

DRAKE

R8 Communications Receiver

Owner's Manual

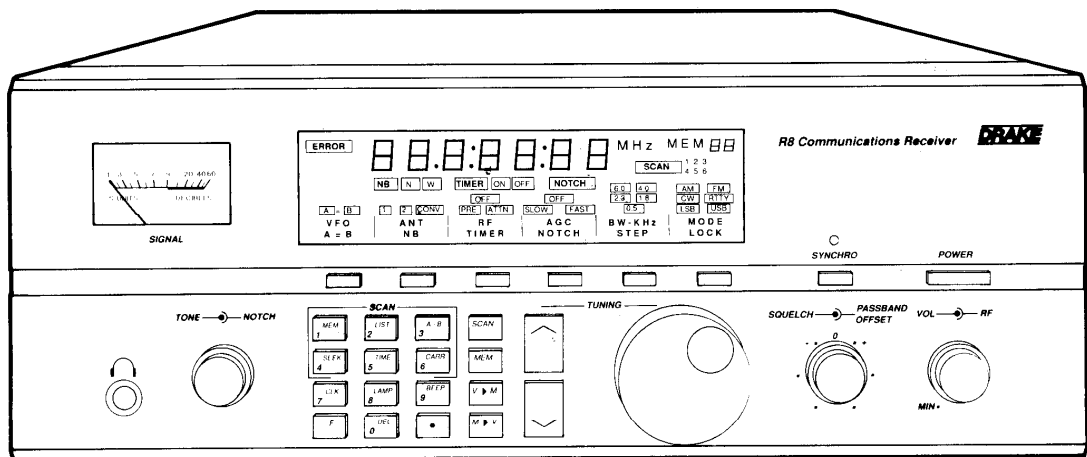

i Important Safeguards

WARNING: TO PREVENT FIRE OR ELECTRICAL SHOCK DO NOT EXPOSE TO RAIN OR MOISTURE.

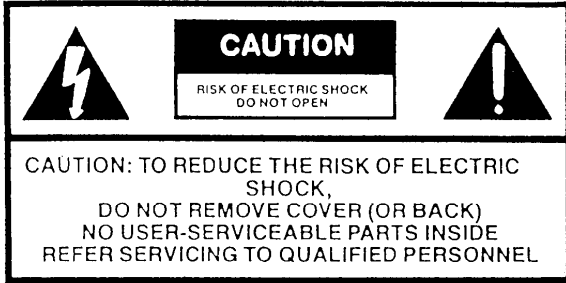

An appliance and cart combination should be moved with care. Quick stops, excessive force and uneven surfaces may cause the appliance and cart combination to overturn.



The lightning flash with arrowhead symbol, within an equilateral triangle, is intended to alert the user to the presence of uninsulated "dangerous voltage" within the product's enclosure that may be of sufficient magnitude to constitute a risk of electric shock to persons.



The exclamation point within an equilateral triangle is intended to alert the user to the presence of important operating and maintenance (servicing) instructions in the literature accompanying the appliance.

WARNING: TO REDUCE THE RISK OF FIRE OR ELECTRIC SHOCK, DO NOT EXPOSE THIS APPLIANCE TO RAIN OR MOISTURE. DO NOT OPEN THE CABINET, REFER SERVICING TO QUALIFIED PERSONNEL ONLY.

CAUTION: TO PREVENT ELECTRIC SHOCK, DO NOT USE THIS (POLARIZED) PLUG WITH AN EXTENSION CORD RECEPTACLE OR OTHER OUTLET UNLESS THE BLADES CAN BE FULLY INSERTED TO PREVENT BLADE EXPOSURE.

ATTENTION: POUR PREVENIR LES CHOCs ELECTRIQUES, NE PAS UTILISER CETTE FICHE POLARISEE AVEC UN PROLONGATEUR, UNE PRISE DE COURANT OU UNE AUTRE SORTIE DE COURANT, SAUF SI LES LAMES PEUVENT ETRE INSEREES A FOND SANS EN LAISSER AUCUNE PARTIE A DECOUVERT.

- 1. Read Instructions**—All the safety and operating instructions should be read before the appliance is operated.
- 2. Retain Instructions**—The safety and operating instructions should be retained for future reference.
- 3. Heed Warnings**—All warnings on the appliance should be adhered to.
- 4. Follow Instructions**—All operating and use instructions should be followed.
- 5. Cleaning**—Unplug this appliance from the wall outlet before cleaning. Do not use liquid cleaners or aerosol cleansers. Use a damp cloth for cleaning.
- 6. Do Not Use Attachments**—not recommended by the manufacturer or they may cause hazards.
- 7. Water and Moisture**—Do not use this product near water—for example, near a bathtub, wash bowl, kitchen sink, laundry tub, in a wet basement, or near a swimming pool—and the like.
- 8. Accessories**—Do not place this product on an unstable cart, stand, tripod, bracket, or table. The product may fall, causing serious injury to a child or adult, and serious damage to the appliance.
- 9. Ventilation**—This product should never be placed near or over a radiator or heat register. This product should not be placed in a built-in installation such as a bookcase or rack unless proper ventilation is provided or the manufacturer's instructions have been adhered to. Any slots or openings in the cabinet are provided for ventilation. To ensure reliable operation of the product and to protect it from overheating, these openings must not be blocked or covered. The openings should never be blocked by placing the product on a bed, sofa, rug, or other similar surface.
- 10. Grounding or Polarization**—This product is equipped with a polarized alternat-

ing-current line plug (a plug having one blade wider than the other). This plug will fit into the power socket only one way. This is a safety feature. If you are unable to insert the plug full into the outlet, try reversing the plug. If the plug should still fail to fit, contact your electrician to replace your obsolete outlet. Do not defeat the safety purpose of the polarized plug.

11. Power Sources—This product should be operated only from the type of power source indicated on the marking label. If you are not sure of the type of power supplied to your home, consult your appliance dealer or local power company.

12. Power-cord Protection—Power-supply cords should be routed so they are not likely to be walked on or pinched by items placed upon or against them. Pay particular attention to cords at plugs, convenience receptacles, and the point where they exit from the appliance.

13. Lightning—For added protection for this product during a lightning storm, or when it is left unattended and unused for long periods of time, unplug it from the wall outlet.

14. Power Lines—An outside antenna system should not be located in the vicinity of overhead power lines, other electric light or power circuits, where it can fall into such power lines or circuits. When installing an outside antenna system, extreme care should be taken to keep from touching such power lines or circuits as contact with them may be fatal.

15. Overloading—Do not overload wall outlets and extension cords as this can result in a risk of fire or electric shock.

16. Object and Liquid Entry—Never push objects of any kind into this product through openings as they may touch dangerous voltage points or short-out parts that could result in a fire or electric shock. Never spill liquid of any kind on the product.

17. Servicing—Do not attempt to service this product yourself as opening or removing covers may expose you to dangerous voltage or other hazards. Refer all servicing to qualified service personnel.

18. Damage Requiring Service—Unplug this product from the wall outlet and refer servicing to qualified service personnel under the following conditions:

- a. When the power-supply cord or plug is damaged.
- b. If liquid has been spilled, or objects have fallen into the product.
- c. If the product has been exposed to rain or water.
- d. If the product does not operate normally by following the operating instructions. Adjust only those controls that are covered by the operating instructions. An improper adjustment may result in damage and will often require extensive work by a qualified technician to restore the product to its normal operation.
- e. If the product has been dropped or the cabinet has been damaged.
- f. When the product exhibits a distinct change in performance—this indicates a need for service.

19. Replacement Parts—When replacement parts are required, be sure the service technician has used replacement parts specified by the manufacturer or have the same characteristics as the original parts. Unauthorized substitutes may result in fire, electric shock or other hazards.

20. Safety Check—Upon completion of any service or repairs to this product, ask the service technician to perform safety checks to determine that the product is in proper operating condition.

21. Outdoor Antenna Grounding—Before attempting to install this product, be sure the antenna or cable system is grounded so as to provide some protection against voltage surges and built-up static charges.

- a. Use No.10 AWG (5.3mm²) copper, No.8 AWG (8.4mm²) aluminum, No.17 AWG (1.0mm²) copper-clad steel or bronze wire or larger, as ground wire.
- b. Secure antenna lead-in and ground wires to house with stand-off insulators spaced from 4 feet (1.22m) to 6 feet (1.83m) apart.
- c. Mount antenna discharge unit as close as possible to where lead-in enters house.
- d. A driven rod may be used as the grounding electrode where other types of electrode systems do not exist. Refer to the National Electrical Code, ANSI/NFPA 70-1990 for information.
- e. Use jumper wire not smaller than No.6 AWG 13.3mm²) copper or equivalent, when a separate antenna grounding electrode is used.

* INSTALL WIRING ACCORDING TO THE CANADIAN ELECTRICAL CODE*
 EFFECTUER LE CABLAGE CONFORMEMENT AU CODE CANADIEN DE L' ELECTRICITE

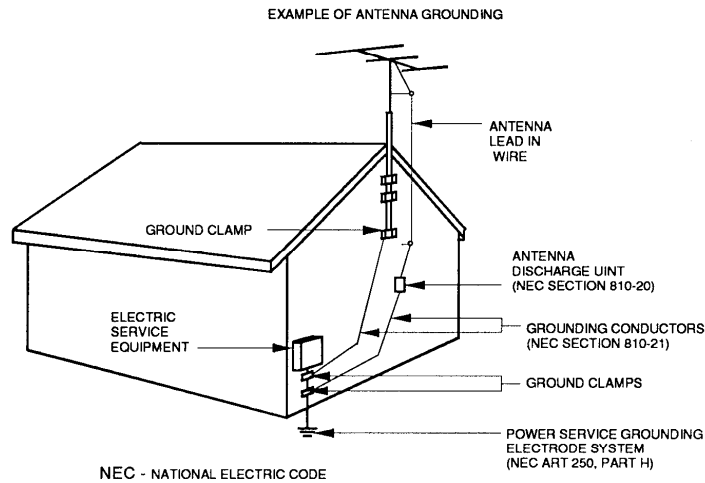

1 Table of Contents

Thank you for purchasing a Drake R8 Communications Receiver. This receiver has been designed and manufactured to high quality standards, and will provide reliable operation for many years.

Please carefully read the Owner's Manual in order to take advantage of the many interesting features that will provide enjoyable listening to radio broadcasts around the world.

Important Safeguards	1	Memory Functions	15
Introduction	2	Scan Functions	17
Safety / Voltage Selection		Clock and Timer Functions	19
General Description	3	Special Use Features and Functions	21
Specifications / Accessories	4	RS232C Interface	22
Installation	5	Suggested References	25
Unpacking		Glossary of Terms	26
Location		Memory Channel Log	27
Fixed Installation		Troubleshooting	29
Mobile Installation		Quick Reference Guide	30
Antenna Requirements		Service and Warranty	32
Installation Diagram	6		
Front Panel Description	7		
Front Panel Display	9		
Rear Panel Description	10		
Getting Started	11		
General Operating Information			
Dual VFO's	12		
Direct Frequency Entry			
Front Panel Lock			
Passband Offset			
AM Synchronous Detector	13		
Attenuator / Preamp			
Noise Blanker			
CW Operation	14		
RTTY Operation	14		
SSB Operation	14		
FM Operation	14		

SAFETY/VOLTAGE SELECTION

WARNING!!!

Please read before applying power

The R8 receiver is normally shipped with the input line voltage selector switch set to 108-132 VAC for operation in the U.S. and Canada. If your operating voltage is different than this, please refer to FIGURE 1 below. The voltage select switch is located on the rear panel and must be set to the proper voltage range for your area. In addition, the proper mains fuse may need to be installed. The unit may be set to operate over the following voltage ranges: 90-110 VAC, 108-132 VAC, 180-220 VAC and 216-264 VAC. Most countries outside the U.S. and Canada use either 220 VAC or 240 VAC line voltage. Please be certain of the operating voltage before connecting to the mains source. The receiver will operate on either 50 Hz or 60 Hz line frequency.

Antenna grounding is necessary if the unit is connected to an outdoor antenna. Grounding of the antenna system is required to protect against static build up and voltage surges. Refer to section 810 of the National Electric Code, ANSI/NFPA No. 70-1984.

The power cord and antenna lead-in should be disconnected if the unit is not to be used for an extended period of time or if threatening weather containing damaging lightning is likely.

Note: The warranty does not cover damage as a result of improper voltage selection, or replacement of fuse with ratings other than those specified.

FIGURE 1 VOLTAGE SELECTOR SWITCH SETTINGS

Setting for 108-132 VAC
Fuse rating 400mA

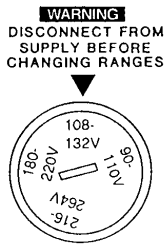

Setting for 90-110 VAC
Fuse rating 400mA

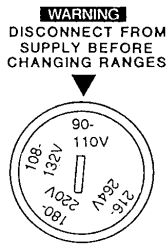

Setting for 180-220 VAC
Fuse rating 200mA

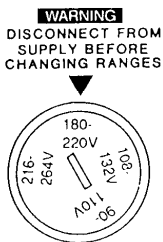

Setting for 216-264 VAC
Fuse rating 200mA

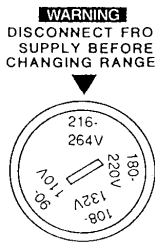

CAUTION

Before using this product outside the U. S. A. or Canada, consult a qualified service technician to perform any necessary modification to the supply cord, supply connector and/or Voltage Selector Switch Settings and fusing of this receiver as supplied.

For use of this product outside the U. S. A. or Canada on supply voltages of 220 VAC or greater, the discharge resistor (4.7 Meg ohm) connected from the ribbed side of the supplied line cord to the receiver chassis must be removed. Refer modification to a qualified service technician.

3 General Description

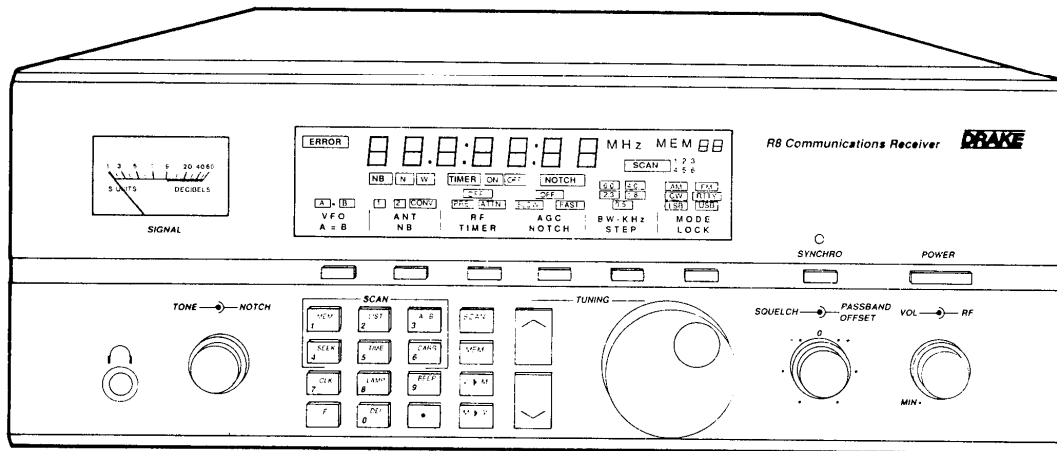

The R8 communications receiver is a microprocessor controlled, synthesized, all mode, world band receiver with continuous coverage capability from 100 kHz through 30 MHz. The R8 offers excellent sensitivity, selectivity, high dynamic range and offers features for the most demanding shortwave reception. Conveniently located front panel controls allow for rapid operator programming and ease of use. The selectable AC input allows for operation around the world. In addition, a DC input is provided for mobile operation.

A High-Q, 8-pole, electronically switched IF filter provides a range of five commonly used bandwidths. These bandwidths are automatically selected by mode, however any bandwidth may be selected at the touch of a button.

The front panel liquid crystal display provides visual feedback to the operator of the current status of the receiver. The seven digit frequency display allows tuning resolution to 10 Hz accuracy.

In the AM mode, a selectable synchronous detector (SYNCHRO) allows for enhanced reception by eliminating or reducing distortion due to fading signals.

A PASSBAND OFFSET control also aids in reducing or eliminating interfering signals by electronically shifting the receiver's IF frequencies without disturbing the operating frequency. This action allows the operator to electronically move interfering signals out of the receiver's passband thus utilizing the high degree of selectivity provided by the High-Q, 8-pole IF filter.

Other built-in reception aids include selectable AGC, noise blanker (NB), RF preamplifier for enhancing weak signals, RF attenuator for further improvement of strong signal handling capabilities, adjustable RF gain, NOTCH, TONE and SQUELCH controls.

A CLOCK (CLK)/TIMER capability allows for unattended recording of a desired program.

A programmable memory area allows for 100 independent receiver set up memories. In addition, these memories are stored in an electronically erasable memory chip which does not require a battery backup and is thus impervious to power line failure. Any of these memories may be altered by the operator and re-stored. These memory channels may be accessed manually or by various scanning methods.

Finally, a built-in RS-232 compatible interface allows complete digital control of the R8 including memory and scanning functions.

Frequency Range	0.1-30 MHz	IP ₃ - Intercept Point	Greater than +5 dBm @ 20 KHz spacing
Modes	AM, LSB, USB, CW, RTTY, FM		Greater than -20 dBm @ 5 KHz spacing
Sensitivity: SSB, CW (10dB S+N/N)	Less than 0.5 μV, 0.1-30 MHz Less than 0.25μV, 1.8-30 MHz (preamp on)	1st IF	45 MHz
		2nd IF	50 KHz
Sensitivity: AM (10dB S+N/N) (1000 Hz, 30% mod)	Less than 1.5 μV, 0.1-30 MHz Less than 0.8 μV, 1.8-30 MHz (preamp on)	AGC	Threshold: 0.8 μV Attack time: 1mS Release time: SLOW: 2 Sec FAST: 300mSec Less than 4 dB change in audio output for 100 dB input change ref. AGC threshold
Sensitivity: FM (12 dB SINAD)	Less than 0.5 μV, 1.8-30 MHz	Ant 1, Converter	50 ohms unbalanced
Frequency Stability	±10ppm, -10° to 50° C	Ant 2	50 or 500 ohms unbalanced
Frequency Accuracy	Better than ±100 Hz, -10° to 50° C	Notch Filter Attenuation	AF type, 40 dB min. Depth (500-5000 Hz)
Selectivity: AM, LSB, USB, RTTY, CW	6 KHz @ -6 dB, less than 12 KHz @ -60 dB 4 KHz @ -6 dB, less than 8 KHz @ -60 dB 2.3 KHz @ -6 dB, less than 4.5 KHz @ -60 dB 1.8 KHz @ -6 dB, less than 3.6 KHz @ -60 dB 500 Hz @ -6 dB, less than 1.5 KHz @ -60 dB	External Speaker Output	2.5 W, 4 ohms @ less than 10% distortion
FM Only	12 KHz @ -6 dB, less than 25 KHz @ -60 dB	Recorder output	300 mV, 4.7K ohms
		Demod output	300 mV, 4.7K ohms
Ultimate Selectivity	Greater than 95 dB	AC Power Requirements	100/120/200/240VAC, ±10% 50 or 60 Hz, 40 Watts nominal
Image Rejection	Greater than 80 dB, 0.1 MHz to 30 MHz	DC Power Requirements	11-16 VDC @ 2 A
IF Rejection	Greater than 80 dB, 45 MHz Greater than 100 dB, 50 KHz	Operating Temperature	-10° to +50° Celsius
Dynamic Range	Greater than 90 dB, 0.1-30 MHz @ 20 KHz spacing	Weight	13 lbs. (5.9 Kg)
		Size	Width 13 1/8" (33.4 cm) Height 5 1/4" (13.4 cm) in- cluding feet Depth 13" (33 cm), includ- ing front knobs and rear connectors

ACCESSORIES

Accessories for the R8 include:

- 1) A VHF converter with frequency coverage of 35-55 MHz and 108-174 MHz.
- 2) A complementary styled MS8 external speaker.

3) A communications software package written for IBM XT/AT and compatibles to allow enhanced operation. (Available soon).

CAUTION: The optional VHF Converter accessory should be installed by a qualified service technician to prevent personal injury or damage to the equipment.

5 Installation

UNPACKING

Carefully remove the R8 from the shipping carton and examine it for evidence of damage. If any damage is noted, immediately contact the transportation company responsible for delivery or return the unit to the dealer from whom it was purchased. Keep the shipping carton and all packing material for the transportation company to inspect. The original carton and packing material should be retained for repackaging should it be necessary to return the unit. Inspect the packing material for any accessories or printed material before storing the box. Locate the registration card, fill out, and immediately return to the R. L. Drake Company to insure registration and validation of warranty.

LOCATION

The location of the R8 is not critical so long as adequate clearance is provided to allow air circulation in and around the unit. Do not cover any ventilation slots in top cover or overheating may result. The ventilation slots also double as a speaker grill and any blockage may result in poor sound quality. For added operating convenience, the front feet may be flipped down to elevate the front of the unit. Refer to Figure 2

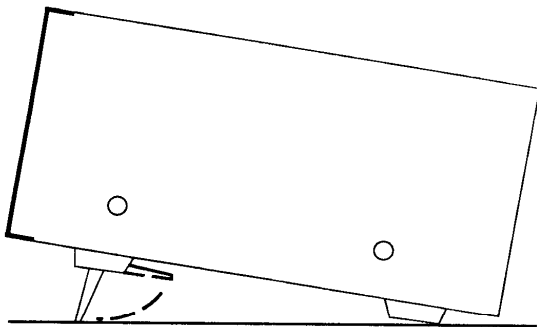

Side View of R8

FIGURE 2 ADJUSTING FRONT FEET

FIXED INSTALLATION

After unpacking unit and checking voltage select switch for proper setting, connect antenna system to appropriate antenna input. Connect AC cord to mains voltage. Connect ground system to ground screw on rear panel of radio. Connect any other external equipment at this time. Refer to Figure 3 for the diagram of a typical fixed installation.

MOBILE INSTALLATION

For use in a mobile environment, the R8 includes a fused external DC input connector. This connector is located on the rear panel. The R8 works well with a DC input voltage of 11-16 VDC. Typical automotive systems supply 13.8 VDC. Due to the relatively low current draw, the R8 may be powered from the vehicle's cigarette lighter socket. Connect DC power cord observing the correct polarity. An internal protection device will protect the R8 from reverse polarity hookup. Connect mobile antenna to appropriate antenna input. This will typically be a whip antenna with a coaxial cable thus permitting the cable to be run under floor mats, etc. Connect a grounding wire from the grounding screw on the rear panel to the vehicle's chassis. To further reduce current draw from the vehicle's battery system, it is recommended the LCD backlighting be turned off for extended listening periods, especially if unit is being operated in squelch mode and scan.

ANTENNA REQUIREMENTS

The R8 incorporates internal switching to allow two separate antenna systems to be connected simultaneously. Refer to Figure 3. Ant 1 is a 50 ohm, SO-239 coaxial input requiring a mating PL-259 connector. This input would typically be used as the primary antenna input. Antennas such as dipoles, trapped dipoles, verticals and beams will provide the best results. Ant 2 is a compression terminal type connection, providing a choice of high impedance (500 ohms typical) or low impedance (50 ohms typical). Antennas such as long wires or end fed Zepps will provide the best results. The best antenna will depend on the frequency range and time of day for the particular signal in question. Refer to publications such as the ARRL Handbook or ARRL Antenna Manual (available in most public libraries) for help on selection and/or construction of the antennas mentioned above.

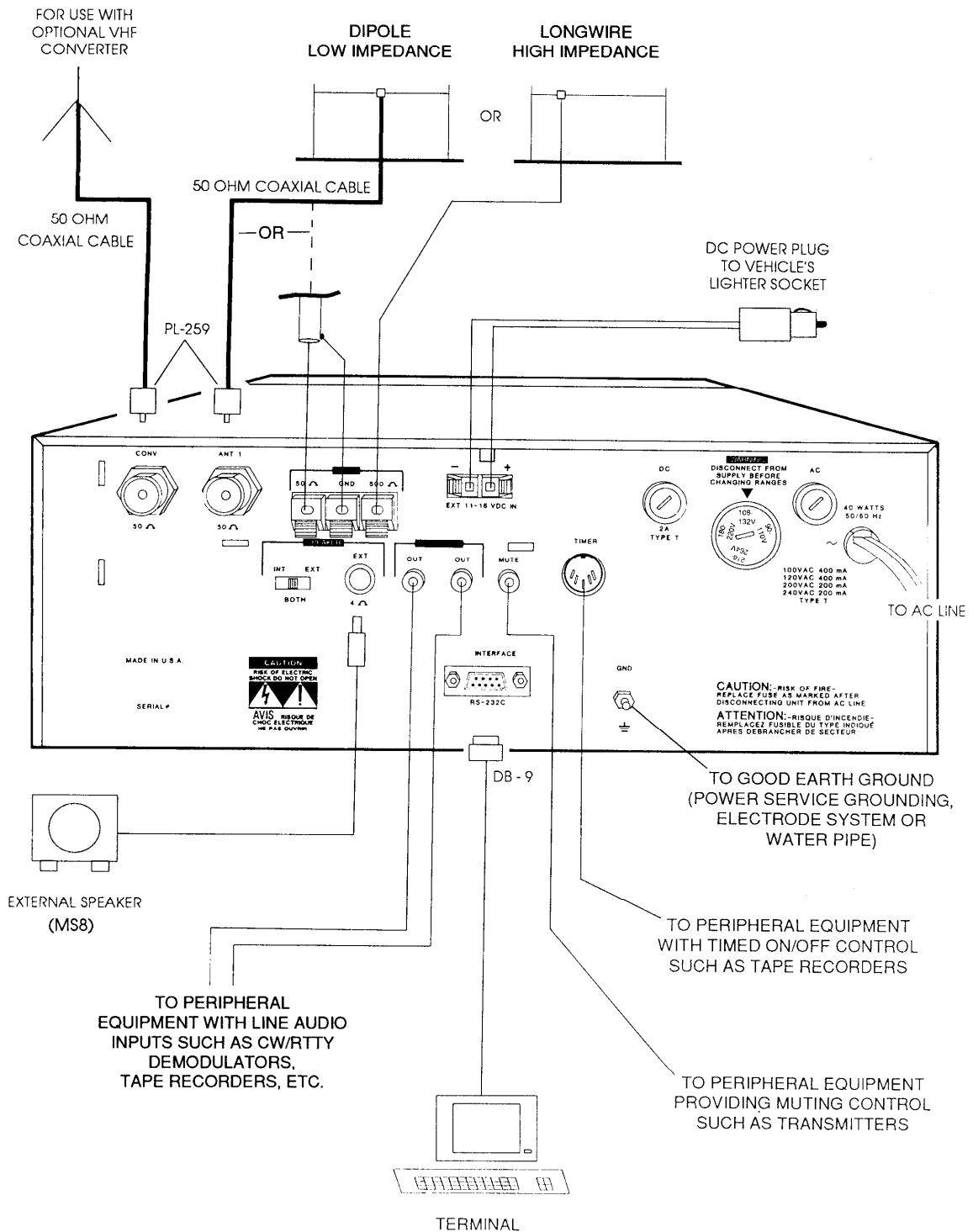

FIGURE 3 INSTALLATION DIAGRAM

7 Front Panel Description

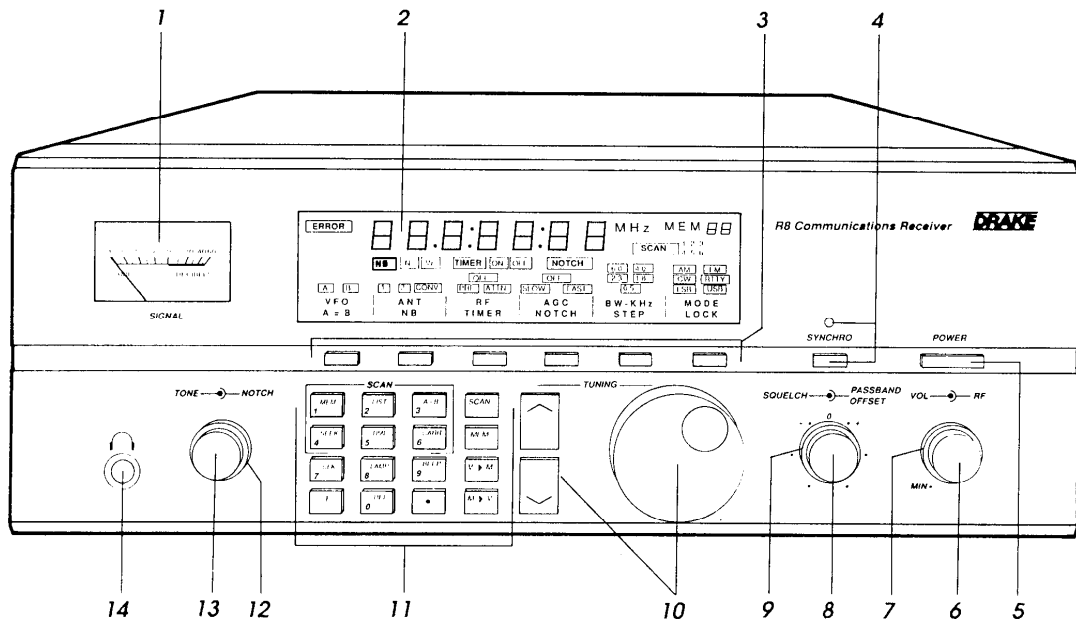

FIGURE 4 FRONT PANEL

1) SIGNAL - This meter indicates the relative signal level in S-units and dB above S9.

2) Display - The backlit, liquid crystal display provides the current status of the R8 such as frequency, mode, bandwidth, etc. Refer to **FRONT PANEL DISPLAY** page 9 for full description.

3) Function Keys - These (6) keys control the various functions of the R8 which are indicated on the display directly above each key.

4) SYNCHRO - This key is used to switch the AM detector from the normal to synchronous mode. The green LED above the key will light when this detector is on.

5) POWER - This key turns the R8 on or off. When unit is off, the clock will be displayed.



6) VOLUME - This control adjusts the R8's audio speaker level. Turn clockwise to increase level or counterclockwise to decrease level.

7) RF - This control adjusts the RF gain of the R8 and is normally left in the clockwise position for maximum gain.

8) SQUELCH - This control sets the signal level at which the audio is muted. For normal operation, this control is set counterclockwise.

9) PASSBAND OFFSET - This control alters the position of the R8's IF passband without disturbing the main tuning. Normally, this control should be set at the "0" or 12 o'clock position. This control is not active in FM mode.

10) TUNING (VFO) - The dial and the up and down keys are the primary tuning controls of the R8. Clockwise rotation of the dial increases frequency and counterclockwise rotation decreases frequency. The dial also incorporates variable speed tuning. The faster the dial is rotated, the faster the tuning speed.

The  key increases and the  key decreases the frequency by fixed steps of 100KHz with each depression. Pressing and holding either key will allow continuous stepping up or down as long as the key is depressed.

11) Program Keys -

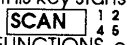



SCAN (Scan) - Pressing this key starts a scan as defined by the scan indicators () on the display. Please refer to SCAN FUNCTIONS on pages 15-16 for details.

MEM (Memory) - Pressing this key in VFO mode switches the R8 to memory mode. Please refer to MEMORY FUNCTIONS on page 14 for details.

V > M (VFO to Memory) - Pressing this key in VFO mode transfers the current status of the R8, i.e., frequency, mode, bandwidth, etc. into memory. Please refer to MEMORY FUNCTIONS on page 14 for details.

 (Memory to VFO) - Pressing this key in memory mode transfers the contents of the current memory location, i.e., frequency, mode, bandwidth, etc. to the selected VFO. Refer to **MEMORY FUNCTIONS** on page 15 for details.

 (Function) - Pressing this key accesses secondary functions, printed in orange, on the numeric keys 0-9 and switches the function line on the display above the 6 function keys.



 to  - These keys are normally used for numeric entries in VFO, memory, clock, and timer modes. Each key also has a secondary function printed in orange. These secondary functions are used as follows: Keys  to  for programming scan methods. Refer to **SCAN FUNCTIONS** page 17.

Key  to access the clock. Refer to **CLOCK & TIMER FUNCTIONS** page 19.

Key  to adjust display and signal meter backlight intensity.

Key  to turn audible beep on or off. Refer to **BEEP TONES** page 11.

Key  to delete a program from a memory location. Refer to **DELETING A MEMORY LOCATION** page 16.

 (Decimal) - This key is used when entering a frequency directly with the numeric keys. Frequency is always entered in megahertz (MHz). Also used in conjunction with  key to provide a Clear entry function. Refer to **DIRECT FREQUENCY ENTRY** page 12.

12) NOTCH - This control is used to "tune" the notch frequency and is active when **NOTCH** is displayed. This control is not active in FM mode.

13) TONE - This control is used to modify the tonal quality of the audio. Counterclockwise rotation increases bass response. Flat response occurs at the 12 o'clock setting. This control is not active in FM mode.

14)  Headphone - This connector accepts a standard 1/4" diameter 2-circuit (monaural) or 3-circuit (stereo) phone plug. Audio is monaural in either case. All speaker outputs are automatically switched off when using headphones.

9 Front Panel Display

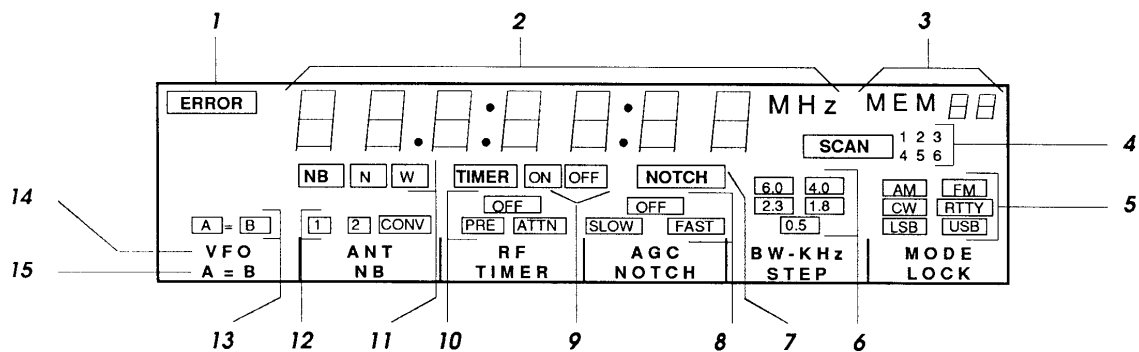

FIGURE 5 FRONT PANEL DISPLAY

1) **ERROR** - This annunciator flashes when an incorrect key sequence is entered.

2) **7-Digit Readout** - This display indicates frequency, in MHz, of current VFO or memory channel. In clock mode, indicates time in 24 hour format i.e., HH:MM:SS. In timer mode, indicates time in 24 hour format i.e., HH:MM. No seconds are used.

3) **MEM 88** - This annunciator indicates current memory location from 00 to 99. MEM will light when R8 enters memory mode. Refer to **MEMORY FUNCTIONS** page 15.

4) **SCAN** $\begin{matrix} 1 & 2 & 3 \\ 4 & 5 & 6 \end{matrix}$ - This annunciator indicates current scan function programming. **SCAN** will light when R8 enters **SCAN** mode. Numbers 1-6 correspond to the scan methods on the numeric keys 1-6. Refer to **SCAN FUNCTIONS** page 17.

5) **MODE** - This annunciator indicates current mode of reception. A box appears around active mode.

Note that the tuning step size, display resolution and bandwidth are user programmable and stored per mode.

The modes are:

- AM - Amplitude modulation
- FM - Frequency modulation
- CW - Continuous wave (Morse code)
- RTTY - Radio teletype
- LSB - Lower sideband
- USB - Upper sideband

6) **BW - KHz** - This annunciator indicates current IF filter bandwidth in kilohertz (KHz). A box appears around active bandwidth.

Note that bandwidth is user programmable per mode.

7) **NOTCH** - This annunciator indicates the notch is on.

8) **AGC** - This annunciator indicates AGC setting. A box appears around active AGC setting.

9) **TIMER** **ON** **OFF** - This annunciator indicates timer on or off. Refer to **SETTING TIMER** page 19.

10) **RF** - This annunciator indicates setting of RF mode. A box appears around active RF mode.

11) **NB** **N** **W** - This annunciator indicates noise blanker (NB) on and narrow (N) or wide (W) selected.

12) **ANT** - This annunciator indicates selected antenna (1, 2 or CONV). A box appears around active antenna setting.

13) **VFO A/B** - This annunciator indicates VFO in use. A box appears around active VFO.

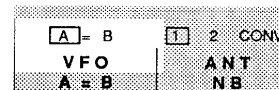

IMPORTANT - PLEASE READ

The function lines of the display, described in callouts 14) and 15) are activated by the unmarked function key located directly below the displayed function. Note that only one of two function lines is displayed at a time. Pressing **F** allows access to the alternate function line. Alternate function availability 'times out' 3 seconds after any front panel activity which alters the display.

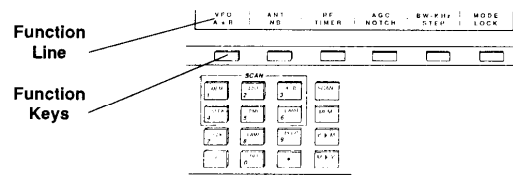

14) Function Line - VFO, ANT, RF, AGC, BW, MODE

When this line is lit, function keys directly below activate displayed function.



15) Function Line - A=B, NB, TIMER, NOTCH, STEP, LOCK

When this line is lit, function keys directly below activates displayed function. Pressing **F** allows access to the alternate function line. Alternate function availability 'times out' 3 seconds after any front panel activity which alters the display.



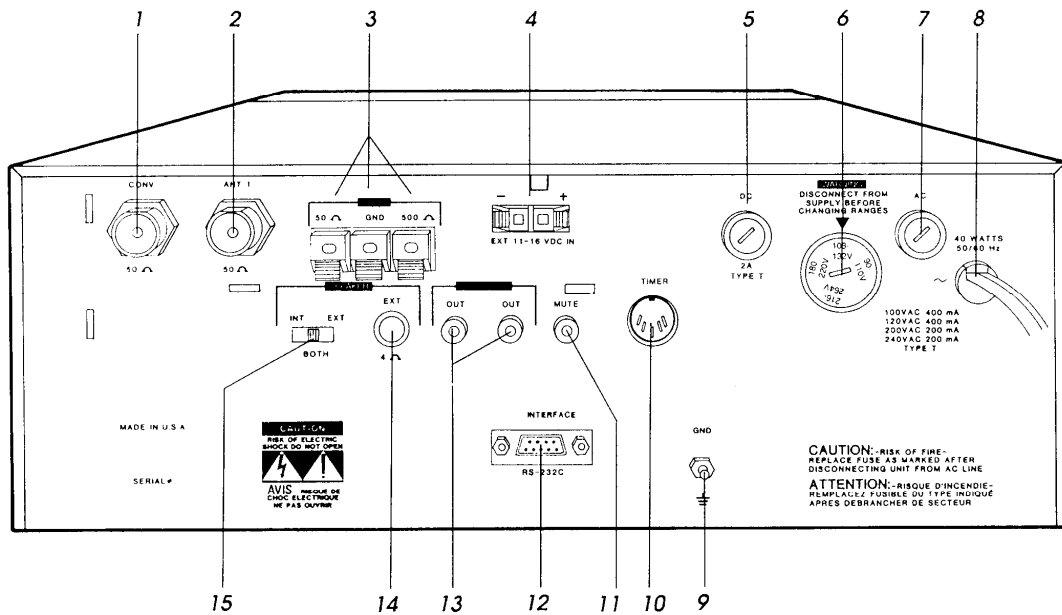

FIGURE 6 REAR PANEL

1) CONV - This connector is used when the optional VHF converter is installed. This connector accepts a standard PL-259 plug.

2) ANT 1 - This connector is used when attaching receiving antennas with coaxial feed lines of 50 ohm nominal impedance. Accepts a standard PL-259 plug.

3) ANT 2 - This connector can be used to attach either a low impedance (50 ohm nominal) or high impedance (500 ohm nominal) antenna. The center clip is ground and its connection should be as short as possible.

4) EXT 11-16 VDC IN - This connector is used for powering the R8 from an external DC source such as a car battery. Observe proper polarity when attaching wires. This connector is internally protected from reverse polarity.

5) DC Fuse - This is a 2 ampere type T fuse. Replace with same type and rating.

6) Voltage Select Switch - Set this switch to the range which matches your mains voltage before applying power. Exchange AC fuse if necessary.

USA/Canada 108-132 VAC
 United Kingdom 216-264 VAC
 Germany 180-220 VAC
 France 180-220 VAC

7) AC Fuse - This is either a 400mA type T fuse for 90-132 VAC or a 200mA type T fuse for 180-264 VAC operation. Replace with same type and rating.

8) Line Cord - Plug this polarized cord into the AC mains.

9) GND (Ground) - The earth ground wire connected here should be as short as possible.

10) TIMER - This 5 pin din connector provides switching contacts for on/off control of an external device such as a cassette tape recorder. Refer to **CLOCK & TIMER FUNCTIONS** page 19.

11) MUTE - The RCA connector provides a method of muting the R8 for use with a transmitter. Ground center pin to mute.

12) Interface RS-232C - This 9 pin DB-9 connector provides a standard RS-232C interface to a keyboard terminal. Refer to **RS-232C INTERFACE** page 22.

13) LINE AUDIO OUT - Both RCA connectors provide a constant low level audio source independent of the setting of the volume control. They are designed to interface to tape recorders, CW/RTTY demodulators, amplifiers, etc.

14) EXT (External Speaker) - This connector accepts a standard 1/4" diameter, 2-circuit, (monaural) phone plug for connection of a 4 ohm external speaker.

15) Speaker Switch (INT/EXT/BOTH) - This 3 position switch allows selection of internal only, both internal and external, or external only speaker outputs.

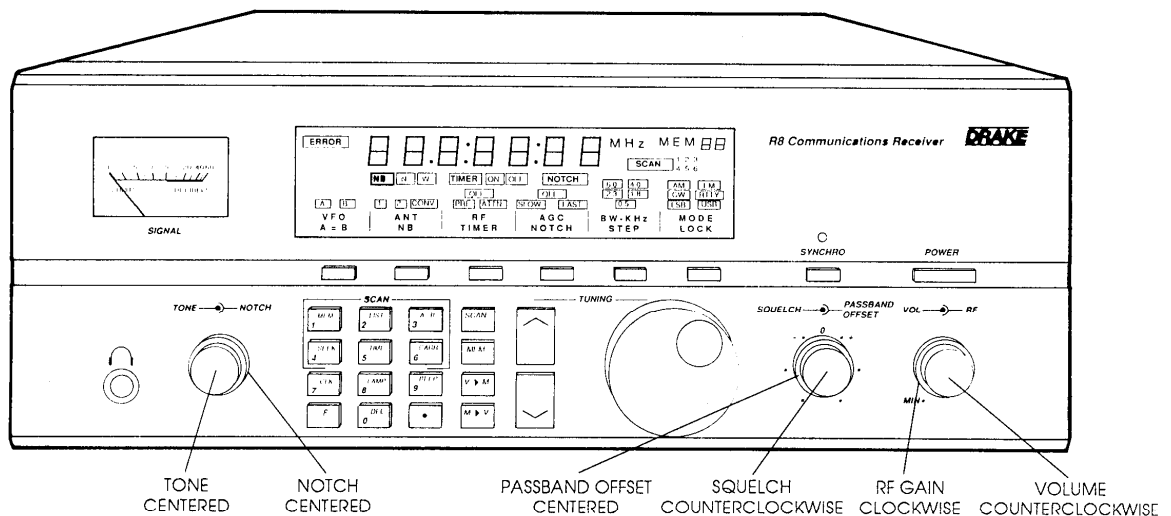

FIGURE 7

GENERAL OPERATING INFORMATION

The R8 is easy to use. Please take a few moments to read through this section and familiarize yourself with general operating information.

MICROPROCESSOR RESET

A power-up reset routine is activated each time the unit is connected to an AC or DC power source. This may be confirmed by the front panel display illuminating all annunciators for 3 seconds, followed by the clock display. If for any reason the R8 display or operation becomes "confused", unplug from power source and reconnect. Note: Any programmed memory locations will not be lost under a power-up reset due to the memory design of the R8.



BEEP TONES

The R8 responds to all key depressions with an audible beep. They are as follows:

- 1 short tone for any key depression.
- 1 long, high tone when programming in memory mode.
- 1 long, low tone for any illegal key depression.

GETTING STARTED

1. Please refer to FIGURE 7 and adjust controls as shown.
2. Press **POWER** key.
3. Set **SQUELCH** control fully counterclockwise
4. Press **VFO** key to select **VFO A**.
5. Press **ANT** key to select desired antenna input.
6. Press **MODE** key to select desired mode of reception. The bandwidth will automatically change with mode selection.
7. Check that 'SPEAKER' switch on rear panel is on desired setting.
8. Adjust **VOLUME (VOL)** control for desired level.

9. Use the numeric keypad to enter frequency, in MHz, directly or use the  or  tuning keys to rapidly tune to the nearest 100 KHz frequency, then fine tune with the tuning knob.

FREQUENCY STEP SELECTION

The R8 can be programmed to tune in three different step sizes and display three different resolutions based upon step size. The three choices are as follows:

- A) 1 KHz display resolution (tunes in 100 Hz steps)
- B) 100 Hz display resolution (tunes in 10 Hz steps)
- C) 10 Hz display resolution (tunes in 10 Hz steps)

Once programmed by the user, the step size is stored per mode. The R8, as shipped from the factory, has step sizes programmed per mode as shown in **Table 1** below:

Mode	Display Resolution (Hz)	Tuning Resolution (Hz)
LSB, USB, RTTY, CW	10	10
AM, FM	1K	100

Table 1

If desired, the factory settings for STEP size, AGC setting and bandwidth can be recalled by holding the **MODE** key while turning **POWER** on.

Pressing the **STEP** key alternates the step.

Press:  **STEP**

The tuning dial incorporates variable rate tuning. The faster the dial is rotated, the greater the frequency change per dial revolution.

DUAL VFO's**A) VFO A/VFO B**

Two VFOs (A and B) are provided on the R8. Selection is made with the VFO function key. Each VFO can be set to any frequency and act as a temporary memory location. For example, suppose you want WWV at 10 MHz in VFO B while using VFO A to tune other frequencies.

Press: **VFO** to select **B**

Press: **MODE** to select **AM**

Press: **MEM** **DEL** **•** **•**
 WWV is now stored in **VFO B**.

Press: **VFO** to select **A**

Tune other frequencies with **VFO A**. To recall WWV, press **VFO** function key. **NOTE:** See 'DIRECT FREQUENCY ENTRY' section below for explanation of second **•** entry.

B) A=B

This function is used to transfer the frequency of the active VFO into the inactive VFO. This is handy if you are tuning and would like to temporarily hold a certain frequency as you continue tuning. For example, suppose you are tuning in VFO B and come across a station at 4.5 MHz you would like to occasionally check.

Press: **F**, then **A=B**

Equal (=) symbol now appears between **A** and **B**

Continue tuning and recall station at 4.5 MHz anytime by pressing the **VFO** key.

DIRECT FREQUENCY ENTRY

Direct keyboard entry of a frequency is possible using numeric keys 0-9 and decimal **•** allowing for rapid frequency change. Pressing the key sequence **F**, **•** will cancel any frequency or memory channel number entry in progress and return the setting to its previous state.

Press: **VFO** to select **VFO A** or **VFO B**

Enter frequency in MHz beginning with the most significant digit. You do not need to enter leading or trailing zeros.

Examples:

1) 1.410 MHz

Press: **MEM** **•** **SEEK** **MEM** **•**

2) 29.660 MHz

Press: **LIST** **BEEP** **•** **CARR** **CARR** **•**

The second depression of the decimal **•** key acts as an 'Enter' and causes immediate response to the entered digits. If you forget to press the decimal **•** key a second time, the R8 will automatically do so for you, but with a slight delay.

EXAMPLE:

1) 700 KHz (= .70 MHz)

Press: **•** **CLK**

After 3 second pause, frequency will be entered.

Attempting to enter a frequency outside of the tuning range of the R8 will cause the **ERROR** annunciator to flash along with the error beep to be heard. The R8 will then return to the last displayed frequency.

FRONT PANEL LOCK (UNLOCK)

First be sure the R8 is in the **VFO** mode, (**MEM** or **SCAN** not displayed). All key entries, display settings and the large tuning knob can be locked if desired.

Press **F** **LOCK** to lock front panel. All control knob functions will still remain operable. Press **F** **LOCK** to unlock front panel if previously locked.

PASSBAND OFFSET OPERATION

When the **PASSBAND OFFSET** control is centered, the R8 will properly position its IF passband with mode change. Occasionally, an interfering signal will appear above or below the desired signal. Rotating the **PASSBAND OFFSET** "+" or "-" will reduce or eliminate this interfering signal by electronically shifting the R8's IF passband. Refer to FIGURE 8. This shifting of the IF passband also alters the audio quality. For example, if you are receiving a signal in USB and rotate the **PASSBAND OFFSET** control "+", the audio will become high pitched. Conversely if the control is rotated to the "-" position, the audio will become low pitched. The results are reversed in LSB; rotated "-" the audio becomes high pitched, rotated "+" the audio becomes low pitched.

In AM, the **PASSBAND OFFSET** can enhance audio quality. For example, with the **PASSBAND OFFSET** control at the normal 12 o'clock position and the 6 KHz IF filter selected, the maximum audio response will begin to roll off above 3 KHz. If the **PASSBAND OFFSET** control is moved to one side or the other, audio response exceeding 5 KHz is obtainable thus enhancing fidelity. Try both offset directions to determine which side of the signal is least subject to any possible adjacent signal interference.

The **PASSBAND OFFSET** control is also coupled to the synchronous detector (SYNCHRO) allowing the passband to be altered while the detector is in use.

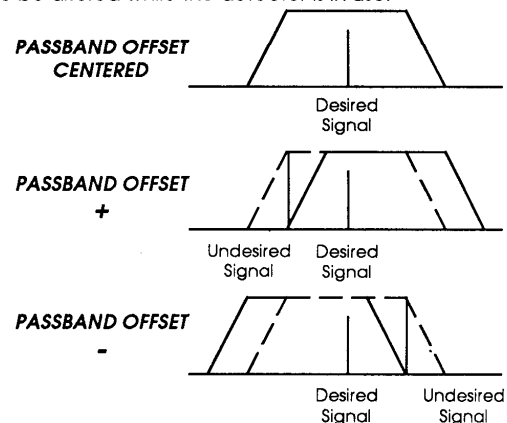

FIGURE 8 PASSBAND OFFSET Operation

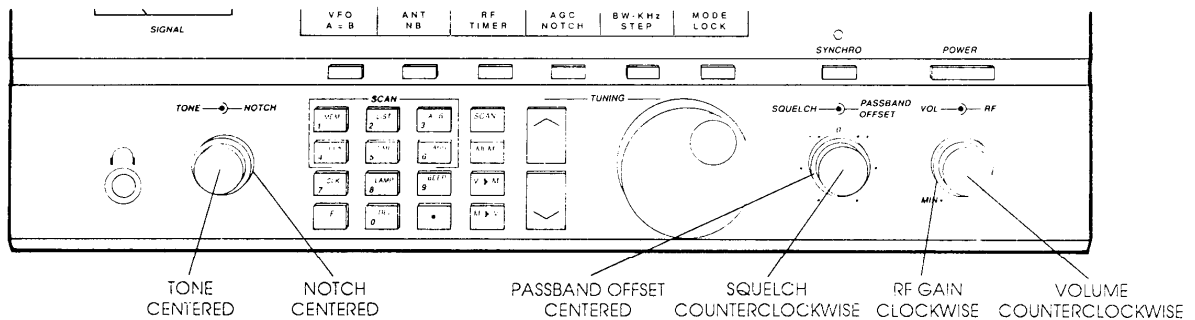

FIGURE 9

AM SYNCHRONOUS DETECTOR OPERATION

For general tuning and listening, the normal AM detector is best. It allows normal AM reception while providing the capability to offset the IF passband without causing distortion. If the received signal is experiencing severe fading as is common on many SW and BC bands, the synchronous detector should be engaged. Make sure the main tuning is set to within 1 KHz of the station's transmitting frequency. Adjust the **PASSBAND OFFSET** control and change bandwidth as required to minimize any interference. Press **SYNCHRO** to activate the synchronous detector. This detector provides a very powerful aid in reducing the severe audio distortion that can occur during the time period when the carrier of the received AM signal is cancelled or reduced by propagation effects.

When the synchronous detector has been activated, moving the main tuning over 200 Hz will automatically turn off the detector.

RF FUNCTION (ATTENUATOR/PREAMP)

Occasionally, a received signal may be very strong such as from a local broadcast station. When this happens, distortion could **degrade** the signal's quality. To help combat this, the **ATTN** should be selected. It provides 10 db of attenuation to the incoming signal allowing the receiver to function normally. Also, when trying to listen to a weak station in the presence of an undesired stronger station, selecting the attenuator will lower the received level of both. This action could make it possible, however, to receive the desired station. The attenuator is available for use across the entire tuning range of the R8.

Another RF function available is the preamp **PRE** which provides an additional 10 dB of gain to the received signal. This can be useful on the higher short-wave frequencies when trying to receive a weak signal perhaps at the noise level. The preamp is only available for use above **1.8 MHz** and, if selected while tuning below **1.8 MHz**, will automatically switch off. Use caution when using the preamp as it could amplify an adjacent signal causing distortion on the desired signal.

For general tuning select **OFF** for the RF function.

To select the RF function:

Repeated depressions of RF will sequence from **OFF** to **PRE** to **ATTN** then, repeat.

NOISE BLANKER

The NOISE BLANKER **NB** provides two settings which should reduce or eliminate most noise interference encountered. The **N** (or narrow) setting is for short duration, high impulse noise such as automotive ignition noise. The **W** (or wide) setting is to reduce longer duration impulses such as over the horizon radar (OTHR) commonly referred to as "The Woodpecker" due to its sound.

Unfortunately, there exists no blanker capable of eliminating all possible noise either atmospheric or man-made. Another side effect of the NOISE BLANKER use is on AM signals. Occasionally, if a strong AM signal is tuned in and the NOISE BLANKER is engaged, blanking can occur on modulation peaks causing a popping or breaking up of the audio. If this is noticed, be sure the NOISE BLANKER is off.

CW OPERATION

For general tuning in **[CW]** mode, the 1.8 kHz bandwidth is recommended since the 0.5 kHz bandwidth is very narrow. When the desired signal is found, tune the R8 until an approximately 800 Hz audio note is heard, then select the 0.5 kHz filter. If interference is present, the passband offset can be employed to reduce or eliminate the interfering signal.

RTTY OPERATION

In **[RTTY]** mode, the R8 selects the user programmed bandwidth (1.8 kHz recommended) filter and positions it for the 2125 Hz mark and 2975 Hz space high tone group.

When receiving other shifts such as 425 Hz or 170 Hz, the **PASSBAND OFFSET** may need to be adjusted to pass both tones equally. Additionally, the selected IF bandwidth can not be smaller than the shift of the received signal. Therefore, the 0.5 kHz bandwidth filter can not be used when receiving a 850 Hz shift **RTTY** signal but could be selected for a 425 Hz or 170 Hz shift **RTTY** signal.

SSB OPERATION

Tuning in a single sideband (SSB) signal can be somewhat frustrating for the first time listener. In either of the R8's SSB modes, LSB (lower sideband) or USB (upper sideband), the receiver will select the 2.3 kHz bandwidth and 10 Hz tuning steps. These initial settings may be altered if desired. Generally, LSB is used below 10 MHz and USB is used above 10 MHz.

First, be sure the **PASSBAND OFFSET** control is centered. When initially tuning in the desired station, tune slowly. If the station is unintelligible, try the other sideband again tuning slowly. A station tuned in on the wrong sideband is totally unreadable but a station mistuned on the right sideband may sound like "Donald Duck". Further tuning will result in a more normal voice sound. Once the station is tuned in, the **PASSBAND OFFSET** can be used to alter the audio response of the received SSB signal. Refer to **PASSBAND OFFSET OPERATION** for details. Additionally, if adjacent stations are causing interference, the 1.8 kHz bandwidth filter may be selected in conjunction with the **PASSBAND OFFSET** to further reduce or eliminate interfering signals.

FM OPERATION

Frequency modulation (FM) is perhaps the easiest mode to use on the R8. When the FM mode is selected the R8 defaults to **PRE** only. No **AGC** or **BANDWIDTH** settings are used in FM mode. In fact, attempting to activate these buttons will result in an error beep. Additionally, **NB**, **NOTCH**, **TONE**, **PASSBAND OFFSET**, and **RF GAIN** controls are not used.

Most FM transmissions are above 29 MHz and are generally amateur radio in nature. A very active frequency, when conditions permit, is 29.660 MHz.

Peculiar to FM transmissions is the fact that a stronger signal on the same frequency or close to the same frequency will completely cover up a weaker signal. Also, there are no controls to help reduce or eliminate an interfering signal. This is not a fault of the receiver but of the FM mode of transmission. However, to help in eliminating the background hiss, the **SQUELCH** control may be used to quiet the receiver during periods of no signal.

15 Memory Functions

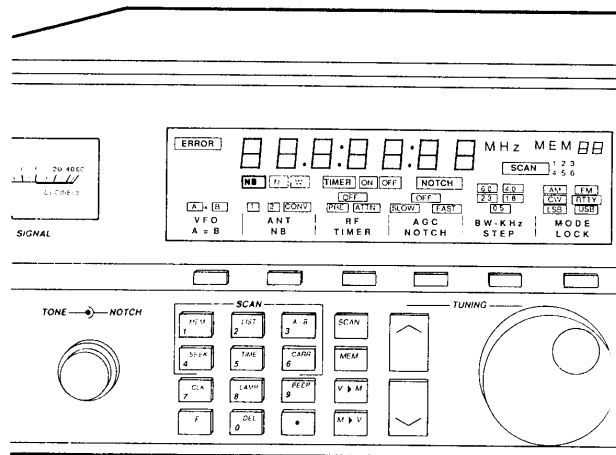

FIGURE 10

MEMORY FUNCTIONS

The R8 contains 100 programmable memory locations that can be used to store and recall commonly monitored frequencies. These 100 locations are divided into blocks of 10, ie, 00-09, 10-19, 20-29, etc. This allows convenient grouping of frequencies. As an example, 00-09 could be broadcast stations, 10-19 could be time stations such as CHU and WWV, 20-29 could be various Voice of America (VOA) frequencies for listening at different times of day, etc. **The R8 is preprogrammed (at the factory) with (20) useful frequencies and corresponding mode in memory channels 80-99.** With memory locations programmed, you can use the various scan functions to automatically monitor desired memory frequencies. The following may be stored in any memory location:

- | | | |
|----------------|--------------------------|-------------------------|
| 1) Frequency | 5) RF setting | 9) Synchronous detector |
| 2) Mode | 6) Antenna ON/OFF | |
| 3) Bandwidth | 7) Notch ON/OFF | |
| 4) AGC setting | 8) Noise blanker setting | |

PREPROGRAMMED MEMORY CHANNELS LIST

MEMORY CHANNEL	FREQUENCY	MODE
80	1.800	LSB
81	3.500	LSB
82	7.000	LSB
83	10.100	CW
84	14.000	USB
85	18.068	USB
86	21.000	USB
87	24.890	USB
88	28.000	USB
89	29.660	FM
90	5.000	AM
91	7.335	AM
92	10.000	AM
93	14.670	AM
94	15.000	AM
95	20.000	AM
96	11.580	AM
97	11.775	AM
98	15.475	AM
99	21.545	AM

All above are in VFOA, ANT 1, RF OFF, AGC and BW as selected by mode.

MEMORY LOCATION PROGRAMMING

First be sure the R8 is in the **VFO** mode (**MEM** or  not displayed).

- A) Select the desired frequency, mode, bandwidth, etc.
 B) Press:  and within 3 seconds, enter a 2 digit number from 00-99. Confirmation beep is heard.
 C) R8 will return to **VFO** mode and last used memory location is displayed in upper right corner of display.



RECALLING A MEMORY LOCATION

First be sure the R8 is in the **VFO** mode (**MEM** or  not displayed).

- A) Press  and select desired memory location with

- 1) **TUNING** dial, 2)   keys, or 3) direct entry of

a two digit memory location. If recalling an unprogrammed location with direct entry, an error beep is heard and  flashes on display.

- B) R8 will be automatically loaded with contents of selected memory location. At this point, any setting other than frequency may be altered. If it is desired to recall original memory settings, press . If it is desired to save altered settings, press .

- C) To transfer memory to **VFO**:

Press  to load selected memory location into a **VFO** for tuning. R8 will return to **VFO** mode. Contents of memory location are not lost.

To return to **VFO** without transfer: Press **VFO** and R8E returns to **VFO** mode and restores last used frequency before  was pressed.

DELETING A MEMORY LOCATION

- A) Press  and select desired memory location with

- 1) **TUNING** dial, 2)   keys, or 3) direct entry of

a two digit memory location. If recalling an unprogrammed location with direct entry, an error beep is heard and  flashes on display.

- B) Press   and hold till short, high pitched beep. Display will show **MEM--**.

- C) Press  or **VFO** to return to **VFO** mode.

ERASE ALL MEMORY CHANNELS

With power off, Press  and hold while turning power on. Hold  for 3 seconds.

LOCKING A MEMORY LOCATION

First be sure the R8 is in the **VFO** mode (**MEM** or  not displayed).

- A) Press  and select desired memory location with

- 1) **TUNING** dial, 2)   keys, or 3) direct entry of

a two digit memory location. If recalling an unprogrammed location with direct entry, an error beep is heard and  flashes on display.

- B) To lock memory location: Press  **LOCK**. **MEM** will now flash.

To unlock a locked memory location: Press  **LOCK**. **MEM** will stop flashing.

- C) Press  or **VFO** to return to **VFO** mode.

17 Scan Functions

SCAN FUNCTIONS

The R8 provides nine distinct scan functions which are programmed with keys 1-6 on the numeric keypad and indicated in the scan status area of the display.

Keys 1-3 are considered 'modes'.

- 1 - Scans all memory locations.
- 2 - Scans all unlocked memory locations within a user selected list of blocks.
- 3 - Scans from frequency in VFO A to frequency in VFO B.

Keys 4-6 are considered 'methods'.

- 4 - Stops scan at first carrier detected.
- 5 - Stops at detected carrier for five seconds, then resumes scan.
- 6 - Stops at detected carrier until carrier drops for five seconds, then resumes scan.

Important Notes About Scanning

In all scanning modes the setting of the SQUELCH control is important for proper scanning action. Due to atmospheric noises alone, using a squelch control in the HF spectrum is, at best, a compromise. A more exact method of SQUELCH setting is provided here.

First, be sure the SQUELCH control is counterclockwise. Next, adjust the RF gain control slowly counterclockwise until the S METER reads the signal level desired to trip the squelch circuit. For example, if you want only signals S-7 or stronger to break the SQUELCH, rotate the RF GAIN control until the S-METER is reading S-7. Next, leaving the RF GAIN control alone, advance the SQUELCH control clockwise until the receiver audio just quiets. Finally, advance the RF GAIN clockwise. The receiver is now ready for accurate scanning.

A scan program therefore consists of any combination of a mode and method. For example, scanning VFO A to VFO B and stopping at a detected carrier five seconds then resuming would be programmed with:

and display would indicate , '5' and '3'.

Table 2 charts the nine (9) scan functions.

Scan methods can be changed while the R8 is scanning. The clock display and back lighting can be accessed while the R8 is scanning. All other functions are locked out until scan functions are terminated.

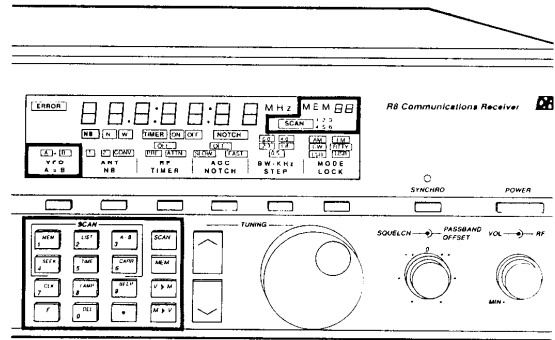

FIGURE 11

SCAN MEMORY

To scan all memory locations from 00 to 99:

Press: ; selects memory scan;
Result: 1 lights in status area.

Select method: **SEEK** or **TIME**
or **CARRIER**
Result: 4, 5, or 6 lights in status area.

Adjust squelch to quiet receiver audio.

Press: ; lights in status area when the scan is activated.

Display will indicate contents of each memory location as scanned. Scanning can be stopped or restarted with repeated depressions of the key. When scan action is stopped, the R8 remains in MEMORY mode. Press VFO to return to last VFO frequency before entering the SCAN mode or to load contents of indicated memory location into indicated VFO.

MODE \ METHOD		MODE		
		Scan All Memory Locations	Scan All Unlocked Memory Locations of User-Selected Lists	Scan From VFO A to VFO B
		<input type="button" value="MEM"/> 1	<input type="button" value="LIST"/> 2	<input type="button" value="A B"/> 3
SEEK '4'	Stop at First Carrier detected	(F) (1) (F) (4)	(F) (2) (F) (4)	(F) (3) (F) (4)
TIME '5'	Pause at Detected Carrier 5 Seconds Then Resumes SCAN.	(F) (1) (F) (5)	(F) (2) (F) (5)	(F) (3) (F) (5)
CARRIER '6'	Pause at Detected Carrier until Carrier Drops for 5 Seconds, Then Resumes SCAN.	(F) (1) (F) (6)	(F) (2) (F) (6)	(F) (3) (F) (6)

Table 2 Scan Functions

SCAN MEMORY LIST BLOCK

The memory locations 00 to 99 are partitioned into ten LISTS (blocks), each block having ten memory locations (total of 100 locations). See Table 3.

A) Single list scan

Press: selects list scan;
Result: 2 flashes in status area prompting list entry.

Enter desired list: Press or or etc.

List Number	Memory Location	List Number	Memory Location
0	00-09	5	50-59
1	10-19	6	60-69
2	20-29	7	70-79
3	30-39	8	80-89
4	40-49	9	90-99

Table 3 Memory Location Blocks

Select method: **SEEK** or **TIME** or **CARRIER**

Result: 4, 5, or 6 lights in status area.

Adjust squelch to quiet receiver audio.

Press: ; lights in status area when scan is activated.

Display will indicate contents of selected memory locations in LIST as scanned. Scanning can be stopped or re-started with repeated depressions of the key. When scan action is stopped, the R8 will be in MEMORY mode. Press **VFO** to return to last VFO frequency before entering scan or to load contents of indicated memory location into indicated VFO.

B) Multiple LIST scan

Press: selects list scan; 2 flashes in status area prompting list entry.

Enter lists desired: Press (0) through (9) in any order.
EXAMPLE: Press , , - will scan LISTS (blocks) 2, 4 and 7.

Select method: **SEEK** or **TIME** or **CARRIER**

Result: 4, 5, or 6 lights in status area.

Adjust squelch to quiet receiver audio.

Press: ; lights in status area when scan is activated.

Display will indicate contents of selected memory locations in LISTS as scanned. Scanning can be stopped or re-started with repeated depressions of the key. When scan action is stopped, the R8 remains in MEMORY mode. Press **VFO** to return to the last VFO frequency before entering scan or to load contents of indicated memory location into indicated VFO.

SCAN VFO A TO VFO B

VFO scan allows continuous tuning of frequencies between the limits programmed into **VFO A** and **VFO B**. Table 4 charts the tuning rate and display resolution based on MODE/STEP for FM and AM modes. Step sizes for other modes remain the same, see Table 1, page 11. If the selected scan range includes the broadcast band, the R8 automatically switches to a 10 KHz step size (9 KHz selectable) while in the broadcast band range.

To program a **VFO** scan-

Press selects A-B scan

Press **VFO** to select **VFO A**. A box appears around A

Enter start frequency

Press **VFO** to select **VFO B**. A box appears around B

Enter **STOP** frequency

Select method: **SEEK** or **TIME** or **CARRIER**

Result: 4, 5, or 6 lights in status area.

Select desired mode, bandwidth (BW), antenna, etc.

Adjust squelch to quiet receiver audio.

Press ; lights in status area when scan is activated.

To adjust step rate: Press **STEP** step size will change as per table 4.

Display will indicate scanned frequency. Scanning can be stopped or restarted with repeated depressions of the key. When scan action is stopped, the R8 will be in the **VFO** mode.

To program a 9 KHz step rate for overseas broadcast band reception-

Press **POWER** to turn R8 off
Hold **BW/STEP** function key
Press **POWER** to turn R8 on

9 KHz step in broadcast band is now programmed. This setting is saved even if power is removed from the receiver. To change back to 10 KHz, repeat above steps.

Mode	Tuning Resolution (Hz)			Display Resolution Default/Steps 1, 2
	Default	Step 1	Step 2	
FM	1K	5K	100	1K
AM	1K	5K*	100	1K
*10 KHz (or 9KHz if programmed) 540-1600 KHz				

Table 4 Scan Tuning Rates

19 Clock & Timer Functions

The R8 incorporates a dual time clock allowing two 24 hour clocks to be set and maintained. The clocks are not backed up by battery if power is lost. However, for momentary power losses up to 20 minutes in length, the local clock will recover (alternate clock will require re-setting). It is normal to incur a 5 to 10 second delay before the 'seconds' digits of the clock update after power is restored or any time power is first applied to the unit. The TIMER functions are also derived from the clock, therefore, the clocks must be set first for proper TIMER operation. TIMER settings are not held through a power loss.

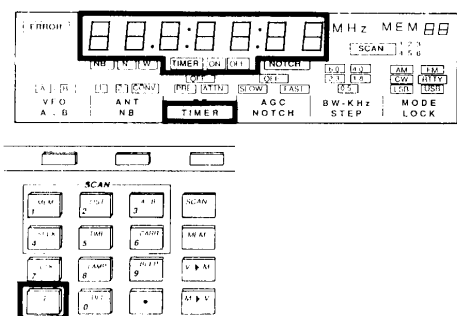

SETTING 24 HOUR CLOCK

Press **F**, then press **CLK** and hold until second beep is heard. Note that any previous clock settings are erased.

Display shifts from frequency to clock display of local time denoted as 'L--:--:--'; colons flash.

Enter time: 'HH:MM:SS:HH' where **H=Hours**, **M=Minutes**, **S=Seconds** and **H=Hours** for alternate clock. Clock is in hold mode. Alternate hours are not displayed.

Press **F** to start clock: clock starts, is displayed for 3 seconds, then switches back to frequency.

To display clock at any time-

Press **F CLK**; time displays for 3 seconds.

To switch clocks at any time-

Press **F CLK**, and time is displayed.

Press **CLK** while time is still being displayed (approximately 3 seconds) to switch to other clock.

Example: 9AM Local = 14 H GMT

Press **F**, then **CLK** and hold until second beep is heard. 9AM Local time is displayed as 'L09:00:00'.

Enter 09:00:00:14.

DEL **BEEP** **DEL** **DEL** **DEL** **DEL** **DEL** **MEM** **SEEK**

Press **F**

To display time:

Press **F CLK** Display: 'L09:00:00'

Press **CLK** Display: '14:00:00'

Press **CLK** Display: 'L09:00:00'

Last selected clock is continuously displayed when the **POWER** key is pressed and R8 is **OFF**.

Last displayed clock is used for EVENT TIMER. For example, if the keys **F CLK CLK** are pressed in sequence to switch to alternate time, the EVENT TIMER will use this clock to trigger the EVENT TIMER.

SETTING TIMER

The **TIMER** allows the R8 to turn on and off at preset times. In addition, the rear panel **TIMER** connector allows control of small cassette tape recorders, etc. to record a favorite program.

To set **TIMER**-

Press **F TIMER** and hold until beep is heard.

Display shifts from frequency to timer display of **HH:MM**; **TIMER** is displayed, **ON** flashes; colon flashes.

Enter **ON** time: **HH:MM**; if **incorrect** time is entered error beep is heard, **ERROR** flashes and display changes to **--:--**.

If you enter a time, then change your mind, press **•** to clear time. Also, press **•** to set no **ON** time.

Note: The programmed **TIMER** settings are overridden (but not erased) whenever the R8E is being controlled by the RS232C Serial Interface ('DTE Ready' line active).

Press **TIMER**. Display shifts to **OFF** time. **TIMER** is displayed and **OFF** is flashing; colon flashes.

Enter **OFF** time: **HH:MM**; If incorrect time is entered error beep is heard, **ERROR** flashes and display shows **--:--**. If you enter a time, then change your mind, press **●** to clear time. Also, press **●** to set no off time.

Press **TIMER**. Display switches to frequency and **TIMER** is displayed indicating that **TIMER** is activated.

At this point, set the **R8** up for reception of desired signal either by **VFO** or **MEMORY** recall.

Press **POWER**. **R8** will now turn **ON** at programmed time, then shut **OFF** at programmed time. The receiver can be used without affecting the **EVENT** provided that the control settings are returned to those desired for the event. The **EVENT TIMER** can only turn the receiver **ON** and/or **OFF** at the programmed times.

If you wish to disable **TIMER** after programming **ON** and **OFF** times.

Press: **F** **TIMER**, **TIMER** extinguishes in display.

To re-activate timer-

Press: **F** **TIMER**, **TIMER** lights in display.

TIMER CONNECTOR INTERFACE

A standard 5 pin DIN connector located on the rear panel provides the connections for unattended, programmed **TIMER** On/Off control of cassette recorders, RTTY or FAX demodulators, etc. Please refer to **Figure 12** for a pin by pin description of this connector.

WARNING!!!

DO NOT USE TIMER CONNECTIONS TO SWITCH STANDARD 120 VAC LINE OPERATED EQUIPMENT DIRECTLY. MAXIMUM RATINGS OF TIMER CONNECTIONS ARE 30 VDC AT 1 AMPERE. IF IT IS NECESSARY TO SWITCH THE 120 VAC LINE UNDER TIMER CONTROL, IT WILL REQUIRE THE ADDITION OF AN EXTERNAL RELAY WITH THE PROPER CONTACT RATING THAT IS DRIVEN FROM THE R8's TIMER CONNECTOR.

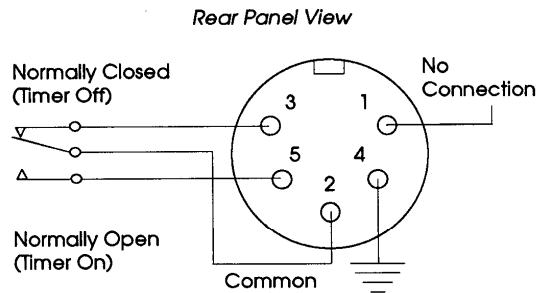

Figure 12 Timer Connections
Contacts shown with **TIMER OFF**

- Pin 1: No Connection.
- Pin 2: Timer Relay Common Connection. This connection switches between Pins 3 and 5 depending on the state of **TIMER**.
- Pin 3: Timer Relay Normally Closed Connection. Connected to relay Common when **TIMER** is OFF.
- Pin 4: Chassis Ground Connection.
- Pin 5: Timer Relay Normally Open Connection. Connected to relay Common when **TIMER** is ON.

As mentioned above, a common usage of the internal timer relay is to control a tape recorder to provide automatic, unattended recordings of received programs. By programming the **TIMER** On/Off times into the **R8**, the recorder will be turned On at the **TIMER ON TIME**, record the program, and then turn off at the **TIMER OFF TIME**.

A typical connection diagram is shown in **FIGURE 13**.

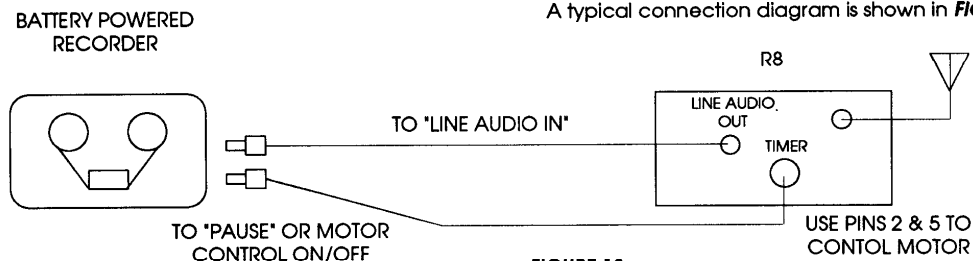



FIGURE 13



21 Special Use Features and Functions

The R8 has several special features that are referred to in the main body of this owner's manual but may require additional explanation.

FUNCTION LINE INVERT

As described on page 9 of this manual, the six function keys, located below the display area of the receiver, activate a primary or secondary function depending upon which particular function is displayed at the time of selection. The user can define either of the two function lines (displayed one line at any time) as the primary functions. To continuously display the alternate function line without incurring the "time out" action,

Press the  button and Hold for 3 seconds. Acknowledge beep will indicate that the alternate function line is now continuously displayed.

To summarize, pressing the  button allows access to the alternate function line for the short duration of the displayed function. Alternate function availability "times out" approximately 3 seconds after any front panel activity which alters the display. Pressing the  button and holding it for 3 seconds acts as a "Shift Lock" on the displayed function line.

10 KHz/9 KHz SCAN

If a selected scan range includes the 540-1600 KHz broadcast band, the R8 automatically switches to a 10 KHz step size while the receiver scans the broadcast band. The 10 KHz step size is practical for tuning the U.S. and Canadian broadcast bands. The step size can be changed to 9 KHz for any scan covering the region of 540 - 1600 MHz broadcast band to permit practical tuning of European broadcast stations. To select the alternate step size,

With **POWER OFF**

Press **BW/STEP** function line button and Hold while pressing the **POWER** button to put R8 in the **POWER 'ON'** mode.

If the step size was 10 KHz prior to performing the above procedure, then the 9 KHz step size for broadcast band scan is now programmed. To change back to 10 KHz, repeat the same procedure.

DELETE ALL MEMORY LOCATIONS

If it is desired to delete all programmed memory locations, perform the following procedure:

With **POWER OFF**,

Press the  button while pressing the **POWER** button to put R8 in the **POWER 'ON'** mode.

Hold the  button until a double 'beep' is heard to indicate that ALL memory locations have been cleared.

The R8 rear panel provides a common DB-9 connector which conforms to the RS-232C serial data communications standard with the R8 configured as DCE. This connector may be attached to a basic dumb ASCII terminal or a personal computer such as an IBM XT/AT running a terminal emulation program such as PROCOMM PLUS™ or BITCOM™. Standard BASIC terminal programs will run equally well.

The interface provides complete control and programming capability of the R8. Only the analog controls such as volume, RF gain, etc. are not controllable.

Please refer to **FIGURE 14** for interface connector pin out.

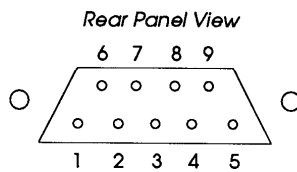

Pin	Signal Description
1	Scan Feedback; +5 Volts = Receiver Unsilenced
2	Rx DATA
3	Tx DATA
4	DTE Ready
5	Ground
6	DCE Ready
7	RTS
8	CTS
9	Ground

FIGURE 14 RS232C Interface Connections

NOTE:

The following additional items apply when using the RS232C Interface capability of the R8:

BITCOM™

- Use of version 3.58C is recommended.
- Select, under 'COMM OPTIONS':
Flw Ctl : RTS/CTS

PROCOMM PLUS™

- Under hardware flow control (RTS/CTS) set to ON
- Use of the particular BITCOM™ version of software mentioned above and setting the aforementioned Flow Control commands avoids having commands ignored by the computer or otherwise having the computer not react properly to commands.

PROCOMM PLUS™ is registered to DATAFORM Technologies, Inc.
BITCOM™ is registered to BIT Software, Inc.

23 RS232C Interface cont'd

R8 RS232 COMMAND	COMPUTER COMMAND (1)	RESPONSE
AGC set	AF AS AO	LF
ANT select	A1 A2 AC	LF
Noise blanker set	BW BN BF	LF
Step change (2)	ST (scrolls)	LF
Set frequency	F xxxxxxx	CR LF if OK CR if not
Synchro det. set (2)	SO, SF	LF
RF select	G+, G-, GO	LF
Notch set	NO, NF	LF
Mode select	M6 (AM), M5 (FM), M4 (CW), M3 (RTTY), M2 (LSB), M1 (USB)	LF
VFO select	VA, VB	LF
Bandwidth select	W0 (0.5), W1 (1.8), W2 (2.3), W4 (4.0), W6 (6.0)	LF
Memory mode	C	LF
Memory channel select	Cx (x= 0 to 99)	CR LF if OK CR if not
Program Memory Channel	PR X (X= 0 to 99)	CR LF if OK CR if not
Power on/off (5)	PO, PF	LF
Timer relay on/off (7)	TO, TF	LF
Identify receiver (5)	ID	R8 CR LF
Tune up (freq. mem or scan) (2)	U	None
Tune Down " " " "	D	None
Scan select (2)	Sx (x=1-3,4-5)*	LF
Scan start/stop (2)	Sc (toggle)	LF
*To enter memory lists to be scanned for S2, enter.		S2 CR 012.... CR (lists) SC CR
Report frequency	RF	xxx.xxxx mHz CR LF
Report frequency, repeat	RFR	same as above every 5 sec
Report mode	RM	xxxx CR LF
Report mode, repeat	RMR	same as above every 5 sec
Report mem channel	RC	*xx CR LF
Report mem channel, repeat	RCR	same as above every 5 sec
Report all	RA	*nn aaaa dd.ddddd#mHz n=mem ch a=mode d=digit *=active channel #=carrier present
Report all repeat	RAR	same as above every 5 sec
Report stop	RS	LF

NOTE: responses to all R_R commands will continue even during scanning to provide updates of the scan progress.

Table 5 RS232C Commands

(1) All commands terminated by carriage return CR, except U and D.
Commands 'Cx' and 'Fxxxxxx' require an optional Carriage Return as follows:
- If 'Cx' is followed by a Carriage Return, response is immediate.
- If 'Cxx' is entered, response is immediate (but note that no Carriage Return was required in this case).
(2) These commands may be used during scanning. Others are locked out.
(3) A null entry (carriage return by itself) results in a LF response.

(4) Format: RS-232C levels at rear panel connector.
1 start bit, 7 data, 1 stop bit
Even parity
9600 baud
Data is ASCII encoded
Half Duplex

(5) These commands allowed even if power is turned off (see PO/PF) others are locked out.

(6) Backspace can be used to correct typing error before hitting return.

(7) The programmed TIMER settings are overridden (but not erased) whenever the R8 is being controlled by the RS232C Serial Interface ('DTE Ready' line active).

Table 6

RESPONSE TO THE RM AND RMR COMMANDS: X X X X X CR LF

ASCII CHARACTER DISPLAYED ON SCREEN	FIRST CHARACTER		SECOND CHARACTER		THIRD CHARACTER		FOURTH CHARACTER	FIFTH CHARACTER			ASCII
	NOISE BLANKER	AGC	RF	NOTCH FILTER	ANT	MODE	BANDWIDTH	BFO	SYNCRO DET.	SCANNING	
0	OFF	OFF	OFF	OFF	1	▲	.5 KHz	B	OFF	NO	0
1	-	-	OFF	OFF	1		1.8	-	-	-	1
2	OFF	FAST	OFF	ON	1	SEE TABLE	2.3	B	OFF	YES	2
3	OFF	SLOW	OFF	ON	-		4.0	-	-	-	3
4	NARROW	OFF	ATTEN	OFF	CONV	7	6.0	B	ON	NO	4
5	-	-	ATTEN	OFF	CONV		-	-	-	-	5
6	NARROW	FAST	ATTEN	ON	CONV		-	B	ON	YES	6
7	NARROW	SLOW	ATTEN	ON	-		-	-	-	-	7
8	-	-	PREAMP	OFF	2		0.5	A	OFF	NO	8
9	-	-	PREAMP	OFF	2		1.8	-	-	-	9
:	-	-	PREAMP	ON	2		2.3	A	OFF	YES	:
;	-	-	PREAMP	ON	-		4.0	-	-	-	;
<	WIDE	OFF	-	-	-	▼	6.0	A	ON	NO	<
=	-	-	-	-	-		-	-	-	-	=
>	WIDE	FAST	-	-	-		-	A	ON	YES	>
?	WIDE	SLOW	-	-	-		-	-	-	-	?

Table 7

THIRD CHARACTER		FOURTH CHARACTER	
		0, 1, 2, 3, OR 4	8, 9, :, ;, OR <
0, 4, OR 8		LSB	USB
1, 5, OR 9		RTTY	CW
2, 6, OR :		FM	AM

EXAMPLE:

You type: RM (ENTER)
and the radio response on your screen is:

3 0 2 < 8 FROM TABLE

_____ VFO is A, SYNCRO DET. is OFF, radio is not scanning
 _____ BANDWIDTH selected is 6.0 KHz
 _____ ANTENNA selected is ANT 1
 _____ RF is OFF, NOTCH is OFF
 _____ NOISE BLANKER is OFF, AGC setting is SLOW

And using characters 3&4, from Table 7:

_____ <
 2 | AM Mode is AM

25 Suggested References

1) ***Passport to World Band Radio***

Published by:
International Broadcasting Services, Ltd.
P. O. Box 300
Penn's Park, Pennsylvania 18943

2) ***World Radio TV Handbook***

Volume 37
Published by:
Billboard Publications Inc.
1515 Broadway
New York, NY 10036

3) ***The ARRL Antenna Book***

Published by:
The American Radio Relay League
Newington, CT USA 06111
Copyright © 1988 by The American Radio Relay League
Library of Congress Catalog Card Number: 55-8966

4) ***The ARRL Handbook***

Published by:
The American Radio Relay League
Newington, CT USA 06111
Copyright © 1989 by The American Radio Relay League
Library of Congress Catalog Card Number: 41-3345

1) **AC Input** - Alternating Current power source available at wall outlet sockets.

2) **AM** - Amplitude Modulated signals in which the information or intelligence being transmitted changes the instantaneous amplitude of the transmitted carrier.

3) **AGC** - Automatic Gain Control which is employed in receivers to adjust the amount of gain in the receiver's circuitry to prevent distortion and maintain a nearly constant audio volume level over wide variations in received signal strength.

4) **Attenuation** - Loss, as applied in the text of this manual, added prior to the input stages of the receiver to reduce the level of very strong signals that may occur on certain bands, in certain locations, at certain times or a combination of all three factors. Each 10 dB (decibel) step reduces the power of the received signal by a factor of ten.

5) **CW** - Continuous Wave transmission signals. Actually, the signal is keyed on and off at precise intervals to convey information. Morse code is the most common CW signal.

6) **DC Input** - Direct Current power source such as is available from batteries or regulated power supplies. Lead acid storage batteries, such as employed in cars and boats, have a 12-14 volt DC output which is the proper operating voltage for the R8 receiver's DC input. Another requirement of the battery is its AMP-HR rating. To determine the number of hours of operation before battery recharging is required, divide the AMP-HR rating of the battery by (2 AMPS) the current requirement of the R8 receiver.

7) **Dynamic Range** - Ability of the receiver to faithfully reproduce high quality audio over a wide range of signal strength conditions - from very weak signals to very strong signals.

8) **Frequency** - Rate of reoccurrence in hertz or cycles/second of electromagnetic wave or carrier.

9) **FM** - Frequency Modulated signals in which the information or intelligence being transmitted changes the instantaneous frequency of the transmitter carrier.

10) **High Q, Electronically Switched Filter** - A multi bandwidth filter with high adjacent channel attenuation switched electronically.

11) **GMT** - Greenwich Mean Time.

12) **LCD - Liquid-crystal display** - composed of two parallel glass plates with conductive coatings sandwiching a liquid-crystal compound between them. The compound becomes opaque and reflective when subjected to an electric field. LCD displays are used as information displays on many types of electronic equipment.

13) **LSB** - Lower Side Band, the mirror image of the USB containing all of the modulation information of amplitude modulation in one half the bandwidth. The lower half, excluding the carrier, of an AM signal.

14) **Notch** - A response producing attenuation of signals over a narrow range of frequencies.

15) **Passband Offset** - A frequency conversion technique which skews the desired channel off center of the detection filters allowing low or high frequency components to be selectively attenuated.

16) **Passive Double Balanced Mixer** - A frequency conversion device requiring a locally generated oscillator (LO) to operate. An incoming RF signal is shifted relative to the LO producing an intermediate or IF frequency.

17) **RF** - Radio frequency

18) **RS232** - Electronics Industries Association standard physical-level interface between DTE (terminal) and DCE (modem).

19) **RTTY** - Radio Teletype communications.

20) **Squelch** - A user controlled adjustment which mutes the audio output below a certain signal strength.

21) **Synchronous Detector** - An amplitude modulation detector which utilizes a replica of the original transmitted carrier signal to improve the reception of weak signals.

22) **Synthesized** - Capable of generating a large number of different output frequencies, all related to a single, highly stable reference source.

23) **Up Conversion** - A frequency conversion technique that translates an incoming RF signal to a higher frequency.

24) **USB** - Upper side band, the mirror image of the LSB containing all of the modulation information of amplitude modulation in one half the band width. The upper half, excluding the carrier, of an AM signal.

25) **UTC** - Universal Time Coordinated.

26) **VFO** - Variable frequency oscillator

27) **VHF** - Very High Frequency band extends from approximately 30MHz to 300 MHz.

29 Troubleshooting

SYMPTOM	PROBABLE CAUSE	CORRECTIVE ACTION
No front panel display or lights when power is depressed	A) Power connection B) Blown supply fuse	A) Check power supply cables B) Check fuse C) Contact service
Scrambled front panel display when power is depressed	A) Microprocessor malfunction	A) Unplug from power source and reconnect to reset microprocessor
No signals heard when antenna is connected or sensitivity low	A) Squelch enabled B) Incorrect antenna input selected C) RF ATTN enabled D) RF gain improperly set	A) Turn squelch counterclockwise B) Select correct antenna input C) Turn off RF ATTN D) Turn RF gain clockwise
S meter indication, but remains constant	A) RF gain improperly set	A) Turn RF gain clockwise
S meter indication, but no sound heard	A) Improper mode selected B) External speaker selected C) Squelch enabled	A) Check mode selection B) Check external speaker switch on rear panel
SSB signals have excessively high or low frequency response	A) PASSBAND OFFSET improperly set	A) Center PASSBAND OFFSET control
No front panel operation i.e. tuning, frequency entry, etc.	A) Lock enabled B) Under RS 232 interface control	A) Press "F" "LOCK" to unlock front panel
Timer does not operate	A) Timer not properly set B) Alternate clock selected	A) Program timer ON/OFF times

Select VFO (page 12)	Press VFO until desired VFO is enclosed in box.
Adjust Frequency (page 12)	Select VFO . Use numeric keypad
Select Antenna (page 9)	Press ANT until desired antenna is enclosed in box.
Preamp or Attn (page 13)	Press RF until Preamp or Attenuator is enclosed in box.
Select AGC (page 9)	Press AGC until desired AGC action is enclosed in box.
Select Bandwidth (page 9)	Press BW-KHz until desired bandwidth is enclosed in box.
Select Mode (page 11)	Press MODE until desired mode is enclosed in box.
Select Synchro (page 13)	Press SYNCHRO to activate or deactivate Synchronous detector.

Most front panel pushbuttons perform two functions. The second function requires that the **F** button be pressed first, and then the desired 2nd function button pressed within 3 seconds. The symbol **F** →³ indicates that button is to be pressed within 3 seconds.

Set VFO A=VFO B (page 12)	F → ³ VFO until display shows A = B.
Select Noise Blanker (page 13)	F → ³ NB until display shows desired noise blanker mode.
Activate Timer (page 20)	F → ³ RF until display shows 'Timer'.
Set Timer On/Off (pages 19-20)	F → ³ TIMER (hold) until 'Timer On' shows. Use keypad to enter On time. Press TIMER again, 'Timer Off' will show. Keypad to enter Off Time. Press TIMER again to leave set mode.
Activate Notch (page 9)	F → ³ NOTCH , use Notch control to adjust for desired results.
Adjust Step Size (page 11)	F → ³ STEP . Frequency display will adjust accordingly.
Lock Controls (page 12)	F → ³ LOCK . Must be in VFO mode. Pushbuttons are inactive.
Display Time (page 19)	F → ³ CLK (press CLK again within 3 seconds to display 2nd time).
Set Time (page 19)	F → ³ CLK (hold until beep). Display will show 'L--:--:--' , Use keypad to enter time, plus first two digits of 2nd time. Press F to start clock.

31 Quick Reference Guide

Dim Lamp (8)

→ 3 → Press until dial lighting is at desired level.

Disable Beep (8)

→ 3 → to enable or disable beep.

MEMORY FUNCTIONS

Recall Memory Channel (page 16)

use keypad to enter channel number, or use or .

Load Memory Channel (page 16)

Select VFO & mode, adjust frequency & BW.

Press (MEM will flash), use keypad to enter memory channel number.

Move VFO to Memory (page 16)

Use (MEM will flash), use keypad to enter memory channel number.

Move Memory to VFO (page 16)

Use . Will move memory contents to last used VFO.

Lock Memory Channel (page 16)

Select memory channel to be locked,

→ 3 → .

Delete Memory Channel (page 16)

Select memory channel to be deleted.

→ 3 → (hold until 2nd beep).

SCAN MODES

All SCAN modes require selecting one of three SCAN METHODS. Select desired SCAN MODE and then select 'SEEK', 'TIME' or 'CARRIER'.

Scan Memory (page 17)

→ 3 → Select method,

→ 3 → or → 3 → or

→ 3 → . Press .

Scan List (page 18)

→ 3 → Select method,

→ 3 → or → 3 → or

→ 3 → . Press .

Scan A - B (page 18)

→ 3 → Select method,

→ 3 → or → 3 → or

→ 3 → . Press .

Other Controls Used in Scan Mode.

Passband Offset

Adjust for optimum reception.

Squelch/RF

Set squelch counterclockwise. Adjust RF (gain) counterclockwise until S-meter indicates desired signal level to trip squelch. Advance the Squelch control clockwise until the audio just quiets. Advance the RF (gain) clockwise.

SERVICE INFORMATION

You may contact R. L. DRAKE Service Department for additional information or assistance by calling (513) 746-6990, Monday through Friday, 8:00 A.M. - 5:00 P.M. EST, except on holidays.

Should you want to return your unit for service, package the receiver carefully using the original carton or other

suitable container. Write your return address clearly on the shipping carton and on an enclosed cover letter describing the service required, symptoms or problems. Also include your daytime telephone number and a copy of your proof of purchase.

The receiver will be serviced under the terms of the R. L. Drake Company Limited Warranty and returned to you.

ONE YEAR LIMITED WARRANTY

R. L. DRAKE COMPANY warrants to the original purchaser this product shall be free from defects in material or workmanship for one year from the date of original purchase.

During the warranty period the R. L. DRAKE COMPANY or an authorized Drake service facility will provide, free of charge, both parts and labor necessary to correct defects in material and workmanship.

To obtain such warranty service, the original purchaser must:

- (1) Complete and send in the Warranty Registration Card within 10 days of purchase.
- (2) Notify the R. L. DRAKE COMPANY or the nearest authorized service facility, as soon as possible after discovery of a possible defect, of:
 - (a) the model and serial number.
 - (b) the identity of the seller and the approximate date of purchase.
 - (c) a detailed description of the problem, including details on the electrical connection to associated equipment and the list of such equipment.
- (3) Deliver the product to the R. L. DRAKE COMPANY or the nearest authorized service facility, or ship the same in its original container or equivalent, fully insured and shipping charges prepaid.

Correct maintenance, repair, and use are important to obtain proper performance from this product. Therefore carefully read the Instruction Manual. This warranty does not apply to any defect that R. L. DRAKE COMPANY determines is due to:

- (1) Improper maintenance or repair, including the instal-

lation of parts or accessories that do not conform to the quality and specification of the original parts.

- (2) Misuse, abuse, neglect or improper installation.
- (3) Accidental or intentional damage.

All implied warranties, if any, terminate ninety (90) days from the date of the original purchase.

The foregoing constitutes R. L. DRAKE COMPANY'S entire obligation with respect to this product, and the original purchaser and any user or owner shall have no other remedy and no claim for incidental or consequential damages. Some states do not allow limitations on how long an implied warranty lasts or do not allow the exclusions or limitation of incidental or consequential damages, so the above limitation and exclusion may not apply to you.

This warranty gives you specific legal rights and you may also have other rights which vary from state to state.

For service information contact:

R. L. DRAKE COMPANY
230 Industrial Drive
Franklin, Ohio 45005 U. S. A.

Customer Service Center Phone: (+1) 513-746-6990
Telefax: (+1) 513-746-4683

MUTE OPERATION OF THE R8 COMMUNICATIONS RECEIVER

When using the R8 communications receiver with an external transmitter, it is often desirable to be able to externally mute the receiver during transmission. The R8 provides this external control by use of the "MUTE" connector located on the rear panel. Grounding the center pin of this connector forces the AGC circuitry in the R8 to shut down all RF/IF stages, thus quieting or muting the receiver.

THE MUTE LINE DOES NOT DISCONNECT THE ANTENNA.

If the R8 is not disconnected from the antenna, even a near-by separate antenna, damage to the R8 will result.

A suggested hookup is illustrated below:

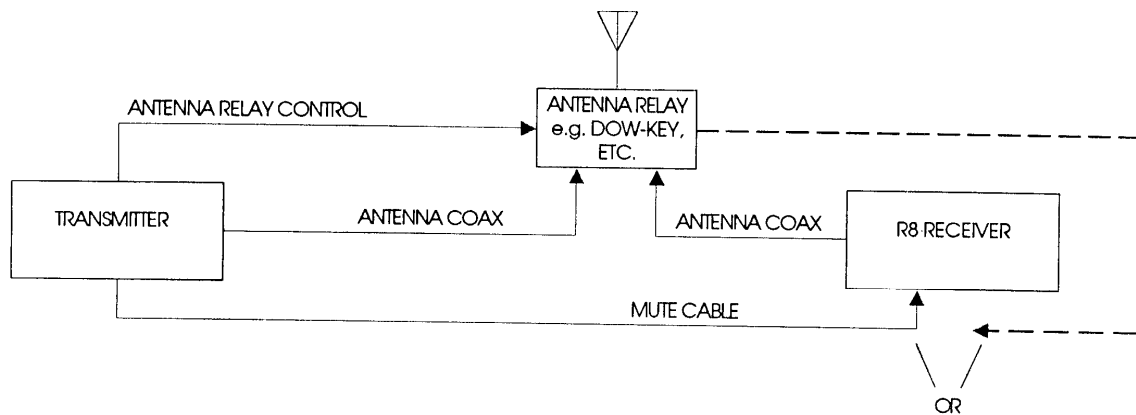

Older Drake equipment required the mute line to be grounded for receive. The R8 requires ground to mute. When using the R8 with older Drake equipment, an external relay is recommended to operate the mute line. Sometimes this may be accomplished by using a spare set of relay contacts on the antenna switch-over relay.

If you are not operating a linear amplifier, you can use the vox relay contacts to provide control of the R8 muting. Simply connect the two pin jack or RCA phono socket of the AC-4, PS-75, PS-7, power supply to the mute jack on the R8.

VHF CONVERTER INSTALLATION INSTRUCTIONS

CAUTION: Refer installation to qualified service technician to prevent personal injury or damage to the equipment.

Prior to starting installation of your new VHF converter, carefully unpack the converter PC board assembly and its associated cables and mounting hardware. You will need to use a Philips screwdriver during installation. Identify the following items:

- (1) #1001590 VHF Converter Assembly
- (1) #3711160 Coaxial Cable, 8' Length
- (1) #3711168 Coaxial Cable, 26' Length
- (1) #2707293 6-Conductor Cable, 17' Length
- (1) #4350171 Retaining Bracket
- (1) #3320244 Screw 4-40 x 1/4" Pan Head Phillips

Install the VHF Converter assembly as follows:

DISCONNECT THE R8 RECEIVER FROM THE AC POWER SOURCE!

1) Remove the top cover from the R8 receiver by removing (5) #6-32 x 1/4" Pan Head Phillips BLACK screws. Retain the cover and screws for reassembly.

2) Remove the bottom cover from the R8 receiver by removing (6) 4-40 x 1/4" Pan Head Phillips screws. Retain the cover and screws for reassembly.

3) Position the R8 with the rear panel directly facing you (Figure 1). Remove (2) screws at left hand side of rear panel. Retain these screws for later reassembly.

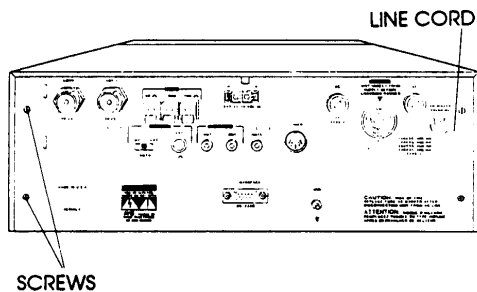

FIGURE 1

4) Locate the top mounted printed circuit board (Front End Board) as shown in Figure 2. Remove (3) screws that attach the board to the chassis standoffs. Retain the screws for later reassembly.

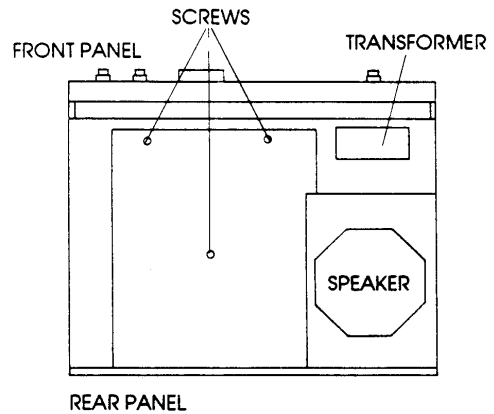

FIGURE 2 R8 TOP VIEW

5) Identify the (6) conductor cable (17' length) and plug it onto the VHF converter assembly (Figure 3) being careful to align the connector with the RED conductor on Pin 1 of the VHF converter assembly.

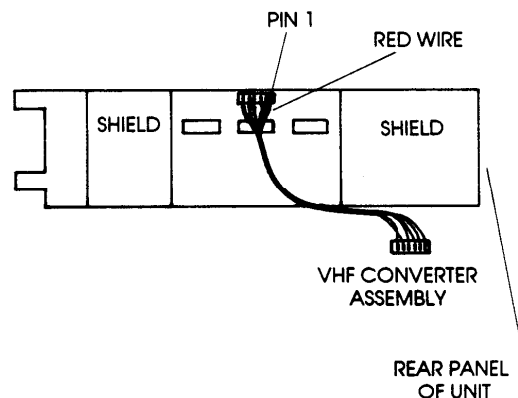

FIGURE 3

6) Route the free end of the 6-conductor VHF converter cable vertically down along the rear panel wall and past the synthesizer board assembly until the cable connector is visible out the bottom of the R8 receiver (Figure 4).

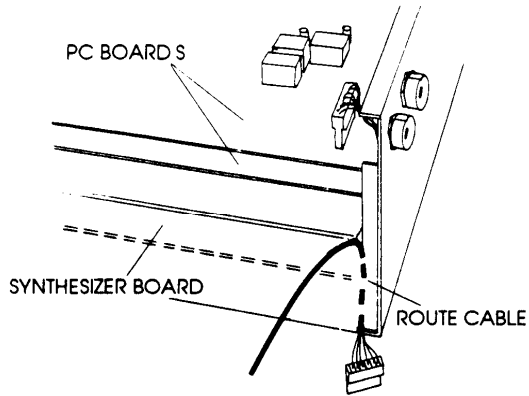

FIGURE 4

Locate the Retaining Bracket and position to edge of the VHF Converter assembly as shown. Use the supplied #4-40 x 1/4 Pan Head Phillips screw to secure the bracket to the R8 chassis (Figure 6).

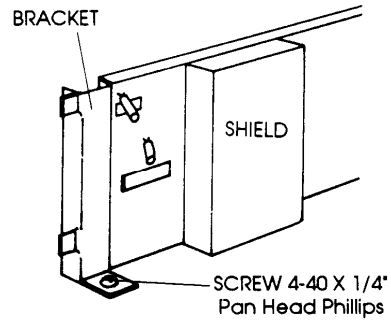

FIGURE 6

7) Position the VHF converter assembly into the chassis as illustrated (Figure 5). The board mounted components should face toward the outside edge of the R8 with the larger of the two component side shields toward the rear panel of the R8. Align the two tabs into the slots located on rear panel of the R8. Reposition any cables at rear panel, as necessary, to allow converter assembly to fit at the rear panel wall.

8) Replace the (2) rear panel screws, 4-40 x 1/4" Pan Head Phillips and (3) Front End board assembly screws that were removed in steps #3 and #4.

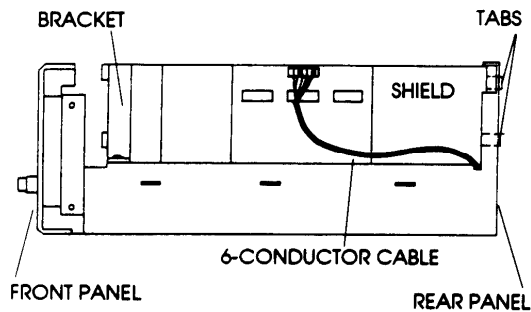

FIGURE 5 R8 SIDE VIEW

9) With the converter assembly now secured in the chassis with 6-conductor cable attached, position the R8 so it rests on its left-hand side (facing front of receiver). Locate the unconnected end of the 6-conductor cable and connect it to the synthesizer board connector in the orientation shown in Figure 7. Be careful to align the RED conductor on Pin 1 of the synthesizer board assembly connector header. Position the cable assembly so that it routes toward the rear panel (reduce any excess slack cable length near the VHF converter to provide the proper routing along the rear panel and its approach to the synthesizer connector header).

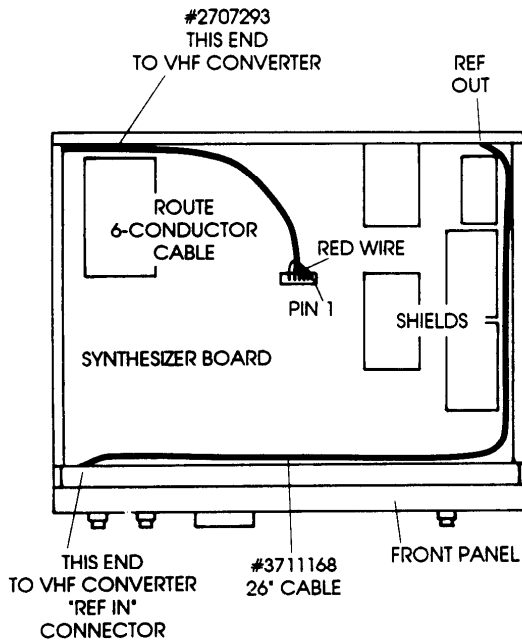

FIGURE 7 R8 BOTTOM VIEW

10) Connect the supplied 26' 'REF' coaxial cable #3711168 to the 'REF OUT' connector located near the right rear corner of the synthesizer board. Position the cable as shown in Figure 7, routing the free end of the coax cable along the front panel and up to the VHF Converter assembly end nearest the front panel.

11) Position the R8 receiver so it rests on its bottom chassis with front panel facing towards you. Plug the unconnected end of the 26' 'REF' coaxial cable #3711168, into the 'REF IN' connector located on the VHF converter assembly as shown in Figure 8.

12) Locate the factory installed coaxial cable connected to the rear panel 'CONV' antenna input connector. Disconnect the terminal end of this coax from the Front End Board connector. Plug the coax cable into the 'RF IN' terminal of the VHF Converter as shown in Figure 8.

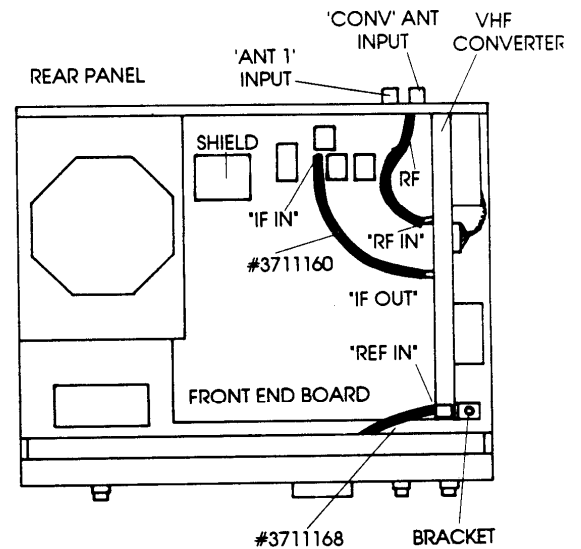

FIGURE 8 R8 TOP VIEW

13) Identify the 8' Coaxial Cable, #3711160. Plug in one end of the cable to the 'IF IN' terminal on the Front End board assembly and plug the other end into the 'IF OUT' terminal of the VHF Converter assembly.

The VHF Converter electrical installation is complete at this point. Prior to applying AC power to the R8 receiver for testing, proceed as follows:

14) Position the R8 with the bottom of the unit facing up, front panel toward you. Place the bottom cover on the unit oriented with the lever feet toward the front panel of the R8. Secure the bottom cover using (6) #4-40 x 1/4" Pan Head Phillips screws that were removed in step #2.

NOTE: You may wish to secure the bottom cover with (2) screws until after unit system check, but note that **AC power is active at all times in the R8 whenever it is connected to a source of AC power.**

15) Position the R8 with the top of the unit facing up, front panel towards you. Install the top cover using the (5) #6-32 x 1/4" Pan Head Phillips BLACK screws retained in step #1.

UNIT SYSTEM CHECK

16) Connect the R8 to a source of AC power. Press the 'POWER' button to place the R8 in the 'ON' mode. The unit should automatically switch to the converter antenna input if any frequency in the range of either 35 - 55 MHz or 108 - 174 MHz is selected. (If the above action does not occur, check the 6-conductor cable assembly of the VHF converter). Once proper operation is noted, tune in a known active signal in either the range of 35 - 55 MHz or 108 - 174 MHz. Select the proper mode, bandwidth and other parameters as appropriate.

HINT: In many areas of the U.S., the NOAA weather stations are active on one of the following frequencies: 162.475 MHz, 162.550 MHz or 162.625 MHz. One of those or a similar type station could be tuned in as a convenient operational check.

Once correct operation is verified, disconnect the R8 from the AC Power Source. Secure the top and bottom covers with remaining screws if this has not already been completed in steps #14 and #15.

The R8 with VHF Converter is now ready for operation.

SPECIFICATIONS:

(Apply to the operation of the VHF Converter assembly installed in the R8 receiver)

Frequency Range	35-55 MHz 108-174 MHz
Antenna Impedance	50 ohms
Sensitivity: SSB, CW (+10dB S+N/N)	Less than 0.25 μ V (2.3 KHz Bandwidth)
Sensitivity: AM (+10 dB S+N/N) (1 KHz, 30% mod)	Less than 1.0 μ V
Sensitivity: FM (12 dB SINAD)	Less than 0.5 μ V
Frequency Stability	Better than ± 10 ppm, -10 $^{\circ}$ to +50 $^{\circ}$ C (determined by the R8 master reference oscillator)
Power Requirements	+10 VDC @ 150 mA
FCC Approval	Part 15 Certification
Weight	6.7 Oz. (0.2 Kg)
Size	Length 9 5/8" (24.4 cm) Width 2 1/2" (6.4 cm) Height 1 1/8" (2.9 cm)

Back Page

DRAKE