

DRAKE

MODEL

SPR-4

COMMUNICATIONS

RECEIVER



Technical Manual

MANUAL PRICE \$3.00

STANDARD WARRANTY

R. L. DRAKE COMPANY warrants each new radio product manufactured by it to be free from defective material and workmanship and agrees to remedy any such defect or to furnish a new part in exchange for any part of any unit of its manufacture which under normal installation, use, and service discloses such defect, provided the unit is delivered by the owner to us or to our authorized radio dealer or wholesaler from whom purchased, intact, for our examination, with all transportation charges prepaid to our factory, within ninety days from the date of sale to original purchaser and provided that such examination discloses in our judgement that it is thus defective. Should a malfunction be suspected, write in detail to our Service Department for suggestions concerning the operation, repair or return of your unit if it should prove necessary.

This warranty does not extend to any of our radio products which have been subjected to misuse, neglect, accident, incorrect wiring not our own, improper installation, or to use in violation of instructions furnished by us, nor extend to units which have been repaired or altered outside our factory, nor in cases where the serial number thereof has been removed, defaced or changed, nor to units used with accessories not manufactured or recommended by us.

Any part of a unit approved for remedy or exchange hereunder will be remedied or exchanged by the authorized radio dealer or wholesaler without charge to the owner.

This warranty is in lieu of all other warranties expressed or implied and no representative or person is authorized to assume for us any other liability in connection with the sale of our radio products.

The R. L. DRAKE COMPANY reserves the right to make any improvements to its products which it may deem desirable without obligating itself to install such improvements in its previously manufactured products.

1. GENERAL DESCRIPTION

1.1 FEATURES

The SPR-4 is an all solid-state communications receiver which can be programmed with accessory crystals to cover 150 kHz to 30 MHz. The SPR-4 receives AM, CW, SSB (upper and lower) and may be powered from 120 VAC, 240 VAC and 12 VDC.

1.2 SPECIFICATIONS

1.2.1 GENERAL SPECIFICATIONS

Frequency Coverage: Can be programmed with accessory crystals for 23 ranges (each tuning a 500 kHz band) from .5 to 30 MHz plus 150 to 500 kHz. Generous PTO dial overtravel allows additional 50 kHz or more off each end of range. Crystals supplied with the receiver allow coverage on these ranges;

150 - 500 kHz	9.5 - 10.0 MHz
.5 - 1.0 MHz	11.5 - 12.0 MHz
1.0 - 1.5 MHz	15.0 - 15.5 MHz
6.0 - 6.5 MHz	17.5 - 18.0 MHz
7.0 - 7.5 MHz	21.5 - 22.0 MHz

Modes of Operation: AM, CW, SSB (upper and lower), and RTTY with RTTY adapter.

Selectivity:

AM	4.8 kHz @ 6 dB, 10.0 kHz @ 60 dB
SSB	2.4 kHz @ 6 dB, 7.2 kHz @ 60 dB
CW	.4 kHz @ 6 dB, 2.7 kHz @ 60 dB
RTTY	With RTTY adapter, RTTY can be received in SSB (lower) or CW.

Sensitivity: SSB, CW, and RTTY: .25 microvolt for 10 dB S + N/N.
AM: .5 microvolt with 30% modulation for 10 dB S + N/N.

Intermediate Frequencies: 1st IF 5645 kHz, 2nd IF 50 kHz.

Frequency Stability: At room temperature, drift for all causes (including \pm 10% change in supply voltage) is less than \pm 100 Hz.

Automatic Volume Control: AVC is used on all modes. Time constants are selected for the optimum effectiveness on each mode. Audio output is held constant to 6 dB over a 100 dB range of input signals.

Input Impedance: 50 ohms approximately, on ranges C - H. On ranges A and B, input is high impedance and plug in loop antenna is low impedance.

Audio Output Power: 3 watts into 4 ohm load (less into higher impedance loads).

Hum and Noise: More than 60 dB below rated output.

Calibration: Dial is accurate to better than \pm 1 kHz when calibrated to nearest 100 kHz calibration point.

1.2.2 POWER CONSUMPTION: 18 watts on 120 V DC, or 240 V AC, and 6 watts on 12 V DC. 2.5 watts on 12 V DC with dial lamps turned off.

1.2.3 SIZE AND WEIGHT: 5-1/2" H x 10-3/4" W x 12-1/4" D,
18 pounds.

1.2.4 SEMICONDUCTOR COMPLIMENT:

<u>Symbol</u>	<u>Type</u>	<u>Function</u>
Q1	2N3394	Loop Amplifier
Q2	2N3394	Range Crystal Oscillator
Q3	2N3563	PTO Buffer
Q4	SFC4982, MFE3007	RF Amplifier
Q5	SFC4982, MFE3007	Premixer
Q6	2N5950	PTO Oscillator
Q7	2N5245	1st Mixer
Q8	2N5245	1st Mixer
Q9	B5030	D.C. Regulator
Q10	SFC4982, MFE3007	2nd Mixer
Q11	2N5245	Crystal Oscillator
Q12	B5030	Audio Amplifier
Q13	B5030	Audio Amplifier
Q14	2N5949, MPP102	S-meter Amplifier
Q15	2N3394	Audio Amplifier
Q16	2N4125	Audio Amplifier
Q17	2N5950, MPP102	Crystal Oscillator Buffer
Q18	2N4125	AVC Amplifier
Q19	2N3394	Audio Amplifier
Q20	2N3394	Audio Amplifier
Q21	2N3566	Negative Supply Driver
Q22	2N3394	Audio Amplifier
Q23	SFC4982, MFE3007	IF Amplifier
Q24	SFC4982, MFE3007	IF Amplifier
Q25	2N3566	AVC Detector
Q26	2N4125	Mute Control
Q27	2N3394	BFO
Q28	2N3394	AM Detector
IC-1	CA3053	S-meter Amplifier

<u>Symbol</u>	<u>Type</u>	<u>Function</u>
CR1	1N270	Premixer Switch
CR2	1N4148	RF Amplifier Protection
CR3	1N4148	RF Amplifier Protection
CR4	1N714	Zener Regulator
CR5	B5G5	Power Supply Rectifier
CR6	B5G5	Power Supply Rectifier
CR7	B5G5	Power Supply Rectifier
CR8	Z13B	Zener Regulator
CR9	1N714	Zener Regulator
CR10	1N4148	AVC Switch
CR11	1N270	AVC Switch
CR12	1N4148	Negative Supply Rectifier
CR13	1N4148	Negative Supply Rectifier
CR14	1N751	Zener Regulator
CR15	1N4148	AVC Switch
CR16	1N4148	AVC Switch
CR17	1N4148	AVC Switch
CR18	1N4148	AVC Switch
CR19	1N270	Product Detector
CR20	1N270	Product Detector
CR21	1N270	AM Detector

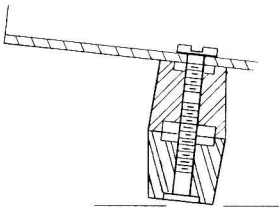
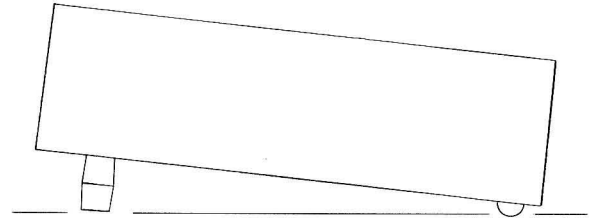
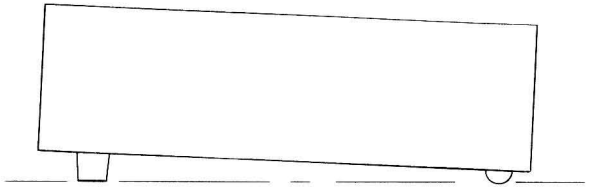
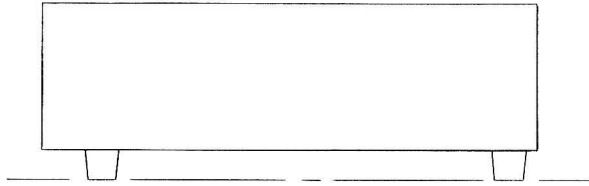

VIEWING ANGLE OPTIONS
Figure 1.

2 . INSTALLATION

2.1 UNPACKING

Carefully remove the receiver from the shipping carton, and examine it for evidence of damage. If any damage is discovered, immediately notify the transportation company that delivered the receiver. Be sure to keep the shipping carton and packing material, as the transportation company will want to examine them if there is a damage claim. Keeping the carton and packing material is recommended even when no shipping damage occurs, as having the original carton available makes shipment of the receiver much easier should it ever be necessary to return it to the factory for service.

2.2 LOCATION

The SPR-4 will work well in almost any location. Extremely hot areas such as over a radiator should be avoided. No air circulation around the receiver is required.

2.3 POWER REQUIREMENTS

The SPR-4 will operate on 120 or 240 VAC 50/60 Hz or from any 12 - 15 VDC source with negative ground.

The SPR-4 is shipped from the factory ready for 120 V AC operation with the power cord supplied. A 1/4 amp, slow-blow fuse, Buss type MDL 1/4, is installed in the fuse holder on the rear of the chassis.

For operating from 240 V AC, the same power cord is used and the 120/240 volt slide switch at the chassis rear is moved to the 240 position. This requires moving the small metal keeper from the right to the left mounting screw on the slide switch.

Also for 240 volt operation, the fuse should be changed to a 1/8 amp, slow-blow, Buss type MDL 1/8.

WARNING: NEVER CONNECT THE SPR-4 TO 240 VOLTS WITH THE SWITCH IN THE 120 VOLT POSITION.

For DC operation, a separate power cord is all that is required. This cord is available with a cigar lighter plug installed.

2.4 ANTENNAS

For optimum performance the SPR-4 should be used with a good antenna. For general broadcast and short wave listening, a long wire antenna from

50 to 100 feet long will give good results. An antenna kit (Model AN-5) is available.

For best single band performance, a half wave dipole or other resonant antenna, fed with unbalanced 50 ohm coaxial cable, may be used. However, Bands A and B require a long wire antenna.

For directional reception on 150 kHz to 1600 kHz, the accessory AL-4 shielded loop antenna may be used. All antennas other than the AL-4 loop antenna, connect to the Ant. jack on the rear of the chassis.

2.5 SPEAKERS

The SPR-4 has a built in 3" x 5" ceramic magnet speaker which makes optimum use of the available space in the cabinet. It may be desirable to use an external speaker when the receiver is used at fixed locations.

The Drake MS-4 Speaker, housed in a cabinet that matches the SPR-4, provides excellent audio reproduction and comes equipped with a cable terminated in a phono plug matching the speaker socket on the rear of the SPR-4.

2.6 HEADPHONE OPERATION

Best results will be obtained with a set of good quality headphones. The headphone connection is made through the jack at the bottom left of the front panel of the SPR-4. A standard 1/4 inch phone plug will mate with the jack. Connecting the headphones to the receiver turns off the speaker. The SPR-4 will accommodate headphones of any impedance.

2.7 VIEWING ANGLE OPTIONS

As supplied, the SPR-4 sits with its base parallel to the mounting surface, and its front panel vertical to the mounting surface. With the studs and rubber feet supplied, it is possible to position the SPR-4 for either of two alternate viewing angles as shown in Figure 1. To convert the SPR-4 to either option, remove the bottom row of three screws on each side of the receiver, and remove the bottom cover. For Option 1, remove the rear feet and snap the small rubber feet into the holes just inboard from the original rear feet and replace the bottom cover. For Option 2, remove the front feet, invert them, and remount them with the same screws. Thread one of the accessory studs into each of the remounted front feet. Remove the rear feet and screw them onto the studs on the front feet and replace the bottom cover.

2.8 REAR CONTROLS AND CONNECTORS

Refer to Figure 3 for the location of the connectors and controls.

2.8.1 POWER

The power connector mates with both the AC and DC power cords .
See "2.3" .

2.8.2 FUSE

The fuse holder must have the proper fuse installed for 120 or 240 V AC operation. See "2.3" .

2.8.3 SPEAKER

The internal speaker is normally connected to the speaker jack , when an external speaker is used , disconnect the internal speaker by removing the plug and connect the external speaker to this jack .

2.8.4 ANTI VOX and INJECTION

The holes marked ANTI VOX and INJ are intended for installation of connectors for the TA-4 accessory which permits the SPR-4 to transceive with the T-4XB . The injection and anti-vox cables from the T-4XB are plugged into these jacks .

2.8.5 MUTE

A shorted phono connector is normally installed in the MUTE jack . When the shorted connector is removed , the SPR-4 will be muted . When the SPR-4 is used as a companion to the T-4XB , the mute cable from the T-4XB is plugged into this jack .

2.8.6 GROUND POST

A binding post is provided to allow connecting the SPR-4 chassis to earth ground .

2.8.7 RTTY

The hole marked RY is intended for the installation of a connector for the RY-4 accessory which permits the SPR-4 to receive RTTY signals . An external switch is plugged into this jack which enables RTTY reception when the jack is shorted and the SPR-4 mode switch is in the CW or LSB position .

2.8.8 AUDIO IN/OUT

The AUDIO IN/OUT jack provides approximately .08 volts of audio into a high impedance load such as a tape recorder . The output level is independent of the setting of the AUDIO GAIN control .

The SPR-4 audio amplifier may be used with an external audio source such as a tuner. The level of the external source must be approximately .08 volts into a 3 K load. The received signals may be eliminated by turning the RF GAIN control counter-clockwise or by removing the mute plug.

2.8.9 DIAL LAMPS

The DIAL LAMPS switch may be used to turn off the three dial lamps. Since the power required to operate the dial lamps is somewhat greater than the power required by the rest of the SPR-4, the operating time for a battery power supply may be extended by turning the lamps off. The on and off positions of the switch are interchanged when operating with a DC power cord.

2.8.10 ANTENNA JACK

The antenna jacks mate with a standard phono fitting. A special antenna fitting (a pin with a spring clip attached) is supplied with the SPR-4 and may be used by inserting it into the antenna jack. The antenna lead-in is then connected to the clip.

2.8.11 ACCESSORY CRYSTAL INSTALLATION

The top of the SPR-4 cabinet must be removed in order to install additional crystals. This is accomplished by removing the top row of screws on both sides of the set. Also, disconnect the cable from the speaker jack. Be sure the power cord is disconnected. The top of the cabinet may now be removed.

At the bottom of each segment of the crystal selector dial is a small number (0 - 23) which corresponds to a particular crystal socket. The crystal location diagram which is located on the chassis behind the crystal sockets indicates the number of each socket. No crystal is required for reception of 150 - 500 kHz, therefore there is no crystal socket numbered zero.

Install the accessory crystal in one of the empty sockets. Locate the appropriate crystal dial decal from the sheet supplied with the crystal. Remove the decal from the sheet by cutting along the appropriate lines with a pair of scissors. Remove the backing from the decal and install it in the dial sector with the same number as the crystal socket used. Replace the cabinet top and the speaker cable.

On certain ranges there are spurious internal signals which are unavoidable in this double conversion, super-heterodyne receiver. These are due to outputs of internal conversion oscillators. There are five frequencies that should be avoided if possible. These are; 5.222 MHz, 5.595 MHz, 5.695 MHz, 9.963 MHz, and 15.334 MHz.

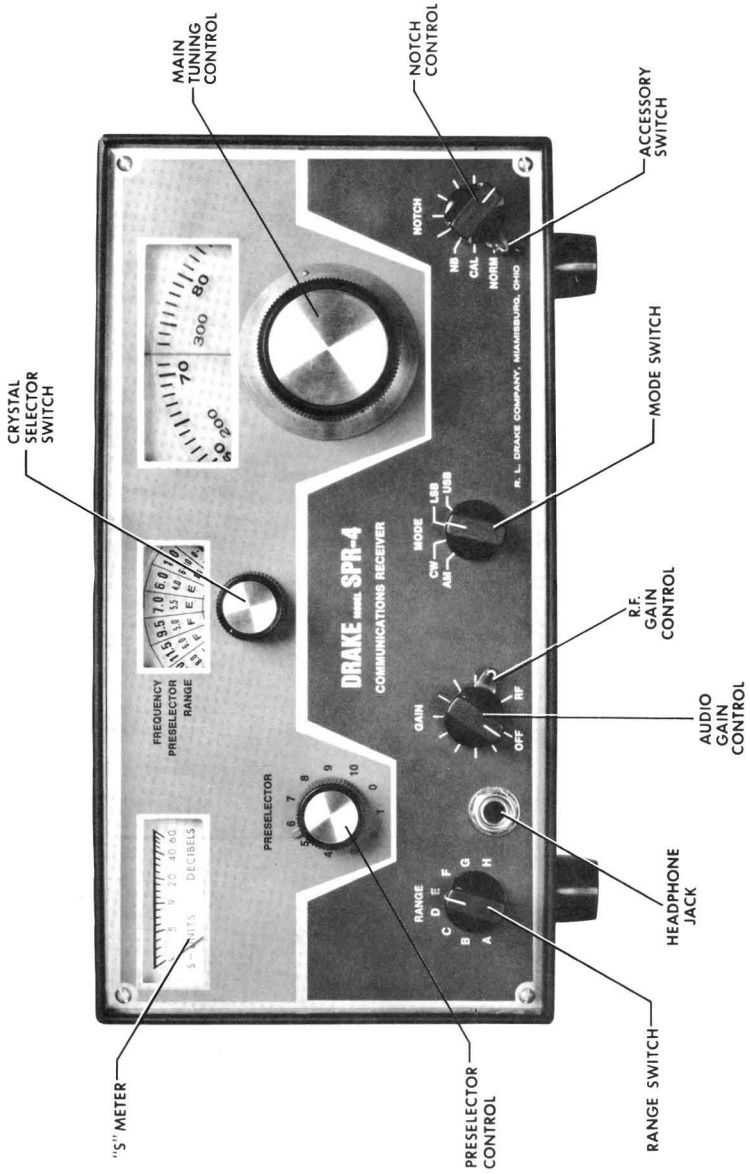

FRONT PANEL OPERATING CONTROLS

Figure 2

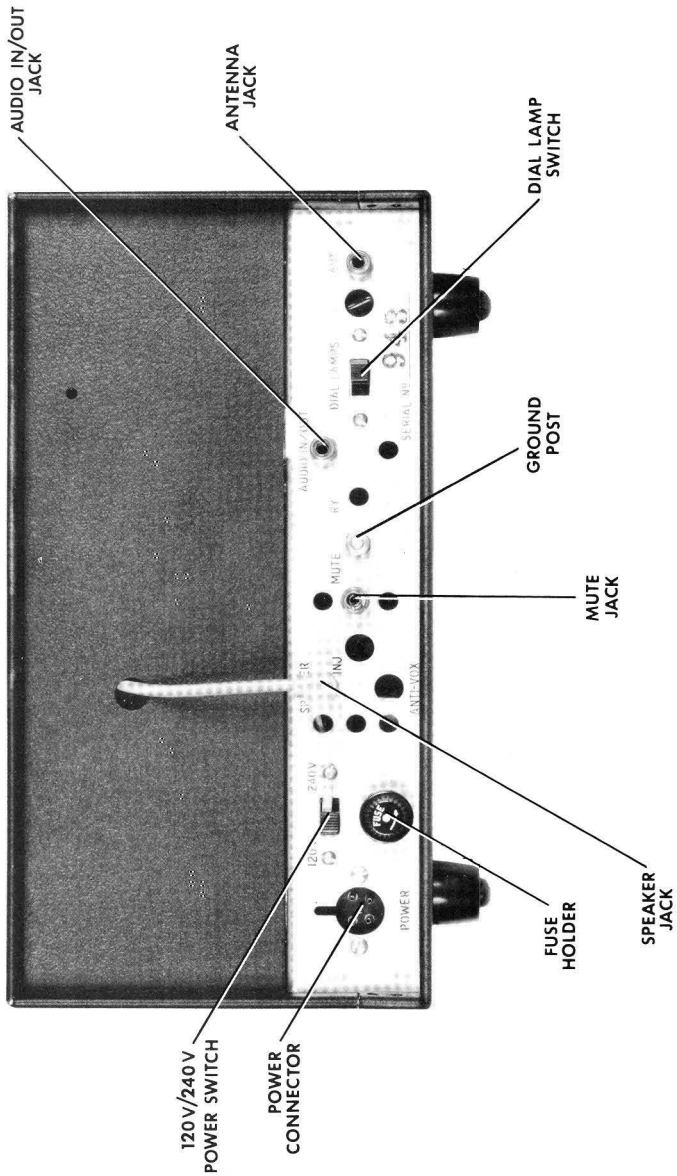

REAR CONTROLS AND CONNECTIONS
Figure 3

3. OPERATION

Refer to Figure 3 for the location of the operating controls .

3.1 OPERATING CONTROLS

1. The S-meter indicates the relative level of the received signals .
2. The crystal selector switch selects the band determining crystals . The top line of the dial sector reads the lowest frequency of each band in MHz , the middle line indicates the approximate position for tuning the preselector and the bottom line indicates the proper setting of the range switch .
3. The main tuning dial reads 0 to 500 kHz with 1 kHz graduations . When the tuning dial reading is added to the crystal dial reading , the actual received frequency is indicated to 1 kHz .

The main tuning dial consists of two concentric transparent discs that rotate at different speeds . Zero to 100 kHz is indicated on one disc and hundreds of kHz are indicated on the other disc . The dial may be calibrated by rotating the skirt with respect to the knob .

4. The preselector is set to the position indicated by the number on the middle line of the crystal selector dial and then fine tuned for peak signal .
5. The range switch sets up the proper tuned circuits to cover the desired band of frequencies . It is set to the position indicated on the bottom line of the crystal selector dial .
6. The headphone jack mates with a standard 1/4 inch phone plug . Connecting the headphones to the receiver will turn off the speaker .
7. The audio gain control adjusts the audio output to the proper level .
8. The RF gain control controls the gain of the receiver for all signals which are below the AVC threshold level to which the control is set . This control is normally set in the full clockwise position . Counter-clockwise rotation reduces the gain of the receiver .
9. The mode selector switches in a product detector for CW and SSB or a diode detector for AM . The proper I.P. bandwidth and AVC time constant is also selected .
10. The notch control may be used to eliminate or reduce an interfering heterodyne or CW signal . The off position , which is shown in Figure 2 , has a positive detent . Counter-clockwise rotation of the

knob from the off position moves the rejection notch across the receiver passband.

11. The accessory switch turns on the 5-NB Noise Blanker and the SCC-4 Crystal Calibrator if they are installed. The 5-NB and the SCC-4 are off in the NORM position.

3.2 SIMPLIFIED OPERATING PROCEDURE

As an example, suppose that the SPR-4 is to be tuned to 7272 kHz. First turn the crystal selector dial to the 7.0 MHz position. Set the preselector to 5.5 as indicated on the second line of the crystal selector dial. Next set the range switch to E as indicated on the bottom line of the crystal selector dial. Turn the tuning knob until the 100 kHz dial is between 200 and 300 and the one kHz dial is on 72. Select the desired mode of reception with the mode switch. The RF gain control should be full clockwise and the notch should be in the off position. Turn on the receiver with the audio gain control and adjust it for normal audio output. Fine tune the preselector for maximum indication of the S-meter.

The frequency of the received signal is the sum of the crystal dial reading and the main tuning dial reading as shown by the example:

Crystal Selector Reading	7.000 MHz
100 kHz Dial Reading	.200
1 kHz Dial Reading	<u>.072</u>
Frequency of Received Signal	7.272 MHz

3.3 DIAL CALIBRATION

The main tuning dial calibration may be adjusted over a short frequency range by using the known frequency of the SCC-4 crystal calibrator or a station such as the National Bureau of Standards, WWV, on 2.5, 5, 10, 15, 20, and 25 MHz. Usually 5 and 10 MHz WWV signals are the easiest to receive. With the mode switch in the CW, LSB or USB position, tune the signal from the SCC-4 or WWV to zero beat. Hold the main tuning knob stationary and rotate the skirt until the dial reads the correct frequency.

4. PRINCIPLES OF OPERATION

4.1 LOOP AMPLIFIER

On Bands A and B, Q1 amplifies signals from the loop antenna and feeds one gate of the R.F. amplifier Q4, through C52 and the tuned circuits formed by C9, C10, C13, C16, C18, C22, C23, C25, C27, C33, T2, and T4.

On Bands A and B, signals from an external antenna connected to J2 (ANT) bypass Q1 through C10 and C13 into the tuned circuits described above.

4.2 R.F. AMPLIFIER

On Bands C through H signals from an external antenna connected to J2 (ANT) are coupled to Q4 through T3 and C52. T3 is resonated with C101 and the capacitors connected to S5R. Q4 is protected from large signals by CR2 and CR3 which are reverse biased. CR2 and CR3 limit the signal to a safe level by conducting when a large signal overcomes their reverse bias.

On Bands A and B the drain of Q4 is untuned and drives the 1st mixer through C90 and C96. On Bands C through H, the drain of Q4 is tuned by T5, the capacitors connected to S9F, and drives the 1st mixer through C90.

4.3 FIRST MIXER

The 1st mixer is a balanced mixer comprised of Q7 and Q8 and driven by the R.F. amplifier and the pre-mixer. On Band A, the pre-mixer is bypassed and the 1st mixer is driven from the P.T.O. through R25 and C99. On Bands B through H, the pre-mixer drives the 1st mixer through T6 and C99.

The 1st mixer is balanced by R40 and the output is tuned by C102 and T8 and drives the 2nd mixer through C110, the 5645 crystal filter, and T9. Heterodyning of the R.F. amplifier and pre-mixer (P.T.O. on Band A) results in a difference frequency output from Q7/Q8 of 5645 kHz.

4.4 PREMIXER

The pre-mixer system consists of the P.T.O., the crystal oscillator Q2, the pre-mixer transistor Q5, and the tuned circuits associated with S1, S4F, S4R, S8F, and S8R.

The collector of the crystal oscillator Q2 is tuned by L5 and the components connected to S1. The feedback winding on L5 is connected through S2 to the proper range crystal and the output of Q2 is connected

to one gate of the pre-mixer, Q5 through C26 and R15. The P.T.O. drives the other gate of Q5 through R25 and C76. The P.T.O. is tuneable from 4955 kHz to 5455 kHz.

The output of Q5 is tuned by the components associated with S4F, S4R, S8F, S8R and drives the 1st mixer through T6, S6R, C99 and C96.

4.5 SECOND MIXER

The 2nd mixer, Q10, is driven by the 1st mixer and the crystal oscillator buffer Q17. Q10 is coupled to the 1st IF amplifier through the T notch filter and the 50 kHz four pole Hi-Q ferrite LC filter. Heterodyning of the 1st mixer and crystal oscillator results in a difference frequency output from Q10 of 50 kHz.

4.6 I. F. SYSTEM

The I.F. system is composed of the 1st I.F. amplifier, Q23, which drives through T15, the 2nd I.F. amplifier, Q24. C169 and C187 tune T15 and T16 respectively to 50 kHz and T16 drives the detection systems.

4.7 DETECTION SYSTEMS

4.7.1 AM DETECTION

The AM signal from T16 is detected by CR21 and amplified by Q28 to a level matching the output level of the product detector and is applied to the audio gain control through C167 and S14F.

4.7.2 CW AND SSB DETECTION

CW and SSB signals from T16 are detected by the product detector made up of CR19, CR20, R122, R123, and Q27, the beat frequency oscillator. The output of the product detector is applied to the audio gain control through S14F.

4.8 AUDIO AMPLIFIER

A portion of the audio signal, determined by the setting of R101, is applied to Q22 through a low-pass filter consisting of L10, L11, C164, R97, R95, C163, and C159 which eliminates any residual 50 kHz signal from driving the audio amplifier. Q22 amplifies this audio signal and drives Q20 through C148 where further amplification occurs and Q20 drives Q16 directly and Q15 via Q19 which is unity gain common base amplifier. Q12, Q15 and Q13, Q16 are darlington connected amplifiers and the configuration of Q16 establishes a phase inversion permitting Q12 and Q13 to operate in push-pull, Q12 and Q13 operate the speaker or a headphone through coupling capacitor C127.

4.9 AVC SYSTEM

The AVC threshold is established by the setting of R111, the R.F. gain control. R111 is normally operated fully clockwise. This applies approximately +2 volts to the AVC line through R104, R100 and CR15 with no received signal. Signals from T16 drive Q25 into base current on the positive R.F. driving cycle which pulls the collector negative because the emitter is returned to the -5 volt line. The negative potential on the collector of Q25 is applied to the AVC line through CR18 and to C171 through CR17. The rate that C162 is charged determines the AVC attack time. The AVC release time is determined by the rate that C171 discharges through R100 allowing C162 to discharge through CR15. The attack and release times for Q4 are lengthened by R22 and C70 to eliminate undesirable transients.

Large signals are kept from overloading Q4 by the application of a positive voltage on Pin 3, the signal gate. This voltage is derived from the S-meter and Q-18 and the delaying circuit of CR10, R47, R52, and C180. On AM, S14R shorts out CR10 to obtain a symmetrical attack and release response.

4.9.1 MUTING

Muting is accomplished by placing an open circuit at J9 which removes base current from Q26, lowering its collector voltage to -5 volts. The cathode of CR16 will also be at -5 volts causing it to conduct, applying cut-off voltage on the AVC line which turns off Q4, Q10, Q23, and Q24 and mutes the receiver.

4.10 S-METER

The S-meter is a voltmeter that measures the AVC voltage and is calibrated in "S" units. The source follower Q14, is connected to the AVC line and drives IC-1 which is a differential amplifier that operates the S-meter. The zero adjustment is affected by R64 and the S-meter full scale sensitivity is set by R73.

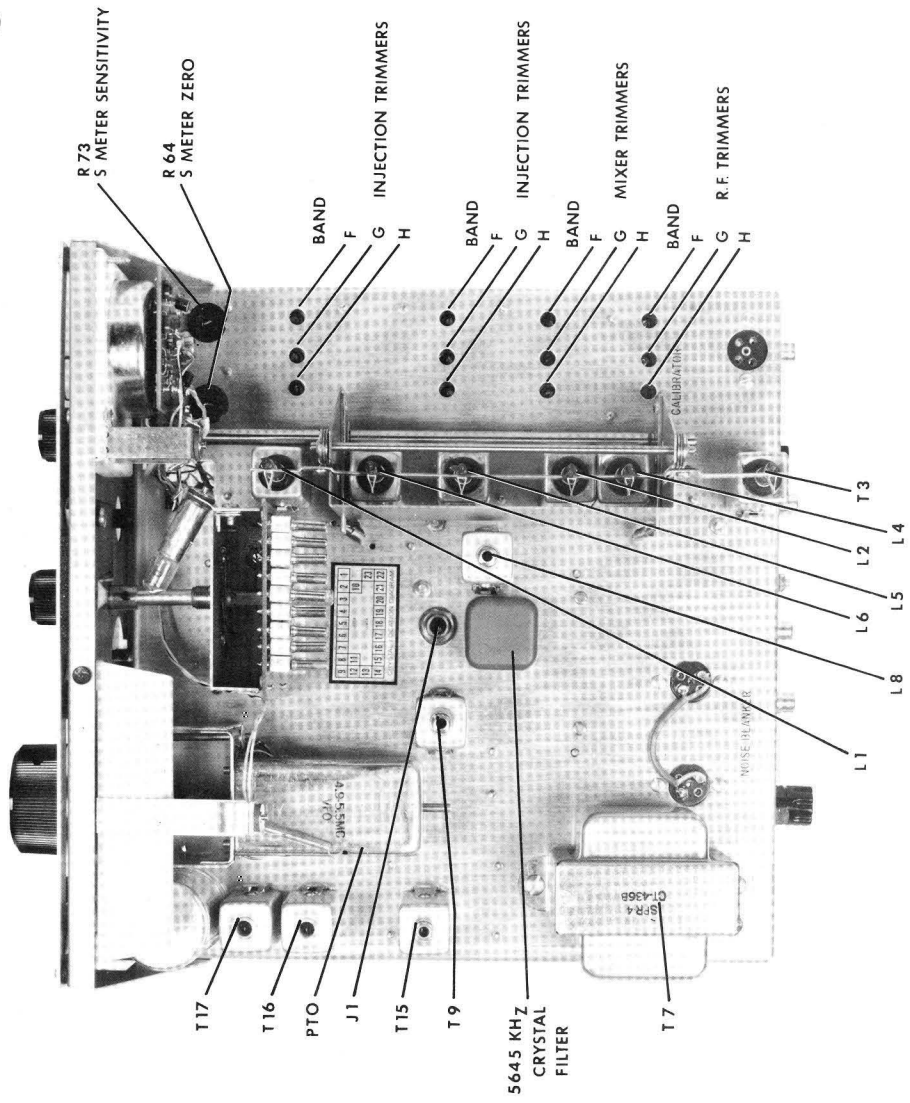

TOP ALIGNMENT ADJUSTMENT POINTS
Figure 5

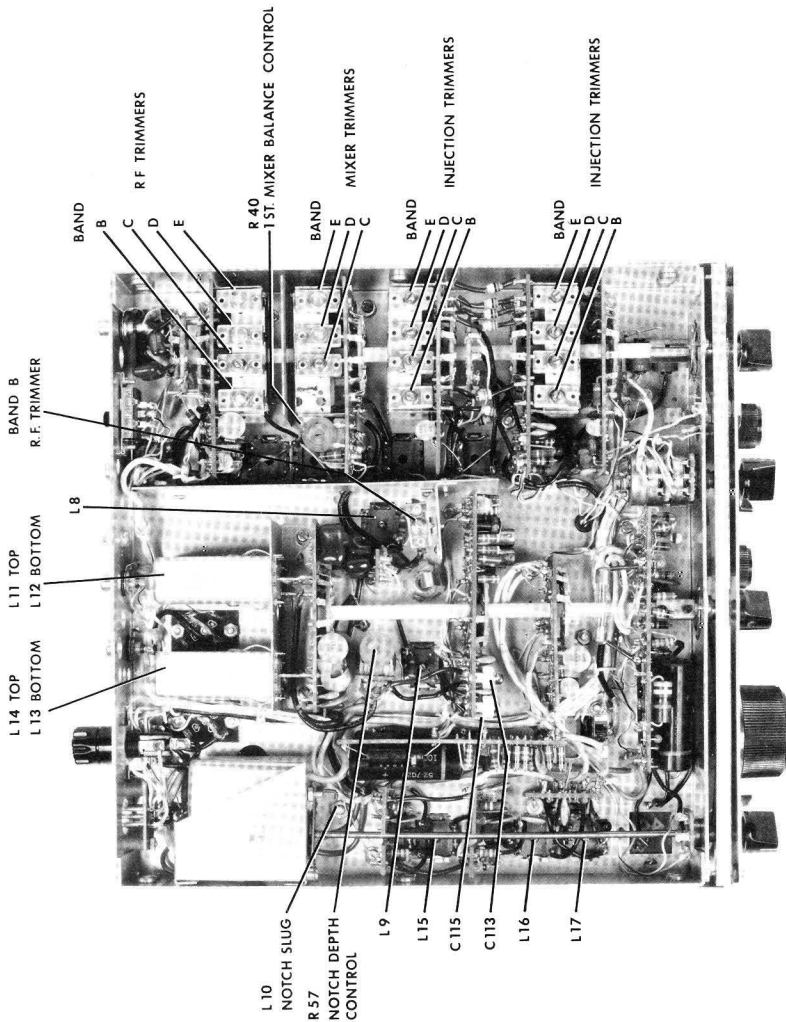

BOTTOM ALIGNMENT ADJUSTMENT POINTS
Figure 6

5 . ALIGNMENT

5.1 REMOVING COVERS

Remove the AL-4 Loop Antenna if it is in use. Remove the top three screws on each side of the SPR-4 and remove the top cover by pulling up on the rear and then on the front of the cabinet. Remove the remaining screws from the bottom cover and lift the SPR-4 from out of the bottom cover.

5.2 TROUBLE SHOOTING

Careful consideration has been given in the design of the SPR-4 to keeping maintenance problems to a minimum. If you experience difficulty we recommend that you return the unit to your Drake dealer or write direct to our Customer Service Department describing your problem in detail. Include full information concerning external connections, control settings, antenna used, serial number, etcetera.

DO NOT RETURN EQUIPMENT TO THE FACTORY WITHOUT PRIOR AUTHORIZATION!

The voltage and parts location charts which follow should be valuable in isolating service problems. However, no attempt should be made to service the SPR-4 unless you are thoroughly familiar with electronic circuitry and transistor and printed circuit servicing technique.

CARE SHOULD BE TAKEN NOT TO DISTURB THE LEAD DRESS IN THE SPR-4 SINCE THIS IS CRITICAL IN SEVERAL CIRCUITS.

5.3 ALIGNMENT INSTRUCTIONS

Alignment of the SPR-4 requires the use of the following equipment.

1. A stable R.F. signal generator with variable output that can be accurately set to any frequency in the range from 50 kHz to 30 MHz.
2. A voltmeter having an input impedance of 11 Megohms or greater, such as a VTVM.
3. The following accessory crystals:
 - 40.59 MHz for 29.5 - 30.0 MHz reception
 - 39.59 MHz for 28.5 - 29.0 MHz reception
 - 25.09 MHz for 14.0 - 14.5 MHz reception
 - 14.59 MHz for 3.5 - 4.0 MHz reception
 - 12.59 MHz for 1.5 - 2.0 MHz reception

4. An accessory crystal for reception of WWV standard frequency transmission that is most reliably received in your area. See Page 33 to determine crystal frequency required. This crystal is not required if SPR-4 does not have an SCC-4 Crystal Calibrator.
5. A 47 ohm 1/2 watt composition resistor connected across a phono plug to serve as an antenna load.
6. A scale with accurate 1/32 inch divisions.
7. An alignment tuning wand such as General Cement GC 8273 or Walsco 2516.

5.3.1 50 kHz I.F., B.F.O., and 50 kHz LC Filter Alignment

1. The settings of the range, preselector, crystal selector, and PTO controls are unimportant for this portion of the alignment. Set the audio gain at 12 o'clock, the RF gain fully clockwise, mode switch to LSB, notch to OFF, and accessory switch to NORM.
2. Connect a VTVM to the AVC line. This line is accessible at the terminal on the 1st I.F. board with the two white/green tracer wires attached.
3. Connect a 50.0 kHz unmodulated signal generator to Gate 1 (pin 3) of Q10 which is the terminal on T9, right side and closest to the front panel when looking into the bottom of the SPR-4 and front panel facing you.
4. Set the generator level so that slight AVC deflection (negative going) can be observed and adjust T17 for zero beat.
5. Adjust T15 and then T16 for maximum deflection of AVC voltage.
6. Set the signal generator to precisely 50.8 kHz and put the mode switch on CW and tune L11, L12, L13, and L14 for maximum AVC deflection. Repeat tuning L11 through L14 until no further improvement can be obtained.

5.3.2 5645 kHz I.F. Alignment

1. With the receiver set up as in 5.3.1, connect the signal generator to the junction of R27 and C90. This point is accessible at the ter-

minal on the R.F. amplifier board at the left top corner, looking into the bottom of the SPR-4 and front panel facing you. This terminal has coax connected to it. Care should be taken not to short this point to ground because Q4 will be ruined.

2. Preset the balance pot on the 1st mixer board fully clockwise.
3. Set the signal generator to 5645 kHz and adjust its level for a slight AVC deflection.
4. Place the mode switch in LSB and adjust C115, the outer trimmer capacitor on the mixer oscillator board for zero beat.
5. Place the mode switch in USB and adjust C113, the inner trimmer capacitor on the mixer oscillator board for zero beat.
6. Set the signal generator to 5650 kHz, the mode switch to LSB and adjust T8 and then T9 for maximum AVC.
7. Set the generator to 5645 kHz and adjust the mixer balance pot for minimum AVC deflection (most positive going).

5.3.3 PRESELECTOR AND INJECTION ALIGNMENT

1. The settings of the range, preselector, crystal selector, and PTO will be indicated before each adjustment. Set the audio gain at 12 o'clock, the RF gain fully clockwise, mode switch to LSB, notch to OFF, and accessory switch to NORM.
2. Install the accessory crystals listed at 5.3, 3 on Page 19. Plug the 47 ohm resistor into the antenna jack, J2.
3. Turn the preselector control fully clockwise and check the shield cans marked T1, T2, T3, T4, T5, and T6 for proper slug engagement. The distance from the top of the slugs to the top of the white coil forms should be $9/16"$. T2 and T4 may differ from this figure by $1/32"$ on receivers from the factory. These slugs may be left alone for "Touch up" alignment. For complete alignment, set all slugs to $9/16"$. Turn the preselector control fully counterclockwise and set the pointer on zero.
4. Tune in the calibrator signal or an unmodulated signal generator loosely coupled to the 47 ohm antenna load at 30.0 MHz (range switch on H with 40.59 MHz crystal, dial on 500.) Rough tune all H band trimmers for maximum S-meter reading and/or maximum AVC deflection.
5. Tune in the calibrator or a signal generator at 28.7 MHz and repeak the preselector for maximum AVC deflection. Tune the H band R.F.

and mixer trimmers for maximum AVC deflection. Detune T6 by grasping a metal screwdriver shaft and touching it to the rotor contact of S4R, and tune the rear H band injection trimmer for maximum AVC deflection. Detune T1 by touching the rotor contact of S8F and tune the front H band injection trimmer for maximum AVC deflection.

6. Tune the G through C bands with the following set-up, tuning the R.F. and mixer trimmers first, followed by the injection trimmers taking care to use the loading techniques described in 5 (above). The identification and location of the trimmers can be found in Figure and Figure

<u>BAND</u>	<u>Calibrator or Signal Generator Frequency in MHz.</u>	<u>Preselector Setting</u>
G	21.5	9.0
F	14.0	7.5
E	6.0	4.0
D	3.8	R.F. slug tops flush with white coil form
C	1.9	R.F. slug tops flush with white coil form

7. BANDS A and B ALIGNMENT

Remove the 47 ohm antenna load and tune in the calibrator or a signal generator at 300 kHz on Band A and set the preselector to exactly 6 on its scale. If a signal generator is used, a 10 pf coupling capacitor should connect the generator to the antenna jack. Adjust the slugs of shield cans T2 and T4 for maximum AVC deflection.

On Band B tune in the calibrator or signal generator at 1600 kHz and turn the preselector control fully clockwise and rough tune all B band trimmers for maximum AVC deflection. Retune to 1400 kHz and carefully peak the signal with the preselector control. Tune the B band R.F., mixer, and injection trimmers (properly loaded) for maximum AVC deflection. The accessory crystals used especially for alignment may now be removed.

5.3.4 NOTCH FILTER ALIGNMENT

Tune in the calibrator or signal generator on LSB for a zero beat and set the notch knob to 3 o'clock. The notch slug should be as far into the coil as it will go without engaging the stop. If it isn't, rotate the notch knob to its OFF detent, loosen the notch knob setscrew and tighten it in the OFF position. Return the knob to the 3 o'clock position and adjust the notch slug for maximum AVC voltage (positive going). Switch to AM, set

the notch control at 12 o'clock and adjust the main tuning knob for maximum AVC voltage (positive going). Alternately adjust the notch control and the notch depth control, R57, for maximum AVC voltage (positive going).

5.3.5 S-METER ADJUSTMENT

Tune in a 10,000 microvolt signal on 7.2 MHz LSB and looking into the top of the chassis with the front panel facing you, adjust R73, the left control on the S-meter circuit board for + 4.5 volts on the middle top terminal of the meter board and has a white/black tracer wire connected to it. Remove the 10,000 microvolt signal and adjust R64, the right control for meter zero. Because these controls interact slightly, repeat the above procedure until no further interaction occurs.

6. ACCESSORIES

6.1 MODEL SCC-4 CRYSTAL CALIBRATOR

6.1.1 GENERAL DESCRIPTION

The SCC-4 is a 100 kHz crystal controlled oscillator that injects into the receiver a harmonic every 100 kHz throughout the SPR-4 frequency coverage.

6.1.2 INSTALLATION

Remove the top row of 3 screws on each side of the SPR-4 cabinet. Disconnect the power cord, internal speaker cable and remove cabinet top. Install the SCC-4 by inserting it into the socket marked CALIBRATOR at the left rear of the SPR-4 chassis. Replace the cabinet top, power cord, and speaker cable.

6.1.3 OPERATION

The calibrator is switched on by placing the accessories switch on the front panel in the CAL position.

6.1.4 CIRCUIT DESCRIPTION

Transistor Q2 and the 100 kHz crystal form the oscillator which drives the harmonic amplifier Q1. Harmonics of 100 kHz are generated by the wave shaping diode CR1. The amplified 100 kHz harmonics are coupled to the SPR-4 antenna input through C2.

6.1.5 SERVICE DATA

A voltage chart, schematic and a circuit board layout, Figure 7 are provided for servicing the SCC-4.

6.1.6 ALIGNMENT

The SCC-4 is factory aligned, but due to shock and vibration during shipment, or normal long term drift, adjustment is sometimes necessary. Turn on the receiver and the calibrator and allow it to warm up for at least 30 minutes. Tune in a standard frequency station such as WWV. Carefully adjust the ceramic trimmer capacitor located on top of the calibrator circuit board for zero beat. This completes all necessary alignment.

6.2 MODEL 5-NB NOISE BLANKER

6.2.1 GENERAL DESCRIPTION

The 5-NB is a solid state noise blanker for use with the SPR-4 Receiver. The 5-NB works by muting the receiver for the duration of the noise

pulse. Between noise pulses, full receiver gain is restored. Receiver AVC is affected only by the desired signal and not by noise when the 5-NB is in use. The 5-NB is most effective on strong, periodic impulse noise such as ignition noise.

6.2.2 INSTALLATION

To install the 5-NB, remove the top row of three screws on each side of the SPR-4 Receiver cabinet. Disconnect the power cord, the internal speaker cable and remove the cabinet top. Unplug the jumper cable from the two sockets near the power transformer and marked noise blanker. Retain the jumper cable so that it may be used if the 5-NB should ever require service. Install the 5-NB by plugging it into the two sockets on top of the SPR-4 chassis. Be sure that the 5-NB is seated in the sockets and do not disturb any components on the 5-NB circuit board. Replace the cabinet top, power cord, and speaker cable.

6.2.3 OPERATION

The 5-NB is controlled by the SPR-4 accessory switch. When the accessory switch is in NB position, the 5-NB is turned on. The accessory switch may be left in the NB position for full time protection against noise interference. Some distortion may be noted when using the 5-NB on extremely strong signals.

6.2.4 CIRCUIT DESCRIPTION

Signals at the I.F. frequency from the 1st mixer in the SPR-4 pass through the two pole crystal filter in the 5-NB and are amplified by Q4. The signal on the collector of Q4 is coupled to Q9 and Q10 through T2, C27, T3 and C33 where it is amplified further and passes through T4 to the series gate CR1, CR2 and into the SPR-4 I.F. through T5. The I.F. signal on the emitter of Q4 is coupled through C16 to Q1 which drives the balanced mixer, Q5 and Q6. The balanced mixer subtracts the I.F. signal from the crystal oscillator Q3 and the difference frequency is coupled to Q7 through T7 and C23. Transistors Q7 and Q8 amplify the mixer output. The collector of Q8 drives the pulse detector, Q15 and the AGC amplifiers, Q11, Q13 and Q14. Q14 drives Q2 and Q16 which control the gain of Q1 and Q7 respectively. The AGC system maintains the amplitude of the signals at the collector of Q8 so that the pulse detector, Q15, remains cut-off for normal radio communication signals. When transistor Q15 is cut-off, Q12 conducts and applies a positive potential to the center tap of the secondary winding of T4 which is greater than the + 1 volt applied to the center tap of T5 primary maintaining the series gate in the "on" state. With the series gate "on", radio signals pass through the 5-NB unaffected. Noise impulses larger than the average communication signal will turn on Q15 for the duration of the impulse. This turns off Q12 for the same duration causing the series gate to be

reverse biased and turned "off". With the series gate "off", the signal path through the 5-NB is broken and reception is blanked for the duration of the interfering noise pulse. The 5-NB is turned on by the accessory switch in the SPR-4 which removes the ground from Pin 1 of P-5 and allows Q3 in the 5-NB to oscillate permitting signals to mix in the 5-NB balanced mixer and eventually operates the series gate.

6.2.5 SERVICE DATA

A voltage chart, schematic, and a circuit board layout, Figure 10 are provided for servicing the 5-NB.

6.2.6 ALIGNMENT

The 5-NB requires no alignment at the time of installation. However, should alignment ever become necessary, the following procedure should be used.

Connect a VTVM at 15 volts full scale between the chassis and R46 of the 5-NB (see Figure 10). Tune the SPR-4 to 21.9 MHz while using a signal generator as a signal source. With the 5-NB turned off, adjust C-21, C-26, and C-28 for maximum S-meter reading. It may be necessary to touch up the adjustment of C-21 for the best AM passband as indicated by the S-meter. With the accessory switch in NB position, and the signal source turned off, adjust R-19 for maximum positive voltage on R-46. With the signal source turned on, adjust C-7 and C-18 for minimum voltage on R-46. Tune the SPR-4 to 21.5 MHz while using the 21.5 MHz crystal. With the signal generator turned off, adjust the spacing between C12 and C49 for maximum voltage on R-46. With the signal generator turned on, and still on 21.9 MHz, adjust R-38 so that the S-meter has the same reading with the 5-NB installed as it does with the jumper cable installed.

6.3 MODEL RY-4 RADIO TELETYPE ADAPTOR

6.3.1 GENERAL DESCRIPTION

The RY-4 Radioteletype Adaptor allows the 50 kHz BFO in the SPR-4 to be remotely switched so that standard shift RTTY tones may be centered in the passband of the 50 kHz I.F. filter. The switching is performed by an external circuit which must short the RTTY jack to ground.

When the mode switch is in the CW position and the RTTY jack grounded, the BFO frequency will be switched to 48.590 kHz so that standard 2125 and 2295 Hz tones may be received.

When the mode switch is in the LSB position and the RTTY jack grounded, the BFO frequency will be shifted to 49.350 kHz so that standard 2125 and 2975 Hz tones may be received.

When the mode switch is in the AM or USB position, shorting the RTTY jack will have no effect.

6.3.2 INSTALLATION

This modification should be made by a competent technician. If you need help or want the RY-4 to be installed by one of our factory authorized service centers or by the factory service technicians, please call or write our Customer Service Department.

Disconnect the speaker cable, the line cord, and remove the SPR-4 cabinet. Mount the circuit board in the location shown in Figure 12 using a No. 4 sheet metal screw with a No. 4 lockwasher between the screw-head and the mounting foot. Some early SPR-4 Receivers may not have the hole in the chassis. In this case, mount the circuit board foot under the No. 6 nut on the PTO spade bolt as shown in Figure 12.

Mount the phono jack (with nut, lockwasher and ground lug on the inside of the chassis) in the hole next to the grounding screw on the rear apron of the chassis. Connect the .01 disc capacitor between the phono jack and the ground lug. Solder only the ground lug. Connect the 3 wires between the terminals on the RY-4 circuit board and the terminals on the BFO board as shown in Figure 13. Use bare wire and sleeving. DO NOT use any more heat than necessary when soldering the terminals as the circuit boards may be damaged.

Connect the 3 color coded wires between the RY-4 circuit board terminals and switch S-14R as shown in Figure 13. Connect the white/yellow wire from the RY-4 circuit board to the installed phono connector. Dress this wire along the wiring harness. Solder all connections.

The BFO transformer T-17, must be adjusted for 50 kHz. Place the mode switch in the USB position and the RF gain control fully clockwise. The position of the crystal selector, range switch, and preselector is unimportant. Connect a clip lead with a series blocking capacitor of 1000 pf between the terminal on T-15 and the 10 K resistor of the SCC-4 crystal calibrator. See Figure 8 and Figure 12. Adjust the slug in T-17 for zero beat. Remove the clip lead and replace the cabinet, If an SCC-4 is not available, follow the B.F.O. alignment in "5.3.1" and make certain the RTTY jack on the rear of the SPR-4 is not connected to ground.

6.3.3 OPERATION

Reception of standard shift (850 Hz) RTTY signals is accomplished by placing the mode switch in LSE position and shorting the RTTY jack with an external switch provided by the user. Reception of narrow shift (170 Hz) RTTY signals is accomplished by placing the mode switch in CW position and shorting the RTTY jack with an external switch.

6.3.4 CIRCUIT DESCRIPTION

The BFO is shifted in frequency for RTTY reception by shunting a capacitor across T17 with an electronic switch. Transistor Q2 electronically switches C2 across T17, and Q3 switches C3. Switch S14R connects the collector of Q1 to the base of Q3 in CW and to the base of Q2 in LSB. If J1 (RTTY jack) is shorted, Q1 conducts and turns on either Q2 in LSB or Q3 in CW, allowing reception of RTTY signals.

6.3.5 SERVICE DATA

A voltage chart, schematic and a circuit board layout, Figure 14 are provided for servicing the RY-4.

6.3.6 ALIGNMENT

Place the mode switch in the USB position and the RF gain control fully clockwise. The position of the crystal selector, range switch and pre-selector is unimportant. Connect a clip lead with a series blocking capacitor of 1000 pf between the terminal on T15 and the 10 K resistor of the SCC-4 crystal calibrator. See Figure 8 and Figure 12. Adjust the slug in T-17 for zero beat. Remove the clip lead and replace the cabinet. If an SCC-4 is not available, follow the BFO alignment in "5.3.1" and make certain the RTTY jack on the rear of the SPR-4 is not connected to ground.

6.4 MODEL TA-4 TRANSCEIVE ADAPTOR

6.4.1 GENERAL DESCRIPTION

The TA-4 Transceive Adaptor allows the SPR-4 to transceive with the T-4/T-4B/T-4X/T-4XB Drake Transmitters.

6.4.2 INSTALLATION

This modification should be made by a competent technician. If you need help or want the TA-4 to be installed by one of our factory authorized service centers or by the factory service technicians, please call or write our Customer Service Department.

Disconnect the speaker cable and the line cord and remove the SPR-4 cabinet. Mount the TA-4 circuit board with two number 4 sheet metal screws and two lockwashers (with the lockwashers between the screw-heads and the mounting feet) in the chassis holes as shown in Figure 16.

Connect the five color coded TA-4 circuit board wires by pushing the connectors at the end of each wire onto the appropriate mating pins in the SPR-4 until they are fully seated. See Figure 17 for the location of the

pins. Late SPR-4's have a 12 K 1/2 watt resistor between T-6 and the pre-mixer board. Cut the resistor lead from T-6 and remove the resistor. Route the coax cable along the wiring harness and install the phono fitting on the end of the cable in the large hole near the center of rear chassis apron as shown in Figure 17. The nut and the flat washer should be on the outside of the chassis.

Remove the SPR-4 S-meter lamp bracket by squeezing the sides of the bracket. Remove the lamp bracket from the crystal selector frame by removing the mounting screw. Locate the audio transformer mounting feet over the two holes in the top of the chassis which are in front of the crystal selector. The black transformer lead should be facing the front panel. Mount the audio transformer by inserting number six screws through the chassis holes from the bottom and into the speed nuts on the transformer. Route the two transformer leads through the rectangular chassis hole. Push the pin on the black wire into the clip on the headphone jack. Some early SPR-4 Receivers do not have this clip. In this case, solder the black wire to the headphone terminal closest to the RF and audio gain controls. Route the red wire along the wiring harness to the rear of the chassis and mount the phono fitting in the 3/8 inch hole directly below the speaker jack. Some early SPR-4 Receivers may have a 1/4 inch hole in this location. In this case, enlarge the 1/4 inch hole to 3/8 inch. Replace both lamp brackets.

It will be necessary to adjust the injection trimmers after the TA-4 installation. See "5.3, Paragraph 3" for the required accessory crystals for tuning the injection trimmers. Tune in the signals in the chart below from a signal generator or the crystal calibrator and peak the preselector for maximum S-meter reading. Detune T6 by grasping a metal screwdriver shaft and touching it to the rotor contact of S4R and tune the rear most injection trimmer for the band under alignment for maximum AVC deflection or S-meter reading. Detune T1 by touching the rotor contact of S8F and tune the front injection trimmer for maximum AVC deflection or S-meter reading.

<u>BAND</u>	<u>FREQUENCY IN MHz</u>
H	28.7 MHz
G	21.5
F	14.0
E	6.0
D	3.8
C	1.9
B	1.6

6.4.3 OPERATION

The TA-4 is activated by circuits in the Drake T-4/T-4B/T-4X/T-4XB Transmitters, therefore operation of the TA-4 is performed at the transceive switch on these transmitters.

6.4.4 CIRCUIT DESCRIPTION

The transceive switch on the T-4/T-4B/T-4X/T-4XB Transmitter controls the TA-4 by applying a negative or positive D.C. potential to the injection cable. When the transceive switch on the transmitter is in SPOT position, no D.C. potential is applied to the injection cable and the injection cable is not utilized. In SEPARATE position, the injection line is connected to the mute jack through a 68 K resistor. The mute jack in the SPR-4 becomes positive under open circuit (receiver muted) condition which supplies base current through R6, CR2 and CR3 to Q2 and turns it on. Whenever, Q2 is on, Q1, Q3 and Q4 are also conducting. The collector current in Q4 drops the gate voltage on the SPR-4 premixer transistor Q5 and cuts it off which eliminates the possibility of the SPR-4 injection frequency from getting into the transmitter and causing a spurious signal.

In RCVR position, the cathode of the premixer tube, V8, in the T-4/T-4B/T-4X/T-4XB Transmitter is connected directly to the injection line which makes it positive, but not enough to cause CR2 to conduct preventing Q4 from disabling the SPR-4 premixer.

T-6 in the SPR-4, drives Q5, an emitter follower, through C5 and R-12 in the TA-4. The output of Q5 drives the injection jack through C7 which allows the T-4XB to transceive on the SPR-4 dial frequency.

In XMTR position, the injection line is made negative which turns on Q1, Q3 and Q4. Collector current in Q4 drops the gate voltage on the SPR-4 premixer transistor Q5 and cuts it off. The injection frequency signal from the transmitter drives the center tap on the link of T6 through Q1 which is used as a switching diode.

T1 in the TA-4, is an audio transformer which matches the SPR-4 audio output impedance to the anti-vox circuit in the transmitter.

6.4.5 SERVICE DATA

A voltage chart, schematic, and circuit board layout, Figure 18 are provided for servicing the TA-4.

6.4.6 ALIGNMENT

The carrier oscillator in the T-4XB must be adjusted so that the SPR-4 and the T-4XB will transceive. Both SPR-4 carrier oscillators must be on frequency. The SPR-4 oscillators are set at the factory and should not require any adjustment. If the SPR-4 alignment is under suspicion, perform the 50 kHz IF and 5645 kHz IF alignment described in 5.3.1 and 5.3.2.

<u>CONTROL OR SWITCH</u>	<u>SPR-4</u>	<u>T-4XB</u>
Band or Range switch	D	3.5
Crystal switch	3.5	---
Function	---	SSB
Mode	LSB	---
Audio Gain	3 o'clock	---
Transceive	---	Spot
Anti-Vox	---	Full clockwise
Sideband	---	Lower
Preselector	Both the SPR-4 and T-4XB preselectors should be set to about 6.5 and peaked for the loudest "canary" sound from the speaker.	

Adjust C-2 in the T-4XB until the "canary" sound slows down to only a few chirps a second and then zero chirp a second and all that is heard is a single tone.

6.5 AVC ALTERATIONS

6.5.1 GENERAL DESCRIPTION

It is possible to alter the SPR-4 AVC system by simple connections to two circuit boards. These alterations allow the gain to be controlled manually with the RF GAIN control and allow fast AVC on CW only instead of the supplied slow AVC response.

6.5.2 FAST AVC ALTERATION

Fast AVC can be obtained on CW for SPR-4's with serial numbers above 1000, by placing a jumper wire between the two terminals at the center of the 2nd mixer board. One terminal has a white/yellow wire connected to it and the other terminal is unused. A resistor placed between these terminals will allow an AVC response between fast and slow. A 6.8 megohm resistor will halve the AVC response time.

6.5.3 AVC OFF ALTERATION

The AVC may be remotely turned off in SPR-4's with serial numbers above 1,000. This is obtained by altering connections to two terminals on the power supply board. One of these two terminals has two white/blue wires attached. Cut the jumper from these two terminals and connect an external SPST switch across these terminals for AVC OFF operation.

SPR-4 ACCESSORY CRYSTAL CHART

OPERATING FREQ. in MHz.	CRYSTAL FREQ. in MHz.	OPERATING FREQ. in MHz.	CRYSTAL FREQ. in MHz.
.15 - .5*	None Required.	15.0 - 15.5*	26.09
.5 - 1.0*	11.59	15.5 - 16.0	26.59
1.0 - 1.5*	12.09	16.0 - 16.5	27.09
1.5 - 2.0	12.59	16.5 - 17.0	27.59
2.0 - 2.5	13.09	17.0 - 17.5	28.09
2.5 - 3.0	13.59	17.5 - 18.0*	28.59
3.0 - 3.5	14.09	18.0 - 18.5	29.09
3.5 - 4.0	14.59	18.5 - 19.0	29.59
4.0 - 4.5	15.09	19.0 - 19.5	30.09
4.5 - 5.0	15.59	19.5 - 20.0	30.59
5.0 - 5.5	16.09	20.0 - 20.5	31.09
5.5 - 6.0	16.59	20.5 - 21.0	31.59
6.0 - 6.5*	17.09	21.0 - 21.5	32.09
6.5 - 7.0	17.59	21.5 - 22.0*	32.59
7.0 - 7.5*	18.09	22.0 - 22.5	33.09
7.5 - 8.0	18.59	22.5 - 23.0	33.59
8.0 - 8.5	19.09	23.0 - 23.5	34.09
8.5 - 9.0	19.59	23.5 - 24.0	34.59
9.0 - 9.5	20.09	24.0 - 24.5	35.09
9.5 - 10.0*	20.59	24.5 - 25.0	35.59
10.0 - 10.5	21.09	25.0 - 25.5	36.09
10.5 - 11.0	21.59	25.5 - 26.0	36.59
11.0 - 11.5	22.09	26.0 - 26.5	37.09
11.5 - 12.0*	22.59	26.5 - 27.0	37.59
12.0 - 12.5	23.09	27.0 - 27.5	38.09
12.5 - 13.0	23.59	27.5 - 28.0	38.59
13.0 - 13.5	24.09	28.0 - 28.5	39.09
13.5 - 14.0	24.59	28.5 - 29.0	39.59
14.0 - 14.5	25.09	29.0 - 29.5	40.09
14.5 - 15.0	25.59	29.5 - 30.0	40.59

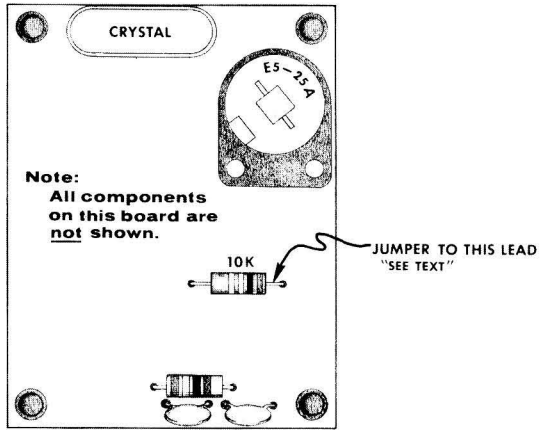

RY-4 CALIBRATION CONNECTION TO SPR-4

Figure 8

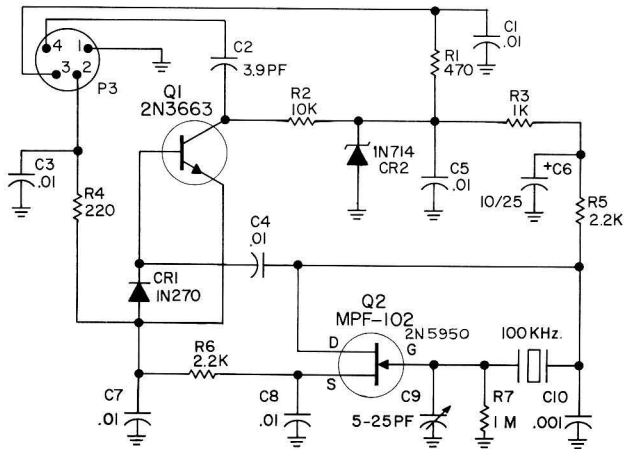

SCC-4

SCC-4 SCHEMATIC DIAGRAM

Figure 9

5-NB D.C. AND R.F. VOLTAGE CHART

Transistor	Drain Collector	Source Emitter	Gate 1 Base
Q1	12.1 (31)	2.7	3.4 (4)
Q2	2.6	2.4	3.0
Q3	8.5 (3.4 V)	3.4	3.0
Q4	3.1 (9.4)	1.8 (6.4)	2.5 (3.8)
Q5	12.3 (57)	1.0	0.0 (480)
Q6	12.3 (57)	1.4	0.0 (480)
Q7	9.6 (12.5)	2.7	3.4 (12)
Q8	9.3 (290)	2.7	3.4
Q9	9.0	1.25	1.8 (8)
Q10	11.5	8.2 (21)	8.8
Q11	4.4 (650)	0.0	0.2
Q12	11.8	5.5	6.1
Q13	12.3	3.85	4.3
Q14	12.3	3.3	3.8
Q15	6.2	0.0	0.0
Q16	2.7	2.4	3.4

MEASUREMENT CONDITIONS

Conditions same as the SPR-4 R. F. voltage chart with the accessory switch in NB position.

11 megohm VTVM and Boonton Model 91CA R.F. voltmeter used.

100:1 divider used on measurements above 500 mV.

Measurements in parenthesis are R.F. voltages.

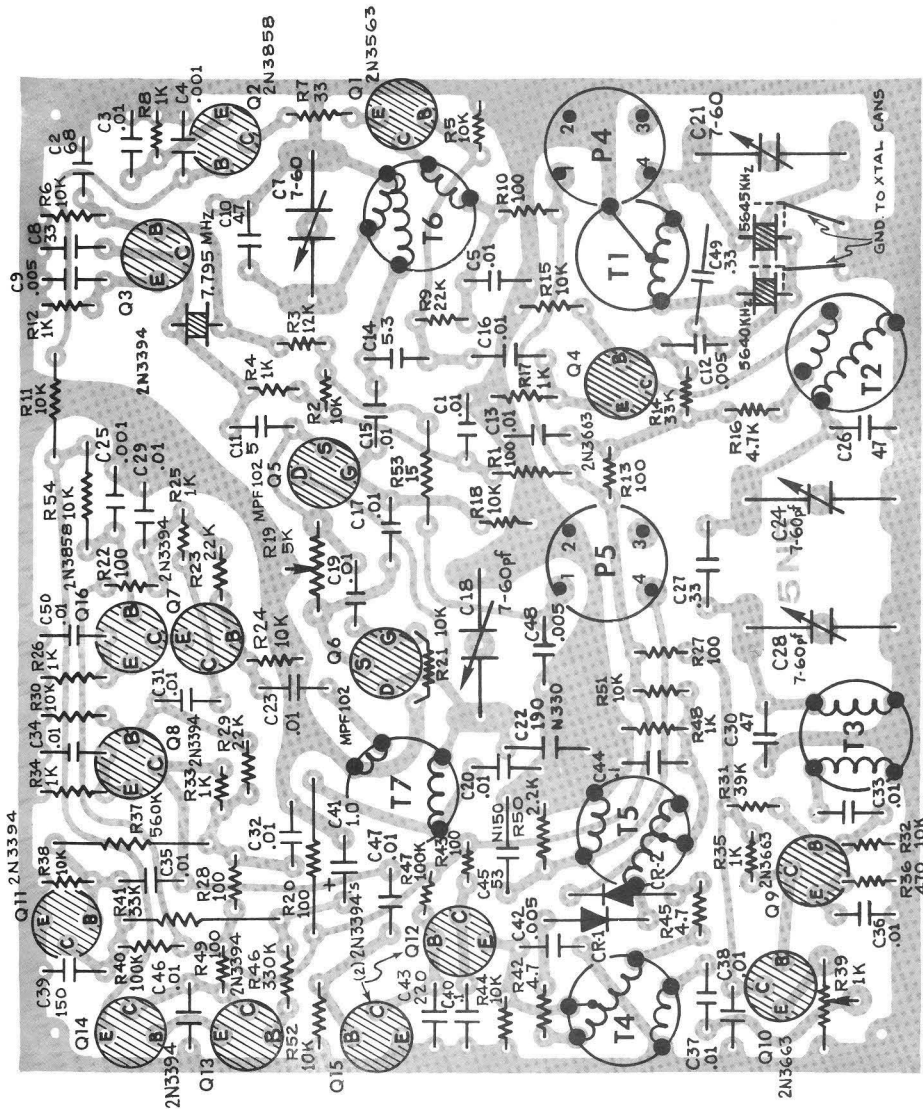

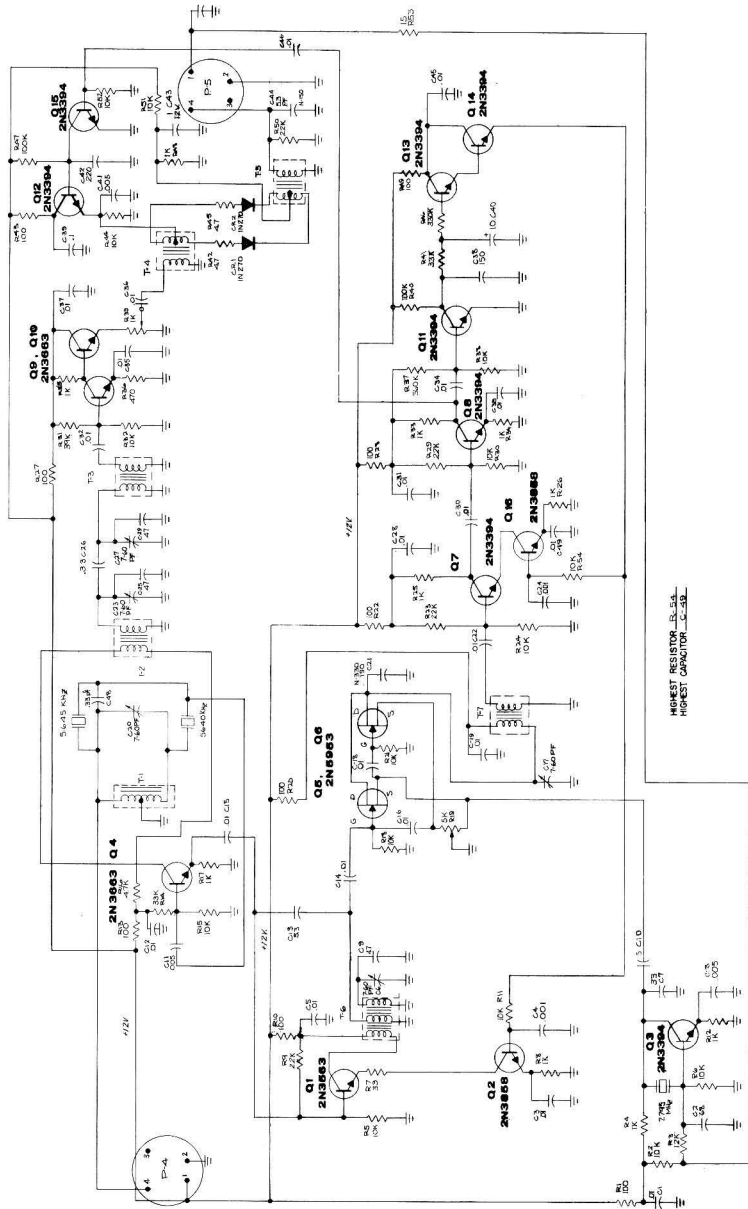

5-NB SCHEMATIC DIAGRAM
Figure 11

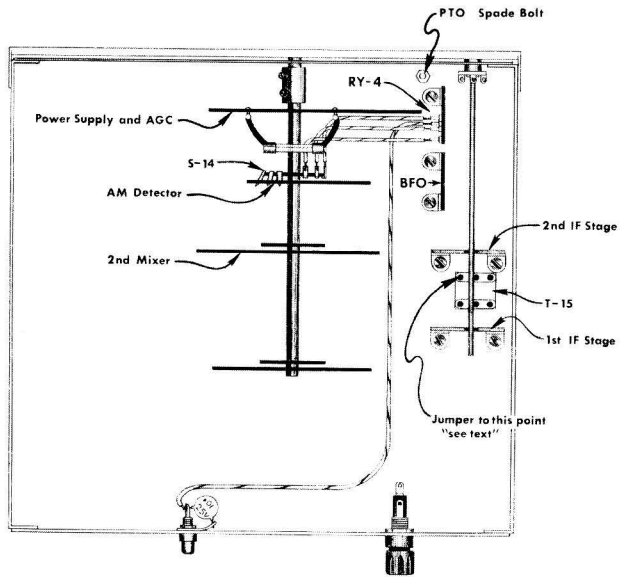

RY-4 CIRCUIT BOARD INSTALLATION DIAGRAM
Figure 12

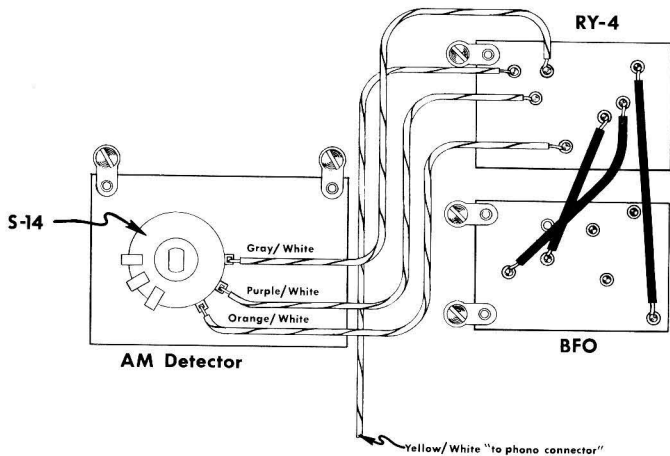

RY-4 PICTORIAL WIRING DIAGRAM
Figure 13

<u>Transistor</u>	<u>Collector</u>	<u>Emitter</u>	<u>Base</u>
Q1, CW	- 1.4	8.8	8.7
Q1, LSB	- 1.1	8.8	8.7
Q2, CW	29	2.2	-.3
Q2, LSB	30	2.2	-.3
Q3, CW	33	2.2	-.5
Q3, LSB	33	2.2	-.5

MEASUREMENT CONDITIONS

Conditions same as the SPR-4 R.F. voltage chart.
 RY jack shorted to ground.
 11 megohm VTVM used.

RY-4 D.C. VOLTAGE CHART

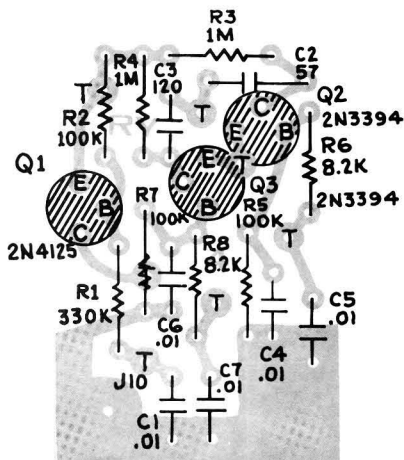

RY-4 CIRCUIT BOARD

Figure 14

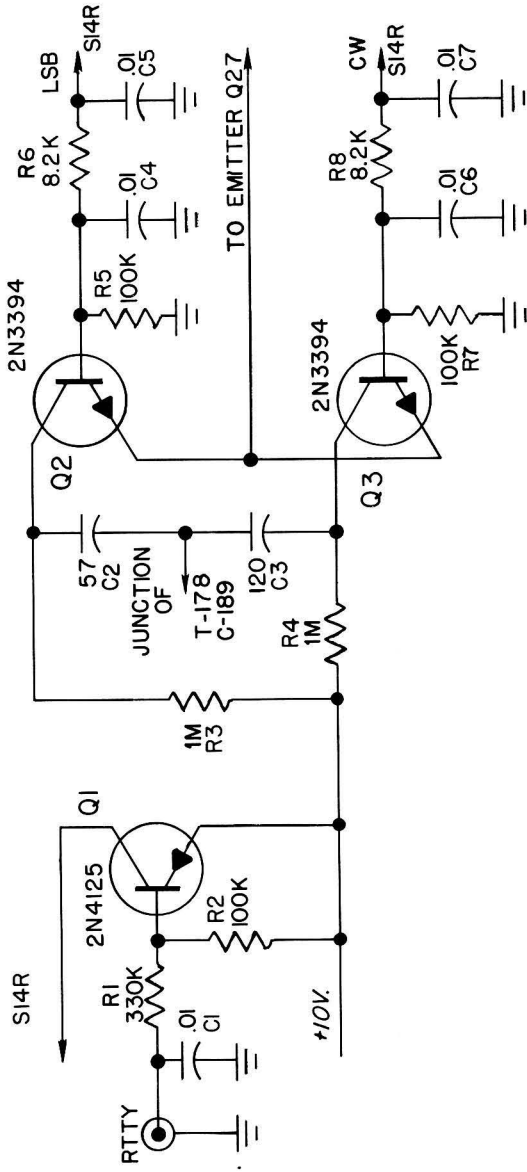

RY-4 SCHEMATIC DIAGRAM

Figure 15

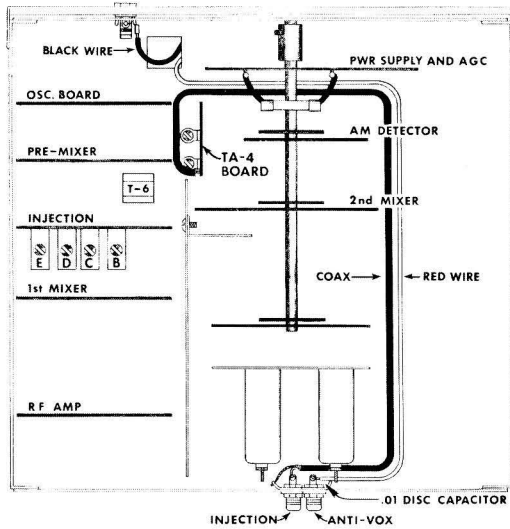

TA-4 CIRCUIT BOARD INSTALLATION DIAGRAM

Figure 16

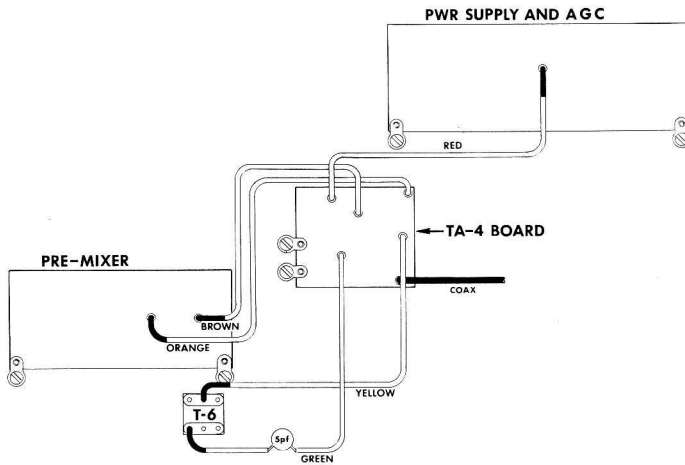

TA-4 PICTORIAL WIRING DIAGRAM

Figure 17

TA-4 D.C. VOLTAGE CHART

Transistor	Transceiver Mode	Collector	Emitter	Base
Q1	Separate	-----	0.0	0.7
Q1	Transmitter	-----	0.0	0.7
Q2	Separate	0.05	0.0	0.6
Q2	Transmitter	11.1	0.0	0.0
Q3	Separate	12.2	12.2	11.5
Q3	Transmitter	0.02	11.9	10.6
Q4	Separate	0.0	0.0	0.6
Q4	Transmitter	0.02	0.0	0.6
Q5	Separate	12.2	0.0	0.01
Q5	Transmitter	12.0	2.3	3.0

MEASUREMENT CONDITIONS

Conditions same as the SPR-4 R.F. voltage chart and including inter-connection with a T4XB.

Measurements taken in SEPARATE mode were with T-4XB transmitting.

11 megohm VTVM used.

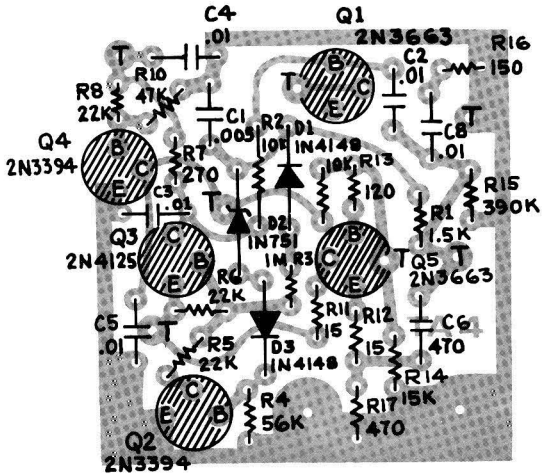

TA-4 CIRCUIT BOARD

Figure 18

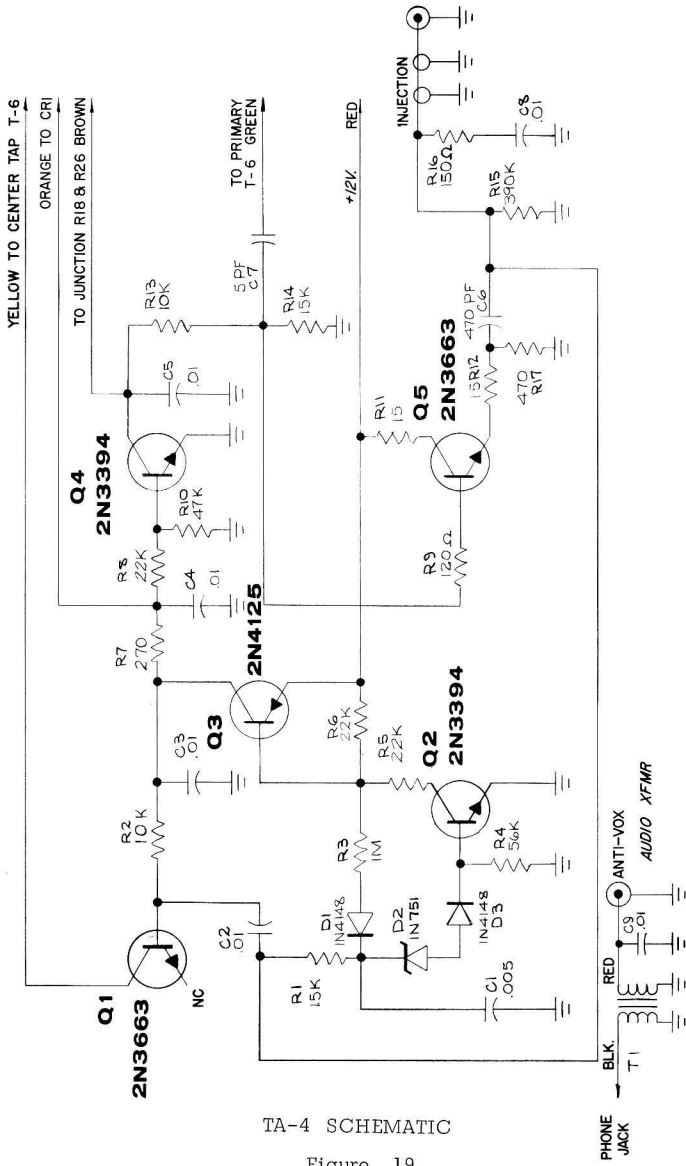

TA-4 SCHEMATIC

Figure 19

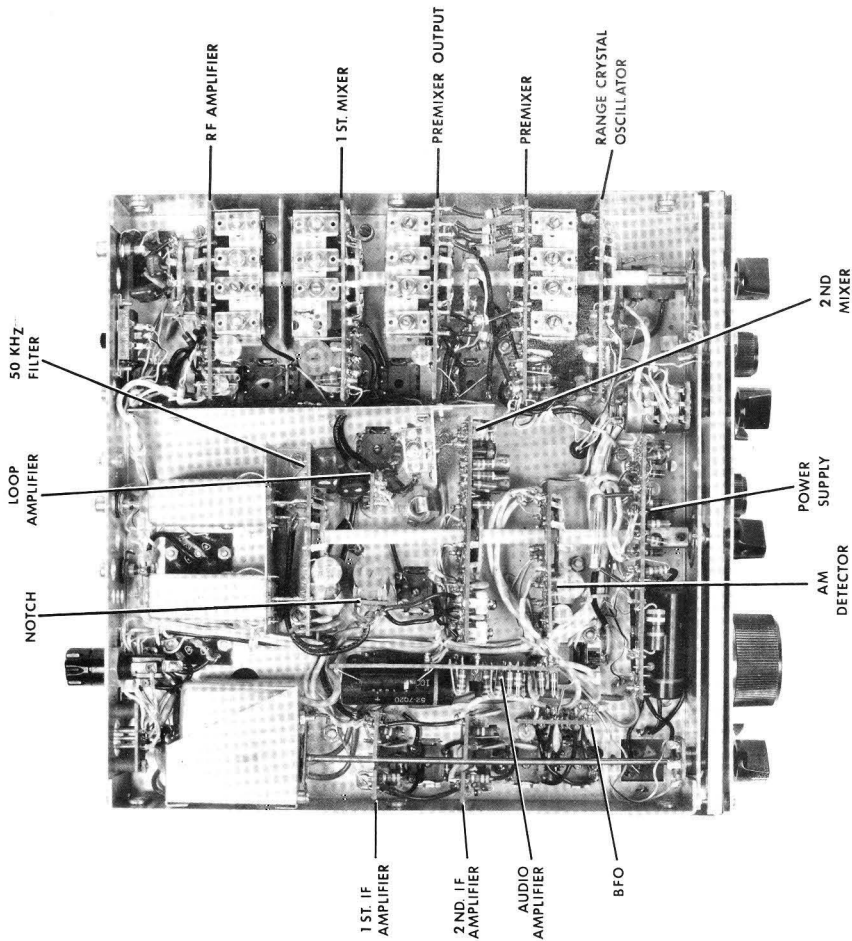

BOTTOM VIEW
 CIRCUIT BOARD LOCATIONS
 Figure 20

SPR-4 D.C. VOLTAGE CHART

Transistor	Drain Collector	Source Emitter	Gate 1 Base	Gate 2
Q1	7.3	.1	.8	-----
Q2	9.0	4.3	3.9	-----
Q3	PTO	-----	-----	-----
Q4	9.7	.3	1.3	.35
Q5	9.8	.8	0.0	.90
Q6	PTO	-----	-----	-----
Q7	10.2	3.0	0.0	-----
Q8	10.2	2.8	0.0	-----
Q9	17.0	12.7	13.2	-----
Q10	11.8	.25	0.0	.30
Q11	6.3	1.8	0.0	-----
Q12	12.2	6.0	6.5	-----
Q13	6.0	0.0	0.5	-----
Q14	6.0	4.0	0.4	-----
Q15	12.2	6.5	7.0	-----
Q16	0.5	6.0	5.4	-----
Q17	10.0	3.9	2.8	-----
Q18	1.7	11.0	10.5	-----
Q19	7.0	5.4	5.9	-----
Q20	5.4	0.0	0.5	-----
Q21	5.5	0.3	-0.1	-----
Q22	8.8	0.15	0.65	-----
Q23	11.2	0.15	0.0	.35
Q24	11.6	0.3	0.0	.35
Q25	1.6	-4.7	-4.6	-----
Q26	4.6	4.6	4.0	-----
Q27	8.6	2.5	3.0	-----
Q28	4.8*	0.2*	0.8*	-----

MEASUREMENT CONDITIONS

Conditions are the same as the SPR-4 R.F. voltage chart.
11 megohm VTVM used.

*Mode switch in AM for these measurement.

SPR-4 R.F. VOLTAGE CHART

Transistor	Function	Drain Collector	Gate 1	Gate 2	Source
Q1	Loop Amp	131*			
Q4	RF Amp	16			
Q7, Q8	1st Mixer	215**			
Q10	2nd Mixer	900**			
Q23	1st IF Amp	310			
Q24	2nd IF Amp	1V			
Q2	Range Xtal Osc.	4V			
Q5	Premixer	2.5V	2.15V	480	
Q11	Xtal Osc.	3V			
Q17	Xtal Osc. Buffer				1.35V
Q21	Neg. Supply Driver	2.8V			
Q27	BFO	4.25V			

All voltages are millivolts RMS except those marked V (volts)

MEASUREMENT CONDITIONS

Set signal generator to 7.0 MHz and 1 millivolt at the SPR-4 antenna jack. Tune in generator on LSB for maximum S-meter reading with RF Gain fully clockwise and accessory switch on NORM and notch in OFF position. Measurements taken without 5-NB installed. Boonton Model 91 CA RF voltmeter used. 100:1 divider used on measurements above 500 mV.

* SPR-4 tuned to 1 MHz LSB with 1 millivolt R.F. across external 47 ohm emitter resistor. Measurement of generator output must be done with SPR-4 turned off.

** Large variations (-50% + 100%) from values shown are typical.



2N 3394



MFE 3007
*SFC 4982



MPF 102



*2N 5949
*2N 5950



T1S88
*2N 5245
*2N 5246

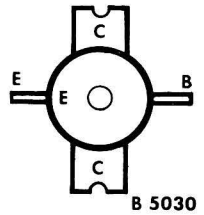

B 5030



2N 4125



2N 3566

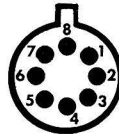

CA 3053

* SERIAL NO'S. ABOVE 1000

TRANSISTOR LEAD CONFIGURATION
Figure 21

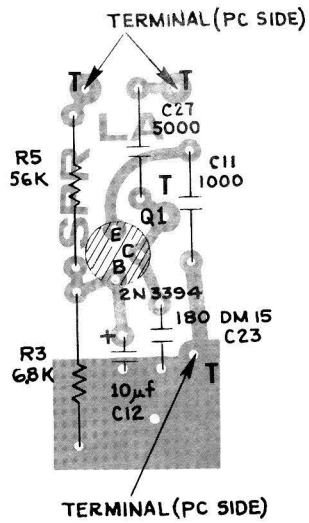

LOOP ANTENNA CIRCUIT BOARD

Figure 22

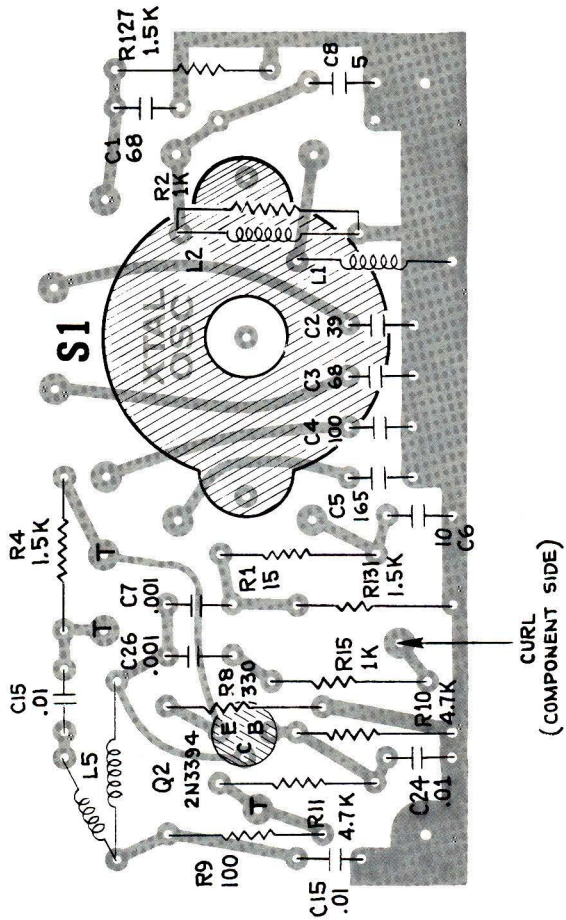

RANGE CRYSTAL OSCILLATOR CIRCUIT BOARD

Figure 24

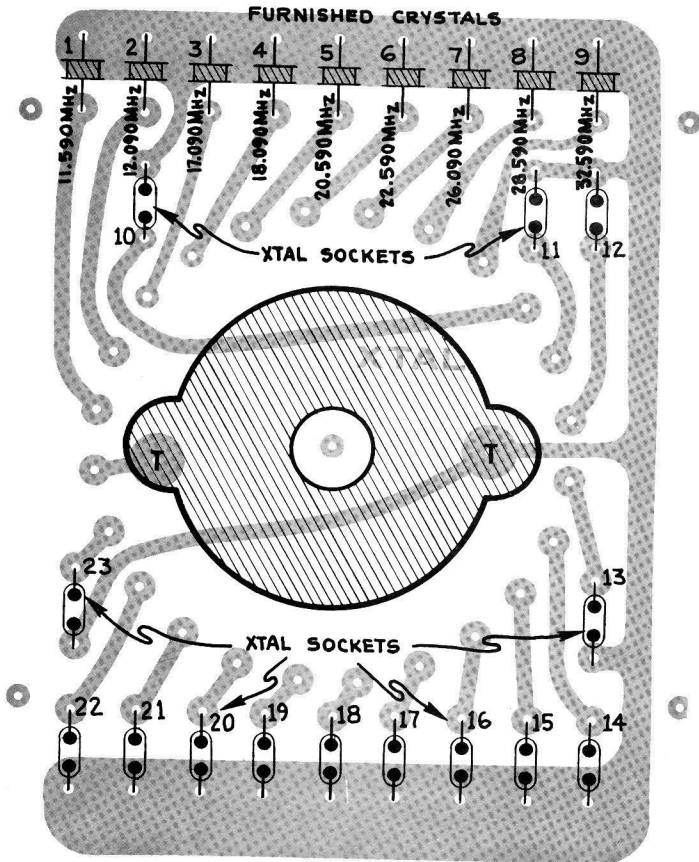

ACCESSORY CRYSTAL CIRCUIT BOARD

Figure 25

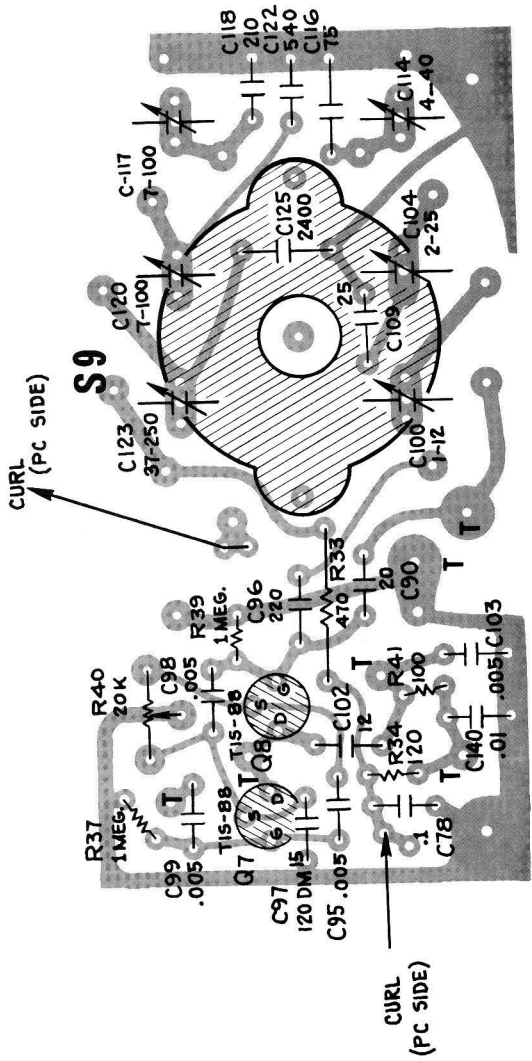

1st MIXER CIRCUIT BOARD
Figure 28

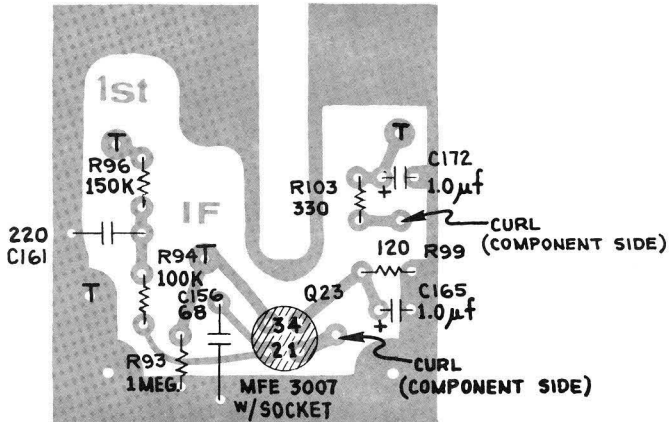

1st IF AMPLIFIER CIRCUIT BOARD

Figure 30

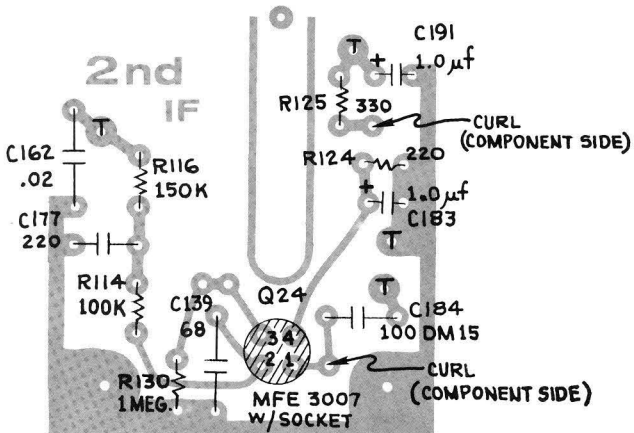

2nd IF AMPLIFIER CIRCUIT BOARD

Figure 31

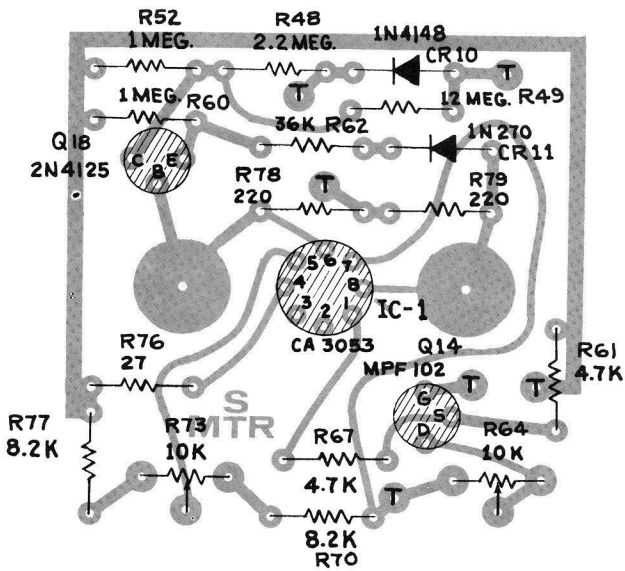

S-METER CIRCUIT BOARD
Figure 32

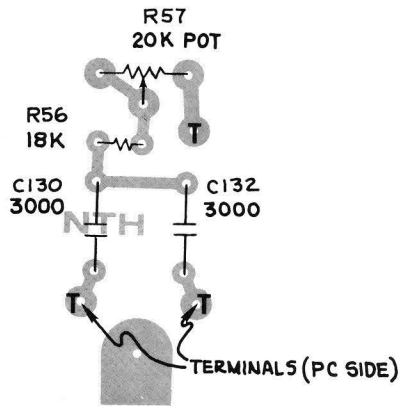

NOTCH FILTER CIRCUIT BOARD
Figure 33

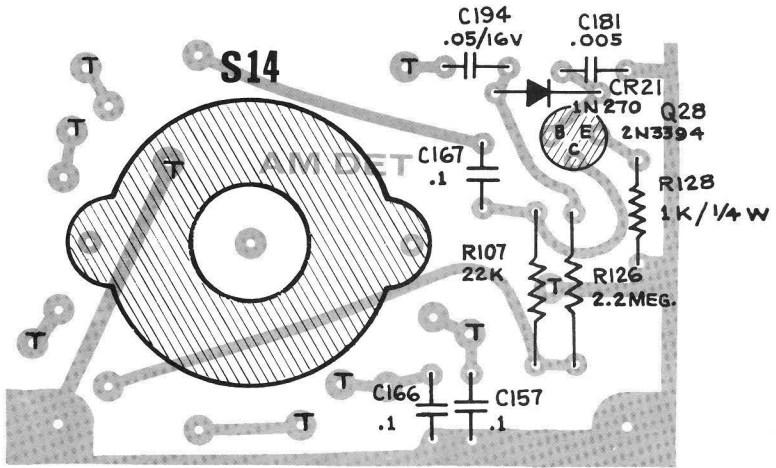

AM DETECTOR CIRCUIT BOARD

Figure 36

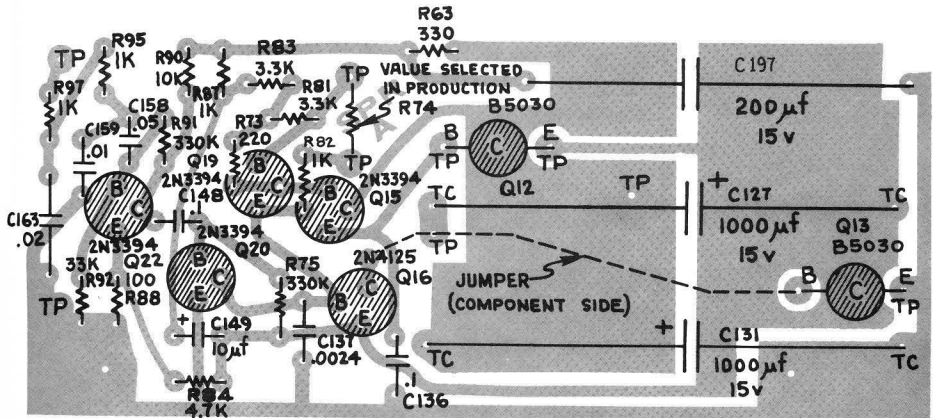

TP : TERMINAL ON PC SIDE

TC : TERMINAL ON COMPONENT SIDE

AUDIO AMPLIFIER CIRCUIT BOARD

Figure 37

SPR-4 SPARE PARTS LIST

February 1, 1971
 Prices subject to change
 without notice

QTY	SYMBOL	ITEM	PRICE EACH
1	-----	Board, printed circuit, audio	\$ 10.00
1	-----	Board, printed circuit, meter	4.50
1	-----	Board, printed circuit, 2nd I.F.	3.25
1	-----	Board, printed circuit, 1st I.F.	3.25
1	-----	Board, printed circuit, Notch	1.75
1	-----	Board, printed circuit, A.M. detector	3.00
1	-----	Board, printed circuit, B.F.O.	3.25
1	-----	Board, printed circuit, Osc. mixer	20.00
1	-----	Board, printed circuit, L.A.	2.25
1	-----	Board, printed circuit, 1st mix	7.00
1	-----	Board, printed circuit, Injection	4.75
1	-----	Board, printed circuit, Oscillator	4.75
1	-----	Board, printed circuit, Pre mixer	5.50
1	-----	Cabinet, top & bottom, w/feet	15.00
--	-----	Capacitor, Electrolytic, 1000 mfd 15V	1.75
--	-----	Capacitor, Electrolytic, 200 mfd 15V	1.25
--	-----	Capacitor, Electrolytic, 1000 mfd 25V	2.40
--	-----	Capacitor, Electrolytic, 10 mfd 25V	.60
--	-----	Capacitors, Disc, Ceramic	.06
--	-----	Capacitors, Mica	.08
--	-----	Capacitors, Trimmer	.40
1	-----	Carton, Shipping, complete	2.75
--	-----	Control, P.C. pots	.40
1	-----	Control, AF/RF On/Off	1.75
1	-----	Control, sideband tuner	Write Factory
1	-----	Control, Crystal selector	Write Factory
1	-----	Cord, D.C. power	5.00
1	-----	Cord, A.C. power	3.00
--	-----	Crystal Filter	25.00
--	-----	Diode, Z13B (or equiv.)	.94
--	-----	Diode, 1N751 (or equiv.)	.80
--	-----	Diode, 1N714 (or equiv.)	1.20
--	-----	Diode, 1N270 (or equiv.)	.55
--	-----	Diode, B5G5 (or equiv.)	.55
--	-----	Diode, 1N4148 (or equiv.)	.50
--	-----	Diodes, others as required	Write Factory
1	-----	Dial assembly, complete	2.50
1	-----	Dial, blue background	.15
1	-----	Dial, crystal selector (blank)	1.00
--	-----	Feet, plastic	.10
--	-----	Fuse, 3/4 amp	.22
--	-----	Fuse, 5 amp	.22
--	-----	Fuse, 1/4 amp	.22

SPR-4 SPARE PARTS LIST (continued)

QTY	SYMBOL	ITEM	PRICE EACH
--	-----	Knob, main tuning, with skirt	\$ 1.50
--	-----	Knob, small	.30
--	-----	Lamp, panel, #47	.15
1	-----	Meter, signal strength	4.95
1	-----	Panel, front	6.00
1	-----	PTO assembly, complete, with dial	Write Factory
--	-----	Resistors, 1/2 watt	.06
--	-----	Resistors, 1 watt	.20
--	-----	Resistors, 2 watt	.25
--	-----	Switch wafers, specify	.65
--	-----	Switch, slide	.20
--	-----	Switch, other	Write Factory
--	-----	Transformer, power	7.50
--	-----	Transformer, R.F. & I.F., specify	4.00
--	-----	TRANSISTORS:	
		2N3394 (or equiv.)	.30
		2N3858 (or equiv.)	.41
		2N4125 (or equiv.)	.52
		2N3566 (or equiv.)	.74
		2N5245 (or equiv.)	1.00
		MPP102 (or equiv.)	1.00
		B5030 (or equiv.)	1.25
		CA3053 (or equiv.)	.81
		MFE3007 (or equiv.)	1.65
--	-----	Transistors, other as required	Write Factory

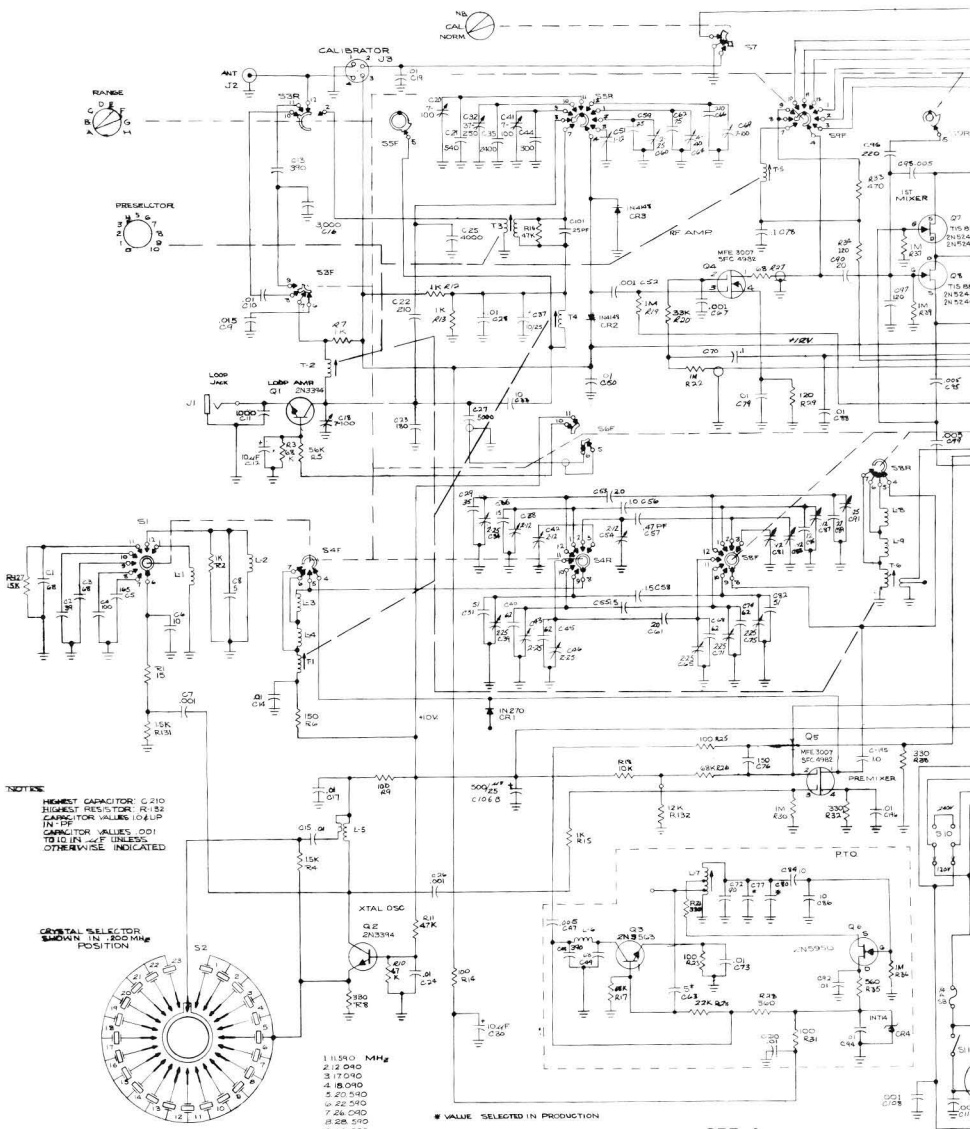

NOTES
 HIGHEST CAPACITOR: C 210
 HIGHEST RESISTOR: R 152
 CAPACITOR VALUES 10 μ P
 CAPACITOR VALUES .001
 TO 10 IN μ F UNLESS
 OTHERWISE INDICATED

**CRYSTAL SELECTOR
 SHOWN IN 850 MHz
 POSITION**

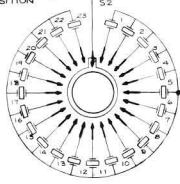

- 1 1150 MHz
- 2 12 040
- 3 17 040
- 4 18 040
- 5 21 540
- 6 22 540
- 7 28 040
- 8 28 540
- 9 32 540

* VALUE SELECTED IN PRODUCTION

**SPR-4
 SCHEMATIC DIAGRAM**

