



*SW8 World Band Shortwave Receiver*  
*with Selectable Sideband Synchronous Detector*

# Owner's Manual

Downloaded by   
Amateur Radio Directory   
  
[www.hamdirectory.info](http://www.hamdirectory.info)



**DRAKE** <sup>®</sup> is a registered trademark of the R. L. Drake Company

# Declaration of Conformity

We, Manufacturer/Importer

(Full address)

**R. L. Drake Company**  
230 Industrial Drive  
Franklin, Ohio 45005 United States of America

declare that the product

(description of the apparatus, system, installation to which it refers)

**SW8 World Band Shortwave Receiver**  
1295

is in conformity with

(reference to the specifications under which conformity is declared)

in accordance with 89/336/EEC-EMC Directive

- |   |  |  |   |
|---|--|--|---|
| <input type="checkbox"/> EN 55011                       | Limits and methods of measurement of radio disturbance characteristics of industrial, scientific and medical (ISM) high frequency equipment                | <input type="checkbox"/> EN 60555-2            | Disturbances in supply systems caused by household appliances and similar electrical equipment "Harmonics"  |
| <input checked="" type="checkbox"/> EN 55013            | Limits and methods of measurement of radio disturbance characteristics of broadcast receivers and associated equipment                                     | <input type="checkbox"/> EN 60555-3            | Disturbances in supply systems caused by household appliances and similar electrical equipment "Voltage fluctuations"   |
| <input type="checkbox"/> EN 55014                       | Limits and methods of measurement of radio disturbance characteristics of household electrical appliances, portable tools and similar electrical apparatus | <input type="checkbox"/> EN 50081-1            | Generic emission standard Part 1: Residual, commercial and light industry   |
| <input type="checkbox"/> EN 55015                       | Limits and methods of measurement of radio disturbance characteristics of fluorescent lamps and luminaries   | <input checked="" type="checkbox"/> EN 50082-1 | Generic immunity standard Part 1: Residual, commercial and light industry   |
| <input checked="" type="checkbox"/> EN 55020            | immunity from radio interference of broadcast receivers and associated equipment   | <input type="checkbox"/> EN 50081-2            | Generic emission standard Part 2: Industrial environment  |
| <input type="checkbox"/> EN 55022                       | Limits and methods of measurement of radio disturbance characteristics of information technology equipment   | <input type="checkbox"/> EN 50082-2            | Generic immunity standard Part 2: Industrial environment  |
| <input type="checkbox"/> DIN V VDE 0855 part 10 part 12 | Cabled distribution systems; Equipment for receiving and/or distribution from sound and television signals   | <input type="checkbox"/> EN 50065-1            | Signalling on low-voltage electrical Installations in the frequency range of 3kHz to 148.5kHz<br>Part 1: General requirements, frequency bands and electromagnetic disturbances |
| <input checked="" type="checkbox"/> CE marking          |  | <input type="checkbox"/> EN55104               | Immunity requirements for household appliances tools and similar apparatus  |

**CE** (EC conformity marking)

The manufacturer/importer also declares the conformity of above mentioned product with the actual required safety standards in accordance with LVD 73/23 EEC.

- EN 60065 Safety requirements for mains operated electronic and related apparatus for household and similar general use

**Manufacturer/Importer**

**DRAKE**®

(Stamp)

Signature: Ronald E. Wysong

Date: January 01, 1997 Name: Ronald E. Wysong

EMC Tested by  electronic GmbH



Date: April 26/1996

Signature: P. Kraśowski

Ref. No. 963732

Name: P. Kraśowski Dipl.-Ing.

WARNING: TO PREVENT FIRE OR ELECTRICAL SHOCK DO NOT EXPOSE THIS PRODUCT'S AC ADAPTOR TO RAIN OR MOISTURE

	<b>!CAUTION!</b> RISK OF ELECTRIC SHOCK DO NOT OPEN	
CAUTION: TO REDUCE THE RISK OF ELECTRIC SHOCK, DO NOT REMOVE COVER OF AC ADAPTOR NO USER-SERVICABLE PARTS INSIDE REFER SERVICING TO QUALIFIED PERSONNEL		



An appliance and cart combination should be moved with care. Quick stops, excessive force and uneven surfaces may cause the appliance and cart combination to overturn.

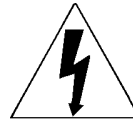

The lightning flash with arrow head symbol, within an equilateral triangle, is intended to alert the user to the presence of uninsulated "dangerous voltage" within the product's enclosure that may be of sufficient magnitude to constitute a risk of electric shock to persons.



The exclamation point within an equilateral triangle is intended to alert the user to the presence of important operating and maintenance (servicing) instructions in the literature accompanying the appliance.

WARNING: TO REDUCE THE RISK OF FIRE OR ELECTRIC SHOCK, DO NOT EXPOSE THIS PRODUCT'S AC ADAPTOR TO RAIN OR MOISTURE. DO NOT OPEN THE AC ADAPTOR CASE, REFER SERVICING TO QUALIFIED PERSONNEL ONLY.

CAUTION: TO PREVENT ELECTRIC SHOCK, DO NOT USE THE AC ADAPTOR WITH AN EXTENSION CORD RECEPTACLE OR OTHER OUTLET UNLESS THE BLADES OF THE AC ADAPTOR CAN BE FULLY INSERTED TO PREVENT BLADE EXPOSURE.

ATTENTION: POUR PREVENIR LES CHOCS ELECTRIQUES, NE PAS UTILISER CETTE FICHE POLARISEE AVEC UN PROLONGATEUR, UNE PRISE DE COURANT OU UNE AUTRE SORTIE DE COURANT, SAUF SI LES LAMES PEUVENT ETRE INSEREES A FOND SANS EN LAISSER AUCUNE PARTIE A DECOUVERT.

- 1. Read Instructions**—All the safety and operating instructions should be read before the appliance is operated.
- 2. Retain Instructions**—The safety and operating instructions should be retained for future reference.
- 3. Heed Warnings**—All warnings on the appliance should be adhered to.
- 4. Follow Instructions**—All operating and use instructions should be followed.
- 5. Cleaning**—Unplug this appliance from the wall outlet before cleaning. Do not use liquid cleaners or aerosol cleansers. Use a damp cloth for cleaning.
- 6. Do Not Use Attachments**—not recommended by the manufacturer or they may cause hazards.
- 7. Water and Moisture**—Do not use this product near water—for example, near a bathtub, wash bowl, kitchen sink, laundry tub, in a wet basement, or near a swimming pool—and the like.
- 8. Accessories**—Do not place this product on an unstable cart, stand, tripod, bracket, or table. The product may fall, causing serious injury to a child or adult, and serious damage to the appliance.
- 9. Ventilation**—This product should never be placed near or over a radiator or heat register. This product should not be placed in a built-in installation such as a bookcase or rack unless proper ventilation is provided or the manufacturer's instructions have been adhered to. Any slots or openings in the cabinet are provided for ventilation.

To ensure reliable operation of the product and to protect it from overheating, these openings must not be blocked or covered. The openings should never be blocked by placing the product on a bed, sofa, rug, or other similar surface. **KEEP CURTAINS AND OTHER FLAMMABLE MATERIALS OUT OF DIRECT CONTACT WITH THE AC ADAPTOR.**

**10. Power Sources**—This product should be operated only from the type of power source indicated on the marking label of the supplied AC Adaptor. If you are not sure of the type of power supplied to your home, consult your appliance dealer or local power company.

**11. Lightning**—For added protection for this product during a lightning storm, or when it is left unattended and unused for long periods of time, unplug the AC adaptor from the wall outlet.

**12. Power Lines**—An outside antenna system should not be located in the vicinity of overhead power lines, other electric light or power circuits, where it can fall into such power lines or circuits. When installing an outside antenna system, extreme care should be taken to keep from touching such power lines or circuits as contact with them may be fatal.

**13. Overloading**—Do not overload wall outlets and extension cords as this can result in a risk of fire or electric shock.

## ii Important Safeguards, continued

**14. Servicing**—Do not attempt to service the AC adaptor yourself as opening or removing covers may expose you to dangerous voltage or other hazards. Refer all servicing to qualified service personnel.

**15. Damage Requiring Service**—Unplug this product from the wall outlet and refer servicing to qualified service personnel under the following conditions:

- a. When the AC adaptor cord or plug is damaged.
- b. If the AC adaptor has been exposed to rain or water.
- c. If the product does not operate normally by following the operating instructions. Adjust only those controls that are covered by the operating instructions. An improper adjustment may result in damage and will often require extensive work by a qualified technician to restore the product to its normal operation.
- d. If the product has been dropped or the cabinet has been damaged.
- e. When the product exhibits a distinct change in performance—this indicates a need for service.

**16. Replacement Parts**—When replacement parts are required, be sure the service technician has used replacement parts specified by the manufacturer or have the same characteristics as the original parts. Unauthorized substitutes may result in fire, electric shock or other hazards.

**17. Safety Check**—Upon completion of any service or repairs to this product, ask the service technician to perform safety checks to determine that the product is in proper operating condition.

**18. Outdoor Antenna Grounding**—Before attempting to install this product, be sure the antenna or cable system is grounded so as to provide some protection against voltage surges and built-up static charges.

- a. Use No.10 AWG (5.3mm<sup>2</sup>) copper, No.8 AWG (8.4mm<sup>2</sup>) aluminum, No.17 AWG (1.0mm<sup>2</sup>) copper-clad steel or bronze wire or larger, as ground wire.
- b. Secure antenna lead-in and ground wires to house with stand-off insulators spaced from 4 feet (1.22m) to 6 feet (1.83m) apart.
- c. Mount antenna discharge unit as close as possible to where lead-in enters house.
- d. A driven rod may be used as the grounding electrode where other types of electrode systems do not exist. Refer to the National Electrical Code, ANSI/NFPA 70-1990 for information.
- e. Use jumper wire not smaller than No.6 AWG (13.3mm<sup>2</sup>) copper or equivalent, when a separate antenna grounding electrode is used.

"INSTALL WIRING ACCORDING TO THE CANADIAN ELECTRICAL CODE"  
"EFFECTUER LE CABLAGE CONFORMEMENT AU CODE CANADIEN DE L' ELECTRICITE"

EXAMPLE OF ANTENNA GROUNDING

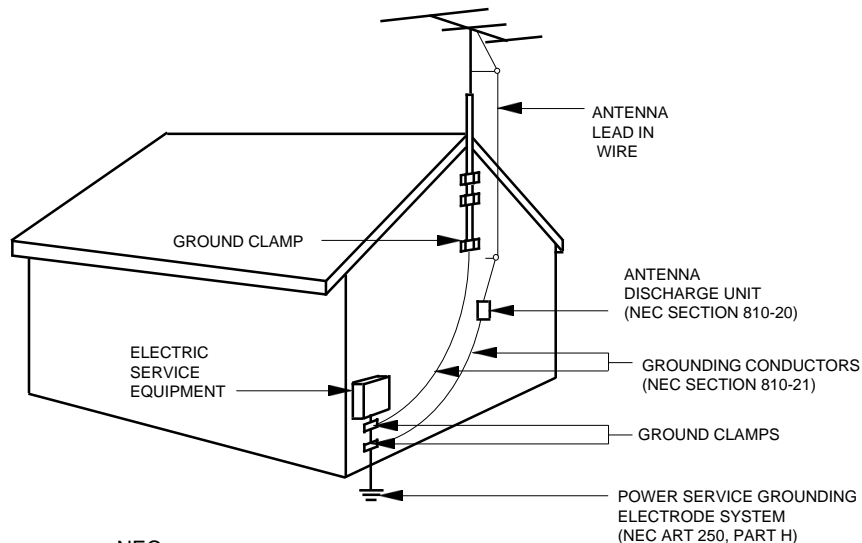

NEC - NATIONAL ELECTRIC CODE

Thank you for purchasing a Drake SW8 World Band Shortwave Receiver. This receiver has been designed and manufactured to high quality standards, and will provide reliable operation for many years.

Please carefully read the Owner's Manual in order to take advantage of the many interesting features that will provide enjoyable listening to radio broadcasts around the world.

---

<b>Important Safeguards</b>	i	<b>Memory Functions</b>	13
		Memory Location Programming	13
<b>Table of Contents</b>	iii	Recalling A Memory Location	13
		Deleting A Memory Location	13
<b>Introduction - General Description</b>	1	<b>Scan Functions</b>	14
		Memory Channel Skip	14
<b>Introduction - Specifications</b>	2	<b>Clock and Timer Functions</b>	15
Optional Accessories	2	Time Display	15
<b>Introduction - Battery Operation and Installation</b>	3	Setting The 24 Hour Clocks	15
		Timer Operation	15
<b>Installation</b>	4	Setting Timer On/Off Times	15
Unpacking	4	Example for Setting Timer	16
Location	4	Enabling / Disabling Timer	16
Adjusting Carrying Handle	4	Example for Setting Overlapping	
Fixed Installation	4	Events	17
Portable Operation	4	Example for Setting Events On Two	
Antenna Requirements	4	Different Memory Channels	17
Installation Diagram	5	<b>Special Use Features and Functions</b>	18
<b>Front Panel Description</b>	6	Lock All Entry to Keypad	18
Telescoping WHIP Antenna	7	10 kHz/9 kHz Broadcast Band Tuning	
<b>Front Panel Display</b>	8	Step Size	18
		Delete All Memory Channels	18
<b>Rear Panel Description</b>	9	Automatic Bandwidth Setting with	
Aircraft Band Squelch	9	Mode Selection Disable (Enable)	18
Master Power Switch	9	<b>Quick Reference Guide</b>	19
<b>Getting Started</b>	10	<b>Memory Channel Log</b>	21
General Operating Information	10	<b>Suggested References</b>	24
Microprocessor Reset	10	<b>Glossary of Terms</b>	25
Beep Tones	10	<b>Troubleshooting</b>	26
Direct Frequency Entry	10	<b>Service and Warranty</b>	27
Shortwave <i>METER</i> Band			
Designator Entry	11		
Frequency Resolution	12		
Front Panel Lock (Unlock)	12		
AM Synchronous Operation	12		
SSB Operation	12		
FM Operation	12		
AGC Operation	12		



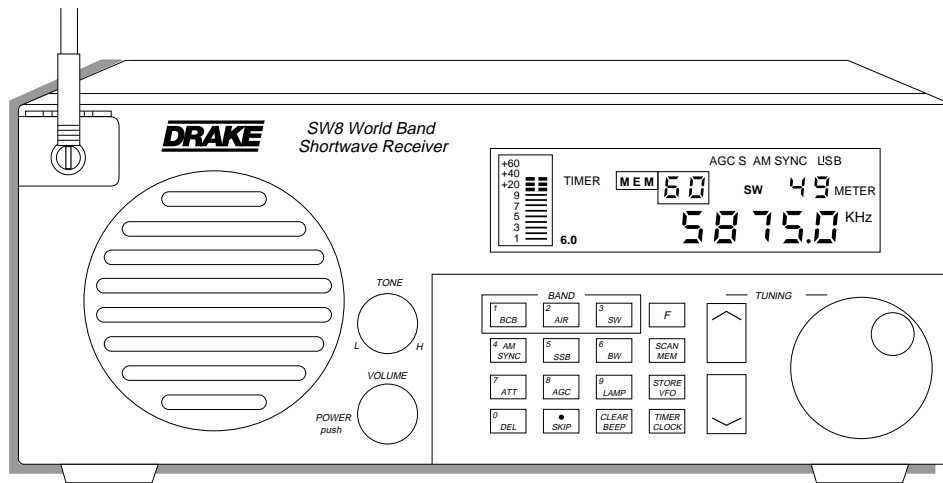

The SW8 is a microprocessor controlled, synthesized, world band receiver with continuous coverage capability from 500 kHz through 30 MHz which includes the AM broadcast and shortwave bands. Reception also includes FM broadcast (87 - 108 MHz) and Aircraft (118-137 MHz). The SW8 offers excellent sensitivity, selectivity, dynamic range and features that permit easy tuning of desired stations. Conveniently located front panel controls allow for rapid operator programming and ease of use. The unit can be operated from either the supplied AC Adaptor or from six "D" cell batteries (not supplied) for portable operation. A low battery voltage indication is displayed when that condition exists.

Three electronically switched IF filters are provided.

The front panel liquid crystal display provides feedback of the current status of the receiver. The seven digit frequency display provides resolution to 100 Hz accuracy in the AM broadcast, Aircraft and Shortwave bands. Resolution to 20 kHz is displayed in the FM broadcast band mode. Backlighting of the display is selectable by a front panel button. To prolong battery life with internal battery operation, the backlighting automatically turns off after a short delay following a function change or retuning of the receiver.

Reception modes include Lower/Upper Sideband (LSB), (USB), and AM in the Shortwave, AM broadcast and Aircraft bands. For the Shortwave and AM broadcast bands, a selectable synchronous detector (SYNC) allows for enhanced reception by eliminating or reducing distortion due to fading signals. During FM broadcast use, stereo reception is available through the use of headphones.

Other built-in reception aids include selectable slow or fast AGC, RF attenuator for use in strong signal handling conditions and TONE control.

Two independent, real time clocks provide a local and alternative time selection. Also provided is a two event timer.

A programmable memory area allows for 70 independent receiver set up memories. These memories do not require battery backup and are thus unaffected by power interruptions. All parameters associated with a particular memory channel are stored including the frequency, mode, bandwidth, fast or slow AGC, RF attenuator and synchronous detector. These memory channels may be accessed manually or through a time scan with each channel monitored for a 5 second period.

## 2 Introduction - Specifications

Frequency Range	100 - 30,000 kHz (0.1 - 30 MHz) 87 - 108 MHz, 118 - 137 MHz AM, USB, LSB modes (0.1 - 30 MHz) AM mode only for 118 - 137 MHz FM mode only for 87 - 108 MHz
Sensitivity: SSB (10 dB S+N/N)	Less than 0.5 $\mu$ V, 0.1 - 30 MHz
Sensitivity: AM (10 dB S+N/N) (1000 Hz, 30% Mod)	Less than 2.0 $\mu$ V, 0.1 - 30 MHz Less than 4.0 $\mu$ V, 118-137 MHz
Sensitivity: FM (20 dB S/N)	Less than 4 $\mu$ V, 87 - 108 MHz (monaural)
Frequency Stability	+/-10 ppm, 0 <sup>o</sup> to 50 <sup>o</sup> C
Frequency Accuracy	Better than +/-100 Hz, @ 25 <sup>o</sup> C
Selectivity- SSB, AM:	6 kHz @ -6 dB, less than 12 kHz @ -60 dB 4 kHz @ -6 dB, less than 9 kHz @ -60 dB 2.3 kHz @ -6 dB, less than 5 kHz @ -60 dB
IF Frequency- SSB, AM:	1st IF 55.845 MHz 2nd IF 455 kHz
FM:	1st IF 10.7 MHz (Single Conversion)
Image Rejection	Greater than 60 dB, 0.1 to 30 MHz Greater than 60 dB, 118 to 137 MHz Greater than 50 dB, 87 to 108 MHz
IF Rejection	Greater than 80 dB, 55.845 MHz Greater than 80 dB, 455 kHz
Dynamic Range	Greater than 95 dB, 0.1 to 30 MHz @ 20 kHz spacing (SSB, 2.3 kHz BW)
IP3 - Intercept Point (@ 50 ohm Ant. input) (Attenuator Off)	Greater than +10 dBm @ 20 kHz spacing Greater than -20 dBm @ 5 kHz spacing
AGC Performance	Threshold: 1.0 $\mu$ V Attack Time: 1 mSec. Release Time - SLOW: 3 sec. - FAST: 300 mSec. Less than 4 dB change in audio output for 100 dB RF input change referenced from the AGC threshold point.

Internal Antenna	41 inch length telescoping whip (for use on all bands).
Antenna Inputs:	
0.1 - 30 MHz	SO-239, 50 ohm connector or 3-terminal compression connector for either 50 OHM or 500 OHM input with ground.
87 - 108 MHz, 118 - 137 MHz	2-terminal compression connector, 300 ohm balanced input
External Speaker Output	2.0 Watts into 4 ohm speaker @ less than 5 % THD with a 9 VDC supply voltage. Output is a bridged amplifier, (DO NOT GROUND).
Line Audio Output	300 mVolts, 4.7K ohms
Headphone Jack	1/8 inch stereo/mono type
DC Power Requirements	Input: 7-10 VDC @ 1 Amp, supplied from AC Adaptor Wall Transformer, external DC Power Supply or 5.7 to 9.0 VDC supplied by (6) internally mounted "D" cell (1.5V) batteries (not supplied).

Current requirements (approximate) from 9.0 VDC Supply or Batteries with 1/4 W average Audio Output:

MODE	BACKLIGHT	
	OFF	ON
AM	570 mA	700 mA
AM SYNC	600 mA	730 mA
SSB	600 mA	730 mA
FM	440 mA	570 mA

Operating Temperature	0 <sup>o</sup> to +50 <sup>o</sup> C
Weight	10 lbs. (includes AC Adaptor) (batteries NOT included)
Size	Width: 11-1/2 " (29.2 cm) (including retractable bail) Height: 5-1/4" (13.3 cm) (including retractable bail and feet) Depth: 13" (33 cm), (including front knobs and rear panel connectors)
Supplied AC Adaptor Wall Transformer	Input: 120 VAC $\pm$ 10%, 15 Watts Output: 9 VDC @ 1 Amp maximum

### OPTIONAL ACCESSORY:

MS8 - A complementary styled external speaker.

Downloaded by   
Amateur Radio Directory   
  
[www.hamdirectory.info](http://www.hamdirectory.info)



The SW8 receiver is supplied with an AC adaptor to power the SW8 indoors. The AC ADAPTOR is designed to be plugged into a wall outlet that supplies nominal 120VAC, 60 Hz power. **Keep curtains and other flammable materials out of direct contact with the AC ADAPTOR to avoid overheating.**

The SW8 receiver is designed to operate from either the supplied AC ADAPTOR or from six "D" cell batteries (not supplied). **NOTE: Check the batteries periodically for leakage.** IF UNIT IS TO BE STORED OR OTHERWISE NOT USED FOR AN EXTENDED PERIOD OF TIME, REMOVE THE BATTERIES TO PREVENT CORROSION AND POSSIBLE DAMAGE TO THE RECEIVER.

#### Battery Installation

- 1) Position receiver with bottom cover up and front panel towards you.
- 2) Remove battery access cover by loosening the thumb screw and sliding cover toward you.
- 3) Place 6 "D" cell alkaline type batteries into holder. Make sure the batteries are in the proper polarity position as illustrated.
- 4) Replace access cover and tighten the thumb screw to secure cover and batteries.

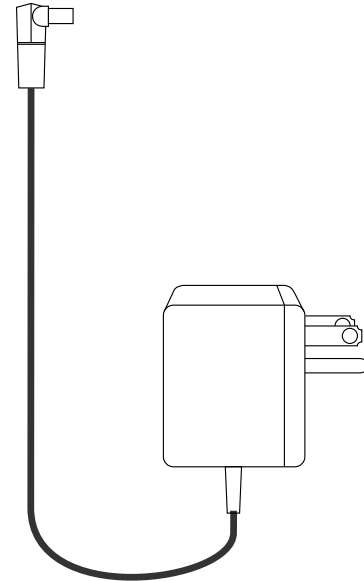

#### NOTE:

The SW8 does not rely on the batteries for retention of memory channels. **To insure that clocks and timers are maintained following the loss of AC power or battery removal, the SW8 must first be connected to a source of AC power or have batteries installed for a minimum of 10 minutes.** If power is lost after this minimum 'charge' time, clocks and timer settings are maintained for a time period of approximately 30 minutes.

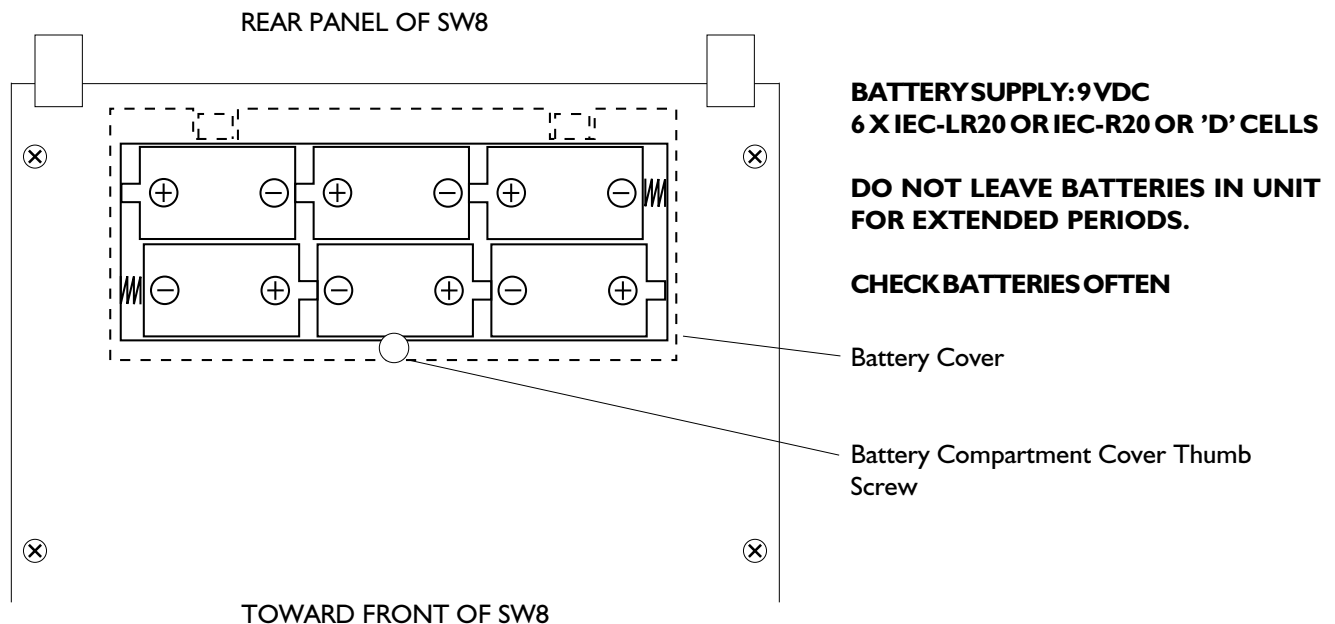

**FIGURE 1 - BATTERY COVER REMOVAL AND INSTALLATION**

## UNPACKING

Carefully remove the SW8 and included AC Adaptor wall transformer from the shipping carton and examine them for evidence of damage. If any damage is noted, immediately contact the transportation company responsible for delivery or return the unit to the dealer from whom it was purchased. Keep the shipping carton and all packing material for the transportation company to inspect. The original carton and packing material should be retained for repackaging should it be necessary to return the receiver. Inspect the packing material for any accessories or printed material before storing the box. Locate the registration card, fill it out, and immediately return it to the R.L. Drake Company to insure registration and validation of warranty.

## LOCATION

The location of the SW8 is not critical. For added operating convenience, the carrying handle may be adjusted to elevate the front of the unit or positioned behind the front feet. To adjust the handle, disengage the detents at both sides of the handle at its pivot points and adjust to desired position until detents are engaged. To detach (or reinstall) handle from the receiver, adjust handle to the vertical up position and bow handle outward at both sides. See Figure 2.

For fixed locations, the SW8 should be operated from the AC Adaptor. Keep curtains and other flammable material away from direct contact with the AC Adaptor to avoid overheating the transformer which could result in failure or fire.

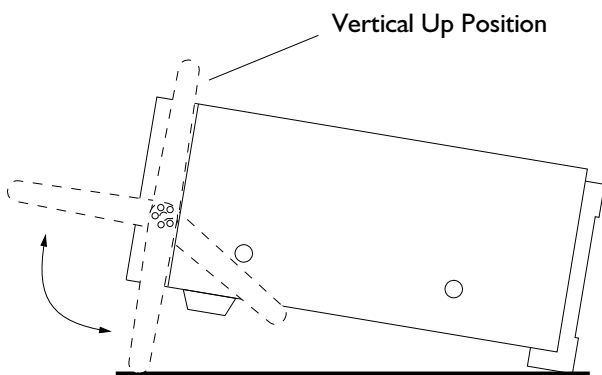

Side View of SW8  
**FIGURE 2 - ADJUSTING CARRYING HANDLE**

## FIXED INSTALLATION

After unpacking the unit, connect the antenna system to the appropriate antenna input. Connect system ground to the compression terminal marked 'GND'. Plug the output cable of the AC Adaptor into the 'External DC Input' connector on the rear panel of the SW8 receiver. Plug the AC Adaptor into a source of 120 VAC, 60 Hz power. Refer to Figure 3 for the diagram of a typical fixed installation.

## PORTABLE OPERATION

For use in a portable environment, the SW8 is operated from six (6) internally mounted "D" cell batteries. These batteries are not supplied and must be installed prior to portable operation of the SW8. See Figure 1 in the 'BATTERY INSTALLATION' section of this manual. For longest battery life, alkaline batteries are recommended for this product.

**NOTE: REMOVE THE BATTERIES IF THE SW8 IS TO BE STORED OR OTHERWISE NOT OPERATED FOR AN EXTENDED PERIOD OF TIME TO AVOID DAMAGE TO THE SW8 DUE TO POSSIBLE BATTERY LEAKAGE OR CORROSION EFFECTS.** The SW8 does not rely on the batteries for retention of memory channels. **To insure that the clocks and timers are maintained following a loss of AC power or battery removal, the SW8 must first be connected to an AC power source or have batteries installed for a minimum of 10 minutes.** If power is lost after this minimum 'charge' time, clocks and event timer settings are maintained for a period of approximately 30 minutes.

## ANTENNA REQUIREMENTS

(Refer to Figure 3, page 5)

The SW8 incorporates rear panel switches to select between the internal whip antenna and various types of external antennas. The built-in 'WHIP' antenna is available for use on all bands. For 500 kHz to 30 MHz operation, two antenna connectors are also provided. 'ANTENNA 1' is a 50 ohm, SO-239 coaxial input requiring a mating PL-259 connector. This input would typically be used as the primary AM broadcast and shortwave band antenna input. Antennas such as dipoles, trap dipoles, verticals and beams will provide the best results depending upon the desired receiving frequency. 'ANTENNA 2' is a compression terminal type connection, providing a choice of high-impedance (500 ohms typical) or low-impedance (50 ohms typical). Antennas such as long wires or end-fed Zepps will provide the best results. For reception in the 87-108 and 118-137 MHz range, the 'FM/AIR' terminals are also provided. Outside TV antennas, folded dipoles or coaxial antennas will provide the best results with this input for reception of the FM broadcast and Aircraft bands. Depending upon the particular type of antenna feed, connect to one of the 'FM/AIR' terminals and the 'GND' terminal for an unbalanced 75 ohm input, or, connect to the two '300 ohm' terminals for a balanced 300 ohm input. The best antenna for any of the previously mentioned inputs will depend on the frequency range and time of day for the particular signal in question. Refer to publications such as the ARRL Handbook or ARRL Antenna Manual (available in most public libraries) for help on selection and/or construction of the antennas mentioned above.

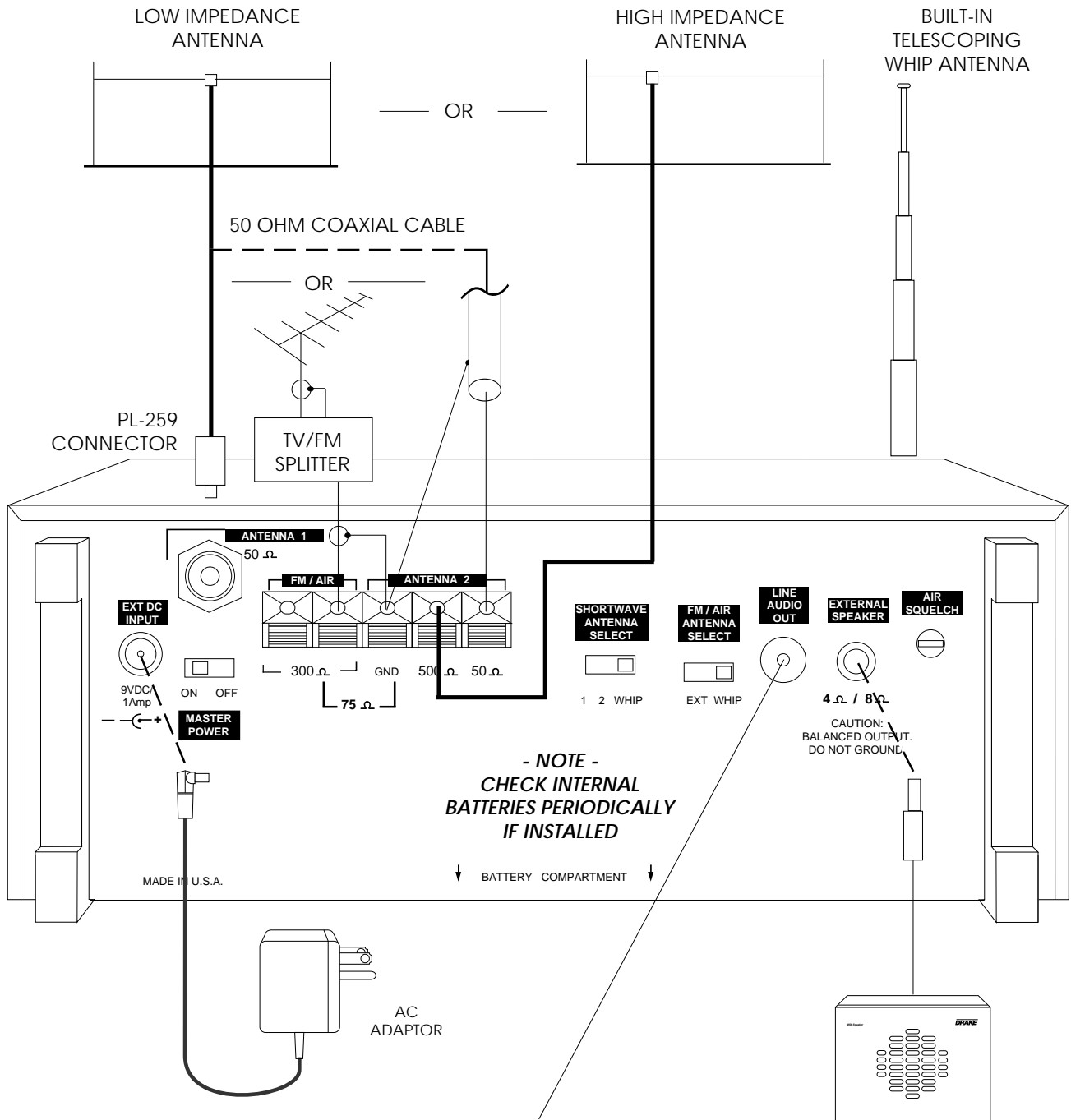

PLUG INTO 120VAC,  
60Hz AC POWER

TO  
TAPE RECORDER  
INPUT

EXTERNAL SPEAKER  
DO NOT GROUND



NOTE:  
Grounding of either speaker  
output wire will limit maximum  
available audio output and  
damage the SW8.

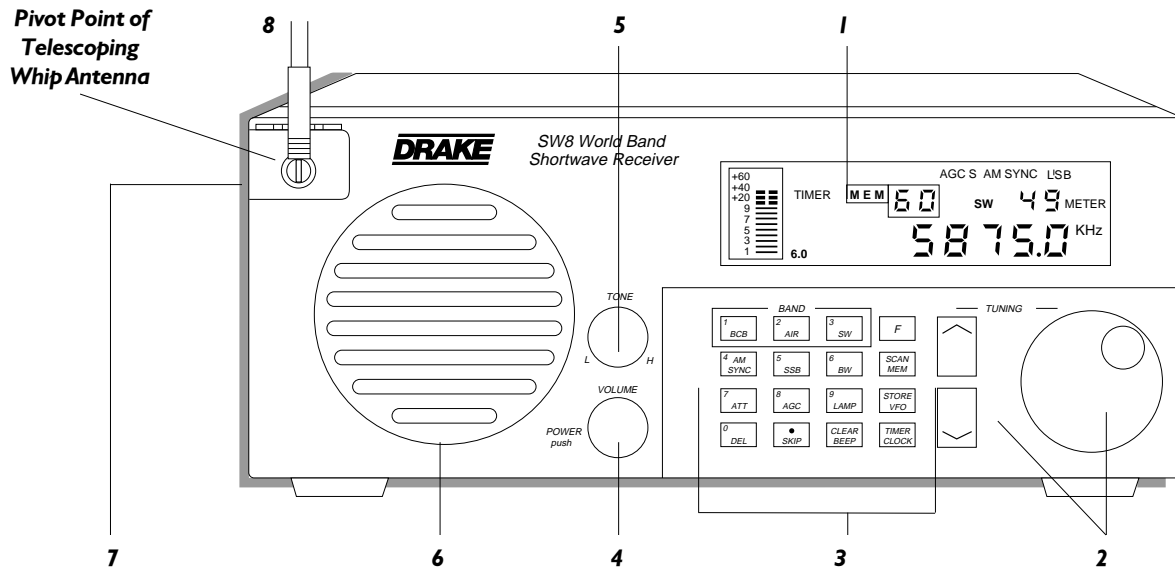

FIGURE 3 - INSTALLATION DIAGRAM

## 6 Front Panel Description







**1) Display** - The backlit, liquid crystal display provides the current status of the SW8 such as frequency, mode, bandwidth, etc. Refer to the 'FRONT PANEL DISPLAY' section of this manual for a full description.

**2) TUNING (VFO)** - The dial and the  and  buttons are the primary tuning controls of the SW8. Clockwise rotation of the dial increases frequency and counterclockwise rotation decreases frequency. The dial also incorporates variable speed tuning. The faster the dial is rotated, the faster the tuning speed.

The  button increases and the  button decreases the frequency by fixed steps (10 kHz or 9 kHz, selectable on the AM broadcast band, 5 kHz on the Shortwave band, 100 kHz on the FM broadcast band and 25 kHz on the Aircraft band) with each depression. Pressing and holding either button will allow continuous stepping up or down as long as the button is depressed.



### 3) Program Buttons -

 **(Function)** - Pressing this button accesses the secondary functions, printed in orange, on the program buttons. Press the  button first to display '  ', then press the desired function button. With the SW8 not in the SCAN mode, pressing and holding the  button locks all keypad entries, display settings and tuning knob entries.



 **BCB** - Press to select between the AM or FM broadcast band. Repeated pressings toggle between AM and FM. The secondary function of this button is the digit '1'.

 **AIR** - Press to select the Aircraft band. The secondary function of this button is the digit '2'.

 **SW** - Press to select the Shortwave band. The secondary function of this button is the digit '3'.

 **AM SYNC** - Press to select the AM mode of operation. Successive depressions toggles the synchronous detector on and off. Press  to turn the synchronous detector off before selecting SSB modes. The 'AM/AM SYNC' modes are not accessed in the FM band. The 'AM SYNC' mode is not accessible in the Aircraft band. The secondary function of this button is the digit '4'.

 **SSB** - Press to select the SSB mode of operation ('SYNC' must be turned off). Successive depressions select alternately the 'LSB' or 'USB' modes as displayed. The SSB mode of operation is not accessed in either the FM or Aircraft band modes. The secondary function of this button is the digit '5'.

 **BW** - The bandwidth setting can be programmed to be automatic with mode selection or manual. The default setting is for automatic selection. Press to select the desired bandwidth: 6.0 kHz, 4.0 kHz or 2.3 kHz. This function has no action in the FM mode. The 6.0 kHz bandwidth is automatically selected in the AM mode. The 2.3 kHz bandwidth is the default for the SSB modes. All three bandwidths are selectable by successive depressions of this button for the AM broadcast, Shortwave and Aircraft bands. To disable the automatic bandwidth selection with mode, start in the POWER 'OFF' mode and press and hold the  button while pressing the POWER button to put the SW8 in the POWER 'ON' mode. To enable the automatic bandwidth selection with mode operation, repeat the same procedure. The secondary function for this button is the digit '6'.

 **ATT** - Press to turn on the built-in 20 dB attenuator to reduce the received signal strength in the AM broadcast and Shortwave bands as required. The attenuator is not active in the FM and Aircraft bands. Successive depressions of the button toggles the attenuator on and off. The secondary function of this button is the digit '7'.

 **AGC** - Press to select either the Slow or Fast AGC setting for the AM broadcast, Shortwave and Aircraft bands. The AGC is not selectable in the FM mode. The secondary function of this button is the digit '8'.





 **LAMP** - Press to turn the display backlighting on or off. With internal battery operation, the backlighting automatically turns off after a short delay following a function change or retuning of the receiver to prolong battery life. Also, the receiver senses Battery or AC operation, and allows the lamp to remain lit if on AC. The secondary function of this button is the digit '9'.



 **DEL** - Press and hold for three seconds to delete a selected memory channel. Audible beep indicates that the selected memory channel has been deleted. The secondary function of this button is the digit '0'.



 **SKIP** - In the memory mode, press to skip the current memory channel for a Scan operation. An 'S' will be displayed to the right of the selected memory channel number. When an 'S' is displayed next to a selected memory channel number, press this button to restore the memory channel for scan operation. The secondary function of this button is the decimal point ('.') which is used when entering a frequency.

 **CLEAR/BEEP** - The 'beep' tone is provided to indicate that entries have been accepted or to notify of error. Press this button to enable or disable the 'beep'.

Pressing the  button first, clears an incorrectly entered frequency or other value.

 **SCAN/MEM** - To recall a memory channel at any time, press the 'MEM' button and within three seconds of the button depression, enter a two-digit number between '00' and '69'. With 'MEM' displayed, other adjacent memory channels can be recalled by use of the  /  buttons. The Tuning wheel may be used to tune from the recalled frequency of the selected memory channel. Please note that digit entries are interpreted as frequency entries if the 'MEM' channel number is not flashing. Pressing the  button first, starts scanning of the current block of 10 channels. The receiver will stop at each programmed channel for 5 seconds, then increment to the next memory channel. Channels programmed for 'SKIP' will not be scanned. Press this button to stop the scan operation.

 **STORE/VFO** - Press to place receiver in the normal variable frequency tuning mode (VFO). Select desired frequency, mode, attenuator, Synchronous detector, AGC, bandwidth, etc. Pressing the  button first, followed by depression of the  button, switches the keypad to the numeric mode. The 'MEM' symbol will flash in the display. Enter a two digit number between '00' and '69' for the desired memory channel. An audible beep will indicate that the memory channel has been stored with the newly entered settings.

 **TIMER/CLOCK** - Pressing this button once will display the current time of the current clock. After three seconds, the display will revert to the current frequency. Pressing and releasing this button while the time is displayed will toggle the time display between the two clocks (local or alternate). The timer will operate according to the last displayed clock time. See the 'SETTING THE 24 HOUR CLOCKS' section of this manual. Pressing the  button first, followed by the TIMER button, will activate the timer mode. If the Timer has been activated, the 'TIMER' symbol will be displayed even after the receiver is turned off. Receiver will automatically turn on and off as programmed. See the "SETTING TIMER ON/OFF TIMES" section of this manual.

**4) VOLUME/POWER** - Push in on this control to turn the receiver On or Off. With receiver power on, adjust this control clockwise to increase the audio level from the receiver's speaker. Be certain to leave the volume setting at the desired level for TIMER use. The POWER switch may be disabled by the rear panel 'MASTER POWER' switch. See the 'Rear Panel Description' section of this manual.

**5) TONE** - This control is used to modify the tonal quality of the audio. Counterclockwise rotation increases the bass response. Flat response occurs at the 12 O'Clock setting. Clockwise rotation increases the treble response.

**6) SPEAKER** - This is the opening for the internal speaker of the SW8.

**7) HEADPHONE JACK** - This connector accepts a 1/8" stereo/mono headphone connector. Stereo reception is possible only in the FM mode. All speaker outputs are automatically switched off when using the headphones.

**8) WHIP ANTENNA** - The receiver has a built-in telescoping antenna that can be used on all bands. **Note that the pivot point section of the antenna must be exposed out of its nesting tube to permit vertical extension of the antenna.** Extend the telescoping sections and position the antenna for best signal reception. Be sure the corresponding rear panel antenna select switch is set to the 'WHIP' position for WHIP antenna reception.

## 8 Front Panel Display

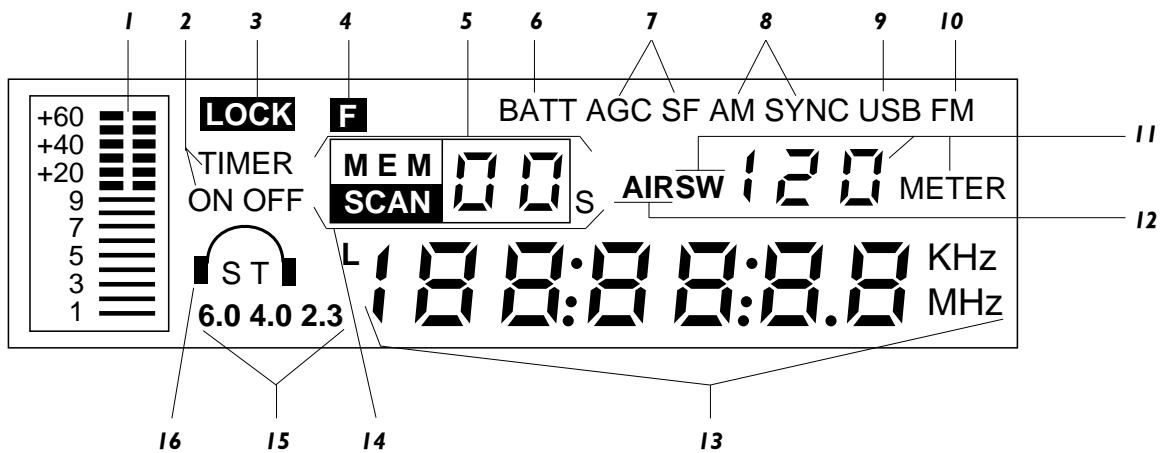



**1) Bar Graph** - This bar graph display indicates the relative received signal level in S-units and dB above S9. Each S-unit between S1 and S9 equals an approximately 5 dB change in received signal strength. Each S-unit above S9 equals an approximately 10 dB change in received signal strength.

**2) TIMER** - This annunciator indicates the state of the Timer as either Active or Inactive. Refer to the 'CLOCK AND TIMER FUNCTIONS' section of this manual.

**3) LOCK** - When illuminated, this annunciator indicates that the Main tuning wheel and keypad are not active.

**4) F** Indicates that the  button has been pressed on the keypad to enable the alternate functions (printed in orange) of the keypad buttons to be active.

**5) MEM  ** - This annunciator indicates current memory location from 00 to 69. MEM will light when the receiver enters the memory mode. Refer to the 'MEMORY FUNCTIONS' section of this manual.

**6) BATT** - When operating on internal batteries, 'BATT' blinks to indicate a low charge on batteries.

**ATT** Indicates that the built-in attenuator is activated.

**7) AGC SF** - Indicates the AGC setting, Slow or Fast.

**8) AM SYNC** - Indicates that the AM mode of reception is on. If SYNC is also illuminated, then the synchronous AM mode of detection is on.

**9) USB** - Indicates that the Upper sideband mode of detection is on.

**LSB** Indicates that the Lower sideband mode of detection is on.

**10) FM** - Indicates that the FM mode of detection is on. This mode is selectable only on the FM broadcast band (87 - 108 MHz).

**11) SW  METER** - Indicates the Shortwave band designators that define a range of frequencies for each band as follows:

### Shortwave Band Designators

**120 METER:** 2300 - 2500 kHz

**90 METER:** 3200 - 3400 kHz

**75 METER:** 3900 - 4000 kHz

**60 METER:** 4750 - 5060 kHz

**49 METER:** 5800 - 6200 kHz

**41 METER:** 7100 - 7600 kHz

**31 METER:** 9500 - 9900 kHz

**25 METER:** 11600 - 12100 kHz

**22 METER:** 13570 - 13870 kHz

**19 METER:** 15100 - 15800 kHz



**16 METER:** 17480 - 17900 kHz

**13 METER:** 21450 - 21850 kHz



**11 METER:** 25600 - 26100 kHz

**12) AIR** - Indicates that the Aircraft band (118 - 137 MHz) has been selected.

**13) 7-Digit Readout** - This display indicates the operating frequency of the receiver. The frequency is displayed in 'kHz' for the AM broadcast and Shortwave bands. The FM and Aircraft band frequencies are displayed in 'MHz'. In the clock mode, these digits indicate time in 24 hour format i.e. HH:MM. In the TIMER mode, indicates time in 24 hour format i.e. HH:MM. 'L' Indicates that Local Time is being displayed in the clock mode. If the 'L' is not illuminated, alternate time is displayed in the clock display mode.

**14) SCAN   S** - Indicates that the receiver is in the memory channel SCAN mode and displays the number of the currently scanned channel, from 00 to 69. In the MEMORY mode, the 'S' illuminates to indicate that a particular memory channel will be skipped over when the SCAN operation is activated.

**15) 6.0 4.0 2.3** - Indicates which IF filter is selected. There is no indication in the FM mode.

**16)  ST ** - Indicates that a stereo FM broadcast station is tuned in when stereo headphones are plugged into the receiver's headphone jack.

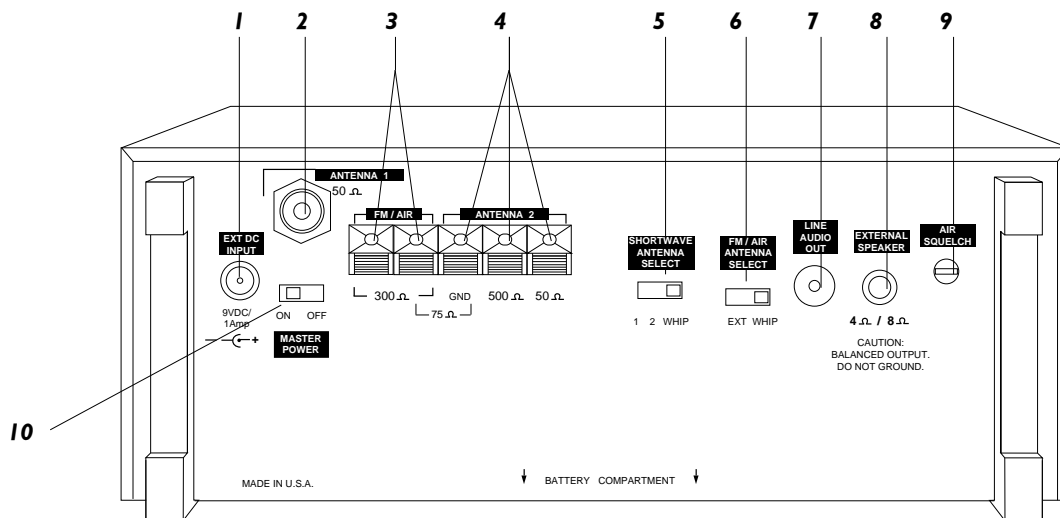

**1) EXT DC INPUT** - Connect the AC Adaptor wall transformer output cable to this connector. The SW8 requires 9 VDC power at approximately 1 Amp current. With external DC power applied, the internal batteries are not used.

**2) ANTENNA 1** - This connector is used when attaching receiving antennas with coaxial feed lines of 50 ohm nominal impedance. Accepts a standard PL-259 plug. If selected by the 'Shortwave Antenna Select' switch (Item 5), this input operates for the AM Broadcast and Shortwave (100 kHz to 30 MHz) bands only.

**3) FM/AIR Antenna** - This input is designed for either an unbalanced 75 ohm input connection that is encountered with coaxial feeds, for example, or, for a two terminal balanced antenna feed with 300 ohm nominal impedance. Connect to the FM connection of a TV/FM outdoor antenna feed (splitter), if available. Folded dipoles or coaxial antennas will also provide good results with this input for reception of the FM broadcast and Aircraft bands. Depending upon the particular type of antenna feed, connect to one of the 'FM/AIR' terminals and the 'GND' terminal for an unbalanced 75 ohm input, or, connect to the two '300 ohm' terminals for a balanced 300 ohm input. If selected by the 'FM/AIR Antenna Select' switch (Item 6), this input operates for the FM broadcast (87-108 MHz) and the Aircraft (118-137 MHz) bands only.

**4) ANTENNA 2** - This connector can be used to attach either a low impedance (50 ohm nominal) or high impedance (500 ohm nominal) antenna. Use the 'GND' and '50 ohm' terminals for a 50 ohm antenna; use the 'GND' and '500 ohm' terminals for a 500 ohm antenna. If selected by the 'Shortwave Antenna Select' switch (Item 5), this input operates for the AM Broadcast and Shortwave (100 kHz to 30 MHz) bands only.

**5) SHORTWAVE ANTENNA SELECT** - This switch selects one of three possible antennas to be used for the 100 kHz to 30 MHz antenna input. The WHIP antenna is built-in to the receiver and is located at the upper left-hand corner of the receiver's front panel. 'ANTENNA 1' and 'ANTENNA 2' are described in Items 2 and 4 on this page.

**6) FM/AIR ANTENNA SELECT** - This switch allows selection of either the built-in WHIP antenna, or the external 75 ohm antenna or 300 ohm antenna connected at the 'FM/AIR' terminals (Item 3) for the 87-108 MHz and 118-137 MHz frequency ranges.

**7) LINE AUDIO OUT** - This RCA connector provides a constant low level audio source that is independent of the front panel volume and tone control settings. It is designed to interface to a tape recorder, CW/RTTY demodulators, amplifiers, etc.

**8) EXTERNAL SPEAKER** - This connector accepts a standard 1/4" diameter, 2-circuit, (monaural) phone plug for connection of an external 4/8 ohm speaker.

**DO NOT GROUND!**

**NOTE: Grounding of either speaker output wire will limit maximum available audio output and damage the SW8.**

**9) AIR SQUELCH** - This control is operational only for the Aircraft band. The control allows muting of the receiver's audio when no signals are present. Adjust the control until background noise just disappears when no signal is being received.

**10) MASTER POWER** - This is a master power switch which protects against accidental activation of front panel power control. If the receiver is operated on batteries and is not to be used for an extended period of time, set this switch to the 'OFF' position. For normal usage of on/off power control from the front panel, set the 'MASTER POWER' switch to the 'ON' position.

# 10 Getting Started

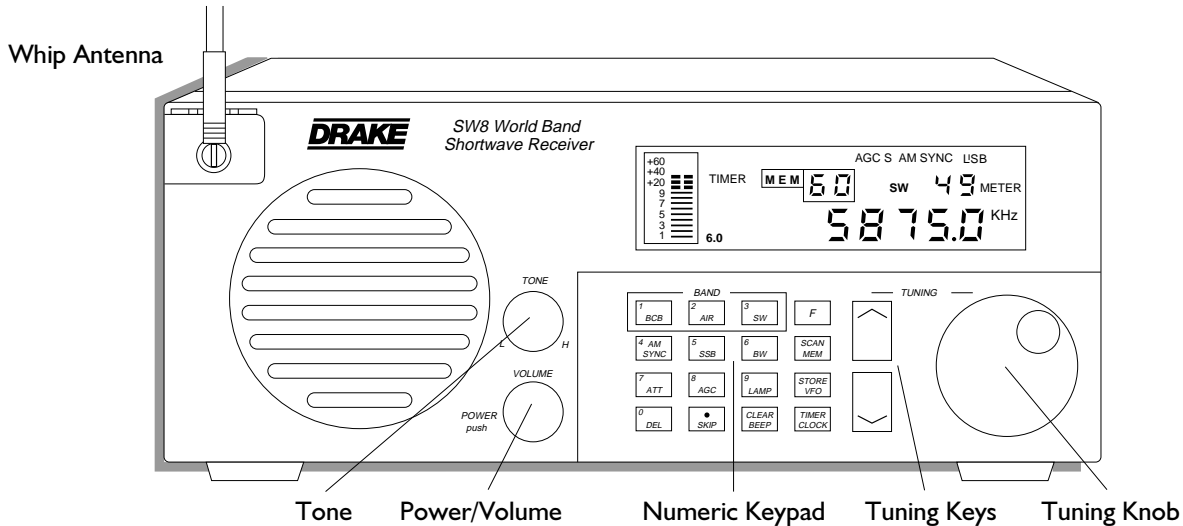

## GENERAL OPERATING INFORMATION

The SW8 has been designed for ease of use. Please take a few moments to read through this section and familiarize yourself with general operating information.

## MICROPROCESSOR RESET

A power-up reset routine will be activated anytime after the SW8 COMPLETELY loses power, either internal batteries or external DC input. This will be observed by the front panel display illuminating all annunciators for 3 seconds, followed by the clock display. However, short term power failures of up to 30 minutes are masked by an internal back-up capacitor. This will allow ample time for battery replacement without loss of the internal clock. Note: Any programmed memory locations will NOT be lost under a power-up reset due to the memory design of the SW8.

## BEEP TONES

The SW8 responds to all key depressions with an audible beep unless the beep has been disabled by the **CLEAR BEEP** button. No beep is generated under any condition for depressions of the TUNING keys. Beep tones indicate the following:  
 One short tone for a key depression.  
 One long, high tone when storing a memory channel.  
 One long, low tone for any illegal key depression.

## GETTING STARTED

Please refer to the front panel illustrations and set the controls as shown.

- 1) Install 6 "D" batteries or connect AC adaptor.
- 2) Fully extend whip antenna, adjust to a vertical position and engage in holder, or connect an external antenna to appropriate rear panel terminals. Set rear panel 'ANTENNA SELECT' switch(es) to appropriate position(s).

3) Press POWER and adjust VOLUME to comfortable level. **(NOTE: Be sure the 'MASTER POWER' switch on the rear panel is in the 'ON' position.)**

4) Select the desired band by pressing one of the **BCB**, **AIR**, or **SW** buttons.

5) Enter the desired frequency by using one of several methods covered below.

## DIRECT FREQUENCY ENTRY

Direct entry of a desired frequency is possible using the orange numeric keys 0-9 and decimal key. While entering a frequency, if an incorrect frequency is entered, pressing the **CLEAR BEEP** button will clear the entry in progress and return the SW8 to its previous settings.

\*\* The second depression of the decimal **SKIP** button acts as an 'ENTER' and causes immediate response to the entered frequency. If you do not press the decimal **SKIP** button a second time at the end, the SW8 will automatically enter the frequency after a slight delay. Press the **F** button to shift keyboard to numeric entry.

Enter frequency as follows:

A) Shortwave and AM broadcast enter in kHz (kilohertz). A maximum of 6 digits may be entered. Example:

700 kHz

Press **F** **7** **ATT** **0** **DEL** **0** **DEL** **SKIP** **SKIP** \*\*

29660 kHz

Press **F** **2** **AIR** **9** **LAMP** **6** **BW** **6** **BW** **0** **DEL** **SKIP** **SKIP** \*\*



14258.1 kHz

Press        







OR

Press        \*

\* When the maximum number of allowed digits is entered, the decimal point will be automatically placed between the 1 kHz and .1 kHz digits and need not be entered.



B) Aircraft and FM broadcast enter in MHz (megahertz). A maximum of 5 digits may be entered for FM. A maximum of 7 digits may be entered for Aircraft. Example:

97.7 MHz

Press       \*\*

121.9 MHz

Press        \*\*

\*\* The second depression of the decimal  button acts as an 'ENTER' and causes immediate response to the entered frequency. If you do not press the decimal  button a second time at the end, the SW8 will automatically enter the frequency after a slight delay.

Attempting to enter a frequency outside the tuning range of the SW8 will cause the ERROR annunciator to flash along with the error beep to be heard. The SW8 will then return to its previous settings.

Downloaded by   
 Amateur Radio Directory   
  
[www.hamdirectory.info](http://www.hamdirectory.info)



### SHORTWAVE 'METER' BAND DESIGNATOR ENTRY

To facilitate tuning to particular sections of the shortwave band that contain many worldwide broadcasts of news, information and music, the SW8 permits entry of the 'METER' band designator. In some cases, the worldwide broadcast station may not announce its exact operating frequency, but will announce the 'METER' band in which it is operating or to which band it will move to improve worldwide reception at a particular time of day. By entering this 'METER' band number, the SW8 automatically tunes to the low frequency end of the corresponding 'METER' band. The search for the new station location is thus limited to a particular smaller section of the entire shortwave band spectrum. The Shortwave Band Designators and corresponding frequency range is as follows:



#### Shortwave Band Designators



**120** METER: 2300 - 2500 kHz  
**90** METER: 3200 - 3400 kHz  
**75** METER: 3900 - 4000 kHz  
**60** METER: 4750 - 5060 kHz  
**49** METER: 5800 - 6200 kHz  
**41** METER: 7100 - 7600 kHz  
**31** METER: 9500 - 9900 kHz  
**25** METER: 11600 - 12100 kHz  
**22** METER: 13570 - 13870 kHz  
**19** METER: 15100 - 15800 kHz  
**16** METER: 17480 - 17900 kHz  
**13** METER: 21450 - 21850 kHz  
**11** METER: 25600 - 26100 kHz

Press the  button to enter the shortwave band tuning mode. At this point, you can enter a frequency with the numeric buttons, or use the Tuning wheel

and' or   buttons to change frequency.

To enter a shortwave band 'METER' designator, press the  button a second time to display a flashing 'METER' number entry prompt. Enter one of the listed two or three digit numbers corresponding to the desired 'METER' band designator using the numeric buttons. While the 'METER' annunciator is flashing, the



 and  buttons can also be used to step quickly from band to band. After selection of the

Meter band, use the Tuning wheel or  and  buttons to change the frequency, or press the  button followed by the desired numeric frequency entry.



## 12 Getting Started, continued

### FREQUENCY RESOLUTION

The SW8 tunes in the following steps:

Mode	Display Resolution	Tuning Resolution	 
Broadcast Band: AM	100 Hz	100 Hz	10 kHz/9 kHz
Shortwave Band: AM	100 Hz	100 Hz	5 kHz
USB, LSB	100 Hz	50 Hz	5 kHz
FM	10 kHz	20 kHz	100 kHz
AIR	100 Hz	100 Hz	25 kHz



### FRONT PANEL LOCK (UNLOCK)

All keyboard entries, display settings, and entries from the tuning knob can be locked if desired. First, be sure the SW8 is not in SCAN. Press and hold the  button. The LOCK annunciator will light indicating the front panel controls are locked out. Power ON/OFF will still function as well as volume and tone controls. Press and hold the  button to unlock.

### AM SYNCHRONOUS OPERATION

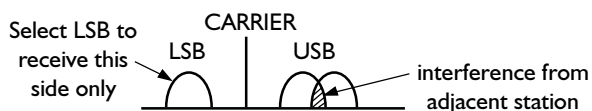
For general tuning and listening, normal AM is best. If, however, the received signal sounds distorted, or interference from adjacent stations is present, AM synchronous should be engaged. The synchronous detector in your receiver can greatly reduce the severe audio distortion that can occur due to signal fading. The detector also permits selectable tuning to either the upper or lower sideband portion of an AM signal. Since most all AM (LW, MW and SW) broadcasting generally uses double-sideband transmission, detection of either of the two sidebands results in full reception of the transmitted information. The selectable sideband tuning and detection not only aids reception by permitting tuning to the stronger or less distorted sideband, but also permits rejection of the sideband nearer to the interfering signal(s). For Example:



The synchronous detector will lock to the strongest signal that is within the IF passband when it is activated. Most of the time, the strongest signal will be the carrier of the desired signal. First, be sure the main tuning is set to within 1 kHz of the desired station's transmitting frequency. Press the  button to activate synchronous operation. If adjacent channel interference or any other undesired signal is sufficiently strong, the synchronous detector may lock to it instead. In that case, press the  button to turn the synchronous detector off and repeat the tuning process. For severe cases of fading, set the audio bandwidth to 4 kHz. If interference is present, press the SSB button to select the sideband with the least interference. If the interference is sufficiently severe to prevent reception, select a narrower IF bandwidth and retune to the desired signal. After reception is obtained, select a wider bandwidth and/or

alternate sideband if desired. When AM/SYNC has been activated, moving the main tuning knob will cause the SYNC circuit to momentarily disengage (indicated by 'SYNC' flashing), then back on again when tuning has stopped. AM SYNC does not function on the AIR band, and will not operate properly on intermittent transmissions such as those encountered on CB radio bands, for example. For those types of transmissions, use the AM mode. Press the  button to turn the synchronous detector off before selecting LSB or USB modes.

### SSB OPERATION

Tuning in a single sideband (SSB) signal can be somewhat frustrating for the first time listener. In either of the SW8's SSB modes, LSB (lower sideband), or USB (upper sideband), the receiver will select the 2.3 kHz bandwidth automatically (the SW8 may be programmed to NOT automatically select a bandwidth. Refer to 'Automatic Bandwidth Setting With Mode Selection DISABLE (ENABLE)' in the 'Special Use Features and Functions' section of this manual). Generally, LSB is used below 10 MHz and USB is used above 10 MHz. When initially tuning in the desired station, tune slowly. If the station is unintelligible, try the other sideband, again tuning slowly. A station tuned in on the wrong sideband is totally unreadable but a station mistuned on the correct sideband may sound like 'Donald Duck'. Further tuning will result in a more normal voice pitch.

### FM OPERATION

FM reception is perhaps the easiest mode to use on the SW8. The AGC and BANDWIDTH settings are not used in FM. In fact, attempting to activate these buttons will result in an 'ERROR' beep. All FM stations in the U. S. end in an odd 100 kHz, i.e., 97.7 MHz, and are spaced 200 kHz apart. The SW8 has the ability to tune in 20 kHz steps to allow tuning in between stations to help eliminate interference to weaker stations that could be covered up by stronger adjacent stations. Additionally, when headphones are used, true stereo reception is possible. The front panel  annunciator will light when a stereo station is tuned in with the stereo headphones plugged in. The SW8 will automatically switch to stereo and provide left and right audio from the headphone jack only. If the headphones are removed while listening to a stereo broadcast, the SW8 reverts to monaural audio from the internal or external speaker.

### AGC OPERATION

The SW8 provides the ability to select a Slow or Fast AGC setting. Either of the two settings will permit automatic control of the receiver's gain thereby producing a constant audio output free of distortion. Generally, the Slow AGC setting is preferred for reception of AM and SSB signals. The Fast AGC setting allows more rapid automatic receiver gain adjustment to quickly fading signal levels.

The AGC does not function in the FM mode.

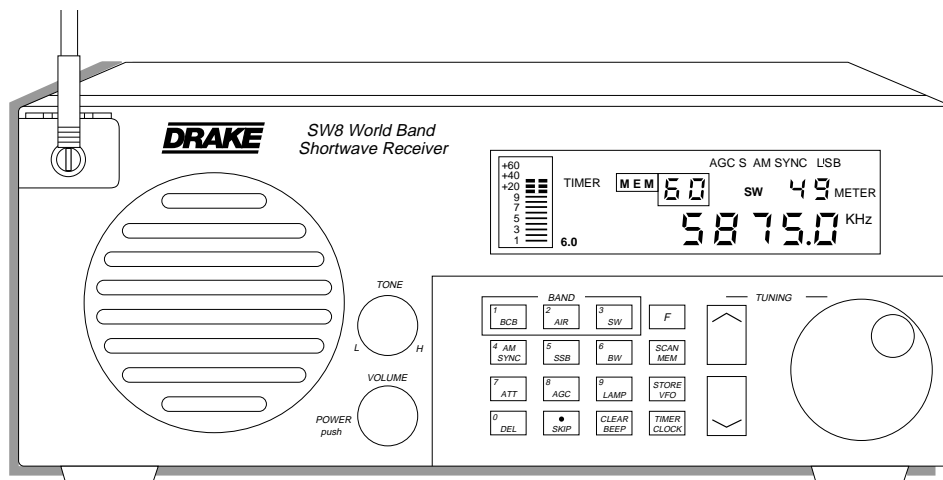

### MEMORY FUNCTIONS

The SW8 contains 70 memory locations that can be used to store and recall commonly monitored frequencies. These 70 locations are divided into blocks of 10, ie. 00-09, 10-19, 20-29, etc. This allows convenient grouping of frequencies. As an example, 00-09 could be AM broadcast stations, 10-19 could be FM broadcast stations, 20-29 could be various time stations such as CHU and WWV, etc. With memory locations programmed, you can use the scan function to automatically monitor desired memory frequencies. The following operating parameters may be stored in any memory location:

- 1) Frequency
- 2) Mode
- 3) Bandwidth
- 4) AGC setting
- 5) Attenuator
- 6) Synchronous detector

### MEMORY LOCATION PROGRAMMING

First, be sure that the SW8 is in the VFO mode (MEM or SCAN not displayed). If required, press the  button to place unit in the VFO mode.

A) Select the desired frequency, mode, bandwidth, etc.

B) Press the  button and then the  button (switches keypad to the numeric mode). 'MEM' will light and the memory channel number will flash.

Within three seconds, enter a two-digit number from 00-69. A confirmation beep is heard.

C) The SW8 will return to the VFO mode and the last used memory location is displayed in the 'MEM' portion of the display.

### RECALLING A MEMORY LOCATION

To select a specific memory channel, press the  button and then enter a two digit number of the desired memory channel to be recalled. Make certain that the successive button depressions are made within 3 seconds of each other. Other memory channels may be selected by pressing the  button and entering two digit numbers. If a channel number is selected that is empty, 'Error' will flash.

The large rotary tuning control may be used to tune from the frequency that was stored in the selected memory channel. The 'MEM' symbol turns off, but the last memory channel number still shows. Pressing the  button, causes the receiver to return to the last selected memory channel number and the 'MEM' symbol turns on.

### DELETING A MEMORY LOCATION

Select the memory channel to be deleted as described in 'RECALLING A MEMORY LOCATION'. Press and hold the  button for three seconds. Beep will be heard to indicate that the contents stored in the selected memory channel number have been deleted.

The SW8 provides a time scan function of programmed memory channels using the **F** button and **SCAN MEM** button. Scan will begin and end within a 10 channel block of programmed memory channels as indicated by the most significant digit of the selected memory channel number.

Block Number	Memory Channel Scan Range
0	00 - 09
1	10 - 19
2	20 - 29
3	30 - 39
4	40 - 49
5	50 - 59
6	60 - 69

The receiver will stop at each programmed memory channel within the block for 5 seconds and then increment to the next memory channel. Memory channels that are programmed to be skipped will not be scanned. The 'SCAN' symbol will be displayed for the duration of the scan action. Scanning will continue until the **SCAN MEM** button is pressed again.

Example for SCAN:

Suppose that memory channels 30 through 39 are programmed and it is desired to scan these channels. To initiate the scan action,

Press the **SCAN MEM** button followed by the two-digit channel number entry (can enter 30 through 39 for this example).

Press the **F** button followed by **SCAN MEM**. The receiver will begin scanning from the selected memory channel and continue scanning in sequence: '30' - '31' - '32' - etc.

Press the **SCAN MEM** button to stop the scanning action.

Note that if channels 29 and 40 were stored, they would not be included in a scan of the channels starting with a '3' as the most significant digit of the channel number.

## MEMORY CHANNEL SKIP

A memory channel can be skipped for scan operations. While in the MEMORY mode, press the **SKIP** button. The display will indicate that the 'SKIP' function has been stored for that particular memory channel number. An 'S' will be displayed to the right of the memory channel number on the display. Repeat the same sequence as described to remove the 'SKIP' function from a memory channel number.

Example for MEMORY CHANNEL 'SKIP':

Refer to the previous example on this page. Suppose it is desired to skip the memory channel number '34' from the scan action:

From the normal variable frequency tuning and reception mode (VFO) or from the Memory mode, press the **SCAN MEM** button followed by the two-digit number '34'.

Press the **SKIP** button. An 'S' will illuminate to the right of the displayed '34'. When the scan action is initiated, all channel numbers 30 through 39, except 34, will be scanned. Note that the memory contents of channel 34 still remain, it is skipped over only in the scan sequence.

To allow channel 34 to again be included in the scan sequence,

Press the **SCAN MEM** button followed by the two-digit number '34'.

Press the **SKIP** button to remove the 'SKIP' function from channel 34 for this example. The 'S' indicator in the display will turn off.

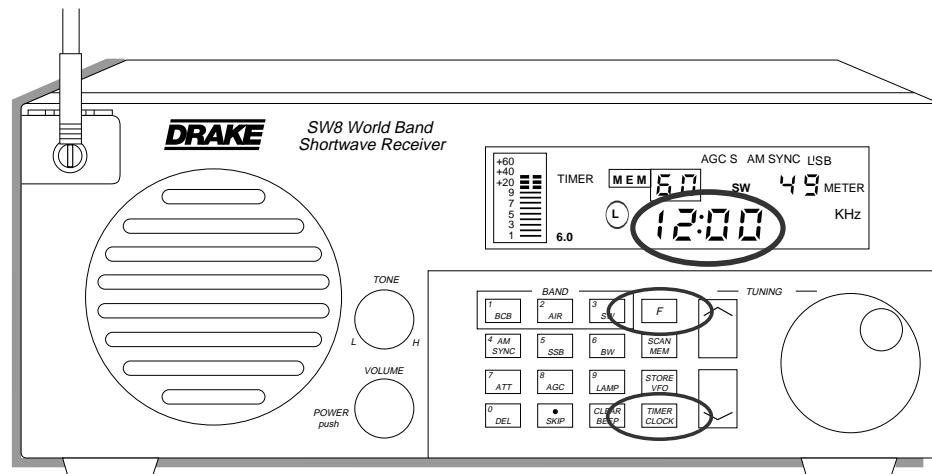

### TIME DISPLAY

The SW8 incorporates a dual time clock allowing two 24 hour clocks to be set and maintained. During loss of AC power, or during battery changing, clock operation is maintained for a period of approximately 30 minutes, if the SW8 has been connected to an AC power source or had the batteries installed for a minimum time of 10 minutes. The two-event timer functions are also derived from the last displayed clock, therefore the clocks must be set first for proper TIMER operation. TIMER Settings are also maintained through a power loss for a period of approximately 30 minutes.

Pressing the **TIMER CLOCK** button once will display the current time of the current clock. After approximately 3 seconds, the display will revert to the current frequency. Pressing and releasing the **TIMER CLOCK** button while time is being displayed will toggle the time display between the two clocks. Normally the clock accompanied by the 'L' on the display will be set with the local time, while the alternate clock will be set to display GMT (UTC) time.

The SW8 will display the selected clock when the **POWER** switch is turned off.

### SETTING THE 24 HOUR CLOCKS

Select local ('L') or alternate time clock by pressing the **TIMER CLOCK** button.

Press and hold the **TIMER CLOCK** button for three seconds until the colon begins flashing rapidly. If the 'L' is illuminated, you are setting the local clock. With no 'L' displayed, you are setting the alternate clock. The keyboard is automatically set up for the shifted ('F') function numeric digit entries in this clock setting mode. Either clock can be set first. Time is entered in a 24 hour format. Enter the time in 'HH:MM', with the 'colon' understood.

The **CLEAR BEEP** button can be pressed to erase erroneous entries.

Press the **F** button to start the clock when the actual time value agrees with the entered time. Colon will flash at one second intervals when clock is running.

Example for Local Clock Set:

With frequency displayed, suppose it is desired to set '13:01':

Press and hold the **TIMER CLOCK** button until the colon flashes rapidly.

Press the following sequence of numeric buttons:

**1** BCB      **3** SW      **0** DEL      **1** BCB  
 L 00:01      L 00:13      L 01:30      L 13:01

When the actual time is 13:01, Press the **F** button. The clock is now started.

### TIMER OPERATION

The SW8 includes two programmable event timers allowing the SW8 to turn ON or OFF at preset times. The timers may be used separately or together and may recall a currently displayed frequency, memory channel or a combination of both. In addition, programming only an OFF time provides a Sleep timer; programming only an ON time provides a Wake timer. **Note that the timers, when activated, respond to the last displayed clock.**

Programming the timers is a two step process. Step one is to set the ON and OFF times. Step two is to assign a frequency or memory channel to a timer. This assignment occurs when the desired timer is actually enabled.

### SETTING TIMER ON/OFF TIMES

Press the **F** button and then hold the **TIMER CLOCK** button for approximately 2 seconds until the 'TIMER' annunciator turns on and 'ON' flashes. The 'On' Time will also be indicated in the frequency portion of the display (same readout format as the clock) as well as the number '1' or '2' displayed to the right of the time. The number '1' or '2' indicates which one of the two event timers you are programming.

Press the desired numeric buttons to enter a new 'ON' time. Enter the time in 'HH:MM' and in 24 hour format.

Press the button to remove the 'On Time' to use the timer as a Sleep timer. For a Wake timer, program an 'On Time' and remove the 'OFF' time.

To set the 'OFF' time, Press the button again to display 'OFF' time.

Press the desired numeric buttons to enter a new 'OFF' time. Enter the time in 'HH:MM' and in 24 hour format.

Press the button to remove the 'OFF' time, if desired.

Press the button again to enter TIMER 2 'ON' time.

Press the button again to enter TIMER 2 'OFF' time.

Finally, press the button to save the settings and switch the display to normal readout values.

### 1) Example for Setting Timer '1'

With frequency displayed, suppose it is desired to set Timer '1' for a local ON Time: '16:59'  
OFF Time: '18:01'

Action:

Press and then hold .

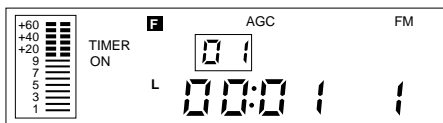

Press the button sequence: , , , .

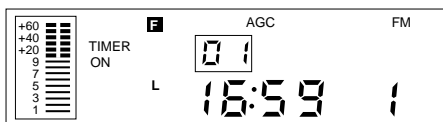

Press .

Press the button sequence: , , , .

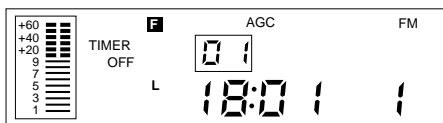

Press .

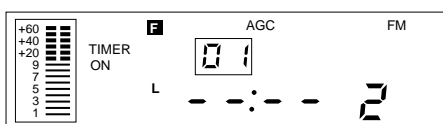

If it is desired to set 'Timer 2', use the same procedure as that for 'Timer 1', otherwise,

Press , to exit setting Timer operation and return to normal frequency display.

### ENABLING/DISABLING TIMER OPERATION

Press the button followed by the button. The 'TIMER' symbol will light in addition to either or both the timer '1' or timer '2' indication. After two seconds with no entry, the display reverts back to frequency readout.

Timer '1' can be disabled/enabled by pressing the numeric digit on the keypad while the timer enable display is showing.

Timer '2' can be disabled/enabled by pressing the numeric digit on the keypad while the timer enable display is showing.

Prior to enabling either or both timers, consider one of two possible cases for each timer:

eg.) - To Enable TIMER '1' —

1) '-' is displayed: Press the button to display '1'.

2) '1' is displayed: Press the button **twice** to again display '1'.

It is important to note that the timer is enabled only when the timer is deliberately changed from a '-' to '1', or '-' to '2'.

Even if the '1' or '2' is already displayed, the timer is not enabled unless the '-' to '1' or '2' transition occurs.

Setting a '-' for either timer **DISABLES** the respective timer.

### Timers '1' and '2' Enabled

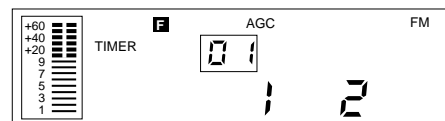

### Timer '1' Enabled; Timer '2' Disabled

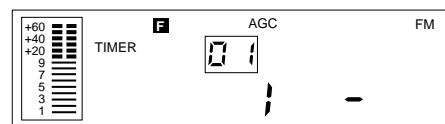

If either one or both the timer '1' or timer '2' are enabled, the TIMER symbol will continue to be displayed after the receiver is turned off. **Be certain to leave the volume setting at the desired level.** The receiver will automatically turn on and off as programmed. If both timers are disabled ('-' '-'), the timer programming in either or both timers is retained, but no TIMER action will take place until one or both are enabled.

## 2) Example for Setting Overlapping Events:

With frequency displayed, suppose it is desired to record a one hour program on one frequency with a beginning time of '16:59' and an ending time of '18:00'; and a second program on the same frequency with a beginning time of '18:00' and an ending time of '19:01'.

Action:

Press **F** and then Hold **TIMER CLOCK**

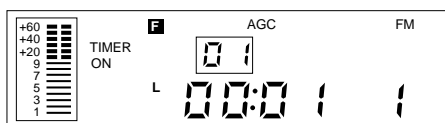

Press the button sequence: **BCB**, **BW**, **SSB**, **LAMP**

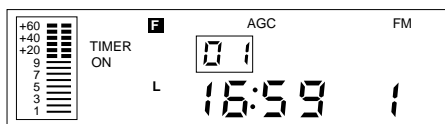

Press **TIMER CLOCK**

Press **CLEAR BEEP** (enters no OFF Time for timer '1')

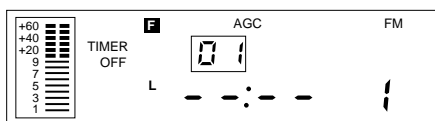

Press **TIMER CLOCK**

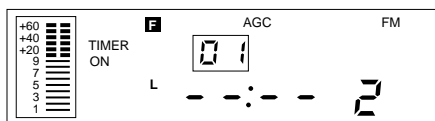

Press the button sequence: **BCB**, **AGC**, **DEL**, **DEL**

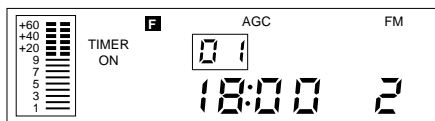

Press **TIMER CLOCK**

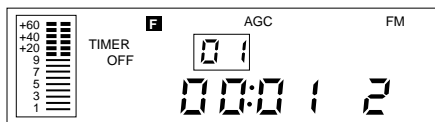

Press the button sequence: **BCB**, **LAMP**, **DEL**, **BCB**

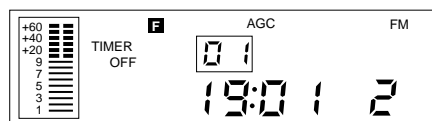

Press **TIMER CLOCK** for normal frequency display.

## 3) Example for Setting Events on Two Different Memory Channels:

eg.) PROGRAMMING MEM 08 in Timer '1';  
MEM 29 in Timer '2':

With frequency displayed,

Press **SCAN MEM** followed within two seconds by button sequence: **DEL**, **AGC**

Press **F** then **TIMER CLOCK** followed within 2 seconds by depression(s) of the **BCB** button until the '1' is displayed with 'MEM 08' indicated.

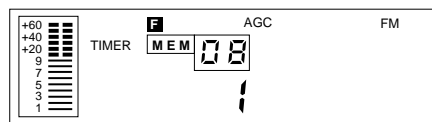

After 3 seconds, the display reverts to the frequency readout.

With frequency displayed,

Press **SCAN MEM** followed within two seconds by button sequence: **AIR**, **LAMP**

Press **F** then **TIMER CLOCK** followed within 2 seconds by depression(s) of the **AIR** button until the '2' is displayed with 'MEM 29' indicated.

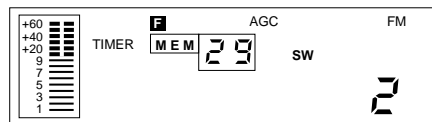



After 3 seconds, the display reverts to the frequency readout.

To set an event with no memory channel to be recalled, exit the memory mode before enabling the event. In this case, the SW8 maintains its current settings. Refer to 'ENABLING/DISABLING TIMER OPERATION' to enable or disable either of the two timers.

The SW8 has several special features that are referred to in the main body of this Owner's manual but may require additional explanation.



### **LOCK ALL ENTRY TO KEYPAD**

The receiver keypad and tuning control may be locked or disabled by pressing and holding the  button for 3 seconds.

Press the  button and hold for 3 seconds. Acknowledge beep will indicate that the keypad and tuning control are locked.

Repeat the procedure to unlock the keypad and tuning control.

### **10 kHz/9 kHz BROADCAST BAND TUNING STEP SIZE**

In the AM broadcast band, the SW8 increments the frequency in 10 kHz steps when pressing the  or  buttons.

The 10 kHz step size is practical for tuning the U.S. and Canadian broadcast bands. The step size can be changed to 9 kHz to permit practical tuning of European broadcast stations. The tuning step size is held in nonvolatile memory and thus is not lost during power failure or battery changing. To select the alternate step size,

With POWER OFF

Press and hold the  button while pressing the POWER button to put the SW8 in the POWER 'ON' mode.

If the step size was 10 kHz prior to performing the above procedure, then the 9 kHz step size for the broadcast band is now programmed. To change back to 10 kHz, repeat the same procedure.

### **DELETE ALL MEMORY CHANNELS**

If it is desired to delete all programmed memory channels, perform the following procedure:

With POWER OFF,

Press and hold the  button while pressing the POWER button to put the SW8 in the POWER 'ON' mode.

Hold the  button until a confirmation beep is heard to indicate that ALL memory locations have been cleared.

### **AUTOMATIC BANDWIDTH SETTING WITH MODE SELECTION DISABLE (ENABLE)**

The SW8 permits automatic setting of the bandwidth appropriate for each mode of detection. For example, the 6.0 kHz bandwidth would be selected automatically for AM mode operation; the 2.3 kHz bandwidth would be selected for SSB mode. Of course, pressing the  button temporarily overrides the automatic setting until a mode change is made. The setting, automatic or manual bandwidth selection with mode, is held in nonvolatile memory and is not lost during power loss or during battery changing. To disable the automatic bandwidth with mode,

With POWER OFF,

Press and hold the  button while pressing the POWER button to put the SW8 in the POWER 'ON' mode.

To enable the automatic bandwidth selection with mode operation, repeat the same procedure.



Most front panel pushbuttons perform two functions. The second function requires that the  button be pressed first, and then the desired second function button

Select normal frequency display (VFO) (pages 6,7) - -

Select Band (page 6, 8) - - - - -

Adjust Frequency (page 6) - - - - -

Select Mode (page 6) - - - - -

Select SYNChro (page 6) - - - - -

Select Bandwidth (page 6) - - - - -

Select AGC (page 7) - - - - -

Attenuator On or Off (page 7) - - - - -

Set Time (page 15) - - - - -





Display Time (page 15) - - - - -





Set Timer On/Off times (page 15-17) - - - - -





Activate (Enabling) Timer (page 16) - - - - -





Lock (Unlock) Controls (page 12) - - - - -



pressed within three seconds. The  symbol indicates that the button is to be pressed within three seconds.

Press   
Press  or  or 

Press  (toggles between AM and FM) or  or . With unit in 'SW', press   two or three digit entry from numeric keypad for Shortwave Meter band designation.

Select Band. Turn tuning wheel, Press  /  keys, or Press   numeric keypad.



Press  for displayed 'AM'.  
Press  to toggle to 'AM SYNC LSB'.  
Press  to toggle between 'USB' and 'LSB'.  
Turn synchronous detector off before selecting LSB or USB modes.  
Press  to toggle between the FM and AM broadcast bands.

With unit in 'AM' mode, press  for displayed 'AM SYNC LSB'.  
With unit in 'AM SYNC LSB' mode, press  to turn synchronous detector off.







Press  for displayed '6.0', '4.0' or '2.3' (not active in FM mode).







Press  for displayed 'S' or 'F' (not active in FM mode).

Press  for displayed 'ATT' or blank (not active in 'FM' or 'AIR' modes).

Press  to display either Local ('L') or alternate time.  
Press  and hold until colon flashes. Use keypad to enter time in 'HH:MM' format.  
Press  to start clock.

Press  (   to display alternate time).

   (hold) until 'TIMER ON' shows. Use keypad to enter On time for TIMER '1'. Press  again.  
Use keypad to enter Off time for TIMER '1'. Press  again.  
Use keypad to enter On time for TIMER '2'. Press  again.  
Use keypad to enter Off time for TIMER '2'. Press  again to leave the set mode.

     and/or 

Press  and hold until 'LOCK' is displayed. Pushbuttons and tuning wheel are inactive.

Lamp On/Off (page 7) -----

Press  to turn display backlight on or off.



Disable Beep (page 7) -----

Press  to enable or disable beep.



## MEMORY FUNCTIONS

Store Memory Channel (page 13) -----



Select bandwidth and adjust frequency.

  $\xrightarrow{3}$  . 'MEM' will light and channel number flashes,  $\xrightarrow{3}$  use keypad to enter two digit memory channel number from '00' to '69'.



Recall Memory Channel (page 13) -----

  $\xrightarrow{3}$  desired two digit number from numeric keypad or use ,  buttons.



Skip Memory Channel (page 14) -----

  $\xrightarrow{3}$  desired two digit number from numeric keypad.  
Press .

Delete a Memory Channel (page 13) -----

  $\xrightarrow{3}$  desired two digit number from numeric keypad.  
Press and hold  for 3 seconds.



Delete all Memory Channels (page 18) -----

With power off, press  while pressing the 'VOLUME (push)' button. Hold  until confirmation beep indicates all channel memory has been deleted.

## SCAN MODE

The SCAN feature only works with channels programmed within a block (page 14).

Scan Memory (page 14) -----

  $\xrightarrow{3}$  desired two digit number from numeric keypad to select the block to scan.  
Then   $\xrightarrow{3}$   to start scan.

## REAR PANEL CONTROLS

'MASTER POWER' On/Off (page 9) -----

Set switch to 'ON' position for normal control from front panel.  
Set switch to 'OFF' position to guard against accidental push of 'VOLUME (push) control on front panel turning on unit and discharging batteries (if installed).

Shortwave Antenna Select (page 9) -----

Select '1', '2' or 'WHIP' as desired. Connect appropriate antenna(s).

FM/AIR Antenna Select (page 9) -----

Select either 'EXTernal' or 'WHIP' as desired. Connect appropriate antenna.

Aircraft Band Squelch Control (page 9) -----

Adjust control counterclockwise until the background noise just quiets.

Downloaded by   
Amateur Radio Directory   
  
[www.hamdirectory.info](http://www.hamdirectory.info)

Air Squelch

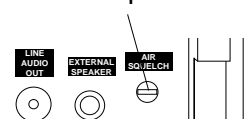

CHANNEL	STATIONNAME	FREQUENCY	MODE	BW	SMETER	AGC	SYNCHRO
00							
01							
02							
03							
04							
05							
06							
07							
08							
09							
10							
11							
12							
13							
14							
15							
16							
17							
18							
19							
20							
21							
22							
23							
24							
25							
26							
27							
28							
29							
30							
31							
32							
33							
34							

## 22 Memory Channel Log

CHANNEL	STATIONNAME	FREQUENCY	MODE	BW	SMETER	AGC	SYNCHRO
35							
36							
37							
38							
39							
40							
41							
42							
43							
44							
45							
46							
47							
48							
49							
50							
51							
52							
53							
54							
55							
56							
57							
58							
59							
60							
61							
62							
63							
64							
65							
66							
67							
68							
69							



1) ***Passport to World Band Radio***

Published by:  
International Broadcasting Services, Ltd.  
P. O. Box 300  
Penn's Park, Pennsylvania 18943

2) ***World Radio TV Handbook***

Published by:  
Billboard Publications Inc.  
1515 Broadway  
New York, NY 10036

3) ***The ARRL Antenna Book***

Published by:  
The American Radio Relay League  
225 Main Street  
Newington, CT USA 06111  
Copyright © 1988 by The American Radio Relay League  
Library of Congress Catalog Card Number: 55-8966

4) ***The ARRL Handbook***

Published by:  
The American Radio Relay League  
225 Main Street  
Newington, CT USA 06111  
Copyright © 1989 by The American Radio Relay League  
Library of Congress Catalog Card Number: 41-3345

- 1) **AC Input** - Alternating Current power source available at wall outlet sockets.
- 2) **AM** - Signals in which the information is conveyed by amplitude changes of the signal. Amplitude Modulation is used for the AM broadcast bands.
- 3) **AGC** - Automatic Gain Control which is employed in receivers to adjust the amount of gain in the receiver's circuitry to prevent distortion and maintain a nearly constant audio volume level over wide variations in received signal strength.
- 4) **Attenuation** - Loss, as applied in the text of this manual, added prior to the input stages of the receiver to reduce the level of very strong signals that may occur on certain bands, in certain locations, at certain times or a combination of all three factors. Each 10 dB (decibel) step reduces the power of the received signal by a factor of ten.
- 5) **CW** - Continuous Wave transmission signals. Actually, the signal is keyed on and off at precise intervals to convey information. Morse code is the most common CW signal.
- 6) **DC Input** - Direct Current power source such as is available from batteries or regulated power supplies.
- 7) **Dynamic Range** - Ability of the receiver to faithfully reproduce high quality audio over a wide range of signal strength conditions - from very weak signals to very strong signals.
- 8) **Frequency** - Rate of reoccurrence in hertz or cycles/second of electromagnetic wave or carrier.
- 9) **FM** - Signals in which the information is conveyed by frequency changes of the signal. Frequency Modulation is used for the FM broadcast bands.
- 10) **Electronically Switched Filter** - A multi bandwidth filter with high adjacent channel attenuation switched electronically.
- 11) **GMT** - Greenwich Mean Time.
- 12) **HF** - High Frequency band extends from approximately 1.5 MHz to 30 MHz.
- 13) **LCD - Liquid-Crystal Display** - Low power consumption displays used for wristwatches and information displays on many types of electronic equipment.
- 14) **LSB - Lower Side Band** - The lower frequency portion, excluding the carrier, of an AM signal. A single-sideband signal, in this case the lower sideband, contains all of the modulation information of amplitude modulation in one half the bandwidth.
- 15) **RF** - Radio frequency
- 16) **RTTY** - Radio Teletype communications.
- 17) **Squelch** - A user controlled adjustment which mutes the audio output below a certain signal strength.
- 18) **Synchronous Detector** - An amplitude modulation detector which utilizes a replica of the original transmitted carrier signal to improve the reception of weak signals.
- 19) **Synthesized** - Capable of generating a large number of different output frequencies, all related to a single, highly stable reference source.
- 20) **Up Conversion** - A frequency conversion technique that translates an incoming RF signal to a higher frequency.
- 21) **USB - Upper Side Band** - The higher frequency portion, excluding the carrier of an AM signal. A single-sideband signal, in this case the upper sideband, contains all of the modulation information of amplitude modulation in one half the bandwidth. .
- 22) **UTC** - Universal Time Coordinated.
- 23) **VFO** - Variable Frequency Oscillator
- 24) **VHF** - Very High Frequency band extends from approximately 30MHz to 300 MHz.

<b>PROBLEM</b>	<b>PROBABLE CAUSE</b>	<b>SOLUTION</b>
Front panel clock display is showing but radio will not turn on	A) Rear panel 'MASTER POWER' switch	A) Check 'MASTER POWER' switch on rear panel and set to 'ON' position
No front panel display or lights	A) Power connection B) Defective AC adaptor unit C) Batteries are discharged or not installed for portable operation, no AC power	A) Check power supply cables B) Check AC ADAPTOR C) Check/install batteries for portable operation
No signals heard when antenna is connected or sensitivity is low	A) Incorrect antenna input selected B) RF <input type="checkbox"/> ATT enabled	A) Select correct antenna input B) Turn off RF <input type="checkbox"/> ATT
S meter indication but no sound heard	A) Improper mode selected B) External speaker connected but defective	A) Check mode selection B) Check external speaker
No front panel operation such as tuning, frequency entry etc.	A) Lock enabled	A) Press 'F' and hold for 3 seconds to unlock front panel
Timer does not operate	A) Clock(s) not set B) Timer not properly set  C) Alternate clock selected	A) Set clock(s) B) Set clock(s) program timer ON/OFF times C) Check that last displayed clock is the desired one for timer event



**SERVICE INFORMATION**

You may contact R. L. DRAKE Service Department for additional information or assistance by calling (513) 746-6990, Monday through Friday, 8:00 A.M. - 5:00 P.M. EST, except on holidays.

You may also contact the R. L. DRAKE Service Department by E-mail at the following address:  
bill\_frost@rldrake.com

or by Telefax:  
+1 (513) 743-4576.

Should you want to return your unit for service, package the receiver carefully using the original carton or other suitable container.

Write your return address clearly on the shipping carton and on an enclosed cover letter describing the service required, symptoms or problems. Also include your daytime telephone number and a copy of your proof of purchase.

The receiver will be serviced under the terms of the R. L. Drake Company Limited Warranty and returned to you.

**ONE YEAR LIMITED WARRANTY**

R. L. DRAKE COMPANY warrants to the original purchaser this product shall be free from defects in material or workmanship for one year from the date of original purchase.

During the warranty period the R. L. DRAKE COMPANY or an authorized Drake service facility will provide, free of charge, both parts and labor necessary to correct defects in material and workmanship. At its option, R. L. Drake Company may replace a defective unit.

To obtain such warranty service, the original purchaser must:

- (1) Complete and send in the Warranty Registration Card within ten (10) days of purchase.
- (2) Notify the R. L. DRAKE COMPANY or the nearest authorized service facility, as soon as possible after discovery of a possible defect, of:
  - (a) the model and serial number.
  - (b) the identity of the seller and the approximate date of purchase.
  - (c) a detailed description of the problem, including details on the electrical connection to associated equipment and the list of such equipment.
- (3) Deliver the product to the R. L. DRAKE COMPANY or the nearest authorized service facility, or ship the same in its original container or equivalent, fully insured and shipping charges prepaid.

Correct maintenance, repair, and use are important to obtain proper performance from this product. Therefore carefully read the Instruction Manual. This warranty does not apply to any defect that R. L. DRAKE COMPANY determines is due to:

(1) Improper maintenance or repair, including the installation of parts or accessories that do not conform to the quality and specification of the original parts.

(2) Misuse, abuse, neglect or improper installation.

(3) Accidental or intentional damage.

All implied warranties, if any, including warranties of merchantability and fitness for a particular purpose, terminate one (1) year from the date of the original purchase.

The foregoing constitutes R. L. DRAKE COMPANY'S entire obligation with respect to this product, and the original purchaser shall have no other remedy and no claim for incidental or consequential damages, losses or expenses. Some states do not allow limitations on how long an implied warranty lasts or do not allow the exclusions or limitation of incidental or consequential damages, so the above limitation and exclusion may not apply to you.

This warranty gives you specific legal rights and you may also have other rights which vary from state to state.

This warranty shall be construed under the laws of Ohio.



R. L. Drake Company  
230 Industrial Drive  
Franklin, Ohio 45005 U.S.A

CUSTOMER SERVICE AND PARTS TELEPHONE: +1 (513) 746-6990  
TELEFAX: +1 (513) 743-4576  
WORLD WIDE WEB SITE: <http://www.rldrake.com>

Downloaded by   
Amateur Radio Directory   
  
[www.hamdirectory.info](http://www.hamdirectory.info)