

**SECTION 2**

**INSTALLATION**

**2.1 INTRODUCTION**

The following paragraphs provide unpacking and inspection information, equipment installation and mounting instructions, site selection, interconnection data, and receiver functional test procedures.

**2.2 UNPACKING AND INSPECTION**

Carefully open the shipping carton and check the contents against the packing list secured to the outside of the container. Inspect all items for signs of damage. Immediately notify the carrier if any damage is discovered. Save all packing material for possible reshipment.

**2.3 ANCILLARY KIT**

Items that are supplied in the RF-590 Ancillary Kit, (part no. 10073-0021) are listed in table 2-1.

**Table 2-1. Ancillary Kit (P/N 10073-0021)**

Quantity	Part No.	Description
5	F03-0002-019	Fuse, 1 amp, slow blow
5	F03-0002-022	Fuse, 1-1/2 amp, slow blow
1	W-0023	Cord, Line, 6 feet
1	Z80-0001-000	Tool, Tuning

The following connectors are available to mate to the rear panel connectors (J7, J8, and J9).

J22-0001-001	Connector, Type D, 25 pin
J22-0010-000	Connector, Type D, 37 pin
J55-0015-825	Shell, D Connector*
J55-0015-837	Shell, D Connector*

\*Note: The two D connector shells are provided with various sized grommets to accommodate different sized cables.

## 2.4 SITE SELECTION

The RF-590 provides specified performance in any environment within the temperature range of -10°C to +55°C and up to 95 percent humidity. Consider the following factors when determining the operating location for the RF-590.

- Avoid sites which will subject the receiver to conditions exceeding those mentioned above. If this is not possible, provide an environmentally controlled site (adequate ventilation, temperature control, etc.) to maintain the stated operating limits.
- Avoid nearby obstructions such as hills, trees, buildings, and power lines which absorb and reflect radio signals. In particular, avoid obstructions that are in a direct line with the desired directions of reception.
- Some antennas, especially the doublet, are directional and should be oriented for maximum signal gain. Therefore allow enough land area around the site to orient the antenna as necessary.
- Reception is generally best at the top of a hill, over level ground, or over water.

Once the operating site has been chosen, consider the following factors when positioning the RF-590 at the site.

- Ease of operation and visibility of controls
- Relation to other units
- Power, control, and output interfaces
- Environmental considerations for unit and operator (temperature control, adequate ventilation, etc.).

**WARNING**

Always operate the RF-590 with a heavy gauge ground strap connected from a solid earth ground to the RF-590 rear panel ground lug (provided for this purpose). Failure to do so could result in serious injury or death to the operator if the receiver should ever fail in such a manner as to make the chassis electrically hot.

### 2.4.1 Antennas

Maximum receiver sensitivity is achieved when the antenna input impedance presented at antenna input connector, J1, is 50 ohms. The use of coaxial cables, such as type RG-58/U terminated with a BNC connector, prevents feed-line noise pickup and provides the proper impedance match.

Doublet antenna kits, such as the RF-334 and SB-AD, are available from Harris Corporation/RF Communications. Three basic types of antennas, the horizontal doublet, the inverted V, and the slant wire can be constructed with these kits. Figure 2-1 shows these three antenna types used in typical installations. Each type of doublet antenna has two legs of equal length, one connected to the center conductor of the coaxial cable and the other connected to the shield. The two legs have a combined electrical length of one-half wavelength (one-quarter wavelength for each leg).

The inverted V and slant wire doublets are useful if the antenna site prohibits the use of the two supports required for a horizontal doublet, or if the supports cannot be located so that the doublet is perpendicular to the direction of the desired transmitted signal. All doublet antennas are directional and provide best response to signals received from directions perpendicular to their lengths. The length of each element of a doublet can be determined from one of the formulas given in table 2-2.

**Table 2-2. Calculation of Doublet Antenna Element Lengths**

Antenna Type	Length of Each Element (Feet)	Length of Each Element (Meters)
Doublet, horizontal, or slanted	$\frac{234}{f(\text{MHz})}$	$\frac{71.3}{f(\text{MHz})}$
Inverted V doublet	$\frac{245}{f(\text{MHz})}$	$\frac{74.5}{f(\text{MHz})}$

## 2.5 INITIAL SETUP AND ADJUSTMENTS

The advanced design of the RF-590 Receiver minimizes initial setup and adjustment procedures. The initial setup and adjustment should include:

- Connecting memory backup battery
- Adjusting front panel display brightness
- Adjusting LSB and USB audio output levels

### CAUTION

Do not short out the memory backup battery terminals. This could result in severe circuit damage.

#### 2.5.1 Connecting Memory Backup Battery

A ni-cad battery is used to keep the RAM memory alive when power is removed from the receiver. The backup battery is located on the A14 Control Board assembly. The backup battery jumper must be

**HARRIS**  
RF COMMUNICATIONS

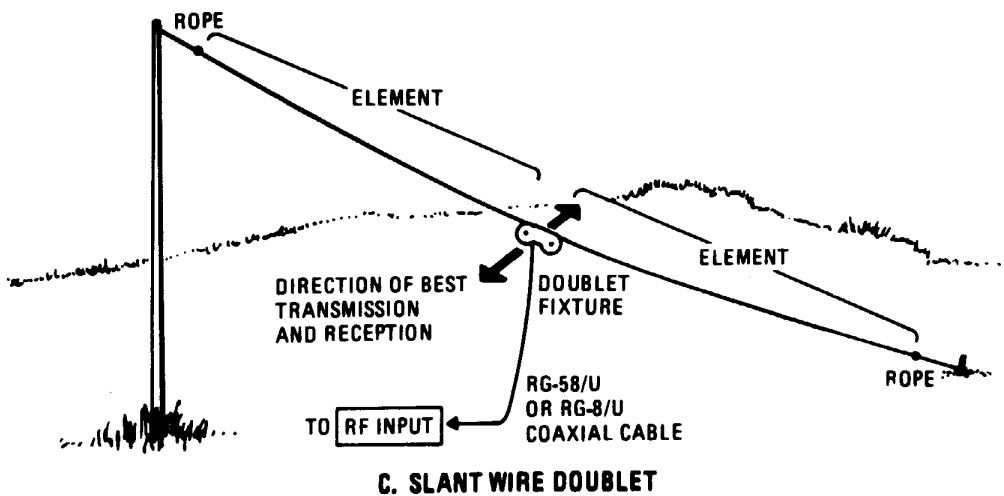
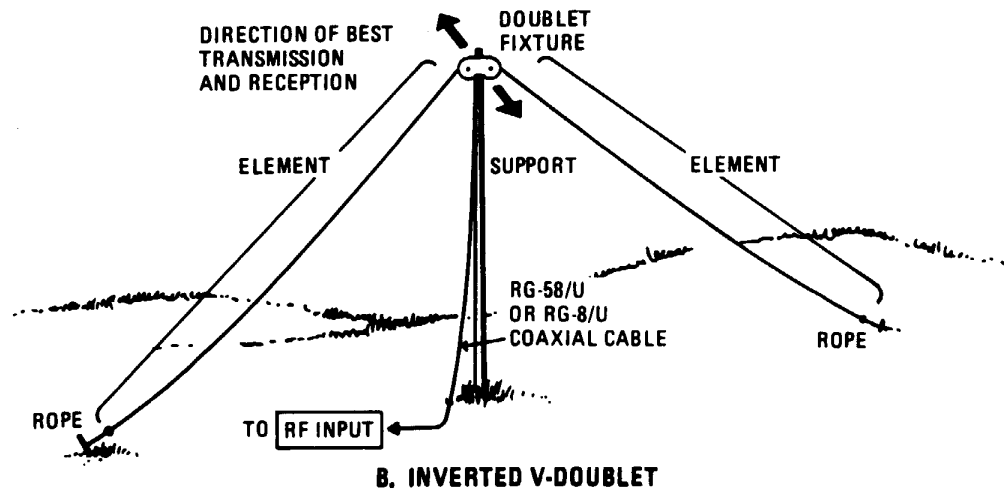
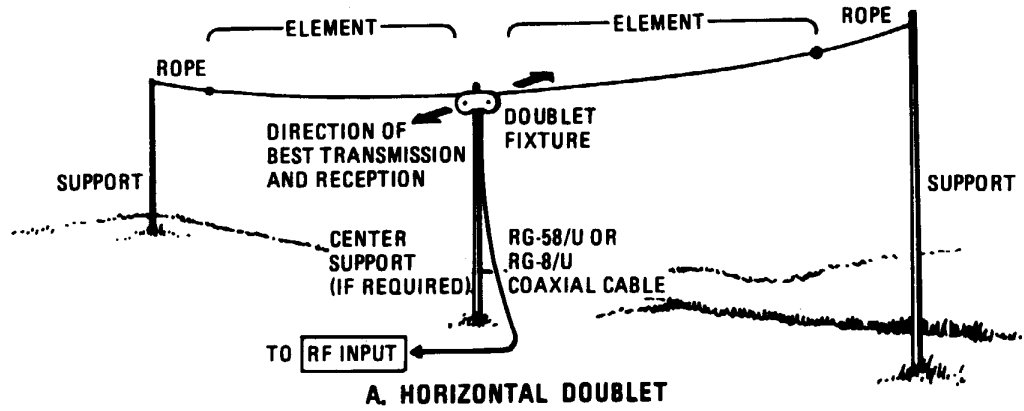

590-1

Figure 2-1. Typical Doublet Antenna Installation

inserted between E1 and E2 on the A14 Control Board assembly to activate the keep alive circuit. See subsection A14 for location of the assembly and the jumper.

### **2.5.2 Adjusting Front Panel Display Brightness**

Potentiometer R29 on Front Panel Driver Board assembly A13A2 is used to adjust the brightness of the vacuum fluorescent displays. R29 can be accessed by removing the top chassis cover or tilting the front panel assembly forward. R29 can be adjusted with a small screwdriver and is identified in subsection A13.

### **2.5.3 USB, LSB and Optional ISB Line Audio Output Level Adjust**

USB and LSB line audio output levels are adjustable from the front panel. Adjustment potentiometers are accessed through holes located next to the USB and LSB meter select pushbutton switches on the front panel.

Line audio output range is -16 to +10 dBm into 600 ohms.

## **2.6 POWER REQUIREMENTS**

The RF-590 requires 100, 120, 220, or 240 Vac, 47 to 420 Hz single phase power at 75 watts, nominally. Ac power selection is normally factory set to 120 Vac. To select a different range, first turn the front panel power switch off, then remove the ac power cord at the rear panel. Slide the plastic cover out of the way to expose the fuseholder and remove the fuse by pulling on the lever labeled FUSE PULL. Grasp the small PC card (located to the left of the fuseholder) with needlenose pliers and pull the card straight out. This card will be labeled with the numbers 100, 120, 220, and 240 Vac. For 220 V or 240 V operation, the fuse must be replaced with a 1.0 amp fuse (P/N F03-0002-019). Orient this card so that the desired range faces the fuseholder, and is the only number visible once the card has been reinserted. Reinsert the fuse and reconnect the power cord to the radio and the ac source. Turn the power on.

## **2.7 MECHANICAL INSTALLATION**

The RF-590 may be desk mounted (RF-594-02 option), see figure 2-2, stack mounted (RF-594-03 option) or rack mounted (RF-594-01 option) into a standard 19-inch equipment rack. See figure 2-3 for rack mounting information. Note that two different mounting brackets are supplied for rack mounting. PN 10073-1010 fits the left side of the RF-590 and PN 10073-1014 fits the right side. The detail drawing in figure 2-3 shows the left side bracket.

## **2.8 INPUT/OUTPUT CONNECTIONS**

The RF-590 is a complete receiver independent of all other equipment. It requires only the appropriate power and antenna connections. All other input/output connectors are used to expand and integrate features of the receiver or the system. RF-590 input and output connectors are shown and their uses explained in figure 2-4.

All RF type connectors are standard BNC, 50 ohm connections. Table 2-3 details the RF-590 local control functions available at TB1. Table 2-4 details the RF-590 local control functions available at J7. (Note that all of the TB1 inputs/outputs also appear at J7). Table 2-5 details the RF-590 remote control connectors J8 (RS-232) and J9 (RS-422).

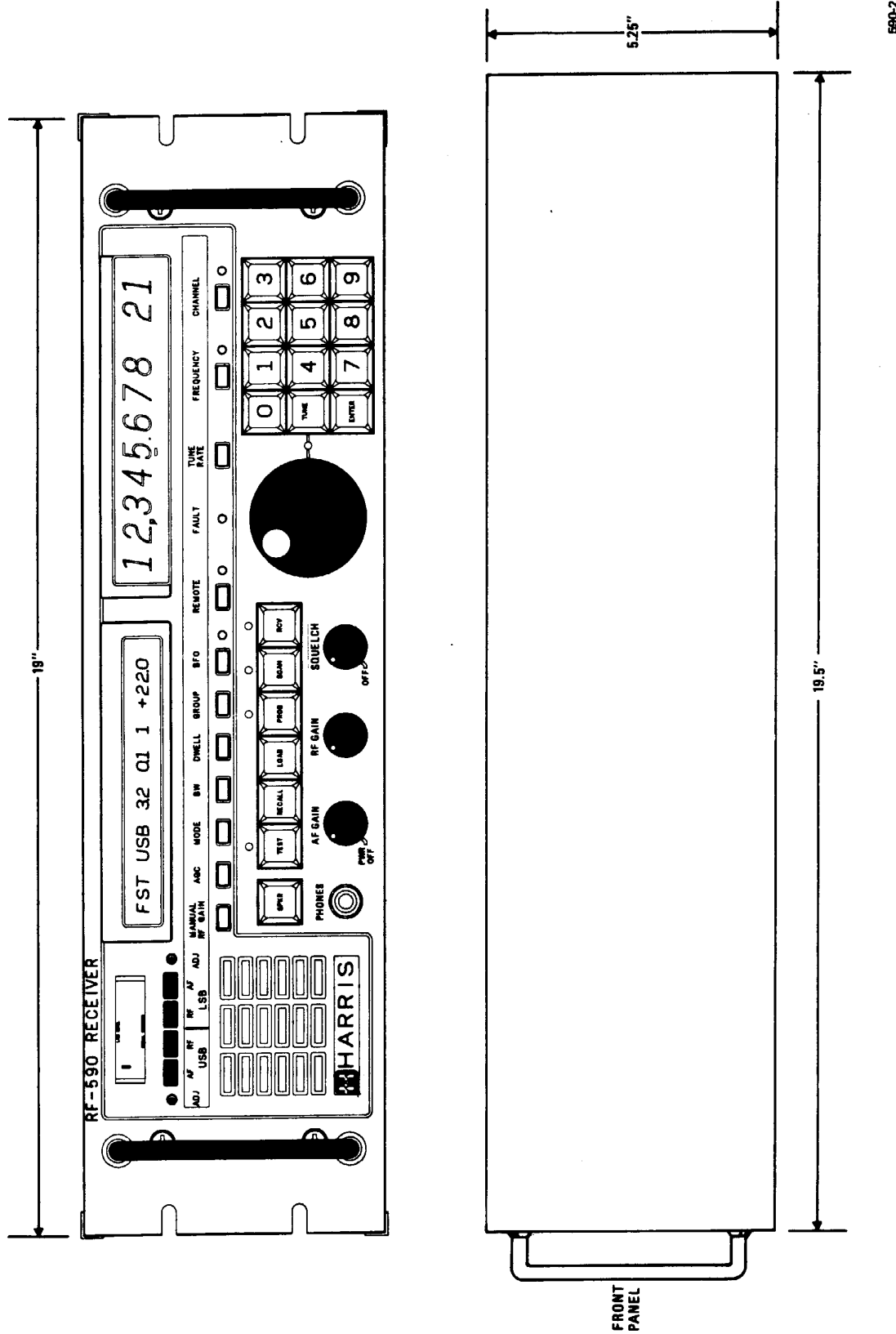

590-2

Figure 2-2. RF-590 Desk Mount Dimensions

**HARRIS**  
RF COMMUNICATIONS

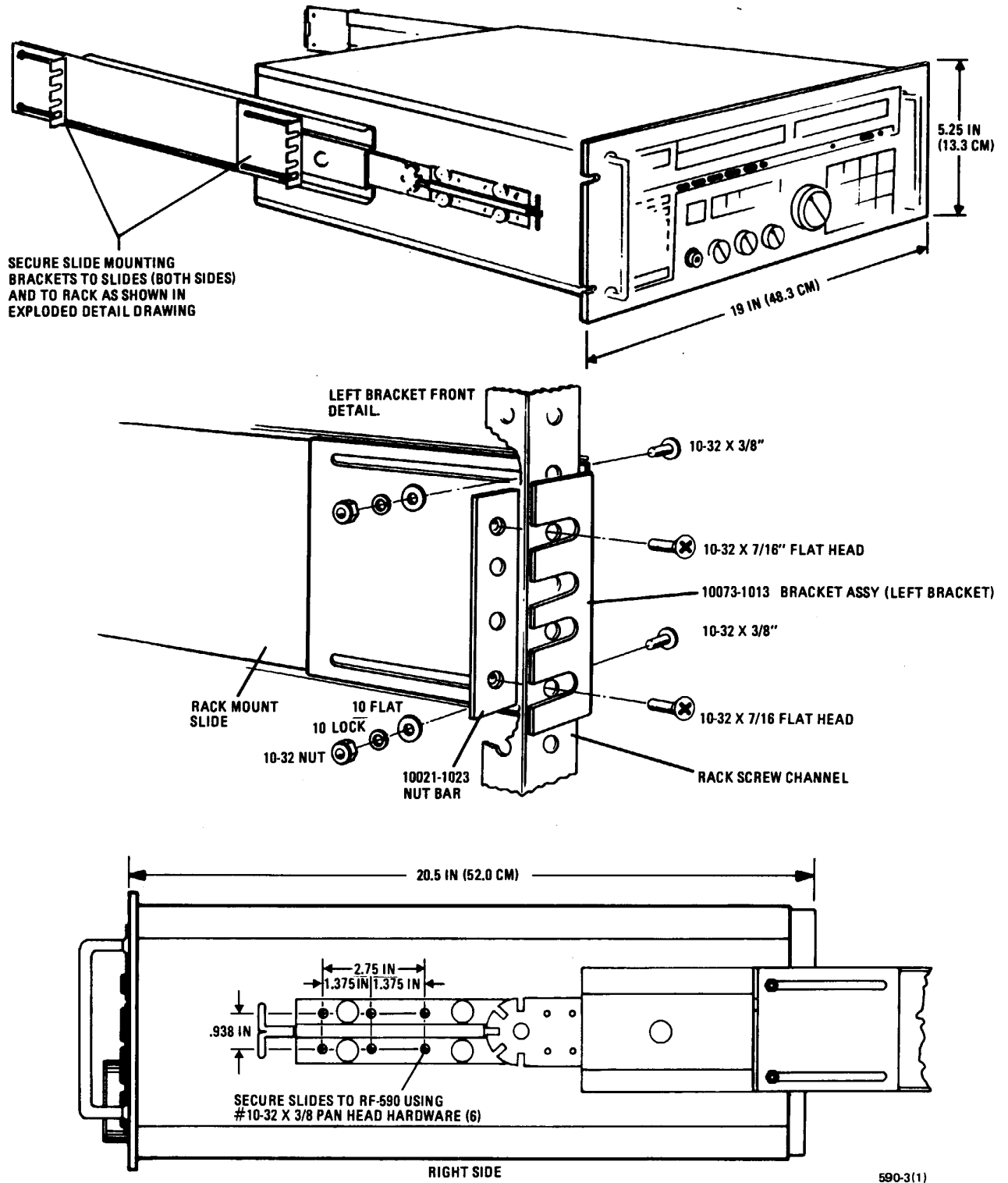

Figure 2-3. RF-590 Rack Mounting Details

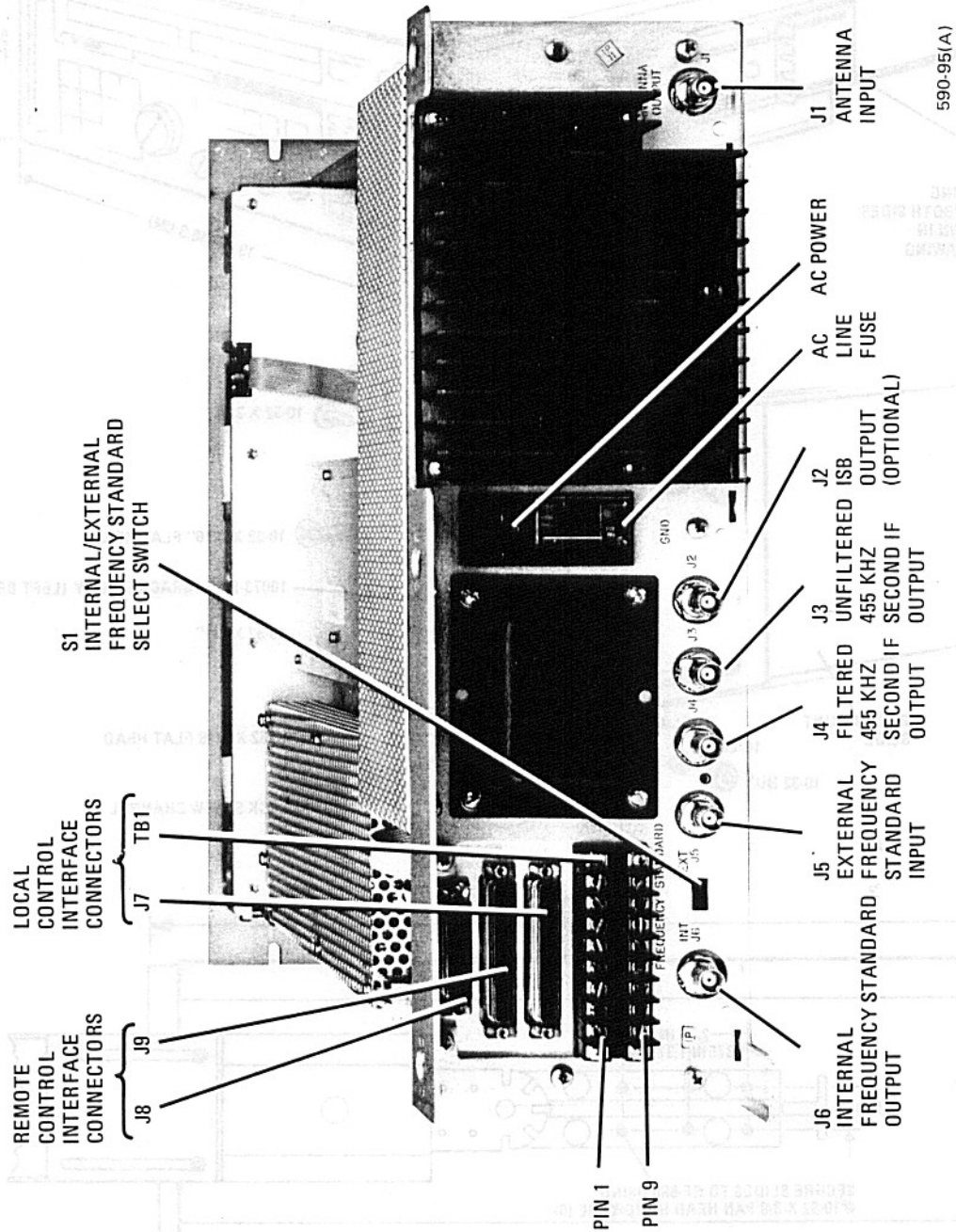

Figure 2-4. RF-590 Rear Panel



**Table 2-3. RF-590 Local Interface Terminal Board TB1**

Pin	Function
TB-1	GND
TB-2	USB AGC Dump
TB-3	USB AGC In
TB-4	Combined AGC
TB-5	ISB AGC Out
TB-6	ISB AGC Dump
TB-7	ISB AGC In
TB-8	Fault
TB-9	USB Line Audio
TB-10	USB Line Audio CT
TB-11	USB Line Audio
TB-12	USB AGC Out
TB-13	ISB Line Audio
TB-14	ISB Line Audio CT
TB-15	ISB Line Audio
TB-16	EXT Mute

**Table 2-4. RF-590 Local Control Interface Connector J7**

Connector and Pin	Function
J7-1	Remote Out 1
J7-2	GND
J7-3	Scan Step
J7-4	Remote Out 0
J7-5	Stop Scan
J7-6	Spare (To Control Board)
J7-7	Ext. Mute

**Table 2-4. RF-590 Local Control Interface Connector J7 (Cont.)**

Connector and Pin	Function
J7-8	ISB Line Audio
J7-9	ISB Line Audio CT
J7-10	ISB Line Audio
J7-11	USB AGC Out
J7-12	USB Line Audio
J7-13	USB Line Audio CT
J7-14	USB Line Audio
J7-15	Ext. Audio In
J7-16	Ext. Speaker GND
J7-17	Ext. Speaker Out
J7-18	Ext. Speaker Out
J7-19	Ext. Speaker GND
J7-20	Strobe 2
J7-21	Spare (To Control Board)
J7-22	Remote Out 2
J7-23	Strobe 1
J7-24	Clock
J7-25	Data
J7-26	Fault
J7-27	ISB AGC In
J7-28	ISB AGC Dump
J7-29	ISB AGC Out
J7-30	Combined AGC
J7-31	USB AGC In
J7-32	USB AGC Dump
J7-33	GND

**Table 2-4. RF-590 Local Control Interface Connector J7 (Cont.)**

Connector and Pin	Function
J7-34	Ext. Speaker GND
J7-35	Ext. Speaker Out
J7-36	Ext. Speaker Out
J7-37	Ext. Speaker GND

**Table 2-5. RF-590 Remote Control Interface Connectors J8 and J9**

Connector and Pin	Function
J8-1	Shield
J8-2	Tx Data 232/188C
J8-3	Rx Data 232/188C
J8-4	FSK Data Out -
J8-5	FSK Data In +
J8-6	ID0
J8-7	RS-232 Sig. GND
J8-8	ID1
J8-9	ID4
J8-10	Baud Rate 1
J8-11	Baud Rate 2
J8-12	N/C
J8-13	N/C
J8-14	Spare
J8-15	ID3
J8-16	ID2
J8-17	ID5
J8-18	ID6
J8-19	GND

**HARRIS**  
**RF COMMUNICATIONS**

Table 2-5. RF-590 Remote Control Interface Connectors J8 and J9 (Cont.)

Connector and Pin	Function
J8-20	Spare
J8-21	Spare
J8-22	Baud Rate 3
J8-23	Baud Rate 0
J8-24	N/C
J8-25	N/C
J9-3	Bus Req.
J9-4	RS-422 Out +
J9-6	RS-422 In +
J9-19	GND
J9-20	RS-422 In -
J9-21	Bus Available
J9-37	RS-422 Out -
<b>NOTE</b>	
All other J9 pins are spares with no internal connections.	

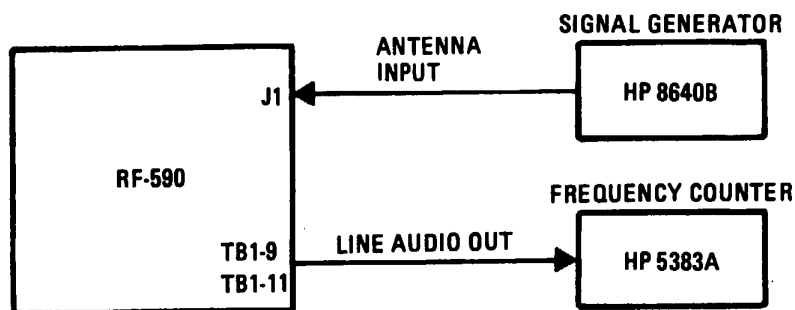

590-5

Figure 2-5. RF-590 Functional Test Setup

## 2.9 RF-590 FUNCTIONAL CHECKOUT PROCEDURE

The following is a local control functional test to determine the satisfactory operation of the RF-590. The following equipment (or equivalent) is required.

- HP-8640B Signal Generator
- HP-5383A Frequency Counter

The following paragraphs briefly describe RF-590 operation. The operator may find it useful to read section 3, Operation, prior to or concurrently with this procedure. Connect the above equipment as shown in figure 2-5.

### 2.9.1 Receive Mode Test

Apply the ac power and check that the receiver (under test) powers up with RCV (Receive), FREQUENCY, and TUNE LEDs lit.

Set the receiver to the following initial conditions:

- Mode: USB
- RF Gain: Fully clockwise (cw)
- AGC: MED
- Speaker: On

Connect the signal generator to the receiver's antenna input and set the generator for a level of -24 dBm (14.1 mVrms).

#### 2.9.1.1 Frequency Entry

Press the FREQUENCY button and enter a frequency of 12.345678 MHz via the keypad. Press ENTER. Set the signal generator to a frequency 1 kHz above the receiver tuned frequency (12.346678) and note the 1 kHz audible output tone. Connect the frequency counter to the line audio output and verify the audio frequency is 1 kHz.

#### 2.9.1.2 Tune Rate

Press TUNE RATE successively until the cursor is beneath the 1 kHz digit. Rotate the Tuning knob and use the signal generator to verify a tune range of 100 kHz  $\pm$ 20 percent per revolution.

Press TUNE RATE to place the cursor beneath the 100 Hz digit and use the signal generator to verify a 10 kHz per revolution  $\pm$ 20 percent tune range.

Press TUNE RATE to place the cursor beneath the 10 Hz digit and use the signal generator to verify a 1 kHz per revolution  $\pm 20$  percent tune range.

### 2.9.1.3 Mode Selection

Press the MODE button under the alphanumeric display and check that USB, LSB, CW, AM, and FM are selectable as modes. Keeping the button pressed causes the display to scroll through the valid modes. Release the button and the receiver is placed into the selected mode.

### 2.9.1.4 Bandwidth Selection

Press the BW button under the alphanumeric display and check that the bandwidth display scrolls through the filter selections that are valid for the selected mode. (Note that filter bandwidths are customer specified, and will vary depending on the requirements. A typical filter complement for different modes is shown in table 2-6).

**Table 2-6. Typical Filter Complement**

Mode	Bandwidth
USB	2.8 kHz
LSB	2.8 kHz
CW	0.3 kHz
CW	1.0 kHz
AM	3.0 kHz
AM	6.8 kHz
AM	16.0 kHz
FM	16.0 kHz

### 2.9.1.5 AGC Selection

Press the AGC button beneath the alphanumeric display and check that the AGC speed selection scrolls from SLOW, MEDIUM, FAST, or DATA.

### 2.9.1.6 BFO Selection

Select the USB mode, and press the BFO button to enable BFO entries. Check that the BFO LED lights and that keypad selections (followed by pressing ENTER) cause the BFO offset frequency to appear in the BFO display field.

Check that the Tuning knob varies the BFO selection when the TUNE LED is lit.

With the signal generator set for a frequency of 12.346678 and the receiver set at 12.345678, USB mode, tune the BFO via the Tuning knob to -1 kHz and check that a zero beat is obtained.

Return the BFO frequency to 0.00 kHz.

**2.9.1.7 RF Gain**

Press the AGC ON/OFF button under the alphanumeric display to select AGC OFF. Check that the AGC display changes to OFF and that the RF GAIN knob adjusts the gain. Push RF meter button to ensure that reading increases.

**2.9.1.8 AF Gain**

Rotate the AF GAIN knob and check that the volume is adjustable.

**2.9.1.9 Channelized Reception**

**NOTE**

Proceed to paragraph 2.9.2.1, Load Memory Function, and perform the steps listed there. Return to 2.9.1.9 after the four channels have been programmed.

With the receiver in the Receive mode (RCV LED lit), press the CHANNEL button. (CHANNEL LED should light.) Select each channel number (followed by ENTER) listed in table 2-7. Check that the receiver front panel updates to number listed. Using the signal generator, check that the receiver has in fact tuned to the frequency listed.

**Table 2-7. Programmed Channels**

Channel	Frequency MHz	AGC	Mode	Bandwidth kHz
01	01.111111	SLO	USB	2.8
02	02.222222	MED	LSB	2.8
03	03.333333	FST	CW	1.0
04	04.444444	MED	CW	1.0

With the TUNE and CHANNEL LEDs lit, rotate the Tuning knob. Check that channels 1-4 are selected.

**2.9.1.10 Speaker On/Off**

Check that the SPKR (SPEAKER ON/OFF) button alternately enables and disables the speaker.

### 2.9.1.11 Local/Remote Switch

The following test applies only if the remote option is installed in the receiver. If not, the REMOTE button will have no effect. With the receiver under local control, press the REMOTE button and check that the REMOTE LED lights and that it is no longer possible to change receiver parameters via the front panel. Make sure that by pressing the REMOTE button a second time, the receiver is placed back under local control.

### 2.9.1.12 Meter Switch

Set the receiver in the following conditions:

Frequency:	12.345678 MHz
Mode:	USB
AGC:	MED
RF Gain:	Fully clockwise (cw)
AF Gain:	As desired

Set the signal generator to a frequency of 12.346678 MHz and a level of -24 dBm (14.1 mVrms).

Press the USB/RF pushbutton under the meter. The meter indication should be approximately 14 mVrms.

Press the USB/AF pushbutton under the meter. The meter indication should be approximately 0 dBm.

Note that in the standard receiver, LSB and USB signals will be routed through the USB switch positions, and the ISB-LSB switch position will be inactive. If the ISB option has been installed, the USB positions select USB information and the ISB-LSB positions select LSB information.

### 2.9.1.13 Squelch Control

Set receiver as in paragraph 2.9.1.12. Verify receiver squelch action as the squelch control is varied. A reduction in speaker audio output should be noted.

## 2.9.2 Program Mode

### 2.9.2.1 Load Memory Function

The channel programming memory allows up to 100 channels to be stored. Press the PROGRAM button to place the receiver in the Program mode, and check that the PROGRAM and CHANNEL LEDs light. Perform the following steps:

- a. Enter 01 via the keyboard.



- b. Press FREQUENCY and enter 01.111111 MHz via the keyboard. Press ENTER.
- c. Select AGC-SLO, MODE-USB.
- d. Press LOAD.
- e. Press CHANNEL and enter 02 via the keyboard.
- f. Press FREQUENCY and enter 02.222222 MHz via the keyboard. Press ENTER.
- g. Select AGC-MED, MODE-LSB.
- h. Press LOAD.
- i. Press CHANNEL and enter 03.
- j. Push FREQUENCY and enter 03.333333 MHz. Press ENTER.
- k. Select AGC-FAST, MODE-CW, BW-1.0 kHz.
- l. Press LOAD.
- m. Press CHANNEL and enter 04.
- n. Press FREQUENCY and enter 04.444444 MHz. Press ENTER.
- o. Select AGC-MED, MODE-CW, BW-1.0 kHz.
- p. Press LOAD.
- q. Press RECEIVE to leave the Program mode.

Perform the steps in paragraph 2.9.1.9, Channelized Reception, to check that the channels were in fact programmed.

### **2.9.2.2** Recall Memory Function

Place the receiver in the Program mode. Enter 02 via the keyboard and press RECALL. The display should update to 02.222222 MHz, CHANNEL-02, AGC-MED, MODE-LSB.

### **2.9.2.3** Program Group Function

Group programming of channels allows the preprogramming of up to 10 channel groups (20 channels per group maximum). Channels may be programmed in any order and any channel can appear in more than one group.

To program a group, place the receiver in the Program mode and perform the following steps:

- a. Press GROUP.
- b. Enter 1 digit via the keyboard in response to the prompt GROUP NUMBER?. Press ENTER.
- c. Enter 03 via the keyboard in response to the prompt CHANNEL NUMBER?, and press ENTER and LOAD. The display will respond with 03 OK.
- d. Enter 02, followed by ENTER and LOAD.
- e. Enter 01, followed by ENTER and LOAD.
- f. Exit programming by pushing RECEIVE.
- g. Proceed to 2.9.3. Verification of Group programming will be done during the Group scan test.

### 2.9.3 Scan Mode Test

The following two scan modes are available on the RF-590.

- Channel scan
- Group scan

Channel scan allows the automatic sequential scanning of up to 100 preprogrammed channels. Group scan allows scanning of up to ten groups (20 channels per group, maximum). Follow the steps in paragraph 2.9.3.1 to perform a Channel scan and the steps in 2.9.3.2 to perform a Group scan.

#### 2.9.3.1 Channel Scan

- a. With the receiver in RECEIVE MODE, press SCAN. SCAN LED should light.
- b. Press CHANNEL in response to GROUP or CHANNEL SCAN?.
- c. Enter 01 followed by ENTER in response to FIRST CHANNEL?.
- d. Enter 04 followed by ENTER in response to LAST CHANNEL?. The receiver should commence to automatically scan channels 1-4. Press SCAN; verify that the scanning stops. Verify that pressing SCAN again restarts scanning. Verify that pushing the DWELL button affects the dwell speed accordingly.

### **2.9.3.2** Group Scan

- a. Push the RECEIVE button, then SCAN.
- b. Press GROUP in response to the GROUP or CHANNEL SCAN? prompt.
- c. Enter 1 digit via the keyboard, then ENTER. The receiver should now scan channels 3, 2, 1 in that order.

### **2.9.4** Self-Test (BITE)

Press the TEST button to begin the receiver's self-diagnostics. The receiver will perform an automatic self-test, approximately 5 seconds in length. During this time, all front panel display segments and LEDs should light, and stay lit until the message — — — TEST PASSED — — — appears in the left hand display.

In the event of a failure, a receiver fault code will be displayed. If this occurs, consult the maintenance section of this manual, table 5-1, which lists the fault codes by assembly number.