



INSTRUCTION MANUAL
IC-PS35
 INTERNAL POWER SUPPLY UNIT
 (DC13.8V 20A SWITCHING REGULATOR)

This instruction manual gives descriptions and installation instructions for the optional power supply unit for ICOM's HF transceiver IC-745 and IC-751. It also provides information you need while using them. Please read all the instructions carefully before installation so you will get maximum performance and full value from the set.

SPECIFICATIONS

Number of Semiconductors	Transistor	5
	IC	2
	Diode	4
Input Voltage	110/220V AC (50/60Hz)	
Allowable Voltage Fluctuation	±10% of input voltage (suitable line voltage)	
Input Capacity	550VA (at 20A load)	
Output Voltage	13.8V DC Negative ground	
Max. Load Current	20A (10 mins ON/10 mins OFF)	
Dimensions	194(W) x 50(H) x 186(D) mm	
Weight	Approx. 2.3kg	
Kit Included	Main Unit	1
	Insulation Spacer	1
	Power Socket Unit	1
	AC Power Cord	1
	Spare Fuse	2
	Installation Screws	6
	Insulation Washers	6

PREPARATION

Before performing any work on the set, make sure that the power cord is unplugged from the transceiver.

Remove the top and bottom covers by unscrewing the six screws each on the top and bottom, and the three screws on each side, while taking care not to damage the internal speaker, and unplug its connector.

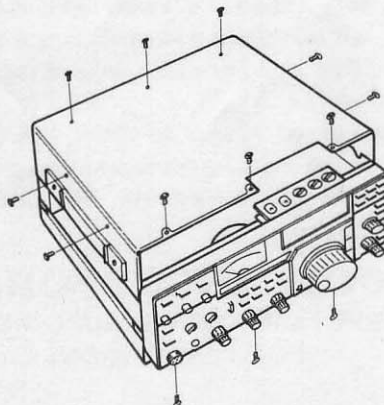

ASSEMBLY PROCEDURE

- ① Turn the transceiver upside down. The screws attached to the rear panel will be used later.
- ② Attach the main unit (power supply unit) to the rear panel using the supplied screws and insulating spacer between the main unit and the rear panel.

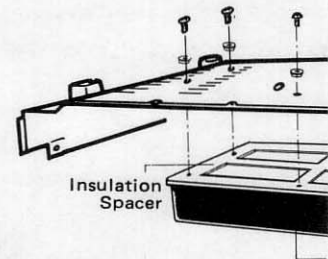

- ③ Pass the DC power cable through the AC power socket plate as shown in the diagram. Attach the AC power socket to the rear panel (A) before attaching the DC power socket (B) to the DC power socket connector (P1).

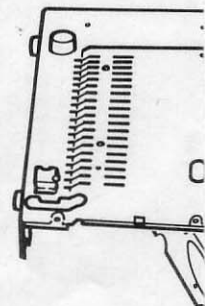
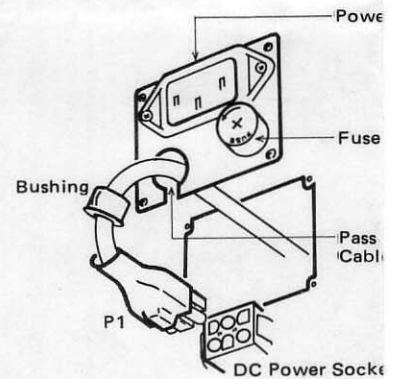

down. Remove the "PLATE (A)" by unscrewing four screws. These

supply) to the bottom cover with washers. At this time, insert the main unit and the bottom cover.

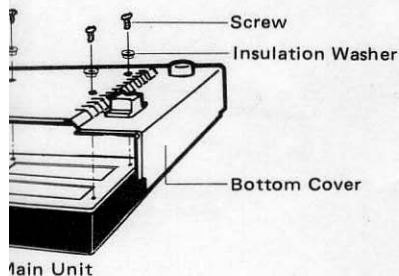

connected to P1 through the hole of the bottom cover in the illustration, then insert

the plate to the position which was removed, by using the screws described in the illustration. It is toward the bottom of the set.

Socket Unit

holder

to receive DC power through this hole.

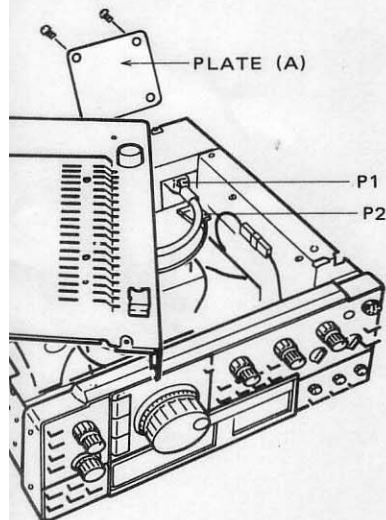

- ④ Pass the connector, P2', from the power socket unit to the inner chassis through the hole of the rear chassis. Then connect it with the connector, P2, from the main unit of the power supply.
- ⑤ Connect the internal speaker connector and replace the bottom and top covers of the set.
Plug P1 of the power supply unit to the DC Power Socket of the set.

OPERATION

1. Connect the DC output plug, P1, of this unit into the transceiver DC Power Socket securely. At this time, make sure that:
 - A. The power switch on the transceiver is OFF.
 - B. The T/R switch is in the RECEIVE position.
 - C. The PTT switch on the microphone is not depressed.
 - D. The VOX switch is in the OFF (out) position.
2. Connect the supplied AC power cord into the AC power socket (newly installed) on the rear panel of the transceiver. Then connect the AC power plug into an AC power outlet.

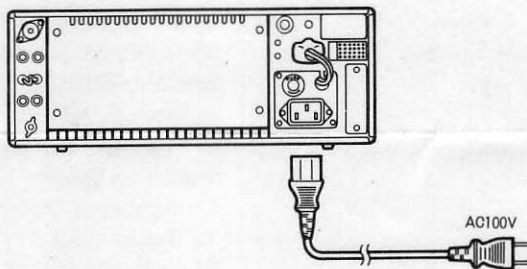

3. By turning the transceiver power switch ON, this unit will be turned ON and supply a DC 13.8V to the transceiver.

CAUTION

1. Ground the GROUND TERMINAL of the set with as short a wire as possible to prevent electrical shock, TVI, BCI and other problems.
2. This unit stops the output voltage with a protection circuit, when output voltage is shorted or consumed load current exceeds 25A. When the output voltage is stopped, turn the power switch of the transceiver OFF and remove the cause of the problem.
3. If the fuse blows, replace it with a 10A (at 117V) or 5A (at 240V) fuse after checking the cause of the problem. Use a Philips (+) screwdriver to open the holder. The outside ring of the holder cannot be rotated.

ICOM INCORPORATED

1-6-19, KAMIKURATSUKURI HIRANO-KU,
OSAKA JAPAN

A-0490
Printed in Japan



ICOM

ICOM AMERICA, INC.

Corporate Headquarters
2112 116th Ave. N.E., Bellevue, Washington 98004
Phone: (206) 454-8155 Telex: 152210

PS-35

PS-740 CONVERSION TO 230VAC

1. Remove the top cover from the PS-740.
2. Remove all screws which mount the PC board, transistors, and rectifier.
3. Move the jumper directly in front of L1 from the 110 to the 220 position.
4. Move the jumper which is located directly behind L2 from the 110 to the 220 position.
5. Remove the jumper which is strapped across the AC input leads of D1.
6. Install a 5 amp fuse in place of the 10A.
7. Replace the fan with a 220V version.

P535
to
220V

~~B-609Bに於て
1.2φ穴を
W3, W12に
裏側で線材
とSLを接続~~

P1-3 ← W3
P2-1 ← W12

* R370U-1に
W4, W5の穴に
挿入す。

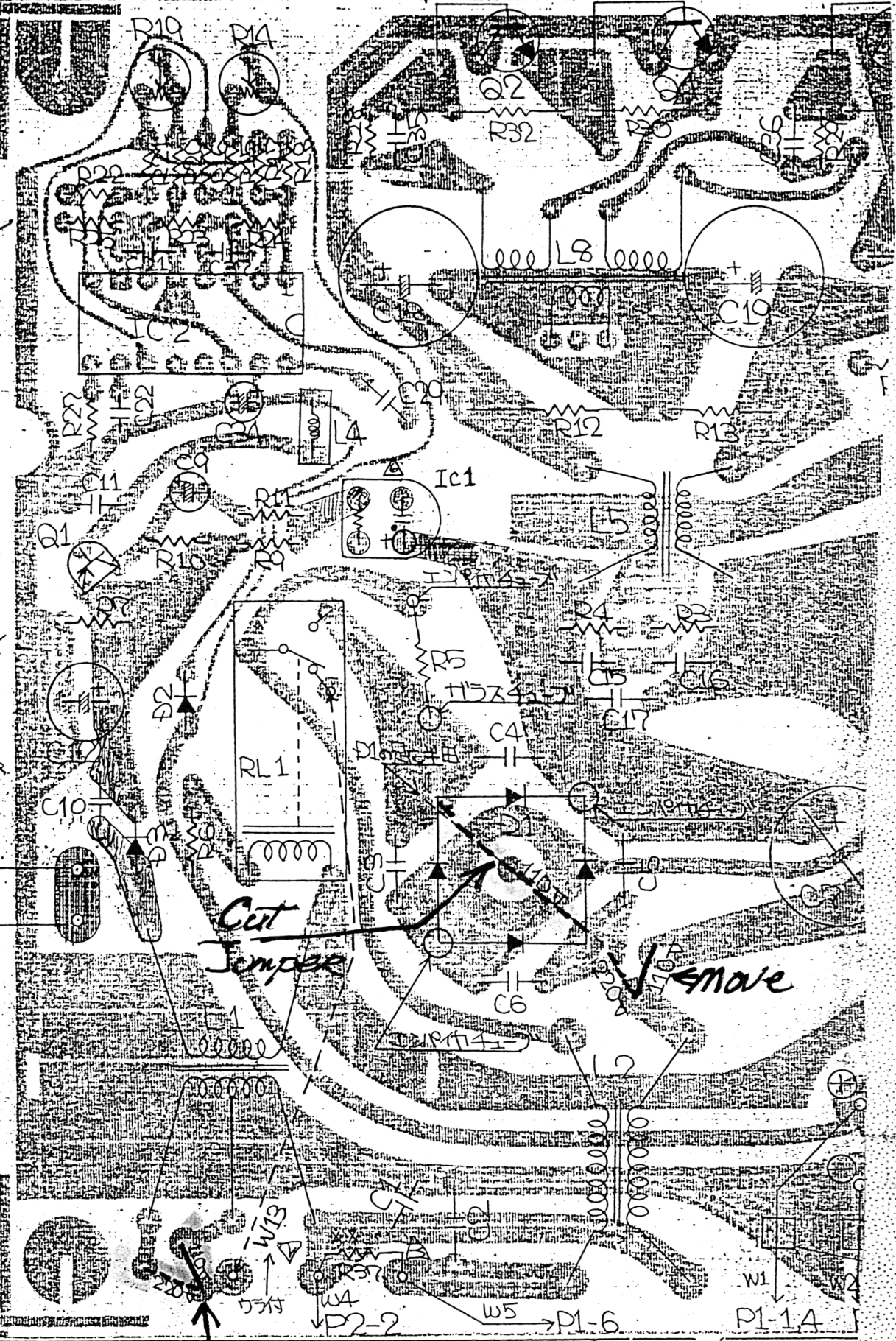

	A	B	C	D	E
1	83.5.21	1	8.7		
2	83.9.30	△6	8		