



# INSTRUCTION MANUAL

## HF/VHF/UHF ALL MODE TRANSCEIVER **IC-7000**



## IMPORTANT

**READ THIS INSTRUCTION MANUAL CAREFULLY** before attempting to operate the transceiver.

**SAVE THIS INSTRUCTION MANUAL.** This manual contains important safety and operating instructions for the IC-7000.

## FOREWORD

We understand that you have a choice of many different radios in the market place. We want to take a couple of moments of your time to thank you for making the IC-7000 your radio of choice, and hope you agree with Icom's philosophy of "technology first." Many hours of research and development went into the design of your IC-7000.

### ◆ FEATURES

- *IF DSP features*
- *All mode capability covering 160–2 m and 70 cm (depending on version)*
- *Compact with detachable front panel*
- *±0.5 ppm of high frequency stability*
- *Baudot RTTY demodulator*
- *Simple band scope function*
- *Selectable SSB transmission passband width (For both higher and lower pass frequency)*
- *Standard voice synthesizer/voice recorder*

Spurious signals may be received near the following frequencies. These are created in the internal circuit and does not indicate a transceiver malfunction:

52.76497 MHz,  
443.03535 MHz

## EXPLICIT DEFINITIONS

WORD	DEFINITION
<b>⚠ WARNING</b>	Personal injury, fire hazard or electric shock may occur.
<b>CAUTION</b>	Equipment damage may occur.
<b>NOTE</b>	If disregarded, inconvenience only. No risk or personal injury, fire or electric shock.

## SUPPLIED ACCESSORIES

The transceiver comes with the following accessories.

	<b>Qty.</b>
① Hand microphone (HM-151) .....	1
② DC power cable (OPC-1457) .....	1
③ Spare fuse (ATC 5 A) .....	1
④ Spare fuse (ATC 30 A) .....	2
⑤ ACC cable .....	1
⑥ 3.5 (d) mm plug .....	1
⑦ 6.5 (d) mm Electronic keyer plug .....	1
⑧ Microphone hanger .....	1

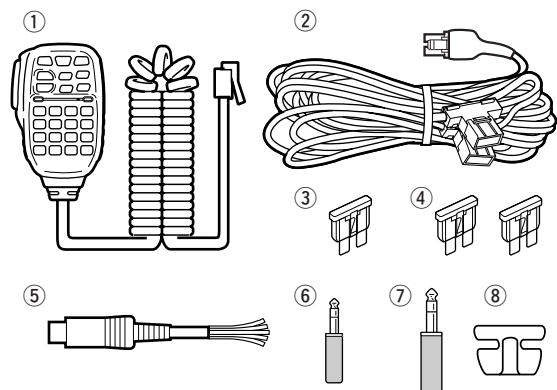

Icom, Icom Inc. and the Icom logo are registered trademarks of Icom Incorporated (Japan) in the United States, the United Kingdom, Germany, France, Spain, Russia and/or other countries.

**OPEN**  
**THIS PAGE**

# ILLUSTRATIONS

## Front panel

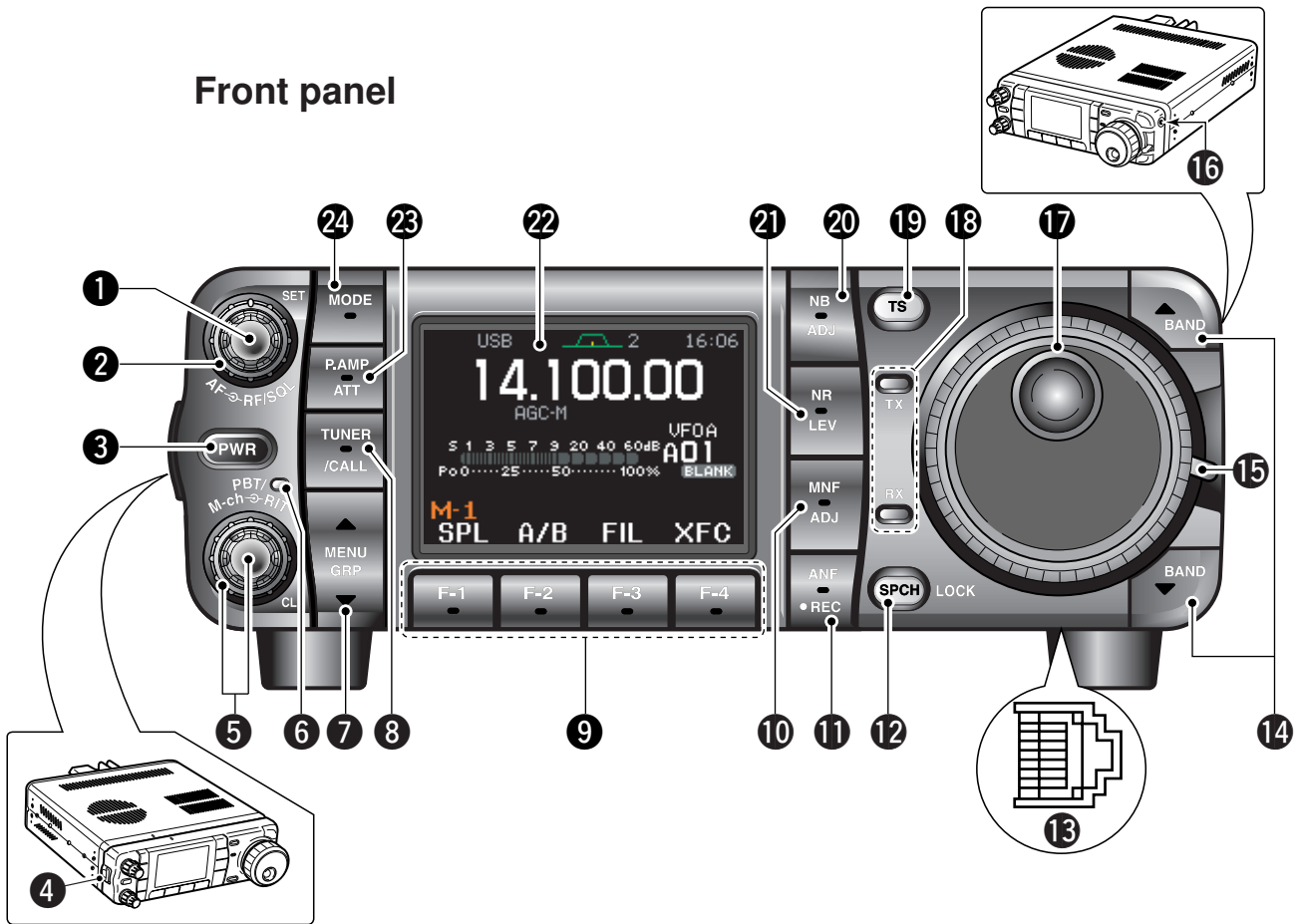

## HM-151

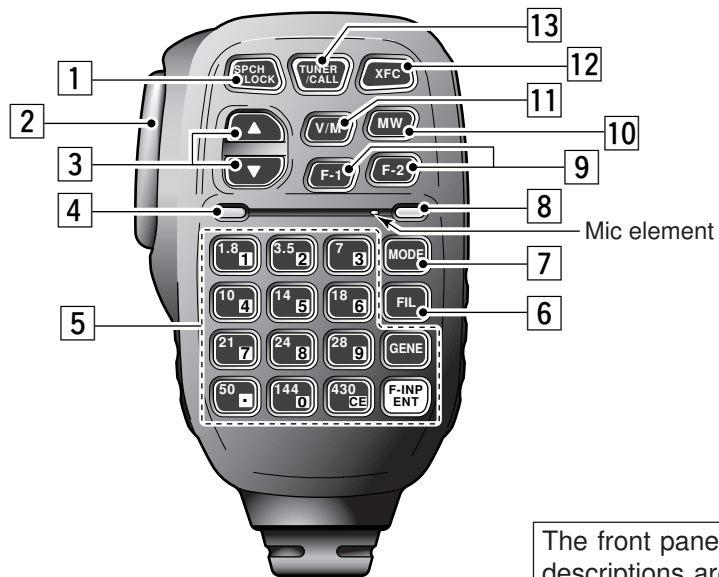

The front panel and HM-151's panel descriptions are described on pages 1 to 4, and on page 9, respectively (see the Chapter 1 (Panel description) for more details).

---

## ■ Front panel

- ① **AF GAIN CONTROL [AF]** (inner control; p. 33)
- ② **RF GAIN CONTROL/SQUELCH CONTROL [RF/SQL]** (outer control; p. 35)
- ③ **POWER KEY [PWR]** (p. 25)
- ④ **FRONT PANEL LATCH** (p. 16)
- ⑤ **PASSBAND TUNING/M-ch/RIT CONTROLS [PBT/M-ch/RIT]** (pgs. 73, 77, 86, 100, 104)
- ⑥ **TWIN PBT (M-ch/RIT) INDICATOR** (pgs. 73, 77, 86, 100)
- ⑦ **MENU/GROUP KEYS [MENU/GRP]** (p. 151)
- ⑧ **TUNER/CALL KEY [TUNER/CALL]** (pgs. 100, 114)
- ⑨ **MULTI-FUNCTION KEYS [F1]/[F2]/[F3]/[F4]** (pgs. 5–8, 151)
- ⑩ **MANUAL NOTCH KEY [MNF/ADJ]** (p. 81)
- ⑪ **AUTO NOTCH/VOICE RECORDER KEY [ANF/•REC]** (pgs. 80, 93)
- ⑫ **SPCH/LOCK KEY [SPCH/LOCK]** (pgs. 34, 37)
- ⑬ **MICROPHONE CONNECTOR** (p. 10)
- ⑭ **UP/DOWN (BAND) KEYS [▲(BAND)]/[▼(BAND)]**
- ⑮ **MAIN DIAL TENSION LATCH**
- ⑯ **HEADPHONE JACK [PHONES]** (p. 18)
- ⑰ **MAIN DIAL [DIAL]**
- ⑱ **RECEIVE/TRANSMIT INDICATORS [RX]/[TX]**
- ⑲ **TUNING STEP KEY [TS]** (pgs. 30–32)
- ⑳ **NOISE BLANKER KEY [NB/ADJ]** (p. 78)
- ㉑ **NOISE REDUCTION KEY [NR/LEV]** (p. 79)
- ㉒ **FUNCTION DISPLAY** (p. 13)
- ㉓ **PRE AMP/ATTENUATOR KEY [P.AMP/ATT]** (p. 72)
- ㉔ **MODE KEY [MODE]** (p. 34)

## ■ Microphone (HM-151)

- ① **SPCH/LOCK KEY [SPCH/LOCK]** (p. 34, 37)
- ② **PTT SWITCH [PTT]** (p. 37)
- ③ **UP/DOWN SWITCHES [▲]/[▼]**
- ④ **TRANSMIT INDICATOR** (p. 37)
- ⑤ **KEYPAD** (pgs. 28, 29)
- ⑥ **FILTER SELECTION [FIL]** (p. 75)
- ⑦ **MODE KEY [MODE]** (p. 34)
- ⑧ **POWER INDICATOR**
- ⑨ **PROGRAMMABLE FUNCTION KEYS [F-1]/[F-2]**
- ⑩ **MEMORY WRITE [MW]** (pgs. 101, 102)
- ⑪ **VFO/MEMORY SELECTION [V/M]** (pgs. 27, 100, 107)
- ⑫ **TRANSMIT FREQUENCY CHECK [XFC]** (pgs. 65, 89)
- ⑬ **TUNER/CALL KEY [TUNER/CALL]** (pgs. 100, 114)

---

## PRECAUTIONS

---

⚠ **WARNING RF EXPOSURE!** This device emits Radio Frequency (RF) energy. Extreme caution should be observed when operating this device. If you have any questions regarding RF exposure and safety standards please refer to the Federal Communications Commission Office of Engineering and Technology's report on Evaluating Compliance with FCC Guidelines for Human Radio Frequency Electromagnetic Fields (OET Bulletin 65).

⚠ **WARNING HIGH VOLTAGE! NEVER** touch an antenna or internal antenna connector during transmission. This may result in an electrical shock or burn.

⚠ **WARNING! NEVER** operate the transceiver while driving a vehicle. Safe driving requires your full attention—anything less may result in an accident.

⚠ **NEVER** apply AC power to the [DC13.8V] socket on the transceiver rear panel. This could cause a fire or damage the transceiver.

⚠ **NEVER** apply more than 16 V DC, such as a 24 V battery, to the [DC13.8V] socket on the transceiver rear panel. This could cause a fire or damage the transceiver.

⚠ **NEVER** let metal, wire or other objects touch any internal part or connectors on the rear panel of the transceiver. This may result in an electric shock or this could cause a fire or damage the transceiver.

⚠ **NEVER** connect or use the supplied HM-151 (microphone) with other transceiver. This could cause damage to the transceiver. The HM-151 is designed for use with the IC-7000 **ONLY**.

**NEVER** expose the transceiver to rain, snow or any liquids.

**AVOID** using or placing the transceiver in areas with temperatures below  $-10^{\circ}\text{C}$  ( $+14^{\circ}\text{F}$ ) or above  $+60^{\circ}\text{C}$  ( $+140^{\circ}\text{F}$ ). Be aware that temperatures on a vehicle's dashboard can exceed  $+80^{\circ}\text{C}$  ( $+176^{\circ}\text{F}$ ), resulting in permanent damage to the transceiver if left there for extended periods.

**AVOID** placing the transceiver in excessively dusty environments or in direct sunlight.

**AVOID** placing the transceiver against walls or putting anything on top of the transceiver. This will obstruct heat dissipation.

Place unit in a secure place to avoid inadvertent use by children.

During mobile operation, **NEVER** place the transceiver where air bag deployment may be obstructed.

During mobile operation, **DO NOT** place the transceiver where hot or cold air blows directly onto it.

During mobile operation, **DO NOT** operate the transceiver without running the vehicle's engine. When the transceiver's power is ON and your vehicle's engine is OFF, the vehicle's battery will soon become exhausted.

Make sure the transceiver power is OFF before starting the vehicle engine. This will avoid possible damage to the transceiver by ignition voltage spikes.

During maritime mobile operation, keep the transceiver and microphone as far away as possible from the magnetic navigation compass to prevent erroneous indications.

**BE CAREFUL!** The rear panel will become hot when operating the transceiver continuously for long periods.

**BE CAREFUL!** If a linear amplifier is connected, set the transceiver's RF output power to less than the linear amplifier's maximum input level, otherwise, the linear amplifier will be damaged.

Use Icom microphones only (supplied or optional). Other manufacturer's microphones have different pin assignments, and connection to the IC-7000 may damage the transceiver.

### ***For U.S.A. only***

**Caution:** Changes or modifications to this transceiver, not expressly approved by Icom Inc., could void your authority to operate this transceiver under FCC regulations.

# TABLE OF CONTENTS

<b>IMPORTANT</b> .....	i-1		
<b>FOREWORD</b> .....	i-1		
<b>EXPLICIT DEFINITIONS</b> .....	i-1		
<b>SUPPLIED ACCESSORIES</b> .....	i-1		
<b>ILLUSTRATIONS</b> .....	i-2		
■ Front panel .....	i-3		
■ Microphone (HM-151) .....	i-3		
<b>PRECAUTIONS</b> .....	ii		
<b>TABLE OF CONTENTS</b> .....	iii		
<b>1 PANEL DESCRIPTION</b> .....	<b>1–14</b>		
■ Front panel .....	1		
■ Multi-function keys .....	5		
◇ Menu M-1 functions .....	5		
◇ Menu M-2 functions .....	5		
◇ Menu M-3 functions .....	5		
◇ Menu S-1 functions .....	7		
◇ Menu S-2 functions .....	7		
◇ Menu S-3 functions .....	8		
◇ Menu G-1 (Scope) functions .....	8		
■ Microphone (HM-151) .....	9		
◇ Microphone connector .....	10		
■ Rear panel .....	11		
◇ DATA socket .....	12		
◇ ACC socket .....	12		
■ Function display .....	13		
<b>2 INSTALLATION AND CONNECTIONS</b> .....	<b>15–24</b>		
■ Unpacking .....	15		
■ Selecting a location .....	15		
■ Grounding .....	15		
■ Antenna connection .....	15		
■ Installation .....	16		
◇ Single body mounting .....	16		
◇ Stand .....	16		
◇ Front panel separation .....	16		
◇ Front panel mounting .....	16		
■ Required connections .....	17		
■ Advanced connections .....	18		
■ Power supply connections .....	19		
■ Connecting a DC power supply .....	19		
■ Battery connections .....	19		
■ External antenna tuners .....	20		
■ Linear amplifier connections .....	21		
■ Connections for CW .....	22		
■ Connections for RTTY .....	23		
◇ Connections for RTTY (FSK) .....	23		
◇ Connections for RTTY (AFSK) .....	23		
■ Connections for packet, SSTV or PSK31 .....	24		
◇ When connecting to [DATA] socket .....	24		
◇ When connecting to [ACC] socket .....	24		
◇ When connecting to [MIC] connector .....	24		
<b>3 BASIC OPERATION</b> .....	<b>25–38</b>		
■ When first applying power (CPU resetting) .....	25		
◇ Menu resetting (M-1) .....	25		
■ Initial settings .....	25		
■ VFO description .....	26		
◇ Differences between VFO and memory mode .....	26		
■ VFO operation .....	27		
◇ Selecting VFO A/VFO B .....	27		
◇ VFO equalization .....	27		
■ Selecting VFO/memory mode .....	27		
■ Selecting an operating band .....	28		
◇ Using the band stacking registers .....	28		
■ Frequency setting .....	29		
◇ Tuning with the main dial .....	29		
◇ Direct frequency entry with the microphone's keypad .....	29		
◇ Programmable tuning step .....	30		
◇ Selecting "kHz" step .....	30		
◇ Selecting 1 Hz or 10 Hz step (SSB/CW/RTTY only) .....	31		
◇ 1 MHz quick tuning step (FM/WFM/AM only) .....	31		
◇ ¼ tuning function (CW/RTTY only) .....	32		
◇ Auto tuning step function .....	33		
◇ Band edge warning beep .....	33		
■ Volume setting .....	33		
■ Operating mode selection .....	34		
■ Voice synthesizer function .....	34		
■ Squelch and receive (RF) sensitivity .....	35		
■ Meter function .....	36		
◇ Multi-function meter .....	36		
■ Lock functions .....	37		
◇ Dial lock function .....	37		
◇ Microphone lock function .....	37		
■ Basic transmit operation .....	37		
◇ Transmitting .....	37		
◇ Setting output power .....	38		
◇ Setting microphone gain .....	38		
<b>4 RECEIVE AND TRANSMIT</b> .....	<b>39–69</b>		
■ Operating SSB .....	39		
◇ Convenient functions for receive .....	39		
◇ Convenient functions for transmit .....	40		
◇ About 5 MHz band operation (USA version only) .....	40		
■ Operating CW .....	41		
◇ Convenient functions for receive .....	42		
◇ Convenient functions for transmit .....	42		
◇ CW reverse mode .....	43		
◇ CW side tone function .....	43		
◇ CW pitch control .....	44		
■ Electronic CW keyer .....	45		
◇ Memory keyer send menu .....	46		
◇ Editing a keyer memory .....	47		
◇ Contest number set mode .....	48		
1 Number Style .....	48		
2 Count UP Trigger .....	48		
3 Present Number .....	48		
◇ Keyer set mode .....	49		
1 Keyer Repeat Time .....	49		
2 Dot/Dash Ratio .....	49		
3 Rise Time .....	50		

# TABLE OF CONTENTS

4 Paddle Polarity .....	50	■ Noise reduction .....	79
5 Keyer Type .....	50	◇ Noise reduction set mode .....	79
6 MIC U/D Keyer (HM-103) .....	50	➔ NR Level .....	79
◇ Paddle operation from [MIC] connector .....	50	■ Notch function .....	80
■ Operating RTTY (FSK) .....	51	◇ Auto notch function .....	80
◇ Convenient functions for receive .....	52	◇ Manual notch function.....	81
◇ RTTY reverse mode .....	53	◇ Manual notch filter set mode .....	81
◇ Twin peak filter .....	53	■ Voice squelch control function .....	82
◇ Functions for the RTTY decoder indication ...	54	■ Meter peak hold function .....	82
◇ Setting the decoder threshold level .....	54		
◇ RTTY decode set mode .....	55	<b>6 FUNCTIONS FOR TRANSMIT ..... 83–92</b>	
1 RTTY Decode USOS .....	55	■ VOX function .....	83
2 RTTY Decode New Line Code .....	55	◇ Adjusting the VOX function .....	83
◇ Pre-setting for using RTTY terminal or TNC ...	56	◇ VOX set mode .....	84
■ Operating AM .....	57	1 VOX Gain .....	84
◇ Convenient functions for receive .....	57	2 Anti-VOX .....	84
◇ Convenient functions for transmit .....	58	3 VOX Delay .....	84
■ Operating FM .....	59	■ Transmit filter width setting (SSB only) .....	84
◇ Convenient functions for receive .....	59	■ Break-in function .....	85
◇ Convenient functions for transmit .....	59	◇ Semi break-in operation .....	85
◇ Tone squelch operation .....	60	◇ Full break-in operation .....	85
◇ DTCS operation .....	61	■ ΔTX function .....	86
◇ Tone scan operation .....	62	■ Monitor function .....	87
■ Repeater operation .....	63	■ Speech compressor .....	87
◇ One-touch repeater function .....	63	◇ Compression level setting .....	88
◇ Repeater tone frequency .....	64	➔ COMP Level .....	88
◇ Transmit frequency monitor check .....	65	■ Split frequency operation .....	89
◇ Auto repeater function (USA version only) ...	65	■ Quick split function .....	90
◇ Storing a non standard repeater .....	66	◇ Split offset frequency setting .....	91
■ 1750 Hz tone burst .....	67	◇ Quick split setting .....	91
■ DTMF memory encoder .....	67	■ Measuring SWR .....	92
◇ DTMF send menu .....	67	◇ Spot measurement .....	92
◇ Programming a DTMF code .....	68	◇ Plot measurement .....	92
◇ DTMF speed.....	68		
<b>5 FUNCTIONS FOR RECEIVE..... 69–82</b>		<b>7 VOICE RECORDER FUNCTIONS ..... 93–99</b>	
■ Simple band scope .....	69	■ Digital voice recorder .....	93
◇ Fix mode .....	70	■ Recording a received audio .....	93
◇ Center mode.....	71	◇ Basic recording .....	93
◇ Scope set mode .....	71	◇ One-touch voice recording.....	94
1 Max Hold .....	72	■ Playing the recorded contents .....	94
2 Scope Size .....	72	■ Erasing the recorded contents .....	95
3 FAST Sweep.....	72	■ Recording a message for transmit .....	96
4 FAST Sweep Sound .....	72	◇ Recording .....	96
■ Preamp and attenuator .....	72	◇ Confirming/Erasing the recorded message...	96
■ RIT function .....	73	■ Programming a memory name for transmit ...	97
■ AGC function .....	74	■ Sending a recorded message .....	98
◇ AGC time constant selection .....	74	◇ Transmit level setting .....	98
◇ Setting the AGC time constant .....	74	■ Voice set mode .....	99
■ IF filter selection .....	75	◇ Voice set mode .....	99
◇ IF filter selection .....	75	1 Auto Monitor .....	99
◇ Filter passband width setting		2 MIC Memo.....	99
(SSB/CW/RTTY/AM only) .....	76		
◇ IF filter shape (SSB/CW only) .....	76	<b>8 MEMORY OPERATION ..... 100–110</b>	
■ Twin PBT operation .....	77	■ Memory channels .....	100
■ Noise blanker .....	78	■ Memory channel selection .....	100
◇ Noise blanker set mode .....	78	■ Memory programming .....	101
1 NB Level .....	78	◇ Programming in VFO mode.....	101
2 NB Width .....	78	◇ Programming in memory mode .....	102
		■ Memory channel list .....	103

1

2

3

4

5

6

7

8

9

10

11

12

13

14

15

16

17

18

19

20

# TABLE OF CONTENTS

◇ Selecting a memory channel using the memory channel list.....	103
◇ Setting a memory channel as a select memory .....	104
◇ Selecting a memory bank .....	104
◇ Memory names .....	105
■ Memory clearing .....	106
◇ Memory clearing using the memory channel list.....	106
■ Frequency transferring.....	107
◇ Transferring in VFO mode .....	107
◇ Transferring in memory mode .....	108
■ Memo pads .....	109
◇ Writing frequencies and operating modes into memo pads .....	109
◇ Calling up a frequency from a memo pad ...	110
<b>9 SCAN OPERATION .....</b>	<b>111–113</b>
■ Scan types .....	111
■ Preparation.....	111
■ Programmed scan operation .....	112
■ Memory scan operation .....	112
■ Select memory scan operation .....	113
■ Priority watch .....	113
<b>10 ANTENNA TUNER OPERATION ...</b>	<b>114–115</b>
■ Optional AT-180 AUTOMATIC ANTENNA TUNER operation.....	114
◇ Tuner operation .....	114
◇ Manual tuning.....	114
■ Optional AH-4 AUTOMATIC ANTENNA TUNER operation.....	115
◇ AH-4 operation .....	115
<b>11 PACKET OPERATION .....</b>	<b>116</b>
■ Packet operation .....	116
◇ Data socket.....	116
◇ Adjusting the data speed .....	116
◇ Adjusting the transmit signal output from the TNC .....	116
<b>12 CLOCK AND TIMERS .....</b>	<b>117–119</b>
■ Time set mode .....	117
1 Year .....	117
2 Date .....	117
3 Time (Now) .....	117
4 CLOCK2 Function .....	117
5 CLOCK2 Offset .....	117
6 Auto Power OFF .....	117
◇ Setting the current year .....	118
◇ Setting the current date .....	118
◇ Setting the current time .....	118
◇ Clock2 function activity .....	119
◇ Clock2 offset setting .....	119
◇ Auto power OFF activity .....	119
<b>13 SET MODE .....</b>	<b>120–136</b>
■ Set mode description .....	120
■ Quick set mode .....	121
➤ RF Power (all modes) .....	121
➤ MIC Gain (SSB/AM/FM modes).....	121
➤ SSB TBW (WIDE) L (SSB mode) .....	121
➤ SSB TBW (WIDE) H (SSB mode) .....	122
➤ SSB TBW (MID) L (SSB mode) .....	122
➤ SSB TBW (MID) H (SSB mode) .....	122
➤ SSB TBW (NAR) L (SSB mode) .....	122
➤ SSB TBW (NAR) H (SSB mode) .....	122
➤ Key Speed (CW mode) .....	122
➤ CW Pitch (CW mode) .....	122
➤ Side Tone Level (CW mode) .....	123
➤ Side Tone Level Limit (CW mode).....	123
➤ Twin Peak Filter (RTTY mode) .....	123
➤ RTTY Mark Frequency (RTTY mode) .....	123
➤ RTTY Shift Width (RTTY mode) .....	123
➤ RTTY Keying Polarity (RTTY mode).....	123
■ Display set mode .....	124
1 Contrast (LCD).....	124
2 Bright (LCD) .....	124
3 LCD Unit Bright .....	124
4 LCD Flicker .....	124
5 Backlight (Switches) .....	124
6 Display Type.....	124
7 Display Font Type .....	125
8 Display Font Size .....	125
9 Meter Peak Hold .....	125
10 Filter Popup (PBT) .....	125
11 Filter Popup (FIL).....	125
12 1 Hz Mode Popup .....	125
13 Scope CENTER/FIX Popup .....	125
14 TV Popup (CH Up/Down) .....	126
15 TV Popup (P.AMP/ATT) .....	126
16 Voice TX Name Display .....	126
17 Keyer Memory Display .....	126
18 DTMF Memory Display .....	126
19 External Display .....	126
20 Opening Message .....	126
21 My Call .....	127
22 Power ON Check.....	127
■ Miscellaneous (others) set mode .....	128
1 Monitor .....	128
2 Monitor Level .....	128
3 Beep (Confirmation) .....	128
4 Beep (Band edge) .....	128
5 Beep Level .....	128
6 Beep Level Limit .....	128
7 RF/SQL Control .....	129
8 Quick SPLIT .....	129
9 SPLIT Offset.....	129
10 SPLIT LOCK.....	129
11 DUP Offset HF .....	129
12 DUP Offset 50M .....	129
13 DUP Offset 144M .....	130
14 DUP Offset 430M .....	130
15 One Touch Repeater .....	130
16 Auto Repeater .....	130



# TABLE OF CONTENTS

17 Tuner (Auto Start) .....	130	◇ Codes for memory name contents .....	147
18 Tuner (PTT start) .....	131	◇ Split/Duplex frequency setting.....	147
19 [TUNER] Switch .....	131	◇ Repeater tone/tone squelch frequency setting .....	147
20 VSEND Select .....	131	◇ DTCS code and polarity setting .....	147
21 SPEECH Level .....	131	<b>18 SPECIFICATIONS .....</b>	<b>148</b>
22 SPEECH Language .....	131	■ General .....	148
23 SPEECH Speed .....	131	■ Transmitter .....	148
24 SPEECH S-Level .....	132	■ Receiver .....	148
25 SPEECH [MODE] Switch .....	132	<b>19 OPTIONS .....</b>	<b>149–150</b>
26 Memopad Numbers .....	132	<b>20 MENU GUIDE .....</b>	<b>151–152</b>
27 SCAN Speed .....	132		
28 SCAN Resume .....	132		
29 MAIN DIAL Auto TS .....	132		
30 HM-151 [F-1] .....	133		
31 HM-151 [F-2] .....	133		
32 MIC Up/Down Speed .....	133		
33 Quick RIT/ΔTX Clear .....	133		
34 SSB/CW Synchronous Tuning .....	133		
35 CW Normal Side .....	134		
36 VOICE 1st Menu .....	134		
37 KEYER 1st Menu .....	134		
38 DTMF 1st Menu .....	134		
39 Mode Select (SSB) .....	134		
40 Mode Select (CW) .....	134		
41 Mode Select (RTTY) .....	134		
42 Mode Select (AM) .....	135		
43 Mode Select (FM) .....	135		
44 Mode Select (WFM) .....	135		
45 External Keypad (VOICE) .....	135		
46 External Keypad (KEYER) .....	135		
47 Front Keypad Type .....	136		
48 CI-V Baud Rate .....	136		
49 CI-V Address .....	136		
50 CI-V Transceive .....	136		
51 REF Adjust .....	136		
<b>14 MAINTENANCE .....</b>	<b>137</b>		
■ Fuse replacement .....	137		
■ Memory backup.....	137		
■ Cleaning .....	137		
<b>15 TROUBLESHOOTING .....</b>	<b>138–139</b>		
<b>16 OPTIONAL UNITS SETTING .....</b>	<b>140–141</b>		
■ MB-106 CARRYING HANDLE .....	140		
■ Band voltage modification .....	140		
■ AT-180 internal switch description .....	141		
<b>17 CONTROL COMMAND .....</b>	<b>142–147</b>		
■ Remote jack (CI-V) information .....	142		
◇ CI-V connection example.....	142		
◇ Data format.....	142		
◇ Command table .....	142		
◇ To send/read memory contents .....	146		
◇ Band stacking register .....	146		
◇ Codes for memory keyer contents .....	146		
◇ Character codes for My Call .....	147		

1
2
3
4
5
6
7
8
9
10
11
12
13
14
15
16
17
18
19
20

See the illustration of the Front panel on page i-2.

## Front panel

### 1 AF GAIN CONTROL [AF(SET)] (inner control; p. 33)

➔ Rotate to vary the audio output level from the speaker or headphones.

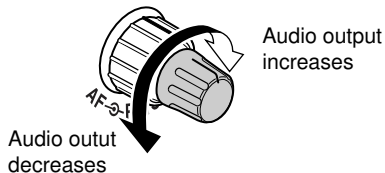

Push momentarily to enter the set mode menu.

• Push again to exit the set mode menu.

### 2 RF GAIN CONTROL/SQUELCH CONTROL [RF/SQL] (outer control; p. 35)

Adjusts the RF gain and squelch threshold level. The squelch, when closed, mutes the speaker or headphones when no signal is received, reducing noise.

• The squelch is particularly effective for FM mode. It is also available in other modes.

• 12 to 1 o'clock position is recommended for any setting of the [RF/SQL] control.

• The control can be set to 'Auto' (RF gain control in SSB, CW and RTTY; squelch control in AM, FM and WFM) or squelch control (RF gain is fixed at maximum) in the miscellaneous (others) set mode as follows. (p. 129)

MODE	SET MODE SELECTION		
	Auto	SQL	RF + SQL
SSB, CW RTTY	RF GAIN	SQL	RF + SQL
AM, FM WFM	SQL	SQL	RF + SQL

#### • When functioning as RF gain/squelch control

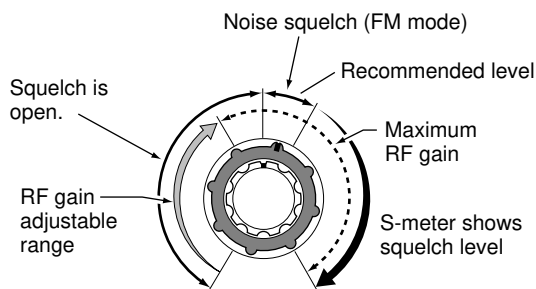

#### • When functioning as RF gain control

(Squelch is fixed open; SSB, CW, RTTY only)

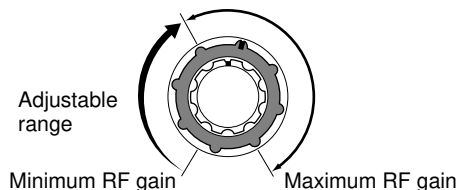

#### • When functioning as squelch control

(RF gain is fixed at maximum.)

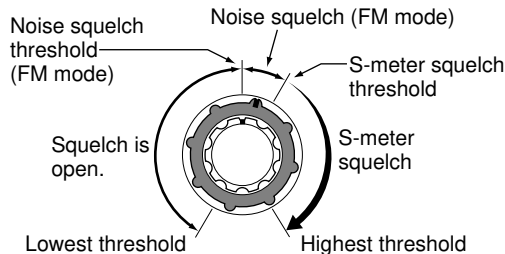

### 3 POWER KEY [PWR] (p. 25)

➔ While transceiver's power is OFF, push to turn the power ON.

• Turn the DC power supply ON in advance.

➔ While transceiver's power is ON, push and hold for 1 sec. to turn the power OFF.

### 4 FRONT PANEL LATCH (p. 16)

Pull away from the transceiver (towards yourself when looking at the front of the transceiver) to detach the front panel from the main body of the transceiver.

### 5 PASSBAND TUNING/M-ch/RIT CONTROLS [PBT/M-ch/RIT]

➔ Push inner control to toggle the twin Passband Tuning (PBT) or memory channel/RIT function ON and OFF.

➔ While Twin PBT is selected (p. 77):

● Adjusts the receiver's DSP filter passband width.

• Passband width and shift frequency are displayed on the LCD.

• The default variable range is half of the IF filter passband width. 25 Hz step is available.

● Push and hold inner control for 1 sec. to return the PBT to default settings.

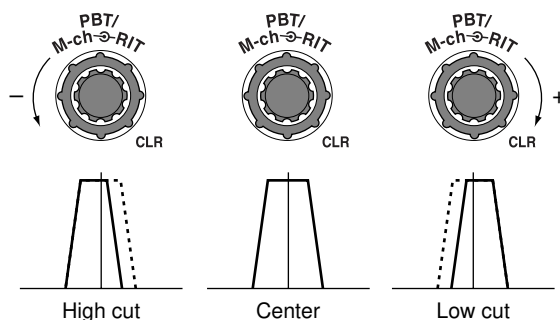
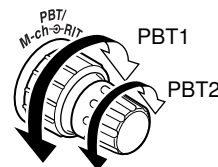

**✓ What is the PBT control?**

PBT electronically narrows the IF passband width to reject interference. This transceiver uses DSP to implement PBT.

- ➔ While M-ch/RIT is selected:
  - Rotate the inner control to select a memory channel number (p. 100).
  - Push and hold inner control for 1 sec. to turn the RIT/ $\Delta$ TX mode ON (pgs. 73, 86).
    - Push [▼(MENU/GRP)] to exit the RIT/ $\Delta$ TX mode.
  - While the RIT/ $\Delta$ TX mode is OFF:
    - Rotate outer control to select a memory bank (p. 104).
  - While the RIT/ $\Delta$ TX is ON:
    - Rotate outer control to shift the receive or transmit frequency (pgs. 73, 86).
    - “RIT” or “ $\Delta$ TX” indicators appear when the RIT or  $\Delta$ TX function is activate, respectively.
    - The shift frequency range is  $\pm$  9.999 kHz in 1 Hz steps (or  $\pm$ 9.99 kHz in 10 Hz steps).

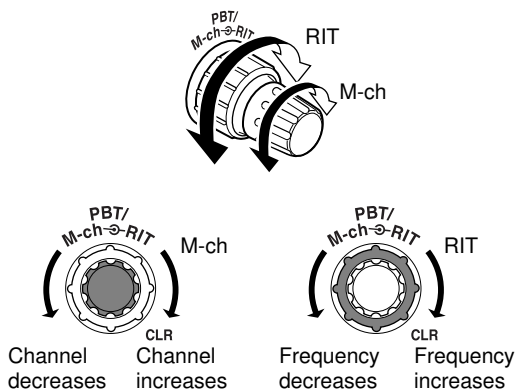

- When the RIT or  $\Delta$ TX function is ON, push and hold [F-1 RIT] or [F-2  $\Delta$ TX] for 1 sec. to add or subtract the frequency shift to the display frequency.

**✓ What is the RIT function?**

RIT (Receiver Incremental Tuning) shifts the receive frequency without shifting the transmit frequency.

This is useful for fine tuning for stations calling you off frequency or when you prefer to listen to slightly different-sounding voice characteristics, etc.

**✓ What is the  $\Delta$ TX function?**

The  $\Delta$ TX shifts the transmit frequency without shifting the receive frequency. This is useful for simple split frequency operation in CW, etc.

**6 TWIN PBT (M-ch/RIT) INDICATOR**

(pgs. 73, 77, 86, 100)

- ➔ Indicates the status of [PBT/M-ch/RIT] (5) as the Twin PBT function or memory channel/RIT control.
  - Indicator is green when the Twin PBT is selected.
  - Indicator is off when the M-ch/RIT is selected.
  - Indicator is orange when the RIT or  $\Delta$ TX function is activate.

**7 MENU/GROUP KEYS [MENU/GRP] (p. 151)**

- ➔ Push either key one or more times to select menus within a menu group (M, S or G (Graphic)).
- ➔ Push and hold for 1 sec. to select one of the three menu groups: M-1 to M-3, S-1 to S-3 and G-1 (Scope) to G-3 (SWR meter).

**8 TUNER/CALL KEY [TUNER/CALL]**

- ➔ During HF/50 MHz operation (p. 114):
  - Push momentarily to toggle the automatic antenna tuner function ON and OFF.
    - An optional antenna tuner must be connected.
    - “TUNE” indicator appears when the tuner is ON.
  - Push and hold for 2 sec. to manually tune the antenna.
    - An optional antenna tuner must be connected.
    - “TUNE” indicator appears when the tuner is ON.
- ➔ During 144/430 MHz operation (p. 100):
  - Push momentarily to select the call channel (or return to the previous channel/frequency when the call channel is already selected).
  - “C1” is the 144 MHz call channel and “C2” is the 430 MHz call channel.

**9 MULTI-FUNCTION KEYS [F-1]/[F-2]/[F-3]/[F-4]**

- ➔ Push to select the function indicated in the LCD display above these keys. (pgs. 5–8, 151)
- Functions vary depending on the active menu.

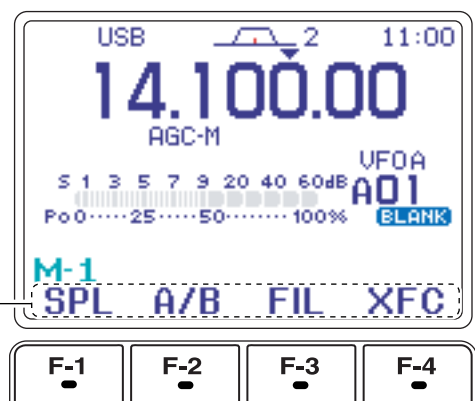

Functions appear

See the illustration of the Front panel on page i-2.

**10 MANUAL NOTCH KEY [MNF/ADJ]** (p. 81)

- ➔ Push momentarily to turn the manual notch function ON and OFF in SSB, CW and AM modes.
  - “MH” appears on the display when the function is activated.
- ➔ Push and hold for 1 sec. to enter the manual notch filter set mode.

✓ **What is the notch function?**

The notch function is a narrow DSP filter that removes interfering tones from CW or AM signals while preserving the desired signal's frequency response.

**11 AUTO NOTCH/VOICE RECORDER KEY [ANF/•REC]**

- ➔ Push momentarily to turn the auto notch function (ANF) ON and OFF in SSB, AM, FM modes. (p. 80)
  - “AN” appears on the display when the function is activated.
- ➔ Push and hold for 1 sec. to record the received signal's audio. (p. 93)

**12 SPCH/LOCK KEY [SPCH/LOCK]**

- ➔ Push momentarily to have the frequency, etc. announced by the speech synthesizer. (p. 34)
  - The parameters to be announced can be selected in the miscellaneous (others) set mode. (pgs. 131, 132)
- ➔ Push and hold for 1 sec. to toggle the dial lock function ON and OFF. (p. 37)
  - The dial lock function electronically locks the main dial.
  - “DL” appears while the dial lock function is active.

**13 MICROPHONE CONNECTOR** (p. 10)

- Modular-type microphone connector—accepts the supplied microphone (HM-151).
  - The optional OPC-589 can be used to connect an 8-pin microphone such as the SM-20, if desired.
  - A microphone connector is also available on the rear panel. DO NOT connect 2 microphones simultaneously.

**14 UP/DOWN (BAND) KEYS [▲(BAND)]/[▼(BAND)]**

- ➔ Push momentarily to select a frequency band.
- ➔ Push and hold [▲(BAND)] for 1 sec. to toggle the simple band scope display ON and OFF.
- ➔ Push and hold [▼(BAND)] for 1 sec. to toggle the multi-function meter display ON and OFF.

**15 MAIN DIAL TENSION LATCH**

- Selects the main dial drag.
  - Three positions are available. The upper setting turns on clicks as the dial is turned.

**16 HEADPHONE JACK [PHONES]** (p. 18)

Accepts headphones with 8–16 Ω impedance.

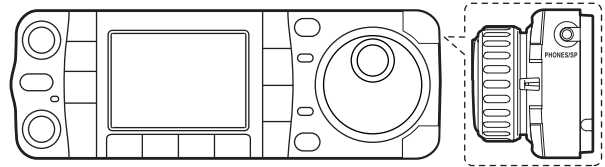

- When headphones are connected, no receive audio comes from the speaker.
- When the PHONES/SPEAKER switch on the back of the front panel is set to the [SPEAKER] position, an external speaker can be used instead of headphones. This is convenient for mobile or outdoor operation.

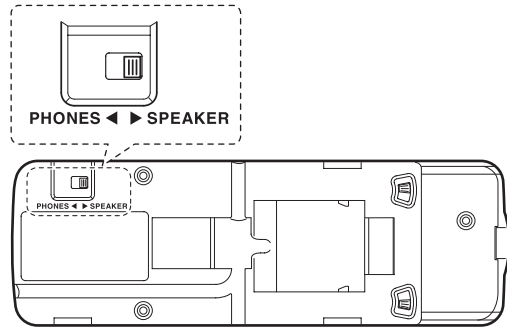

Back of the front panel

**17 MAIN DIAL [DIAL]**

Changes the displayed frequency and selects values for selected set mode items, etc.

**18 RECEIVE/TRANSMIT INDICATORS [RX]/[TX]**

- ➔ [RX]: Lights green in receive mode and when squelch is open.
- ➔ [TX]: Lights red while transmitting.

See the illustration of the Front panel on page i-2.

**19 TUNING STEP KEY [TS]** (pgs. 30–32)

- ➔ While in SSB/CW/RTTY modes, push momentarily to turn the programmable tuning step ON and OFF. While in AM/FM/WFM modes, push momentarily to toggle the programmable tuning step and 1 MHz quick tuning step.
- While the programmable tuning step indicator is displayed, the frequency can be changed in the programmed kHz step size.

Programmable tuning step indicator

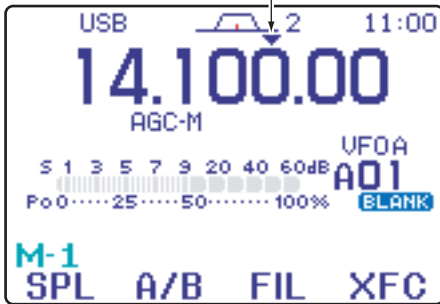

- 0.01 (AM/FM/WFM mode only), 0.1, 1, 5, 9, 10, 12.5, 20, 25 and 100 kHz tuning steps are available.
- 1 MHz quick tuning step is only available in AM, FM and WFM modes.
- ➔ While programmable tuning steps are OFF, turns the 1 Hz step ON and OFF when pushed and held for 1 sec.
  - 1 and 10 Hz steps are only available in SSB, CW and RTTY modes.
  - 1 Hz indication appears, and the frequency can be changed in 1 Hz steps.
- ➔ While the programmable tuning step is ON, enters the tuning step selection mode when pushed and held for 1 sec.

**20 NOISE BLANKER KEY [NB/ADJ]** (p. 78)

- ➔ Push momentarily to turn the noise blanker ON and OFF. The noise blanker reduces pulse-type noise such as that generated by automobile ignition systems. This function does not work on non-pulse noise or in WFM mode.
  - “**NB**” appears when the noise blanker is ON.
- ➔ Push and hold for 1 sec. to enter the noise blanker set mode.

**21 NOISE REDUCTION KEY [NR/LEV]** (p. 79)

- ➔ Push momentarily to turn DSP noise reduction ON and OFF.
  - “**NR**” appears on the display when the function is activated.
- ➔ Push and hold for 1 sec. to enter the DSP noise reduction level.

**22 FUNCTION DISPLAY**

Shows the operating frequency, function key menus, simple band scope display, selected memory channel, etc. See p. 13 for details.

**23 PRE AMP/ATTENUATOR KEY [P.AMP/ATT]**

- (p. 72)
- ➔ Push momentarily to turn the preamp ON or OFF.
    - “**P.AMP**” indicator appears when the preamp is activated.
  - ➔ Push and hold for 1 sec. to turn the 12 dB attenuator ON; push momentarily to turn the attenuator OFF.
    - “**ATT**” indicator appears when the attenuator is activated.

✓ **What is the preamp?**

The preamp amplifies signals in the receiver front end (input circuit) to improve the sensitivity. Turn ON ‘P.AMP’ when receiving weak signals.

✓ **What is the attenuator?**

The attenuator prevents a strong undesired signal near the desired frequency or near your location, such as from a broadcast station, from causing distortion or spurious signals.

**24 MODE KEY [MODE]** (p. 34)

- ➔ Push momentarily to cycle through the operating modes:  
 USB/LSB ↕ CW/CW-R ↕  
 RTTY/RTTY-R ↕ AM/FM/WFM
- ➔ Push and hold for 1 sec. to toggle the following operating modes:  
 USB ↔ LSB  
 CW ↔ CW-R  
 RTTY ↔ RTTY-R  
 AM → FM → WFM → AM, etc

**OPERATING MODE SELECTION**

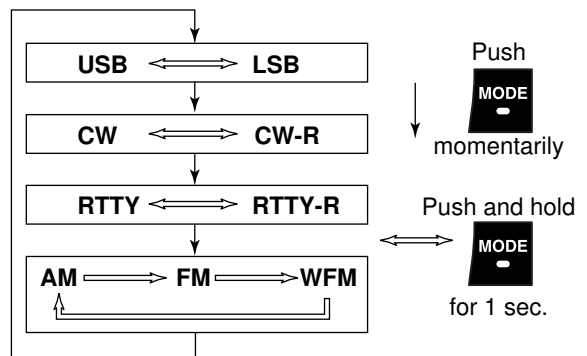

See the illustration of the Front panel on page i-2.

## Multi-function keys

### ◇ Menu M-1 functions

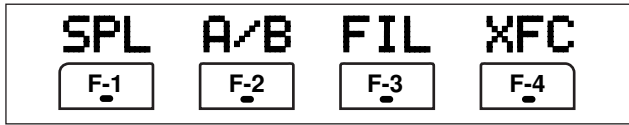

#### SPLIT OPERATION

- SPL** (F-1) → Push momentarily to toggle the split function ON and OFF. (p. 89)
- “**SPL**” and transmit frequency appear when the split function is ON.
- Push and hold for 1 sec. to turn the quick split function ON. (p. 90)
- The offset frequency must be programmed in advance using the miscellaneous (others) set mode. (pgs. 129, 130)
  - The offset frequency is the shift from the displayed frequency.
  - The quick split function can be turned OFF in the miscellaneous (others) set mode. (p. 129)

#### VFO A/B SELECTION

- A/B** (F-2) → Push momentarily to exchange the transmit VFO and receive VFO contents. (p. 27)
- Push momentarily to toggle the transmission VFO and reception VFO during split operation. (p. 89)
- Push momentarily to toggle the transmit and receive frequencies (and modes) of memory channels when the split function is turned ON.
- Push and hold for 1 sec. to equalize the frequency and operating mode of the two VFO's.
- The lower indicated frequency and operating mode are equalized to the upper (indicated) VFO frequency and operating mode.

#### FILTER SELECTION (p. 75)

- FIL** (F-3) → Push momentarily to select one of three IF filter settings.
- Push and hold for 1 sec. to enter the filter set mode.

#### TRANSMIT FREQUENCY CHECK (pgs. 65, 89)

- XFC** (F-4) Monitors the transmit frequency when pushed and held.
- While pushing and holding this key, the transmit frequency can be changed with **[DIAL]**.

### ◇ Menu M-2 functions

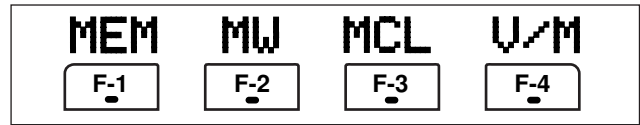

#### MEMORY MENU (p. 103)

- MEM** (F-1) Push momentarily to indicate the memory frequency and modes.
- Memory list indication is available.

#### MEMORY WRITE (pgs. 101, 102)

- MW** (F-2) Push and hold for 1 sec. to store the selected frequency and operating mode into the displayed memory channel.

#### MEMORY CLEAR (p. 106)

- MCL** (F-3) Push and hold for 1 sec. to clear the selected memory channel contents.
- “**BLANK**” appears.

#### VFO/MEMORY SELECTION

- U/M** (F-4) → Push momentarily to toggle VFO and memory modes. (pgs. 27, 100)
- Push and hold for 1 sec. to transfer the selected memory channel to the currently displayed VFO. (p. 107)

### ◇ Menu M-3 functions

#### DURING SSB OPERATION:

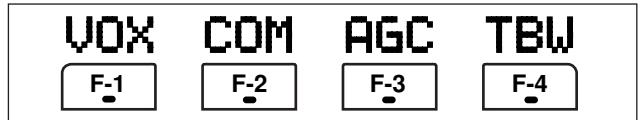

#### DURING CW OPERATION:

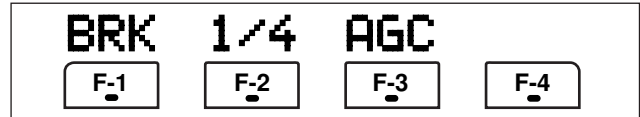

#### DURING RTTY OPERATION:

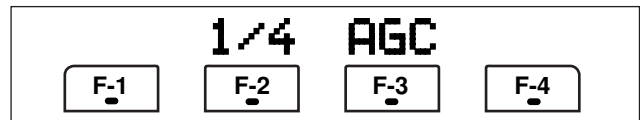

#### DURING AM OPERATION:

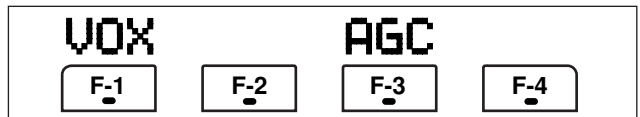

DURING FM/WFM OPERATIONS:

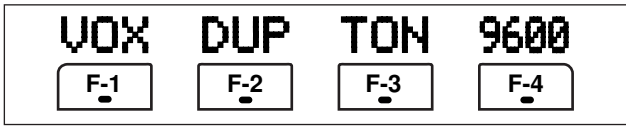

**VOX FUNCTION** (p. 83)

- VOX** Push momentarily to toggle the VOX function ON and OFF.
- “VOX” appears when the VOX function is ON.
- Push and hold for 1 sec. to enter the VOX set mode.
- The VOX gain, ANTI-VOX and VOX delay can be set in VOX set mode.

✓ **What is the VOX function?**

The VOX function (voice operated transmission) activates the transmitter when you speak into the microphone and automatically returns to receive when you stop speaking.

**SPEECH COMPRESSOR** (p. 87)

- COM** Push momentarily to toggle the speech compressor ON and OFF.
- “COM” appears when the speech compressor is ON.
- Push and hold for 1 sec. to enter the compression level set mode.
- Speech compression can be adjusted in compression level set mode.

**AGC** (p. 74)

- AGC** Push to change the time constant of the AGC circuit.
- “AGC-F,” “AGC-M” or “AGC-S” appears when the fast time constant, middle time constant or slow time constant is selected, respectively.
- Push and hold for 1 sec. to enter the AGC set mode.
- “AGC-X” (OFF) can be selected.

**TBW** (p. 84)

- TBW** Push momentarily to indicate the selected TX filter width.
- The popup indicator appears.
- Push and hold for 1 sec. to toggle the TX filter width between narrow, middle or wide.
- The following filters are specified as the default. Each filter width can be set in the quick set mode. (pgs. 121, 122)
- |      |                     |
|------|---------------------|
| WIDE | : 100 Hz to 2900 Hz |
| MID  | : 300 Hz to 2700 Hz |
| NAR  | : 500 Hz to 2500 Hz |

**BREAK-IN FUNCTION** (p. 85)

- BRK** Push momentarily to select semi break-in, full break-in (QSK) and break-in OFF.
- “BK-IN” or “F-BK” appears when selecting semi break-in or full break-in, respectively.
  - An external switch, such as a foot switch, must be connected to the ACC socket (pin 3, pin 7 or RTTY SEND—see p. 23) if break-in is turned OFF.
- Push and hold for 1 sec. to enter the break-in delay time set mode.

✓ **What is the break-in function?**

Full break-in (QSK) activates the receiver between transmitted dots and dashes. This is useful when operating in nets, or during DX pile-ups and during contests, when “fast responses” are common.

**1/4 FUNCTION**

- 1/4** Push to toggle the 1/4-speed tuning function ON and OFF in CW and RTTY modes.
- When the 1/4 function is ON, “” appears and fine tuning can be used.

**DUPLEX FUNCTION** (p. 63)

- DUP** Push to select the duplex transmit offset direction or turn the function OFF.
- Push and hold for 1 sec. to turn the one-touch repeater function ON/OFF.

**FM TONE OPERATION**

- TON** Push momentarily to set the subaudible tone encoder for repeater use, tone squelch function, DTCS and OFF.
- “TONE” appears when the repeater tone function is ON. (p. 63)
  - “TSQL” appears when the tone squelch function is ON. (p. 60)
  - “DTCS” appears when the DTCS squelch function is ON. (p. 61)
- Push and hold for 1 sec. to enter the tone frequency or DTCS code set mode. (pgs. 60, 61)
- Tone scan function is also available. (p. 62)
- Push and hold to transmit a 1750 Hz tone when pushing and holding [PTT]. (p. 67)

**9600 MODE**

- 9600** Push to turn the 9600 bps data transmission mode ON and OFF. (p. 116)

◇ Menu S-1 functions

DURING SSB/AM OPERATION:

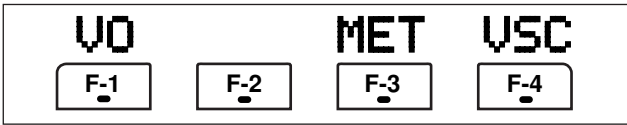

DURING CW OPERATION:

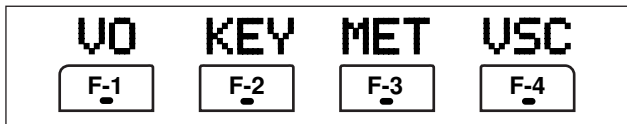

DURING RTTY OPERATION:

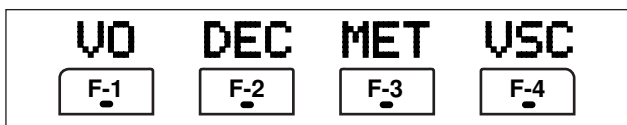

DURING FM/WFM OPERATIONS:

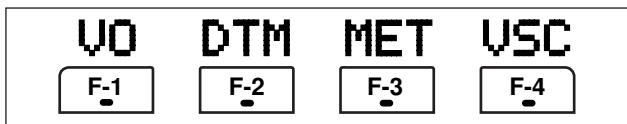

VO (p. 93)

**VO**  
F-1

Push to enter the voice recorder mode.  
•The voice TX/RX menu or voice root menu appears depending on the "VOICE 1st Menu" setting in the miscellaneous (others) set mode. (p. 134)

METER SELECTION (p. 36)

**MET**  
F-3

Push to select the type of metering displayed (during transmit) on the display.  
•Power, SWR, ALC or COMP metering can be selected.  
•Only the S-meter is available during receive.

VOICE SQUELCH CONTROL (p. 82)

**USC**  
F-4

Push to toggle the voice squelch control function ON and OFF.

KEYER OPERATION (p. 45)

**KEY**  
F-2

Push to enter the memory keyer mode.  
•The keyer send menu or keyer root menu appears depending on the "KEYER 1st Menu" setting in the miscellaneous (others) set mode.(p. 134)

RTTY DECODER FUNCTION (p. 54)

**DEC**  
F-2

Push to toggle the RTTY decoder display ON and OFF.  
•RTTY decoder screen appears.

DTMF OPERATION

**DTM**  
F-4

Push to enter DTMF memory mode. (p. 67)  
•The DTMF send menu or DTMF root menu appears depending on the "DTMF 1st Menu" setting in the miscellaneous (others) set mode. (p. 134)

◇ Menu S-2 functions

DURING VFO MODE:

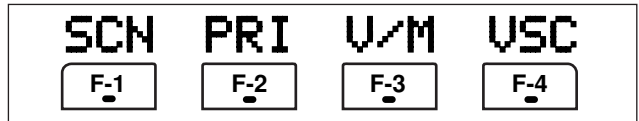

DURING MEMORY MODE:

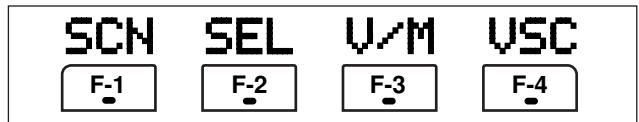

SCAN (pgs. 111–113)

**SCN**  
F-1

Push momentarily to start or stop the scan function.

PRIORITY WATCH (p. 113)

**PRI**  
F-2

Push to start or stop priority watch.

VFO/MEMORY SELECTION

**U/M**  
F-3

Push momentarily to toggle VFO and memory modes. (pgs. 27, 100)  
Push and hold for 1 sec. to transfer the frequency and operating mode in the selected memory channel to the currently displayed VFO. (p. 107)

VOICE SQUELCH CONTROL (p. 82)

**USC**  
F-4

Push to toggle the voice squelch control function ON and OFF.

SELECT SCAN

**SEL**  
F-2

Push momentarily to toggle the select scan settings ON and OFF for the selected memory channel. (pgs. 104, 113)  
Push and hold for 2 sec. to clear all select scan setting. (p. 113)  
While scanning, push to toggle the selected memory scan ON and OFF. (p. 113)



◇ Menu S-3 functions

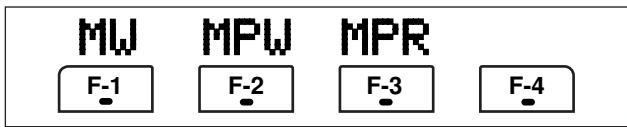

**MEMORY WRITE** (pgs. 101, 102)

**MW**  Push and hold for 1 sec. to store the displayed VFO frequency and operating mode into the selected memory channel.

**MEMO PAD WRITE** (p. 109)

**MPW**  Push to store the displayed VFO frequency and operating mode into a memo pad.

**MEMO PAD READ** (p. 110)

**MPR**  Push to call up a memo pad.

✓ **What is the memo pad function?**

The memo pad function stores the frequency and operating mode for easy recall. The memo pads are separate from the usual memory channels. The memo pads are separate from the usual memory channels. The default number of memo pads is 5, however, this can be increased to 10 in the miscellaneous (others) set mode, if desired. (p. 132)

◇ Menu G-1 (Scope) functions

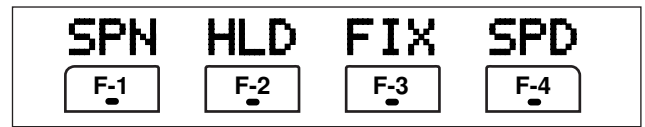

**SWEEP STEPS** (pgs. 70, 71)

**SPN**  Push momentarily to change the sweep step size.  
 • Available steps are  $\pm 10$ , 25, 50, 100 and 250 kHz.  
 ➔ Push and hold for 1 sec. to change the sweep steps to  $\pm 10$  kHz.

**PEAK HOLD** (pgs. 70, 71)

**HLD**  Push to freeze the current simple band scope display.  
 • "H" indicator appears while the function is in use.  
 ➔ Push and hold for 1 sec. to clear the peak levels.  
 • Peak levels are displayed in the background on the simple band scope display. The peak hold function can be disabled in the scope set mode. (p. 71)

**FIX/CENTER SELECTION** (pgs. 70, 71)

**FIX**  Push to toggle the simple band scope fix mode and center mode.  
 • Fix mode:  
 Rotating [DIAL] leaves the marker centered.  
 • Center mode:  
 Rotating [DIAL] moves the edge frequencies.  
 ➔ During fix mode operation, push and hold for 1 sec. to set the displayed frequency to that of the marker.

**SWEEP SPEED**

**SPD**  Push momentarily to change the sweep speed between Fast and Slow. (pgs. 70, 71)  
 ➔ Push and hold for 1 sec. to enter the scope set mode. (p. 71)

## ■ Microphone (HM-151)

### 1 SPCH/LOCK KEY [SPCH/LOCK]

- ➔ Push momentarily to have the frequency, etc. announced by the speech synthesizer. (p. 34)
  - The parameters to be announced can be selected in the miscellaneous (others) set mode. (p. 132)
- ➔ Push and hold for 1 sec. to toggle the microphone lock function ON and OFF. (p. 37)

### 2 PTT SWITCH [PTT] (p. 37)

- Push and hold to transmit; release to receive.

### 3 UP/DOWN SWITCHES [▲]/[▼]

- Change the operating frequency.
  - Push and hold to change the frequency repeatedly.
  - Tuning step size is 50 Hz if no TS indicator is displayed.

### 4 TRANSMIT INDICATOR (p. 37)

- Lights red while transmitting.

### 5 KEYPAD

- ➔ Pushing a key selects the operating band.
  - **[(GENE)•]** selects the general coverage band.
- ➔ Pushing the same key 2 or 3 times calls up other stacked frequencies in the band. (p. 28)
  - Icom's triple band stacking register memorizes 3 frequencies in each band.
- ➔ After pushing **[(F-INP)ENT]**, enter a numeric frequency, followed by pressing **[(F-INP)ENT]** again. (p. 29)
  - e.g. to enter 14.195 MHz, push **[(F-INP)ENT] [1] [4] [.] [1] [9] [5] [(F-INP)ENT]**.

### 6 FILTER SELECTION [FIL]

- ➔ Push momentarily to select one of three IF filter settings. (p. 75)
- ➔ Push and hold for 1 sec. to enter the filter set mode. (p. 76)

### 7 MODE KEY [MODE] (p. 34)

- ➔ Push momentarily to cycle through the operating modes:
  - USB/LSB ↕ CW/CW-R ↕
  - RTTY/RTTY-R ↕ AM/FM/WFM
- ➔ Push and hold for 1 sec. to toggle the following operating modes:
  - USB ↔ LSB
  - CW ↔ CW-R
  - RTTY ↔ RTTY-R
  - AM → FM → WFM → AM, etc

### 8 POWER INDICATOR

- Lights green while transceiver power is ON.

See the illustration of the HM-151 on page i-2.

### 9 PROGRAMMABLE FUNCTION KEYS [F-1]/[F-2]

- Program and perform a selected function.
  - The functions can be assigned in the miscellaneous (others) set mode (p. 133). The default settings for **[F-1]** and **[F-2]** are "MPW" and "MPR," respectively.

#### Default settings

- [F-1]** (MPW): Push to store the selected readout frequency and operating mode into a memo pad.
- [F-2]** (MPR): Push to call up a memo pad.

### 10 MEMORY WRITE [MW] (pgs. 101, 102)

- Push and hold for 1 sec. to store the displayed VFO frequency and operating mode into the displayed memory channel.

### 11 VFO/MEMORY SELECTION [V/M]

- ➔ Push momentarily to toggle VFO and memory modes. (pgs. 27, 100)
- ➔ Push and hold for 1 sec. to transfer the selected memory channel to the currently displayed VFO. (p. 107)

### 12 TRANSMIT FREQUENCY CHECK [XFC]

- (pgs. 65, 89)
- Monitors the transmit frequency when pushed and held.
  - While pushing and holding this key, the transmit frequency can be changed with **[DIAL]**.

### 13 TUNER/CALL KEY [TUNER/CALL]

- ➔ During HF/50 MHz operation (p. 114):
  - Push momentarily to toggle the automatic antenna tuner function ON and OFF.
    - An optional antenna tuner must be connected.
    - "TUNE" indicator appears when the tuner is ON.
  - Push and hold for 2 sec. to manually tune the antenna.
    - An optional antenna tuner must be connected.
    - "TUNE" indicator appears when the tuner is ON.
- ➔ During 144/430 MHz operation (p. 100):
  - Push momentarily to select the call channel (or return to the previous channel/frequency when the call channel is already selected).
    - "C1" is the 144 MHz call channel and "C2" is the 430 MHz call channel.

◇ Microphone connector

MICROPHONE CONNECTOR INFORMATION

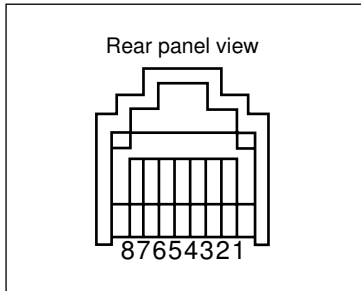

**CAUTION: DO NOT** short pin 1 to ground as this can damage the internal 8 V regulator.

**HM-151**

- ① +8 V DC output
- ② Frequency up/down
- ③ M8V SW
- ④ PTT
- ⑤ GND (Microphone ground)
- ⑥ Microphone input
- ⑦ GND
- ⑧ DATA IN

• When HM-151 is connected

PIN NO.	FUNCTION	DESCRIPTION
1	+8 V DC output	Max. 10 mA
2	Frequency up	Ground
	Frequency down	Ground through 470 Ω
3	HM-151 connection	Grounded to indicate HM-151 is connected.
8	HM-151 data	Control signal input

**HM-103**

- ① +8 V DC output
- ② Frequency up/down
- ③ M8V SW
- ④ PTT
- ⑤ GND (Microphone ground)
- ⑥ Microphone input
- ⑦ GND
- ⑧ Squelch switch

• When HM-103 is connected

PIN NO.	FUNCTION	DESCRIPTION
1	+8 V DC output	Max. 10 mA
2	Frequency up	Ground
	Frequency down	Ground through 470 Ω
3	HM-151 connection	Open
8	Squelch open	“LOW” level
	Squelch closed	“HIGH” level

⚠ **NEVER** connect or use the supplied HM-151 (microphone) with other transceiver. This could cause damage to the transceiver. The HM-151 is designed for use with the IC-7000 **ONLY**.

## ■ Rear panel

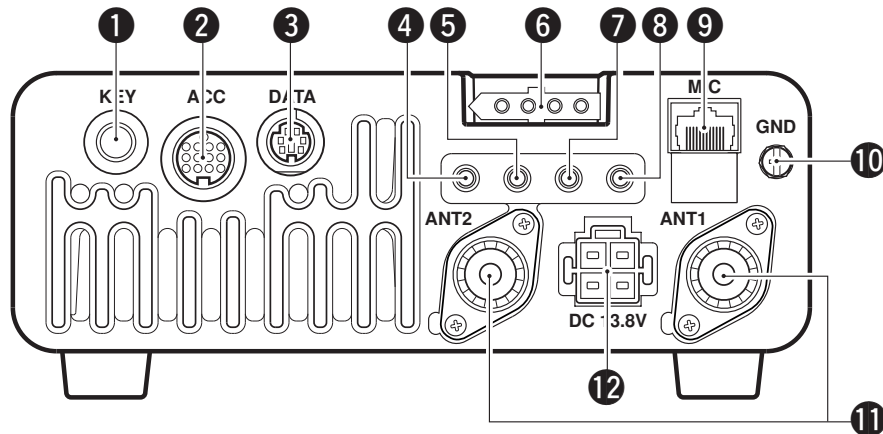

### 1 ELECTRONIC KEYSER JACK [KEY] (p. 22)

Accepts a paddle to activate the internal electronic keyer.

- Selection between the internal electronic keyer and straight key operation can be made in the keyer set mode. (p. 50)

When connecting a straight key

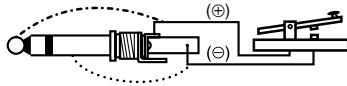

When connecting a paddle

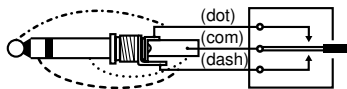

⚠ If you use an external electronic keyer, make sure the output voltage of the keyer is less than 0.4 V when keying the transmitter.

### 2 ACCESSORY SOCKET [ACC] (p. 12)

Enables connection to external equipment such as a TNC for data communications, a linear amplifier or an automatic antenna selector/tuner, etc.

- See page at right for socket wiring information.

### 3 DATA SOCKET [DATA] (p. 12)

6-pin mini-DIN socket to connect a TNC (Terminal Node Controller), etc. for packet operation.

- See page at right for socket wiring information.

### 4 VIDEO OUT JACK [VOUT] (p. 18)

Outputs a video signal.

### 5 CI-V REMOTE CONTROL JACK [REMOTE] (p. 142)

➔ Designed for use with a personal computer for remote control of the transceiver functions.

- ➔ Used for transceiver operation with another Icom CI-V transceiver or receiver.

### 6 TUNER CONTROL SOCKET [TUNER] (p. 20)

Accepts the control cable from an optional AH-4 HF/50 MHz AUTOMATIC ANTENNA TUNER.

### 7 RTTY JACK [RTTY] (p. 23)

Connects an external terminal unit for RTTY (FSK) operation.

- The keying polarity, mark/shift frequencies and etc. can be selected in quick set mode (p. 123).

### 8 EXTERNAL SPEAKER JACK [EXT SP] (p. 18)

Accepts a 4–8 Ω speaker.

### 9 MICROPHONE CONNECTOR [MIC] (p. 17)

Accepts the supplied microphone (connected in parallel with the front panel's [MIC] connector).

- See p. 3 for microphone notes.
- See p. 10 for microphone connector information.

### 10 GROUND TERMINAL [GND] (p. 15)

Connect this terminal to a station or vehicle ground to prevent electrical shocks, TVI, BCI and other problems.

### 11 ANTENNA CONNECTOR [ANT1], [ANT2] (p. 17)

Accepts a 50 Ω antenna with a PL-259 connector.

- [ANT1] is for connection to an HF/50 MHz antenna.
- [ANT2] is for connection to an 144/430 MHz antenna.
- ANT1 is used below and ANT2 above 60 MHz.

### 12 DC POWER SOCKET [DC13.8V] (p. 19)

Accepts 13.8 V DC through the supplied DC power cable.

Rear panel view

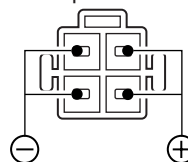

⚠ **NOTE: DO NOT** use a cigarette lighter socket as a power source when operating in a vehicle. The plug may cause voltage drops and ignition noise may be superimposed onto transmit or receive audio.

◇ DATA socket

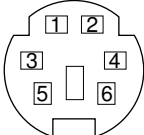
DATA	PIN No.	NAME	DESCRIPTION
 <p>Rear panel view</p>	1	DATA IN	Input terminal for data transmit. (1200 bps: AFSK/9600 bps: G3RUH, GMSK)
	2	GND	Common ground for DATA IN, DATA OUT and AF OUT.
	3	PTT P	PTT terminal for packet operation. Connect to ground to activate the transmitter. When grounded, microphone input (pin 6) of [MIC] connector will be disconnected.
	4	DATA OUT	Data out terminal for 9600 bps operation only.
	5	AF OUT	Data out terminal for 1200 bps operation only.
	6	SQL	<p>Squelch out terminal. This pin is grounded when the transceiver receives a signal which opens the squelch.</p> <ul style="list-style-type: none"> <li>• To avoid interfering transmissions, connect squelch to the TNC to inhibit transmission when squelch is open.</li> <li>• Keep RF gain at a normal level, otherwise a “SQL” signal will not be output.</li> </ul>

◇ ACC socket

ACC	PIN No.	NAME	DESCRIPTION	SPECIFICATIONS
 <p>Rear panel view</p> <p>① brown ⑧ gray ② red ⑨ white ③ orange ⑩ black ④ yellow ⑪ pink ⑤ green ⑫ light blue ⑥ blue ⑬ light green ⑦ purple</p> <p>Color refers to the cable strands of the supplied cable.</p>	1	8 V	Regulated 8 V output.	Output voltage : 8 V ±0.3 V Output current : Less than 10 mA
	2	GND	Connects to ground.	---
	3 <sup>†</sup>	HSEND	Input/output pin. (HF/50 MHz only) Grounded when transmits.	Ground level : -0.5 V to 0.8 V Output current : Less than 20 mA Input current (Tx) : Less than 200 mA
	4	BDT	Data line for the optional AT-180.	---
	5	NC (BAND*)	(*If the modification (p. 140) is performed, band voltage output.)	Output voltage : 0 to 8.0 V
	6	ALC	ALC voltage input.	Control voltage : -4 V to 0 V Input impedance : More than 10 kΩ
	7 <sup>†</sup>	VSEND	Input/output pin. (144/430 MHz only) Grounded when transmits.	Ground level : -0.5 V to 0.8 V Output current : Less than 20 mA Input current (Tx) : Less than 200 mA
	8	13.8 V	13.8 V output when power is ON.	Output current : Max. 1 A
	9	TKEY	Key line for the optional AT-180.	---
	10	FSKK	Controls RTTY keying	“High” level : More than 2.4 V “Low” level : Less than 0.6 V Output current : Less than 2 mA
	11	MOD	Modulator input.	Input impedance : 10 kΩ Input level : Approx. 100 mV rms
	12	AF	AF detector output. Fixed level, regardless of [AF] position in default settings.	Output impedance : 4.7 kΩ Output level : 100–300 mV rms
	13	SQLS	Squelch output. Grounded when squelch opens.	SQL open : Less than 0.3 V/5 mA SQL closed : More than 6.0 V/100 μA

<sup>†</sup>: Activating band can be changed in the miscellaneous (other) set mode (p. 131).

• When connecting the ACC conversion cable (OPC-599)

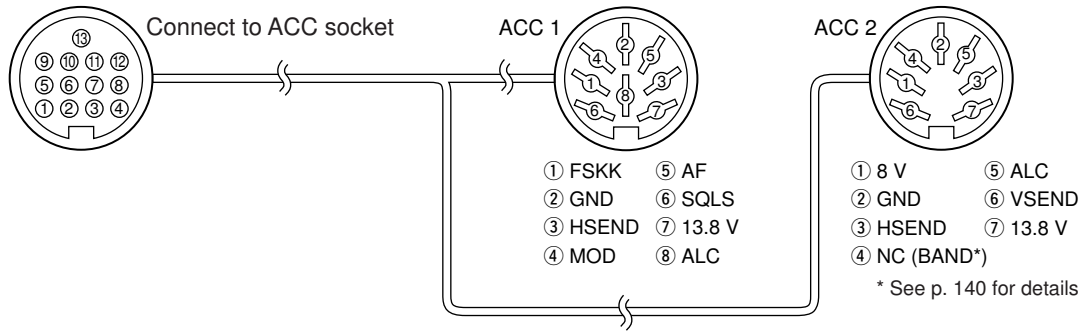

■ Function display

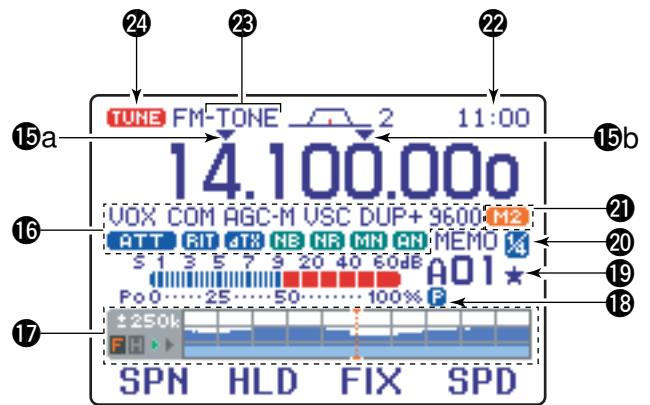
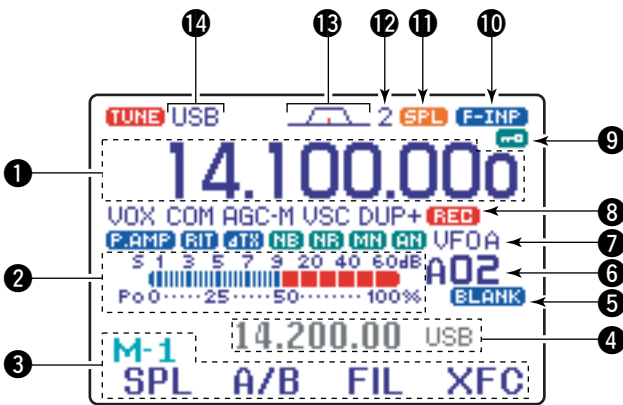

1 FREQUENCY READOUT

Shows the operating frequency.

2 METER READOUTS

- Shows received signal strength while receiving.
- Shows either transmit power meter (Po), SWR, ALC or compression level meter (COM) while transmitting.

3 MULTI-FUNCTION KEY GUIDE (p. 151)

Indicates the function of the multi-function keys. These alphanumeric readouts show a variety of information such as current functions of the “F” keys [F-1] to [F-4].

4 SPLIT FREQUENCY READOUT (pgs. 89, 90)

Shows the transmit frequency during split operation.

5 BLANK MEMORY INDICATOR (p. 101)

Appears when the displayed memory channel is not programmed (blank channel).  
• This indicator appears both in VFO and memory modes.

6 MEMORY CHANNEL READOUT (p. 100)

Shows the selected memory channel or scan edge channel.  
• Memory bank indicator (A to E) appears to the left of memory channel.  
• This indicator appears both in VFO and memory modes.

7 VFO/MEMORY INDICATORS (pgs. 27, 100)

Shows VFO A or B appears when VFO mode is selected; MEMO appears when memory mode is selected.

8 VOICE RECORDER INDICATORS (p. 94)

REC appears when the digital voice recoder function is activated.

9 LOCK INDICATOR (p. 37)

Appears when the dial lock function is activated.

10 DIRECT FREQUENCY ENTRY INDICATOR (p. 29)

Appears when the transceiver is ready for direct frequency entry.  
• This indicator appears when [(F-INP)ENT] key on the HM-151 is pushed.

**11 SPLIT INDICATOR** (pgs. 89, 90)

Appears during split operation.

**12 IF FILTER INDICATOR** (p. 75)

Shows the selected IF filter number.

**13 PASSBAND WIDTH INDICATOR** (p. 75, 77)

Graphically displays the passband width for twin PBT operation and center frequency for IF shift operation.

**14 MODE INDICATORS** (p. 34)

Shows the selected operating mode.

- “-R” appears when CW reverse or RTTY reverse mode is selected.

**15 PROGRAMMABLE/1 MHz TUNING STEP INDICATORS**

➔ **15a** appears when the 1 MHz quick tuning step is selected. (p. 31)

➔ **15b** appears when the programmable tuning step is selected. (p. 30)

**16 FUNCTION INDICATORS**

➔ “**VOX**” appears when the VOX function is activated. (p. 83)

➔ “**F-BK**” appears when full break-in operation is selected and “**BK-IN**” appears when semi break-in operation is selected. (p. 85)

➔ “**COM**” appears when the speech compressor is activated. (p. 87)

➔ “**AGC-F**,” “**AGC-M**,” “**AGC-S**” or “**AGC-X**” (OFF) appears when the fast time constant, middle time constant, slow time constant or AGC OFF is selected, respectively. (p. 74)

➔ “**VSC**” appears when the VSC (Voice Squelch Control) function is activated in phone (SSB, AM, FM, WFM) modes. (p. 82)

➔ “**DUP-**” appears for negative offset and “**DUP+**” appears for positive offset during duplex operation. (p. 63)

➔ “**9600**” appears when the 9600 baud mode is activated for packet operation. (p. 116)

➔ “**F.AMP**” appears when the preamp is ON, “**ATT**” appears when the 12 dB attenuator is ON. (p. 72)

➔ “**RIT**” or “**ΔTX**” appears when the RIT or ΔTX function is activated. (pgs. 73, 86)

➔ “**NE**” appears when the noise blanker is activated. (p. 78)

➔ “**NR**” appears when DSP noise reduction is activated. (p. 79)

➔ “**MN**” appears when the manual notch function is activated. (p. 81)

➔ “**AN**” appears when the automatic notch function is activated. (p. 80)

**17 MULTI-FUNCTION SCREEN**

Shows the screens for the multi-function meter, simple band scope, SWR meter, memory channel, voice recorder, memory keyer, DTMF memory encoder, RTTY decoder, IF filter selection or popup indication, etc.

**18 PRIORITY WATCH INDICATOR** (p. 113)

Appears while priority scan is activated.

**19 SELECT MEMORY CHANNEL INDICATOR**

(p. 113)

Appears when select scan is enabled for the selected memory channel.

**20 1/4 FUNCTION INDICATOR** (p. 32)

Appears when the 1/4-speed tuning function is activated in CW and RTTY modes.

**21 EXTERNAL KEYPAD INDICATOR**

Shows the memory keyer or voice memory channel number. This indication appears when “External Keypad (VOICE)” or “External Keypad (KEYER)” in the miscellaneous (others) set mode (p. 135) is set to ON, and which one is activated.

<Example>

• “**M2**” appears when the memory keyer “M2” is transmitted.

• “**T1**” appears when the voice memory “T1” is transmitted.

**22 CLOCK READOUT** (p. 117)

Shows the current time.

- UTC time or local time can be selected.

**23 TONE INDICATOR** (pgs. 60,, 61, 64)

Appears during FM tone operation.

- “**TONE**,” “**TSQL**” or “**DTCS**” appears when the repeater tone, tone squelch, DTCS squelch are activated, respectively.

**24 TUNER INDICATOR** (pgs. 114, 115)

Appears when the optional automatic antenna tuner is activated.

- This indicator blinks while the tuner is tuning.

## ■ Unpacking

After unpacking, immediately report any damage to the delivering carrier or dealer. Keep the shipping cartons.

For a description and a diagram of accessory equipment included with the IC-7000, see 'Supplied accessories' on p. i-1 of this manual.

## ■ Selecting a location

Select a location for the transceiver that allows adequate air circulation, free from extreme heat, cold, or vibrations, and away from TV sets, TV antenna elements, radios and other electromagnetic sources.

The base of the transceiver has an adjustable stand for desktop use. Set the stand to one of two angles depending on your operating conditions. (see description on right hand page)

## ■ Grounding

To prevent electrical shock, television interference (TVI), broadcast interference (BCI) and other problems, ground the transceiver through the GROUND terminal on the rear panel.

For best results, connect a heavy gauge wire or strap to a long, buried copper rod. Make the distance between the [GND] terminal and ground as short as possible.

**WARNING: NEVER** connect the [GND] terminal to a gas pipe or electric conduit, since the connection could cause an explosion or electric shock.

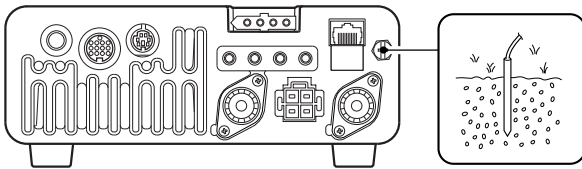

## ■ Antenna connection

For radio communications the antenna is of critical importance for output power and sensitivity. Use well-matched 50-ohm antennas and coaxial feedline. An SWR (standing wave ratio) of 1.5:1 or lower is recommended when transmitting.

**CAUTION:** Protect your transceiver from lightning by using a lightning arrestor.

### PL-259 CONNECTOR INSTALLATION EXAMPLE

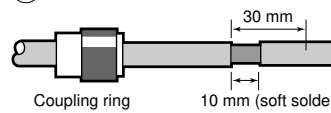
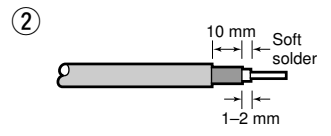
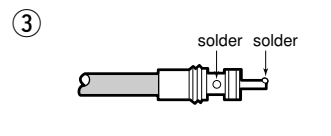
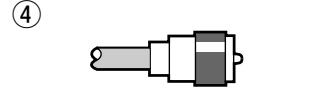
- ①  Slide the coupling ring down. Strip the cable jacket and soft solder.
- ②  Strip the cable as shown at left. Soft solder the center conductor.
- ③  Slide the connector body on and solder it.
- ④  Screw the coupling ring onto the connector body.

### ANTENNA SWR

Each antenna is tuned for a specified frequency range and SWR increases outside that range. When the SWR is higher than approx. 2.0:1, the transceiver's power drops to protect the final transistors. In this case, an antenna tuner is used to match the transceiver and antenna. Low SWR allows full power for transmitting even when using the antenna tuner. The IC-7000 has an SWR meter to monitor the antenna SWR continuously.



## Installation

### Single body mounting

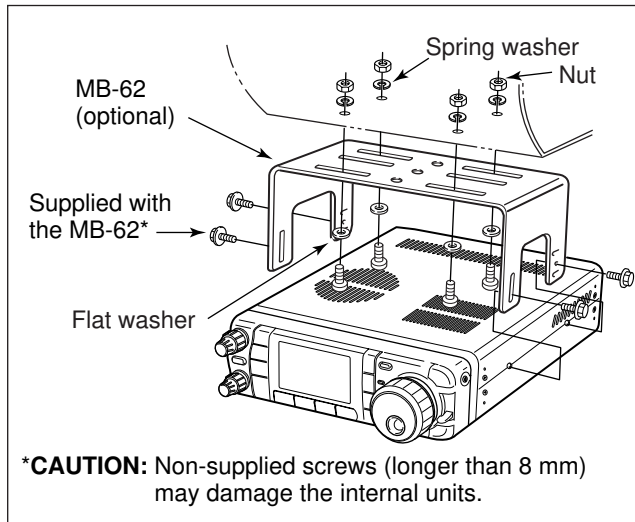

### Stand

*To raise the stand:*  
With the transceiver upside down, pull the stand towards the rear panel and then upwards, as illustrated below.

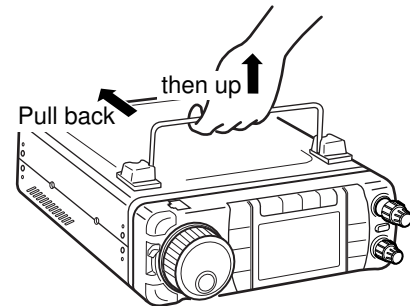

### Front panel separation

- ① While pulling the front panel latch towards you, slide the front panel to the left (fig. 1).
- ② Attach the optional OPC-1443 to the main body and tighten the supplied screw as in fig. 2.
- ③ Attach the other end of the OPC-1443 to the detached front panel as in fig. 3.

**CAUTION: NEVER** detach/attach the front panel when connecting the DC power supply (or battery). Be sure to disconnect the DC power cable from the [13.8 V] socket on the transceiver rear panel.

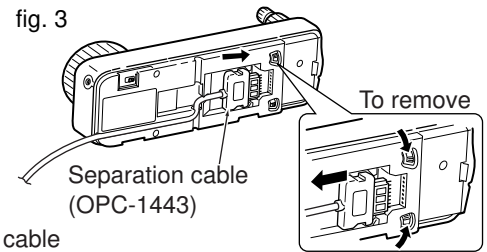
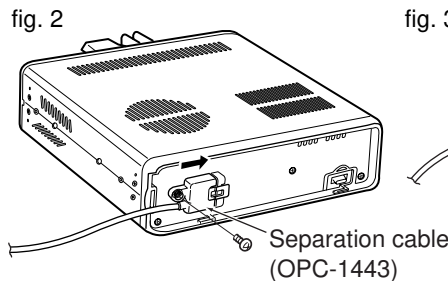
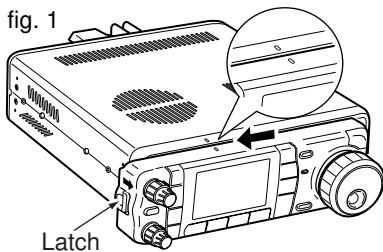

### Front panel mounting

- ① Attach the MB-105 to a flat surface using the four supplied screws (fig. 1).
- ② Fix the detached front panel to the MB-105 as illustrated in fig. 2.

**BE CAREFUL** to mount the MB-105 so that the front panel attaches with the correct side up.

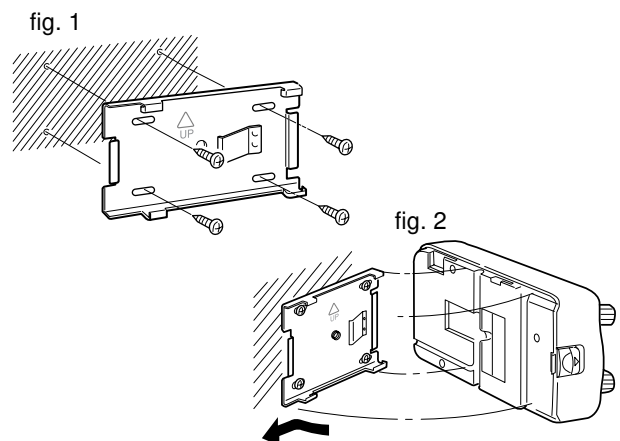

## Required connections

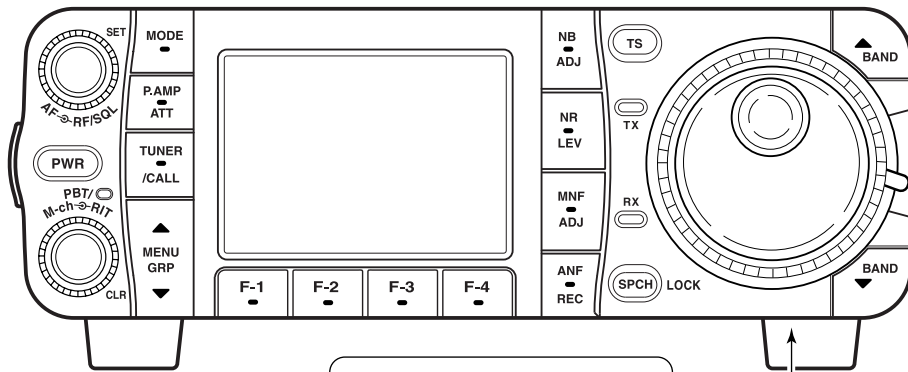

**MICROPHONE** (p. 10)

HM-151

**GROUND** (p. 15)

Use the heaviest gauge wire or strap available and make the connection as short as possible.

Grounding prevents electrical shocks, TVI and other problems.

**STRAIGHT KEY**

**RTTY TERMINAL UNIT** (p. 23)

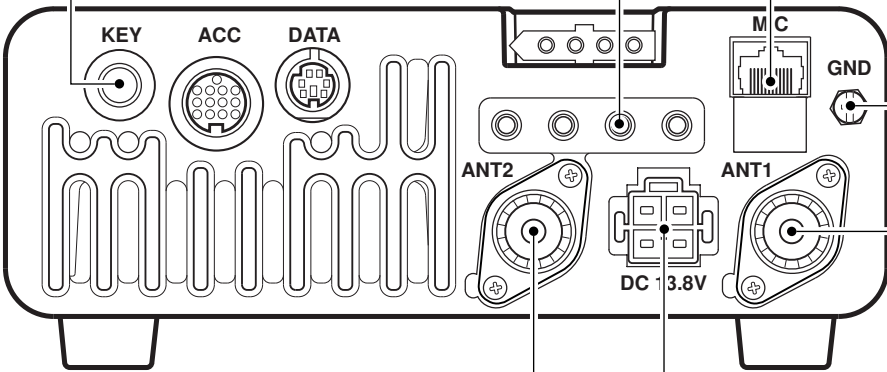

**2 m/70 cm ANTENNA**

**DC POWER SUPPLY** (p.19)

AC outlet A DC power supply

13.8 V; at least 25 A  
Red Black

**HF/50 MHz ANTENNA**

## Advanced connections

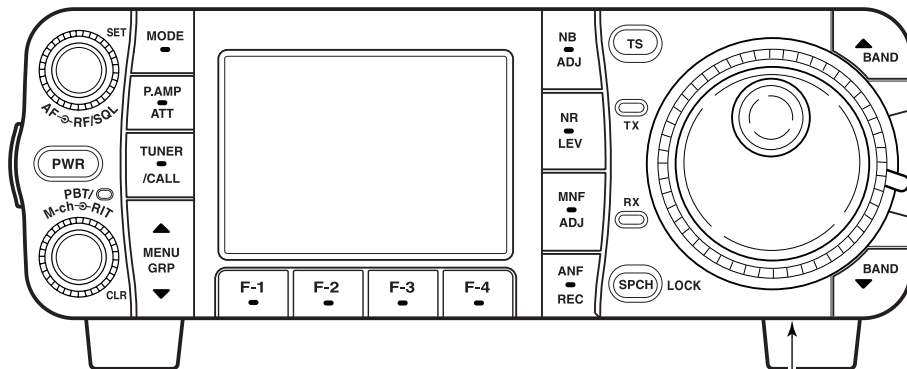

**DATA SOCKET** (p. 12)  
6-pin mini DIN socket to connect to a TNC, etc. for packet operation.

**VIDEO OUT**  
to [VOUT] jack  
Vout GND  
3.5(d) mm

**ACC SOCKET** (p. 12)

**OPC-589** (p. 150)

**SM-20**  
**DESKTOP** (p. 149)  
**MICROPHONE**

**HEADPHONES**

or

**SPEAKER**

Selectable with the [PHONE/SPEAKER] switch on the back of the front panel.

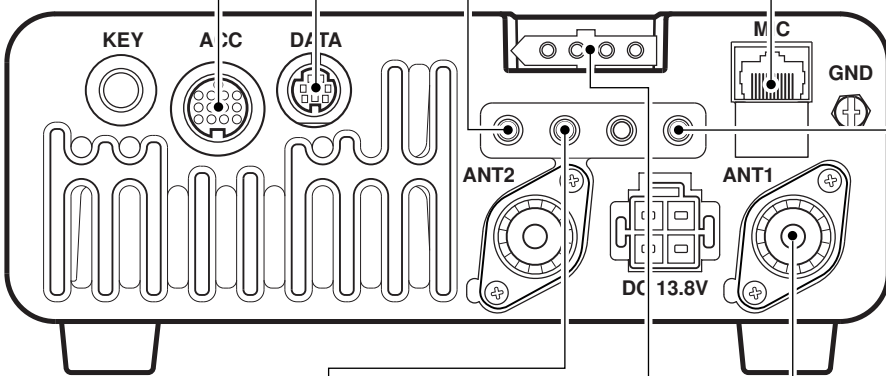

**EXTERNAL SPEAKER** (p. 149)  
SP-7/SP-10

**REMOTE** (p. 142)  
Used for computer control and transceive operation.

**AH-4** (p. 20)      **AH-2b**

## ■ Power supply connections

Use the DC power supply with a 25 A capacity when operating the transceiver with AC power. Refer to the diagrams below.

**CAUTION:** Before connecting the DC power cable, check the following important items. Make sure:

- The **[POWER]** switch is OFF.
- Output voltage of the power source is 12–15 V.
- DC power cable polarity is correct.
  - Red : positive ⊕ terminal
  - Black : negative ⊖ terminal

## ■ Connecting a DC power supply

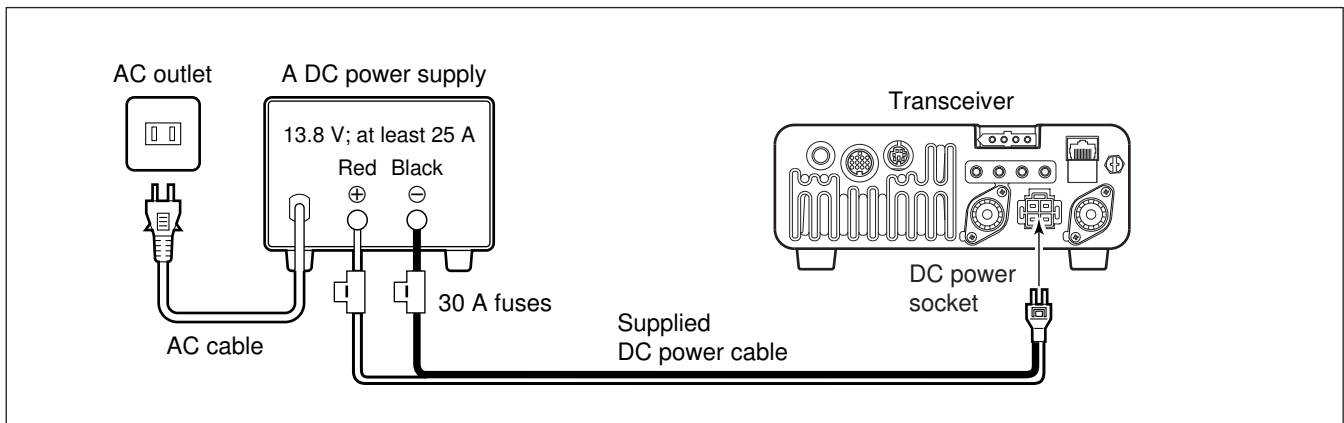

## ■ Battery connections

- **⚠ WARNING NEVER connect** to a battery without supplying a DC fuse, otherwise a fire hazard occurs.
- **NEVER connect** the transceiver directly to a 24 V battery.

- **DO NOT** use a cigarette lighter socket as a power source when operating in a vehicle. The plug may cause voltage drops and ignition noise may be superimposed onto transmit or receive audio.
- Use a rubber grommet when passing the DC power cable through a metal plate to prevent a short circuit.

### CONNECTING A VEHICLE BATTERY

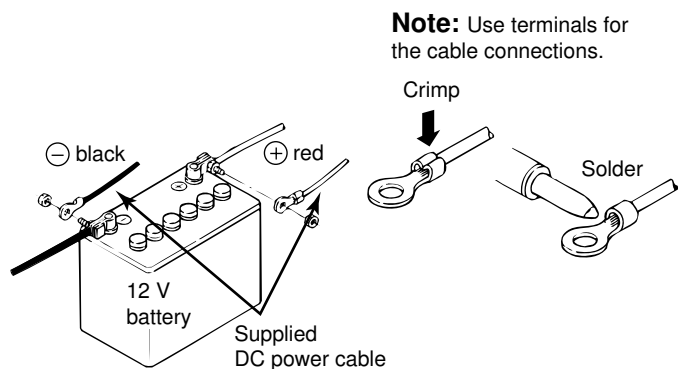
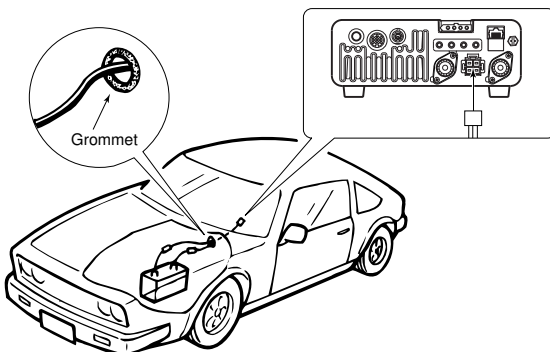

**Note:** Use terminals for the cable connections.

The transceiver may not receive well on some frequencies when installed in a hybrid vehicle, or any type of electric vehicle (fuel cell vehicle). This is because vehicle's electric components such as the inverter system generate a lot of electric noise.

**IMPORTANT!** Detailed installation notes for Icom mobile transceivers to be fitted into vehicles are available. Contact your Icom dealer or distributor.

## External antenna tuners

### CONNECTING THE AH-4

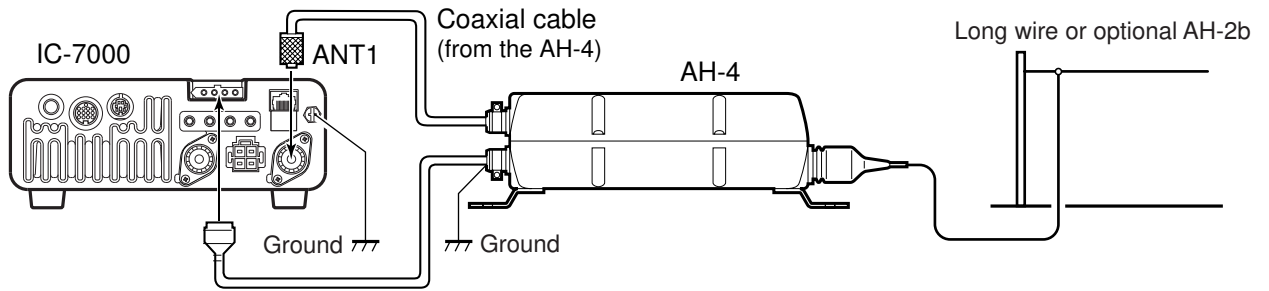

### CONNECTING THE AT-180

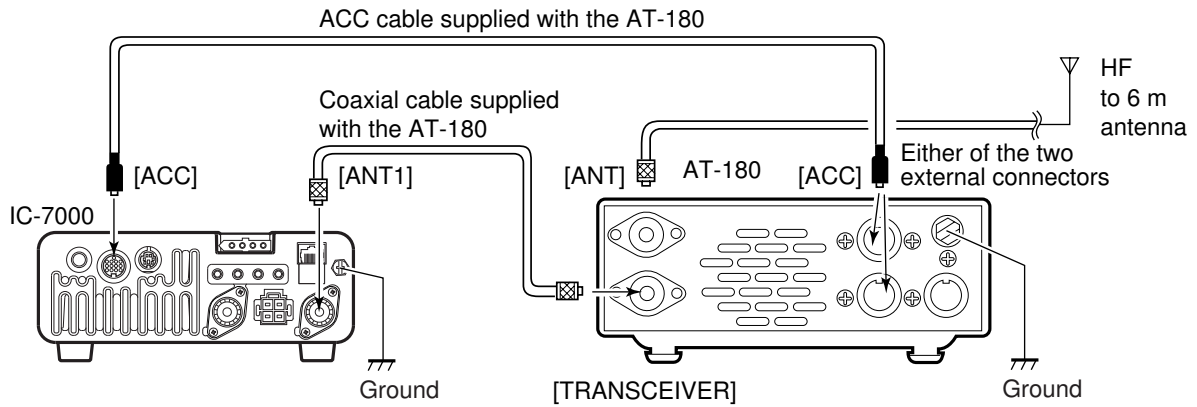

- Turn the IC-7000's power OFF when connecting the AT-180, otherwise, the CPU may malfunction and the AT-180 may not function properly.
- The OPC-742 is required when using both the AT-180 and a 2m/70cm linear amplifier.

- Do not connect [ANT2] to the AT-180. When using an HF to 2m/70cm dual or wide-band antenna, use a duplexer between the AT-180 and antenna since 2 m/70 cm signals do not pass through the AT-180.

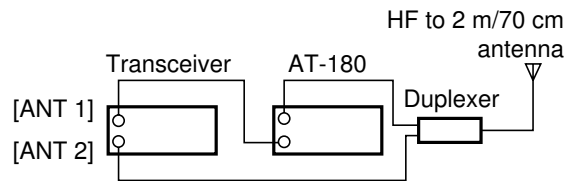

## Linear amplifier connections

Use the [ANT1] connector when connecting an HF/50 MHz linear amplifier.

### CONNECTING THE IC-PW1/EURO

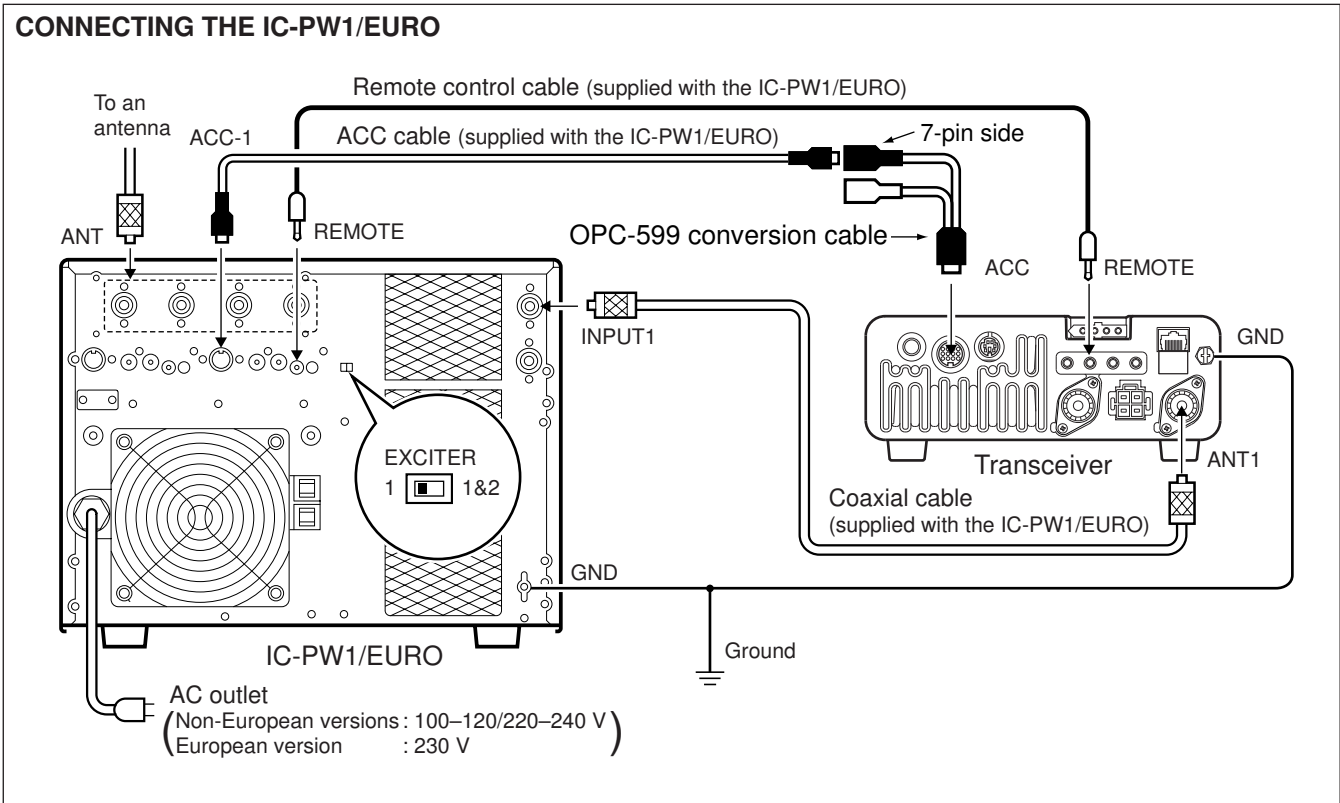

### CONNECTING A NON-ICOM LINEAR AMPLIFIER

#### ⚠ WARNING:

- Set the transceiver output power and linear amplifier ALC output level referring to the linear amplifier instruction manual. Be sure the linear amplifier keying circuit control voltage is compatible with the IC-7000, before connecting to the HSEND line (ACC cable).
- The ALC input level must be in the range 0 V to -4 V, and the transceiver does not accept positive voltage. Non-matched ALC and RF power settings could cause a fire or damage the linear amplifier.

- The IC-7000 SEND line (ACC connector pin 3) is rated at 16 V/200 mA DC. If this level is exceeded, a larger external relay must be used.

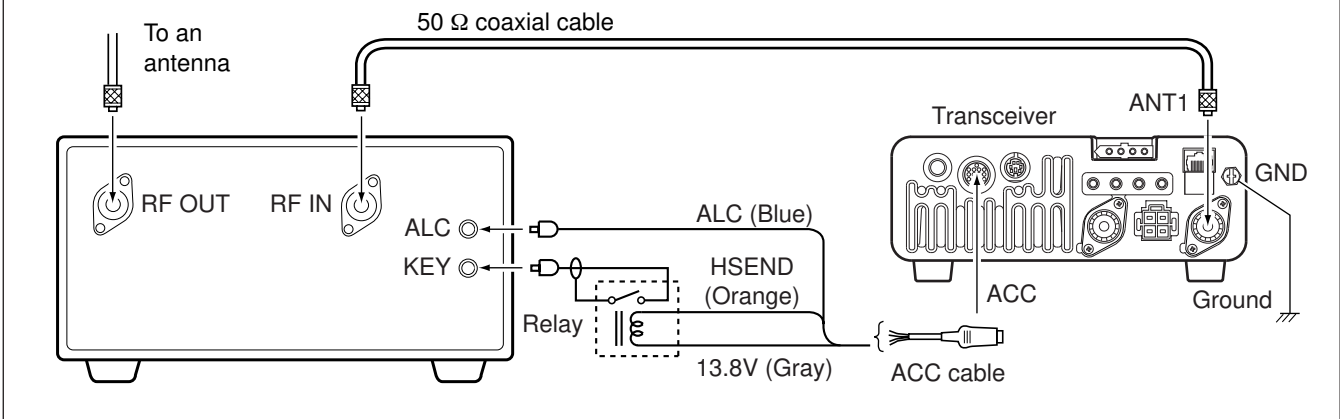

## ■ Connections for CW

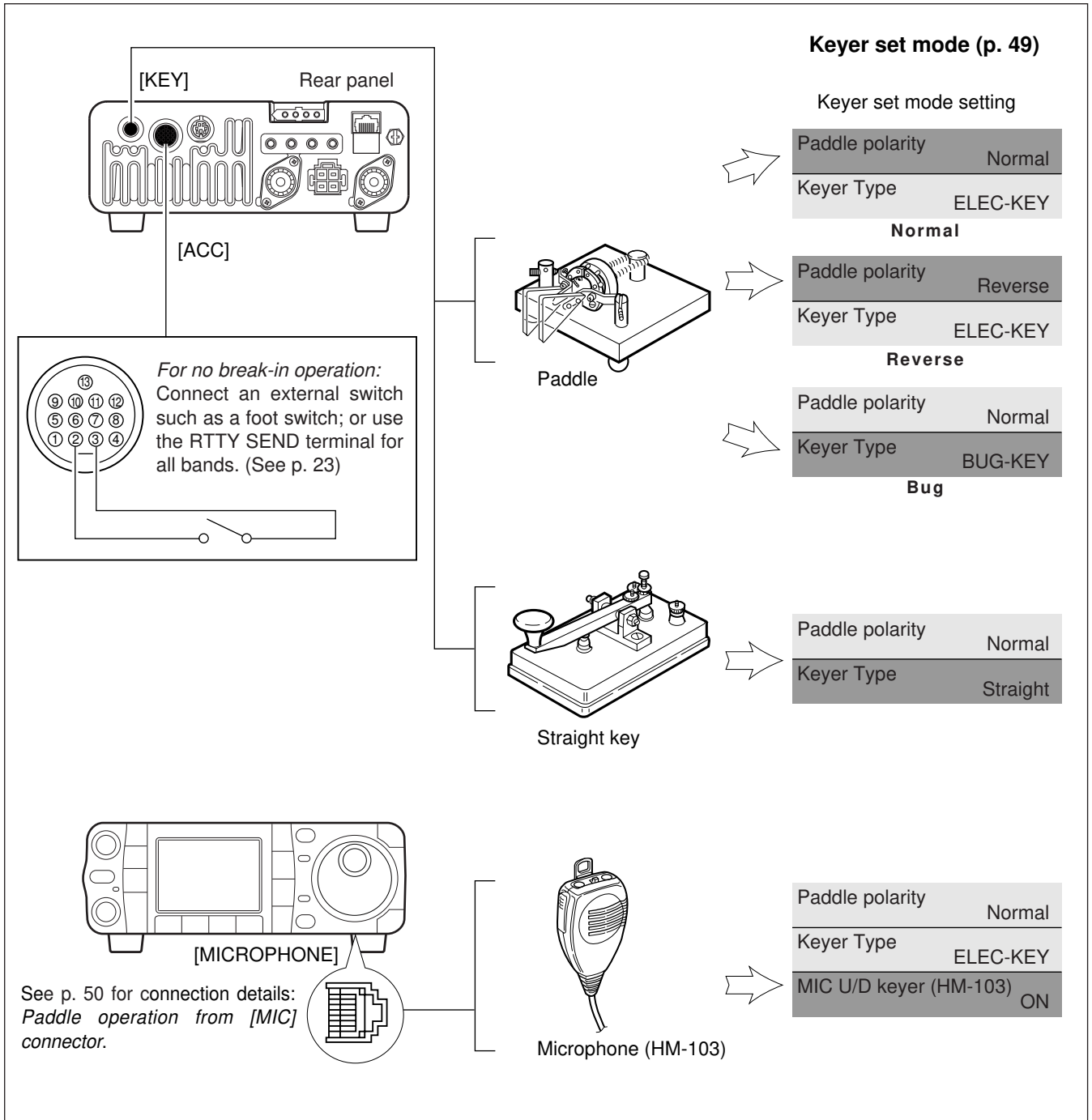

## ■ Connections for RTTY

### ◇ Connections for RTTY (FSK)

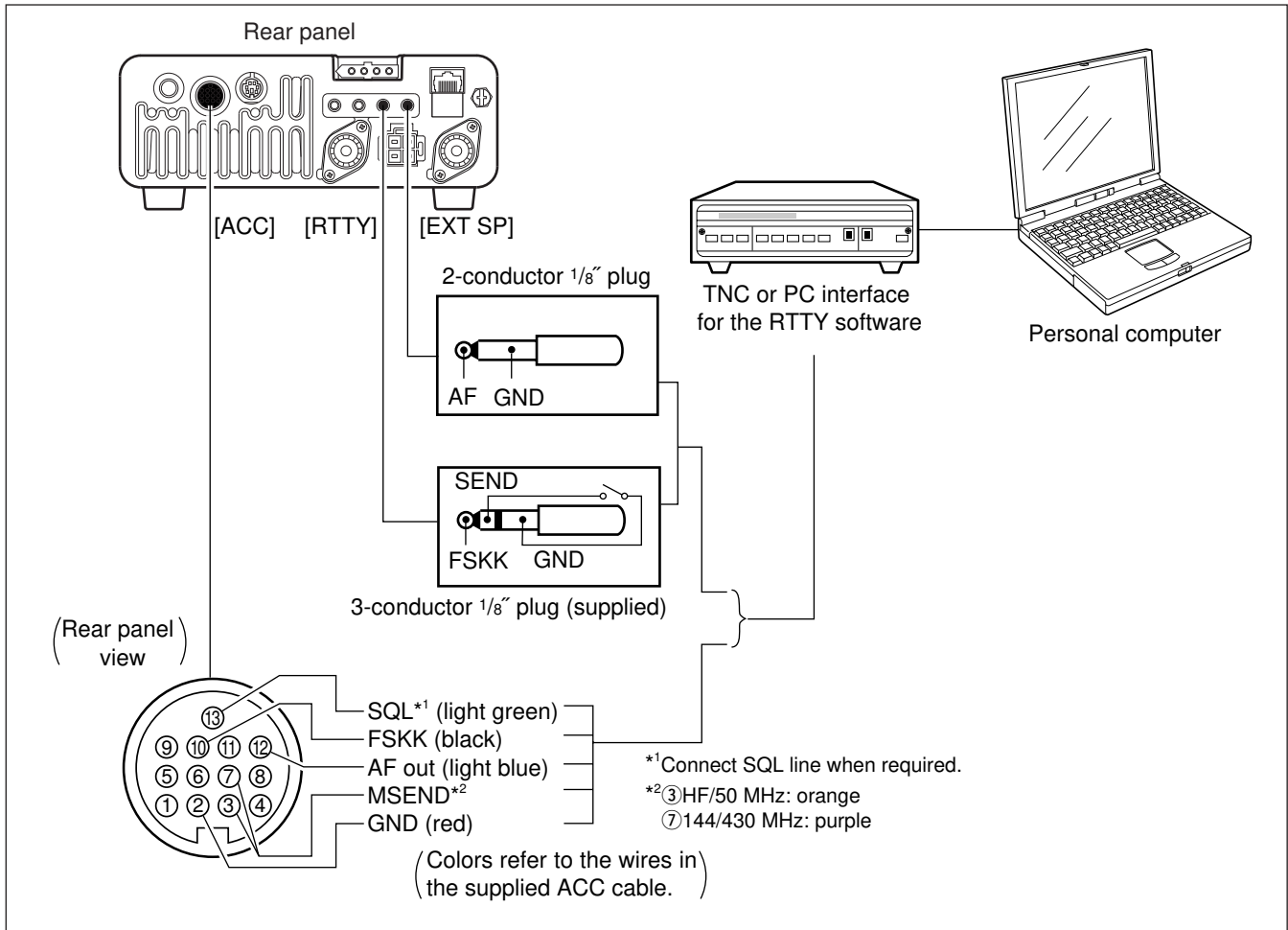

### ◇ Connections for RTTY (AFSK)

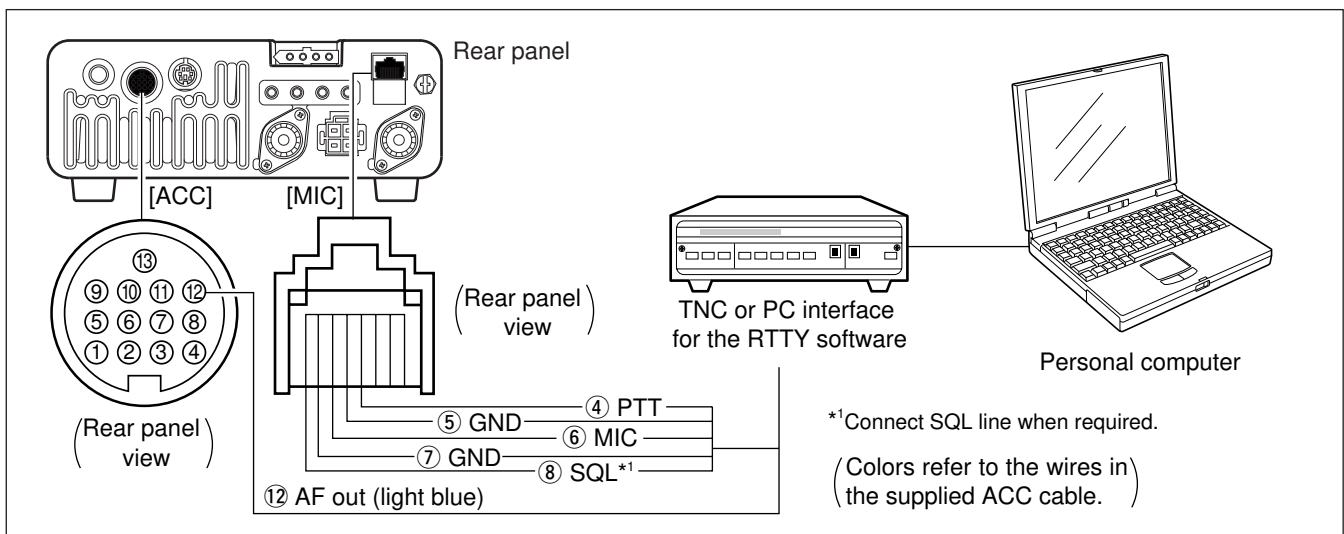



## ■ Connections for packet, SSTV or PSK31

### ◇ When connecting to [DATA] socket

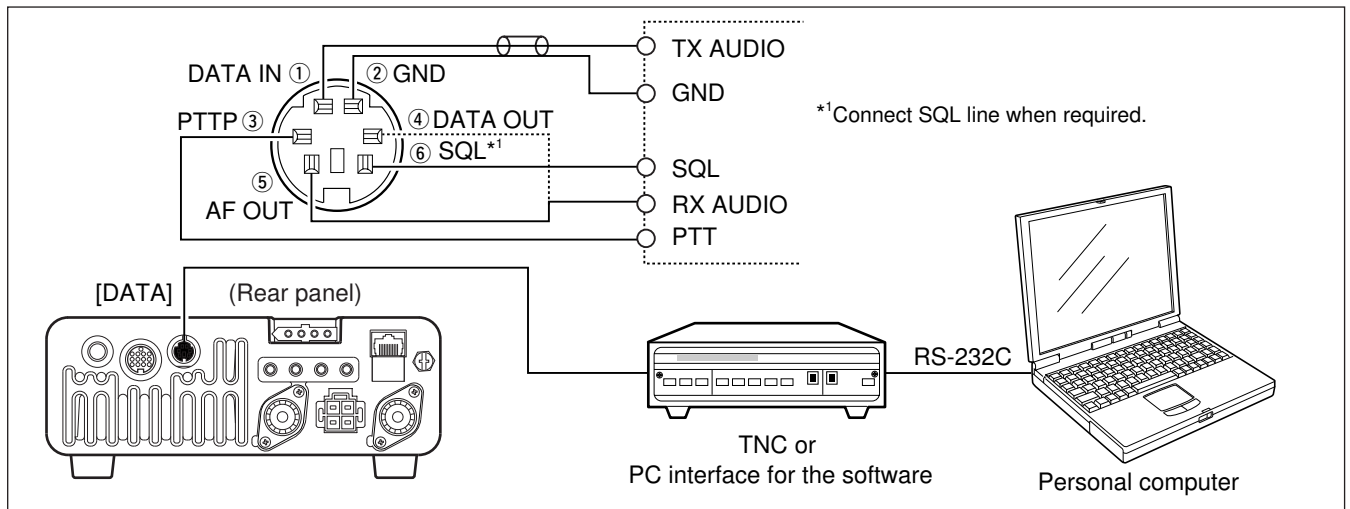

### ◇ When connecting to [ACC] socket

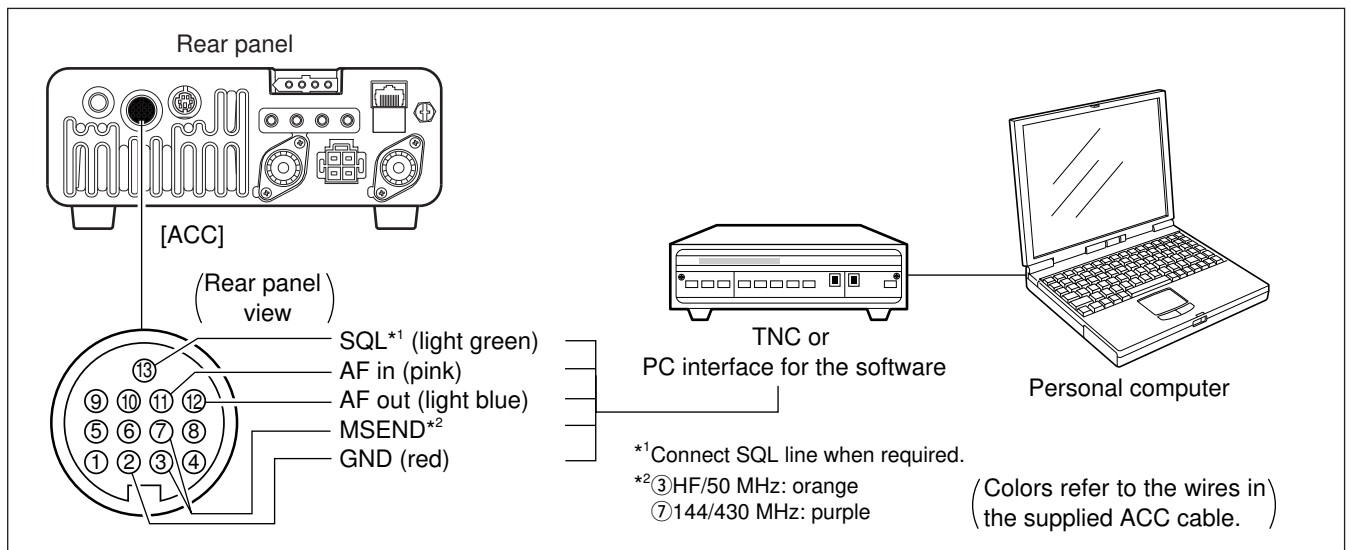

### ◇ When connecting to [MIC] connector

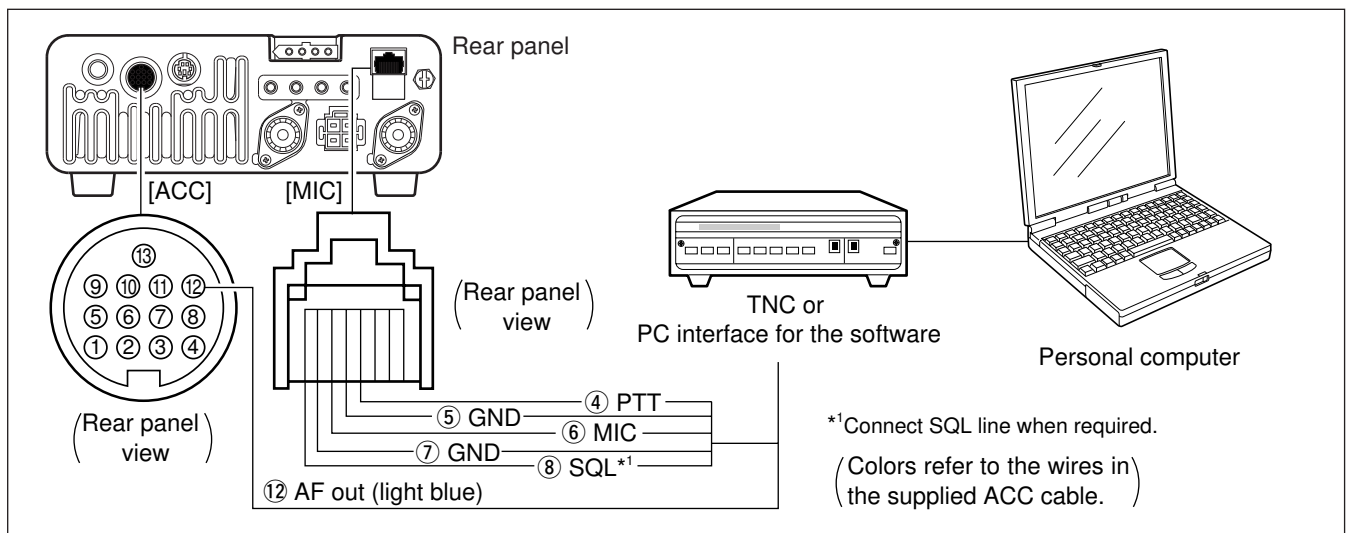

### ■ When first applying power (CPU resetting)

Before first applying power, make sure all connections required for your system are complete by referring to Chapter 2. Then, reset the transceiver using the following procedure.

Resetting **CLEARs** all programmed contents in memory channels and returns default values in set mode.

- ① Make sure the transceiver power is OFF.
- ② While pushing and holding **[▲(BAND)]** and **[▼(BAND)]**, push **[PWR]** to start resetting.
  - The internal CPU is reset.
  - The display changes to 'ALL CLEAR,' 'RF power 100%' and 'Initial frequency and Mode' as shown at right.

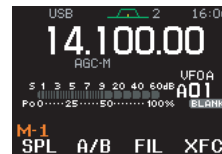
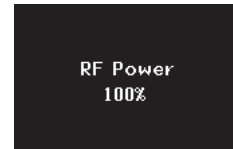
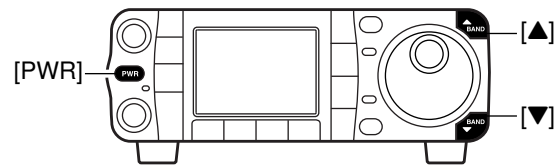

The transceiver's initial frequency and mode

### ◇ Menu resetting (M-1)

If you can't figure out how to return to menu **M-1**: While pushing and holding either **[▲(MENU/GRP)]** or **[▼(MENU/GRP)]**, turn power ON.  
 • The other groups are also reset to **S-1** or **G-1** (Scope) at this time.

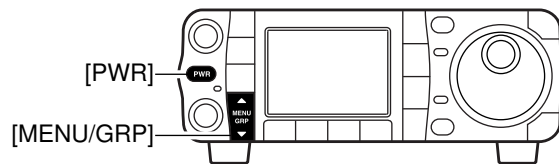

### ■ Initial settings

After resetting the transceiver, set controls and switches as shown in the diagram below.

**CCW : counterclockwise**

**[AF]:** Max. CCW

**[POWER]:** OFF

**[PBT]:** Center  
(Push and hold for 1 sec.)

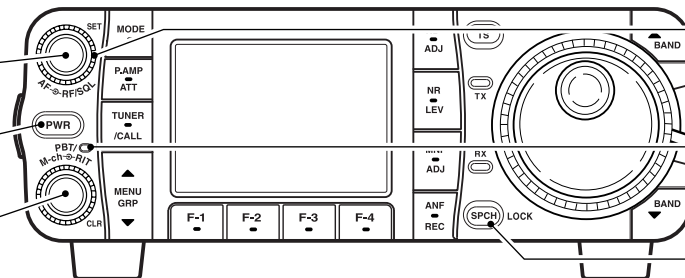

**[RF/SQL]:** Center

**[PBT/M-ch/RIT]:** PBT (indicator lights)

**[LOCK]:** OFF

Turn power ON, then check the display. If any of the following indicators appear, turn them OFF as follows:

- Tuning step indicators, ▼, (SSB, CW or RTTY): Push **[TS]**.
- MHz tuning step indicator, ▼, (FM, WFM or AM): Push **[TS]**
- 1 Hz frequency readout (SSB, CW or RTTY): Push and hold **[TS]**.
- Preamp indicator, **[P.AMP]**: Push **[P.AMP/ATT]**
- Attenuator indicator, **[ATT]**: Push **[P.AMP/ATT]**

- Noise blanker indicator, **[NB]**: Push **[NB/ADJ]**
- Noise reduction indicator, **[NR]**: Push **[NR/LEV]**
- Manual notch indicator, **[MNF]**: Push **[MNF/ADJ]**
- Auto notch indicator, **[ANF]**: Push **[ANF/REC]**
- Memory mode indicator, MEMO: Use **[F-4 U/M]** in the **M-2** menu (p. 27).
- Split indicator, **[SPL]**: Use **[F-1 SPL]** in the **M-1** menu (p. 89).

## VFO description

VFO is an abbreviation of Variable Frequency Oscillator, and traditionally refers to an oscillator.

The IC-7000 VFO is somewhat different. The VFO display of the IC-7000 acts like a computer's window and can show one frequency and one operating mode.

You can call up a desired frequency to the VFO with the memo pad-read key (p. 110) or the memory transfer function (p. 107). You can also change the frequency with **[DIAL]** and select an operating mode with **[MODE]** key or call up previously accessed frequency and modes with the band stacking register (p. 28).

The IC-7000 has two VFOs, specially suited for split frequency operation. The VFOs are called VFO A and VFO B. You can use the desired VFO to call up a frequency and operating mode for operation.

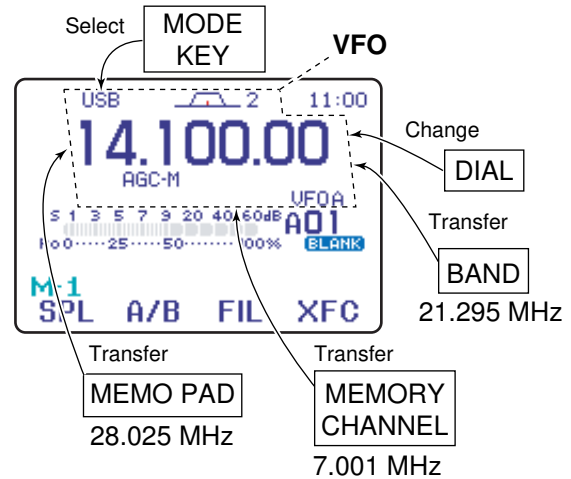

### Differences between VFO and memory mode

#### VFO MODE

Each VFO shows a frequency and operating mode. If the frequency or operating mode is changed, the VFO automatically memorizes the new frequency or operating mode.

When VFO settings are changed with frequency and mode from another VFO or memory mode, the last-used frequency and operating mode for that VFO appear.

#### [EXAMPLE]

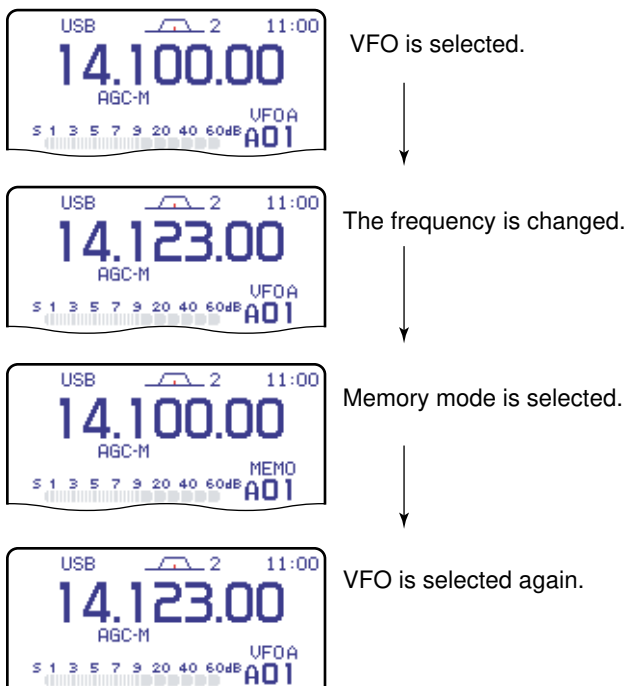

Changed frequency (14.123 MHz) appears.

#### MEMORY MODE (pgs. 100–108)

Each memory channel shows a frequency and operating mode like a VFO. Even if the frequency or mode is changed, the memory channel does not memorize the new frequency or operating mode.

When a memory channel is changed with frequency and mode from another memory channel or VFO mode, the memorized frequency and operating mode appear.

#### [EXAMPLE]

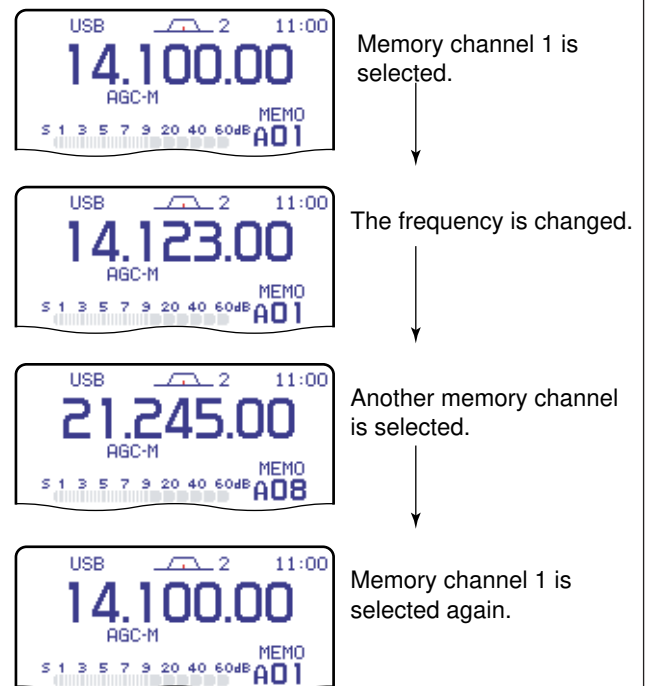

Changed frequency (14.123 MHz) does not appear and memorized frequency (14.100 MHz) appears instead.

## ■ VFO operation

### ◇ Selecting VFO A/VFO B

① Select **M-1**.

#### Menu group selection

Push **[MENU/GRP]** for 1 sec.  
Selection from: **M**, **S** or **G(Graphic)**

#### Menu selection (Example: M)

Push **[MENU/GRP]** momentarily.  
Selection from: **M-1**, **M-2** or **M-3**



Either  
△ or ▽

② Push **[F-2 A/B]** to toggle VFO A or VFO B.

Either "VFOA" or "VFOB" appears.

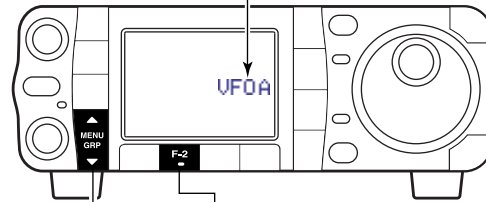

[MENU/GRP] [F-2]

### ◇ VFO equalization

① Select **M-1**.

② Push and hold **[F-2 A/B]** for 1 sec. to set the undisplayed VFO frequency and mode to those of the displayed VFO.

- Three beeps sound when the VFO equalization is completed.

#### CONVENIENT

#### Use two VFOs as a quick memory

When you find a new station, but you wish to continue searching, the Two-VFO system can be used for quick memory storage.

- ① Push **[F-2 A/B]** for 1 sec. to store the displayed frequency into the undisplayed VFO.
- ② Continue searching for stations.
- ③ Push **[F-2 A/B]** to retrieve the stored frequency.
- ④ To continue searching for a station, push **[F-2 A/B]** again.

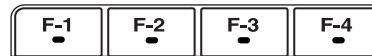
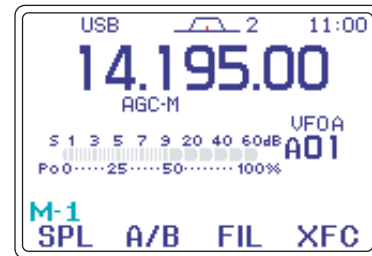

Push **[F-2]** for 1 sec.,  
then push **[F-2]** again.

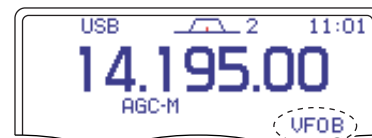

## ■ Selecting VFO/memory mode

① Select **M-2**.

② Push **[F-4 U/M]** to toggle VFO and memory modes.

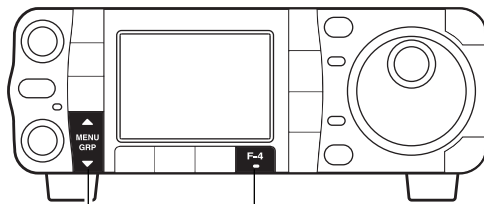

[MENU/GRP] [F-4]

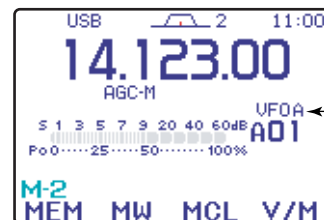

← "VFO" indicator



← Memory channel indicator

## ■ Selecting an operating band

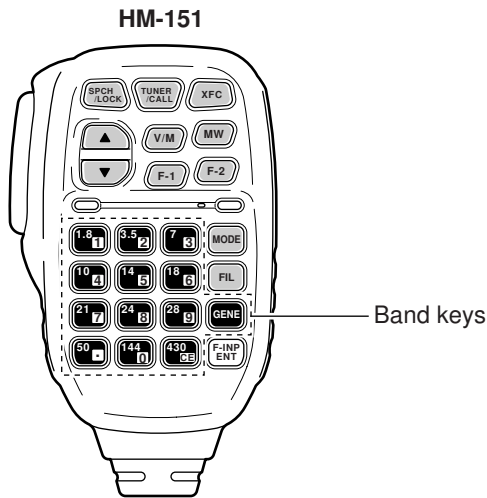

The triple band stacking register provides 3 memories in one band. 3 sets of frequency and operating mode on each band are automatically stored when used.

If a band key (on the HM-151) is pushed once, the last used frequency and operating mode on that band are called up. When the key is pushed again, another stored frequency and operating mode are called up.

This function is convenient when you operate 3 operating modes on one band. For example, one register is used for a CW frequency, another for an SSB frequency and the other one for an RTTY frequency.

See the table below for a list of the bands available and the default settings for each band.

BAND	REGISTER 1	REGISTER 2	REGISTER 3
1.8 MHz	1.900000 MHz CW	1.910000 MHz CW	1.915000 MHz CW
3.5 MHz	3.550000 MHz LSB	3.560000 MHz LSB	3.580000 MHz LSB
7 MHz	7.050000 MHz LSB	7.060000 MHz LSB	7.020000 MHz CW
10 MHz	10.120000 MHz CW	10.130000 MHz CW	10.140000 MHz CW
14 MHz	14.100000 MHz USB	14.200000 MHz USB	14.050000 MHz CW
18 MHz	18.100000 MHz USB	18.130000 MHz USB	18.150000 MHz USB
21 MHz	21.200000 MHz USB	21.300000 MHz USB	21.050000 MHz CW
24 MHz	24.950000 MHz USB	24.980000 MHz USB	24.900000 MHz CW
28 MHz	28.500000 MHz USB	29.500000 MHz USB	28.100000 MHz CW
50 MHz	50.100000 MHz USB	50.200000 MHz USB	51.000000 MHz FM
144 MHz	145.000000 MHz FM	145.100000 MHz FM	145.200000 MHz FM
430 MHz	433.000000 MHz FM	433.100000 MHz FM	433.200000 MHz FM
General	15.000000 MHz USB	15.100000 MHz USB	15.200000 MHz USB

## ◇ Using the band stacking registers

[Example]: 14 MHz band

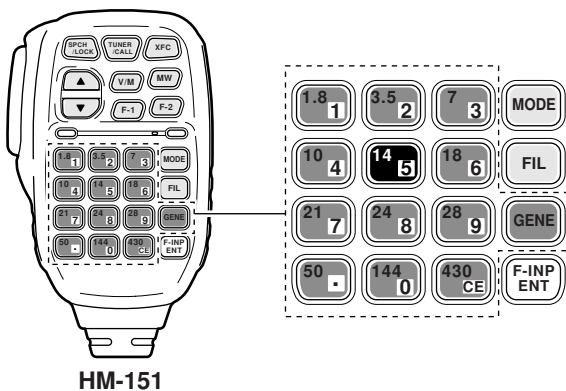

- ① Push **[(14)5]**, then select a frequency and an operating mode.
  - Frequency and operating mode are memorized in the first band stacking register.
- ② Push **[(14)5]** again, then select another frequency and operating mode.
  - This frequency and operating mode are memorized in the second band stacking register.
- ③ Push **[(14)5]** again, then select another frequency and operating mode.
  - This frequency and operating mode are memorized in the third band stacking register.
  - When a fourth frequency and operating mode are selected on a band, the first register set in step ①, is overwritten.

## Frequency setting

The transceiver has several tuning methods for convenient frequency tuning.

### ◇ Tuning with the main dial

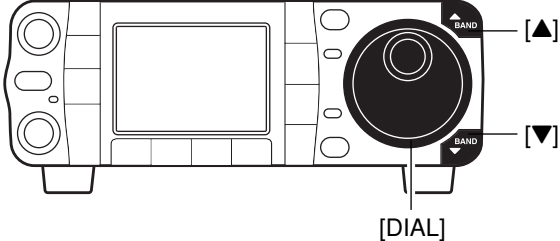

[DIAL]

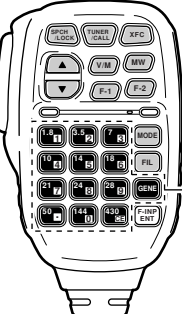

Band keys

- ① Push [**▲(BAND)**] or [**▼(BAND)**] to select the desired band. Or push the desired band key on the microphone 1–3 times.
  - Three different frequencies can be selected on each band with the microphone’s band key. (See previous page “Using the band stacking register.”)



- ② Rotate [**DIAL**] to set the desired frequency.



/// If the dial lock function is activated, “**—**” indicator lights, and [**DIAL**] does not function. In this case, push [**SPCH/LOCK**] to deactivate the lock function. (p. 37)

### ◇ Direct frequency entry with the microphone’s keypad

The HM-151 has a keypad for direct frequency entry as described right.

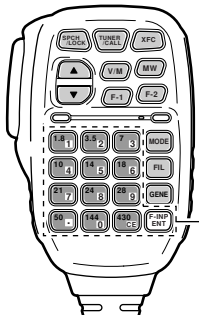

Keypad

- ① Push [**F-INP/ENT**].
  - “**F-INP**” appears.
- ② Input the desired frequency.
  - Push [**(50)•**] to input “• (decimal point)” between the MHz digits and kHz digits.
- ③ Push [**F-INP/ENT**] to set the input frequency.
  - To cancel the input, push [**CE**] instead of [**F-INP/ENT**].

**[EXAMPLES]**

14.025 MHz    **F-INP/ENT** **1.8** **1** **0** **4** **50** **144** **0** **3.5** **2** **14** **5** **F-INP/ENT**

18.0725 MHz    **F-INP/ENT** **1.8** **1** **24** **8** **50** **144** **0** **21** **7** **3.5** **2** **14** **5** **F-INP/ENT**

706 kHz    **F-INP/ENT** **144** **0** **50** **21** **7** **144** **0** **18** **6** **F-INP/ENT**

5.100 MHz    **F-INP/ENT** **14** **5** **50** **1.8** **1** **F-INP/ENT**

7.000 MHz    **F-INP/ENT** **21** **7** **F-INP/ENT**

21.280 → 21.245    **F-INP/ENT** **50** **3.5** **2** **10** **4** **14** **5** **F-INP/ENT**

### ◇ Programmable tuning step

The operating frequency can be changed in steps of (0.01 (AM/FM/WFM only), 0.1, 1, 5, 9, 10, 12.5, 20, 25 or 100 kHz selectable) for quick tuning.

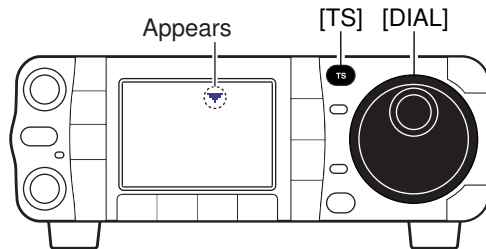

① Push **[TS]** momentarily to turn the programmable tuning function ON.

• “▼” appears when the programmable tuning function is ON.

Programmable tuning step indicator



② Rotate **[DIAL]** to change the frequency in programmed kHz steps.

③ Push **[TS]** again to turn the programmable tuning function OFF.

• “▼” disappears.

④ Rotate **[DIAL]** for normal tuning, if desired.

### ◇ Selecting “kHz” step

Programmable tuning steps are available to suit your operating requirements.

These tuning steps are:

- Independently selectable for each mode
- Selectable from 0.01 (AM/FM/WFM only), 0.1, 1, 5, 9, 10, 12.5, 20, 25 and 100 kHz

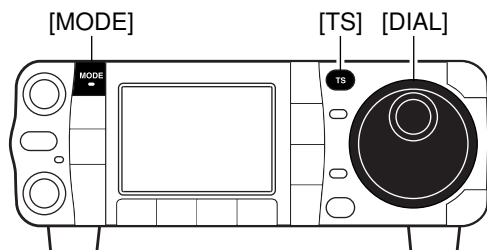

① Push **[TS]** momentarily to turn the programmable tuning step ON.

• “▼” appears when the programmable tuning function is ON.

② Push and hold **[TS]** for 1 sec. to enter the tuning step setting display.

• The tuning step setting for the selected mode appears.

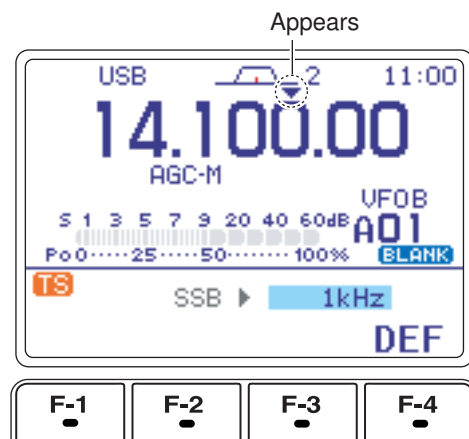

③ Select the desired operating mode with **[MODE]**. (see p. 34)

④ Rotate **[DIAL]** to select the desired tuning step from 0.01 (FM/WFM/AM only), 0.1, 1, 5, 9, 10, 12.5, 20, 25 or 100 kHz.

• Push and hold **[F-4 DEF]** for 1 sec. to return to the default setting, if desired.

⑤ Repeat steps ③ and ④ to select the “kHz” tuning steps for other modes, if desired.

⑥ Push **[TS]** (or **[▼(MENU/GRP)]**) to exit the setting display.

◇ Selecting 1 Hz or 10 Hz step (SSB/CW/RTTY only)

When neither the quick tuning step or programmable tuning step “▼” appear, rotating **[DIAL]** changes the frequency in increments of 1 or 10 Hz. These tuning steps are only available in SSB, CW and RTTY modes.

- ① Select SSB, CW or RTTY mode if necessary.
- ② Push and hold **[TS]** for 1 sec. to toggle between the 1 Hz and 10 Hz step settings.
  - When the 1 Hz step is selected, the 1 Hz digit appears in the frequency indication; when the 10 Hz step is selected, the 1 Hz digit disappears from the frequency indication.
  - Rotating **[DIAL]** changes the frequency in 1 Hz or 10Hz tuning step.

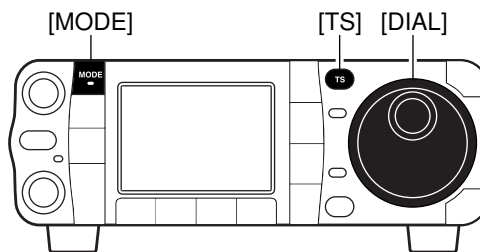

Rotating **[DIAL]** changes the frequency in 10 Hz steps.

Push and hold **[TS]** for 1 sec.



Rotating **[DIAL]** changes the frequency in 1 Hz steps.

◇ 1 MHz quick tuning step (FM/WFM/AM only)

The quick tuning step function allows you to change the frequency in 1 MHz steps when rotating **[DIAL]**. This function is only available in FM, WFM and AM modes.

- ① Select FM, WFM or AM mode if necessary.
- ② Push **[TS]** momentarily to toggle between the 1 MHz tuning step and the programmable tuning step.
  - “▼” appears above the 1 MHz indicator when the 1 MHz tuning step is selected.
  - Rotating **[DIAL]** changes the frequency 1 MHz.

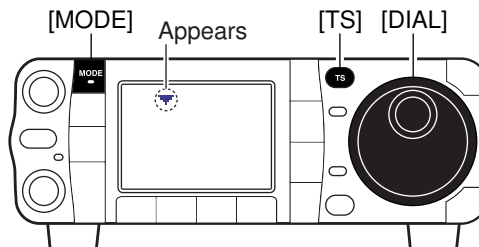

Quick tuning step indicator



Rotating **[DIAL]** changes the frequency in 1 MHz steps.





• [TS] switch flow chart

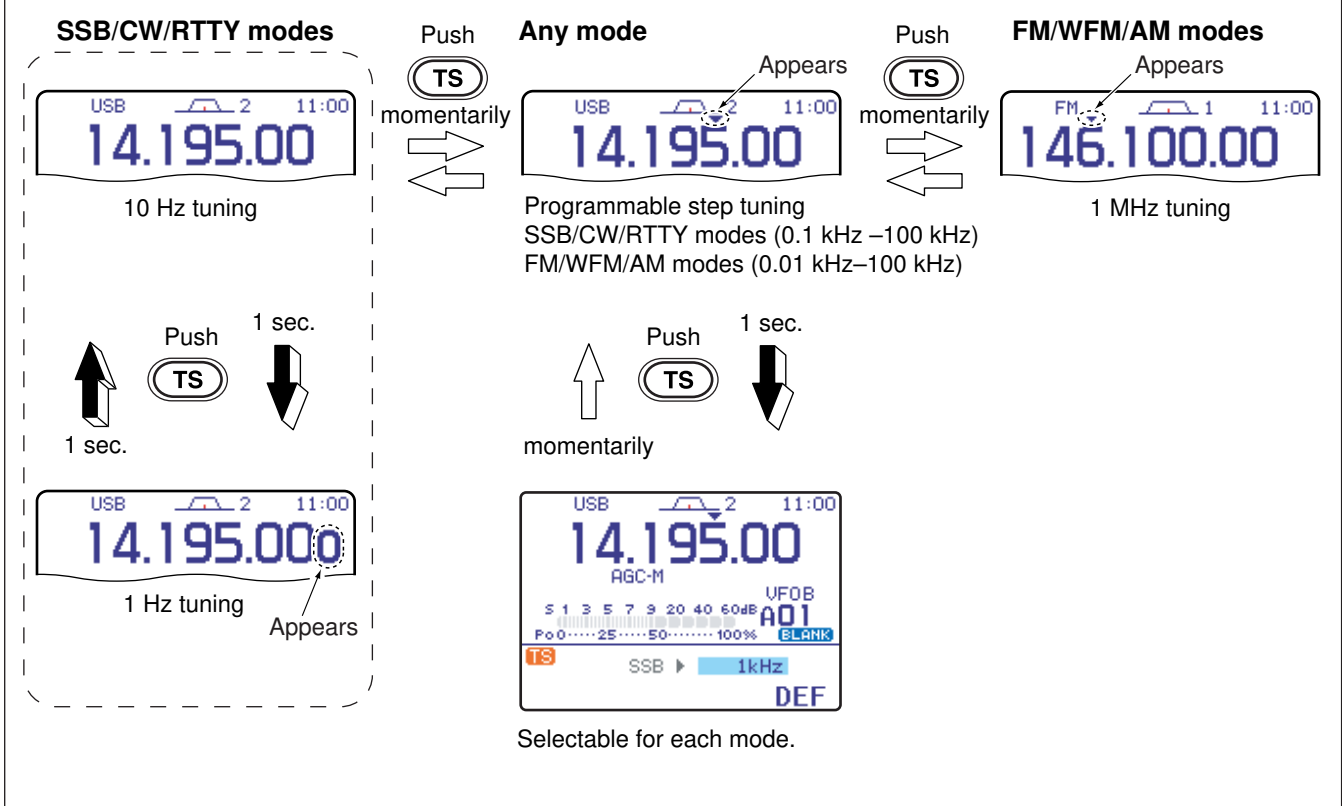

◇ 1/4 tuning function (CW/RTTY only)

While operating in CW/RTTY, the 1/4 tuning function is available for critical tuning. Dial sensitivity is reduced to 1/4 of normal when the 1/4 function is in use.

- ① Select **M-3**.
  - Push and hold **[MENU/GRP]** for 1 sec. once or twice to select the menu group **M**.
  - Push **[MENU/GRP]** momentarily one or more times to select the menu **M-3**.
- ② Push **[F-2 1/4]** to toggle the 1/4 function ON and OFF.
  - “

[MENU/GRP] [F-2]

Appears

**NOTE:** This function is only available when the programmable tuning step is OFF (p. 30).

### ◆ Auto tuning step function

When rotating the tuning dial rapidly, the tuning speed accelerates automatically as selected.

- ① Push **[AF(SET)]** momentarily to enter the set mode menu.
- ② Push **[F-4 OTH]** to enter the miscellaneous (others) set mode.
- ③ Push **[F-1 ▲]** or **[F-2 ▼]** to select "MAIN DIAL Auto TS."
- ④ Rotate **[DIAL]** to select the desired tuning speed from high, low and OFF.
  - HIGH: Approx. 5 times faster
  - LOW : Approx. twice faster
  - OFF : Auto tuning step is turned OFF
  - Push **[F-4 DEF]** for 1 sec. to return to default setting.
- ⑤ Push **[▼(MENU/GRP)]** twice to return to the normal operating mode.

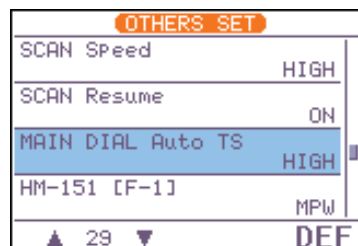
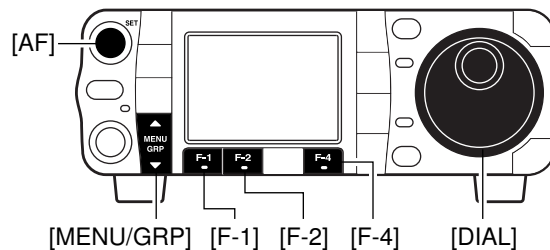

### ◆ Band edge warning beep

When selecting a frequency that lies outside of a band's specified frequency range, a warning beep sounds.

This function can be turned OFF in set mode, if desired.

- ① Enter the miscellaneous (others) set mode as above.
- ② Push **[F-1 ▲]** or **[F-2 ▼]** to select "Beep (Band Edge)," then rotate **[DIAL]** to select the desired setting.
  - Push **[F-4 DEF]** for 1 sec. to return to default setting.
- ③ Push **[▼(MENU/GRP)]** twice to return the normal operating mode.

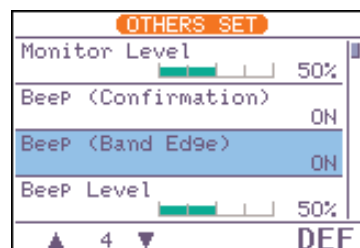

## ■ Volume setting

Rotate **[AF]** control clockwise to increase; counter-clockwise to decrease the audio output level.

- Set a suitable audio level.

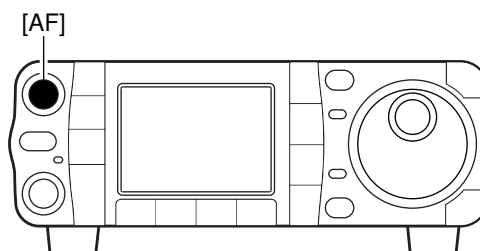
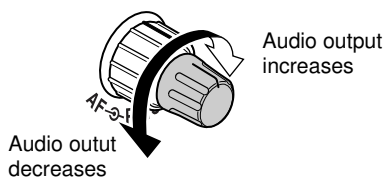

## ■ Operating mode selection

The following modes are available in the IC-7000: SSB (LSB/USB), CW, CW-R (CW reverse), RTTY, RTTY-R (RTTY reverse), AM, FM and WFM (receive only).

To select the desired mode of operation, push **[MODE]** one or more times, then push **[MODE]** for 1 sec., if necessary. See the diagram at right for the order of selection.

• The selected mode is indicated in the function display.

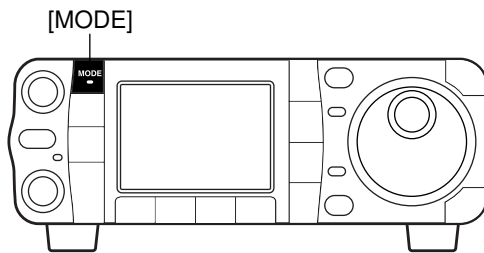

**NOTE:** If a desired mode cannot be selected, it may be hidden because of a setting in the miscellaneous (others) set mode (pgs. 134, 135).

### OPERATING MODE SELECTION

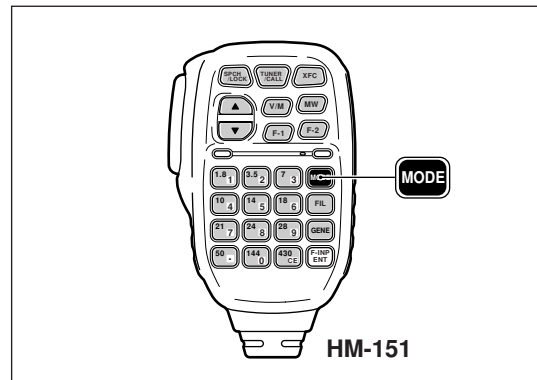
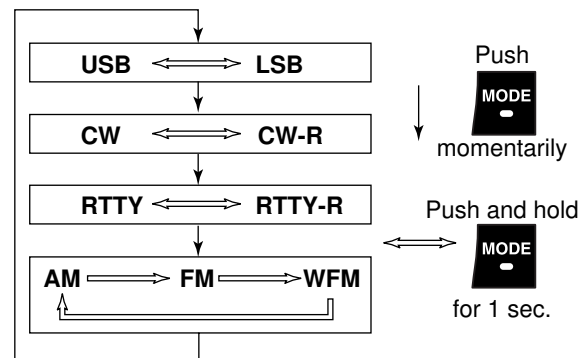

## ■ Voice synthesizer function

The IC-7000 has a voice synthesizer function. This function announces the S-meter level, operating frequency and mode (S-meter level's announcement can be deactivated—p. 132) in a clear, electronically generated voice, in English (or Japanese).

- ① Select the desired parameters to be announced, such as Audio level, speed, language, contents, in the miscellaneous (others) set mode. (p. 131)
- ② Push **[SPCH/LOCK]** momentarily to announce the selected contents.
  - Push **[SPCH/LOCK]** momentarily to stop the announcement.

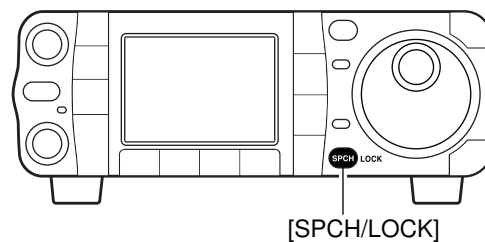

## ■ Squelch and receive (RF) sensitivity

**[RF/SQL]** adjusts the RF gain and squelch threshold level. The squelch removes noise output from the speaker (closed position) when no signal is received.

- The squelch is particularly effective for FM. It is also available for other modes.
- The 12 to 1 o'clock position is recommended for any setting of the **[RF/SQL]** control.
- The control can be set as 'Auto' (RF gain control in SSB, CW and RTTY; squelch control in AM, FM and WFM (RF gain is fixed at maximum) in the miscellaneous (others) set mode as follows (p. 129).

SETTING	OPERATION
RF+SQL (default)	Can be used in all modes. Functions as noise squelch or S-meter squelch in FM mode; S-meter squelch only in other modes.
SQL	Operates as a squelch control. • RF gain is fixed at maximum sensitivity.
AUTO	Operates as an RF gain control in SSB, CW and RTTY modes. • Squelch is fixed open. Operates as a squelch control in AM, FM and WFM modes. • RF gain is fixed at maximum sensitivity.

### Adjusting RF gain (Receive sensitivity)

Normally, **[RF/SQL]** is set to the 11 o'clock position. Rotate **[RF/SQL]** to the 11 o'clock position for maximum sensitivity.

- Rotating counterclockwise from the maximum position reduces sensitivity.
- The S-meter indicates receive sensitivity.

### Adjusting squelch (Removing non-signal noise)

Rotate **[RF/SQL]** clockwise when receiving no signal, until the noise just disappears.

- **[RX]** indicator light goes out.
- Rotating **[RF/SQL]** past the threshold point invokes the S-meter squelch—this allows you to set a minimum signal level needed to open the squelch.

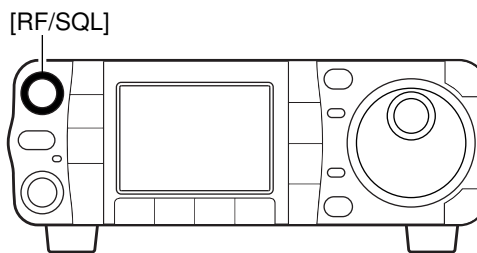

### • When functioning as RF gain/squelch control

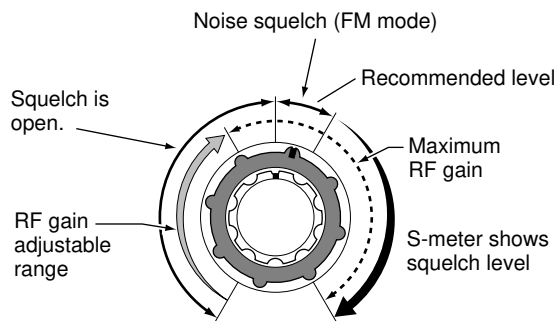

### • When functioning as RF gain control (Squelch is fixed open; SSB, CW, RTTY only)

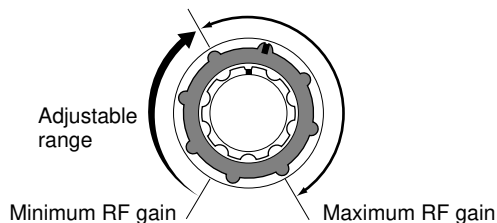

### • When functioning as squelch control (RF gain is fixed at maximum)

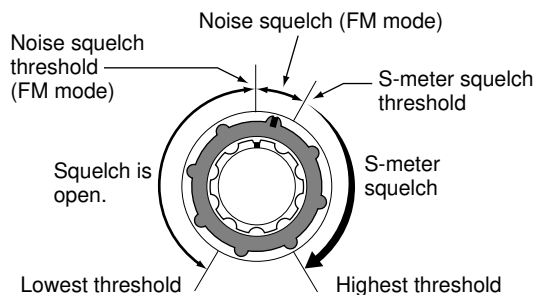

While rotating the RF gain control, noise may be heard. This comes from the DSP unit and does not indicate an equipment malfunction.

## Meter function

The transceiver has 4 transmit meter functions for your convenience. Select the desired meter with the [F-3 MET] in the S-1 display.

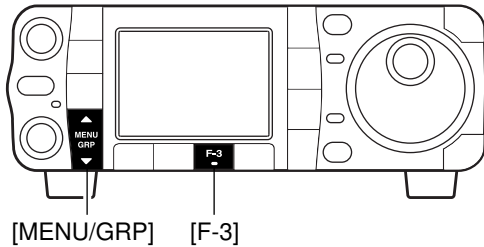

- ① Select S-1.
  - Push and hold [MENU/GRP] for 1 sec. once or twice to select the menu group S.
  - Push [MENU/GRP] momentarily one or more times to select the menu S-1.
- ② Push [F-3 MET] one or more times to select from RF power (Po), SWR, ALC or compression level (COM).
  - The display indication changes as the table at the right.

DISPLAY INDICATION	MEASUREMENT
Po	Indicates the relative RF output power in %.
SWR	Indicates the SWR on the transmission line.
ALC	Indicates the ALC level. When the meter movement shows the input signal level exceeds the allowable level, the ALC limits the RF power. In such cases, reduce the MIC gain setting (see p. 38) in the quick set mode.
COM	Indicates the compression level when the speech compressor is in use.

3

## Multi-function meter

In addition, the transceiver can display the multi-function meter in the graphic display, which displays all transmit meters simultaneously.

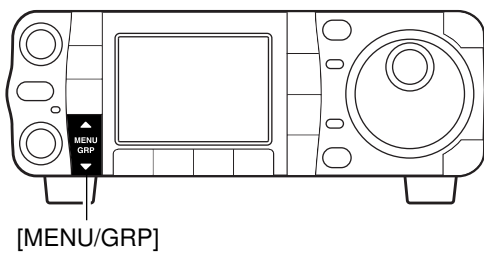

- ➔ Select G-2 (Multi-meter).
  - Push and hold [MENU/GRP] for 1 sec. once or twice to select the menu group G.
  - Push [MENU/GRP] momentarily one or more times to select the menu G-2 (Multi-meter).

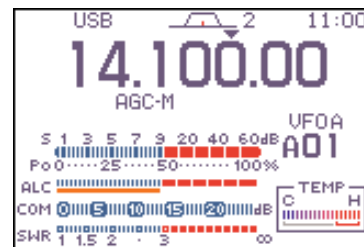

▨ The multi-function meter also displays the internal temperature meter.

### Quick entry

- ➔ Push and hold [▼(BAND)] for 1 sec. to turn the multi-function meter ON and OFF.
  - Push [▼(MENU/GRP)] also to turn OFF.

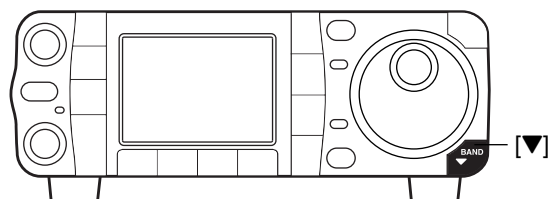

## Lock functions

The lock function can only be activated when displaying frequency, not in set mode or memory channel listing display.

### ◇ Dial lock function

The dial lock function prevents accidental change caused by [DIAL].

- ➔ Push and hold [SPCH/LOCK] for 1 sec. to turn the dial lock function ON and OFF.
  - “” indicator appears while the dial lock function is activated.

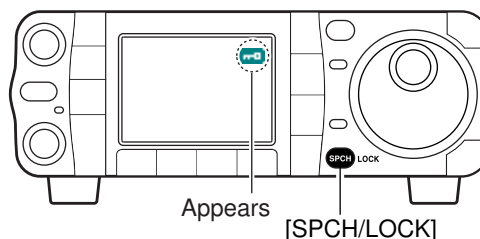

### ◇ Microphone lock function

This function locks microphone keypads.

- ➔ Push and hold [SPCH/LOCK] (microphone) for 1 sec. to toggle the microphone lock function ON and OFF.
  - “MIC LOCK ON” and “MIC LOCK OFF,” popup indicators appear, respectively
  - [PTT] and [SPCH/LOCK] can be used.
  - All keys on the transceiver can be used.

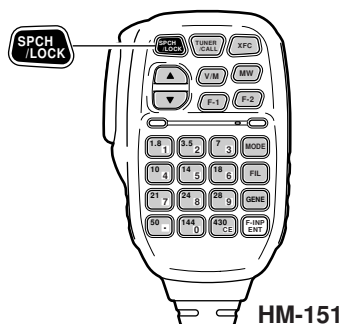

## Basic transmit operation

### ◇ Transmitting

**Before transmitting, monitor your selected operating frequency to make sure transmitting won't cause interference to other stations on the same frequency. It's good Amateur practice to listen first. On the HF bands, even if nothing is heard, ask “is the frequency in use” once or twice, before you begin operating on that frequency.**

- ① Push [PTT] (microphone) to transmit.
  - [TX] indicator lights red.
- ② Release [PTT] (microphone) to return to receive.

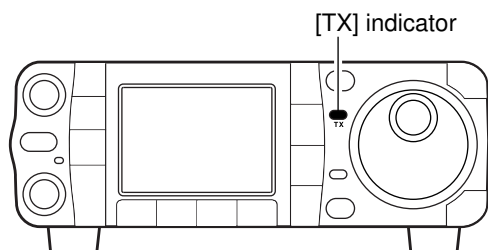
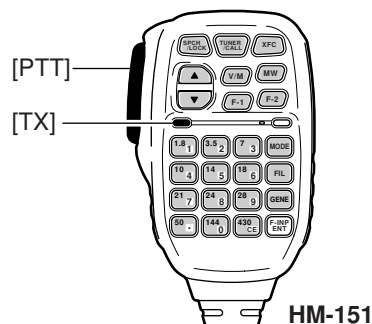

### ◇ Setting output power

- ① Push **[AF(SET)]** momentarily to enter the set mode menu.
- ② Push **[F-1 QS]** to enter the quick set mode.
- ③ Push **[F-1 ▲]** or **[F-2 ▼]** to select “RF Power.”
- ④ Rotate **[DIAL]** to set the desired output setting.
  - Output power is displayed in 1% steps (0% to 100%).
- ⑤ Push **[▼(MENU/GRP)]** to exit quick set mode.

• Available power

BAND	SSB/CW RTTY/FM	AM*
HF	2–100 W	1–40 W
50 MHz	2-100 W	1–40 W
144 MHz	2–50 W	2–20 W
430 MHz	2–35 W	2–14 W

\*Carrier power

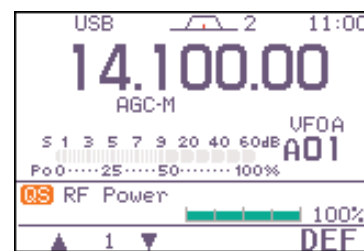
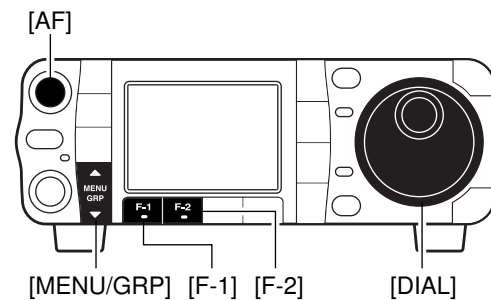

If a linear amplifier is connected such as the IC-PW1/EURO, set the output power using the ALC meter (see below) to the ALC zone (ALC meter reading should be within this zone), otherwise the linear amplifier will not work properly.

### ◇ Setting microphone gain

Microphone gain must be adjusted properly so that your signal is not distorted when transmitted.

- ① Select SSB or another phone mode (AM or FM mode).
- ② Select **S-1**.
  - Push and hold **[MENU/GRP]** for 1 sec. once or twice to select the menu group **S**.
  - Push **[MENU/GRP]** momentarily one or more times to select the menu **S-1**.
- ③ Push **[F-3 MET]** one or more times to select the ALC meter.
  - “ALC” appears.
- ④ Push **[AF(SET)]** momentarily to enter the set mode menu.
- ⑤ Push **[F-1 QS]** to enter the quick set mode.
- ⑥ Push **[F-1 ▲]** or **[F-2 ▼]** to select “MIC Gain.”
- ⑦ Push **[PTT]** (microphone) to transmit.
  - Speak into the microphone at your normal voice level.
- ⑧ While speaking into the microphone, rotate **[DIAL]** so that the ALC meter reading does not go outside the ALC zone.
  - Microphone gain is adjusted in 1% steps (0% to 100%).
- ⑨ Release **[PTT]** (microphone) to return to receive.
- ⑩ Push **[▼(MENU/GRP)]** to exit the quick set mode.
  - Push **[▼(MENU/GRP)]** again to return the normal operating mode.

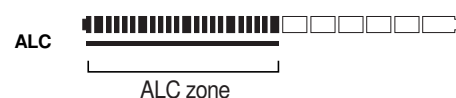
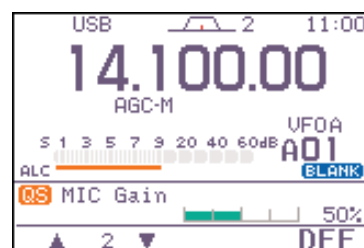
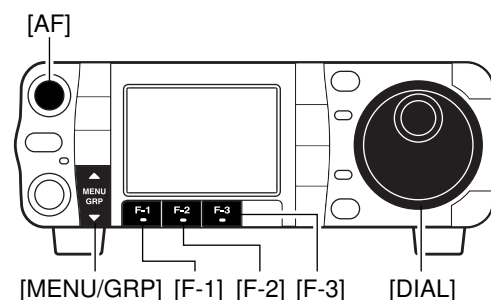

## ■ Operating SSB

- ① Push [**▲(BAND)**]/[**▼(BAND)**] to select the desired band or push a band key on the HM-151.
- ② Push [**MODE**] momentarily or push and hold for 1 sec. to select LSB or USB mode.
  - Below 10 MHz LSB is automatically selected; above 10 MHz USB is automatically selected.
- ③ Rotate [**DIAL**] to tune in a desired signal.
  - The S-meter indicates received signal strength when signal is received.
- ④ Rotate [**AF**] to set audio to a comfortable listening level.
- ⑤ Push [**PTT**] (microphone) to transmit.
  - [**TX**] indicator lights red.
- ⑥ Speak into the microphone at your normal voice level.
  - Adjust 'MIC Gain' at this step, if necessary. (p. 38)
- ⑦ Release [**PTT**] (microphone) to return to receive.

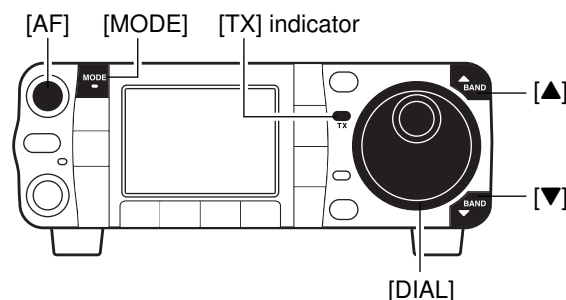

"LSB" or "USB" appears

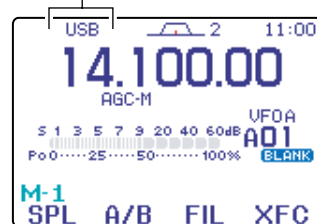

## ◇ Convenient functions for receive

- **Preamp and attenuator** (p. 72)
  - ➔ Push [**P.AMP/ATT**] momentarily to turn the preamp ON or OFF.
    - "**F.AMP**" appears when the preamp is set to ON.
  - ➔ Push [**P.AMP/ATT**] for 1 sec. to turn the attenuator ON.
    - Push [**P.AMP/ATT**] momentarily to turn the attenuator OFF.
    - "**ATT**" appears when the attenuator is set to ON.
- **Twin PBT (passband tuning)** (p. 77)
  - ➔ Push [**PBT/M-ch/RIT**] (switch) momentarily once or twice to select the twin PBT ON or OFF (M-ch RIT).
    - PBT indicator lights green when the twin PBT is selected.
  - ➔ Rotate [**PBT/M-ch/RIT**] (controls—inner/outer).
    - Push [**PBT/M-ch/RIT(CLR)**] to clear the settings.
- **AGC (auto gain control)** (p. 74)
  - ➔ While "**M-3**" is selected, push [**F-3 AGC**] momentarily one or more times to select AGC fast, AGC middle and AGC slow.
    - Push and hold [**MENU/GRP**] for 1 sec. once or twice to select the menu group **M**.
    - Push [**MENU/GRP**] momentarily one or more times to select the menu **M-3**.
    - "**AGC-F**," "**AGC-M**" and "**AGC-S**" appears when the fast time constant, middle time constant and slow time constant is selected, respectively.
  - ➔ While "**M-3**" is selected, push and hold [**F-3 AGC**] for 1 sec. to enter the AGC set mode.
    - Push [**F-2 FAST**], [**F-3 MID**] or [**F-4 SLOW**] to select the time constant, then rotate [**DIAL**] to adjust the time constant.
- **Noise blanker** (p. 78)
  - ➔ Push [**NB/ADJ**] to turn the noise blanker ON and OFF.
    - "**NB**" appears when the noise blanker is set to ON.
  - ➔ Push and hold [**NB/ADJ**] for 1 sec. to enter the noise blanker set mode, then rotate [**DIAL**] to adjust the threshold level, or noise pulse width.
- **DSP noise reduction** (p. 79)
  - ➔ Push [**NR/LEV**] to turn the DSP noise reduction ON and OFF.
    - "**NR**" appears when the DSP noise reduction is ON.
  - ➔ Push and hold [**NR/LEV**] for 1 sec. to enter the DSP noise reduction level set mode, then rotate [**DIAL**] to adjust the DSP noise reduction level.
- **Manual notch filter** (pgs. 80, 81)
  - ➔ Push [**MNF/ADJ**] to turn the manual notch filter ON and OFF.
    - "**MNF**" appears when the manual notch filter is set to ON.
  - ➔ Push and hold [**MNF/ADJ**] for 1 sec. to enter the manual notch filter set mode.
    - Push [**F-2 NF1**], [**F-3 NF2**] to select the notch filter, push [**F-4 NFw**] to set the filter width, rotate [**DIAL**] to set the notch frequency.
- **Auto notch filter** (p. 80)
  - ➔ Push [**ANF/•REC**] to turn the auto notch filter ON and OFF.
    - "**ANF**" appears when the auto notch filter is set to ON.
- **VSC (voice squelch control)** (p. 82)
  - ➔ While "**S-1**" is selected, push [**F-4 VSC**] to turn the VSC function ON and OFF.
    - "**VSC**" appears when VSC function is set to ON.



### ◇ Convenient functions for transmit

#### • Transmit quality monitor (p. 87)

- Push **[AF(SET)]**, then **[F-4 OTH]** to enter the miscellaneous (others) set mode. Select an item with **[F-1 ▲]/[F-2 ▼]**, then rotate **[DIAL]** to turn the monitor function ON and OFF.

#### • VOX (voice operated transmit) (p. 83)

- While "M-3" is selected, push **[F-1 VOX]** to turn the VOX function ON and OFF.

- Push and hold **[MENU/GRP]** for 1 sec. once or twice to select the menu group M.
- Push **[MENU/GRP]** momentarily one or more times to select the menu M-3.

• "VOX" appears when the VOX function is set to ON.

- While "M-3" is selected, push and hold **[F-1 VOX]** for 1 sec. to enter the VOX set mode.
  - Push **[F-1 ▲]/[F-2 ▼]** to select an item.
  - Rotate **[DIAL]** to set the value/conditions.

#### • Speech compressor (p. 87)

- While "M-3" is selected, push **[F-2 COM]** to turn the speech compressor ON and OFF.

• "COM" appears when the speech compressor is set to ON.

- While "M-3" is selected, push and hold **[F-2 COM]** for 1 sec. to enter the compression level set mode.

• Rotate **[DIAL]** to adjust the compression level.

#### • Transmit filter width (p. 84)

- While "M-3" is selected, push **[F-4 TBW]** momentarily to display the selected transmit filter width.

- While "M-3" is selected, push and hold **[F-4 TBW]** for 1 sec. to select the transmit filter width from narrow, middle and width.

• The transmit filter width window appears for showing the selected transmit filter width each time **[F-4 TBW]** is pushed.

### ◇ About 5 MHz band operation (USA version only)

IC-7000 Display Frequency*	FCC Channel Center Frequency*
5.33050 MHz	5.33200 MHz
5.34650 MHz	5.34800 MHz
5.36650 MHz	5.36800 MHz
5.37150 MHz	5.37300 MHz
5.40350 MHz	5.40500 MHz

To assist you in operating the 5 MHz band correctly within the rules specified by the FCC, transmission is impossible on any 5 MHz band frequency other than the 5 frequencies indicated in the table above.

Operation on the 5 MHz band is allowed on 5 discrete frequencies and must adhere to the following:

- USB mode
- Maximum of 50 watts ERP (Effective Radiated Power)
- 2.8 kHz bandwidth

It is the operator's responsibility to set all controls so that the transmission in this band meets the stringent conditions under which we may use these frequencies.

**NOTE:** We recommend that you store these frequencies, mode and filter settings into the memory channel for easy recall.

\*The channel center frequencies that are specified by the FCC, show the center frequency of their passband. However, the IC-7000 displays carrier point frequency, so set 1.5 kHz below from FCC channel center frequency.

## Operating CW

- ① Connect a paddle or straight key as on page 22.
- ② Push **[▲(BAND)]**/**[▼(BAND)]** to select the desired band or push a band key on the HM-151.
- ③ Push **[MODE]** momentarily to select CW mode.
  - After CW mode is selected, push and hold **[MODE]** for 1 sec. to toggle between CW and CW-R modes.
- ④ Rotate **[DIAL]** to tune in a desired signal with the desired tone frequency.
- ⑤ Rotate **[AF]** to set audio to a comfortable listening level.
- ⑥ Set CW break-in operation as semi break-in, full break-in or OFF.
  - Push and hold **[MENU/GRP]** for 1 sec. once or twice to select the menu group **M**.
  - Push **[MENU/GRP]** momentarily one or more times to select the menu **M-3**.
  - Push **[F-1 BRK]** one or more times to select the CW break-in operation.
  - “**BK-IN**,” “**F-BK**,” and “OFF (no indication)” appears.
    - ▶ **BK-IN** : semi break-in
    - ▶ **F-BK** : full break-in
    - ▶ **OFF** : no break-in (ACC socket connection is necessary as shown on page 22.)
- ⑦ Set the CW delay time when semi break-in operation is selected.
  - Push and hold **[F-1 BRK]** for 1 sec. to enter the break-in delay time set mode.
  - Rotate **[DIAL]** to set the desired delay time.
- ⑧ Set CW setting in the keyer set mode (**S-1**).
  - Push and hold **[MENU/GRP]** for 1 sec. once or twice to select the menu group **S**.
  - Push **[MENU/GRP]** momentarily one or more times to select the menu **S-1**.
  - Push **[F-2 KEY]**, **[▼(MENU/GRP)]**, then **[F-4 SET]** to enter the keyer set mode. (p. 49)
- ⑨ Keying to transmit, use the electric keyer or paddle to send your CW signals.
  - **[TX]** indicator lights red.
  - The Po meter indicates transmitted CW signal strength.
- ⑩ Stop keying to return to receive.

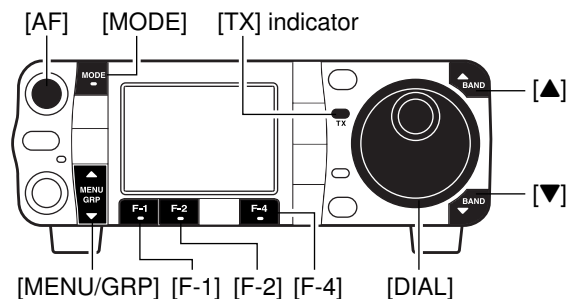

“CW” or “CW-R” appears

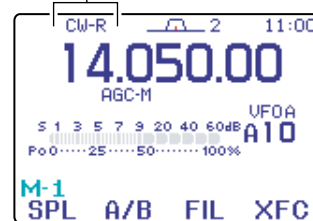

Appears

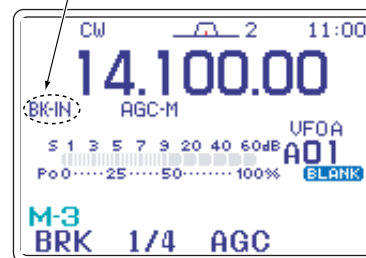

Semi break-in operation is selected.

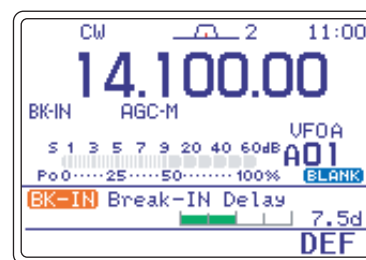

Delay time of 7.5 dots is selected for semi break-in operation.

### ◇ Convenient functions for receive

- **Preamp and attenuator** (p. 72)
  - ➔ Push **[P.AMP/ATT]** momentarily to turn the preamp ON or OFF.
    - “**P.AMP**” appears when the preamp is set to ON.
  - ➔ Push **[P.AMP/ATT]** for 1 sec. to turn the attenuator ON.
    - Push **[P.AMP/ATT]** momentarily to turn the attenuator OFF.
    - “**ATT**” appears when the attenuator is set to ON.
- **Twin PBT (passband tuning)** (p. 77)
  - ➔ Push **[PBT/M-ch/RIT]** (switch) momentarily once or twice to select the twin PBT ON or OFF (M-ch RIT).
    - PBT indicator lights green when the twin PBT is selected.
  - ➔ Rotate **[PBT/M-ch/RIT]** (controls–inner/outer).
    - Push **[PBT/M-ch/RIT(CLR)]** to clear the settings.
- **AGC (auto gain control)** (p. 74)
  - ➔ While “**M-3**” is selected, push **[F-3 AGC]** momentarily one or more times to select AGC fast, AGC middle and AGC slow.
    - Push and hold **[MENU/GRP]** for 1 sec. once or twice to select the menu group **M**.
    - Push **[MENU/GRP]** momentarily one or more times to select the menu **M-3**.
  - “**AGC-F**,” “**AGC-M**” and “**AGC-S**” appears when the fast time constant, middle time constant and slow time constant is selected, respectively.
  - ➔ While “**M-3**” is selected, push and hold **[F-3 AGC]** for 1 sec. to enter the AGC set mode.
    - Push **[F-2 FAST]**, **[F-3 MID]** or **[F-4 SLOW]** to select the time constant, then rotate **[DIAL]** to adjust the time constant.
- **Noise blanker** (p. 78)
  - ➔ Push **[NB/ADJ]** to turn the noise blanker ON and OFF.
    - “**NB**” appears when the noise blanker is set to ON.
  - ➔ Push and hold **[NB/ADJ]** for 1 sec. to enter the noise blanker set mode, then rotate **[DIAL]** to adjust the threshold level, or noise pulse width.
- **DSP noise reduction** (p. 79)
  - ➔ Push **[NR/LEV]** to turn the DSP noise reduction ON and OFF.
    - “**NR**” appears when the DSP noise reduction is set to ON.
  - ➔ Push and hold **[NR/LEV]** for 1 sec. to enter the noise reduction level set mode, then rotate **[DIAL]** to adjust the DSP noise reduction level.
- **Manual notch filter** (pgs. 80, 81)
  - ➔ Push **[MNF/ADJ]** to turn the manual notch filter ON and OFF.
    - “**MNF**” appears when the manual notch filter is set to ON.
  - ➔ Push and hold **[MNF/ADJ]** for 1 sec. to enter the manual notch filter set mode.
    - Push **[F-2 NF1]**, **[F-3 NF2]** to select the notch filter, push **[F-4 NW]** to set the filter width, rotate **[DIAL]** to set the attenuated frequency.
- **1/4 function** (p. 32)
  - ➔ While “**M-3**” is selected, push **[F-2 1/4]** to turn the 1/4 function ON and OFF.
    - “**1/4**” indicator appears when the function is activated.
- **CW pitch control** (p. 44)
  - ➔ Push **[AF(SET)]**, then **[F-1 QS]** to enter the quick set mode. Select an item with **[F-1 ▲]/[F-2 ▼]**, then rotate **[DIAL]** to set the desired CW pitch from 300 to 900 Hz in 5 Hz steps.

### ◇ Convenient functions for transmit

- **Break-in function** (p. 85)
  - ➔ While “**M-3**” is selected, push **[F-1 BRK]** one or more times to select the CW break-in operation.
    - Push and hold **[MENU/GRP]** for 1 sec. once or twice to select the menu group **M**.
    - Push **[MENU/GRP]** momentarily one or more times to select the menu **M-3**.
  - “**BK-IN**” or “**F-BK**” appears when the semi break-in or full break-in is set to ON, respectively.
- **Memory keyer function** (p. 45)
  - ➔ While “**S-1**” is selected, push **[F-2 KEY]** to enter the keyer set menu.

◇ CW reverse mode

The CW-R (CW Reverse) mode receives CW signals on the reverse sideband like that of LSB and USB modes.

Use when interference is near the desired signal and you want to change the interference tone.

- ① Push **[MODE]** momentarily several times to select CW mode.
- ② Push and hold **[MODE]** for 1 sec. to select CW or CW-R mode.
  - Check the interference tone.

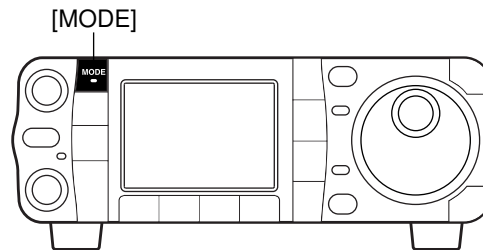

• Receive audio tone response

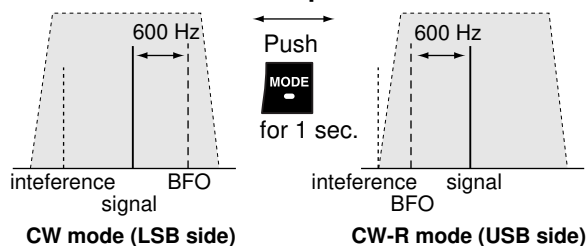

◇ CW side tone function

When the transceiver is in receive condition (and the break-in function is OFF— p. 85) you can listen to the tone of your CW signal without actually transmitting.

This allows you to spot your transmit signal exactly to another station's. This also convenient for CW practice.

- ① When CW (CW-R) mode is selected, enter the quick set mode.
  - Push **[AF(SET)]** momentarily to enter the set mode menu.
  - Push **[F-1 QS]** to enter the quick set mode.
- ② Push **[F-1 ▲]** or **[F-2 ▼]** several times to select "Side Tone Level," then rotate **[DIAL]** to adjust the side tone level.
  - Side tone level is adjusted in 1% steps (0% to 100%).
- ③ Push **[▼(MENU/GRP)]** to exit the quick set mode.
  - Push **[▼(MENU/GRP)]** again to return the normal operating mode.

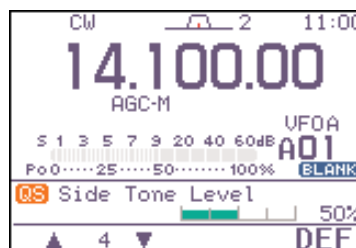
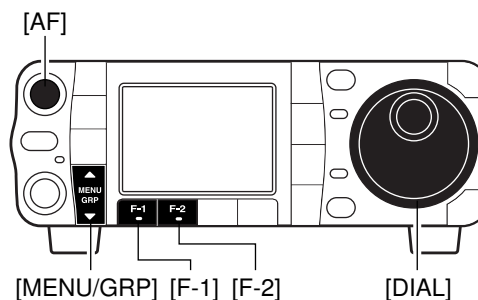

### ◇ CW pitch control

The received CW audio pitch and monitored CW audio pitch can be adjusted to suit your preferences (300 to 900 Hz) without changing the operating frequency.

- ① When CW (CW-R) mode is selected, enter the quick set mode.
  - Push **[AF(SET)]** momentarily to enter the set mode menu.
  - Push **[F-1 QS]** to enter the quick set mode.
- ② Push **[F-1 ▲]** or **[F-2 ▼]** several times to select “CW Pitch,” then rotate **[DIAL]** to set the desired pitch.
  - CW pitch is adjusted in 5 Hz steps (300 to 900 Hz).
- ③ Push **[▼(MENU/GRP)]** to exit the quick set mode.
  - Push **[▼(MENU/GRP)]** again to return the normal operating mode.

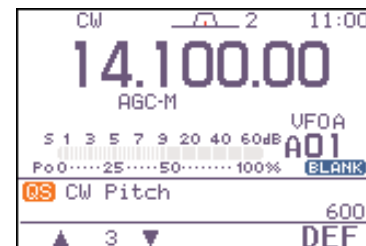
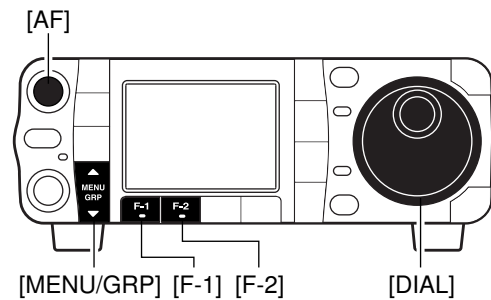

- This shows the default setting for the CW pitch control (600 Hz).

## ■ Electronic CW keyer

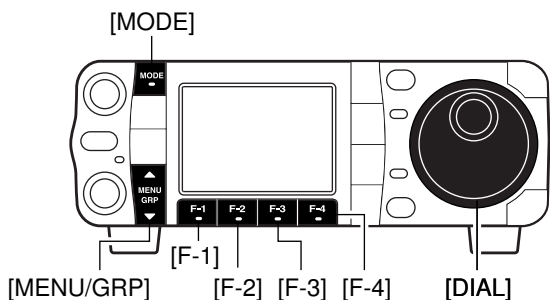

The IC-7000 has a number of convenient functions for the electronic keyer that can be accessed from the memory keyer menu.

- ① Push **[MODE]** to select CW mode.
- ② Select **S-1**. (See right page.)
- ③ Push **[F-2 KEY]** to enter the keyer send menu.
- ④ Push **[▼(MENU/GRP)]** to select the keyer root menu.
- ⑤ Push one of the multi-function keys (**[F-1]** to **[F-4]**) to select the desired menu. See the diagram below.
  - Push **[▼(MENU/GRP)]** to return to the previous indication.

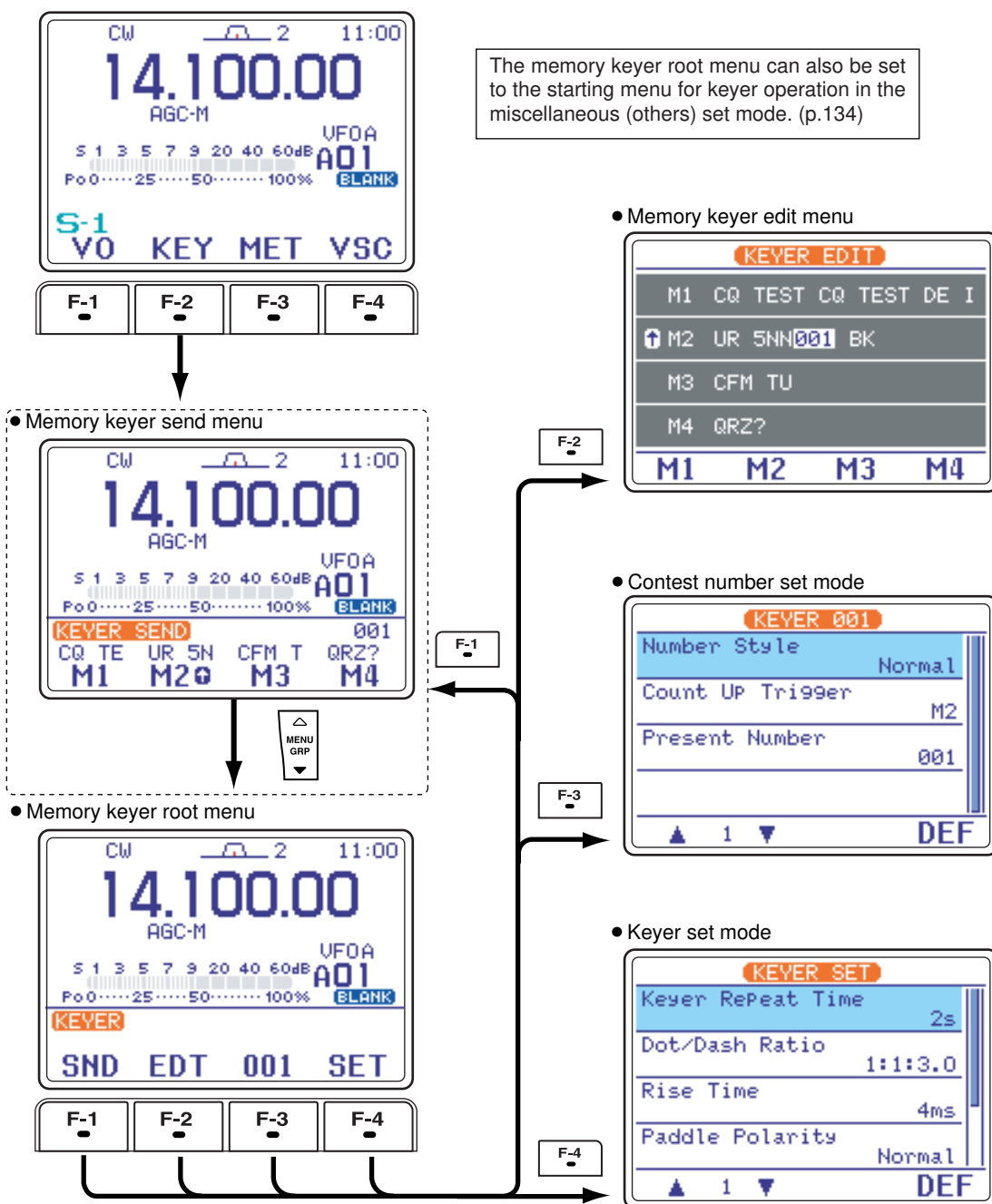

### Menu group selection

Push **[MENU/GRP]** for 1 sec.

Selection from: **M**, **S** or **G**(Graphic)

### Menu selection (Example: S)

Push **[MENU/GRP]** momentarily.

Selection from: **S-1**, **S-2** or **S-3**



Either  
△ or ▽

## ◇ Memory keyer send menu

Pre-set messages can be sent using the memory keyer send menu. Contents of the memory keyer are set using the edit menu.

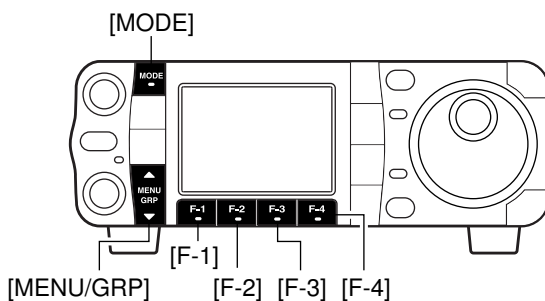

### • Memory keyer send menu

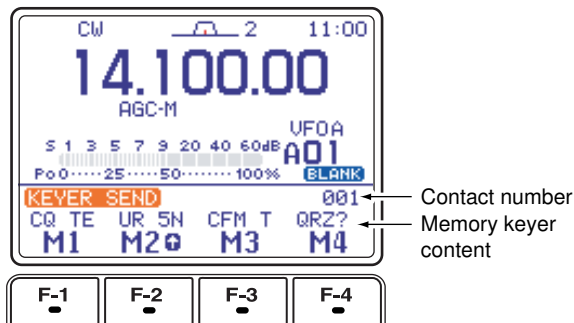

### • Transmitting

- ① Select CW mode with **[MODE]**.
- ② Set the break-in function ON (p. 85).
  - When step ⑤ is performed with the break-in function OFF, the memory keyer contents are monitored.
- ③ Select **S-1**.
- ④ Push **[F-2 KEY]** to enter the keyer send menu.
  - If the keyer root menu appears, push **[F-1 SND]**. The keyer starting menu can be changed in the miscellaneous (others) set mode (p. 134).
- ⑤ Push **[F-1 M1]** – **[F-4 M4]** momentarily to transmit the contents one time; push and hold these keys for 1 sec. to transmit the contents repeatedly.
  - “M1” – “M4” are highlighted while transmitting.
  - “(” and “)” appear while transmitting repeatedly.
  - While transmitting repeatedly, push any function key to cancel the transmission.
  - Set the repeat interval of the memory keyer to 1–60 sec. (1 sec. steps). See p. 49 for keyer set mode.
  - To decrement the contact number, push **[▲(MENU/GRP)]**.
- ⑥ Push **[▼(MENU/GRP)]** twice to exit the memory keyer send menu and return to normal CW mode indication.

◆ Editing a keyer memory

The contents of the memory keyer memories can be set using the memory keyer edit menu. The memory keyer can memorize and re-transmit 4 CW sequences for often-used CW messages, contest number, etc. Total capacity of the memory keyer is 55 characters per memory channel.

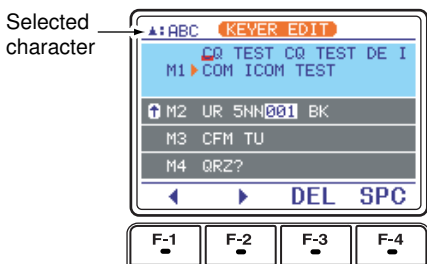
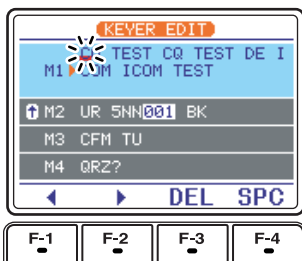
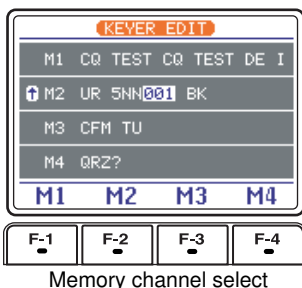
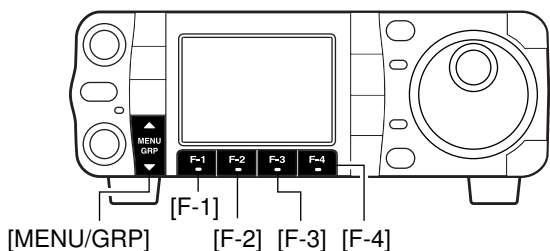

• Pre-programmed contents

CH	Contents
M1	CQ TEST CQ TEST DE ICOM ICOM TEST
M2	UR 5NN* BK
M3	CFM TU
M4	QRZ?

• Programming contents

- ① Push [MODE] to select CW mode.
- ② Select S-1.
  - Push and hold [MENU/GRP] for 1 sec. once or twice to select the menu group S.
  - Push [MENU/GRP] momentarily one or more times to select the menu S-1.
- ③ Push [F-2 KEY] then [▼(MENU/GRP)] to select the keyer root menu.
  - If the keyer root menu appears, skip pushing [▼(MENU/GRP)]. The keyer starting menu can be changed in the miscellaneous (others) set mode. (p. 134)
- ④ Push [F-2 EDT] to enter the keyer edit menu.
- ⑤ Push [F-1 M1] – [F-4 M4] to select the desired keyer memory channel.
- ⑥ Push [▲(MENU/GRP)] several times to select the desired character group ([ABC], [123] or [etc]).

Key selection	Editable characters
ABC	A to Z (capital letters)
123	0 to 9 (numbers)
etc	/ ? ^ . , @ *

NOTE:

“^” is used to transmit a following word with no space such as AR. Put “^” before a text string such as ^AR, and the CW prosign “AR” is sent with no space.  
 “\*” is used to insert the CW contest number. The contest number automatically increments by 1. This function is only available for one memory keyer channel at a time. Memory keyer channel M2 uses “\*” by default.

- ⑦ Select the desired character by rotating [DIAL] or by pushing the band key (HM-151) for the incrementing trigger memory number input.
  - Push [F-1 ←] or [F-2 →] for cursor movement.
  - Push [F-3 DEL] to delete the selected character.
  - Push [F-4 SPC] to input a space.
  - “\*” is for contact numbers and can only be used on the memory channel used to increment the contact number (“i” appears next to that channel).
- ⑧ Repeat steps ⑥ and ⑦ until the desired contents are input.
- ⑨ Push [▼(MENU/GRP)] to return to memory channel selection mode, then select the next memory channel and repeat steps ⑥ and ⑧ for character input, if desired.
- ⑩ Push [▼(MENU/GRP)] twice to exit the keyer edit mode.



## ◇ Contest number set mode

This menu is used to set the contest (serial) number and incrementing trigger channel, etc.

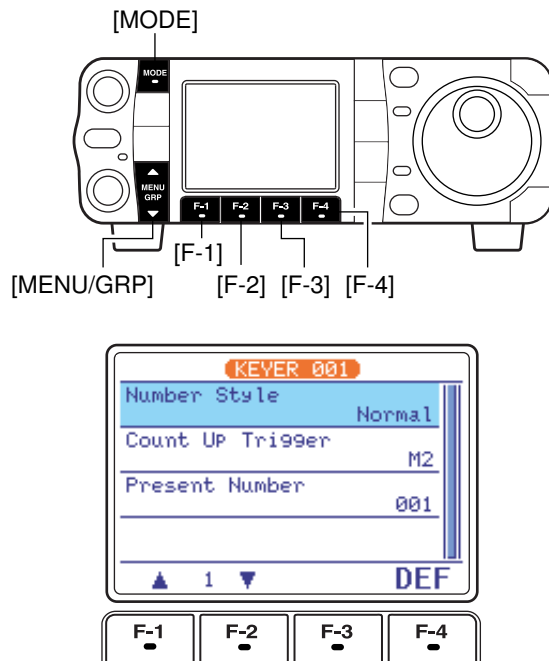

### •Setting the contact (serial) number

Contact number can be automatically transmitted from one of the memory keyer channels. The Morse cut numbers can be used as the contact numbers. The maximum number for contact numbers is 9999.

- ① Select CW mode with **[MODE]**.
- ② Select **S-1**.
  - Push and hold **[MENU/GRP]** for 1 sec. once or twice to select the menu group **S**.
  - Push **[MENU/GRP]** momentarily one or more times to select the menu **S-1**.
- ③ Push **[F-2 KEY]** then **[▼(MENU/GRP)]** to select the keyer root menu.
  - If the keyer root menu appears, skip pushing **[▼(MENU/GRP)]**. The keyer starting menu can be changed in the miscellaneous (others) set mode. (see p.134)
- ④ Push **[F-3 001]** to enter the contest number set menu.
- ⑤ Push **[F-1 ▲]** or **[F-2 ▼]** to select the desired set item.
  - Push and hold **[F-4 DEF]** for 1 sec. to select the default condition or value.
- ⑥ Push **[▼(MENU/GRP)]** twice to exit the contest number set menu and return to normal CW mode indication.

4

### 1 Number Style

This item sets the numbering system used for contest (serial) numbers— normal or cut numbers.

- Normal : Does not use morse cut number (default)
- 190→ANO: Sets 1 as A, 9 as N and 0 as O.
- 190→ANT: Sets 1 as A, 9 as N and 0 as T.
- 90→ NO : Sets 9 as N and 0 as O.
- 90→ NT : Sets 9 as N and 0 as T.

### 2 Count UP Trigger

This selects which of the four memory channels will send the contest serial number. The count up trigger increments the serial number automatically after each complete serial number is sent.

- M1, M2, M3 and M4 can be set. (default: M2)

### 3 Present Number

This item shows the current number in the count up trigger channel set above.

- Rotate **[DIAL]** to change the number, or push **[F-4 CLR]** for 1sec. to reset the current number to 001.

◇ **Keyer set mode**

This set mode is used to set the memory keyer repeat time, dash weight, paddle specifications, keyer type, etc.

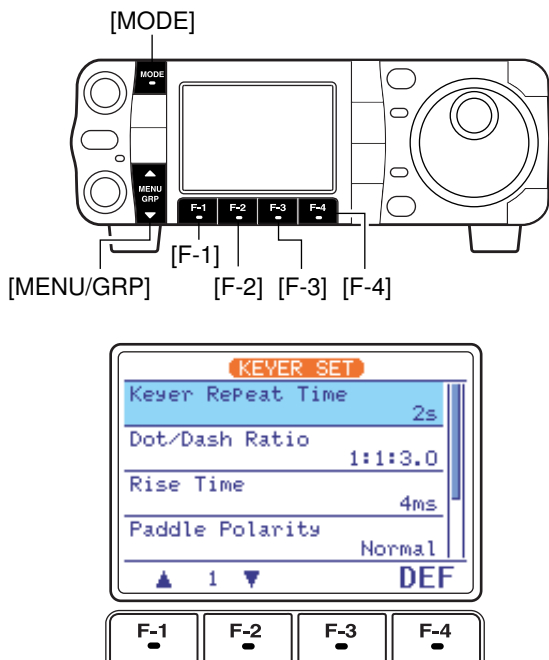

• **Setting the electronic keyer**

- ① Select CW mode with **[MODE]**.
- ② Select **S-1**.
  - Push and hold **[MENU/GRP]** for 1 sec. once or twice to select the menu group **S**.
  - Push **[MENU/GRP]** momentarily one or more times to select the menu **S-1**.
- ③ Push **[F-2 KEY]** then **[▼(MENU/GRP)]** to select the keyer root menu.
  - If the keyer root menu appears, skip pushing **[▼(MENU/GRP)]**. The keyer starting menu can be changed in the miscellaneous (others) set mode. (see p.134)
- ④ Push **[F-4 SET]** to enter the keyer set menu.
- ⑤ Push **[F-1 ▲]** or **[F-2 ▼]** to select the desired set item.
  - Push and hold **[F-4 DEF]** for 1 sec. to select the default condition or value.
- ⑥ Push **[▼(MENU/GRP)]** twice to exit the keyer set menu and return to normal CW mode indication.

**1 Keyer Repeat Time**

When sending CW using the repeat timer, this item sets the time between transmission.

- 1 to 60 sec. in 1 sec. steps can be selected.
- Push and hold **[F-4 DEF]** for 1 sec. to select a default setting. (default: 2 sec.)

**2 Dot/Dash Ratio**

This item sets the dot/dash ratio.

**Keying weight example: Morse code "K"**

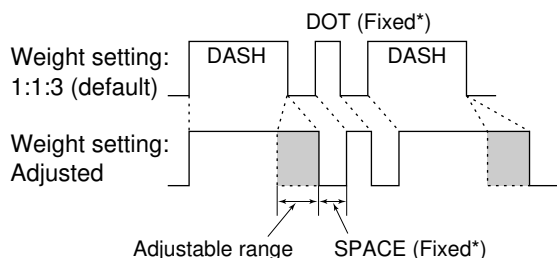

- 1 : 1 : 2.8 to 1 : 1 : 4.5 can be set.
- Check the ratio with side tone in CW mode.
- Push and hold **[F-4 DEF]** for 1 sec. to select a default ratio of 1 : 1 : 3.0.

\*SPACE and DOT length can be adjusted with "Key Speed" only in the quick set mode.

### ◇ Keyer set mode (continued)

#### 3 Rise Time

This item sets the envelop rise time during which the output power reaches the set transmit power.

##### • About rise time

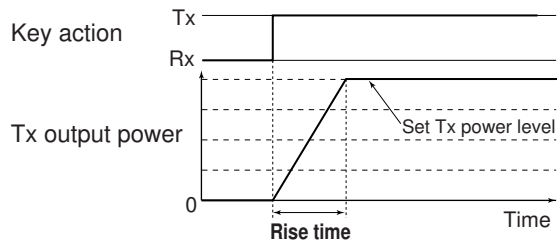

- 2, 4, 6, or 8 msec. can be selected.
- Push and hold **[F-4 DEF]** for 1 sec. to select a default setting. (default: 4 sec.)

#### 4 Paddle Polarity

This item sets the paddle polarity.

- Normal and reverse polarity can be selected.
- Push and hold **[F-4 DEF]** for 1 sec. to select a default setting. (default: Normal)

#### 5 Keyer Type

This item selects the keyer type for **[KEY]** connector on the rear panel.

- ELEC-KEY, BUG-KEY and Straight key can be selected.
- Push and hold **[F-4 DEF]** for 1 sec. to select a default setting. (default: ELEC-KEY)

#### 6 MIC U/D Keyer (HM-103)

(Microphone's **[UP]/[DN]** switches keyer)

This item allows you to set the microphone **[UP]/[DN]** switches to be used as a paddle.

- ON : **[UP]/[DN]** switches can be used for CW.
- OFF : **[UP]/[DN]** switches cannot be used for CW.
- Push and hold **[F-4 DEF]** for 1 sec. to select a default setting. (default: OFF)

**NOTE:** When "ON" is selected, the frequency and memory channel cannot be changed using the **[UP]/[DN]** switches.

### ◇ Paddle operation from **[MIC]** connector

Connect a CW paddle as at right to operate an electronic keyer from the front panel **[MIC]** connector.

- This function is available from the front panel mic connector only.
- Be sure to select "Paddle Polarity," "Keyer Type" "MIC U/D Keyer (HM-103)" in the keyer set mode. (see above)
- Connect straight key to "DOT" side.
- Push both of "DOT" and "DASH" to activate the squeeze operation.

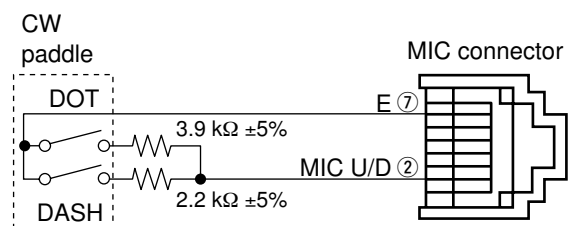

**NOTE:** The HM-103 can be operate as a CW paddle from both of the front panel and rear panel mic connector. But the HM-103 is not available the squeeze operation.

## ■ Operating RTTY (FSK)

When using your RTTY terminal or TNC, consult the manual that comes with the RTTY terminal or TNC.

- ① Push **[▲(BAND)]/[▼(BAND)]** to select the desired band or push a band key on the HM-151.
- ② Push **[MODE]** momentarily to select RTTY mode.
  - After RTTY mode is selected, push and hold **[MODE]** for 1 sec. to toggle between RTTY and RTTY-R modes.
- ③ Display the RTTY decoder screen.
  - Push and hold **[MENU/GRP]** for 1 sec. once or twice to select the menu group **S**.
  - Push **[MENU/GRP]** momentarily one or more times to select the menu **S-1**.
  - Push **[F-2 DEC]** to display the Baudot decoder screen.
- ④ Rotate **[DIAL]** to tune in a desired signal.
  - Use **[F-2 1/4]** in the **M-3** display when critical setting is required.
  - S-meter indicates received signal strength when signal is received.
  - If the received signal cannot be demodulated, try selecting RTTY-R mode (or RTTY mode).
- ⑤ Transmit a SEND signal from your TNC.
  - **[TX]** indicator lights red.
  - The Po meter indicates transmitted RTTY signal strength.
- ⑥ Operate the connected PC or TNC (TU) to transmit RTTY (FSK) signals.

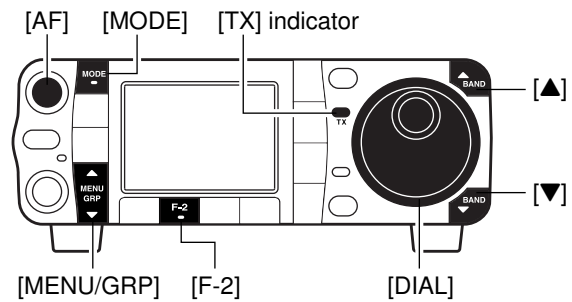

“RTTY” or “RTTY-R” appears

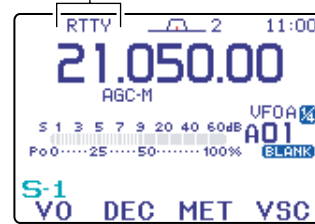

## ◇ Convenient functions for receive

### • Preamp and attenuator (p. 72)

- Push **[P.AMP/ATT]** momentarily to turn the preamp ON or OFF.
  - “**P.AMP**” appears when the preamp is set to ON.
- Push **[P.AMP/ATT]** for 1 sec. to turn the attenuator ON.
  - Push **[P.AMP/ATT]** momentarily to turn the attenuator OFF.
  - “**ATT**” appears when the attenuator is set to ON.

### • Twin PBT (passband tuning) (p. 77)

- Push **[PBT/M-ch/RIT]** (switch) momentarily once or twice to select the twin PBT ON or OFF (M-ch RIT).
  - PBT indicator lights green when the twin PBT is selected.
- Rotate **[PBT/M-ch/RIT]** (controls–inner/outer).
  - Push **[PBT/M-ch/RIT(CLR)]** to clear the settings.

### • AGC (auto gain control) (p. 74)

- While “**M-3**” is selected, push **[F-3 AGC]** momentarily one or more times to select AGC fast, AGC middle and AGC slow.
  - Push and hold **[MENU/GRP]** for 1 sec. once or twice to select the menu group **M**.
  - Push **[MENU/GRP]** momentarily one or more times to select the menu **M-3**.
  - “**AGC-F**,” “**AGC-M**” and “**AGC-S**” appears when the fast time constant, middle time constant and slow time constant is selected, respectively.
- While “**M-3**” is selected, push and hold **[F-3 AGC]** for 1 sec. to enter the AGC set mode.
  - Push **[F-2 FAST]**, **[F-3 MID]** or **[F-4 SLOW]** to select the time constant, then rotate **[DIAL]** to adjust the time constant.

### • Noise blanker (p. 78)

- Push **[NB/ADJ]** to turn the noise blanker ON and OFF.
  - “**NB**” appears when the noise blanker is set to ON.
- Push and hold **[NB/ADJ]** for 1 sec. to enter the noise blanker set mode, then rotate **[DIAL]** to adjust the threshold level, or noise pulse width.

### • DSP noise reduction (p. 79)

- Push **[NR/LEV]** to turn the DSP noise reduction ON and OFF.
  - “**NR**” appears when the DSP noise reduction is set to ON.
- Push and hold **[NR/LEV]** for 1 sec. to enter the noise reduction level set mode, then rotate **[DIAL]** to adjust the DSP noise reduction level.

### • Manual notch filter (pgs. 80, 82)

- Push **[MNF/ADJ]** to turn the manual notch filter ON and OFF.
  - “**MN**” appears when the manual notch filter is set to ON.
- Push and hold **[MNF/ADJ]** for 1 sec. to enter the manual notch filter set mode.
  - Push **[F-2 NF1]**, **[F-3 NF2]** to select the notch filter, push **[F-4 NW]** to set the filter width, rotate **[DIAL]** to set the attenuated frequency.

### • 1/4 function (p. 32)

- While “**M-3**” is selected, push **[F-2 1/4]** to turn the 1/4 function ON and OFF.
  - “**1/4**” indicator appears when the function is activated.

◇ RTTY reverse mode

Received characters are occasionally garbled when the receive signal is reversed between MARK and SPACE. This reversal can be caused by incorrect TNC connections, settings, commands, etc.

To receive a reversed RTTY signal correctly, select RTTY-R (RTTY reverse) mode.

- ① Push **[MODE]** momentarily several times to select RTTY mode.
- ② Push and hold **[MODE]** for 1 sec. to select RTTY or RTTY-R mode.

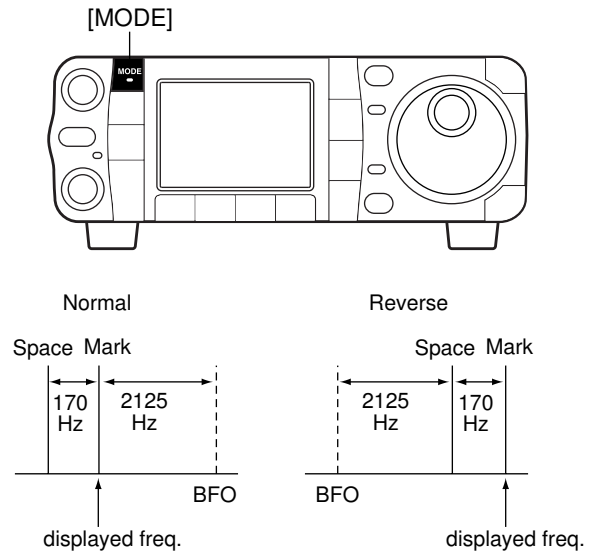

◇ Twin peak filter

The twin peak filter changes the receive frequency response by boosting 2 particular frequencies (2125 and 2295 Hz) for better copying of desired RTTY signals.

- ① Push **[MODE]** momentarily to select RTTY mode.
  - After RTTY mode is selected, push **[MODE]** for 1 sec. to toggle between RTTY and RTTY-R modes.
- ② Push **[AF(SET)]** momentarily to enter the set mode menu.
- ③ Push **[F-1 QS]** to enter the quick set mode.
- ④ Push **[F-1 ▲]** or **[F-2 ▼]** to select "Twin Peak Filter."
- ⑤ Rotate **[DIAL]** to select the twin peak filter function ON or OFF.
  - The received audio volume may become greater when the twin peak filter is turned ON.
- ⑥ Push **[▼(MENU/GRP)]** twice to return the normal operating mode.

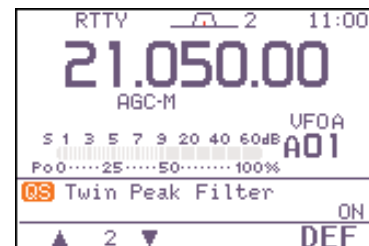
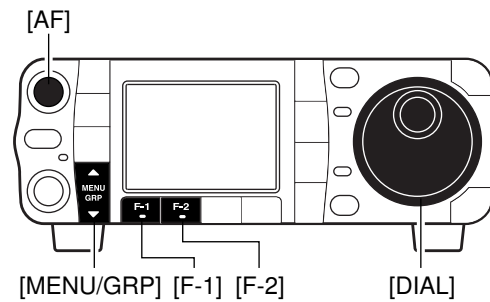

### ◇ Function for the RTTY decoder indication

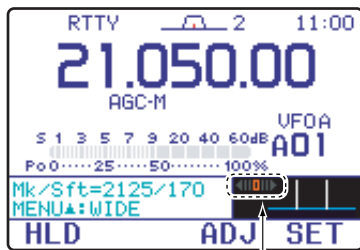
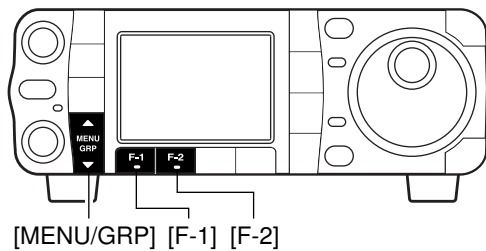

RTTY tuning meter

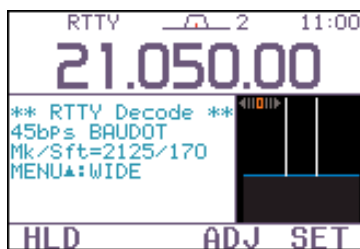

The transceiver has an RTTY decoder for Baudot (mark freq.: 2125 Hz, shift freq.: 170 Hz, 45 bps).

An external terminal unit (TU) or terminal node controller (TNC) is not necessary for receiving a Baudot signal.

- ① Push **[MODE]** momentarily to select RTTY mode.
  - After RTTY mode is selected, push **[MODE]** for 1 sec. to toggle between RTTY and RTTY-R modes.
- ② Select **S-1**.
  - Push and hold **[MENU/GRP]** for 1 sec. once or twice to select the menu group **S**.
  - Push **[MENU/GRP]** momentarily one or more times to select the menu **S-1**.
- ③ Push **[F-2 DEC]** momentarily to turn the RTTY decoder ON.
  - When tuned into an RTTY signal, decoded characters are displayed in the RTTY decoder screen.
- ④ Push **[F-1 HLD]** momentarily to freeze the current screen.
  - “H” appears while the function is in use.
- ⑤ Push **[▲(MENU/GRP)]** to toggle the normal or wide screen space.
- ⑥ Push and hold **[F-1 HLD]** for 1 sec. to clear the displayed characters.
- ⑦ Push **[▼(MENU/GRP)]** to exit the RTTY decoder screen.

▨ The transceiver has an RTTY tuning indicator to make correct tuning easier.

▨ The RTTY tuning meter is automatically displayed when the RTTY decoder is turned ON.

### ◇ Setting the decoder threshold level

Adjust the RTTY decoder threshold level if some characters are displayed when no signal is received.

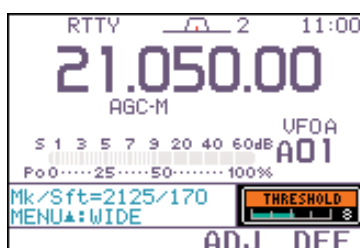
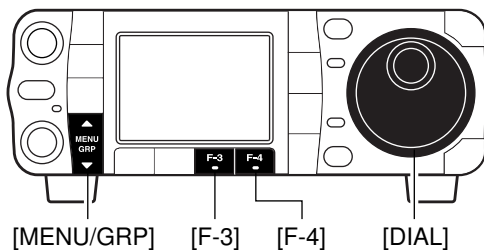

- ① Call up the RTTY decoder screen as described above.
- ② Push **[F-3 ADJ]** to select the threshold level setting condition.
- ③ Rotate **[DIAL]** to adjust the RTTY decoder threshold level.
  - Push and hold **[F-4 DEF]** for 1 sec. to select the default condition.
- ④ Push **[▼(MENU/GRP)]** to exit the RTTY decoder screen.

▨ The UnShift On Space (USOS) function and new line code can be set in the RTTY decode set mode. (p. 55)

◇ RTTY decode set mode

This set mode is used to set the decode USOS function, etc.

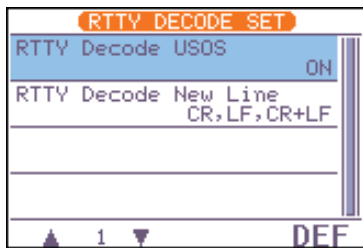
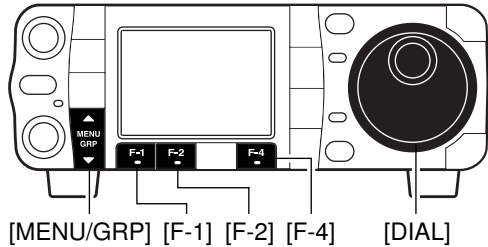

- ① Push **[MODE]** momentarily to select RTTY mode.
  - After RTTY mode is selected, push **[MODE]** for 1 sec. to toggle between RTTY and RTTY-R modes.
- ② Select **S-1**.
  - Push and hold **[MENU/GRP]** for 1 sec. once or twice to select the menu group **S**.
  - Push **[MENU/GRP]** momentarily one or more times to select the menu **S-1**.
- ③ Push **[F-2 DEC]** momentarily to turn the RTTY decoder ON.
  - RTTY decoder screen appears.
- ④ Push **[F-4 SET]** to select the RTTY decode set mode.
- ⑤ Push **[F-1 ▲]** or **[F-2 ▼]** to select the desired set item.
- ⑥ Set the desired condition using **[DIAL]**.
  - Push **[F-4 DEF]** for 1 sec. to select a default condition or value.
- ⑦ Push **[▼(MENU/GRP)]** to exit from set mode.

1 RTTY Decode USOS

This item selects the USOS (UnShift On Space) function of the internal RTTY decoder.

<b>ON</b>	<b>OFF</b>
Decode space as letter code (default)	Decode space as character code

2 RTTY Decode New Line Code

This item selects the new line code of the internal RTTY decoder.

CR : Carriage Return  
 LF : Line Feed

<b>CR, LF, CR+LF</b>	<b>CR+LF</b>
CR, LF and CR+LF (default)	CR+LF only



## ◇ Pre-setting for using RTTY terminal or TNC

When using your RTTY terminal or TNC, consult the manual that comes with the RTTY terminal or TNC.

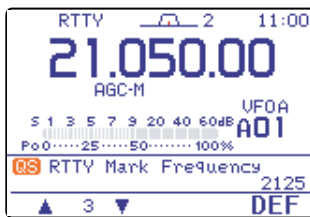
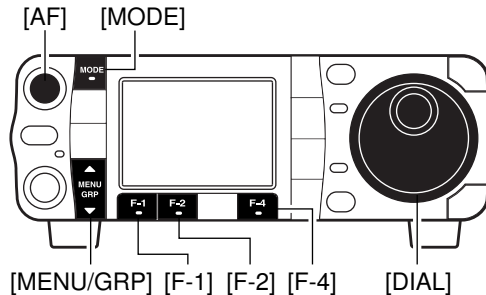

RTTY mark frequency is set to 2125 Hz. (default)

2125, 1615 and 1275 Hz are available.

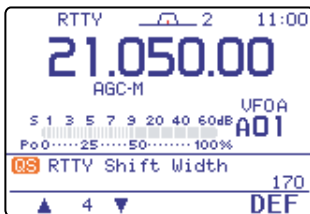

RTTY shift width is set to 170 Hz. (default)

170/200/425 Hz are available.

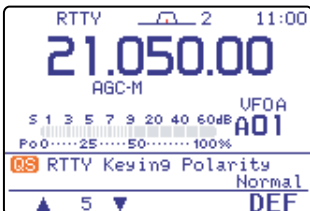

RTTY keying is set to 'normal'. (default)

normal :  
key open=mark  
key close=space  
reverse:  
key open=space  
key close=mark

### Mark frequency

- ① Push **[MODE]** momentarily to select RTTY mode.
  - After RTTY mode is selected, push **[MODE]** for 1 sec. to toggle between RTTY and RTTY-R modes.
- ② Push **[AF(SET)]** momentarily to enter the set mode menu.
- ③ Push **[F-1 QS]** to enter the quick set mode.
- ④ Push **[F-1 ▲]** or **[F-2 ▼]** to select "RTTY Mark Frequency."
- ⑤ Rotate **[DIAL]** to select the desired frequency.
  - Push and hold **[F-4 DEF]** for 1 sec. to select the default frequency.

### Shift width

- ① Enter the quick set mode as above.
- ② Push **[F-1 ▲]** or **[F-2 ▼]** to select "RTTY Shift Width."
- ③ Rotate **[DIAL]** to select the desired shift width.
  - Push and hold **[F-4 DEF]** for 1 sec. to select the default shift width.

### RTTY keying polarity

- ① Enter the quick set mode as above.
- ② Push **[F-1 ▲]** or **[F-2 ▼]** to select "RTTY Keying Polarity."
- ③ Rotate **[DIAL]** to select the desired keying polarity.
  - Push and hold **[F-4 DEF]** for 1 sec. to select the default polarity.

After Pre-setting is finished, push **[▼(MENU/GRP)]** twice to return the normal operating mode.

## ■ Operating AM

- ① Push [**▲(BAND)**]/[**▼(BAND)**] to select the desired band or push a band key on the HM-151.
- ② Push [**MODE**] momentarily or push and hold for 1 sec. to select AM mode.
  - After FM, WFM or AM mode is selected, push [**MODE**] for 1 sec. to select from FM, WFM and AM modes.
- ③ Rotate [**DIAL**] to tune in a desired signal.
  - The S-meter indicates received signal strength when a signal is received.
  - The default tuning step for AM mode is 1 kHz; this can be changed using the tuning step program mode. (p. 30)
- ④ Rotate [**AF**] to set audio to a comfortable listening level.
- ⑤ Push [**PTT**] (microphone) to transmit.
  - [**TX**] indicator lights red.
- ⑥ Speak into the microphone at your normal voice level.
  - Adjust 'MIC Gain' at this step, if necessary. (p. 38)
- ⑦ Release [**PTT**] (microphone) to return to receive.

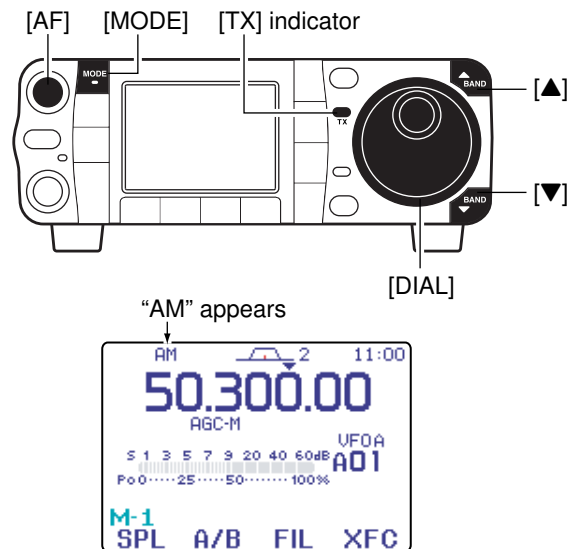

## ◇ Convenient functions for receive

### • Preamp and attenuator (p. 72)

- ➔ Push [**P.AMP/ATT**] momentarily to turn the pre-amp ON or OFF.
  - "**F.AMP**" appears when the preamp is set to ON.
- ➔ Push [**P.AMP/ATT**] for 1 sec. to turn the attenuator ON.
  - Push [**P.AMP/ATT**] momentarily to turn the attenuator OFF.
  - "**ATT**" appears when the attenuator is set to ON.

### • Twin PBT (passband tuning) (p. 77)

- ➔ Push [**PBT/M-ch/RIT**] (switch) momentarily once or twice to select the twin PBT ON or OFF (M-ch RIT).
  - PBT indicator lights green when the twin PBT is selected.
- ➔ Rotate [**PBT/M-ch/RIT**] (controls—inner/outer).
  - Push [**PBT/M-ch/RIT(CLR)**] to clear the settings.

### • Noise blanker (p. 78)

- ➔ Push [**NB/ADJ**] to turn the noise blanker ON and OFF.
  - "**NB**" appears when the noise blanker is set to ON.
- ➔ Push and hold [**NB/ADJ**] for 1 sec. to enter the noise blanker set mode, then rotate [**DIAL**] to adjust the threshold level, or noise pulse width.

### • AGC (auto gain control) (p. 74)

- ➔ While "**M-3**" is selected, push [**F-3 AGC**] momentarily one or more times to select AGC fast, AGC middle and AGC slow.
  - Push and hold [**MENU/GRP**] for 1 sec. once or twice to select the menu group M.
  - Push [**MENU/GRP**] momentarily one or more times to select the menu M-3.
  - "**AGC-F**," "**AGC-M**" and "**AGC-S**" appears when the fast time constant, middle time constant and slow time constant is selected, respectively.
- ➔ While "**M-3**" is selected, push and hold [**F-3 AGC**] for 1 sec. to enter the AGC set mode.
  - Push [**F-2 FAST**], [**F-3 MID**] or [**F-4 SLOW**] to select the time constant, then rotate [**DIAL**] to adjust the time constant.

### Convenient functions for receive (continued)

- **DSP noise reduction** (p. 79)
  - Push **[NR/LEV]** to turn the DSP noise reduction ON and OFF.
    - “NR” appears when the DSP noise reduction is set to ON.
  - Push **[NR/LEV]** for 1 sec. to enter the noise reduction level set mode, then rotate **[DIAL]** to adjust the DSP noise reduction level.
- **Manual notch filter** (pgs. 80, 81)
  - Push **[MNF/ADJ]** to turn the manual notch filter ON and OFF.
    - “MH” appears when the manual notch filter is set to ON.
  - Push and hold **[MNF/ADJ]** for 1 sec. to enter the manual notch filter set mode.
    - Push **[F-2 NF1]**, **[F-3 NF2]** to select the notch filter, push **[F-4 Nw]** to set the filter width, rotate **[DIAL]** to set the notch frequency.
- **Auto notch filter** (p. 80)
  - Push **[ANF/•REC]** to turn the auto notch filter ON and OFF.
    - “AN” appears when the auto notch filter is set to ON.
- **VSC (voice squelch control)** (p. 82)
  - While “S-1” is selected, push **[F-4 VSC]** to turn the VSC function ON and OFF.
    - “VSC” appears when VSC function is set to ON.

### ◇ Convenient functions for transmit

- **Transmit quality monitor** (p. 87)
  - Push **[AF(SET)]**, then **[F-4 QTH]** to enter the miscellaneous (others) set mode. Select an item with **[F-1 ▲]/[F-2 ▼]**, then rotate **[DIAL]** to turn the monitor function ON and OFF.
- **VOX (voice operated transmit)** (p. 83)
  - While “M-3” is selected, push **[F-1 VOX]** to turn the VOX function ON and OFF.
    - Push and hold **[MENU/GRP]** for 1 sec. once or twice to select the menu group M.
    - Push **[MENU/GRP]** momentarily one or more times to select the menu M-3.
    - “VOX” appears when the VOX function is set to ON.
  - While “M-3” is selected, push and hold **[F-1 VOX]** for 1 sec. to enter the VOX set mode.
    - Push **[F-1 ▲]/[F-2 ▼]** to select an item.
    - Rotate **[DIAL]** to set the value/conditions.

## ■ Operating FM

- ① Push **[▲(BAND)]**/**[▼(BAND)]** to select the desired band or push a band key on the HM-151.
- ② Push **[MODE]** momentarily or push and hold for 1 sec. to select FM mode.
  - After FM, WFM or AM mode is selected, push **[MODE]** for 1 sec. to select from FM, WFM and AM modes.
- ③ Rotate **[DIAL]** to tune in a desired signal.
  - The S-meter indicates received signal strength when a signal is received.
  - The default tuning step for FM mode is 1 kHz; this can be changed using the tuning step program mode. (p. 30)
- ④ Rotate **[AF]** to set audio to a comfortable listening level.
- ⑤ Push **[PTT]** (microphone) to transmit.
  - **[TX]** indicator lights red.
- ⑥ Speak into the microphone at your normal voice level.
  - Adjust 'MIC Gain' at this step, if necessary. (p. 38)
- ⑦ Release **[PTT]** (microphone) to return to receive.

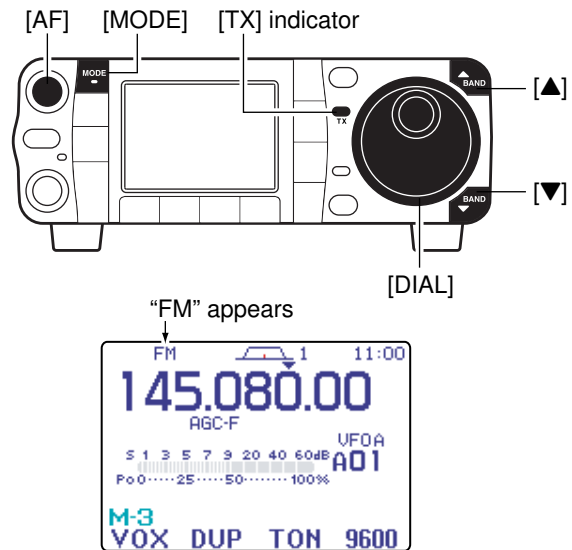

### ◇ Convenient functions for receive

- **Preamp and attenuator** (p. 72)
  - ➔ Push **[P.AMP/ATT]** momentarily to turn the pre-amp ON or OFF.
    - “**F.AMP**” appears when the preamp is set to ON.
  - ➔ Push and hold **[P.AMP/ATT]** for 1 sec. to turn the attenuator ON.
    - Push **[P.AMP/ATT]** momentarily to turn the attenuator OFF.
    - “**ATT**” appears when the attenuator is set to ON.
- **Auto notch filter** (p. 80)
  - ➔ Push **[ANF/•REC]** to turn the auto notch filter ON and OFF.
    - “**ANF**” appears when the auto notch filter is set to ON.
- **DSP noise reduction** (p. 79)
  - ➔ Push **[NR/LEV]** to turn the DSP noise reduction ON and OFF.
    - “**NR**” appears when the DSP noise reduction is set to ON.
  - ➔ Push and hold **[NR/LEV]** for 1 sec. to enter the noise reduction level set mode, then rotate **[DIAL]** to adjust the DSP noise reduction level.
- **VSC (voice squelch control)** (p. 82)
  - ➔ While “**S-1**” is selected, push **[F-4 VSC]** to turn the VSC function ON and OFF.
    - “**VSC**” appears when VSC function is set to ON.

### ◇ Convenient functions for transmit

- **VOX (voice operated transmit)** (p. 83)
  - ➔ While “**M-3**” is selected, push **[F-1 VOX]** to turn the VOX function ON and OFF.
    - Push and hold **[MENU/GRP]** for 1 sec. once or twice to select the menu group **M**.
    - Push **[MENU/GRP]** momentarily one or more times to select the menu **M-3**.
    - “**VOX**” appears when the VOX function is set to ON.
  - ➔ While “**M-3**” is selected, push **[F-1 VOX]** for 1 sec. to enter the VOX set mode.
    - Push **[F-1 ▲]/[F-2 ▼]** to select an item.
    - Rotate **[DIAL]** to set the value/conditions.
- **Transmit quality monitor** (p. 87)
  - ➔ Push **[AF(SET)]**, then **[F-4 OTH]** to enter the miscellaneous (others) set mode. Select an item with **[F-1 ▲]/[F-2 ▼]**, then rotate **[DIAL]** to turn the monitor function ON and OFF.

### ◇ Tone squelch operation

Tone squelch operation is a method of communications using selective calling. Only received signals having a matching tone will open the squelch. Before communicating using tone squelch, all members of your party must agree on the tone squelch frequency.

- ① Push **[MODE]** one or more times to select FM mode.
- ② Select **M-3**.
  - Push and hold **[MENU/GRP]** for 1 sec. once or twice to select the menu group **M**.
  - Push **[MENU/GRP]** momentarily one or more times to select the menu **M-3**.
- ③ Push **[F-3 TON]** momentarily several times to turn the tone squelch function ON.
  - "TSQL" appears.
- ④ Push and hold **[F-3 TON]** for 1 sec. to enter the FM tone set mode.
  - The selected tone frequency for TSQL appears.
  - Other tone functions can be set by pushing **[F-1 TON]**.
- ⑤ Rotate **[DIAL]** to set the desired subaudible tone frequency.
  - See table at right for available tone frequencies.
  - Push and hold **[F-3 DEF]** for 1 sec. to select the default frequency.
  - Push **[▼(MENU/GRP)]** to exit the FM tone set mode.
- ⑥ Communicate in the usual manner.
  - Push and hold **[PTT]** to transmit; release **[PTT]** to receive.

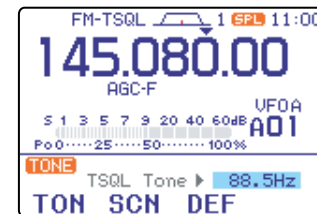
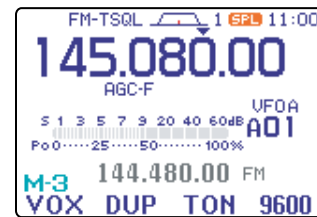
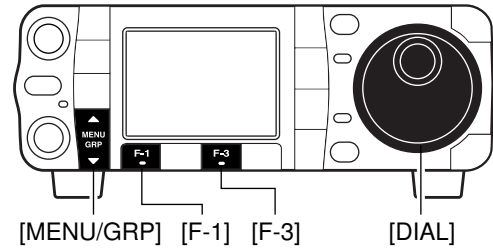

#### • Available tone squelch frequencies (Unit: Hz)

67.0	85.4	107.2	136.5	165.5	186.2	210.7	254.1
69.3	88.5	110.9	141.3	167.9	189.9	218.1	
71.9	91.5	114.8	146.2	171.3	192.8	225.7	
74.4	94.8	118.8	151.4	173.8	196.6	229.1	
77.0	97.4	123.0	156.7	177.3	199.5	233.6	
79.7	100.0	127.3	159.8	179.9	203.5	241.8	
82.5	103.5	131.8	162.2	183.5	206.5	250.3	

◇ DTCS operation

DTCS function is an another method of communications using selective calling. Only received signals having a matching 3-digit code will open the squelch.

- ① Push **[MODE]** one or more times to select FM mode.
- ② Select **M-3**.

- Push and hold **[MENU/GRP]** for 1 sec. once or twice to select the menu group **M**.
- Push **[MENU/GRP]** momentarily one or more times to select the menu **M-3**.

- ③ Push **[F-3 TON]** once or twice to turn the DTCS function ON.

- "DTCS" appears.

- ④ Push and hold **[F-3 TON]** for 1 sec. to enter the FM tone set mode.

- The selected DTCS code appears.
- Other tone functions can be set by pushing **[F-1 TON]**.

- ⑤ Rotate **[DIAL]** to set the desired DTCS code and push **[F-4 POL]** several times to select the desired code polarity.

- NN** : Normal polarity is used for both transmit and receive.

- NR** : Normal polarity is used for transmit, reversed polarity is used for receive.

- RN** : Reversed polarity is used for transmit, normal polarity is used for receive.

- RR** : Reversed polarity is used for both transmit and receive.

- Push and hold **[F-3 DEF]** for 1 sec. to select the default code and polarity.

- Push **[▼(MENU/GRP)]** to exit the FM tone set mode.

- ⑥ Communicate in the usual manner.

- Push and hold **[PTT]** to transmit; release **[PTT]** to receive.

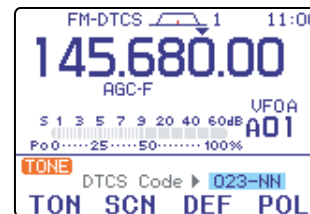
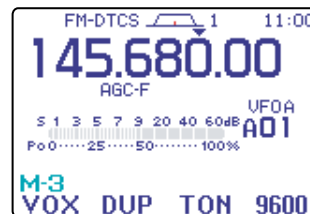
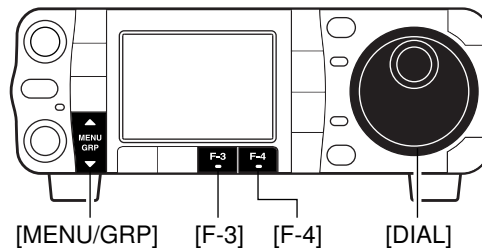

• Available tone codes

023	072	152	244	311	412	466	631
025	073	155	245	315	413	503	632
026	074	156	246	325	423	506	654
031	114	162	251	331	431	516	662
032	115	165	252	332	432	523	664
036	116	172	255	343	445	526	703
043	122	174	261	346	446	532	712
047	125	205	263	351	452	546	723
051	131	212	265	356	454	565	731
053	132	223	266	364	455	606	732
054	134	225	271	365	462	612	734
065	143	226	274	371	464	624	743
071	145	243	306	411	465	627	754

### ◇ Tone scan operation

By monitoring a signal that is being transmitted on a repeater input frequency, you can determine the tone frequency necessary to access a repeater.

- ① During tone squelch, DTCS squelch or repeater operation (“TSQL,” “DTCS” or “TONE” is displayed), select **M-3**.
  - Push and hold **[MENU/GRP]** for 1 sec. once or twice to select the menu group **M**.
  - Push **[MENU/GRP]** momentarily one or more times to select the menu **M-3**.
- ② Push and hold **[F-3 TON]** for 1 sec. to enter the FM tone set mode.
- ③ Push **[F-2 SCN]** to toggle the tone scan operation ON and OFF.
  - When a matched tone or code is detected, tone scan automatically stops, the matched tone or code is displayed and the tone or code setting is automatically adjusted accordingly.
- ④ Push **[▼(MENU/GRP)]** to exit the FM tone set mode.

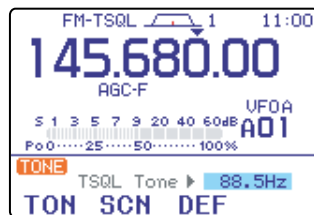
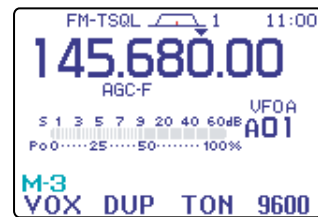
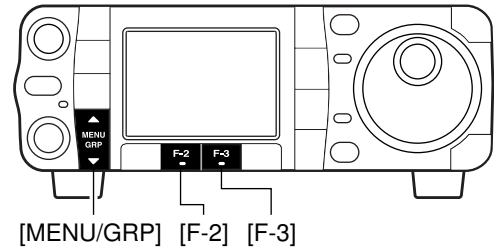

During tone squelch operation.

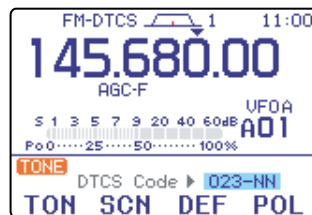

During DTCS squelch operation.

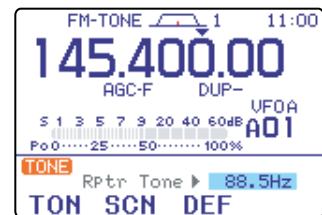

During repeater operation.

## ■ Repeater operation

A repeater amplifies received signals and retransmits them at a different frequency. When using a repeater, the transmit frequency is shifted from the receive frequency by an offset frequency. A repeater can be accessed using split frequency operation with the shift frequency set to the repeater's offset frequency.

For accessing a repeater which requires a repeater tone, set the repeater tone frequency in the FM tone set mode as described on the next page.

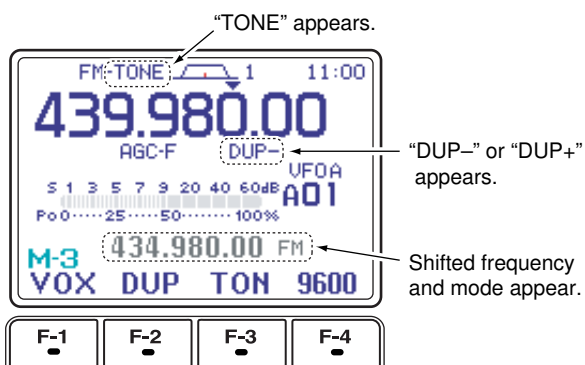
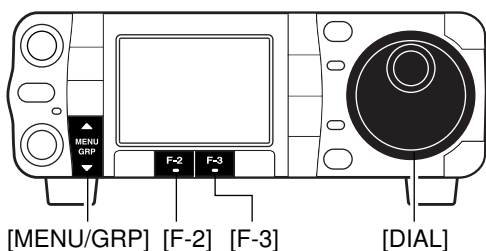

To set the transceiver for repeater operation, follow the steps ① to ③ to select VFO mode, desired band, FM mode.

- ① Push **[F-4 U/M]** to select VFO mode.
  - Push and hold **[MENU/GRP]** for 1 sec. once or twice to select the menu group **M**.
  - Push **[MENU/GRP]** momentarily one or more times to select the menu **M-2**.
- ② Push **[▲(BAND)]/[▼(BAND)]** to select the desired band or push a band key on the HM-151.
- ③ Push **[MODE]** momentarily or push and hold for 1 sec. to select FM mode.
  - After FM, WFM or AM mode is selected, push **[MODE]** for 1 sec. to select from FM, WFM and AM modes.
- ④ Rotate **[DIAL]** to set the receive frequency (repeater output frequency).
- ⑤ Select **M-3**.
- ⑥ Push **[F-2 DUP]** once or twice to set the offset direction.
  - "DUP-" or "DUP+" appears.
  - The default repeater offsets are the standard values of 0.1000 MHz for HF, 0.500 MHz for 50MHz, 0.600 MHz for 144 MHz, and 5.000 MHz for 430 MHz. The offset can be adjusted in set mode. (pgs. 129, 130)
  - The transmit frequency can be monitored while pushing and holding **[F-4 XFC]** in the **M-1** display.
- ⑦ Push **[F-3 TON]** to turn the repeater tone ON.
  - "TONE" appears.
  - The tone frequency can be set in the FM tone set mode as described on the next page.
- ⑧ Communicate in the usual manner.
  - Push and hold **[PTT]** to transmit; release **[PTT]** to receive.

### ◇ One-touch repeater function

This function allows you to set repeater operation by pushing one key.

To set the transceiver for repeater operation using the one-touch repeater function, follow the steps ① to ⑤ as above, then push and hold **[F-2 DUP]** for 1 sec.

• Push and hold **[F-2 DUP]** for 1 sec. again to exit the repeater operating condition.

Set the offset shift direction and frequency in advance (p. 130) as well as the tone frequency (see p. 64).

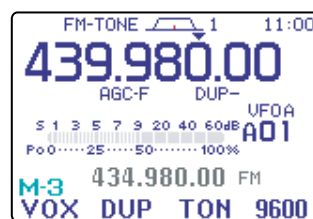
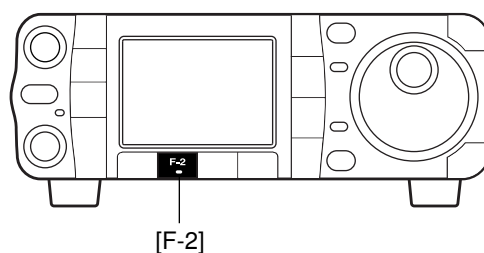



## ◇ Repeater tone frequency

Some repeaters require subaudible tones to be accessed. Subaudible tones are superimposed over your normal signal and must be set in advance. The transceiver has 50 tones from 67.0 Hz to 254.1 Hz.

Each memory channel can store a different subaudible tone frequency.

- ① Select **M-3**.
  - Push and hold **[MENU/GRP]** for 1 sec. once or twice to select the menu group **M**.
  - Push **[MENU/GRP]** momentarily one or more times to select the menu **M-3**.
- ② Push **[F-3 TON]** once or twice to turn the tone encoder ON.
  - "TONE" appears.
- ③ Push and hold **[F-3 TON]** for 1 sec. to enter the FM tone set mode.
  - The selected tone frequency appears.
  - Other tone functions can be set by pushing **[F-1 TON]**.
- ④ Rotate **[DIAL]** to set the desired subaudible tone frequency.
  - See table at right for available tone frequencies.
- ⑤ Push **[▼(MENU/GRP)]** to exit the FM tone set mode.

### CONVENIENT

Store repeater tone frequencies and ON/OFF settings in memory channels for easy recall. The transceiver's repeater tone frequency is set to 88.5 Hz by default. This can be changed if desired.

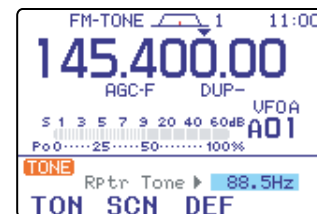
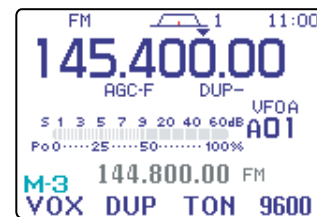
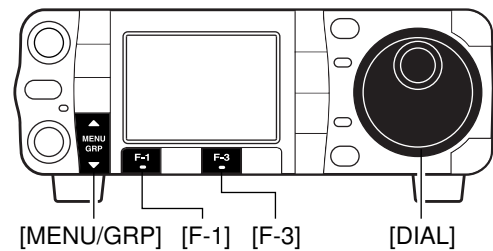

### • Available tone squelch frequencies (Unit: Hz)

67.0	85.4	107.2	136.5	165.5	186.2	210.7	254.1
69.3	88.5	110.9	141.3	167.9	189.9	218.1	
71.9	91.5	114.8	146.2	171.3	192.8	225.7	
74.4	94.8	118.8	151.4	173.8	196.6	229.1	
77.0	97.4	123.0	156.7	177.3	199.5	233.6	
79.7	100.0	127.3	159.8	179.9	203.5	241.8	
82.5	103.5	131.8	162.2	183.5	206.5	250.3	

◆ Transmit frequency monitor check

You may be able to receive the other party's transmit signal directly (called 'listening on the repeater input') without having to go through a repeater. Transmit frequency monitor check (XFC) allows you to check this.

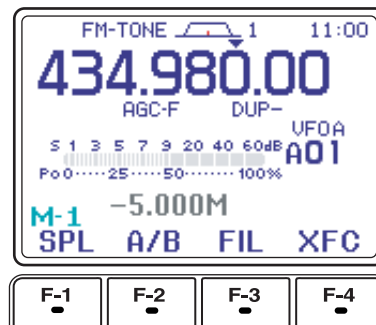
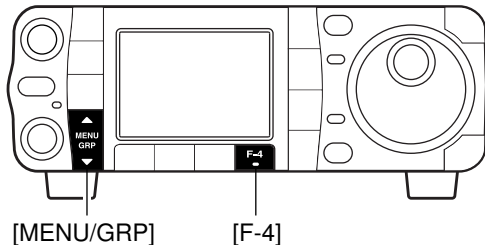

① Select **M-1**.

- Push and hold **[MENU/GRP]** for 1 sec. once or twice to select the menu group **M**.
- Push **[MENU/GRP]** momentarily one or more times to select the menu **M-1**.

② While receiving, push and hold **[F-4 XFC]** to see if you can receive the other party's transmit signal directly.

- While holding **[F-4 XFC]**, the offset direction and frequency are displayed above the multi-function key indicator.



◆ Auto repeater function (USA version only)

This function automatically activates the repeater settings (DUP- or DUP+ and/or tone encoder ON/OFF) when the operating frequency falls within the general repeater output frequency range and deactivates them when outside of the range.

Set the auto repeater function ON-1 (auto duplex setting) or ON-2 (auto duplex setting and activating tone encoder) in the miscellaneous (others) set mode in advance (p. 130). When ON-1 or ON-2 are turned on, repeater settings are automatically activated according to the table below right.

ON-1 sets the duplex setting and ON-2 sets the duplex setting and tone encoder automatically.

- ① Push **[AF(SET)]** momentarily to enter the set mode menu.
- ② Push **[F-4 OTH]** to enter the miscellaneous (others) set mode.
- ③ Push **[F-1 ▲]** or **[F-2 ▼]** to select "Auto Repeater."
- ④ Rotate **[DIAL]** to select the desired auto repeater condition from ON-1, ON-2 and OFF.
  - Push **[F-4 DEF]** for 1 sec. to return to default setting.
- ⑤ Push **[▼(MENU/GRP)]** twice to return to the normal operating mode.

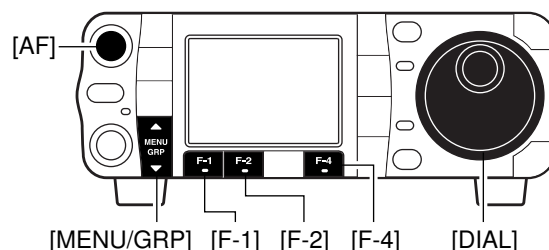

• Frequency range and offset direction (for USA)

FREQUENCY RANGE	DUPLEX DIRECTION
51.620–51.999999 MHz	minus duplex
52.500–52.999999 MHz	
53.500–53.999999 MHz	
145.200–145.499999 MHz	minus duplex
146.610–146.999999 MHz	
147.000–147.399999 MHz	
147.000–147.399999 MHz	plus duplex
442.000–444.999999 MHz	plus duplex
447.000–449.999999 MHz	minus duplex

◇ Storing a non standard repeater

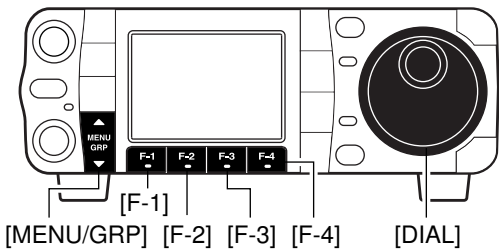

- ① Turn the auto repeater function OFF in the miscellaneous (others) set mode. (p. 130)
- ② Push **[MODE]** to select FM mode.
- ③ Select **M-2**.
  - Push and hold **[MENU/GRP]** for 1 sec. once or twice to select the menu group **M**.
  - Push **[MENU/GRP]** momentarily one or more times to select the menu **M-2**.
- ④ Push **[F-4 V/M]** to select VFO mode.
- ⑤ Select **M-1**, then push **[F-2 A/B]** to select VFO A.
- ⑥ Rotate **[DIAL]** to set the receive frequency (repeater output frequency).
- ⑦ Push **[F-2 A/B]** to select VFO B.
- ⑧ Rotate **[DIAL]** to set the transmit frequency (repeater input frequency).
- ⑨ Push **[F-2 A/B]** to select VFO A.
- ⑩ Push **[F-1 SPL]** to turn the split function ON.
  - “**SPL**” appears.
- ⑪ Select **M-3**, then push **[F-3 TON]** to turn on the previously set tone encoder ON. (p. 64)
- ⑫ Rotate **[M-ch]** to select the desired memory channel.
  - “**BLANK**” appears when the blank channel is selected.
- ⑬ Select **M-2**, then push and hold **[F-2 MW]** for 1 sec. to store the contents in the selected memory channel.

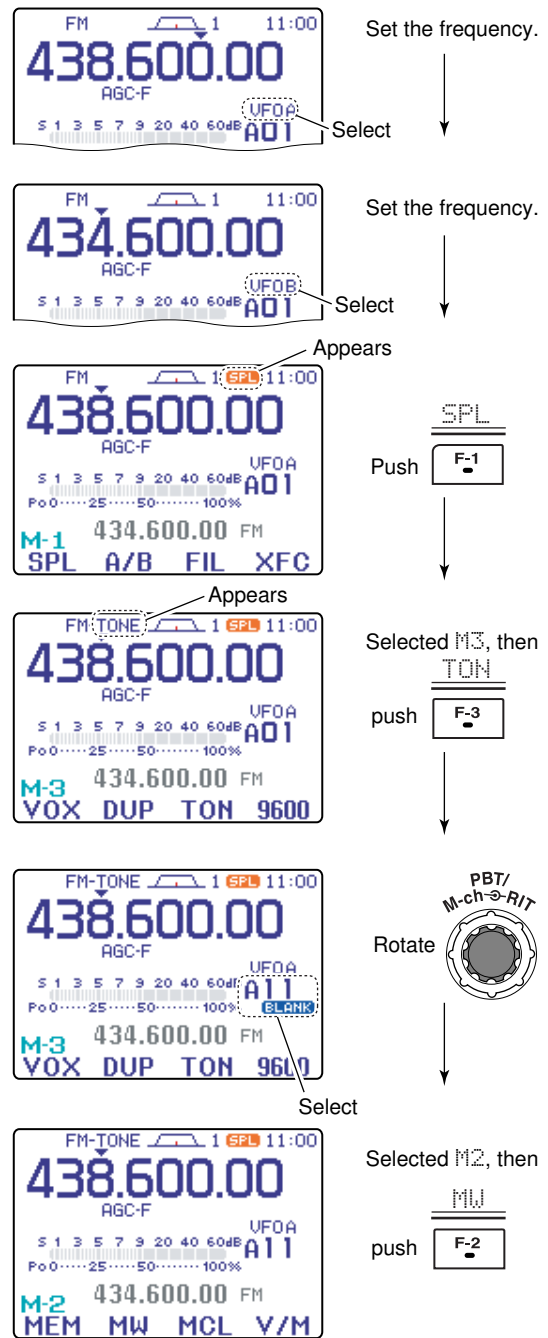

## ■ 1750 Hz tone burst

A 1750 Hz tone is required to access most European repeaters.

➔ While pushing and holding [PTT], push [F-3 TON] in the M-1 display during repeater operation. (pgs. 63, 66)

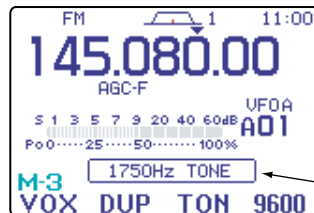
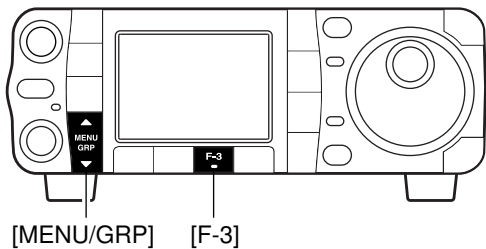

Popup indication appears.

**NOTE:** This function is not available for non-European versions.

## ■ DTMF memory encoder

DTMF tones are used for autopatching, controlling other equipment, etc. The transceiver has 4 DTMF memory channels (D1–D4) for storage of often-used DTMF codes sequence of up to 24 digits.

### ◇ DTMF send menu

To transmit a DTMF code using a DTMF send menu, program the desired code in advance as described on next page.

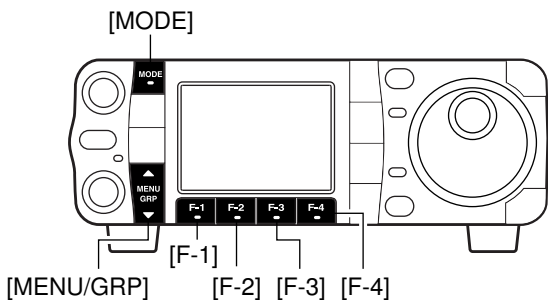

#### • DTMF send menu

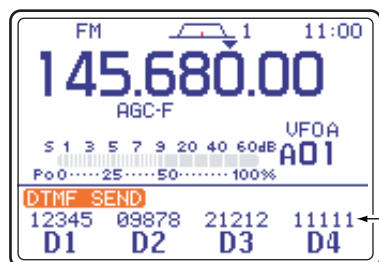

DTMF code sequence



#### • Transmitting

- ① Select FM mode with [MODE].
- ② Select S-1.
  - Push and hold [MENU/GRP] for 1 sec. once or twice to select the menu group S.
  - Push [MENU/GRP] momentarily one or more times to select the menu S-1.
- ③ Push [F-2 DTM] to enter the DTMF send menu.
  - If the DTMF root menu appears, push [F-1 SND]. The DTMF starting menu can be changed in the miscellaneous (others) set mode (see p. 134).
- ④ Push [F-1 D1] – [F-4 D4] to transmit the DTMF code.
  - “D1” – “D4” are highlighted while transmitting.
  - Set the DTMF speed from 100–500 msec. (100 msec. steps). See next page for DTMF set mode.
- ⑤ Push [▼(MENU/GRP)] twice to exit DTMF send menu and return to the normal FM mode display.

### ◇ Programming a DTMF code

- ① Push **[MODE]** to select FM mode.
- ② Select **S-1**.
  - Push and hold **[MENU/GRP]** for 1 sec. once or twice to select the menu group **S**.
  - Push **[MENU/GRP]** momentarily one or more times to select the menu **S-1**.
- ③ Push **[F-2 DTM]** then **[▼(MENU/GRP)]** to select the DTMF root menu.
  - If the DTMF root menu appears, skip pushing **[▼(MENU/GRP)]**. The DTMF starting menu can be changed in the miscellaneous (others) set mode. (see p. 134)
- ④ Push **[F-2 EDT]** to enter the DTMF edit menu.
- ⑤ Push **[F-1 D1]** – **[F-4 D4]** to select the desired DTMF memory channel.
- ⑥ Select the desired code by rotating **[DIAL]**.
  - Push **[F-1 ⏪]** or **[F-2 ⏩]** for cursor movement.
  - Push **[F-3 DEL]** to delete the selected code.
- ⑦ Repeat steps ⑤ and ⑥ until the desired contents are input.
- ⑧ Push **[▼(MENU/GRP)]** to return to memory channel selection mode, then select the next memory channel and repeat steps ⑤ and ⑦ for code input, if desired.
- ⑨ Push **[▼(MENU/GRP)]** twice to exit the keyer edit mode.

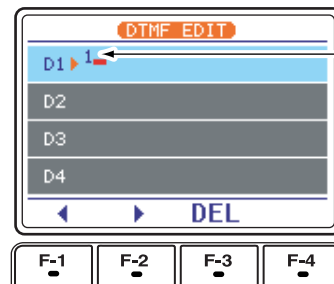
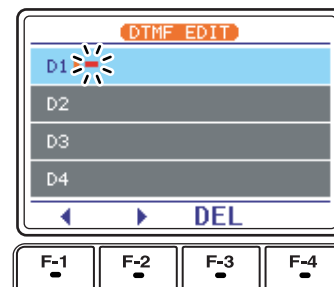
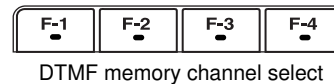
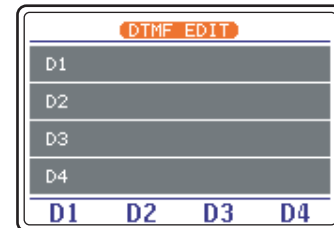
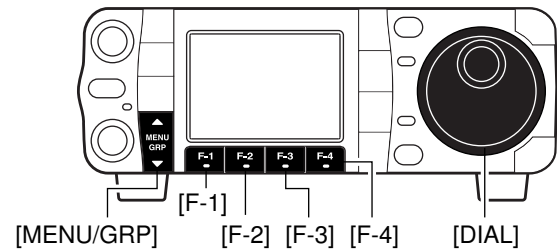

Selected code

### ◇ DTMF speed

The rate at which DTMF memories send individual DTMF characters can be set to accommodate operating needs.

- ① Select the DTMF root menu as described above.
- ② Push **[F-4 SET]** to enter the DTMF set mode.
- ③ Rotate **[DIAL]** to set the desired DTMF speed.
  - Four rates are available: “100 ms” is the fastest; “500 ms” is slowest.
  - Push and hold **[F-4 DEF]** for 1 sec. to select the default rate.
- ④ Push **[▼(MENU/GRP)]** twice to exit the DTMF set mode and return to the normal FM mode display.

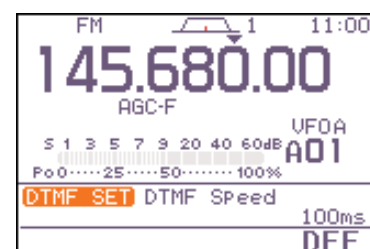

## ■ Simple band scope

This DSP-based simple band scope allows you to display conditions on the selected band, as well as relative strength of signals. The IC-7000 has two modes for the spectrum indication—one is fix mode, and another one is center mode.

**NOTE:** The IC-7000's simple band scope can monitor the displayed frequency during sweeping. Both the receiving and sweeping functions use the same receive circuits which must switch at high speed. This switching sound may be irritating to listen to. If so, set the desired monitoring sound, "FAST Sweep Sound," or change the fast sweep setting, "FAST Sweep," in the scope set mode (p. 72).

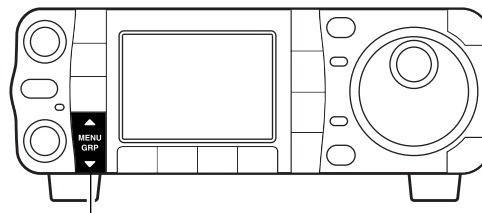

[MENU/GRP]

➔ Select **G-1** (Scope).

- Push and hold [MENU/GRP] for 1 sec. once or twice to select the menu group **G** (Graphic).
- Push [MENU/GRP] momentarily one or more times to select the menu **G-1** (Scope).

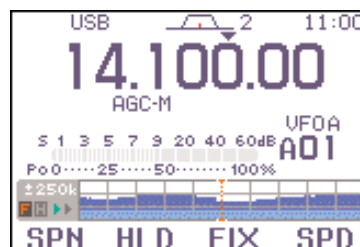

### Quick entry

- ➔ Push and hold [▲(BAND)] for 1 sec. to turn the simple band scope ON and OFF.
- Push [▼(MENU/GRP)] also to turn OFF.

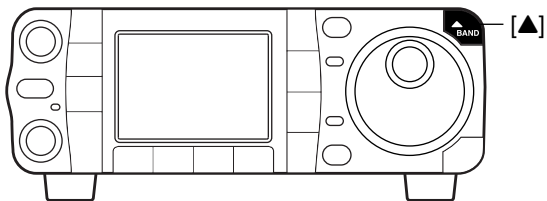

### ◇ Fix mode

Displays signals within the specified frequency range. The selected band conditions can be observed at a glance when using this mode.

- ① Set a mode and frequency.
- ② Select **G-1** (Scope).
  - Push and hold **[MENU/GRP]** for 1 sec. once or twice to select the menu group **G** (Graphic).
  - Push **[MENU/GRP]** momentarily one or more times to select the menu **G-1** (Scope).
- ③ Push **[F-3 FIX]** momentarily to select the fix mode.
  - “**G**” and readout frequency indicator appear when the fix mode is selected.
- ④ Push **[F-4 SPD]** momentarily to select the sweep speed.
  - “**>**” or “**>>**” appears when Slow speed or Fast speed is selected, respectively.
- ⑤ Push **[F-1 SPN]** one or more times to select the desired steps.
  - $\pm 10$ , 25, 50, 100 and 250 kHz are available.
  - Push and hold **[F-1 SPN]** for 1 sec. to select the  $\pm 10$  kHz step.
  - “**<**” or “**>**” indicates when the displayed frequency is out of range. The scope center position can be set to the displayed frequency by pushing and holding **[F-3 FIX]** for 1 sec.
  - The simple band scope operates in the peak level hold mode. Peak levels are displayed in the background of the current spectrum in a different color until the receive frequency changes. This can be cleared by pushing and holding **[F-2 HLD]** for 1 sec., or deactivated in the scope set mode. (p. 72)
- ⑥ Push **[F-2 HLD]** to freeze the current spectrum display.
  - “**G**” appears while the function is in use.

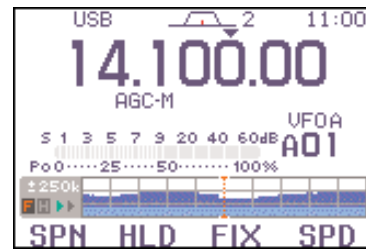
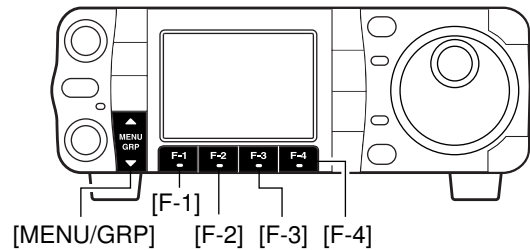

**NOTE:** If there is a lot of signal noise, turn the pre-amp OFF and the attenuator ON (p. 72) to reduce the input level and improve the readability of the scope.

◇ Center mode

Displays signals around the displayed frequency within the selected span. The set frequency is always displayed at the center of the screen.

- ① Set a mode and frequency.
- ② Select **G-1** (Scope).
  - Push and hold **[MENU/GRP]** for 1 sec. once or twice to select the menu group **G** (Graphic).
  - Push **[MENU/GRP]** momentarily one or more times to select the menu **G-1** (Scope).
- ③ Push **[F-3 FIX]** momentarily to select the center mode.
  - “**G**” appears when the center mode is selected.
- ④ Push **[F-4 SPD]** momentarily to select the sweep speed.
  - “**▶**” or “**▶▶**” appears when Slow speed or Fast speed is selected, respectively.
- ⑤ Push **[F-1 SPN]** one or more times to select the desired steps.
  - $\pm 10, 25, 50, 100$  and  $250$  kHz are available.
  - Push and hold **[F-1 SPN]** for 1 sec. to select the  $\pm 10$  kHz step.
  - The simple band scope operates in the peak level hold mode. Peak levels are displayed in the background of the current spectrum in a different color until the receive frequency changes. This can be cleared by pushing and holding **[F-2 HLD]** for 1 sec., or deactivated in the scope set mode. (p. 72)
- ⑥ Push **[F-2 HLD]** to freeze the current spectrum display and range.
  - “**G**” and readout frequency indicator appear while the function is in use.

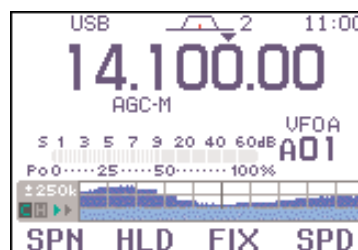
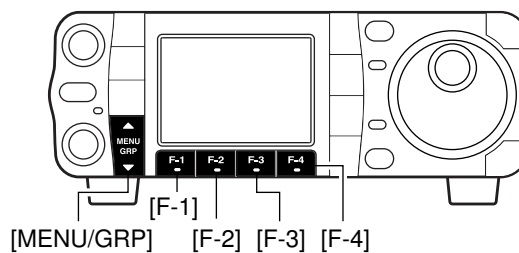

**NOTE:** If there is a lot of signal noise, turn the pre-amp OFF and the attenuator ON (p. 72) to reduce the input level and improve the readability of the scope.

◇ Scope set mode

This set mode is used to set the peak hold function and scope size setting.

- ① Select **G-1** (Scope).
  - Push and hold **[MENU/GRP]** for 1 sec. once or twice to select the menu group **G** (Graphic).
  - Push **[MENU/GRP]** momentarily one or more times to select the menu **G-1** (Scope).
- ② Push and hold **[F-4 SPD]** for 1 sec. to enter the scope set mode.
- ③ Push **[F-1 ▲]** or **[F-2 ▼]** to select the desired set item.
- ④ Set the desired condition using **[DIAL]**.
  - Push **[F-4 DEF]** for 1 sec. to select a default condition.
- ⑤ Push **[▼(MENU/GRP)]** to exit from set mode.

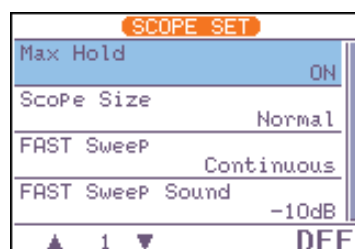
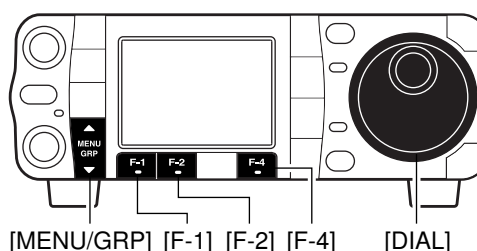



Scope set mode (Continued)

<p><b>1 Max Hold</b></p> <p>This item turns the peak level holding function ON and OFF.</p>	<p><b>ON</b></p> <p>Peak hold is turned ON. (default)</p>	<p><b>OFF</b></p> <p>Peak hold is turned OFF.</p>
---------------------------------------------------------------------------------------------	-----------------------------------------------------------	---------------------------------------------------

<p><b>2 Scope Size</b></p> <p>This item toggles the scope size setting between normal and wide.</p>	<p><b>Normal</b></p> <p>Normal size is selected. (default)</p>	<p><b>Wide</b></p> <p>Wide size is selected.</p>
-----------------------------------------------------------------------------------------------------	----------------------------------------------------------------	--------------------------------------------------

<p><b>3 FAST Sweep</b></p> <p>This item selects the sweep speed setting.</p>	<p><b>Continuous</b></p> <p>Push [F-4 SPD] momentarily to toggle the sweep speed Fast and Slow continuously. (default)</p>	<p><b>1 Sweep</b></p> <p>One Fast speed sweep occurs each time [F-4 SPD] is pushed momentarily.</p>
------------------------------------------------------------------------------	----------------------------------------------------------------------------------------------------------------------------	-----------------------------------------------------------------------------------------------------

<p><b>4 FAST Sweep Sound</b></p> <p>This item sets the monitoring sound level for fast sweeping.</p>	<p><b>-10dB</b> : Monitoring sound is set 10 dB smaller than normal sound. (default)</p>
	<p><b>0dB</b> : Same as normal sound.</p>
	<p><b>OFF</b> : No sound comes out while fast sweeping.</p>

5

■ Preamp and attenuator

The *preamp* amplifies received signals in the receiver input (front end) circuit to improve the S/N ratio and sensitivity. Turn this function ON when receiving weak signals.

The *attenuator* prevents a strong undesired signal near the desired frequency or near your location, such as from a broadcast station, from causing distortion or spurious signals.

Push [P.AMP/ATT] momentarily to turn the preamp ON and OFF; push and hold for 1 sec. to turn the attenuator ON.

- “P.AMP” appears when the preamp is ON; “ATT” appears when the 12 dB attenuator is ON.
- Only one of these functions can be activated at a time.

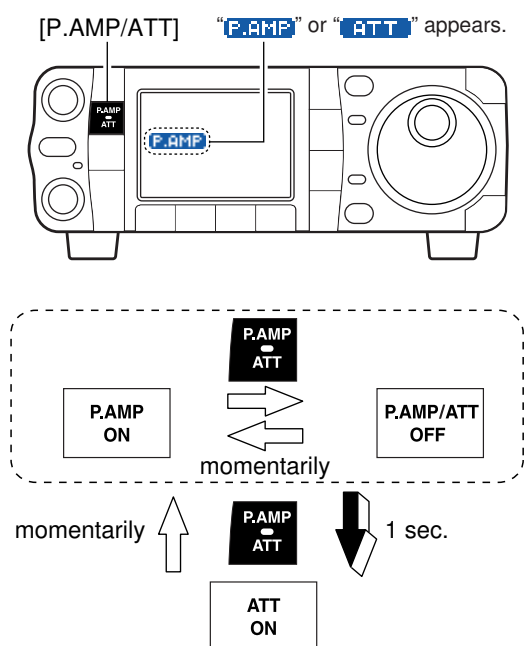

## ■ RIT function

The RIT (Receive Incremental Tuning) function compensates for stations transmitting off-frequency. The function shifts the receive frequency up to  $\pm 9.999$  kHz in 1 Hz steps (10 Hz steps when cancelling the 1 Hz step readout) without moving the transmit frequency.

- ① Push **[PBT/M-ch/RIT]** momentarily to select the M-ch/RIT function, if the twin PBT is selected.
  - **[PBT/M-ch/RIT]** indicator (Green) goes out.
- ② Push and hold **[PBT/M-ch/RIT]** for 1 sec. to enter the RIT/ $\Delta$ TX mode.
- ③ Push **[F-1 RIT]** to turn the RIT function ON.
  - “**RIT**” indicator and the frequency shift appear and **[PBT/M-ch/RIT]** indicator lights orange when the function is ON.
- ④ Rotate **[RIT]** (outer) control to compensate for off-frequency stations.
  - The transmit frequency is not shifted.
- ⑤ To reset the RIT frequency, push and hold **[F-3 CLR]** for 1 sec.
  - Push **[F-3 CLR]** momentarily to reset the RIT frequency when “Quick RIT/ $\Delta$ TX Clear” in the miscellaneous (others) set mode is ON. (p. 133)
- ⑥ To cancel the RIT function, push **[F-1 RIT]** momentarily again.
  - “**RIT**” indicator disappears.
- ⑦ Push **[ $\nabla$ (MENU/GRP)]** to exit the RIT/ $\Delta$ TX mode.

When RIT and  $\Delta$ TX are ON at the same time, the **[RIT]** (outer) control shifts both the transmit and receive frequencies from the displayed frequency at the same time.

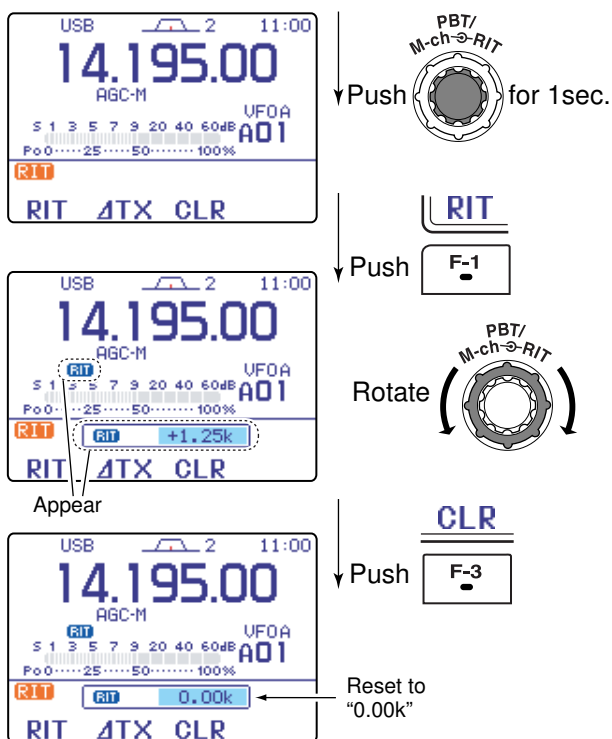
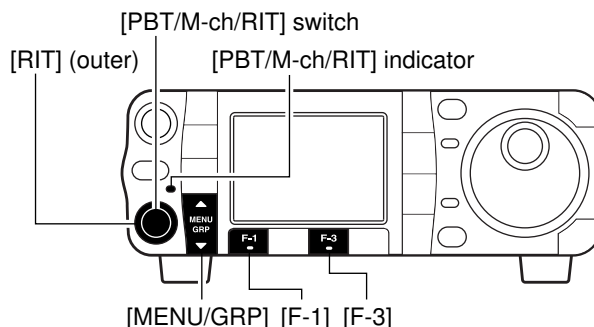

### • Calculate function

The shift frequency of the RIT (or  $\Delta$ TX) function can be added/subtracted to the displayed frequency.

While displaying the RIT (and/or  $\Delta$ TX) shift frequency, push and hold **[F-1 RIT]** (or **[F-2  $\Delta$ TX]**) for 1 sec.

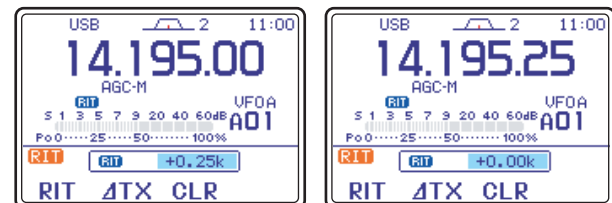

Push and hold

### • Practical example

When you find a DX station on 21.025 MHz/CW and the station is picking up stations transmitting slightly up from 21.025 MHz.

- ① Push **[F-1 RIT]** and **[F-2  $\Delta$ TX]** to turn both the RIT and  $\Delta$ TX functions ON.
- ② Rotate **[RIT]** (outer) to find the DX station's receive frequency.
- ③ When you find the DX station's receive frequency, push **[F-1 RIT]** to turn the RIT function OFF.
  - Now you can transmit the DX station's receive frequency and receive on the DX station's transmit frequency (21.025 MHz).
- ④ Start transmitting when the station stands by for new callers.

## AGC function

The AGC (auto gain control) controls receiver gain to produce a constant audio output level even when the received signal strength is varied by fading, etc.

The transceiver has 3 AGC characteristics (time constant; fast, mid, slow) for non-FM/WFM mode.

The FM/WFM modes AGC time constant is fixed as 'FAST' (0.1 sec.) and AGC time constant cannot be selected.

### AGC time constant selection

- ① Select non-FM/WFM mode with [MODE].
- ② Select M-3.
  - Push and hold [MENU/GRP] for 1 sec. once or twice to select the menu group M.
  - Push [MENU/GRP] momentarily one or more times to select the menu M-3.
- ③ Push [F-3 AGC] several times to select AGC fast, AGC medium (MID) AGC slow or AGC OFF.
  - "AGC-F," "AGC-M," "AGC-S" or "AGC-X" appears when AGC fast, AGC medium (MID), AGC slow or AGC OFF is selected, respectively.

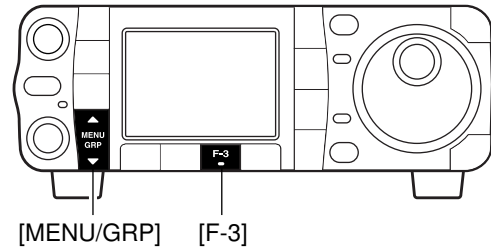

"AGC-X" (OFF) appears when AGC time constant OFF is set for one of FAST, MID, SLOW setting in AGC set mode.

### Setting the AGC time constant

- ① Select the desired mode other than FM/WFM modes.
- ② Select M-3.
  - Push and hold [MENU/GRP] for 1 sec. once or twice to select the menu group M.
  - Push [MENU/GRP] momentarily one or more times to select the menu M-3.
- ③ Push and hold [F-3 AGC] for 1 sec. to enter the AGC set mode.
- ④ Push one of [F-2 FAST], [F-3 MID], [F-4 SLOW] to select the desired AGC time constant.
- ⑤ Rotate [DIAL] to set the desired time constant.
  - AGC time constants can be selected between 0.1 to 8.0 sec. (depends on mode) or turned OFF.
  - Push and hold [F-2 FAST], [F-3 MID] or [F-4 SLOW] for 1 sec. to select a default value each for fast, mid. and slow, respectively.
- ⑥ Select another mode other than FM/WFM. Repeat steps ④ and ⑤, if desired.
  - See table to the right for available time constants.
- ⑦ Push [▼(MENU/GRP)] to exit the AGC set mode.

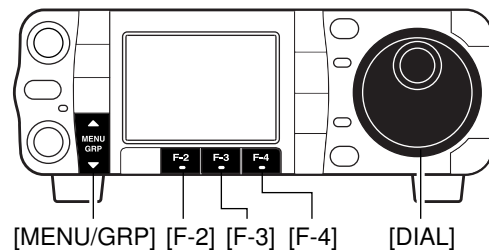

### Selectable AGC time constant (unit: sec.)

Mode	Default	Selectable AGC time constant
SSB	0.3 (FAST)	OFF, 0.1, 0.2, 0.3, 0.5, 0.8, 1.2, 1.6, 2.0, 2.5, 3.0, 4.0, 5.0, 6.0
	2.0 (MID)	
	6.0 (SLOW)	
CW	0.1 (FAST)	OFF, 0.1, 0.2, 0.3, 0.5, 0.8, 1.2, 1.6, 2.0, 2.5, 3.0, 4.0, 5.0, 6.0
	0.5 (MID)	
	1.2 (SLOW)	
RTTY	0.1 (FAST)	OFF, 0.1, 0.2, 0.3, 0.5, 0.8, 1.2, 1.6, 2.0, 2.5, 3.0, 4.0, 5.0, 6.0
	0.5 (MID)	
	1.2 (SLOW)	
AM	3.0 (FAST)	OFF, 0.3, 0.5, 0.8, 1.2, 1.6, 2.0, 2.5, 3.0, 4.0, 5.0, 6.0, 7.0, 8.0
	5.0 (MID)	
	7.0 (SLOW)	
FM/WFM	0.1 (FAST)	Fixed

## ■ IF filter selection

The transceiver has 3 passband IF filter widths for each mode.

For SSB and CW modes, the passband width can be set from 50 to 3600 Hz in 50 or 100 Hz steps. A total of 41 passband widths are available.

For RTTY mode, the passband width can be set from 50 to 2700 Hz in 50 or 100 Hz steps. A total of 32 passband widths are available.

For AM mode, the passband width can be set from 200 Hz to 10 kHz in 200 Hz steps. A total of 50 passband widths are available.

For FM mode, the passband width is fixed and 3 passband widths are available.

For WFM mode, the passband width is fixed at 280 kHz.

- /// The filter selection is automatically memorized in each mode.
- /// The PBT shift frequencies are automatically memorized in each filter.

### ◇ IF filter selection

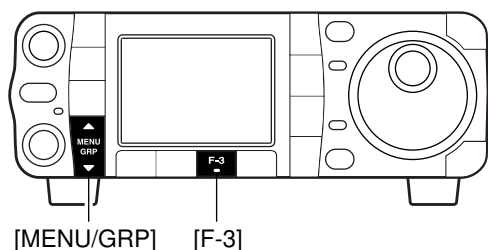

- ① Select the desired mode.
- ② Select **M-1**.
  - Push and hold **[MENU/GRP]** for 1 sec. once or twice to select the menu group **M**.
  - Push **[MENU/GRP]** momentarily one or more times to select the menu **M-1**.
- ③ Push **[F-3 FIL]** momentarily several times to select the IF filter 1, 2 or 3.
  - The selected filter number is displayed in the LCD.
  - The filter setting window appears and shows the selected passband width and shift frequency. (The filter setting window can be turned OFF in the display set mode. (p. 125)

/// The IF filter for WFM mode is fixed and cannot be changed.

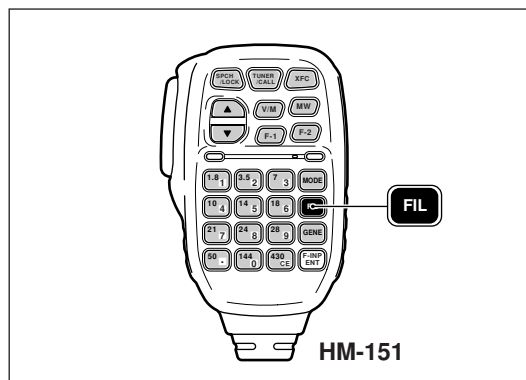
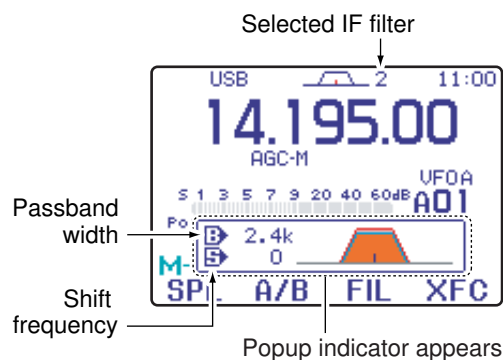

◇ Filter passband width setting (SSB/CW/RTTY/AM only)

- ① Select SSB, CW, RTTY or AM mode.
  - Passband widths for FM and WFM modes are fixed and cannot be set.
- ② Select **M-1**.
  - Push and hold **[MENU/GRP]** for 1 sec. once or twice to select the menu group **M**.
  - Push **[MENU/GRP]** momentarily one or more times to select the menu **M-1**.
- ③ Push **[F-3 FIL]** for 1 sec. to enter filter set mode.

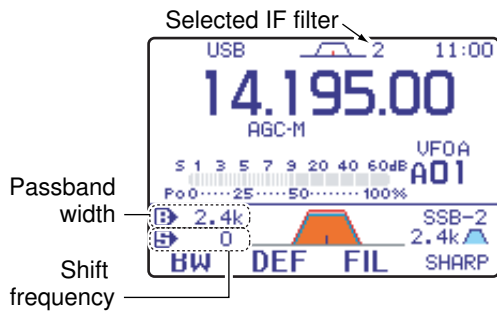
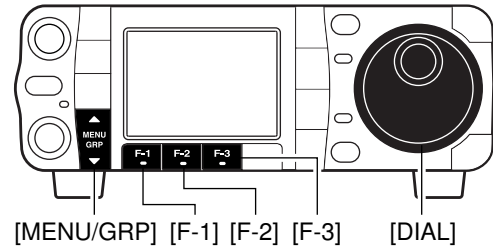

Mode	Filter	Default	Range (Steps)
SSB	FIL1	3.0 kHz	50–500 Hz (50 Hz)/ 600–3.6 kHz (100 Hz)
	FIL2	2.4 kHz	
	FIL3	1.8 kHz	
CW	FIL1	1.2 kHz	50–500 Hz (50 Hz)/ 600–3.6 kHz (100 Hz)
	FIL2	500 Hz	
	FIL3	250 Hz	
RTTY	FIL1	2.4 kHz	50–500 Hz (50 Hz)/ 600–2.7 kHz (100 Hz)
	FIL2	500 Hz	
	FIL3	250 Hz	
AM	FIL1	9.0 kHz	200 Hz–10.0 kHz (200 Hz)
	FIL2	6.0 kHz	
	FIL3	3.0 kHz	
FM*	FIL1	15 kHz	Fixed
	FIL2	10 kHz	
	FIL3	7.0 kHz	
WFM	FIL	280 kHz	Fixed

- ④ Push **[F-3 FIL]** several times to select the desired IF filter.
- ⑤ While pushing and holding **[F-1 BW]**, rotate **[DIAL]** to set the desired passband width.
  - The passband width can be set within the range as shown in the table to the right.
  - Push **[F-2 DEF]** for 1 sec. to select the default value.
- ⑥ Repeat steps ④ to ⑤ if desired.
- ⑦ Push **[▼(MENU/GRP)]** to exit the filter set mode.

- ▨ The PBT shift frequencies are cleared when the passband width is changed.
- ▨ This filter set mode screen graphically displays the PBT shift frequencies.

\*: When the IF filter is selected FIL2 or FIL3 in the FM mode operation, the Tx IF filter's passband width is fixed narrow selection (2.5 kHz).

◇ IF filter shape (SSB/CW only)

The type of DSP filter shape for each SSB and CW can be selected independently from soft and sharp.

- ① Select SSB or CW mode.
- ② Select **M-1**.
  - Push and hold **[MENU/GRP]** for 1 sec. once or twice to select the menu group **M**.
  - Push **[MENU/GRP]** momentarily one or more times to select the menu **M-1**.
- ③ Push **[F-3 FIL]** for 1 sec. to enter filter set mode.
- ④ Push **[F-3 FIL]** several times to select the desired IF filter.
- ⑤ Push **[F-4]** to select the filter shape from "SHARP" and "SOFT."
- ⑥ Push **[▼(MENU/GRP)]** to exit the filter set mode.

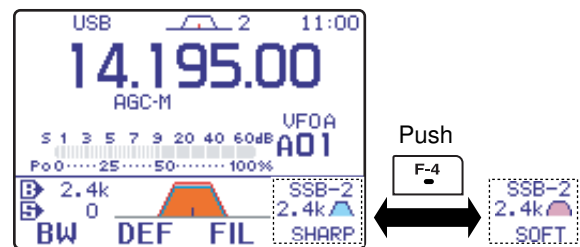
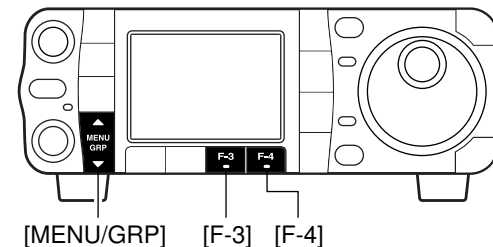

- ▨ Specified selectivity (p. 148) is measured with this parameter set to SHARP.

## ■ Twin PBT operation

The general PBT (Passband Tuning) function electronically narrows the IF passband width by shifting the IF frequency slightly outside of the IF filter passband to reject interference. This transceiver uses the DSP circuit for the PBT function. Moving both **[PBT/M-ch/RIT]** controls to the same position shifts the IF.

- Push **[PBT/M-ch/RIT]** momentarily to select the twin PBT function, if the M-ch-RIT is selected.
  - **[PBT/M-ch/RIT]** indicator (Green) lights.
  - The passband settings window shows the passband width and shift frequency graphically. (The passband settings window can be turned OFF in the display set mode. p. 125)
- When **M-1** is selected, push and hold **[F-3 FIL]** for 1 sec. to enter the filter set mode. Current passband width and shift frequency is displayed in the filter set mode.
- To set the **[PBT/M-ch/RIT]** controls to the center positions, push and hold **[PBT/M-ch/RIT(CLR)]** for 1 sec.

The limit of the variable range depends on the passband width and mode. The limit of the variable range is half of the passband width, and PBT is adjustable in 100 (AM) or 25 Hz steps (other modes).

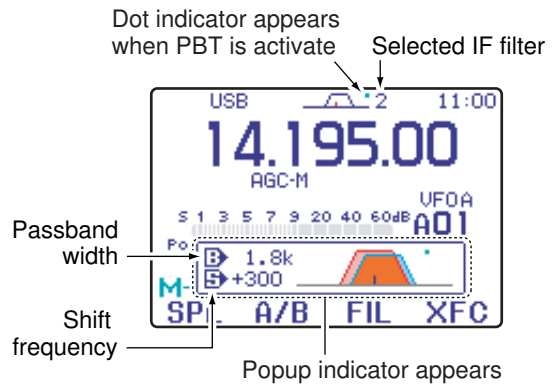
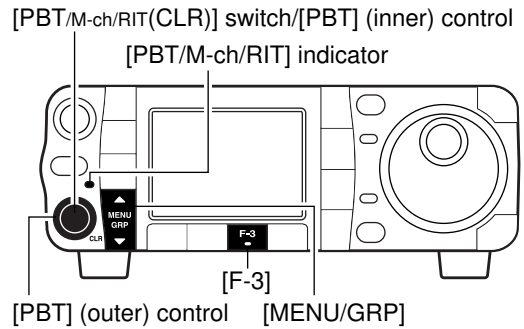

- **[PBT]** controls should normally be set to the center positions (PBT setting is cleared) when there is no interference.
- When PBT is used, the audio tone may be changed.
- Not available for FM or WFM modes.
- While rotating **[PBT]**, noise may occur. This comes from the DSP unit and does not indicate an equipment malfunction.

### PBT OPERATION EXAMPLE

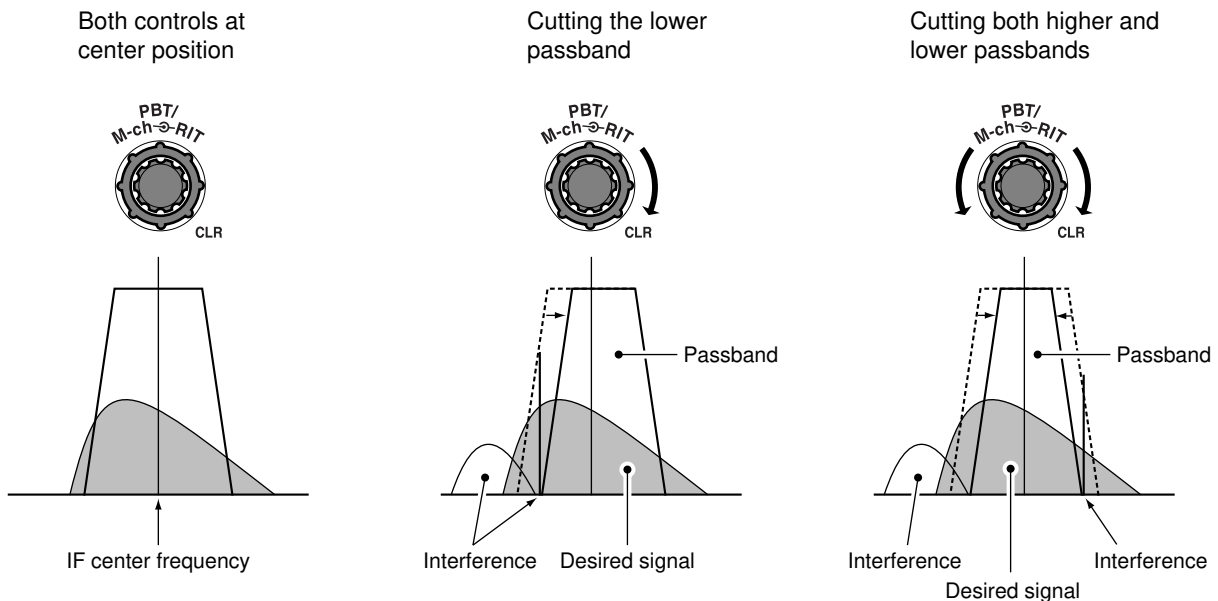

## ■ Noise blanker

The noise blanker eliminates pulse-type noise such as from car ignitions. The noise blanker is not available for WFM mode.

- ➔ Push **[NB/ADJ]** momentarily to toggle the noise blanker ON and OFF.
  - “**NB**” indicator appears when the NB function is ON.

When using the noise blanker, received signals may be distorted if they are excessively strong or the noise type is other than impulse. Nearby strong signals can also cause the noise blanker to create distortion. Turn the noise blanker function OFF, or adjust the noise blanker level to a shallower setting (see below) in this case.

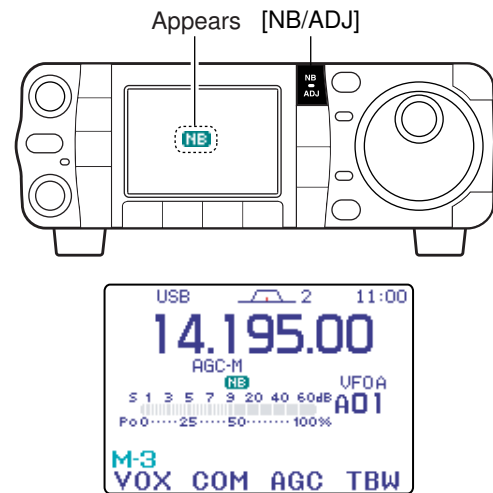

## ◇ Noise blanker set mode

- ① Push and hold **[NB/ADJ]** for 1 sec. to enter the noise blanker set mode.
- ② Push **[F-1 ▲]** or **[F-2 ▼]** to select the desired set item.
- ③ Rotate **[DIAL]** to adjust the desired condition.
  - Push **[F-4 DEF]** for 1 sec. to return to default value.
- ④ Push **[NB/ADJ]** (or push **[▼(MENU/GRP)]**) to exit the noise blanker set mode.

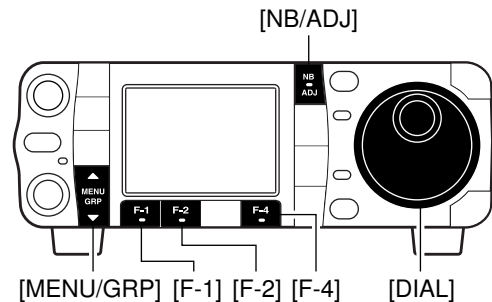
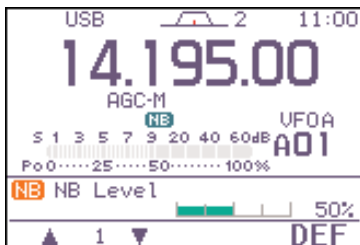

5

### 1. NB Level

This item adjusts the noise blanker level. The noise blanker level can be adjusted from 0 to 100%.

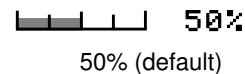

### 2. NB Width

This item adjusts the noise blanker width. The noise blanker width can be adjusted from 1 to 100.

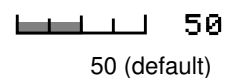

## ■ Noise reduction

The noise reduction function enhances desired signals in the presence of noise by using the DSP circuit. The amount of enhancement is adjustable.

- ➔ Push **[NR/LEV]** momentarily to toggle the noise reduction ON and OFF.
  - “**NR**” indicator appears when the NR function is ON.

▨ The noise reduction level can result in audio signal masking. Set the noise reduction level for maximum readability as described below.

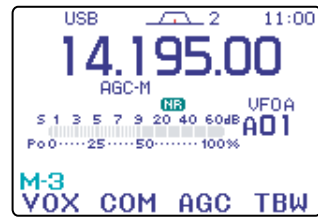
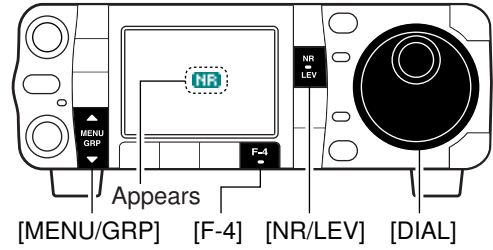

Noise reduction OFF



Noise reduction activated

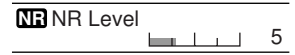

Noise components

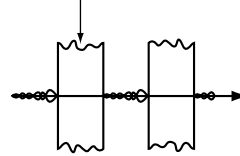

Desired signal (CW)

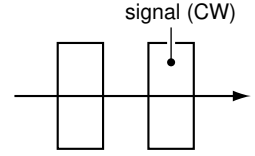

### ◆ Noise reduction set mode

- ① Push **[NR/LEV]** for 1 sec. to enter the noise reduction level set mode.
- ② Rotate **[DIAL]** to adjust the noise reduction level.
  - Set the noise reduction level 0 to 15.
  - Push **[F-4 DEF]** for 1 sec. to return to default level.
- ③ Push **[NR/LEV]** (or push **[▼(MENU/GRP)]**) to exit the noise reduction level set mode.

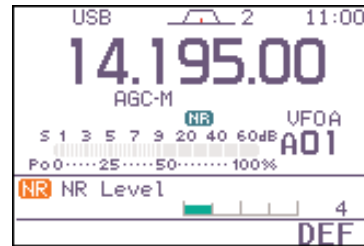

### NR Level

This item adjusts the noise reduction level. The noise reduction level can be adjusted from 0 to 15.

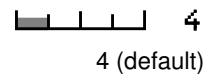

4 (default)



## ■ Notch function

This transceiver has auto and manual notch functions. The auto notch function automatically attenuates up to 3 beat tones, tuning signals, etc., even if they are moving. The manual notch can be set to attenuate a frequency via the manual notch filter set mode.

- While in SSB and AM modes, push **[ANF/•REC]** or **[MNF/ADJ]** to toggle the notch function between auto, manual and OFF.
  - Both of the auto and manual notch functions can be activated at the same time.
- While in CW and RTTY modes, push **[MNF/ADJ]** to toggle the manual notch function ON and OFF.
- While in FM mode, push **[ANF/•REC]** to toggle the auto notch function ON and OFF.
  - “**AN**” appears when auto notch function is in use.
  - “**MM**” appears when manual notch function is in use.
  - Manual notch filter settings are described on the next page.

### ◇ Auto notch function

The auto notch can be used in SSB, AM and FM modes.

- Push **[ANF/•REC]** momentarily to turn the automatic notch function ON and OFF.
  - “**AN**” appears when auto notch function is in use.

Auto notch OFF

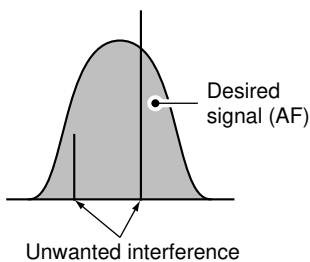

Auto notch ON

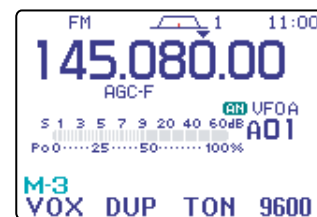
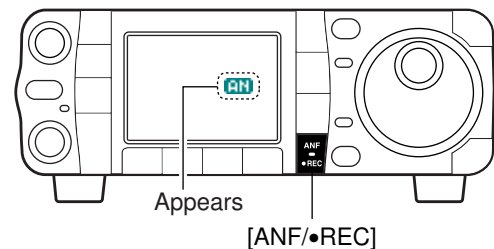
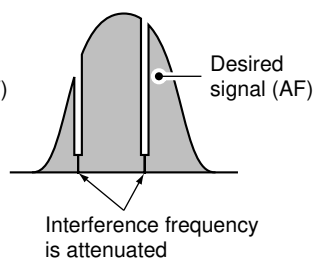

◇ Manual notch function

The manual notch function can be used in SSB, CW, RTTY and AM modes.

➔ Push **[MNF/ADJ]** momentarily to turn the manual notch function ON and OFF.

- “**MIN**” appears when manual notch function is in use.
- Set the frequency for manual notch filtering via the manual notch filter set mode. (shown below)
- Even when both of the manual notch filters, “**NF1**” and “**NF2**,” are set to OFF in the manual notch filter set mode, “**NF1**” is automatically turned ON if the manual notch function is ON.

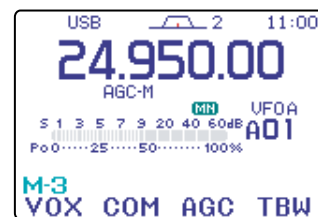
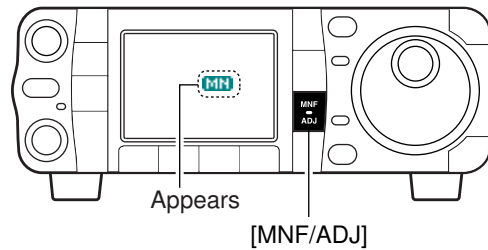

◇ Manual notch filter set mode

- ① Push **[MNF/ADJ]** for 1 sec. to enter the manual notch filter set mode.
- ② Push **[F-2 NF1]** or **[F-3 NF2]** to select the desired filter ON and OFF.
- ③ Rotate **[DIAL]** to adjust the selected filter frequency.
  - Push **[F-4 NW]** to toggle the filter width from narrow, middle and wide.
- ④ Push **[MNF/ADJ]** (or push **[▼(MENU/GRP)]**) to exit the manual notch filter set mode.

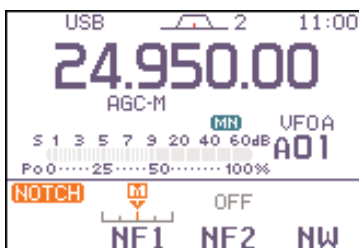
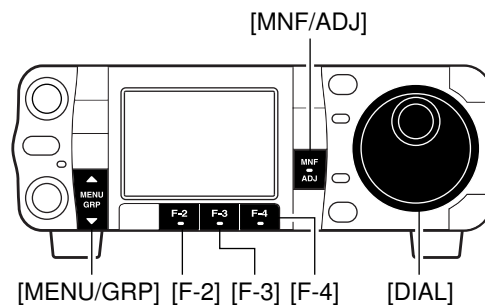

While adjusting the manual notch filter, noise may be heard. This comes from the DSP unit and does not indicate an equipment malfunction.

## ■ Voice squelch control function

This function is useful when you don't want to hear unmodulated signals. When the voice squelch control function is activated, the transceiver checks received signals for voice components.

If a receiver signal includes voice components, and the tone of the voice components changes within 1 sec., squelch opens. If the received signal includes no voice components or the tone of the voice components does not change within 1 sec., squelch closes.

### ① Select S-1 or S-2.

- Push and hold **[MENU/GRP]** for 1 sec. once or twice to select the menu group S.
- Push **[MENU/GRP]** momentarily one or more times to select the menu S-1 or S-2.

### ② Push **[F-4 USC]** to turn the VSC (Voice Squelch Control) function ON.

- "USC" appears when the function is activated.

- ▨ • The VSC function is available for phone modes (SSB, AM, FM, WFM).
- ▨ • The VSC function can also be used for scanning operation in AM, FM or WFM modes. (p. 112)

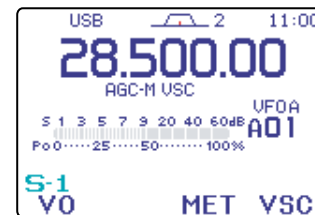
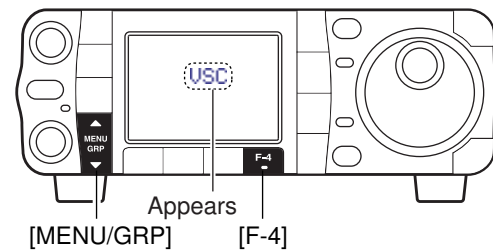

5

## ■ Meter peak hold function

The S-meter has a peak level holding function. The peak level of the received signal strength is indicated for 0.5 sec. (approx). This function can be deactivated in the display set mode ("Meter Peak Hold" ; see p. 125) if desired.

- ① Push **[AF(SET)]** momentarily to enter the set mode menu.
- ② Push **[F-2 DISP]** to enter the display set mode.
- ③ Push **[F-1 ▲]** or **[F-2 ▼]** to select "Meter Peak Hold."
- ④ Rotate **[DIAL]** to turn the meter peak hold setting ON and OFF.
  - Push **[F-4 DEF]** for 1 sec. to return to default condition.
- ⑤ Push **[▼(MENU/GRP)]** twice to return to normal operating mode.

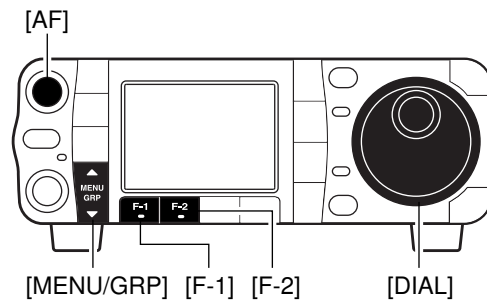
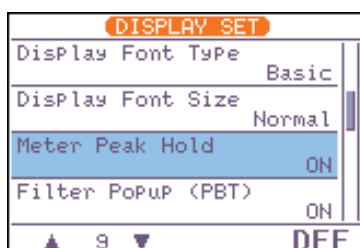

### [EXAMPLE]:

S 1 3 5 7 9 20 40 60dB

Initial reception of a signal results in an S-meter reading of 40 dB.

S 1 3 5 7 9 20 40 60dB

The highest indicated bar remains displayed for about 0.5 sec. even when the signal strength decreases.

## ■ VOX function

The VOX (Voice-Operated Transmission) function switches between transmit and receive with your voice. This function provides an opportunity for hands-free operation or to input log entries into your computer, etc., while operating.

- ① Select a phone mode (SSB, AM, FM) with **[MODE]**.
- ② Select **M-3**.

- Push and hold **[MENU/GRP]** for 1 sec. once or twice to select the menu group **M**.
- Push **[MENU/GRP]** momentarily one or more times to select the menu **M-3**.

- ③ Push **[F-1 VOX]** to toggle the VOX function ON and OFF.

- “**VOX**” appears while the VOX is in use.

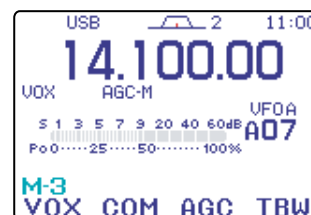
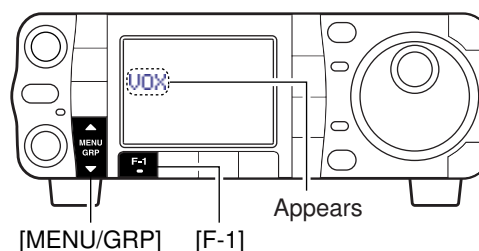

The VOX gain, ANTI-VOX and VOX delay can be set in VOX set mode.

## ◇ Adjusting the VOX function

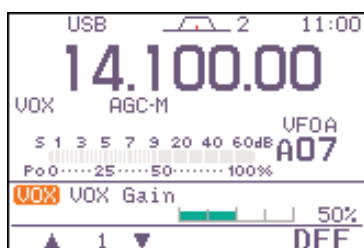
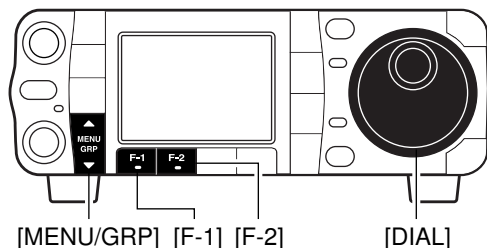

- ① Select a phone mode (SSB, AM, FM).
- ② Select **M-3**.
  - Push and hold **[MENU/GRP]** for 1 sec. once or twice to select the menu group **M**.
  - Push **[MENU/GRP]** momentarily one or more times to select the menu **M-3**.
- ③ Push and hold **[F-1 VOX]** for 1 sec. to enter the VOX set mode.
- ④ Select the VOX gain item using **[F-1 ▲]** or **[F-2 ▼]**.
- ⑤ While speaking into the microphone, rotate **[DIAL]** to the point where the transceiver is continuously transmitting.
- ⑥ Adjust the VOX delay for a convenient interval before returning to receive.
  - Select the VOX delay item using **[F-1 ▲]** or **[F-2 ▼]**.
  - Rotate **[DIAL]**.
- ⑦ If the receive audio from the speaker causes the VOX circuit to switch to, adjust the anti-VOX setting to the point where speaker audio does not activate the VOX.

## ◇ VOX set mode

### 1. VOX Gain

This item adjusts the VOX gain for the VOX (voice activated transmit) function. This setting can be adjusted from 0 to 100% in 1% steps.

• Push **[F-4 DEF]** for 1 sec. to return to default gain.

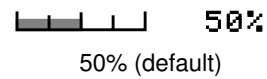

### 2. Anti-VOX

This item adjusts the ANTI-VOX gain for the VOX (voice activated transmit) function. This setting can be adjusted from 0 to 100% in 1% steps.

• Push **[F-4 DEF]** for 1 sec. to return to default gain.

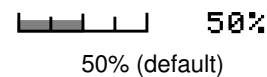

### 3. VOX Delay

This item adjusts the VOX (Voice-activated Transmit) delay time. The delay time can be adjusted from 0 to 2.0 sec. in 0.1 sec. steps.

• Push **[F-4 DEF]** for 1 sec. to return to default delay time.

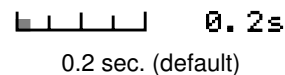

## ■ Transmit filter width setting (SSB only)

The transmit filter width for SSB mode can be selected from wide, middle and narrow.

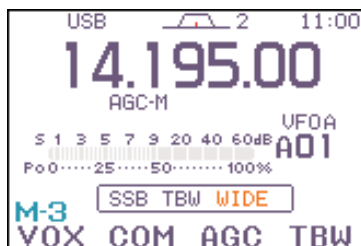
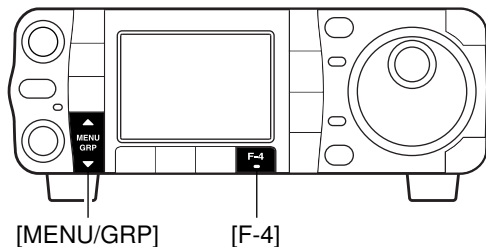

① Select an SSB mode (USB or LSB) with **[MODE]**.

② Select **M-3**.

• Push and hold **[MENU/GRP]** for 1 sec. once or twice to select the menu group **M**.

• Push **[MENU/GRP]** momentarily one or more times to select the menu **M-3**.

③ Push and hold **[F-4 TBW]** for 1 sec. once or twice to select the desired transmit filter width from narrow, middle and wide.

• Push **[F-4 TBW]** momentarily to display the selected TX filter width.

• The transmit filter width window appears for showing the selected TX filter width each time **[F-4 TBW]** is pushed.

• The following filters are specified as the default. Each of the filter widths can be set in the quick set mode. (pgs. 121, 122)

WIDE : 100 Hz to 2900 Hz

MID : 300 Hz to 2700 Hz

NAR : 500 Hz to 2500 Hz

## ■ Break-in function

The break-in function is used in CW mode to automatically switch the transceiver between transmit and receive when keying. The IC-7000 is capable of full break-in or semi break-in.

### ◇ Semi break-in operation

During semi break-in operation, the transceiver selects transmit when keying, then automatically returns to receive after a pre-set time from when you stop keying.

#### • Semi break-in operation

- ① Push **[MODE]** to select CW or CW-R mode.
- ② Select **M-3**.
  - Push and hold **[MENU/GRP]** for 1 sec. once or twice to select the menu group **M**.
  - Push **[MENU/GRP]** momentarily one or more times to select the menu **M-3**.
- ③ Push **[F-1 BRK]** once or twice to turn the semi break-in function ON.
  - “**BK-IN**” appears.

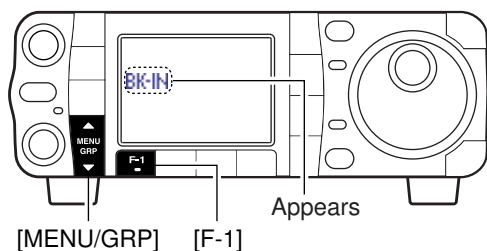

When using a paddle, set “**Key Speed**” in the quick set mode to adjust the keying speed. (p. 122)

#### • Break-in delay setting

- ① Push **[MODE]** to select CW or CW-R mode.
- ② Select **M-3**.
- ③ Push and hold **[F-1 BRK]** for 1 sec. to enter the break-in delay time set mode.
- ④ Rotate **[DIAL]** to set the break-in delay time (the delay from transmit to receive).

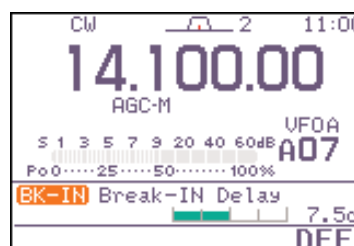
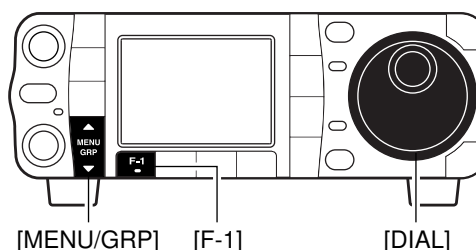

### ◇ Full break-in operation

During full break-in operation, the transceiver automatically switches to receive between keying dots and dashes so that the operator can hear activity on the channel when transmitting.

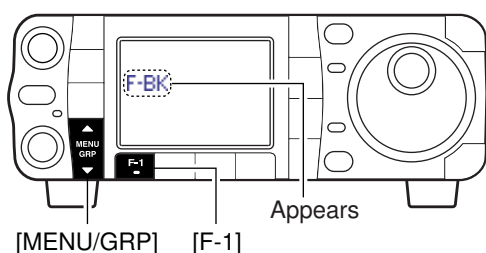

- ① Push **[MODE]** to select CW or CW-R mode.
- ② Select **M-3**.
  - Push and hold **[MENU/GRP]** for 1 sec. once or twice to select the menu group **M**.
  - Push **[MENU/GRP]** momentarily one or more times to select the menu **M-3**.
- ③ Push **[F-1 BRK]** once or twice to turn the semi break-in function ON.
  - “**F-BK**” appears.

When using a paddle, set “**Key Speed**” in the quick set mode to adjust the keying speed. (p. 122)

## ■ ΔTX function

The ΔTX function shifts the transmit frequency up to ±9.999 kHz in 1 Hz steps (10 Hz steps when cancelling the 1 Hz step readout) without moving the receive frequency.

- ① Push **[PBT/M-ch/RIT]** momentarily to select the M-ch/RIT function, if the twin PBT is selected.
  - **[PBT/M-ch/RIT]** indicator (Green) goes out.
- ② Push and hold **[PBT/M-ch/RIT]** for 1 sec. to enter the RIT/ΔTX mode.
- ③ Push **[F-2 ΔTX]** to turn the ΔTX function ON.
  - “**ΔTX**” indicator and the frequency shift appear and **[PBT/M-ch/RIT]** indicator lights orange when the function is ON.
- ④ Rotate **[RIT]** (outer) control to shift the transmitter frequency.
  - The receive frequency is not shifted.
- ⑤ To reset the ΔTX frequency, push **[F-3 CLR]** for 1 sec.
  - Push **[F-3 CLR]** momentarily to reset the RIT frequency when “Quick RIT/ΔTX Clear” in the miscellaneous (others) set mode is ON. (p. 133)
- ⑥ To cancel the ΔTX function, push **[F-2 ΔTX]** momentarily again.
  - “**ΔTX**” indicator disappears.
- ⑦ Push **[▼(MENU/GRP)]** to exit the RIT/ΔTX mode.

When RIT and ΔTX are ON at the same time, **[RIT]** (outer) control shifts both the transmit and receive frequencies from the displayed frequency at the same time.

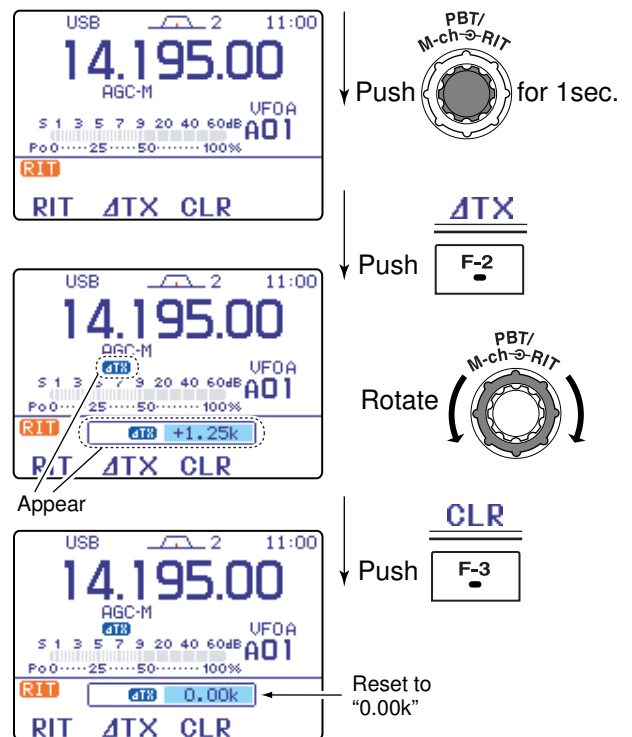
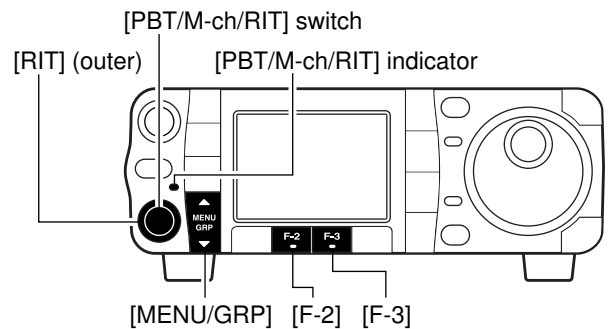

6

### • Calculate function

The frequency shift of the (RIT or) ΔTX function can be added/subtracted to the displayed frequency.

While displaying the (RIT and/or) ΔTX shift frequency, push and hold **([F-1 RIT] or) [F-2 ΔTX]** for 1 sec.

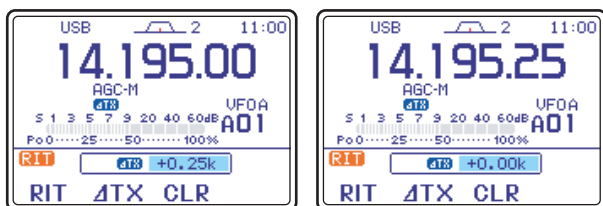

**[F-2]**  
Push and hold

### • Practical example

When you find a DX station on 21.025 MHz/CW and the station is picking up stations transmitting slightly up from 21.025 MHz.

- ① Push **[F-1 RIT]** and **[F-2 ΔTX]** to turn both the RIT and ΔTX functions ON.
- ② Rotate **[RIT]** (outer) to find the DX station's receive frequency.
- ③ When you find the DX station's receive frequency, push **[F-1 RIT]** to turn the RIT function OFF.
  - Now you can transmit the DX station's receive frequency and receive the DX station's transmit frequency (21.025 MHz).
- ④ Start transmitting while the station is standing by.

## ■ Monitor function

The monitor function allows you to monitor your transmitted signals in any mode through the speaker. The CW side tone functions regardless of the monitor function setting.

- ① Push **[AF(SET)]** momentarily to enter the set mode menu.
- ② Push **[F-4 OTH]** to enter the miscellaneous (others) set mode.
- ③ Push **[F-1 ▲]** several times to select "Monitor."
- ④ Rotate **[DIAL]** to turn the monitor function ON.
  - Push **[F-4 DEF]** for 1 sec. to return to default condition.
- ⑤ Push **[F-2 ▼]** to select "Monitor Level."
- ⑥ Rotate **[DIAL]** to adjust the monitor level.
  - Push **[F-4 DEF]** for 1 sec. to return to default level.
- ⑦ Push **[▼(MENU/GRP)]** twice to return to normal operating mode.

/// Use headphones to prevent feedback.

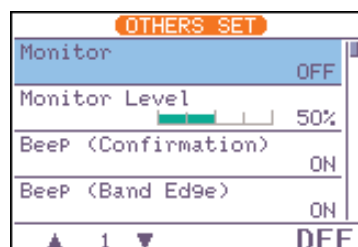
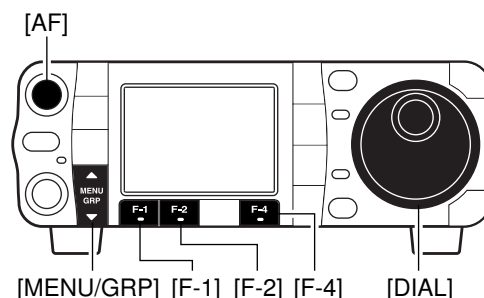

## ■ Speech compressor

The IC-7000 has a built-in, low distortion speech compressor circuit. This circuit increases your average talk power in SSB mode and is especially useful for DX-ing or noisy condition when the receiving station is having difficulty copying your signal.

- ① Select an SSB mode.
- ② Select **M-3**.
  - Push and hold **[MENU/GRP]** for 1 sec. once or twice to select the menu group **M**.
  - Push **[MENU/GRP]** momentarily one or more times to select the menu **M-3**.
- ③ Push **[F-2 COM]** momentarily to turn the speech compressor function ON and OFF.
  - "COM" appears.

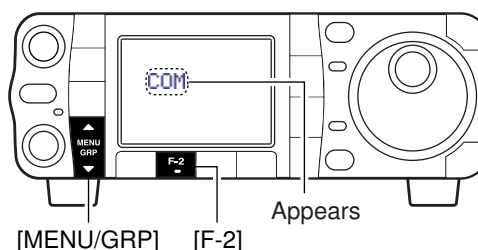



◇ Compression level setting

•Pre-setting the transceiver

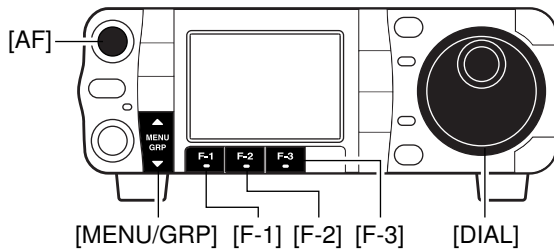

- ① Select an SSB mode.
- ② Turn the speech compressor function OFF, if it's ON.
  - Select **M-1**.
    - Push and hold **[MENU/GRP]** for 1 sec. once or twice to select the menu group **M**.
    - Push **[MENU/GRP]** momentarily one or more times to select the menu **M-1**.
  - Push **[F-2 COM]** momentarily to turn the speech compressor function OFF.
    - “COM” disappears.
- ③ Select ALC meter.
  - Select **S-1**.
  - Push **[F-3 MET]** one or more times to select the ALC meter.
    - “ALC” appears.
- ④ Adjust the MIC gain.
  - Push **[AF(SET)]** momentarily to enter the set mode menu.
  - Push **[F-1 QS]** to enter the quick set mode.
  - Push **[F-1 ▲]** or **[F-2 ▼]** to select “MIC Gain.”
  - Push **[PTT]** (microphone) to transmit at your normal voice level.
  - While speaking into the microphone, rotate **[DIAL]** so that the ALC meter reads within the ALC zone, whether you speak softly or loudly.
  - Push **[▼(MENU/GRP)]** twice to return normal operating mode.

•Compression level setting

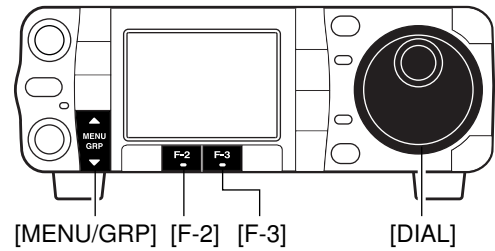

- ① Select COMP meter.
  - Select **S-1**.
    - Push and hold **[MENU/GRP]** for 1 sec. once or twice to select the menu group **S**.
    - Push **[MENU/GRP]** momentarily one or more times to select the menu **S-1**.
  - Push **[F-3 MET]** one or more times to select the COMP meter.
    - “COM” appears.
- ② Turn ON the speech compressor function and enter the speech compression level set mode.
  - Select **M-1**.
  - Push and hold **[F-2 COM]** for 1 sec. to enter the speech compression level set mode.
    - speech compressor function automatically turns ON.
- ③ Rotate **[DIAL]** so that the COMP meter reads between 10 dB to 20 dB.

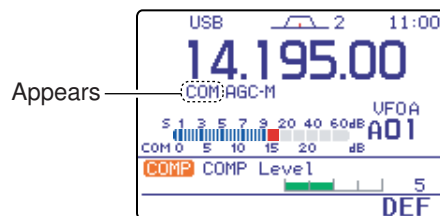

NOTE: When the ALC meter peaks below the ALC zone, your transmitted voice may be distorted.

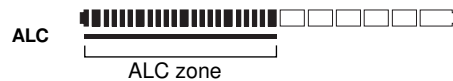

Adjust ‘COMP LEVEL’ so that the ALC meter peaks above the ALC zone.

COMP Level

This item adjusts the speech compression level. The speech compression level can be adjusted from 0 to 10.

- Push **[F-4 DEF]** for 1 sec. to return to default level.

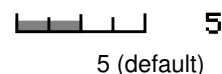

## ■ Split frequency operation

Split frequency operation allows you to transmit and receive in the same mode on two different frequencies. The split frequency operation is basically performed using 2 VFO frequencies (VFO A and VFO B) on the main and sub readouts.

The following is an example of setting 21.290 MHz for receiving and 21.310 MHz for transmitting.

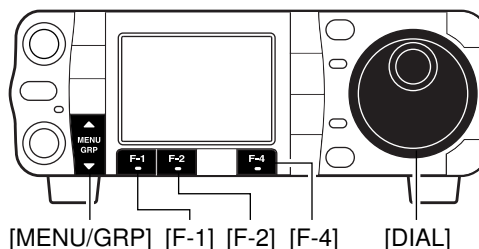

① Select VFO A and set the frequency to 21.290 MHz (USB).

- [F-4  $\mathbb{X}/\mathbb{M}$ ] is available when **M-2** appears.
- [F-2  $\mathbb{A}/\mathbb{B}$ ] is available when **M-1** appears.

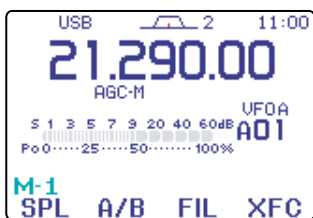

② Push [F-1 **SPL**] momentarily (in the **M-1** menu) to turn the split function ON, then push and hold [F-2  $\mathbb{A}/\mathbb{B}$ ] (**M-1**) for 1 sec.

- The equalized transmit (VFO B) frequency and “**SPL**” appear on the LCD.
- The quick split function is much more convenient for selecting the transmit frequency. See the next page for details.



③ Rotate [DIAL] while pushing and holding [F-4  $\mathbb{X}/\mathbb{M}$ ] (**M-1**) to set the transmit frequency to 21.310 MHz.

- [**XFC**] on the HM-151 can also be used.
- The transmit frequency can be monitored while pushing and holding [F-4  $\mathbb{X}/\mathbb{M}$ ].



④ Now you can receive on 21.290 MHz and transmit on 21.310 MHz.

To swap the transmit and receive frequencies, push [F-2  $\mathbb{A}/\mathbb{B}$ ] (**M-1**) to exchange the VFO A and VFO B.

### CONVENIENT

#### DIRECT SHIFT FREQUENCY INPUT

The shift frequency can be entered directly.

- ① Push [F-INP/ENT] (HM-151).
- ② Enter the desired shift frequency with the digit keys.
  - 1 kHz to 1 MHz shifts can be entered.
  - When you require a minus shift direction, push [50/+] before entering the shift.
- ③ Push [F-1 **SPL**] (**M-1**) on the transceiver’s front panel.
  - The shift frequency is input to the sub readout and the split function is turned ON.

#### [EXAMPLE]

To operate on 1 kHz higher frequency:



To operate on 3 kHz lower frequency:



### CONVENIENT

#### SPLIT LOCK FUNCTION

Accidentally releasing [F-4  $\mathbb{X}/\mathbb{M}$ ] (**M-1**) while rotating [DIAL] changes the receive frequency. To prevent this, use both the split lock and dial lock functions to change the transmit frequency only. The split lock function cancels the dial lock function while pushing and holding [F-4  $\mathbb{X}/\mathbb{M}$ ] (**M-1**) during split frequency operation.

The dial lock’s effectiveness during split frequency operation can be selected in the miscellaneous (others) set mode for both receive and transmit frequencies; or only the receive frequency. (p. 129)

## Quick split function

When you find a DX station, an important consideration is how to set the split frequency.

When you push and hold **[F-1 SPL] (M-1)** for 1 sec., split frequency operation is turned ON, the undisplayed VFO is automatically changed according to the plus/minus shift frequency programmed in the miscellaneous (others) set mode (p. 129) or equalized with the displayed VFO when 0.000 MHz (default) is programmed as the split offset frequency.

This shortens the time needed to start split frequency operation.

Quick split operation is turned ON by default but can be turned OFF in the miscellaneous (others) set mode (p. 129).

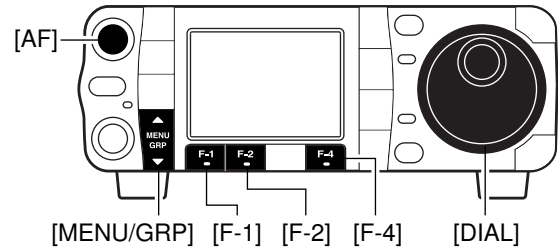

### Menu selection (Example: M-1)

- Push **[MENU/GRP]** for 1 sec. once or twice to select the menu group **M**. Selection from: **M**, **S** or **G** (Graphic)
- Push **[MENU/GRP]** momentarily one or more times to select the menu **M-1**. Selection from: **M-1**, **M-2** or **M-3**

- Suppose you are operating at 21.290 MHz (USB) in VFO A.

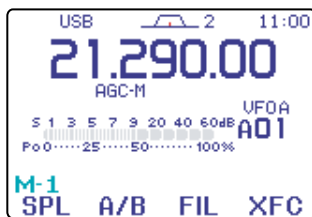

- Push and hold **[F-1 SPL] (M-1)** for 1 sec.
  - Split frequency operation is turned ON.
  - The VFO A and VFO B are equalized.

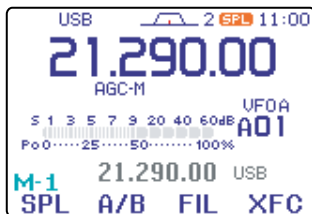

- While pushing and holding **[F-4 XFC] (M-1)**, rotate **[DIAL]** to set the frequency offset between transmit and receive.
  - **[XFC]** on the HM-151 can also be used.
  - The transmit frequency can be monitored while pushing and holding **[F-4 XFC]**.



### PRACTICAL EXAMPLE

When you are searching for DX stations and you suspect that a DX station may say “up ‘X’ kHz” for their receive frequency:

#### OPERATION 1

- Push and hold **[F-1 SPL] (M-1)** for 1 sec. to standby for split operation.
- If the DX station’s operator says “up 10 kHz.”
  - Push **[F-INP/ENT]**, **[1]**, **[0]** then **[F-1 SPL] (M-1)**.
  - Or, rotate the tuning dial.

#### OPERATION 2

If the DX station’s operator says “down 5 kHz” before you enter standby for split operation:

- ➔ Push **[F-INP/ENT]**, **[+]**, **[5]** then **[F-1 SPL] (M-1)**.
  - The split function is turned ON and “5 kHz down” frequency is entered in the sub readout.

### PRACTICAL EXAMPLE

When you are working a pile-up and you want to start split frequency operation to simplify picking out stations:

- Push **[F-1 SPL] (M-1)** momentarily, and push and hold **[F-2 A/B] (M-1)** for 1 sec.
  - The transmit (VFO B) frequency is equalized to the receive (VFO A) frequency and “**SPL**” appears.
- Rotate **[DIAL]** to set your receive frequency in the VFO A.
- Announce your receive frequency.
- After you catch one of the calling stations’ call signs, push and hold the PTT switch to respond.
  - While pushing and holding **[F-4 XFC]**, you can monitor your transmit frequency.

◇ Split offset frequency setting

By setting an often-used split frequency offset in advance, you can operate the quick split function to select split operation at the push of one key.

- ① Push **[AF(SET)]** momentarily to enter the set mode menu.
- ② Push **[F-4 OTH]** to enter the miscellaneous (others) set mode.
- ③ Push **[F-1 ▲]** or **[F-2 ▼]** to select “**SPLIT Off-set.**”
- ④ Rotate **[DIAL]** to set the desired split offset.
  - The split offset can be selected from -9.999 MHz to +9.999 MHz.
  - Push **[F-4 DEF]** for 1 sec. to return to default value.
- ⑤ Push **[▼(MENU/GRP)]** twice to return the normal operating mode.

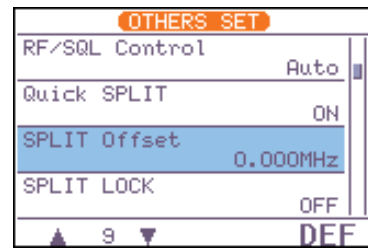
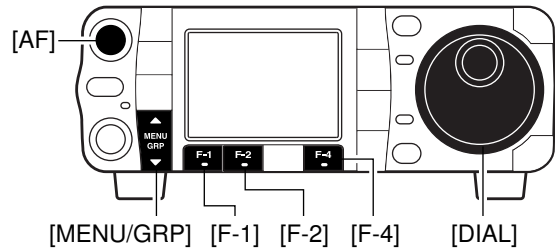

◇ Quick split setting

- ① Enter the miscellaneous (others) set mode as above.
- ② Push **[F-1 ▲]** or **[F-2 ▼]** to select “**Quick SPLIT,**” then rotate **[DIAL]** to select the desired setting.
  - Push **[F-4 DEF]** for 1 sec. to return to default setting.
- ③ Push **[▼(MENU/GRP)]** twice to return the normal operating mode.



## ■ Measuring SWR

The IC-7000 has a built-in circuit for measuring antenna SWR—no external equipment or special adjustments are necessary.

The IC-7000 can measure SWR in 2 ways—spot measurement and plot measurement.

### Menu selection (Example: S-1)

- Push **[MENU/GRP]** for 1 sec. once or twice to select the menu group **S**. Selection from: **M**, **S** or **G**(Graphic)
- Push **[MENU/GRP]** momentarily one or more times to select the menu **S-1**. Selection from: **S-1**, **S-2** or **S-3**

### ◇ Spot measurement

- ① Select CW or RTTY operation with **[MODE]**.
- ② Confirm that the output power is over 30 W.
- ③ Select **S-1**.
- ④ Push **[F-3 MET]** one or more times to select the SWR meter.
- ⑤ Key down or push **[PTT]** to transmit; then read the actual SWR from the meter.
  - ➡ ≤ 1.5 well matched antenna
  - ➡ > 1.5 check antenna or cable connection, etc.

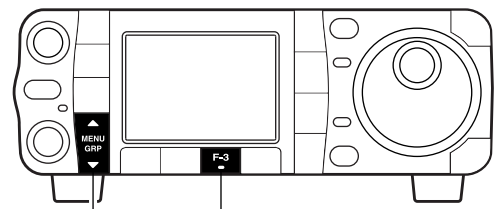
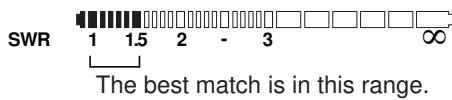

[MENU/GRP] [F-3]

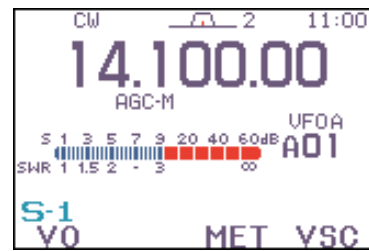

### ◇ Plot measurement

Plot measurement allows you to measure the SWR over an entire band.

- ① Confirm that the output power is over 30 W.
- ② Set the center frequency for the SWR to be measured.
- ③ Select **G-3** (SWR meter).
- ④ Push and hold **[F-4 STEP]** for 1 sec. one or more times to select the desired measuring step from 10, 50, 100 and 500 kHz.
- ⑤ Push **[F-2]** or **[F-3]** one or more times to select the desired number of measuring steps from 3, 5, 7, 9, 11, and 13 steps.
- ⑥ Push **[F-1]** to start the measuring.
- ⑦ Push and hold **[PTT]** on the microphone to measure the SWR.
  - Frequency marker, “▲,” appears below SWR graph.
  - RTTY mode is automatically selected.
- ⑧ When releasing **[PTT]**, the frequency marker and frequency indication move to the next frequency to be measured.
- ⑨ Repeat steps ⑦ and ⑧ to measure SWR over the entire frequency range.
- ⑩ When the measured SWR is less than 1.5:1, the antenna is well matched with the transceiver in the measured frequency range.

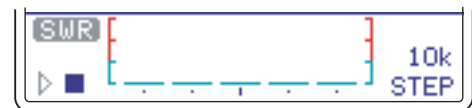

Push [F-1] to start measuring.

Push [F-4] to Select SWR measuring steps.

Push [F-2] or [F-3] to select number of SWR measuring steps.

#### • Measuring (after pushing [F1])



Frequency marker appears and moves after measurement.

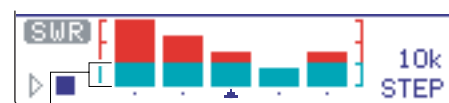

The antenna is well matched in this range

## ■ Digital voice recorder

The transceiver has digital voice memories, up to 4 channels for transmit, and up to 99 channels for receive. A maximum message length of 120 sec. can be recorded into a receive channel (total message length for all channels of up to 1500 sec.), and a total message length of 90 sec. can be recorded in transmit channels.

Providing a transmission memory is very convenient for repeated CQ and number transmissions at contest times, as well as when making consecutive calls in DX'pedition.

### Menu group selection

Push **[MENU/GRP]** for 1 sec.  
Selection from: **M**, **S** or **G**(Graphic)

### Menu selection (Example: S)

Push **[MENU/GRP]** momentarily.  
Selection from: **S-1**, **S-2** or **S-3**



## ■ Recording a received audio

### ◇ Basic recording

- ① Select the desired frequency and mode.
- ② Select **S-1**.
- ③ Push **[F-1 VO]** to call up the voice recorder menu.
  - If the transmit voice memory channels (T1–T4) screen appears, push **[▼(MENU/GRP)]** then push **[F-1 RX]** to select the receive voice memory channel.
  - If the voice root menu appears, push **[F-1 RX]** to select the receive voice memory menu. The voice recorder starting menu can be changed in the miscellaneous (others) set mode. (p. 134)
- ④ Push and hold **[ANF/•REC]** for 1 sec. to start recording while receiving a signal.
  - Records audio into the new channel.
  - **"REC"** appears and the recording timer counts up.
  - The operating frequency, mode and current time are programmed as the memory names automatically.
- ⑤ Push and hold **[ANF/•REC]** for 1 sec. again to stop recording.
  - **"REC"** disappears.
  - Recording is automatically terminated after 120 sec. or when a total of the recorded time becomes 1500 sec.
- ⑥ Push **[▼(MENU/GRP)]** twice to exit the voice recorder mode.

The voice recoder stores the received audio in 15 sec. blocks. Thus the total recording time is reduced by 15 sec. each time recording is stopped.

### CONVENIENT

#### MIC Memo FUNCTION

While recording received audio, speak into microphone (without pushing **[PTT]**) to record your comment, impression or some information with recorded audio.

This function can be activated in the voice set mode. (p. 99)

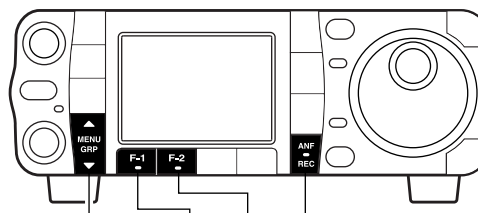

[MENU/GRP] [F-1] [F-2] [ANF/•REC]

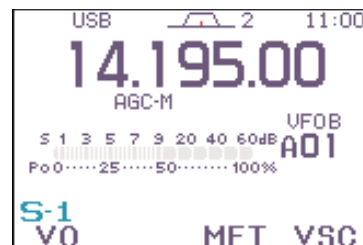

VOICE RX		1230s
1	144.424.00 USB	112s
2	434.620.00 FM	34s
3	1.873.00 LSB	120s
4	1.800.00 CW	2s
5	1.900.00 CW	4s
2005-10- 7 9:52		
▲ ▼ PLY CLR		

VOICE RX		1204s
REC	14.195.00 USB	26s
2	144.424.00 USB	112s
3	434.620.00 FM	34s
4	1.873.00 LSB	120s
5	1.800.00 CW	2s
2005-10- 7 10:25		
▲ ▼ PLY CLR		

◇ One-touch voice recording

To record the receiving signal contents immediately, one-touch voice recording is available.

- ① Push and hold **[ANF/•REC]** for 1 sec. while receiving a signal to start recording.
  - “**REC**” blinks.
  - Records audio into the new channel.
- ② Push and hold **[ANF/•REC]** for 1 sec. again to stop recording.
  - Recording is automatically terminated after 120 sec. or when a total of the recorded time becomes 1500 sec.

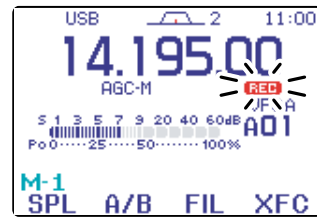
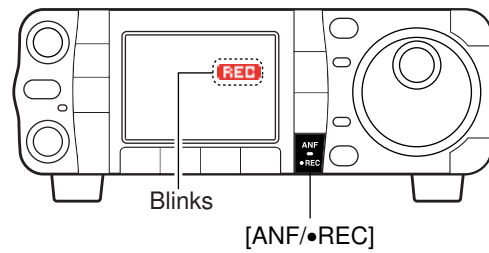

■ Playing the recorded contents

- ① Select **S-1**.
- ② Push **[F-1 VO]** to call up the voice recorder menu.
  - If the transmit voice memory channels (T1–T4) screen appears, push **[▼(MENU/GRP)]** then push **[F-1 RX]** to select the receive voice memory channel.
  - If the voice root menu appears, push **[F-1 RX]** to select the receive voice memory menu. The voice recorder starting menu can be changed in the miscellaneous (others) set mode.
- ③ Push **[F-1 ▲]** or **[F-2 ▼]** to select the desired recorded contents, then push **[F-3 PLY]** to playback.
  - “**PLY**” appears.
- ④ Push **[F-3 PLY]** again (or push **[▼(MENU/GRP)]**) to stop playback, if desired.
  - Playback is terminated automatically when all of the recorded contents in the channel are played.
- ⑤ Push **[▼(MENU/GRP)]** twice to exit the voice recoder mode.

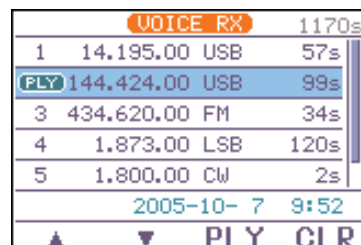
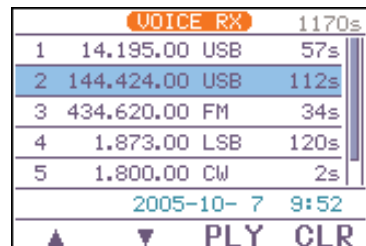
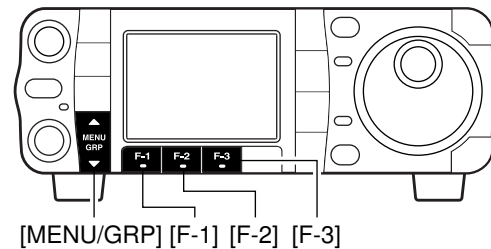

**Menu group selection**

Push [MENU/GRP] for 1 sec.  
*Selection from: M, S or G(Graphic)*

**Menu selection (Example: S)**

Push [MENU/GRP] momentarily.  
*Selection from: S-1, S-2 or S-3*



Either  
 Δ or ▽

**Erasing the recorded contents**

The recorded contents can be erased independently by channel.

- ① Select S-1.
- ② Push [F-1 VO] to call up the voice recorder menu.
  - If the transmit voice memory channels (T1–T4) screen appears, push [▽(MENU/GRP)] then push [F-1 RX] to select the receive voice memory channel.
  - If the voice root menu appears, push [F-1 RX] to select the receive voice memory menu. The voice recorder starting menu can be changed in the miscellaneous (others) set mode. (p. 134)
- ③ Push [F-1 ▲] or [F-2 ▼] to select the desired recorded channel to be erased, then push and hold [F-4 CLR] for 1 sec. to erase the contents.
- ④ Push [▽(MENU/GRP)] twice to exit the voice recorder mode.

/// Be careful!—the erased contents CANNOT be recalled.

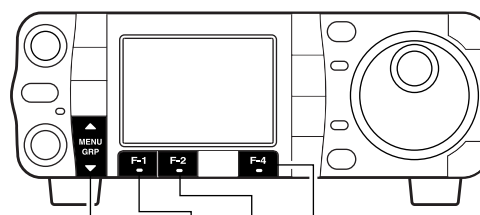

[MENU/GRP] [F-1] [F-2] [F-4]

VOICE RX			1170s
1	14.195.00 USB		57s
2	144.424.00 USB		112s
3	434.620.00 FM		34s
4	1.873.00 LSB		120s
5	1.800.00 CW		2s
			2005-10- 7 9:52
			PLY CLR

Erasing a long message takes a little time, and a maximum message length (120 sec./channel) takes over 1 sec.

When resetting the CPU, the transceiver clears all of the voice memory area (1500 sec.), and it takes almost 30 sec. In these cases, you can use the record function, but you cannot playback the recorded contents during the clearing process until it is completed.



## Recording a message for transmit

### Recording

To transmit a message using a voice recorder, record the desired message in advance as described below.

- ① Select **S-1**.
- ② Push **[F-1 VO]** then **[▼(MENU/GRP)]** to select the voice root menu.
  - If the voice root menu appears, skip the pushing **[▼(MENU/GRP)]**. The voice starting menu can be changed in the miscellaneous (others) set mode. (p. 134)
- ③ Push **[F-3 MIC]** to select the voice memory recording mode.
- ④ Push **[▲(MENU/GRP)]** then rotate **[DIAL]** to adjust the mic gain control so that the "REC LEVEL" indicator reads within maximum.
  - Speak into the microphone without pushing **[PTT]**.
  - Push **[F-4 DEF]** to select the default mic gain.
  - Push **[▼(MENU/GRP)]** to exit the mic gain adjustment condition.
- ⑤ Push **[F-1 ▲▼]** to select the desired memory channel, then push and hold **[F-3 REC]** for 1 sec. to start recording.
  - Speak into the microphone without pushing **[PTT]**.
  - Previously recorded contents are cleared.
- ⑥ Push **[F-3 REC]** again (or push **[▼(MENU/GRP)]**) to stop recording.
  - Recording is automatically terminated when the total time of recorded messages, T1–T4, becomes 90 sec.
- ⑦ Push **[▼(MENU/GRP)]** twice to exit the voice memory screen.

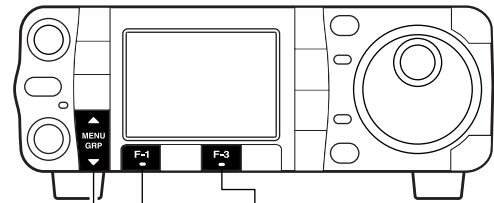

[MENU/GRP] [F-1] [F-3]

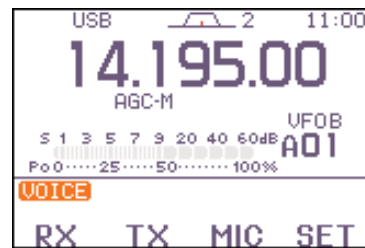

### Confirming/Erasing the recorded message

#### Playing the recorded contents

- ① Call up the voice memory recording mode as described in steps ① to ③ as shown above.
- ② Push **[F-1 ▲▼]** to select the desired memory channel, then push **[F-2 PLY]** to start playback.
  - "FLY" appears.



- ③ Push **[F-2 PLY]** again to stop playback, if desired.
- ④ Push **[▼(MENU/GRP)]** twice to exit the voice memory mode

#### Erasing the recorded contents

- ① Call up the voice memory recording mode as described in steps ① to ③ as shown above.
- ② Push **[F-1 ▲▼]** to select the desired memory channel to be erased, push **[F-2 PLY]** to start playback.
  - "FLY" appears.

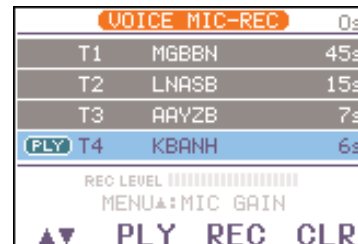

- ③ Push and hold **[F-4 CLR]** for 1 sec. to erase the contents.
- ④ Push **[▼(MENU/GRP)]** twice to exit the voice memory mode.

**Menu group selection**

Push **[MENU/GRP]** for 1 sec.  
*Selection from: M, S or G(Graphic)*

**Menu selection (Example: S)**

Push **[MENU/GRP]** momentarily.  
*Selection from: S-1, S-2 or S-3*



**■ Programming a memory name for transmit**

Memory channels can be tagged with alphanumeric names of up to 5 characters each.

Capital letters, small letters, numerals, some symbols (! # \$ % & ¥ ? " ' ` ^ + - \* / · : ; = < > ( ) [ ] { } | \_ - @) and space can be used. (See the step ⑤ below.)

- ① Record a message as described on the previous page.
- ② Call up the voice memory recording mode as described in steps ① to ③ (see the instructions for recording at previous page).
- ③ Push **[F-1 ▲]** or **[F-2 ▼]** to select the desired voice memory.
- ④ Push **[F-4 NAM]** to enter memory name editing.
  - A cursor appears and blinks.
  - Memory channel names of no-recorded channels cannot be selected.
- ⑤ Push **[▲(MENU/GRP)]** several times to select the desired character group.
  - **[ABC]**, **[abc]**, **[123]** or **[etc]** indicates the capital letters, small letters, numerals or symbols, respectively
- ⑥ Input the desired character by rotating **[DIAL]**.
  - Push **[F-1 ▲]** or **[F-2 ▼]** for cursor movement.
  - Push **[F-3 DEL]** to delete the selected character.
  - Push **[F-4 SPC]** to input a space.
  - Pushing the HM-151's keypad, **[0]–[9]**, can also enter numerals.
- ⑦ Push **[▼(MENU/GRP)]** to input and set the name.
  - The cursor disappears.
- ⑧ Repeat steps ③ to ⑥ to program another voice memory's name, if desired.
- ⑨ Push **[▼(MENU/GRP)]** twice to exit the voice memory screen.

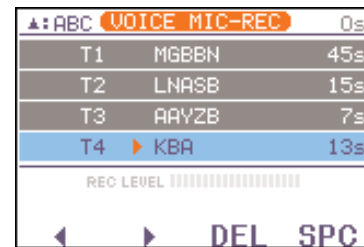
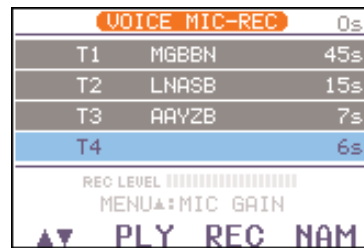
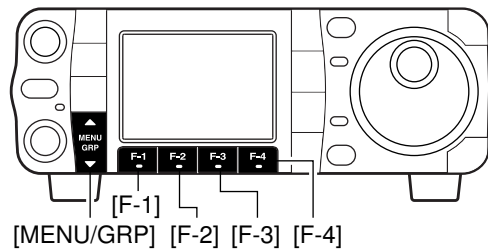

## ■ Sending a recorded message

- ① Select S-1.
- ② Push **[F-1 VO]** to call up the voice recorder menu.
  - If the receive voice memory channels screen appears, push **[▼(MENU/GRP)]** then push **[F-2 TX]** to select the transmit voice memory channel.
  - If the voice root menu appears, push **[F-2 TX]** to select the transmit voice memory menu. The voice recorder starting menu can be changed in the miscellaneous (others) set mode.
- ③ Push **[F-1 T1]** – **[F-4 T4]** to transmit the contents.
  - “T1”–“T4” are highlighted while transmitting.
- ④ Push the selected memory channel key, **[F-1 T1]** – **[F-4 T4]**, again to stop, if desired.
- ⑤ Push **[▼(MENU/GRP)]** twice to exit the voice memory screen.

### /// For your information

- /// When an external keypad is connected to the pin 2 and pin 7 of the **[MIC]** connector, the recorded message, T1–T4, can be transmitted without opening the voice recorder set screen.
- /// See page 135 for details.

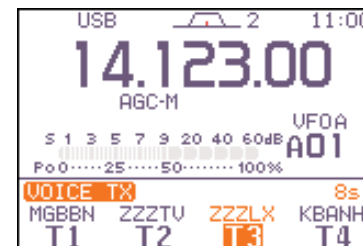
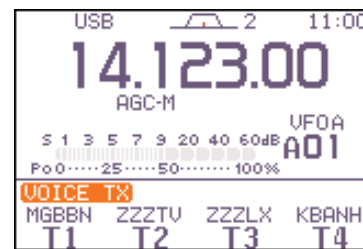
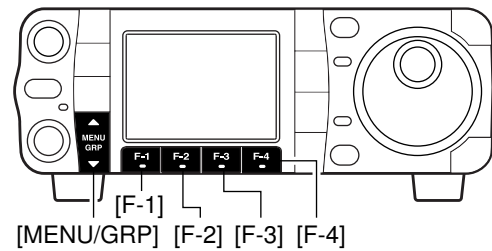

## ◇ Transmit level setting

- ① Call up the voice memory recording mode as described in steps ① to ② as above.
- ② Push **[▲(MENU/GRP)]** to select the voice memory transmit level set mode.
- ③ Push the desired memory channel key, **[F-1 T1]**–**[F-3 T3]**, momentarily to transmit the contents.
- ④ Rotate **[DIAL]** to adjust the transmit voice level.
  - Push **[F-4 DEF]** to select the default condition.
- ⑤ Push **[▼(MENU/GRP)]** to return to the voice recorder screen.

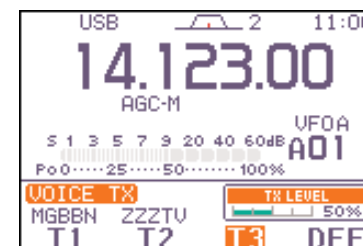
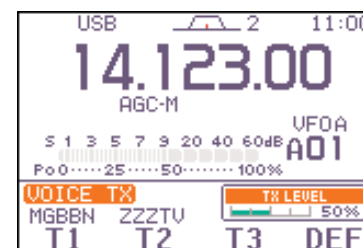

**Menu group selection**

Push [MENU/GRP] for 1 sec.  
 Selection from: M, S or G(Graphic)

**Menu selection (Example: S)**

Push [MENU/GRP] momentarily.  
 Selection from: S-1, S-2 or S-3



Either  
 Δ or ▽

**■ Voice set mode**

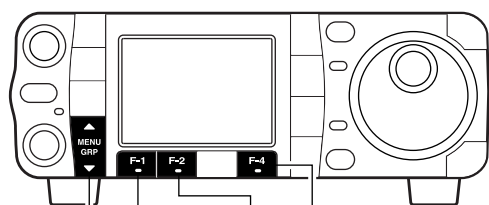

[MENU/GRP] [F-1] [F-2] [F-4]

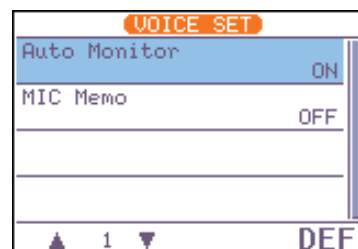
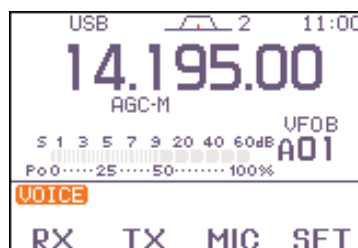

- ① Select S-1.
- ② Push [F-1 VO] then [▼(MENU/GRP)] to select the voice root menu.
  - If the voice root menu appears, skip the pushing [▼(MENU/GRP)]. The voice starting menu can be changed in the miscellaneous (others) set mode. (p. 134)
- ③ Push [F-4 SET] to enter the voice recorder set mode.
- ④ Push [F-1 ▲] or [F-2 ▼] to select the desired item, then rotate [DIAL] to set the selected function ON and OFF.
  - Push [F-4 DEF] for 1 sec. to select the default condition.
- ⑤ Push [▼(MENU/GRP)] to return to the voice root menu.

**◇ Voice set mode**

**1. Auto Monitor**

This item turns the auto monitor function ON and OFF. When this function is ON, the monitor function is automatically turned ON while transmitting a voice memory message.

• Push [F-4 DEF] for 1 sec. to return to default setting.

**ON**

Automatic monitor function is ON. (default)

**OFF**

Automatic monitor function is OFF.

**2. MIC Memo**

This item selects the mic memo function ON and OFF. When this function is ON, and you speak into the microphone (without pushing [PTT]), your voice is mixed with the received audio and recorded. This function is convenient when you want to record some information or comment while recording the received audio.

• Push [F-4 DEF] for 1 sec. to return to default setting.

**ON**

MIC memo function is ON.

**OFF**

MIC memo function is OFF. (default)

## Memory channels

The transceiver has 501 memory channels including 6 scan edge channels (3 pairs), and 2 call channels. In addition, a total of 5 memory banks (99 memory channel each), A to E, are available for usage by group, etc.

All 503 memory/call channels are tuneable which means the programmed frequency can be tuned temporarily with **[DIAL]**, etc., in memory mode.

Memory mode is very useful for quickly changing to often-used frequencies.

MEMORY CHANNEL	MEMORY CHANNEL NUMBER	CAPABILITY	TRANSFER TO VFO	OVER-WRITING	CLEAR
Regular (split memory)	1-99 (in each banks)	Independent transmit and receive frequencies and one mode in each memory channel. In addition, tone frequencies can also be stored for repeater use.	Yes	Yes	Yes
Scan edges	1A-3B (common)	One frequency and one mode in each memory channel as scan edges for programmed scan.	Yes	Yes	No
Call channels (split memory)	C1, C2 (common)	Same as regular channels, but only frequencies in 144 MHz (C1), 430 MHz (C2) band can be programmed.	Yes	Yes	No

## Memory channel selection

- Push **[PBT/M-ch/RIT]** momentarily to select the M-ch/RIT function, if the twin PBT is selected.
  - **[PBT/M-ch/RIT]** indicator (Green) goes out.
- Select **M-2**.
  - Push and hold **[MENU/GRP]** for 1 sec. once or twice to select the menu group **M**.
  - Push **[MENU/GRP]** momentarily one or more times to select the menu **M-2**.
- Push **[F-4 U/M]** to select memory mode.
- Rotate **[M-ch]** (inner) control to select the desired memory channel.
  - All memory channels including blank channels can be selected.
  - Rotating **[RIT]** (outer) control changes the bank.
  - **[▲]/[▼]** on the microphone also change the channels.
- To return to VFO mode, push **[F-4 U/M]** again.

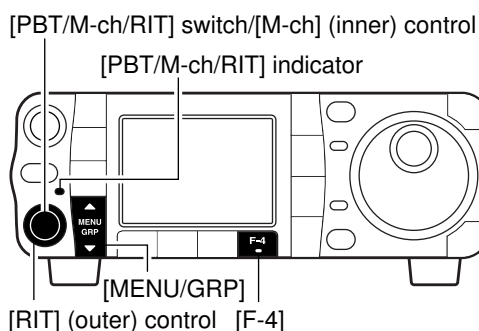

**[EXAMPLE]:** Selecting memory channel 17.

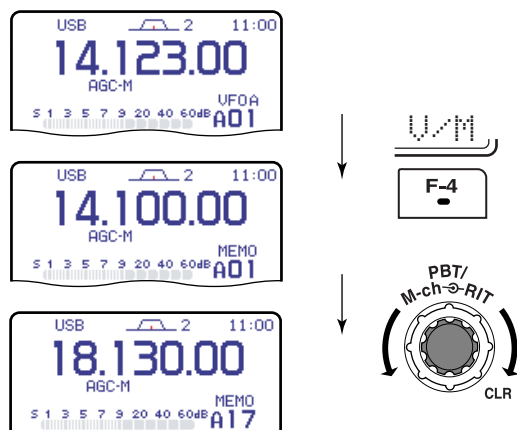

## Memory programming

Memory channel programming can be performed either in VFO mode or in memory mode.

### Menu group selection

Push **[MENU/GRP]** for 1 sec.  
Selection from: **M**, **S** or **G**(Graphic)



### Menu selection (Example: M)

Push **[MENU/GRP]** momentarily.  
Selection from: **M-1**, **M-2** or **M-3**

Either  
△ or ▽

### ◇ Programming in VFO mode

- ① Push **[PBT/M-ch/RIT]** momentarily to select the M-ch/RIT function, if the twin PBT is selected.
  - **[PBT/M-ch/RIT]** indicator (Green) goes out.
- ② Set the desired frequency and operating mode in VFO mode.
  - If you want to program the split frequency function, program both receive and transmit frequencies into VFO A and B, then turn ON the split function. (p. 89)
  - If you want to program a repeater function, set a tone frequency (p. 60) in addition to the receive/transmit frequencies.
- ③ Select **M-2**.
- ④ Push **[F-1 MEM]** to display the memory channel contents.
  - Memory channel contents appear above the multi-function key indicator.
  - Push **[F-1 LST]** to display the memory channel list. This is convenient for selecting the desired channel. Push **[▽(MENU/GRP)]** to exit the memory channel list.
- ⑤ Rotate **[M-ch]** to select the desired memory channel.
  - “**BLANK**” and “---,---,---” appear if the selected memory channel is a blank channel (and does not have contents).
  - Rotating **[RIT]** (outer) control changes the bank.
- ⑥ Push and hold **[F-2 MW]** for 1 sec. to program the displayed frequency and operating mode into the selected memory channel.

To check the programmed contents, push **[F-4 U/M]** to select memory mode.

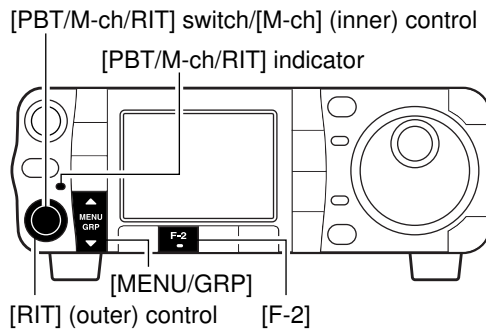

**[EXAMPLE]:** Programming 7.088 MHz/LSB into ch 12.

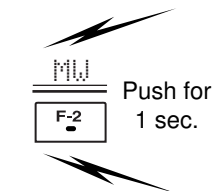
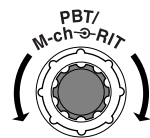
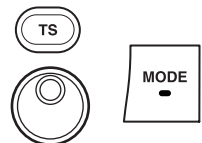
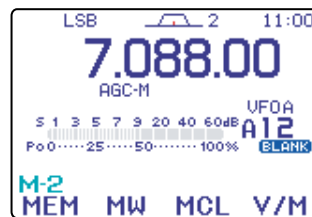

### ◇ Programming in memory mode

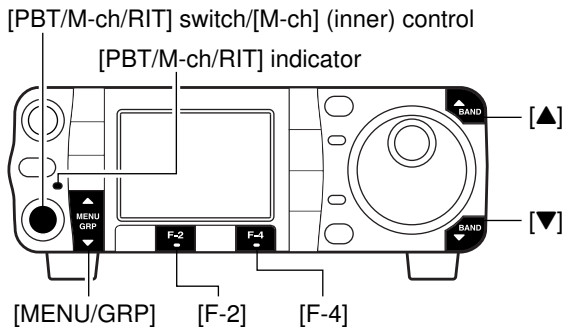

[PBT/M-ch/RIT] switch/[M-ch] (inner) control  
[PBT/M-ch/RIT] indicator

[MENU/GRP] [F-2] [F-4]

[▲] [▼]

**[EXAMPLE]:** Programming 21.280 MHz/USB into ch 18.

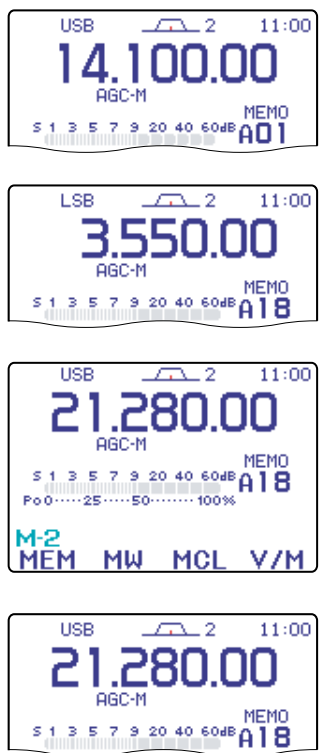

- ① Push **[PBT/M-ch/RIT]** momentarily to select the M-ch/RIT function, if the twin PBT is selected.
  - **[PBT/M-ch/RIT]** indicator (Green) goes out.
- ② Select **M-2**.
- ③ Push **[F-4]** to select memory mode, then select the desired memory channel with **[M-ch]**.
  - Memory channel contents appear instead of the VFO's frequency readout.
- ④ Set the desired frequency and operating mode.
  - To program a blank channel, push **[▲(BAND)]** or **[▼(BAND)]** to select the desired band or use direct frequency entry with the keypad (HM-151).
- ⑤ Push and hold **[F-2]** for 1 sec. to program the displayed frequency and operating mode into the memory channel.

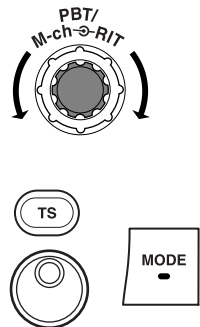

PBT/M-ch-RIT

TS

MODE

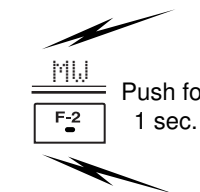

F-2 Push for 1 sec.

## Memory channel list

The memory channel list simultaneously shows 7 memory channels and their programmed contents.

You can select a desired memory channel from the memory channel list.

### Menu group selection

Push **[MENU/GRP]** for 1 sec.  
Selection from: **M**, **S** or **G**(Graphic)

### Menu selection (Example: M)

Push **[MENU/GRP]** momentarily.  
Selection from: **M-1**, **M-2** or **M-3**



Either  
△ or ▽

### ◇ Selecting a memory channel using the memory channel list

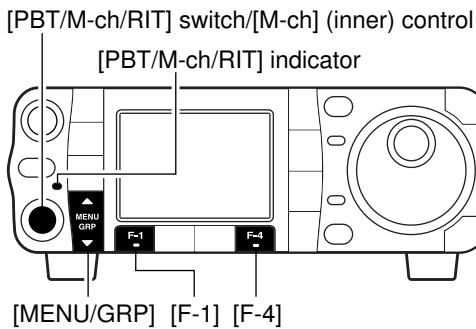

- ① Select **M-2**.
- ② Push **[F-4 U/M]** to select memory mode.
- ③ Push **[F-1 (MEM, LST)]** twice to enter the memory channel list.
- ④ Push **[PBT/M-ch/RIT]** momentarily to select the M-ch/RIT function, if the twin PBT is selected.
  - **[PBT/M-ch/RIT]** indicator (Green) goes out.
- ⑤ Rotate **[M-ch]** (inner) control to select the desired memory channel.
  - All memory channels including blank channels can be selected.
  - **[▲]/[▼]** on the microphone also changes the channels.
- ⑥ To exit the memory channel list, push **[▼(MENU/GRP)]** twice.

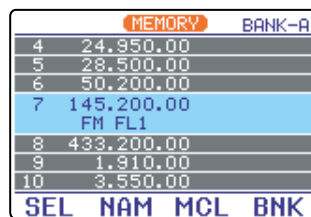
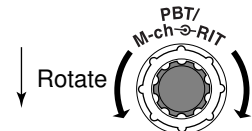
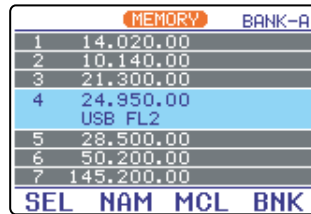
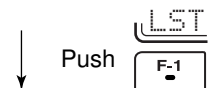
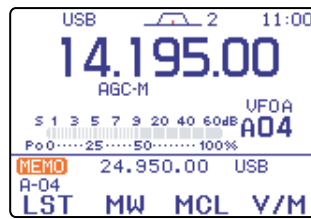
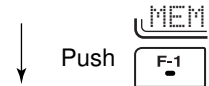
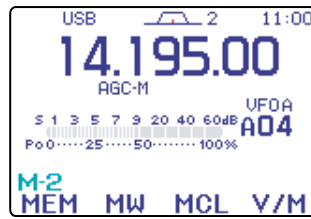



◇ Setting a memory channel as a select memory

Select memory channels are used for select memory scan. Select memory scan repeatedly scans the select memory channels only. This is useful to speed up the memory scan interval. Of course, select memory channels are also scanned during normal memory scan.

- ① Select the memory channel list as described at left.
- ② Push **[PBT/M-ch/RIT]** momentarily to select the M-ch/RIT function, if the twin PBT is selected.
  - **[PBT/M-ch/RIT]** indicator (Green) goes out.
- ③ Rotate **[M-ch]** (inner) control to select the desired memory channel.
  - All memory channels including blank channels can be selected.
  - **[▲]/[▼]** on the microphone also changes the channels.
- ④ Push **[F-1 SEL]** to set the memory channel as a select memory or not.
- ⑤ Repeat steps ③ to ④ to program another memory channel as a select memory channel, if desired.
- ⑥ Push **[▼(MENU/GRP)]** twice to exit the memory channel list.

Setting select memory channels is also possible in the memory scan indication. (p. 113)

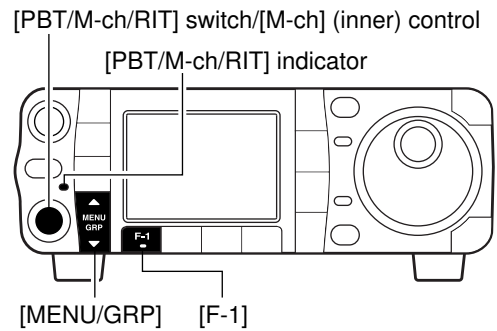

"★" appears for select memory channel.

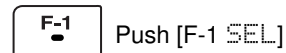
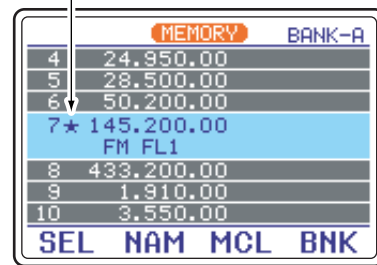

◇ Selecting a memory bank

The IC-7000 has a total of 5 memory banks (99 memory channel each), A to E, available for usage by group, etc.

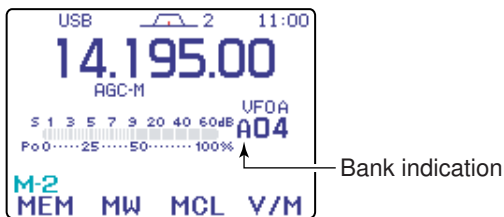

- ① Select the memory channel as described at p. 100.
- ② Push **[PBT/M-ch/RIT]** momentarily to select the M-ch/RIT function, if the twin PBT is selected.
  - **[PBT/M-ch/RIT]** indicator (Green) goes out.
- ③ Rotate **[RIT]** (outer) control to select the desired memory bank.

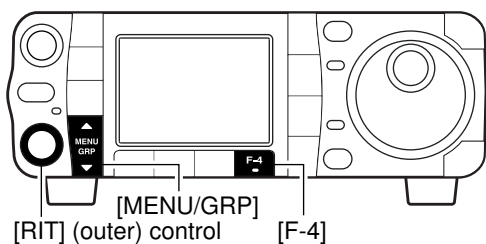

• Memory channel list indication

- ① Select the memory channel list as described at left.
- ② Push **[F-4 BNK]** several times to select the desired memory bank.
  - Rotating **[RIT]** (outer) control also changes the bank.
- ③ Push **[▼(MENU/GRP)]** twice to exit the memory channel list.

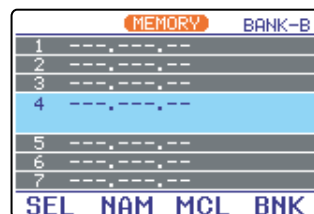
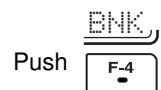
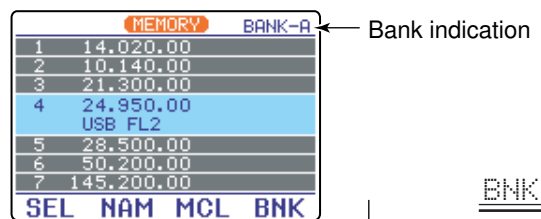

**Menu group selection**

Push [MENU/GRP] for 1 sec.  
Selection from: *M*, *S* or *G*(Graphic)

**Menu selection (Example: M)**

Push [MENU/GRP] momentarily.  
Selection from: *M-1*, *M-2* or *M-3*



◇ **Memory names**

All memory channels (including scan edges) can be tagged with alphanumeric names of up to 9 characters each.

Capital letters, small letters, numerals, some symbols (! # \$ % & ¥ ? " ' ` ^ + - \* / . , ; = < > ( ) [ ] { } | \_ ~ @) and spaces can be used.

• **Editing (programming) memory names**

- ① Select *M-2*.
- ② Push [F-4 ] to select memory mode.
- ③ Push [F-1] (MEM, LST) twice to enter the memory channel list.
- ④ Push [PBT/M-ch/RIT] momentarily to select the M-ch/RIT function, if the twin PBT is selected.
  - [PBT/M-ch/RIT] indicator (Green) goes out.
- ⑤ Rotate [M-ch] (inner) control to select the desired memory channel.
  - All memory channels including blank channels can be selected.
  - [▲]/[▼] on the microphone also changes the channels.
- ⑥ Push [F-2 ] to edit memory channel name.
  - A cursor appears and blinks.
  - Memory channel names of blank channels cannot be edited.
- ⑦ Push [▲(MENU/GRP)] several times to select the desired character group.
  - [ABC], [abc], [123] or [etc] indicates the capital letters, small letters, numerals or symbols, respectively
- ⑧ Input the desired character by rotating [DIAL].
  - Push [F-1 ] or [F-2 ] for cursor movement.
  - Push [F-3 DEL] to delete the selected character.
  - Push [F-4 SPC] to input a space.
  - Pushing the HM-151's keypad, [0]–[9], can also enter numerals.
- ⑨ Push [▼(MENU/GRP)] to input and set the name.
  - The cursor disappears.
- ⑩ Repeat steps ⑤ to ⑨ to program another memory channel's name, if desired.
- ⑪ Push [▼(MENU/GRP)] twice to exit the memory channel list.

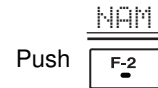
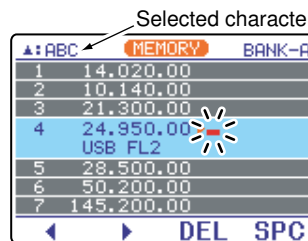
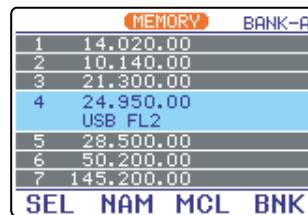
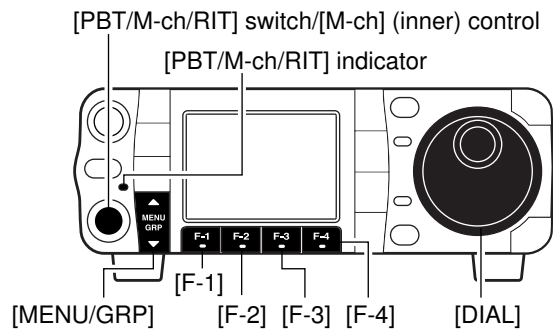

## Memory clearing

Any unnecessary memory channels can be cleared. The cleared memory channels become blank channels.

- ① Select **M-2**.
- ② Push **[F-4 U/M]** momentarily to select the memory mode.
- ③ Push **[PBT/M-ch/RIT]** momentarily to select the M-ch/RIT function, if the twin PBT is selected.
  - **[PBT/M-ch/RIT]** indicator (Green) goes out.
- ④ Rotate **[M-ch]** to select the memory channel to be cleared.
- ⑤ Push and hold **[F-3 MCL]** for 1 sec. to clear the contents.
  - The programmed frequency and operating mode disappear and **"BLANK"** appears.
- ⑥ To return to VFO mode, push **[F-4 U/M]** again.

[PBT/M-ch/RIT] switch/[M-ch] (inner) control  
[PBT/M-ch/RIT] indicator

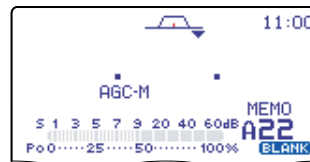
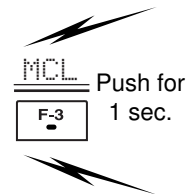
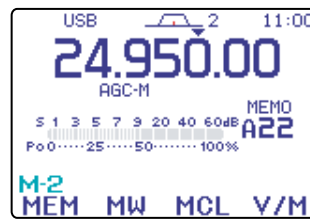
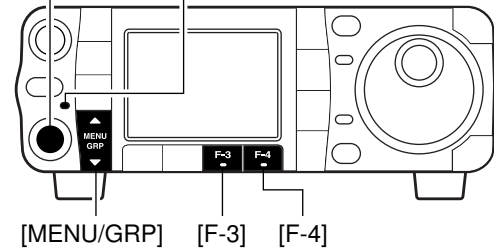

## Memory clearing using the memory channel list

- ① Select **M-2**.
- ② Push **[F-4 U/M]** to select memory mode.
- ③ Push **[F-1 (MEM, LST)]** twice to enter the memory channel list.
- ④ Push **[PBT/M-ch/RIT]** momentarily to select the M-ch/RIT function, if the twin PBT is selected.
  - **[PBT/M-ch/RIT]** indicator (Green) goes out.
- ⑤ Rotate **[M-ch]** to select the memory channel to be cleared (blanked).
- ⑥ Push and hold **[F-3 MCL]** for 1 sec. to clear the contents.
- ⑦ Push **[▼(MENU/GRP)]** twice to exit the memory channel list.

[PBT/M-ch/RIT] switch/[M-ch] (inner) control  
[PBT/M-ch/RIT] indicator

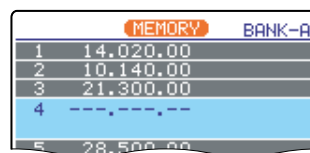
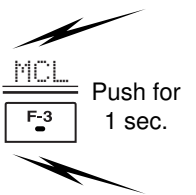
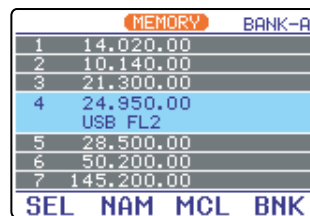
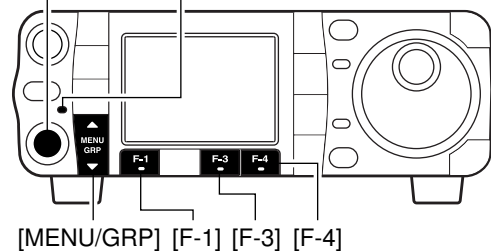

Programmed frequency and operating mode disappear.

## ■ Frequency transferring

The frequency and operating mode in a memory channel can be transferred to the VFO.

Frequency transferring can be performed in either VFO mode or memory mode.

### Menu group selection

Push **[MENU/GRP]** for 1 sec.  
Selection from: **M**, **S** or **G**(Graphic)

### Menu selection (Example: M)

Push **[MENU/GRP]** momentarily.  
Selection from: **M-1**, **M-2** or **M-3**



### ◇ Transferring in VFO mode

This is useful for transferring programmed contents to VFO.

- ① Select **M-2**.
- ② Push **[F-4 U/M]** momentarily to select the VFO mode.
- ③ Push **[F-1 MEM]** to display the memory channel contents.
  - Memory channel contents appear above the multi-function key indicator.
- ④ Push **[PBT/M-ch/RIT]** momentarily to select the M-ch/RIT function, if the twin PBT is selected.
  - **[PBT/M-ch/RIT]** indicator (Green) goes out.
- ⑤ Select a memory channel with **[M-ch]**.
  - "**BLANK**" appears if the selected memory channel is a blank channel (and does not have contents). In this case transferring is not possible.
- ⑥ Push and hold **[F-4 U/M]** for 1 sec. to transfer the frequency and operating mode.
  - Transferred frequency and operating mode appear in the display.

[PBT/M-ch/RIT] switch/[M-ch] (inner) control

[PBT/M-ch/RIT] indicator

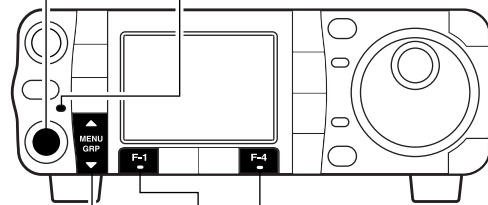

[MENU/GRP] [F-1] [F-4]

**[EXAMPLE]:** Transferring contents of memory 16.

Operating frequency : 21.320 MHz/USB (VFO)

Contents of memory 16 : 14.020 MHz/CW

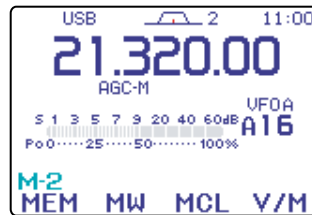
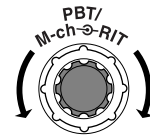
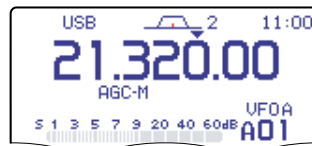

### ◇ Transferring in memory mode

This is useful for transferring frequency and operating mode while operating in memory mode.

When you have changed the frequency or operating mode in the selected memory channel.

- **Displayed** frequency and mode are transferred.
- **Programmed** frequency and mode in the memory channel are not transferred, and they remain in the memory channel.

- ① Push **[PBT/M-ch/RIT]** momentarily to select the M-ch/RIT function, if the twin PBT is selected.
  - **[PBT/M-ch/RIT]** indicator (Green) goes out.
- ② Select **M-2**.
- ③ Push **[F-4 U/M]** momentarily to select the memory mode.
- ④ Rotate **[M-ch]** to select the memory channel to be transferred.
  - **"BLANK"** appears if the selected memory channel is a blank channel (and does not have contents). In this case transferring is not possible.
- ⑤ Push and hold **[F-4 U/M]** for 1 sec. to transfer the frequency and operating mode.
  - Displayed frequency and operating mode are transferred to the VFO.
- ⑥ Push **[F-4 U/M]** momentarily to select the VFO mode.

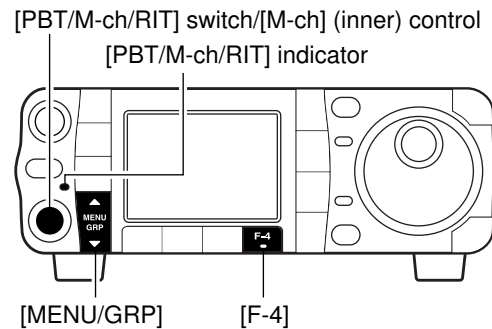

## ■ Memo pads

The transceiver has a memo pad function to store frequency and operating mode for easy write and recall. The memo pads are separate from memory channels.

The default number of memo pads is 5, however, this can be increased to 10 in the miscellaneous (others) set mode if desired (p. 132).

Memo pads are convenient when you want to memorize a frequency and operating mode temporarily, such as when you find a DX station in a pile-up or when a station is busy for a long time and you want to temporarily search for other stations.

Use the transceiver's memo pads instead of relying on hastily scribbled notes that are easily misplaced.

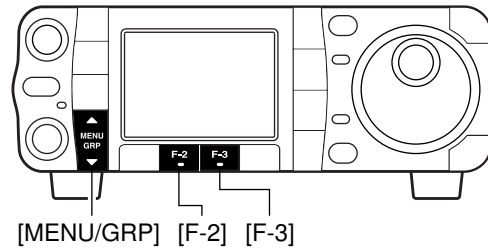

### Menu group selection

Push **[MENU/GRP]** for 1 sec.  
Selection from: **M**, **S** or **G**(Graphic)

### Menu selection (Example: S)

Push **[MENU/GRP]** momentarily.  
Selection from: **S-1**, **S-2** or **S-3**



## ◇ Writing frequencies and operating modes into memo pads

- ① Select **S-3**.
- ② Push **[F-2 MPW]** to program the frequency into a memo pad.

When you write a 6th frequency and operating mode, the oldest written frequency and operating mode are automatically erased to make room for the new settings.

**NOTE:** Each memo pad must have its own unique combination of frequency and operating mode; memo pads having identical settings cannot be written.

Displayed frequency and mode

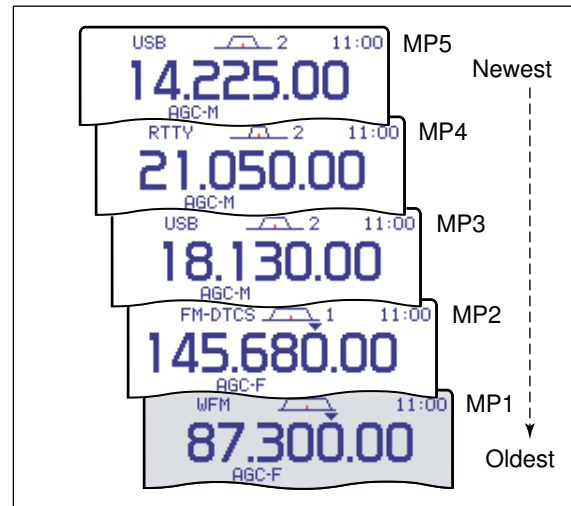
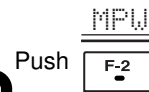
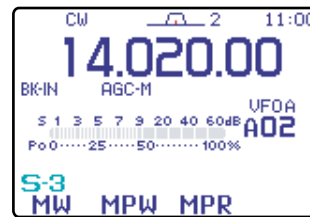

The oldest written frequency and mode are erased.

### ◇ Calling up a frequency from a memo pad

You can call up the desired frequency and operating mode of a memo pad by pushing **[F-3 MPR]** in the **S-3** menu.

- Make sure **S-3** is selected in advance.
- Both VFO and memory modes can be used.
- The frequency and operating mode are called up, starting from the most recently written.

When you call up a frequency and an operating mode from memo pads with **[F-3 MPR]**, the previously displayed frequency and operating mode are automatically stored in a temporary pad. The frequency and operating mode in the temporary pad can be recalled by pushing **[F-3 MPR]** one or more times.

**NOTE:** If you change the frequency or operating mode called up from a memo pad, the frequency and operating mode in the temporary pad are erased.

VFO or memory mode

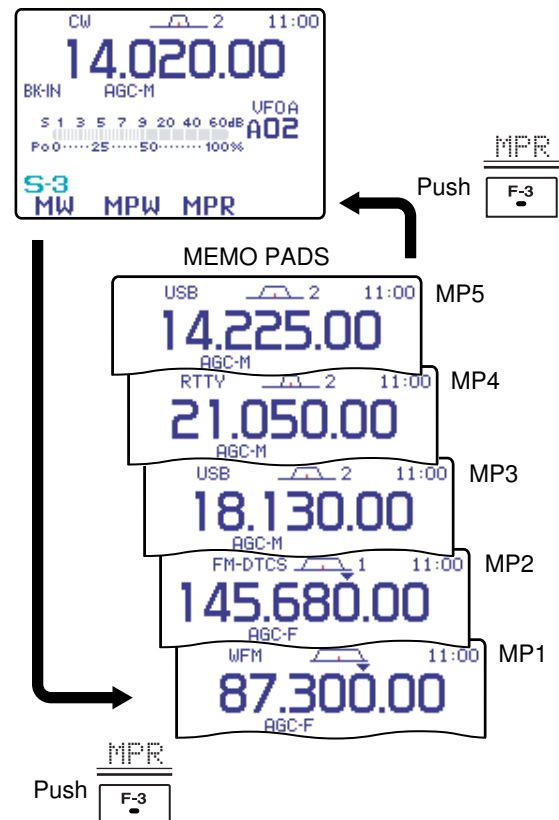

## ■ Scan types

### PROGRAMMED SCAN

Repeatedly scans between two scan edge frequencies (scan edge memory channels 1A and 1B).

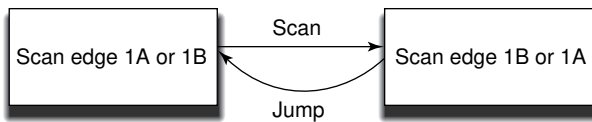

This scan operates in VFO mode.

### PRIORITY WATCH

Checks for signals on a memory while operating on a VFO frequency.

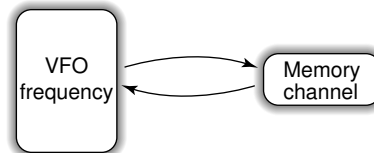

This scan operates in VFO mode.

### MEMORY SCAN

Repeatedly scans all programmed memory channels.

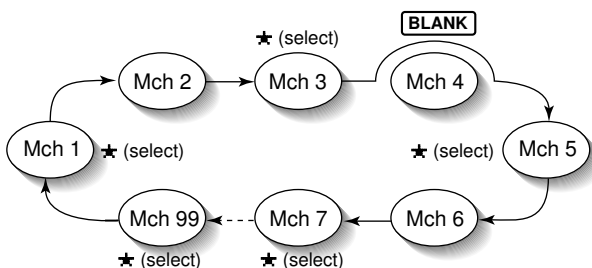

This scan operates in memory mode.

### SELECTED MEMORY SCAN

Repeatedly scans all selected memory channels.

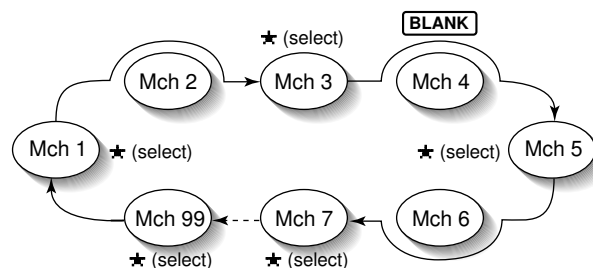

This scan operates in memory mode.

## ■ Preparation

### • Channels

*For programmed scan:* Program scan edge frequencies into scan edge memory channels 1A and 1B. (p. 101)

*For memory scan:* Program two or more memory channels except scan edge memory channels.

*For memory select scan:* Designate two or more memory channels as select memory channels—select a memory channel, then push [F-2 SEL] in the S-2 menu (memory mode) to designate the channel as a select memory channel.

*For priority watch:* Program one memory channel to be watched.

### • Scan resume ON/OFF

You can select the scan to resume or cancel when detecting a signal, in the miscellaneous (others) set mode, item "SCAN RESUME." Scan resume ON/OFF must be set before operating a scan. See p. 132 for ON/OFF setting and scan resume condition details.

### • Scan speed

Scan speed can be selected from 2 levels, high or low, in the miscellaneous (others) set mode. See p. 132 for details.

### • Squelch condition

SCAN STARTS WITH	PROGRAMMED SCAN	MEMORY SCANS PRIORITY WATCH
SQUELCH OPEN	The scan continues until it is stopped manually, and does not pause even if it detects signals.	Scan pauses on each channel when the scan resume is ON; not applicable when OFF.
	This is not applicable when the scan resume is OFF and a programmable step (more than 1 kHz) is selected.	
SQUELCH CLOSED	Scan stops when detecting a signal. If you set scan resume ON in the miscellaneous (others) set mode, the scan pauses for 10 sec. when detecting a signal, then resumes. When a signal disappears while scan is paused, scan resumes 2 sec. later.	



**Menu group selection**  
 Push [MENU/GRP] for 1 sec.  
*Selection from: M, S or G(Graphic)*

**Menu selection (Example: M)**  
 Push [MENU/GRP] momentarily.  
*Selection from: S-1, S-2 or S-3*



Either  
 ▲ or ▼

## Programmed scan operation

- ① Select S-2.
- ② Push [F-3 U/M] to select VFO mode.
- ③ Select the desired operating mode.
  - The operating mode can also be changed while scanning.
- ④ Set [RF/SQL] open or closed.
  - See page at left for squelch condition.
  - If the [RF/SQL] control function is set as “AUTO,” the squelch is always open in SSB, CW and RTTY modes. See pgs. 1, 35, 129 for details.
- ⑤ Push [F-1 SCN] to start the scan.
  - Decimal point blinks while scanning.
- ⑥ When the scan detects a signal, the scan turns OFF, pauses or ignores it depending on the resume setting and the squelch condition.
- ⑦ To cancel the scan push [F-1 SCN].

**NOTE:** If the same frequencies are programmed into both scan edge memory channels 1A and 1B, programmed scan does not start.

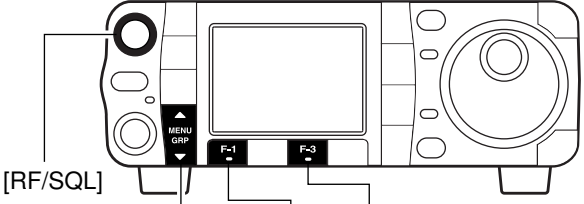
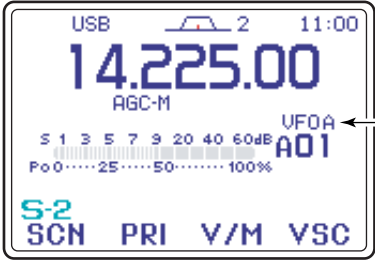



then push [F-1 SCN]

## Memory scan operation

- ① Select the desired memory bank, if necessary.
  - Push [PBT/M-ch/RIT] momentarily to select the M-ch/RIT function, if the twin PBT is selected.
    - [PBT/M-ch/RIT] indicator (Green) goes out.
  - Rotate [RIT] (outer) control to select the desired memory bank.
- ② Select S-2.
- ③ Push [F-3 U/M] to select memory mode.
- ④ Close the squelch with [RF/SQL].
- ⑤ Push [F-1 SCN] to start the scan.
  - Decimal point blinks while scanning.
- ⑥ When the scan detects a signal, the scan stops or pauses depending on the resume setting.
- ⑦ To cancel the scan push [F-1 SCN].

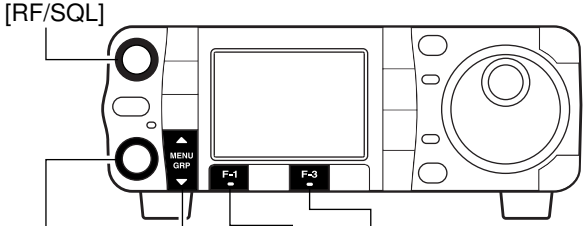
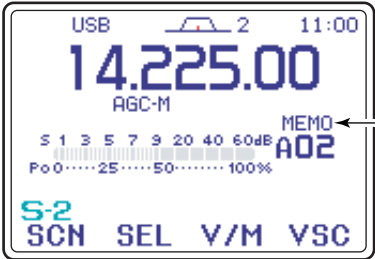
**NOTE:** Two or more memory channels must be programmed for memory scan to start.

then push [F-1 SCN]

**Menu group selection**

Push [MENU/GRP] for 1 sec.  
Selection from: M, S or G(Graphic)

**Menu selection (Example: M)**

Push [MENU/GRP] momentarily.  
Selection from: S-1, S-2 or S-3



**Select memory scan operation**

- ① Select S-2.
- ② Push [F-3 V/M] to select memory mode.
- ③ Close the squelch with [RF/SQL].
- ④ Push [F-1 SCN] to start the memory scan.
  - Decimal point blinks while scanning.
- ⑤ Push [F-2 SEL] to change the memory scan to select memory scan.
- ⑥ When the scan detects a signal, the scan stops or pauses depending on the resume setting.
- ⑦ To cancel the scan push [F-1 SCN].

**NOTE:** Two or more memory channels must be designated as select memory channels for select memory scan to start (see p. 104).

While scan function is not active, pushing [F-2 SEL] sets the select memory channels ON or OFF. And pushing and holding [F-2 SEL] for 2 sec. clears the all select memory channels.

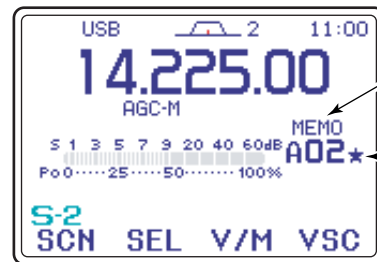
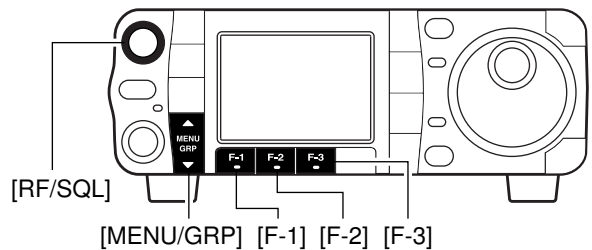

Select memory mode.  
Designate "★."

Push [F-1 SCN], then push [F-2 SEL].

**Priority watch**

- ① Select VFO mode, then set a frequency.
- ② Close the squelch with [RF/SQL].
- ③ Set the desired memory channel as the channel to be watched.
- ④ Select S-2.
- ⑤ Push [F-2 PRI] to start the priority watch.
  - "P" appears and decimal points blink while watching VFO, and then "P" and decimal points blink while watching a memory channel.
- ⑥ When the scan detects a signal, the scan pauses for 10 sec. or until the signal disappears, depending on the resume setting.
- ⑦ To cancel the scan push [F-2 PRI].

**NOTE:** The paused condition when detecting a signal differs depending on the scan resume condition. (p. 132)

- resume on: pauses for 10 sec.
- resume off: pauses until the signal disappears.

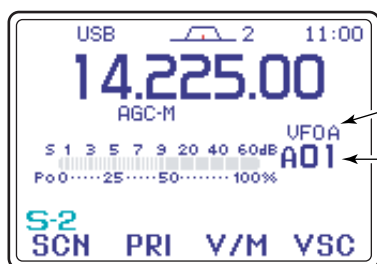
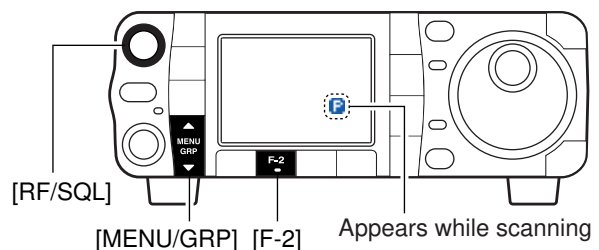

Select VFO mode.  
Select watching channel.

Push [F-2 PRI].

## ■ Optional AT-180 AUTOMATIC ANTENNA TUNER operation

The AT-180 automatic antenna tuner matches the IC-7000 to the connected antenna automatically. Once the tuner matches an antenna, the variable capacitor setting are memorized as a preset point for each frequency range (100 kHz steps). Therefore, when you change the frequency range, the variable capacitors are automatically preset to the memorized point.

### NOTE:

- The AT-180 can match both HF and 50 MHz bands. However, operation is different for the HF and 50 MHz bands.
- When connecting the AT-180, the IC-7000's output power must be set over the 10 W. Otherwise, the AT-180 may not be tuned correctly. (AT-180's minimum operating input power is 8 W.)

**CAUTION: NEVER** transmit with the tuner ON when no antenna is connected. This will damage both the transceiver and antenna tuner.

The AT-180 cannot be used for the 144/430 MHz bands. When operating on the 144/430 MHz band, pushing [TUNER/CALL] selects the call channel (p. 100).

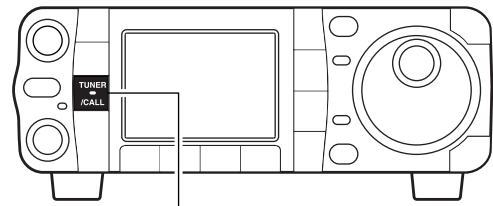

[TUNER/CALL]

### ◇ Tuner operation

#### • For the HF band:

Push [TUNER/CALL] to turn the tuner ON. The antenna is tuned automatically during transmission when the antenna SWR is higher than 1.5:1.

- When the tuner is ON, "TUNE" indication appears.

#### • For the 50 MHz band:

Push and hold [TUNER/CALL] for 1 sec. to tune the antenna. If "TUNE" indicator blinks slowly while transmitting, push and hold [TUNER/CALL] for 1 sec. again to re-tune the antenna.

### ◇ Manual tuning

During SSB operation on HF bands at low voice levels, the AT-180 may not be tuned correctly. In such cases, manual tuning is helpful.

Push [TUNER/CALL] for 2 sec. to start manual tuning.

- CW mode is selected, a side tone is emitted, and "TUNE" indicator blinks; then, the previous mode is selected.

If the tuner cannot reduce the SWR to less than 1.5:1 after 20 sec. of tuning, "TUNE" indicator disappears.

In this case, check the following:

- the antenna connection and feedline
- the antenna SWR (p. 36; meter function)

#### Through inhibit (HF bands only)

The AT-180 has a through inhibit condition. When selecting this condition, the tuner can be used at poor SWR's. In this case, automatic tuning in the HF bands activates only when exceeding SWR 3:1. Therefore, manual tuning is necessary each time you change the frequency. Although termed "through inhibit," the tuner will be set to the "through" configuration if the SWR is higher than 3:1 after tuning.

#### CONVENIENT

#### • Tuner sensitive condition (HF bands only)

If you require critical tuning at any time during transmission, select the tuner sensitive condition. See p. 131 for selection.

#### • Automatic tuner start (HF bands only)

If you want to turn OFF the tuner under conditions of VSWR 1.5:1 or less, use "automatic tuner on" and turn the tuner OFF. See p. 130 for turning the function ON and OFF.

**Menu group selection**

Push [MENU/GRP] for 1 sec.  
 Selection from: *M*, *S* or *G*(Graphic)

**Menu selection (Example: M)**

Push [MENU/GRP] momentarily.  
 Selection from: *S-1*, *S-2* or *S-3*



**Optional AH-4 AUTOMATIC ANTENNA TUNER operation**

The AH-4 matches the IC-7000 to a long wire antenna more than 7 m/23 ft long (3.5 MHz and above).

- See p. 20 for connection.
- See the AH-4 instruction manual for AH-4 installation and antenna connection details.

**AH-4 setting example:**

For mobile operation

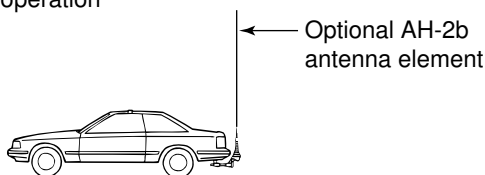

For outdoor operation

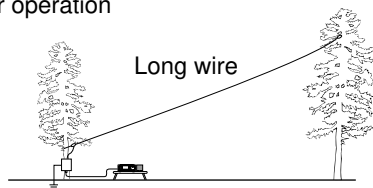

**⚠ DANGER!: HIGH VOLTAGE!**

**NEVER** touch the antenna element while tuning or transmitting.

**NEVER** operate the AH-4 without an antenna wire. The tuner and transceiver will be damaged.

**NEVER** operate the AH-4 when it is ungrounded.

Transmitting before tuning may damage the transceiver. Note that the AH-4 cannot tune when using a  $\frac{1}{2} \lambda$  long wire or on a multiple of that frequency.

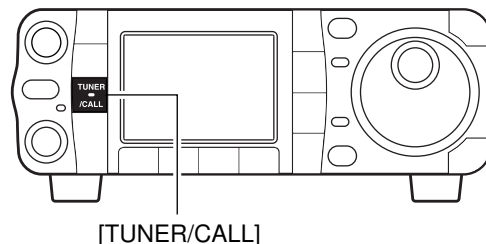

**◇ AH-4 operation**

Tuning is required for each frequency. **Be sure** to re-tune the antenna before transmitting when you change the frequency—even slightly.

- ① Set the desired frequency in an HF band.
  - The AH-4 will not operate on frequencies outside of ham bands.
- ② Push and hold [TUNER/CALL] for 1 sec.
  - “**TUNE**” indicator and “CW” appears while tuning.
- ③ “**TUNE**” indicator stays ON when tuning is complete.
  - When the connected wire cannot be tuned, “**TUNE**” indicator blinks, and the AH-4 is bypassed and the antenna wire is connected to the antenna connector on the transceiver directly.
- ④ To bypass the AH-4 manually, push [TUNER/CALL].

CONVENIENT

**• PTT tune function**

The AH-4 is always tuned when the PTT is pushed after the frequency is changed (more than 1%). This function removes the “push and hold [TUNER/CALL]” operation and activates first transmission on the new frequency. This function is turned ON in the miscellaneous (others) set mode (p. 131).

## ■ Packet operation

### ◇ Data socket

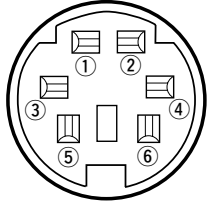

Rear panel view

PIN #/NAME	DESCRIPTION
① DATA IN	Communication data input.
② GND	Ground for DATA IN, DATA OUT and AF OUT.
③ PTPP	Transmits when grounded. When grounded, microphone input (pin 6) of [MIC] connector will be disconnected.
④ DATA OUT	Outputs 9600 bps receive data.
⑤ AF OUT	Outputs 1200 bps receive data.
⑥ SQL	Squelch output. Goes to ground when squelch opens.

### ◇ Adjusting the data speed

- ① Select M-3.
- ② Push [F-4 9600] to select the 9600 baud mode ON and OFF.
  - “9600” appears when the 9600 baud mode is activated.

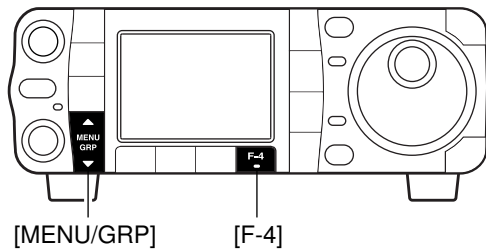

[MENU/GRP]

[F-4]

### ◇ Adjusting the transmit signal output from the TNC

When setting data transmission speed to 9600 baud bps, the data signal coming from the TNC is applied exclusively to the internal limiter circuitry to automatically maintain bandwidth.

**NEVER** apply data levels from the TNC of over 0.6 Vp-p, otherwise the transceiver will not be able to maintain the band width and may possibly interfere with other stations.

**NOTE:** Read the instructions supplied with your TNC carefully before attempting packet operation with the IC-7000.

1. When using a level meter or oscilloscope, adjust the TX audio level (DATA IN level) from the TNC as follows.
  - 0.4 Vp-p (0.2 Vrms): recommended level
  - 0.2–0.5 Vp-p (0.1–0.25 Vrms): acceptable level
2. When not using a measuring device.
  - ① Connect the IC-7000 to a TNC.
  - ② Enter a test mode (“CAL”, etc.) on the TNC, then transmit some test data.
  - ③ *When the transceiver fails to transmit test data or transmits sporadically ([TX] indicator doesn't light red or blinks):*
    - Decrease the TNC output level until [TX] indicator lights red continuously.*When transmission is not successful even though [TX] indicator lights red continuously:*
    - Increase the TNC output level.

# 12 CLOCK AND TIMERS

## ■ Time set mode

This transceiver has a built-in 24-hour clock with power-off timer function. The clock indication is always displayed except after pushing [F-INP/ENT] (HM-151).

### • Set mode operation

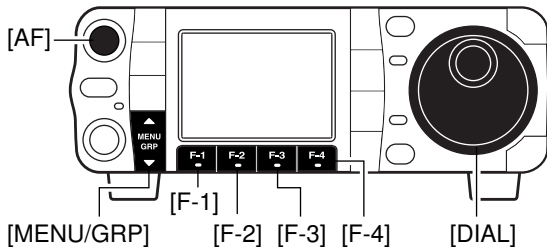

- ① Push [AF(SET)] momentarily to enter the set mode menu.
- ② Push [F-3 TIME] to enter the time set mode.
- ③ Push [F-1 ▲] or [F-2 ▼] to select the desired item.
- ④ Rotate [DIAL] to set or select the desired value or condition.
  - Push [F-4 DEF] for 1 sec. to select a default value or condition.
- ⑤ Push [▼(MENU/GRP)] twice to exit the set mode.

### 1 Year

This item sets the current year.

2005

Rotate [DIAL], then push [F-3 SET] to set the year.

### 2 Date

This item sets the current date.

3-15(Tue)

Rotate [DIAL], then push [F-3 SET] to set the date.

### 3 Time (Now)

This item sets the current time for the built-in 24-hour clock.

15:00

Rotate [DIAL], then push [F-3 SET] to set the time.

### 4 CLOCK2 Function

This item turns the second clock indication ON and OFF instead of 1st clock.

The clock 2 is convenient to indicate the UTC and other country's local time, etc.

• Push [F-4 DEF] for 1 sec. to set the default value.

ON

The clock 2 is displayed instead of the 1st clock indication.

OFF

The clock 2 does not display. (default)

### 5 CLOCK2 Offset

This item sets the desired off-set time period for the clock 2 indication within -24:00 to +24:00 in 5 min. steps.

• Push [F-4 DEF] for 1 sec. to set the default value.

± 0:00  
(default)

+ 9:00

Rotate [DIAL] to set the time.

### 6 Auto Power OFF

This item sets the power-off period for automatic shut-down after the power-on timer has turned power ON.

60min

Push [F-3 SET] to enter the time.

### ◇ Setting the current year

- ① Entering time set mode, push [F-1 ▲] to select "Year" item.

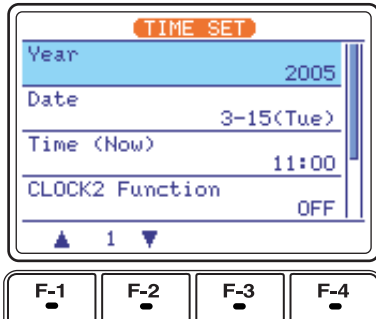

- ② Set the current year using [DIAL].  
• "Push [SET]" blinks.

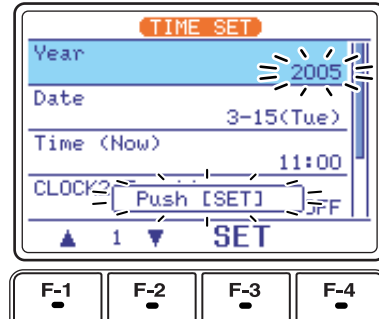

- ③ Push [F-3 SET] to enter the set year.  
• Push [▼(MENU/GRP)] to cancel the setting.  
④ Push [▼(MENU/GRP)] twice to exit time set mode.

### ◇ Setting the current date

- ① Entering time set mode, push [F-1 ▲] or [F-2 ▼] to select "Date" item.  
② Rotate [DIAL] to set the current date.  
• "Push [SET]" blinks.  
③ Push [F-3 SET] to enter the set date.  
• Push [▼(MENU/GRP)] to cancel the setting.  
④ Push [▼(MENU/GRP)] twice to exit time set mode.

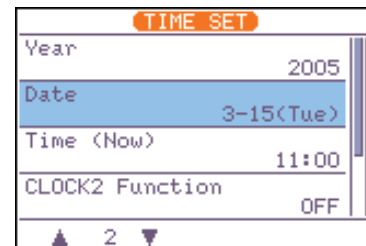

### ◇ Setting the current time

- ① Entering time set mode, push [F-1 ▲] or [F-2 ▼] to select "Time (Now)" item.  
② Rotate [DIAL] to set the current time.  
• "Push [SET]" blinks.  
③ Push [F-3 SET] to enter the set time.  
• Push [▼(MENU/GRP)] to cancel the setting.  
④ Push [▼(MENU/GRP)] twice to exit time set mode.

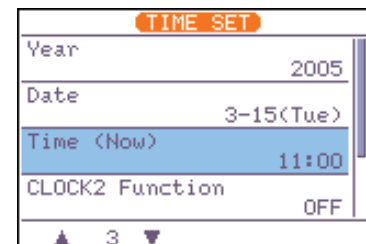

◇ **Clock2 function activity**

- ① Entering time set mode, push **[F-1 ▲]** or **[F-2 ▼]** to select “**CLOCK2 Function**” item.
- ② Select the **CLOCK2** function activity using **[DIAL]**.
- ③ Push **[▼(MENU/GRP)]** twice to exit time set mode.

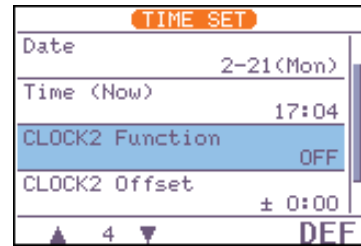

◇ **Clock2 offset setting**

- ① Entering time set mode, push **[F-1 ▲]** or **[F-2 ▼]** to select “**CLOCK2 Offset**” item.
- ② Rotate **[DIAL]** to set the offset time within -24:00 to +24:00 in 5 min. steps.
- ③ Push **[▼(MENU/GRP)]** twice to exit time set mode.

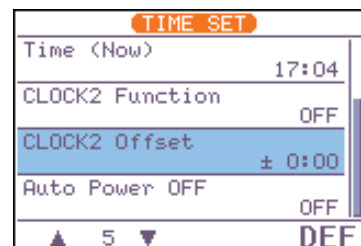

◇ **Auto power OFF activity**

The transceiver can be set to automatically turn OFF after a specified period is with beep when no operation is performed. The power-off period can be set to 30–120 min. in 30 min. steps.

- ① Entering time set mode, push **[F-2 ▼]** to select “**Auto Power OFF**” item.
- ② Set the desired power-off time using **[DIAL]**.
  - “Push **[SET]**” blinks.
- ③ Push **[F-3 SET]** to enter the set time.
  - Push **[▼(MENU/GRP)]** to cancel the setting.
- ④ Push **[▼(MENU/GRP)]** twice to exit timer set mode.

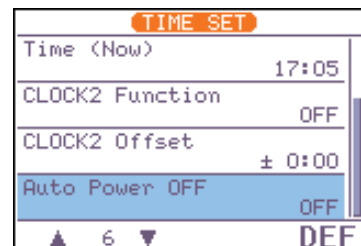



## ■ Set mode description

Set mode is used for programming infrequently changed values or conditions of functions. This transceiver has a quick set mode, display set mode, timer set mode and miscellaneous (others) set mode.

### • Set mode operation

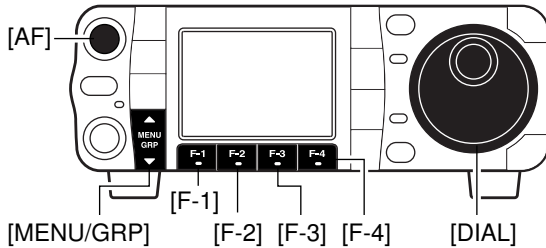

- ① Push **[AF(SET)]** momentarily to enter the set mode menu.
- ② Push **[F-1 QS]**, **[F-2 DISP]**, **[F-3 TIME]** or **[F-4 OTH]** to enter the desired set mode.
- ③ Push **[F-1 ▲]** or **[F-2 ▼]** to select the desired item.
- ④ Set the desired condition using **[DIAL]**.
  - Push **[F-4 DEF]** for 1 sec. to select a default condition or value.
- ⑤ Push **[▼(MENU/GRP)]** twice to exit the set mode.

### • Start up screen

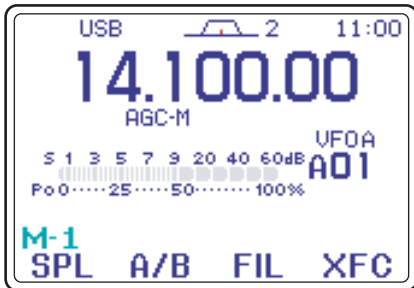

Push **[AF]** momentarily

### • Set mode menu

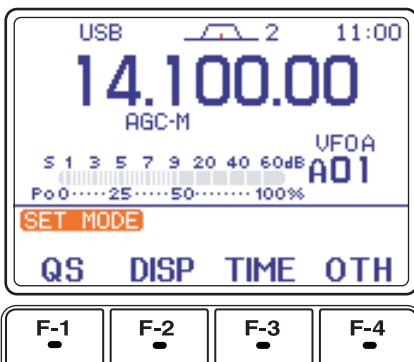

### • Quick set mode (p. 121)

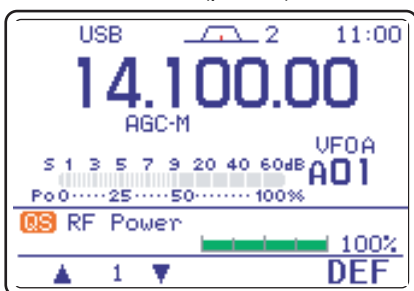

### • Display set mode (p. 124)

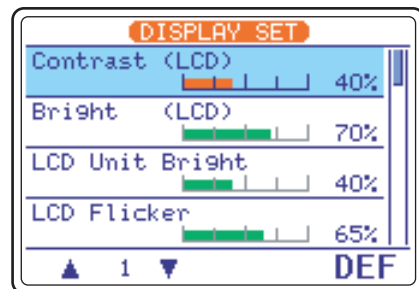

### • Time set mode (p. 117)

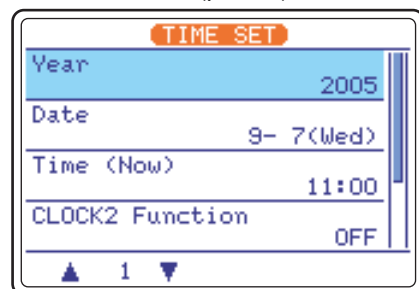

### • Miscellaneous (others) set mode (p. 128)

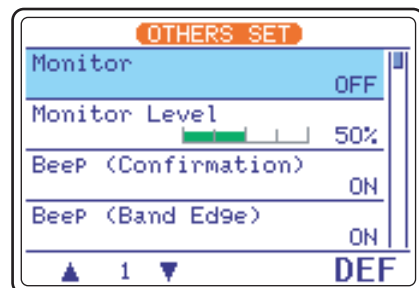

## ■ Quick set mode

Mode	Set mode item	Default setting
SSB	1 RF Power	100%
	2 MIC Gain	50%
	3 SSB TBW (WIDE) L	100 [Hz]
	4 SSB TBW (WIDE) H	2900 [Hz]
	5 SSB TBW (MID) L	300 [Hz]
	6 SSB TBW (MID) H	2700 [Hz]
	7 SSB TBW (NAR) L	500 [Hz]
	8 SSB TBW (NAR) H	2500 [Hz]
CW	1 RF Power	100%
	2 Key Speed	20WPM
	3 CW Pitch	600 [Hz]
	4 Side Tone Level	50%
	5 Side Tone Level Limit	ON
RTTY	1 RF Power	100%
	2 Twin Peak Filter	OFF
	3 RTTY Mark Frequency	2125 [Hz]
	4 RTTY Shift Width	170 [Hz]
	5 RTTY Keying Polarity	Normal
AM FM/WFM	1 RF Power	100%
	2 MIC Gain	50%

### RF Power (all modes)

This item adjusts the RF output power. The RF output power can be adjusted from 0 to 100% in 1% steps.



### MIC Gain (SSB/AM/FM modes)

This item adjusts microphone gain from 0 to 100% in 1% steps.

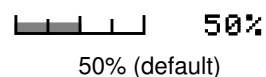

### SSB TBW (WIDE) L (SSB mode)

These items set the transmission passband width for the wide setting by selecting the lower and higher frequencies.

Lower freq. : 100 (default), 200, 300 and 500 Hz

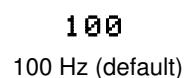

### ■ Quick set mode (continued)

<p><b>SSB TBW (WIDE) H (SSB mode)</b></p> <p>These items set the transmission passband width for the wide setting by selecting the lower and higher frequencies.</p> <p>Higher freq.: 2500, 2700, 2800 and 2900 Hz (default)</p>	<p><b>2900</b> 2900 Hz (default)</p>
<p><b>SSB TBW (MID) L (SSB mode)</b></p> <p>These items set the transmission passband width for the middle setting by selecting the lower and higher frequencies.</p> <p>Lower freq. : 100, 200, 300 (default) and 500 Hz</p>	<p><b>300</b> 300 Hz (default)</p>
<p><b>SSB TBW (MID) H (SSB mode)</b></p> <p>These items set the transmission passband width for the middle setting by selecting the lower and higher frequencies.</p> <p>Higher freq.: 2500, 2700 (default) 2800 and 2900 Hz</p>	<p><b>2700</b> 2700 Hz (default)</p>
<p><b>SSB TBW (NAR) L (SSB mode)</b></p> <p>These items set the transmission passband width for the narrow setting by selecting the lower and higher frequencies.</p> <p>Lower freq. : 100, 200, 300 and 500 Hz (default)</p>	<p><b>500</b> 500 Hz (default)</p>
<p><b>SSB TBW (NAR) H (SSB mode)</b></p> <p>These items set the transmission passband width for the narrow setting by selecting the lower and higher frequencies.</p> <p>Lower freq. : 2500 (default), 2700, 2800 and 2900 Hz</p>	<p><b>2500</b> 2500 Hz (default)</p>
<p><b>Key Speed (CW mode)</b></p> <p>This item adjusts the CW key speed. The key speed can be selected from 6 to 60 wpm.</p>	<p><b>20WPM</b> 20 WPM (default)</p>
<p><b>CW Pitch (CW mode)</b></p> <p>This item adjusts the CW receive pitch. The pitch can be selected from 300 to 900 Hz in 5 Hz steps.</p>	<p><b>600</b> 600 Hz (default)</p>

■ Quick set mode (continued)

**Side Tone Level (CW mode)**

This item adjusts the CW side tone level from 0% to 100% in 1% steps.

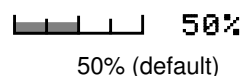

See p. 43 for details.

**Side Tone Level Limit (CW mode)**

This item allows you to set a maximum volume level for CW side tones. CW side tones are linked to the [AF] control until a specified volume level is reached — further rotation of the [AF] control will not increase the volume of the CW side tones.

**ON**

CW side tone level is limited with [AF] (default)

**OFF**

CW side tone level is linked to [AF]

**Twin Peak Filter (RTTY mode)**

This item turns the twin peak filter ON and OFF.

**ON**

Twin peak filter is ON

**OFF**

Twin peak filter is OFF. (default)

**RTTY Mark Frequency (RTTY mode)**

This item selects the RTTY mark frequency. RTTY mark frequency is switched between 1275, 1615 and 2125 Hz.

**2125**

2125 Hz RTTY mark frequency (default)

**1275**

1275 Hz RTTY mark frequency

**RTTY Shift Width (RTTY mode)**

This item adjusts the RTTY shift width. There are 3 selectable values: 170, 200 and 425 Hz.

**170**

170 Hz RTTY shift frequency (default)

**425**

425 Hz RTTY shift frequency

**RTTY Keying Polarity (RTTY mode)**

This item selects the RTTY keying polarity. Normal or reverse keying polarity can be selected.

When reverse polarity is selected, Mark and Space are reversed.

- Normal : Key open/close = Mark/Space

- Reverse : Key open/close = Space/Mark

**Normal**

Normal polarity (default)

**Reverse**

Reverse polarity

## ■ Display set mode

/// To adjust the LCD contrast or backlight, wait until the LCD becomes stable (10 min. or more after turning power ON). This is an inherent characteristic of LCDs and LCD backlights and does not indicate a transceiver malfunction.

### 1 Contrast (LCD)

This item adjusts the contrast of the LCD from 0% to 100% in 1% steps.

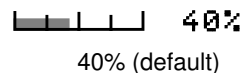

### 2 Bright (LCD)

This item adjusts the brightness of the LCD from 0% to 100% in 1% steps.

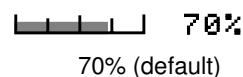

### 3 LCD Unit Bright

This item adjusts the brightness of the LCD unit from 0% to 100% in 1% steps.

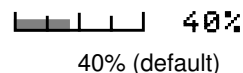

### 4 LCD Flicker

This item adjusts the flicker of the LCD from 0% to 100% in 1% steps.

/// Icom recommends using the default value. But if you find the LCD flicker objectionable, adjust this item.



### 5 Backlight(Switches)

This item adjusts the brightness of the switches from 0% to 100% in 1% steps.

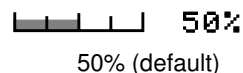

### 6 Display Type

This item sets the LCD screen type. There are 3 selectable types: A (Black-background), B (White-background), and C (Blue-background).

A  
A-type LCD screen (default)

■ *Display set mode (continued)*

**7 Display Font Type**

This item sets the font type of the frequency readouts. Basic and Italic (2 fonts) are selectable.

**Basic**

Basic font (default)

**8 Display Font Size**

This item sets the font size of the frequency readouts. Normal and large (2 sizes) are selectable.

**Normal**

Normal size (default)

**9 Meter Peak Hold**

This item turns the meter peak hold function ON and OFF. When the meter peak hold function is ON, the highest activated segment of the meter remains visible for 0.5 sec.; when OFF, the meter functions normally.

**ON**

Meter peak hold is ON (default)

**OFF**

Meter peak hold is OFF

**10 Filter PoPuP (PBT)**

This item turns the popup indication ON and OFF for the PBT function.

**ON**

Popup function is ON (default)

**OFF**

Popup function is OFF

**11 Filter PoPuP (FIL)**

This item turns the popup indication ON and OFF for the filter selection.

**ON**

Popup function is ON (default)

**OFF**

Popup function is OFF

**12 1Hz Mode PoPuP**

This item turns the popup indication ON and OFF for the 1 Hz tuning step function.

**ON**

Popup function is ON (default)

**OFF**

Popup function is OFF

**13 Scope CENTER/FIX PoPuP**

This item turns the popup indication ON and OFF for the Scope center/fix mode selection.

**ON**

Popup function is ON (default)

**OFF**

Popup function is OFF

## ■ Display set mode (continued)

<p><b>14 TV PoPuP (CH UP/Down)</b></p> <p>This item turns the popup indication ON and OFF for the TV channel Up/Down operation. TV operation is available for Japanese version only.</p>	<p><b>ON</b></p> <p>Popup function is ON (default)</p>	<p><b>OFF</b></p> <p>Popup function is OFF</p>
<p><b>15 TV PoPuP (P. AMP/ATT)</b></p> <p>This item turns the popup indication ON and OFF for the P.AMP/ATT setting on TV operation. TV operation is available for Japanese version only.</p>	<p><b>ON</b></p> <p>Popup function is ON (default)</p>	<p><b>OFF</b></p> <p>Popup function is OFF</p>
<p><b>16 Voice TX Name Display</b></p> <p>This item turns the indication of the voice TX memory channel names ON and OFF on the voice TX memory channels of the voice TX menu.</p>	<p><b>ON</b></p> <p>Voice TX memory names are indicated on the voice TX memory channels. (default)</p>	<p><b>OFF</b></p> <p>Only the voice TX memory channels are indicated.</p>
<p><b>17 Keyer Memory Display</b></p> <p>This item turns the indication of the keyer memory contents ON and OFF on the keyer memory channels of the memory keyer send menu.</p>	<p><b>ON</b></p> <p>Memory contents are indicated on the keyer memory channels. (default)</p>	<p><b>OFF</b></p> <p>Only the keyer memory channels are indicated.</p>
<p><b>18 DTMF Memory Display</b></p> <p>This item turns the indication of the DTMF code sequence ON and OFF on the DTMF memory channels of the DTMF send menu.</p>	<p><b>ON</b></p> <p>DTMF code sequence are indicated on the DTMF memory channels. (default)</p>	<p><b>OFF</b></p> <p>Only DTMF memory channels are indicated.</p>
<p><b>19 External Display</b></p> <p>This item selects the indication size for external display.</p>	<p><b>1</b></p> <p>Same indication ratio as transceiver display. (default)</p>	<p><b>2</b></p> <p>The indication width becomes narrow.</p>
<p><b>20 Opening Message</b></p> <p>This item turns the opening message screen indication capability ON and OFF.</p>	<p><b>ON</b></p> <p>Opening message is ON (default)</p>	<p><b>OFF</b></p> <p>Opening message is OFF</p>

■ Display set mode (continued)

21 My Call

Your call sign, etc. can be displayed in the opening screen when turning power ON. Up to 10 characters can be programmed.

Capital letters, numerals, some symbols (– / ·) and space can be used.

- ① Push [AF(SET)] momentarily, then [F-2 DISP] to select the display set mode.
- ② Push [F-1 ▲] or [F-2 ▼] several times to select the "My Call" item.

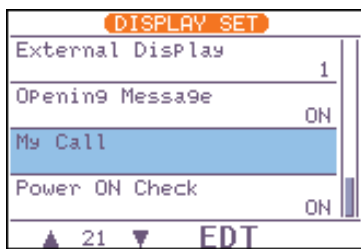

- ③ Push [F-3 EDT] to edit.
  - A cursor appears and blinks.

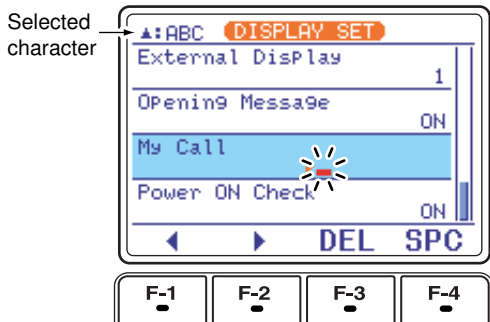

- ④ Input the desired character by rotating [DIAL] or by pushing the band key (on HM-151) for number input.
  - Push [▲(MENU/GRP)] to select the capital letters ([ABC]), numerals ([123]) or symbols ([etc]).
  - Push [F-1 ▲] or [F-2 ▼] for cursor movement.
  - Push [F-3 DEL] to delete the selected character.
  - Push [F-4 SPC] to input a space.
- ⑤ Push [▼(MENU/GRP)] to input the set name.
  - The cursor disappears.
- ⑥ Push [▼(MENU/GRP)] twice to exit the set mode screen.

• Opening screen example



22 Power ON Check

This item selects the indication ON or OFF when turning power ON.

ON : The Transceiver briefly displays 'Your Call sign,' 'RF power,' 'Auto power OFF timer' and 'RIT/ΔTX frequency' when turning power ON.
 

- No-programmed or disactivated items are skipped.

OFF : The display goes directly to frequency indication at power ON.

<p><b>ON</b></p> <p>Power ON check is ON. (default)</p>	<p><b>OFF</b></p> <p>Power ON check is OFF.</p>
-------------------------------------------------------------	-------------------------------------------------



## ■ Miscellaneous (others) set mode

### 1 Monitor

This item sets the TX monitor function ON and OFF.

The monitor gain can be set described below.

ON

TX monitor function is turned ON.

OFF

TX monitor function is turned OFF. (default)

### 2 Monitor Level

This item adjusts the transmit IF signal monitor level from 0% to 100% in 1% steps.

See p. 87 for details.

 50%  
50% (default)

### 3 Beep (Confirmation)

A beep sounds each time a switch is pushed to confirm it. This function can be turned OFF for silent operation.

The volume level can be set described below.

ON

Confirmation beep ON (default)

OFF

Confirmation beep OFF

### 4 Beep (Band Edge)

A beep sounds when an operating frequency enters or exits an amateur band. This functions independent of the confirmation beep setting (above).

The volume level can be set described below.

ON

Band edge beep ON (default)

OFF

Band edge beep OFF

### 5 Beep Level

This item adjusts the volume level for (confirmation and band edge) beep tones from 0% to 100% in 1% steps. When beep tones are turned OFF, this setting has no effect.

 50%  
50% (default)

### 6 Beep Level Limit

This item allows you to set a maximum volume level for (confirmation and band edge) beep tones. The beep tones are linked to the [AF] control until a specified volume level is reached — further rotation of the [AF] control will not increase the volume of the beep tones.

ON

Beep level is limited with [AF] (default)

OFF

Beep level is linked to [AF]

■ *Miscellaneous (others) set mode (continued)*

**7 RF/SQL Control**

The **[RF/SQL]** control can be set as the RF/squelch control (default), the squelch control only (RF gain is fixed at maximum) or 'Auto' (RF gain control in SSB, CW and RTTY; squelch control in AM and FM).

See pgs. 1, 35 for details.

<b>RF+SQL</b>	<b>[RF/SQL]</b> control as RF/squelch control
<b>SQL</b>	<b>[RF/SQL]</b> control as squelch control
<b>AUTO</b>	<b>[RF/SQL]</b> control as RF gain control in SSB, CW and RTTY; squelch control in AM and FM (default)

**8 Quick SPLIT**

When this item is set to ON, pushing and holding **[F-1 SPL] (M-1)** for 1 sec. sets the undisplayed VFO frequency to the displayed VFO frequency plus the split offset and activates split operation.

See p. 90 for details.

<b>ON</b>	<b>OFF</b>
Quick split ON (default)	Quick split OFF

**9 SPLIT Offset**

This item sets the offset (difference between transmit and receive frequencies) for the quick split function.

The offset frequency can be set from -9.999 MHz to +9.999 MHz in 1 kHz steps.

<b>0.000MHz</b>	<b>-9.999MHz</b>
0.000 MHz offset (default)	Minus 9.999 MHz offset

**10 SPLIT LOCK**

When this item is ON, **[DIAL]** can be used to adjust the transmit frequency while pushing and holding **[XFC]** even while the lock function is activated.

See p. 89 for split frequency operation details.

<b>ON</b>	<b>OFF</b>
Split lock function ON	Split lock function OFF (default)

**11 DUP Offset HF**

This item sets the offset (difference between transmit and receive frequencies) for duplex operation. However, this setting is used to input the repeater offset for an HF band only.

The offset frequency can be set from 0.000 MHz to +9.999 MHz in 1 kHz steps.

<b>0.100MHz</b>
0.1 MHz offset (default)

**12 DUP Offset 50M**

This item sets the offset (difference between transmit and receive frequencies) for duplex operation. However, this setting is used to input the repeater offset for the 50 MHz band only.

The offset frequency can be set from 0.000 MHz to +9.999 MHz in 1 kHz steps.

<b>0.500MHz</b>
0.5 MHz offset (default)

■ *Miscellaneous (others) set mode (continued)*

**13 DUP Offset 144M**

This item sets the offset (difference between transmit and receive frequencies) for duplex operation. However, this setting is used to input the repeater offset for an 144 MHz band only.

**0.600MHz**

0.6 MHz offset (default)

The offset frequency can be set from 0.000 MHz to +9.999 MHz in 1 kHz steps.

**14 DUP Offset 430M**

This item sets the offset (difference between transmit and receive frequencies) for duplex operation. However, this setting is used to input the repeater offset for the 430 MHz band. only

**5.000MHz**

5 MHz offset (default)

The offset frequency can be set from 0.000 MHz to +9.999 MHz in 1 kHz steps.

**15 One Touch Repeater**

This item turns the one touch repeater function ON (DUP-, DUP+) and OFF.

**DUP-**

Minus offset direction is selected. (default)

**OFF**

One touch repeater function is OFF.

When [F-2 DUP] (M-3) is pushed and held for 1 sec., the selected offset direction and programmed duplex offset frequency (depending on the operating frequency band) is set with the displayed frequency.

**16 Auto Repeater**

This item turns the auto repeater function ON-1 (auto duplex setting), ON-2 (auto duplex setting and activating tone encoder) or OFF.

**ON-1**

Auto duplex setting is ON. (default)

**OFF**

Auto repeater function is OFF.

See p. 65 for details concerning the auto repeater function.

**17 Tuner (Auto Start)**

The optional AT-180 ANTENNA TUNER has an automatic start capability which starts tuning if the SWR is higher than 1.5–3:1.

**ON**

Automatic tune function is ON.

**OFF**

Automatic tune function is OFF. (default)

When “OFF” is selected, the tuner remains OFF even when the SWR is poor (1.5–3:1). When “ON” is selected, automatic tune starts even when the tuner is turned OFF.

/// Even when “ON” is selected, automatic tune does not start for the 50 MHz band.

■ Miscellaneous (others) set mode (continued)

18 Tuner (PTT Start)

When an optional AH-4 ANTENNA TUNER is connected, tuning can be started automatically at the moment the PTT is pushed.  
This function activates for HF band only.

- |           |                                                      |            |                                                      |
|-----------|------------------------------------------------------|------------|------------------------------------------------------|
| <b>ON</b> | Tuning starts when pushing [PTT] on a new frequency. | <b>OFF</b> | Tuning starts only when [TUNER] is pushed. (default) |
|-----------|------------------------------------------------------|------------|------------------------------------------------------|

19 [TUNER] Switch

When an optional AT-180 ANTENNA TUNER is connected, the transceiver retains the [TUNER/CALL] key ON/OFF condition for each band, "Auto," or all band, "Manual."

- |               |                                                                        |
|---------------|------------------------------------------------------------------------|
| <b>Auto</b>   | [TUNER/CALL] key ON/OFF condition is retained for each band. (default) |
| <b>Manual</b> | [TUNER/CALL] key ON/OFF condition is retained for all band.            |

20 VSEND Select

This item select the [ACC] (pin 7) output.

- |                 |                                                                     |
|-----------------|---------------------------------------------------------------------|
| <b>ON</b>       | VSEND is for the 144/430 MHz; HSEND is for the HF/50 MHz. (default) |
| <b>UHF Only</b> | VSEND is for the 430 MHz; HSEND is for the HF/50/144 MHz.           |
| <b>OFF</b>      | VSEND is not used; HSEND is for all bands.                          |

21 SPEECH Level

This item adjusts the volume level for speech function from 0% to 100% in 1% steps.

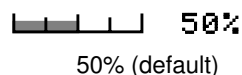

22 SPEECH Language

This item selects language for the speech function.  
You can select between English and Japanese as the SPEECH language.

- |                |                                |                 |                       |
|----------------|--------------------------------|-----------------|-----------------------|
| <b>English</b> | English announcement (default) | <b>JaPANEse</b> | Japanese announcement |
|----------------|--------------------------------|-----------------|-----------------------|

23 SPEECH Speed

This item selects the speech speed between faster or slower synthesizer output.

- |             |                               |            |                     |
|-------------|-------------------------------|------------|---------------------|
| <b>HIGH</b> | Faster announcement (default) | <b>LOW</b> | Slower announcement |
|-------------|-------------------------------|------------|---------------------|

■ *Miscellaneous (others) set mode (continued)*

<p><b>24 SPEECH S-Level</b></p>	<p>You can have frequency, mode and signal level announcement. Signal level announcement can be deactivated if desired.</p>	<p><b>ON</b> Signal level announcement (default)</p>	<p><b>OFF</b> No signal level announcement</p>
<p>When "OFF" is selected, the signal level is not announced.</p>			
<p><b>25 SPEECH [MODE] Switch</b></p>	<p>This item selects the operating mode speech capability when [MODE] is pushed.</p>	<p><b>ON</b> Operating model announcement with [MODE]</p>	<p><b>OFF</b> No operating mode announcement with [MODE] (default)</p>
<p>When "ON" is selected, the selected operating mode is announced at pushing [MODE].</p>			
<p><b>26 MemoPad Numbers</b></p>	<p>This item sets the number of memo pad channels available. 5 or 10 memo pads can be set.</p>	<p><b>5</b> 5 memo pads (default)</p>	<p><b>10</b> 10 memo pads</p>
<p><b>27 SCAN Speed</b></p>	<p>This item sets the rate at which channels or frequencies are scanned during scan operations. High and low can be selected.</p>	<p><b>HIGH</b> Scan is faster. (default)</p>	<p><b>LOW</b> Scan is slower.</p>
<p><b>28 SCAN Resume</b></p>	<p>This item sets the scan resume function ON and OFF.</p>	<p><b>ON</b> Scan resumes 10 sec. after stopping on a signal (or 2 sec. after a signal disappear). (default)</p>	<p><b>OFF</b> Scan does not resume after stopping on a signal. For the priority watch, setting to OFF pauses the watch until the signal disappears and scan resumes.</p>
<p><b>29 MAIN DIAL Auto TS</b></p>	<p>This item sets the auto tuning step function. When rotating [DIAL] rapidly, the tuning step rate adapts as selected.</p>	<p><b>HIGH</b> Auto tuning step is turned ON. Fastest tuning step during rapid rotation (default)</p>	<p><b>LOW</b> Auto tuning step is turned ON. Faster tuning step during rapid rotation</p>
<p>There are 2 type of auto tuning steps: HIGH (Fastest) and LOW (Faster).</p>			
<p><b>OFF</b> Auto tuning step is turned OFF.</p>			

■ Miscellaneous (others) set mode (continued)

30 HM-151 [F-1]

This item programs one of several functions to [F-1] key of HM-151. Programmable key assignments are described as below.

**MPW**

Memo pad write is programmed. (default)

**ANF**

Auto notch filter is programmed.

“P.AMP/ATT” (Pre-amplifier/attenuator),  
 “NB” (Noise blanker),  
 “NR” (Noise reduction),  
 “MNF” (Manual notch filter),  
 “ANF” (Auto notch filter),  
 “TS” (Tuning step),  
 “SPL” (Split operation),  
 “A/B” (VCO A/B selection),  
 “MCL” (Memory clear),  
 “BNK” (Bank selection),  
 “COM” (Speech compressor),

“AGC” (AGC selection),  
 “TBW” (TX filter width),  
 “DUP” (Duplexer),  
 “TON” (FM tone operation),  
 “MET” (Meter selection),  
 “VSC” (Voice squelch control),  
 “MPW” (Memo pad write),  
 “MPR” (Memo pad read),  
 “<SCOPE>” (Scope selection),  
 “<METER>” (Multi-meter selection)

31 HM-151 [F-2]

This item programs one of several functions to [F-2] key of HM-151. Programmable key assignments are same as above.

**MPR**

Memo pad read is programmed. (default)

**NB**

Noise blanker function is programmed.

32 MIC UP/Down Speed

This item sets the rate at which frequencies are scanned when the microphone (HM-151) [▲]/[▼] keys are pushed and held. High or low can be selected.

**HIGH**

High speed (default, 5 tuning steps/sec.)

**LOW**

Low speed (2.5 tuning steps/sec.)

33 Quick RIT/ΔTX Clear

This item selects the RIT/ΔTX frequency clearing instruction for the [F-3 CLR] key.

See pgs. 73, 86 for details.

**ON**

Clears the RIT/ΔTX frequency when [F-3 CLR] is pushed momentarily.

**OFF**

Clears the RIT/ΔTX frequency when [F-3 CLR] is pushed and held for 1 sec. (default)

34 SSB/CW Synchronous Tuning

This item selects the displayed frequency shift function from ON and OFF.

When this function is activated, the received signal will remain the same even when the operating mode is changed between SSB and CW.

▨ The frequency shifting value may differ according to the CW pitch setting.

**ON**

The displayed frequency shifts when the operating mode is changed between SSB and CW.

**OFF**

The displayed frequency does not shift. (default)

### ■ Miscellaneous (others) set mode (continued)

<p><b>35 CW Normal Side</b></p> <p>Selects the carrier point of CW mode from LSB and USB.</p>	<p><b>LSB</b></p> <p>The carrier point is set to LSB side. (default)</p>	<p><b>USB</b></p> <p>The carrier point is set to USB side.</p>
<p><b>36 VOICE 1st Menu</b></p> <p>This item selects the initial menu when [F-1 VO] (S-1) is pushed, from "VOICE-RX/TX" or "VOICE-Root."</p>	<p><b>VOICE-RX/TX</b></p> <p>Voice RX/TX menu is selected. (default)</p>	<p><b>VOICE-Root</b></p> <p>Voice root menu is selected.</p>
<p><b>37 KEYER 1st Menu</b></p> <p>This item selects the initial menu when [F-2 KEY] (S-1) is pushed, from "KEYER-SEND" or "KEYER-Root."</p>	<p><b>KEYER-SEND</b></p> <p>Keyer send menu is selected. (default)</p>	<p><b>KEYER-Root</b></p> <p>Keyer root menu is selected.</p>
<p><b>38 DTMF 1st Menu</b></p> <p>This item selects the initial menu when [F-2 DTM] (S-1) is pushed, from "DTMF-SEND" or "DTMF-Root."</p>	<p><b>DTMF-SEND</b></p> <p>DTMF send menu is selected. (default)</p>	<p><b>DTMF-Root</b></p> <p>DTMF root menu is selected.</p>
<p><b>39 Mode Select (SSB)</b></p> <p>This item inhibits the selection of SSB (LSB/USB) modes, and allows you to simplify operation during normal operation.</p> <p>For example if you are operating mobile and only plan on using FM and AM modes, sets all other modes (SSB, CW, RTTY, WFM) to OFF, thereby making selection of AM or FM quick and easy.</p>	<p><b>ON</b></p> <p>SSB modes are selectable. (default)</p>	<p><b>OFF</b></p> <p>SSB modes are inhibited.</p>
<p><b>40 Mode Select (CW)</b></p> <p>This item inhibits the selection of CW/CW-R modes, and allows you to simplify operation during normal operation.</p>	<p><b>ON</b></p> <p>CW modes are selectable. (default)</p>	<p><b>OFF</b></p> <p>CW modes are inhibited.</p>
<p><b>41 Mode Select (RTTY)</b></p> <p>This item inhibits the selection of RTTY/RTTY-R modes, and allows you to simplify operation during normal operation.</p>	<p><b>ON</b></p> <p>RTTY modes are selectable. (default)</p>	<p><b>OFF</b></p> <p>RTTY modes are inhibited.</p>

■ Miscellaneous (others) set mode (continued)

**42 Mode Select (AM)**

This item inhibits the selection of AM mode, and allows you to simplify operation during normal operation.

**ON**

AM mode is selectable.  
(default)

**OFF**

AM mode is inhibited.

**43 Mode Select (FM)**

This item inhibits the selection of FM mode, and allows you to simplify operation during normal operation.

**ON**

FM mode is selectable.  
(default)

**OFF**

FM mode is inhibited.

**44 Mode Select (WFM)**

This item inhibits the selection of WFM mode, and allows you to simplify operation during normal operation.

**ON**

WFM mode is selectable.  
(default)

**OFF**

WFM mode is inhibited.

**45 External Keypad (VOICE)**

This item sets the external keypad capability and function.

**For your information**

The following diagram shows the equivalent circuit of an external keypad and connects to the pin 2 and pin 7 of the [MIC] connector (p. 10).

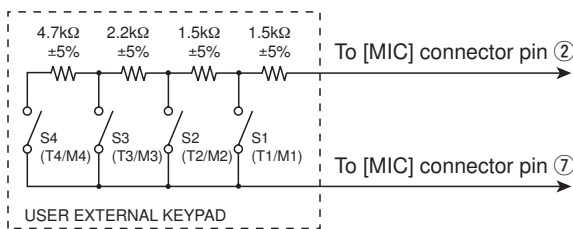

**ON** : Pushing one of external keypad switches, transmits the desired voice memory contents (during a phone mode (SSB, AM, FM) operation).

**OFF** : External keypad does not function.  
(default)

/// If you want to transmit a message using the external keypad described at left, you must set “47 Front Keypad Type” (p. 136) to “Ext Keypad,” and record the desired message in transmit voice memory channels T1–T4 in advance (p.96).

**46 External Keypad (KEYER)**

This item sets the external keypad capability and function.

**User external keypad is same as above.**

**ON** : Pushing one of external keypad switches, transmits the desired memory keyer contents during CW mode operation.

**OFF** : External keypad does not function. (default)

/// If you want to transmit a memory keyer contents using the external keypad described above, you must set “47 Front Keypad Type” (p. 136) to “Ext Keypad.”



■ *Miscellaneous (others) set mode (continued)*

<b>47 Front Keypad Type</b>		
This item selects the keypad type that connected to the <b>[MIC]</b> connector.	<b>Dot/Dash</b>	<b>Ext Keypad</b>
	Dot/Dash (default)	External keypad

<b>48 CI-U Baud Rate</b>		
This item sets the data transfer rate. 300, 1200, 4800, 9600, 19200 bps and "Auto" are available.  When "Auto" is selected, the baud rate is automatically set according to the connected controller or remote controller.	<b>Auto</b>	<b>19200</b>
	Auto baud rate (default)	19200 bps

<b>49 CI-U Address</b>		
To distinguish equipment, each CI-V transceiver has its own Icom standard address in hexadecimal code. The IC-7000's address is 70h.  When 2 or more IC-7000's are connected to an optional CT-17 CI-V LEVEL CONVERTER, rotate <b>[DIAL]</b> to select a different address for each IC-7000 in the range 01h to 7Fh.	<b>70h</b>	<b>7Fh</b>
	Address of 70h (default)	Address of 7Fh

<b>50 CI-U Transceive</b>		
Transceive operation is possible with the IC-7000 connected to other Icom HF transceivers or receivers.  When "ON" is selected, changing the frequency, operating mode, etc. on the IC-7000 automatically changes those of connected transceivers (or receivers) and vice versa.	<b>ON</b>	<b>OFF</b>
	Transceive ON (default)	Transceive OFF

<b>51 REF Adjust</b>		
This item adjusts the internal reference frequency within 0 to 100% range in 1 % steps.		

## ■ Fuse replacement

If a fuse blows or the transceiver stops functioning, try to find the source of the problem, and replace the damaged fuse with a new, adequately rated fuse.

**CAUTION:** Disconnect the DC power cable from the transceiver when changing a fuse.

- The IC-7000 has three fuses (DC power cable fuses × 2, circuitry fuse × 1) installed for transceiver protection.
- DC power cable fuses ..... ATC20 30 A
  - Circuitry fuse ..... ATC20 5 A

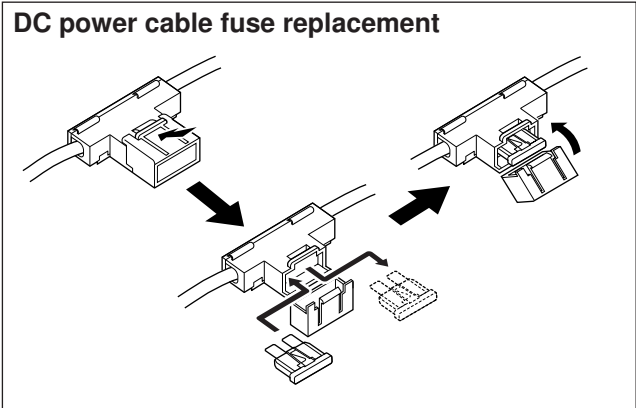

### CIRCUITRY FUSE REPLACEMENT

The 13.8 V DC from the DC power cable is applied to all units in the IC-7000, except for the power amplifier, through the circuitry fuse. This fuse is installed in the FRONT unit.

**WARNING:** NEVER attempt to remove fuse cover using your finger nails, this may result in injury.

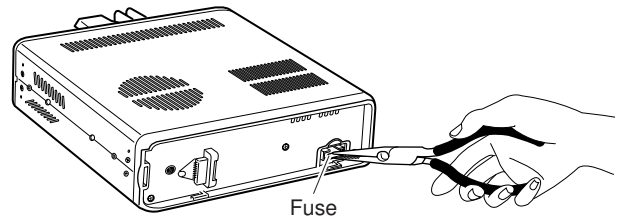
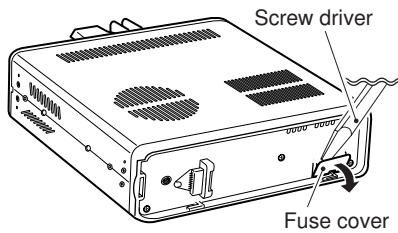

## ■ Memory backup

All of the CPU's memory is backed up by an EEPROM (Electrically-Erasable Programmable Read-Only Memory). All data you set, such as VFO, memory, set mode contents, etc. are stored in this EEPROM. There is no internal lithium battery.

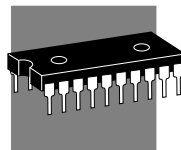

## ■ Cleaning



If the transceiver becomes dusty or dirty, wipe it clean with a dry, soft cloth.



**AVOID** the use of strong chemical solvents such as thinner, benzene or alcohol to clean the transceiver. These may damage the transceiver's surfaces.

The following chart is designed to help you correct problems which are not equipment malfunctions.

If you are unable to locate the cause of a problem or solve it through the use of this chart, contact your nearest Icom Dealer or Service Center.

	PROBLEM	POSSIBLE CAUSE	SOLUTION	REF.
<b>POWER SUPPLY</b>	Power does not come on when [PWR] key is pushed.	<ul style="list-style-type: none"> <li>• DC power cable is improperly connected.</li> <li>• Fuse is blown.</li> <li>• Battery is exhausted if you are using a 12 V battery as the power source.</li> </ul>	<ul style="list-style-type: none"> <li>• Reconnect the power cable correctly.</li> <li>• Check for the cause, then replace the fuse with a spare one. (Fuses are installed in two places. One is installed in the DC power cable and the other is installed in the FRONT unit.)</li> <li>• Check the battery voltage.</li> </ul>	<p>p. 19</p> <p>p. 137</p> <p>—</p>
	No sound comes from the speaker.	<ul style="list-style-type: none"> <li>• Volume level is set too low.</li> <li>• The squelch is closed.</li> <li>• The transceiver is in transmit mode.</li> <li>• An external speaker or headphones are connected.</li> </ul>	<ul style="list-style-type: none"> <li>• Rotate [AF] clockwise to obtain a suitable listening level.</li> <li>• Rotate [SQL] counterclockwise to open the squelch.</li> <li>• Release [PTT] on the microphone or check the SEND line of an external unit, if connected.</li> <li>• Check the external speaker or headphone plug connection.</li> </ul>	<p>pgs. 1, 25, 33</p> <p>pgs. 1, 25, 35</p> <p>—</p> <p>p. 18</p>
<b>RECEIVE</b>	Sensitivity is low.	<ul style="list-style-type: none"> <li>• The antenna is not connected properly.</li> <li>• The antenna feed line is cut or shorted.</li> <li>• The antenna is not properly tuned.</li> <li>• The attenuator function is activated.</li> </ul>	<ul style="list-style-type: none"> <li>• Reconnect to the antenna connector.</li> <li>• Check the feed line and correct any improper conditions.</li> <li>• Push [TUNER/CALL] to manually tune the antenna.</li> <li>• Push [P.AMP/ATT] to turn the function OFF.</li> </ul>	<p>—</p> <p>—</p> <p>pgs. 114, 115</p> <p>p. 72</p>
	Receive audio is distorted.	<ul style="list-style-type: none"> <li>• The operating mode is not selected correctly.</li> <li>• The PBT function is activated.</li> </ul>	<ul style="list-style-type: none"> <li>• Select a suitable operating mode.</li> <li>• Push [PBT/M-ch/RIT(CLR)] for 1 sec. to clear the PBT function.</li> </ul>	<p>p. 34</p> <p>p. 77</p>
	Receive signal is distorted by strong signals.	<ul style="list-style-type: none"> <li>• Noise blanker function is activated.</li> <li>• Preamp is activated.</li> </ul>	<ul style="list-style-type: none"> <li>• Push [NB/ADJ] to turn the function OFF.</li> <li>• Push [P.AMP/ATT] to turn the function OFF.</li> </ul>	<p>p. 78</p> <p>p. 72</p>

	PROBLEM	POSSIBLE CAUSE	SOLUTION	REF.
TRANSMIT	Transmitting is impossible.	<ul style="list-style-type: none"> <li>The operating frequency is not set to a ham band.</li> </ul>	<ul style="list-style-type: none"> <li>Set the frequency to a ham band.</li> </ul>	p. 29
	Output power is too low.	<ul style="list-style-type: none"> <li>Power is set to a lower power than maximum.</li> <li>Microphone gain is set too low.</li> </ul>	<ul style="list-style-type: none"> <li>Set the output power in quick set mode.</li> <li>Set microphone gain to a suitable position using quick set mode.</li> </ul>	p. 38 p. 38
		<ul style="list-style-type: none"> <li>The antenna is not connected properly.</li> <li>The antenna feed line is cut or shorted.</li> </ul>	<ul style="list-style-type: none"> <li>Reconnect the antenna connector.</li> <li>Check the feed line and correct any improper conditions.</li> </ul>	— —
		<ul style="list-style-type: none"> <li>The antenna is not properly tuned.</li> </ul>	<ul style="list-style-type: none"> <li>Push [TUNER/CALL] to manually tune the antenna.</li> </ul>	pgs. 114, 115
		No contact possible with other stations.	<ul style="list-style-type: none"> <li>RIT function is activated.</li> <li>Split function is activated.</li> </ul>	<ul style="list-style-type: none"> <li>Push [F-1 RIT] in the RIT/ΔTX mode to turn the function OFF.</li> <li>Push [F-1 SPL] in the M-1 menu to turn the function OFF.</li> </ul>
Repeater cannot be accessed.	<ul style="list-style-type: none"> <li>Split function is not activated.</li> <li>An incorrect transmit frequency is set.</li> </ul>	<ul style="list-style-type: none"> <li>Push [F-1 SPL] in the M-1 menu to turn the function ON.</li> <li>Set the proper frequencies into VFO A and B or into one of the memory channels.</li> </ul>	p. 89 pgs. 27, 29	
	<ul style="list-style-type: none"> <li>Subaudible tone encoder is OFF and repeater requires a tone for access.</li> <li>Programmed subaudible tone frequency is wrong.</li> </ul>	<ul style="list-style-type: none"> <li>Use [F-3 TON] in the M-3 menu to select FM-TONE.</li> <li>Program the required frequency using FM tone set mode.</li> </ul>	p. 63 p. 64	
	Transmitted signals are distorted.	<ul style="list-style-type: none"> <li>Microphone gain is set too high.</li> <li>The compression level is set too high with the speech compressor ON.</li> </ul>	<ul style="list-style-type: none"> <li>Set MIC gain in quick set mode.</li> <li>Set compression level to a suitable position.</li> </ul>	p. 38 p. 88
DISPLAY	Displayed frequency does not change properly.	<ul style="list-style-type: none"> <li>The dial lock function is activated.</li> </ul>	<ul style="list-style-type: none"> <li>Push [SPCH/LOCK] to deactivate the function.</li> </ul>	p. 37
		<ul style="list-style-type: none"> <li>The internal CPU has malfunctioned.</li> </ul>	<ul style="list-style-type: none"> <li>Reset the CPU. (While pushing [▲(BAND)] and [▼(BAND)]], push [PWR] to turn power ON.</li> </ul>	p. 25
SCAN	Programmed scan does not stop.	<ul style="list-style-type: none"> <li>Squelch is open.</li> </ul>	<ul style="list-style-type: none"> <li>Set squelch to the threshold position.</li> </ul>	p. 35
	Programmed scan does not start.	<ul style="list-style-type: none"> <li>The same frequencies have been programmed in scan edge memory channels.</li> </ul>	<ul style="list-style-type: none"> <li>Program different frequencies into scan edge memory channels.</li> </ul>	p. 101
	Memory scan does not start.	<ul style="list-style-type: none"> <li>2 or more memory channels have not been programmed.</li> </ul>	<ul style="list-style-type: none"> <li>Program 2 or more memory channels.</li> </ul>	p. 101
	Memory select scan does not start.	<ul style="list-style-type: none"> <li>2 or more memory channels have not been designated as select channels.</li> </ul>	<ul style="list-style-type: none"> <li>Designate 2 or more memory channels as select channels for the scan.</li> </ul>	p. 104

## ■ MB-106 CARRYING HANDLE

The optional MB-106 CARRYING HANDLE is convenient when carrying the transceiver for DX' peditions, field operation, etc.

① Attach the rubber feet with the supplied screws as shown below.

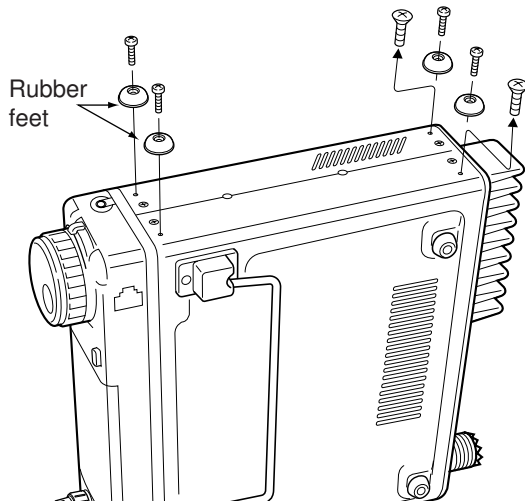

② Attach the MB-106 to the left side of the transceiver as shown below.

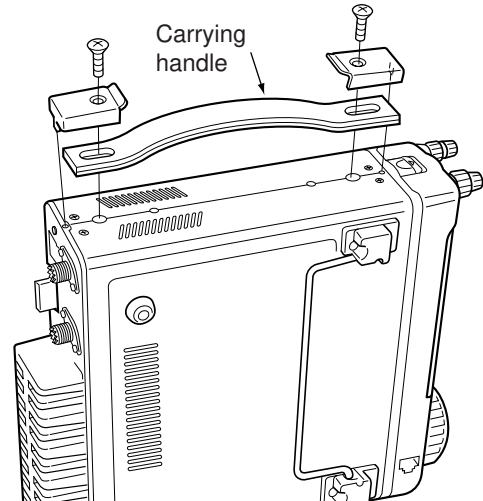

## ■ Band voltage modification

If you want to connect an external unit which can be controlled by the band voltage from [ACC] connector, the following modification is necessary. The band voltage appears on pin 5 of [ACC] connector after modification is completed.

Performing this modification is the customer's responsibility. Icom does not guarantee this modification's result.

**CAUTION:** Disconnect the DC power cable from the transceiver before any work on the transceiver.

IC-7000's top view with DDS unit top panel is opened

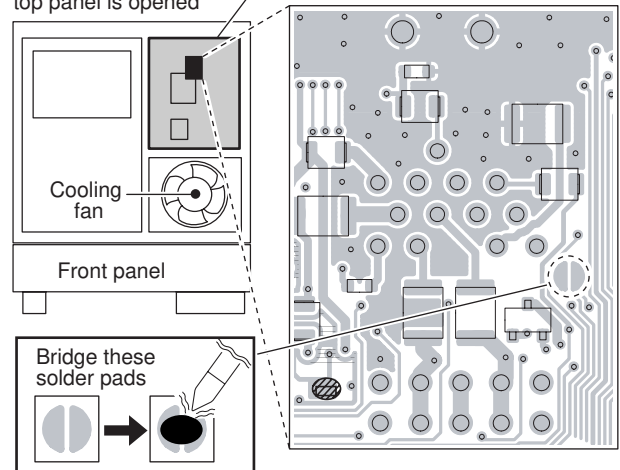

### • Band voltage generator circuit

The below circuit is just for reference.

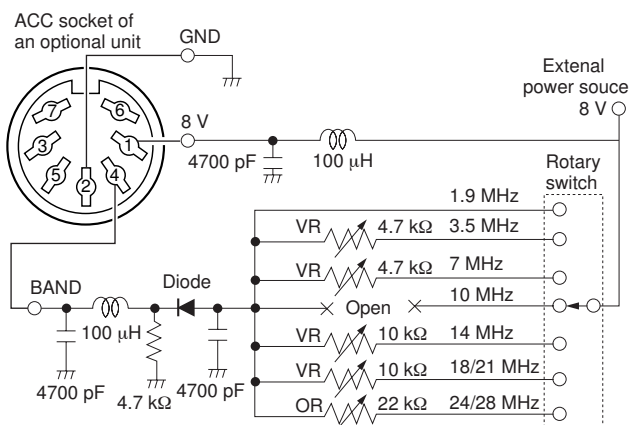

The following band voltage table is for reference only. Please adjust and confirm against the actual operating condition.

BAND	VOLTAGE
1.9 MHz	—
3.5 MHz	6.1 V
7 MHz	5.1 V
10 MHz	—
14 MHz	4.1 V
18/21 MHz	3.1 V
24/28 MHz	2.1 V

## ■ AT-180 internal switch description

The optional AT-180 has 3 operating configurations for HF band operation. Select a suitable configuration according to your antenna system.

- ① Remove the top cover of the AT-180.
- ② Set the tuner switches to the desired positions according to the table below.

### • AT-180 inside top cover

SW	Position	Operation
S1	A (default)	The tuner operating condition is set by S2 described below.
	B	<b>THROUGH INHIBIT</b> The tuner tunes the antenna even when the antenna has poor SWR (up to VSWR 3:1 after tuning). In this case, manual tuning is necessary each time you change the frequency although the tuner automatically starts tuning when the VSWR is higher than 3:1. This setting is called "through inhibit," however, the tuner is set to "through" if the VSWR is higher than 3:1 after tuning.
S2	C	<b>TUNER SENSITIVE CONDITION</b> The tuner tunes each time you transmit (except SSB mode). Therefore, the lowest SWR is obtained at any given time. For SSB mode, the same condition as the "D" position.
	D (default)	<b>NORMAL CONDITION</b> The tuner tunes when the SWR is higher than 1.5:1. Therefore, the tuner activates only when tuning is necessary.

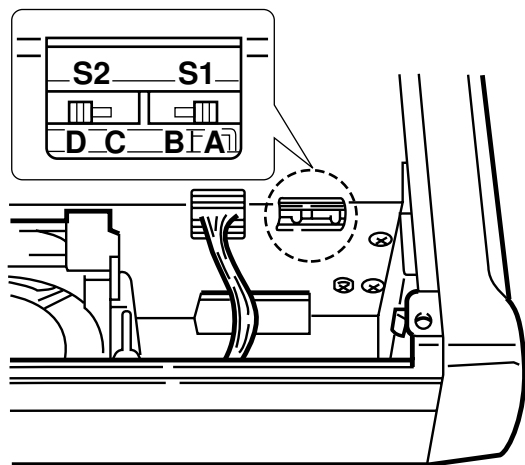

### • Specifications for the AT-180

- Frequency coverage : 1.9–54 MHz
- Input impedance : 50 Ω
- Maximum input power : 120 W
- Minimum tuning power : 8 W
- Matching impedance : 16.7–150 Ω (HF band)  
range : 20–125 Ω (50 MHz band)
- Tuning accuracy : Less than SWR 1.5:1
- Insertion loss : Less than 1.0 dB (after tuning)
- Power supply requirements : 13.8 V DC/1 A (supplied from the transceiver's ACC socket)
- Dimensions (mm/in) : 167(W) × 58.6(H) × 225(D)  
6<sup>9</sup>/<sub>16</sub>(W) × 2<sup>5</sup>/<sub>17</sub>(H) × 8<sup>7</sup>/<sub>8</sub>(D)
- Weight : 2.4 kg; 5 lb 4 oz
- Supplied accessories : Coaxial cable (1 m), ACC cable (DIN 13 pins)

### • Connector information for ACC(2) socket



PIN NO./NAME	DESCRIPTION
① 8 V	Regulated 8 V output. (10 mA max.)
② GND	Connects to ground.
③ SEND	Input/output pin. Goes to ground when transmitting (20 mA max). When grounded, transmits.
④ BAND	Band voltage output. (Varies with amateur band; 0 to 8.0 V).
⑤ ALC	ALC output voltage (–4 to 0 V).
⑥ NC	No connection.
⑦ 13.8V	13.8 V output when power is ON (1 A max).

## Remote jack (CI-V) information

### ◇ CI-V connection example

The transceiver can be connected through an optional CT-17 CI-V LEVEL CONVERTER to a personal computer equipped with an RS-232C port. The Icom Communication interface-V (CI-V) controls the following functions of the transceiver.

Up to four Icom CI-V transceivers or receivers can be connected to a personal computer equipped with an RS-232C port. See p. 136 for setting the CI-V condition using the miscellaneous (others) set mode.

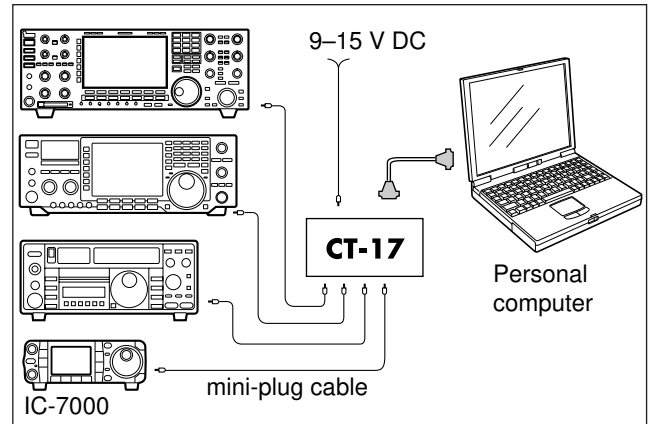

### ◇ Data format

The CI-V system can be operated using the following data formats. Data formats differ according to command numbers. A data area is added for some commands.

#### CONTROLLER TO IC-7000

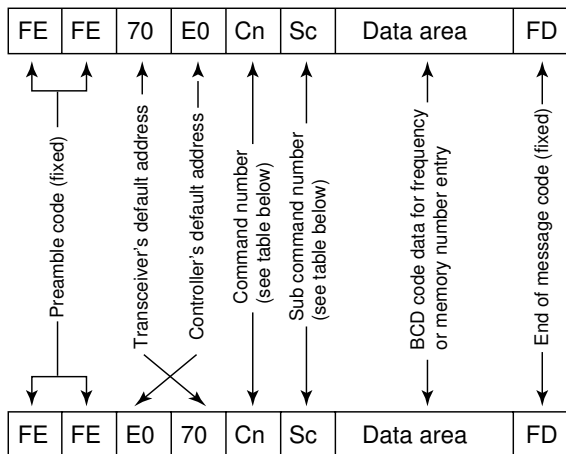

#### IC-7000 TO CONTROLLER

#### OK MESSAGE TO CONTROLLER

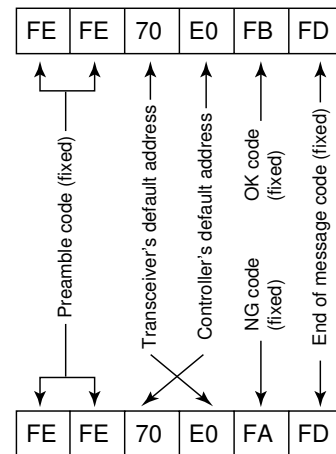

#### NG MESSAGE TO CONTROLLER

### ◇ Command table

Command	Sub command	Description
00	—	Send frequency data
01	Same as command 06	Send mode data
02	—	Read band edge frequencies
03	—	Read operating frequency
04	—	Read operating mode
05	—	Set operating frequency
06	00	Select LSB
	01	Select USB
	02	Select AM
	03	Select CW
	04	Select RTTY
	05	Select FM
	07	Select CW-R
	08	Select RTTY-R
07	—	Select VFO mode
	00	Select VFO A
	01	Select VFO B
	A0	Equalize VFO A and VFO B

Command	Sub command	Description
07	B0	Exchange VFO A and VFO B
08	—	Select memory mode
	0001–0105*	Select memory channel *P1=0100, P2=0101
	0106, 0107	Select the call channel (C1=0106, C2=0107)
	A0	Set the bank number (1=A, 2=B, 3=C, 4=D, 5=E)
09	—	Memory write
0A	—	Memory to VFO
0B	—	Memory clear
0C	—	Read offset frequency
0D	—	Set offset frequency
0E	00	Scan stop
	01	Programmed/memory scan start
	02	Programmed scan start
	22	Memory scan start
	23	Select memory scan start

## •Command table (continued)

Command	Sub command	Description
0E	B0	Set as non-select channel
	B1	Set as select channel
	D0	Set scan resume OFF
	D3	Set scan resume ON
0F	00	Turn the split function OFF
	01	Turn the split function ON
	10	Select simplex operation
	11	Select -DUP operation
	12	Select +DUP operation
10	00	AM/FM/WFM modes: Select 10 Hz tuning step SSB/CW/RTTY modes: TS OFF
	01	Select 100 Hz tuning step
	02	Select 1 kHz tuning step
	03	Select 5 kHz tuning step
	04	Select 9 kHz tuning step
	05	Select 10 kHz tuning step
	06	Select 12.5 kHz tuning step
	07	Select 20 kHz tuning step
	08	Select 25 kHz tuning step
	09	Select 100 kHz tuning step
	10	AM/FM/WFM modes: Select MHz step SSB/CW/RTTY modes: Invalid
11	—	Select/read attenuator (0=OFF, 12=ON (12 dB))
13	00	Announce with voice synthesizer (00=all data; 01=frequency and S-meter level; 02=receive mode)
	01	
	02	
14	01 + Level data	[AF] level setting (0=max. CCW to 255=max. CW)
	02 + Level data	[RF] level setting (0=max. CCW to 255=11 o'clock)
	03 + Level data	[SQL] level setting (0=11 o'clock to 255=max. CW)
	06 + Level data	NR level setting (0=min. to 255=max.)
	07 + Level data	Inside [PBT] setting or IF shift setting (0=max. CCW, 128=center, 255=max. CW)
	08 + Level data	Outside [PBT] setting (0=max. CCW, 128=center, 255=max. CW)
	09 + Level data	CW Pitch setting (0=300 Hz, 128=600 Hz, 255=900 Hz, in 5 Hz steps)
	0A + Level data	RF Power setting (0=mini. to 255=max.)
	0B + Level data	MIC Gain setting (0=mini. to 255=max.)
	0C + Level data	Key Speed setting (0=slow to 255=fast)
	0D + Level data	NOTCH (NF1) frequency setting (0=low freq. to 255=high freq.)
	0E + Level data	COMP Level setting (0=0 to 10=10)
	0F + Level data	Break-IN DELAY setting (20=2.0d to 130=13.0d)
	12 + Level data	NB level setting (0=0 to 255=100%)
15 + Level data	Monitor gain setting (0=0 to 255=100%)	
16 + Level data	VOX gain setting (0=0 to 255=100%)	

Command	Sub command	Description
14	17 + Level data	Anti-VOX gain setting (0=0 to 255=100%)
	18 + Level data	Contrast (LCD) setting (0=0 to 255=100%)
	19 + Level data	Bright (LCD) setting (0=0 to 255=100%)
	1A + Level data	NOTCH (NF2) frequency setting (0=low freq. to 255=high freq.)
15	01	Read squelch condition
	02	Read S-meter level
	11	Read RF power meter
	12	Read SWR meter
	13	Read ALC meter
	14	Read COMP meter
16	02	Preamplifier (0=OFF; 1=ON)
	12	AGC selection (1=Fast; 2=Mid; 3=Slow)
	22	Noise blanker (0=OFF; 1=ON)
	40	Noise reduction (0=OFF; 1=ON)
	41	Auto notch (0=OFF; 1=ON)
	42	Repeater tone (0=OFF; 1=ON)
	43	Tone squelch (0=OFF; 1=ON)
	44	Speech compressor (0=OFF; 1=ON)
	45	Monitor (0=OFF; 1=ON)
	46	VOX function (0=OFF; 1=ON)
	47	Break-in (0=OFF; 1=semi break-in; 2=full break-in)
	48	Manual notch (NF1) (0=OFF; 1=ON)
	4B	DTCS (0=OFF; 1=ON)
	4C	VSC (0=OFF; 1=ON)
4F	Twin Peak Filter (0=OFF; 1=ON)	
50	Dial lock function (0=OFF; 1=ON)	
51	Manual notch (NF2) (0=OFF; 1=ON)	
19	00	Read the transceiver ID
1A	00	Send/read memory contents (see p. 146 for details)
	01	Send/read band stacking register contents (see p. 146 for details)
	02	Send/read memory keyer contents (see p. 146 for details)
	03	Send/read the selected filter width (SSB, CW, RTTY: 0=50 Hz to 40/31=3600/2700 Hz; AM: 0=200 Hz to 49=10 kHz)
	04	Send/read the selected AGC time constant (0=OFF, 1=0.1/0.3 sec. to 13=6.0/8.0 sec.)
	050001	RF Power setting (0=mini. to 255=max.)
	050002	MIC Gain setting (0=mini. to 255=max.)
050003	Send/read of SSB TX bandwidth (lower edge) for wide (0=100, 1=200, 2=300, 3=500 HZ)	
050004	Send/read of SSB TX bandwidth (higher edge) for wide (0=2500, 1=2700, 2=2800, 3=2900 HZ)	
050005	Send/read of SSB TX bandwidth (lower edge) for middle (0=100, 1=200, 2=300, 3=500 HZ)	
050006	Send/read of SSB TX bandwidth (higher edge) for middle (0=2500, 1=2700, 2=2800, 3=2900 HZ)	



## •Command table (continued)

Command	Sub command	Description
1A	050007	Send/read of SSB TX bandwidth (lower edge) for narrow (0=100, 1=200, 2=300, 3=500 HZ)
	050008	Send/read of SSB TX bandwidth (higher edge) for narrow (0=2500, 1=2700, 2=2800, 3=2900 HZ)
	050009	Twin Peak Filter (0=OFF; 1=ON)
	050010	Send/read RTTY mark frequency (0=1275 Hz, 1=1615 Hz, 2=2125 Hz)
	050011	Send/read RTTY shift width (0=170 Hz, 1=200 Hz, 2=425 Hz)
	050012	Send/read RTTY keying polarity (0=Normal, 1=Reverse)
	050013	Send/read CW key speed (0=0.6 WPM to 255=60 WPM)
	050014	Send/read CW Pitch setting (0=300 Hz, 120=900 Hz, in 5 Hz steps)
	050015	Send/read CW side tone level (0=min. to 255=max.)
	050016	Send/read CW side tone level limit (0=OFF, 1=ON)
	050017	Send/read LCD contrast (0=0% to 255=100%)
	050018	Send/read LCD bright (0=0%, 255=100%)
	050019	Send/read LCD unit bright (0=0% to 255=100%)
	050020	Send/read LCD flicker level (0=0% to 255=100%)
	050021	Send/read switch backlight (0=0% to 255=100%)
	050022	Send/read display type (0=A, 1=B, 2=C)
	050023	Send/read display font type (0=Basic, 1=Italic)
	050024	Send/read display font size (0=Normal, 1=Large)
	050025	Send/read meter peak hold (0=OFF, 1=ON)
	050026	Send/read filter pop up indication for PBT shifting (0=OFF, 1=ON)
	050027	Send/read filter pop up indication for IF filter setting (0=OFF, 1=ON)
	050028	Send/read pop up indication for 1 Hz mode (0=OFF, 1=ON)
	050029	Send/read pop up indication for scope center/fix (0=OFF, 1=ON)
	050030	Send/read TV pop up indication for channel Up/Down (0=OFF, 1=ON)
	050031	Send/read TV pop up indication for P.AMP/ATT (0=OFF, 1=ON)
	050032	Send/read indication of the voice TX memory channel names (0=OFF, 1=ON)
	050033	Send/read indication of the keyer memory names (0=OFF, 1=ON)
	050034	Send/read indication of the DTMF memory names (0=OFF, 1=ON)
	050035	Send/read external display setting (0=1:1.8, 1=1:1.6)

Command	Sub command	Description
1A	050036	Send/read opening message (0=OFF, 1=ON)
	050037	Send/read my call sign setting (10 character: see p. 147 )
	050038	Send/read power ON check (0=OFF, 1=ON)
	050039	Send/read current year (2000 to 2099)
	050040	Send/read current date (0101 to 1231=Jan. 1st to Dec. 31st)
	050041	Send/read current time (0000 to 2359=00:00 to 23:59)
	050042	Send/read clock2 function (0=OFF, 1=ON)
	050043	Send/read offset time for clock2 function (24001 to 24000=-24:00 to +24:00)
	050044	Send/read auto power OFF period (0=OFF, 1=30 min., 2=60 min., 3=90 min.)
	050045	Send/read TX monitor set (0=OFF, 1=ON)
	050046	Send/read TX monitor gain (0=0% to 255=100%)
	050047	Send/read confirmation beep (0=OFF, 1=ON)
	050048	Send/read band edge beep (0=OFF, 1=ON)
	050049	Send/read beep gain (0=min. to 255=max.)
	050050	Send/read beep gain limit (0=OFF, 1=ON)
	050051	Send/read RF/SQL control set (0=Auto, 1=SQL, 2=RF+SQL)
	050052	Send/read quick split set (0=OFF, 1=ON)
	050053	Send/read split offset -9.999 to +9.999 MHz (see p. 147 for details)
	050054	Send/read split lock set (0=OFF, 1=ON)
	050055	Send/read duplex offset 0.000 to 9.999 MHz for HF (see p. 147 for details)
	050056	Send/read duplex offset 0.000 to 9.999 MHz for 50 MHz band (see p. 147 for details)
	050057	Send/read duplex offset 0.000 to 9.999 MHz for 144 MHz band (see p. 147 for details)
050058	Send/read duplex offset 0.000 to 9.999 MHz for 430 MHz band (see p. 147 for details)	
050059	Send/read one touch repeater set (0=DUP-, 1=DUP+)	
050060	Send/read auto repeater set (0=OFF, 1=ON-1, 2=ON-2)	
050061	Send/read tuner auto start set (0=OFF, 1=ON)	
050062	Send/read PTT tune set (0=OFF, 1=ON)	

CW: Clockwise, CCW: Counter Clockwise

## • Command table (continued)

Command	Sub command	Description
1A	050063	Send/read [TUNER/CALL] key action set (0=Manual, 1=Auto)
	050064	Send/read [ACC] (pin 7) output "VSEND" set (0=OFF, 1=UHF only, 2=ON)
	050065	Send/read speech level (0=0 to 255=100%)
	050066	Send/read speech language (0=English, 1=Japanese)
	050067	Send/read speech speed (0=Slow, 1=Fast)
	050068	Send/read S-level speech (0=OFF, 1=ON)
	050069	Send/read speech capability with [MODE] key operation (0=OFF, 1=ON)
	050070	Send/read memopad numbers (0=5 ch, 1=10 ch)
	050071	Send/read scan speed (0=Low, 1=High)
	050072	Send/read scan resume (0=OFF, 1=ON)
	050073	Send/read main dial auto TS (0=OFF, 1=Low, 2=High)
	050074	Send/read [F-1] key assignment of the HM-151. (0="P.AMP/ATT," 1="NB," 2="NR," 3="MNF," 4="ANF," 5="TS," 6="SPL," 7="A/B," 8="MCL," 9="BNK," 10="COM," 11="AGC," 12="TBW," 13="DUP," 14="TON," 15="MET," 16="VSC," 17="MPW," 18="MPR," 19="<SCOPE>," 20="<METER>")
	050075	Send/read [F-2] key assignment of the HM-151. (Selectable functions are same as [F-1].)
	050076	Send/read mic. up/down speed (0=Low, 1=High)
	050077	Send/read quick RIT/ΔTX clear function (0=OFF, 1=ON)
	050078	Send/read SSB/CW synchronous tuning function (0=OFF, 1=ON)
	050079	Send/read CW normal side set (0=LSB, 1=USB)
	050080	Send/read voice recorder 1st menu set (0=Voice-root, 1=Voice-RX/TX)
	050081	Send/read keyer 1st menu set (0=Keyer-root, 1=Keyer-send)
	050082	Send/read DTMF 1st menu set (0=DTMF-root, 1=DTMF-send)
	050083	Send/read SSB mode selectability (0=OFF: inhibition, 1=ON: selectable)
	050084	Send/read CW mode selectability (0=OFF: inhibition, 1=ON: selectable)
	050085	Send/read RTTY mode selectability. (0=OFF: inhibition, 1=ON: selectable)
	050086	Send/read AM mode selectability (0=OFF: inhibition, 1=ON: selectable)

Command	Sub command	Description
1A	050087	Send/read FM mode selectability (0=OFF: inhibition, 1=ON: selectable)
	050088	Send/read WFM mode selectability (0=OFF: inhibition, 1=ON: selectable)
	050089	Send/read external keypad set for voice memory (0=OFF, 1=ON)
	050090	Send/read external keypad set for keyer memory (0=OFF, 1=ON)
	050091	Send/read external keypad type connected to [MIC] connector of controller (0=Dot/Dash type, 1=Ext Keypad)
	050092	Send/read CI-V transceive set (0=OFF, 1=ON)
	050093	Send/read reference frequency set (0=0 to 255=100%)
	050094	Send/read speech compressor level (0=0 to 10=10)
	050095	Send/read auto voice monitor set (0=OFF, 1=ON)
	050096	Send/read MIC memo function (0=OFF, 1=ON)
	050097	Send/read contest number style (0=Normal, 1=190→ANO, 2=190→ANT, 3=90→NO, 4=90→NT)
	050098	Send/read count up trigger channel (1=M1, 2=M2, 3=M3, 4=M4)
	050099	Send/read present number (1-9999)
	050100	Send/read CW keyer repeat time (1=1 sec. to 60=60 sec.)
	050101	Send/read CW keyer dot/dash ratio (28=1:1:2.8 to 45=1:1:4.5)
	050102	Send/read rise time (0=2 msec., 1=4 msec., 2=6 msec., 3=8 msec.)
	050103	Send/read CW paddle polarity (0=Normal, 1=Reverse)
050104	Send/read CW keyer type (0=Straight, 1=Bug-key, 2=ELEC-Key)	
050105	Send/read MIC up/down keyer (HM-103) set (0=OFF, 1=ON)	
050106	Send/read RTTY decode USOS (0=OFF, 1=ON)	
050107	Send/read RTTY decode new line code (0=CR,LF,CR+LF, 1=CR+LF)	
050108	Send/read scope max. hold (0=OFF, 1=ON)	
050109	Send/read scope size set (0=Normal, 1=Wide)	
050110	Send/read fast sweep set (0=1 sweep, 1=Continuous)	
050111	Send/read fast sweep audio level (0=0 dB, 1=-10 dB, 2=OFF)	
050112	Send/read NB level set (0=min. to 255=max.)	
050113	Send/read NB width set (0=min. to 255=max.)	

### • Command table (continued)

Command	Sub command	Description
1A	050114	Send/read NR level set (0=0 to 15=15)
	050115	Send/read VOX gain (0=0% to 255=100%)
	050116	Send/read anti VOX gain (0=0% to 255=100%)
	050117	Send/read VOX delay (0=0.0 sec. to 20=2.0 sec.)
	050118	Send/read DTMF speed set (0=100 msec., 1=200 msec., 2=300 msec., 3=500 msec.)
	050119	Send/read Break-IN delay set (20=2.0d to 130=13.0d)
06		Send/read SSB transmit bandwidth (0=WIDE, 1=MID, 2=NAR)
07		Send/read DSP filter shape (0= sharp, 1= soft)
08		Send/read manual notch filter1 bandwidth (0=WIDE, 1=MID, 2=NAR)
09		Send/read manual notch filter2 bandwidth (0=WIDE, 1=MID, 2=NAR)
0A		Send/read 9600 bps mode set (0=OFF, 1=ON)
1B	00	Set/read repeater tone frequency (see p. 147 for details)
	01	Set/read TSQL tone frequency (see p. 147 for details)
	02	Set/read DTCS code and polarity (see p. 147 for details)
1C	00	Set/read the transceiver's condition (0=Rx; 1=Tx)
	01	Set/read antenna tuner condition (0=OFF, 1=ON, 2=Start tuning or while tuning)

CW: Clockwise, CCW: Counter Clockwise

### ◇ To send/read memory contents

When sending or reading memory contents, an additional code as follows must be added to specify the memory channel.

➔ Additional code: 0000–0102 (0100=P1, 0101=P2, 0102=Call)

### ◇ Band stacking register

To send or read the desired band stacking register's contents, a combination of the frequency band and register codes as follows are used.

For example, when sending/reading the oldest contents in the 21 MHz band, the code "0703" is used.

#### • Frequency band codes

Code	Frequency band	Frequency range (unit: MHz)
01	1.8	1.800000– 1.999999
02	3.5	3.400000– 4.099999
03	7	6.900000– 7.499999
04	10	9.900000–10.499999
05	14	13.900000–14.499999
06	18	17.900000–18.499999
07	21	20.900000–21.499999
08	24	24.400000–25.099999
09	28	28.000000–29.999999
10	50	50.000000–54.000000
11	144	144.000000–148.000000
12	430	430.000000–450.000000
13	GENE	Other than above

#### • Register codes

Code	Register number
01	1 (latest)
02	2
03	3 (oldest)

### ◇ Codes for memory keyer contents

To send or read the desired memory keyer contents, the channel and character codes as follows are used.

#### • Channel codes

Code	Channel number
01	M1
02	M2
03	M3
04	M4

#### • Character codes

Character	ASCII code	Description
0–9	30–39	Numerals
A–Z	41–5A	Alphabetical characters
space	20	Word space
/	2F	Symbol
?	3F	Symbol
,	2C	Symbol
.	2E	Symbol
^	5E	e.g., to send BT, enter ^4254
*	2A	Inserts contact number (can be used for 1 channel only)

◇ Character codes for My Call

Character	ASCII code	Description
0-9	30-39	Numerals
A-Z	41-5A	Alphabetical characters
space	20	Word space
-	2D	Symbol
.	2E	Symbol
/	2F	Symbol

◇ Codes for memory name contents

To send or read the desired memory name settings, the character codes, instruction codes for memory keyer contents as above, and the following are used.

• Character codes— Alphabetical characters

Character	ASCII code	Character	ASCII code
a-z	61-7A	-	-

• Character codes— Symbols

Character	ASCII code	Character	ASCII code
!	21	#	23
\$	24	%	25
&	26	¥	5C
?	3F	”	22
'	27	`	60
+	2B	-	2D
:	3A	;	3B
=	3D	<	3C
>	3E	(	28
)	29	[	5B
]	5D	{	7B
}	7D		7C
_	5F	-	7E
@	40		

◇ Split/Duplex frequency setting

The following data sequence is used when sending/reading the split or duplex frequency setting.

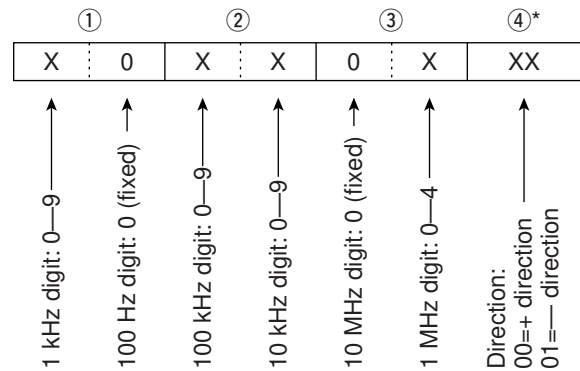

\*No need to enter for duplex frequency setting.

◇ Repeater tone/tone squelch frequency setting

The following data sequence is used when sending/reading the DTCS code and polarity setting.

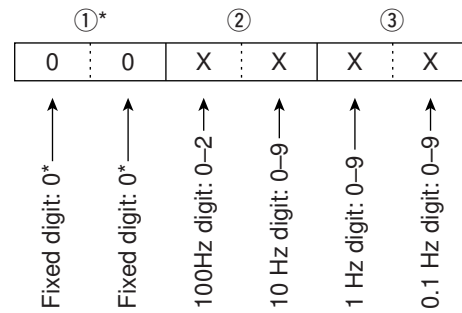

\*Not necessary when setting a frequency.

◇ DTCS code and polarity setting

The following data sequence is used when sending/reading the DTCS code and polarity setting.

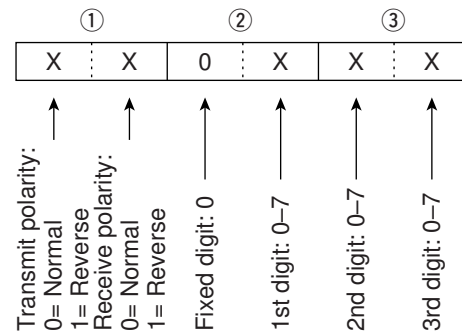

## General

- Frequency coverage :
  - Receive
    - 30 kHz–199.999999 MHz<sup>\*1\*2</sup>
    - 400–470.000000 MHz<sup>\*1\*2</sup>
  - Transmit
    - 1.800–1.999999 MHz<sup>\*2</sup>, 3.500–3.999999 MHz<sup>\*2</sup>
    - 5.33050<sup>\*3</sup>, 5.34650<sup>\*3</sup>, 5.36650<sup>\*3</sup>,
    - 5.37150<sup>\*3</sup>, 5.40350<sup>\*3</sup>,
    - 7.000–7.300 MHz<sup>\*2</sup>, 10.100–10.150 MHz<sup>\*2</sup>,
    - 14.000–14.350 MHz<sup>\*2</sup>, 18.068–18.168 MHz<sup>\*2</sup>,
    - 21.000–21.450 MHz<sup>\*2</sup>, 24.890–24.990 MHz<sup>\*2</sup>,
    - 28.000–29.700 MHz<sup>\*2</sup>, 50.000–54.000 MHz<sup>\*2</sup>,
    - 144.000–148.000 MHz<sup>\*2</sup>, 430.000–450.000 MHz<sup>\*2</sup>

<sup>\*1</sup>Some frequency bands are not guaranteed.

<sup>\*2</sup>Depending on version. <sup>\*3</sup>USA version only.

- Mode : SSB, CW, RTTY, AM, FM, WFM  
(WFM is for receive only)
- Number of memory CH: 503 (split memory: 99×5 banks; scan edges: 6; call channel: 2) channels
- Antenna connector : SO-239×2 (for HF/50 MHz and 144/430 MHz) /50 Ω
- Usable temperature range : -10°C to +60°C (+14°F to +140°F)
- Frequency stability : Less than ±0.5 ppm  
(0°C to +50°C; +32°F to +122°F)
- Power supply requirement : 13.8 V DC±15% (negative ground)
- Current drain : Transmit (at 100 W) 22 A  
Receive squelched 1.3 A  
max. audio 1.6 A
- Dimensions : 167(W)×58(H)×180(D) mm,  
(projections not included) 6<sup>9</sup>/<sub>16</sub>(W)×2<sup>9</sup>/<sub>32</sub>(H)×7<sup>9</sup>/<sub>32</sub>(D) in
- Weight (approx.) : 2.3 kg (5 lb 1 oz)
- CI-V connector : 2-conductor 3.5 (d) mm (1/8")
- Video connector : 2-conductor 3.5 (d) mm (1/8")
- ACC connector : 13-pin
- Data connector : 6-pin

## Transmitter

- Output power :
    - SSB, CW, FM, RTTY 2–100 W (1.8–50 MHz bands)
    - 2–50 W (144 MHz band)
    - 2–35 W (430 MHz band)
    - AM 1–40 W (1.8–50 MHz bands)
    - 2–20 W (144 MHz band)
    - 2–14 W (430 MHz band)
  - Modulation system :
    - SSB Balanced modulation
    - AM Low level modulation
    - FM Variable reactance modulation
  - Spurious emissions : Less than -60 dB<sup>\*</sup>
- <sup>\*</sup>spurious freq.: below 30 MHz -50 dB, above 50 MHz -60 dB
- Carrier suppression : More than 50 dB
  - Unwanted sideband : More than 50 dB
  - Microphone connector : 8-pin modular jack (600 Ω)
  - KEY connector : 3-conductor 6.35 (d) mm (1/4")
  - RTTY connector : 3-conductor 3.5 (d) mm (1/8")

## Receiver

- Receive system :
  - SSB/CW/RTTY/AM/FM Triple-conversion superheterodyne
  - WFM Double-conversion superheterodyne
- Intermediate frequencies:
  - 1st
    - SSB/CW/RTTY/AM/FM 124.487 MHz
    - WFM 134.732 MHz
  - 2nd
    - SSB/CW/RTTY/AM/FM 455 kHz
    - WFM 10.700 MHz
  - 3rd
    - SSB/CW/RTTY/AM/FM 16.15 kHz
- Sensitivity (at preamp ON):

Frequency range [MHz]	SSB/CW/RTTY 10 dB S/N	AM 10 dB S/N	FM 12 dB SINAD	WFM 12 dB SINAD
0.5–1.8	—	13 μV	—	—
1.8–28	0.15 μV	2.0 μV	—	—
28–29.995			0.5 μV	—
50 MHz band	0.12 μV	1.0 μV	0.25 μV	—
76–108	—	—	—	10.0 μV
144/430 MHz bands	0.11 μV	1.0 μV	0.18 μV	—

- Squelch sensitivity (threshold; preamp ON) :
  - SSB Less than 5.6 μV
  - FM Less than 0.3 μV
- Selectivity :
  - SSB\* (BW=2.4 kHz) More than 2.4 kHz/-6 dB  
Less than 3.6 kHz/-60 dB
  - CW\* (BW=500 Hz) More than 500 Hz/-6 dB  
Less than 900 Hz/-60 dB
  - RTTY (BW=350 Hz) More than 360 Hz/-6 dB  
Less than 650 Hz/-60 dB
  - AM (BW=6 kHz) More than 6.0 kHz/-6 dB  
Less than 15.0 kHz/-60 dB
  - FM (BW=15 kHz) More than 12.0 kHz/-6 dB  
Less than 20.0 kHz/-60 dB

<sup>\*</sup>IF filter shape is set to SHARP.
- Spurious and image rejection ratio:
  - HF bands More than 70 dB
  - 50 MHz band More than 70 dB (except IF/2 through)
  - 144/430 MHz band More than 65 dB (except IF through)
- Audio output power : More than 2.0 W at 10% distortion with an 8 Ω load (at 13.8 V DC)
- RIT variable range : ±9.99 kHz
- PHONES connector : 3-conductor 3.5 (d) mm (1/8")/8 Ω
- EXT SP connector : 2-conductor 3.5 (d) mm (1/8")/8 Ω

# 19 OPTIONS

## AT-180 HF/50 MHz AUTOMATIC ANTENNA TUNER



Fully automatic antenna tuner with preset memories for each 100 kHz. Unique "automatic tuner on" function is available. See p. 141 for AT-180 specifications.

## AH-4 HF AUTOMATIC ANTENNA TUNER



Specially designed to tune a long wire antenna for portable or mobile HF/50 MHz operation. The "PTT tune" function provides simple operation.

- Input power rating: 150 W

## AH-2b ANTENNA ELEMENT



A 2.5 m long antenna element for mobile operation with the AH-4.

- Frequency coverage 7–54 MHz band with the AH-4

## HM-151 HAND MICROPHONE



Standard hand microphone.

## SM-20 DESKTOP MICROPHONE



Includes [UP]/[DOWN] switches and a low cut function. The OPC-589 is necessary to use this microphone.

## CT-17 CI-V LEVEL CONVERTER UNIT



For remote transceiver control using a personal computer equipped with an RS-232C port. You can change frequencies, operating mode, memory channels, etc., via your computer.

## SP-7 EXTERNAL SPEAKER



Compact speaker for base station operation. Height can be adjusted for your convenience.

- Input impedance: 8  $\Omega$
- Max. input power: 5 W

## SP-10 EXTERNAL SPEAKER



External speakers suitable for mobile operation.

- SP-12: Slim-type; 8  $\Omega$ /5 W
- SP-10: Compact-type; 4  $\Omega$ /5 W

## MB-62 MOBILE MOUNTING BRACKET



Mounts the transceiver main body, with or without the front panel, inside a vehicle.

## MB-105 MOUNTING BRACKET



Metal plate for attaching the front panel to a wall or other such flat surface.

## MB-65 MOUNTING BASE



Allows you to conveniently vehicle-mount the front panel of the IC-7000. An MB-105 must be used in combination with the MB-65.

## MB-106 CARRYING HANDLE



Convenient when carrying the transceiver.

**OPC-1443**  
SEPARATION CABLE



Provide front panel detached operation for mobile installations or compact transceiver operation.

- OPC-1443: 3.5 m (11.5 ft)
- OPC-1444: 5 m (16.4 ft)

**OPC-1444**  
SEPARATION CABLE



Provide front panel detached operation for mobile installations or compact transceiver operation.

- OPC-1443: 3.5 m (11.5 ft)
- OPC-1444: 5 m (16.4 ft)

**OPC-589**  
MICROPHONE ADAPTOR CABLE

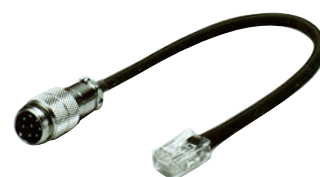

Conversion between 8-pin modular and 8-pin metal connector for using a desktop microphone with the IC-7000.

**OPC-598** ACC 13-PIN CABLE



Required when using the AT-180.  
• 7 m (22 ft)

**OPC-599** ADAPTOR CABLE



13-pin, ACC connector to 7-pin + 8-pin ACC connector.

**OPC-742** ACC 13-PIN CABLE  
Required when using both the AT-180 and 2 m linear amplifier.

**IC-PW1/EURO HF/50 MHz ALL BAND 1 kW LINEAR AMPLIFIER**



Full-duty 1 kW linear amplifier including an automatic antenna tuner. Has automatic tuning and band selection capability. Full break-in (QSK) operation is possible. The amplifier/power supply unit and the remote control unit are separated. An optional OPC-599 is required for connection.

# 20 MENU GUIDE

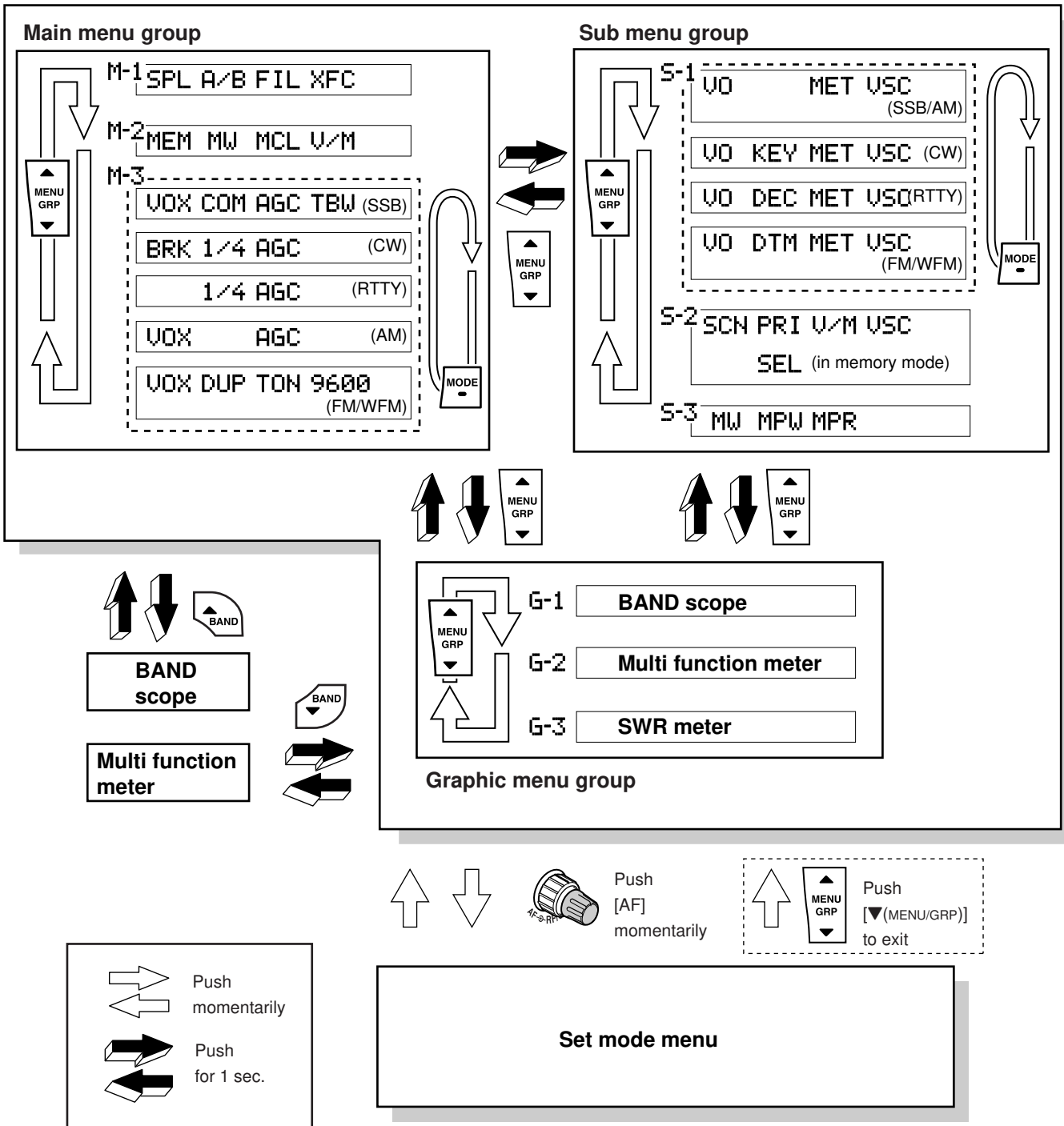



## Set mode description

### • Set mode menu

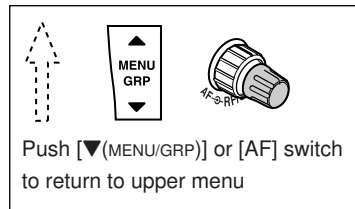
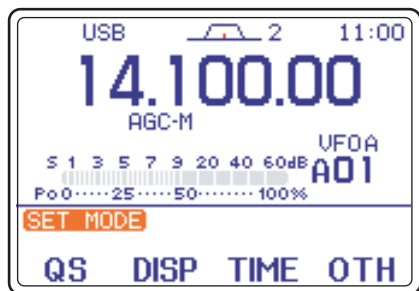

### • Miscellaneous (others) set mode

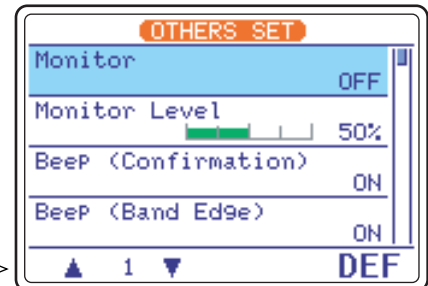

### • Display set mode

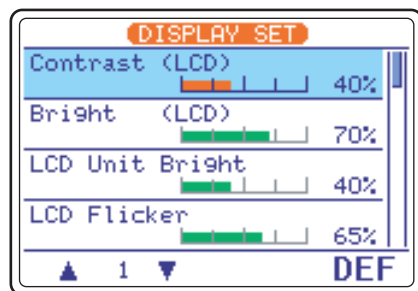

### • Time set mode

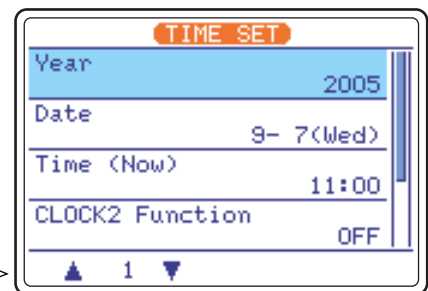

### Quick set mode

No.	SSB mode	CW mode	RTTY mode	AM/FM mode
1	RF Power	RF Power	RF Power	RF Power
2	MIC Gain	Key Speed	Twin Peak Filter	MIC Gain
3	SSB TBW (WIDE) L	CW Pitch	RTTY Mark Frequency	---
4	SSB TBW (WIDE) H	Side Tone Level	RTTY Shift Width	---
5	SSB TBW (MID) L	Side Tone Level Limit	RTTY Keying Polarity	---
6	SSB TBW (MID) H	---	---	---
7	SSB TBW (NAR) L	---	---	---
8	SSB TBW (NAR) H	---	---	---

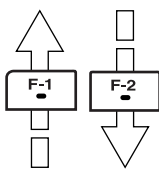









**Count on us!**

