



INSTRUCTION MANUAL

HF/50 MHz
ALL MODE TRANSCEIVER
IC-703



Icom Inc.

Downloaded by

Amateur Radio Directory

FOREWORD

Thank We understand that you have a choice of many different radios in the market place. We want to take a couple of moments of your time to thank you for making the IC-703 your radio of choice, and hope you agree with Icom's philosophy of "technology first." Many hours of research and development went into the design of your IC-703.

FEATURES

- DSP features (AF DSP; UT-106 DSP UNIT required some version)
- All mode capability covering 160–6 m
- 9.0–15.87 V operation
- Compact with detachable front panel
- ±0.5 ppm of high frequency stability
- Built in antenna tuner
- Simple band scope function

PRECAUTION

⚠ WARNING RF EXPOSURE! This device emits Radio Frequency (RF) energy. Extreme caution should be observed when operating this device. If you have any questions regarding RF exposure and safety standards please refer to the Federal Communications Commission Office of Engineering and Technology's report on Evaluating Compliance with FCC Guidelines for Human Radio Frequency Electromagnetic Fields (OET Bulletin 65).

⚠ WARNING HIGH VOLTAGE! NEVER attach an antenna or internal antenna connector during transmission. This may result in an electrical shock or burn.

⚠ NEVER apply AC to the [DC13.8V] receptacle on the transceiver rear panel. This could cause a fire or damage the transceiver.

⚠ NEVER apply more than 16 V DC, such as a 24 V battery, to the [DC13.8V] receptacle on the transceiver rear panel. This could cause a fire or damage the transceiver.

⚠ NEVER let metal, wire or other objects touch any internal part or connectors on the rear panel of the transceiver. This may result in an electric shock.

NEVER expose the transceiver to rain, snow or any liquids.

AVOID using or placing the transceiver in areas with temperatures below -10°C ($+14^{\circ}\text{F}$) or above $+60^{\circ}\text{C}$ ($+140^{\circ}\text{F}$). Be aware that temperatures on a vehicle's dashboard can exceed 80°C ($+176^{\circ}\text{F}$), resulting in permanent damage to the transceiver if left there for extended periods.

AVOID placing the transceiver in excessively dusty environments or in direct sunlight.

IMPORTANT

READ THIS INSTRUCTION MANUAL CAREFULLY before attempting to operate the transceiver.

SAVE THIS INSTRUCTION MANUAL. This manual contains important safety and operating instructions for the IC-703.

EXPLICIT DEFINITIONS

WORD	DEFINITION
⚠ WARNING	Personal injury, fire hazard or electric shock may occur.
CAUTION	Equipment damage may occur.
NOTE	If disregarded, inconvenience only. No risk or personal injury, fire or electric shock.

AVOID placing the transceiver against walls or putting anything on top of the transceiver. This will obstruct heat dissipation.

Place unit in a secure place to avoid inadvertent use by children.

During mobile operation, **DO NOT** operate the transceiver without running the vehicle's engine. When the transceiver's power is ON and your vehicle's engine is OFF, the vehicle's battery will soon become exhausted.

Make sure the transceiver power is OFF before starting the vehicle. This will avoid possible damage to the transceiver by ignition voltage spikes.

During maritime mobile operation, keep the transceiver and microphone as far away as possible from the magnetic navigation compass to prevent erroneous indications.

BE CAREFUL! The rear panel will become hot when operating the transceiver continuously for long periods.

BE CAREFUL! If a linear amplifier is connected, set the transceiver's RF output power to less than the linear amplifier's maximum input level, otherwise, the linear amplifier will be damaged.

Use Icom microphones only (supplied or optional). Other manufacturer's microphones have different pin assignments, and connection to the IC-703 may damage the transceiver.

Beat signals may be heard on some frequencies. These will occur as a result of circuit construction.

For U.S.A. only

Caution: Changes or modifications to this transceiver, not expressly approved by Icom Inc., could void your authority to operate this transceiver under FCC regulations.

TABLE OF CONTENTS

FOREWORD i
IMPORTANT i
EXPLICIT DEFINITIONS i
PRECAUTION i
TABLE OF CONTENTS ii

QUICK REFERENCE GUIDE I-X

- Installation I
 - 1. Grounding your Shack I
 - 2. Installing your DC Power Supply I
 - 3. Installing lightning protection II
 - 4. Installing your antenna system II
 - 5. Connect other peripheral equipment III
- Operation III
 - 1. Voice III
 - 2. CW III
 - 3. Other convenient items IV
- Your first contact IV
 - ◇ Getting started IV
 - ◇ Just listening V
 - 1. Select the desired band V
 - 2. Tune to the desired frequency V
 - 3. Adjust audio output V
 - ◇ What are you hearing? VI
 - 1. Verify mode VI
 - 2. Reducing interference
(Some functions may require
an optional unit depending on version) ... VI
- Ready to call CQ? IX
 - 1. Setting up your Mic Gain IX
 - 2. Speech compressor X

1 PANEL DESCRIPTION 1-10

- Front panel 1
- Multi-function switches 4
 - ◇ M1 functions 4
 - ◇ M2 functions 4
 - ◇ M3 functions 4
 - ◇ M4 functions 5
 - ◇ S1 functions 6
 - ◇ S2 functions 6
 - ◇ S3 functions 6
 - ◇ S4 functions
(UT-106 is required for some version) 6
- Rear panel 7
 - ◇ DATA socket 8
 - ◇ ACC socket 8
- Function display 9
- Microphone (HM-103) 10

2 INSTALLATION AND CONNECTIONS ... 11-16

- Unpacking 11
- Selecting a location 11
- Grounding 11
- Antenna connection 11
- Installation 12
 - ◇ Single body mounting 12
 - ◇ Stand 12
 - ◇ Front panel separation 12
 - ◇ Front panel mounting 12
- Required connections 13
- Advanced connections 14
- DC Power voltage 15
- DC Power supply connections 15
- Battery connections 15
- External antenna tuners and linear amplifier ... 16

Quick Reference

1

2

3

4

5

6

7

8

9

10

11

12

13

14

15

16

17

18

19

SUPPLIED ACCESSORIES

The transceiver comes with the following accessories.

	Qty.
① Hand microphone (HM-103)	1
② DC power cable (OPC-1229)	1
③ Spare fuse (FGB 4 A)	3
④ ACC cable	1
⑤ 3.5 (d) mm plug	1
⑥ 6.5 (d) mm Electronic keyer plug.....	1
⑦ Microphone hanger.....	1

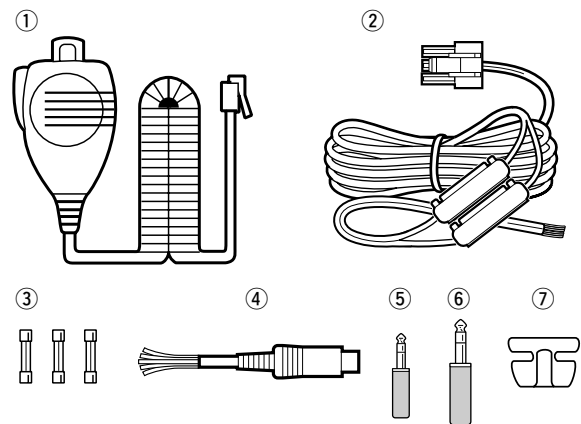

TABLE OF CONTENTS

3 BASIC OPERATION	17–26
■ When first applying power (CPU resetting).....	17
◇ MI display selection	17
■ Initial settings	17
■ VFO description	18
◇ The differences between VFO and memory mode	18
■ Frequency setting	19
■ Operating mode selection	23
■ Volume setting	23
■ Squelch and receive (RF) sensitivity	24
■ Dial lock function	25
■ Basic transmit operation	25
◇ Transmitting	25
◇ Maximum output power	25
◇ Setting output power	26
◇ Setting microphone gain.....	26
4 RECEIVE AND TRANSMIT	27–45
■ Operating SSB.....	27
◇ Convenient functions for receive	27
◇ Convenient functions for transmit	27
■ Operating CW	28
◇ Connections for CW	28
◇ CW operation	29
◇ Convenient functions for receive	30
◇ Convenient functions for transmit	30
◇ CW reverse mode	30
◇ CW pitch control	31
◇ Electronic CW keyer	31
◇ CW side tone function.....	32
◇ Keyer set mode	32
■ Memory keyer functions.....	33
◇ Memory keyer send menu	34
◇ Editing a memory keyer	35
◇ Contest number set mode	36
◇ Memory keyer set mode.....	37
■ Operating RTTY	38
◇ Connections for RTTY (FSK).....	38
◇ RTTY (FSK) operation	38
◇ Convenient functions for receive	39
◇ RTTY reverse mode	39
◇ Presetting for RTTY	40
◇ RTTY tone set mode	40
■ Operating AM	41
◇ Convenient functions for receive	41
◇ Convenient functions for transmit	41
■ Operating FM	42
◇ Convenient functions for receive	42
◇ Convenient functions for transmit	42
◇ Tone squelch operation	43
◇ Tone scan operation	43
◇ FM tone set mode	44
■ Repeater operation	45
5 FUNCTION FOR RECEIVE	46–50
■ Simple band scope	46
■ Preamp and attenuator	46
■ RIT function	47
■ IF shift function	47
■ Noise blanker	48
◇ Noise blanker level set mode	48
■ AGC time constant	48
■ Optional filter selection	49
■ Peak meter hold	50
■ DSP Functions (may require an optional unit depending on version)	50
◇ ANF (Automatic Notch Filter) function	50
◇ NR (Noise Reduction) function	50
6 FUNCTION FOR TRANSMIT	51–55
■ Split frequency operation	51
◇ Quick split function	52
■ Meter selection	52
■ VOX operation	53
◇ VOX set mode	53
■ Speech compressor	54
◇ Compression level set mode	54
■ SWR.....	55
◇ Measuring SWR	55
7 MEMORY OPERATION	56–60
■ Memory channels	56
■ Memory channel selection.....	56
■ Memory programming	57
■ Memory clearing	58
■ Frequency transferring	58
■ Memory names	59
■ Memo pads	60
8 SCAN OPERATION	61–63
■ Scan types	61
■ Preparation	61
■ Programmed scan operation.....	62
■ Memory scan operation	62
■ Select memory scan operation	63
■ Priority watch	63
9 ANTENNA TUNER OPERATION	64–66
■ Antenna tuner operation	64
◇ Internal antenna tuner.....	64
◇ Tuner operation	64
◇ Optional external tuner operation	65
◇ Optional AT-180 AUTOMATIC ANTENNA TUNER operation	65
◇ Optional AH-4 AUTOMATIC ANTENNA TUNER operation	66

TABLE OF CONTENTS

10 DATA COMMUNICATION	67–70	29 [UP]/[DN] speed	80
■ Connections for packet	67	30 Noise blanker in AM mode	80
◇ When connecting to [DATA] socket	67	31 Available memo pads	80
◇ When connecting to [ACC] socket	67	32 Power ON check function	81
◇ When connecting to [MIC] connector	67	33 Auto tune start function	81
■ Packet (AFSK) operation	68	34 PTT tune function	81
◇ Frequency indication during AFSK operation ...	68	35 Tuner switch condition	81
◇ SSB-D mode selection	69	36 Packet data speed	81
◇ Carrier point setting	69	37 Voice synthesizer language.....	82
◇ Adjusting the transmit signal from the TNC...	70	38 Voice synthesizer speed	82
11 CONTROL COMMAND	71–73	39 S-meter level speech	82
■ Remote jack (CI-V) information	71	40 CI-V address setting	82
◇ CI-V connection example	71	41 CI-V data transfer rate.....	82
◇ Data format	71	42 CI-V transceive	82
◇ Command table	72	43 CI-V operating frequency data length ...	82
◇ Band stacking register	73	13 MAINTENANCE	83
◇ Codes for memory keyer contents	73	■ Fuse replacement	83
◇ Codes for memory name contents	73	■ Memory backup	83
12 SET MODE	74–82	■ Cleaning	83
■ General	74	14 TROUBLESHOOTING	84–85
◇ Quick set mode operation	74	15 OPTIONAL UNIT	
◇ Initial set mode operation	74	INSTALLATIONS AND SETTINGS ...	86–89
■ Quick set mode items.....	75	■ Opening the transceiver case	86
■ Initial set mode items	76	■ UT-102 VOICE SYNTHESIZER UNIT	86
1 Maximum output power setting	76	◇ Operation	86
2 Power save setting	76	■ IF filter	87
3 Simple mode setting.....	76	■ UT-106 DSP RECEIVER UNIT	88
4 Mode availability	76	■ MB-72 CARRYING HANDLE	88
5 Output power setting for mode	76	■ AT-180 internal switch description	89
6 Confirmation beeps	77	16 SPECIFICATIONS	90
7 Band edges beeps	77	■ General	90
8 Beep level adjustment	77	■ Transmitter	90
9 Beep audio level limit	77	■ Receiver	90
10 CW carrier point setting	77	■ Antenna tuner	90
11 CW side tone level	77	17 OPTIONS	91–92
12 CW side tone level limit	77	18 MENU GUIDE	93–94
13 SSB/CW frequency shift setting	78	19 ABOUT CE	95–96
14 Display backlighting	78		
15 Key/switch backlighting	78		
16 Light timer setting	78		
17 LED brightness	78		
18 Automatic power OFF	78		
19 Current intercept point	79		
20 RF gain/squelch control	79		
21 Sub dial setting	79		
22 Optional filter selection.....	79		
23 Peak meter hold setting	79		
24 Quick split function	79		
25 Split lock function	80		
26 Split offset frequency	80		
27 Scan resume condition.....	80		
28 Scanning speed.....	80		

QUICK REFERENCE GUIDE

■ Installation

1. Install a ground system for DC noise suppression and RFI suppression
2. Install your DC power supply
3. Install lightning protection. This will help protect more than your gear.

4. Install and connect an antenna system for the appropriate bands of operation
5. Connect other peripheral equipment. This includes microphones, headsets, TNC, amplifiers and any other equipment necessary to make your shack complete.

1. Grounding your Shack

Although your radio will operate by connecting the DC power supply and antenna, it is necessary to have a good ground system in your shack. A ground connection is the electrical contact between the common point of an electrical or electronic system and the earth.

A good earth ground is necessary to prevent electrical shock, eliminate problems from RFI and DC noise. With more electronic devices being used today, it is also important to reduce RFI and EMI. Although you may not see interference in your shack, without a grounding system, your neighbours may experience interference. Even though many of these devices are Part 15, where they must accept interference from their surrounding environment, it is best to eliminate as much of the possible interference from your shack.

If you do not have a grounding system for your shack, depending on the location of your shack, basement or ground floor, a good ground system can be as simple as a couple of ground rods driven 6 to 8 feet into the soil. When installing your IC-703 to your grounding system, the shortest most direct connection is recommended.

/// **NOTE:** There are many publications covering proper grounding techniques. Check with your local dealer for more information and recommendations.

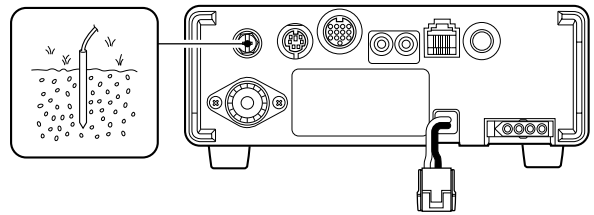

/// **WARNING!** NEVER ground station equipment or antennas to house gas lines. NEVER attach ground lines to plastic (pvc) pipe.

◆ Some Symptoms if inadequate grounding

a. Poor DC Ground

50/60 Hz hum on the audio either Rx or Tx without the antenna connected.

If you feel a tingling sensation when you touch a metal surface. Surfaces such as the cover of your radio or power supply.

b. Poor RF Ground

While transmitting and you feel a tingling sensation when you touch a metal surface. Surfaces such as the cover of your radio or power supply.

While transmitting, you experience interference to other electronic devices, such as the telephone, television or stereo audio systems.

2. Installing your DC Power Supply

The DC power supply is a device used to convert 110/220 V AC, also known as Household current, to a steady source of 13.8 V DC.

The perfect match to your IC-703 is the PS-125. This plug and play unit plugs into the DC power receptacle using an optional OPC-1248 located on the rear of the radio.

Or connect the supplied DC power cable (OPC-1229) to the appropriate color coded terminals, then insert the DC connector into the DC power receptacle located on the rear of the radio.

/// **NOTE:** Although the power supply current requirement is quite low during receiving, this is not the case when you transmit. With many electrical devices in the shack, it is very important to verify the electrical circuit is not overloaded.

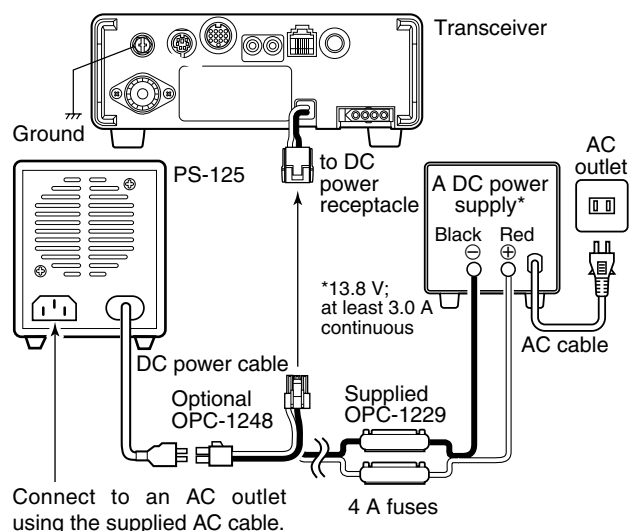

3. Installing lightning protection

Although you may not live in an area with high occurrence for lightning storms, it is always wise to take precautions for lightning or static discharges. Proper lightning protection not only offers protection to the ham gear, but the shack and most importantly the operator.

NOTE: There are many publications covering proper lightning protection, check with your local dealer for more information and recommendations.

4. Installing your antenna system

Whether your IC-703 is your first radio or one of many, one of your key elements in a great shack is the antenna system. There is a connection on the back of your IC-703, for HF and 6 m. If you are using one antenna for HF and 6 m, for simplicity, connect the antenna coax to ANT.

ANTENNA

Connect a HF/50MHz antenna
Impedance: 50Ω

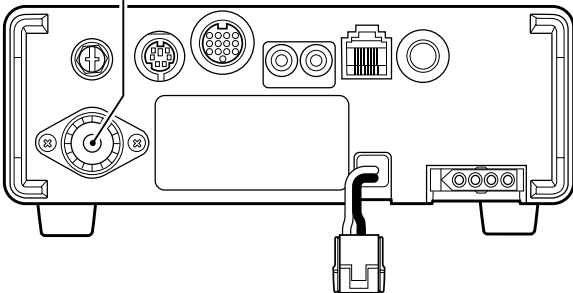
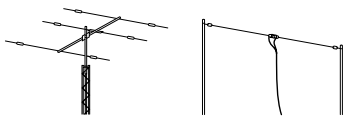

Your IC-703 is equipped with an internal antenna tuner (ATU) for operation on 160–6 m. This ATU is designed to work with an unbalanced 50 Ω feedline. The purpose of the internal antenna tuner is to match the impedance of your antenna system to as close to a 50 Ω load as possible. This ATU will not operate with a long wire or ladder line (450 Ω or other balanced feedlines). An external ATU such as the AH-4 would be necessary for this kind of operation.

Antenna SWR

Each antenna is tuned for a specified frequency range and SWR may be increased out-of-range. When the SWR is higher than approx. 2.0:1, the transceiver's power drops to protect the final transistors. In this case, an antenna tuner is useful to match the transceiver and antenna. Low SWR allows full power for transmitting even when using the antenna tuner. The IC-703 has an SWR meter to monitor the antenna SWR continuously.

PL-259 CONNECTOR INSTALLATION EXAMPLE

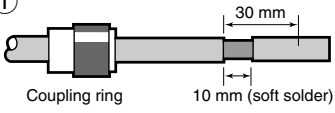
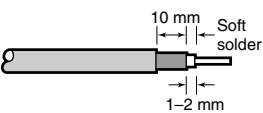
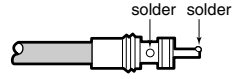
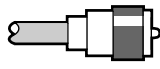
- ①  Slide the coupling ring down. Strip the cable jacket and soft solder.
- ②  Strip the cable as shown at left. Soft solder the center conductor.
- ③  Slide the connector body on and solder it.
- ④  Screw the coupling ring onto the connector body.

30 mm ≈ 9/8 in 10 mm ≈ 3/8 in 1–2 mm ≈ 1/16 in

WARNING: Although a mag mount antenna works great on a vehicle, **DO NOT** use the IC-703 with this type of antenna.

CAUTION: Although your IC-703 has protection to drop down power with a high SWR, this does not completely protect the transceiver from transmission without an antenna. Make sure you have an antenna connected whenever you transmit with your radio.

NOTE: There are many publications covering proper antennas and their installation, check with your local dealer for more information and recommendations.

5. Connect other peripheral equipment

Everyone has his or her favorite ad-on gear; now is the time to connect this gear! We will cover the basic devices that can be connected to your IC-703.

If you do not see the particular item you are wanting to connect, refer to the Advance Connections section starting on page 14.

■ Operation

1. Voice

Microphones: Connect the microphone to the modular-type connector bottom of the front panel or back of the radio.

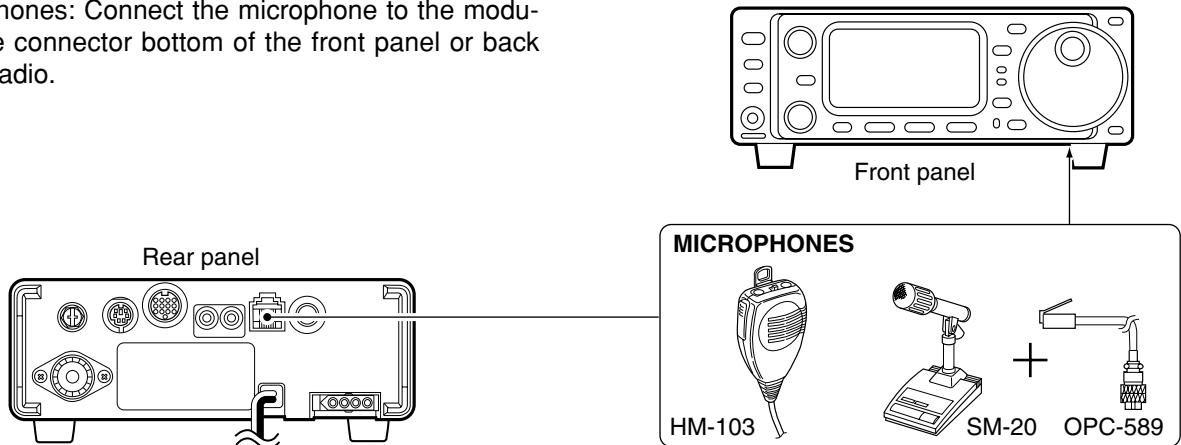

2. CW

CW Key: There are several types of keys or keyers that can be used with your IC-703.

a. Iambic Key paddle: Use a 6.35(d) mm (1/4") stereo plug and connect to the [KEY] jack located on the rear of the radio.

b. Straight Key: Use a 6.35(d) mm (1/4") mono plug and connect key to the back of the radio.

c. External Keyer: Use a 6.35(d) mm (1/4") mono plug and connect to the back of the radio.

d. Computer Keying: Use a 6.35(d) mm (1/4") mono plug and connect to the back of the radio.

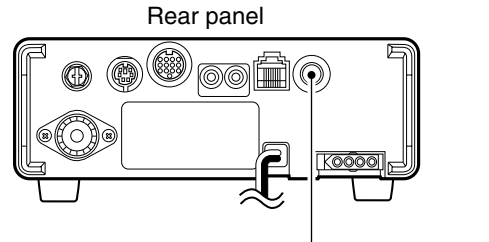
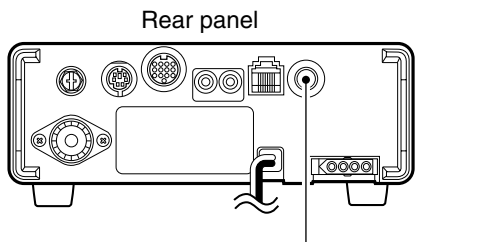

CW KEY
A straight key can be used when the internal electronic keyer is turned OFF in keyer set mode. (p. 32)

When connecting a straight key or else

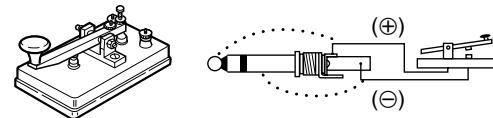

NOTE: You will need to select the type of keyer you are using in the keyer set mode. There are many advanced CW functions in this set mode. Until you have a full understanding of these functions change only the items necessary.

3. Other convenient items

Headphones:

A 3.5(d) mm (1/4") mono jack for operation without using the internal or external speakers. Perfect for operation without disturbing others in the room.

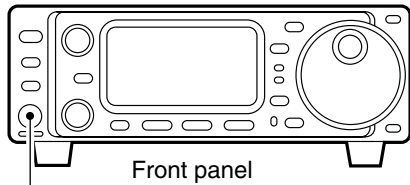

Front panel

HEADPHONES

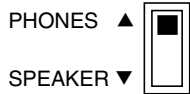

Select 'PHONES' with the [PHONES/SPEAKER] switch on the back of the front panel.

External Speaker:

A 3.5(d) mm (1/8") mono jack for operation with an external speaker. (Input impedance: 8 Ω/Max. input power: 5 W)

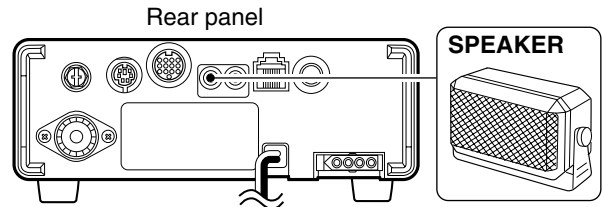

Rear panel

SPEAKER

or

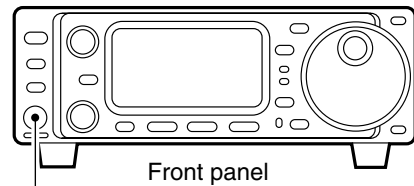

Front panel

SPEAKER

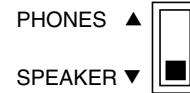
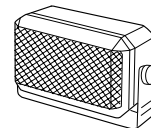

Select 'SPEAKER' with the [PHONES/SPEAKER] switch on the back of the front panel.

■ Your first contact

Now you should have your IC-703 installed in your shack, and like a kid on his birthday, you are probably excited to get on the air. We would like to take you through a few basic operation steps to make your first "On The Air" an enjoyable experience.

◇ Getting started

1. Before powering up your radio, you may want to make sure the following controls are set in the following positions:

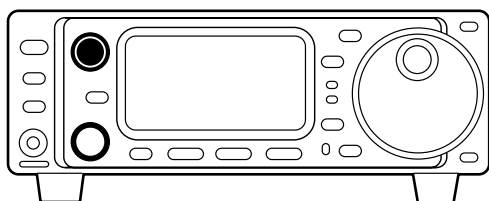

- [AF] : Commonly referred to as the volume: fully counter clockwise.
- [RF/SQL] : The control for the RF Gain and Squelch circuits: 12 o'clock.
- [SHIFT] : Shifts the IF center frequency: 12 o'clock

2. Resetting the CPU: Although you have purchased a brand new radio, some settings may be changed from the factory defaults during the QC process. So your radio can start from Factory Defaults resetting the CPU is necessary. (Refer to p.17)

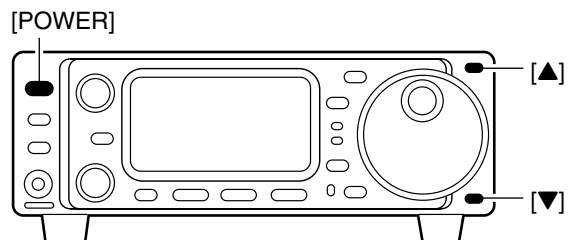

◆ Just listening

1. Select the desired band

On your IC-703, an easy way of changing bands is by using the [(▲)BAND] or [(▼)BAND] located just right corner on the front panel.

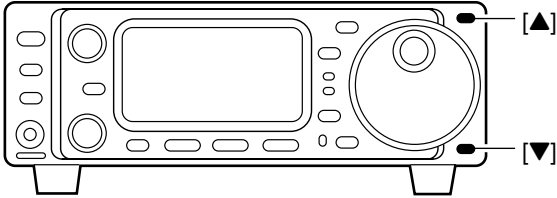

Push [(▲)BAND] or [(▼)BAND] to select the desired band.

• Pushing [(▲)BAND] or [(▼)BAND] continuously scrolls through the available bands.

• Say you want to go to 20 meters or 14 MHz; you would push [(▲)BAND] or [(▼)BAND] several times to select it. This will change the displayed operating frequency to the 20-meter band.

/// **NOTE:** The band stacking register can also be used to select bands. (Refer to p. 22)

2. Tune to the desired frequency

Directly left of the [(▲)BAND]/[(▼)BAND] is the main dial. This will allow you to dial in the frequency you want to operate. You will notice the tuning speed [TS] is 10 Hz resolution. Page 20 will instruct you on how to set the tuning speed [TS] for 1 Hz resolution.

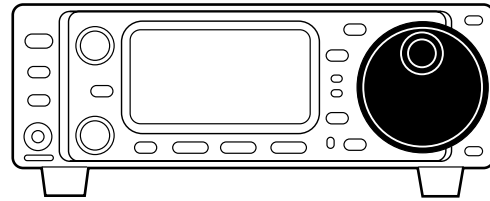

3. Adjust audio output

Adjust this control to a comfortable audio level.

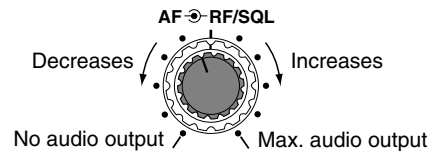
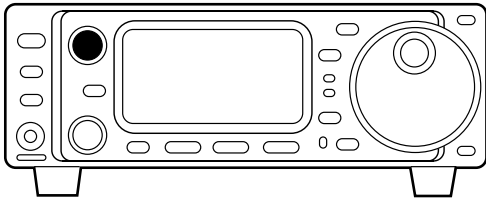

◆ What are you hearing?

Stop and focus on what you are hearing. Do you hear a lot of noise? Is the signal intelligible? Are you set up for the right mode? How about the filters?

1. Verify mode

Although your IC-703 will automatically select USB or LSB in the HF bands, it will not select any of the other modes. You will need to select the proper mode whether CW, RTTY, AM or FM.

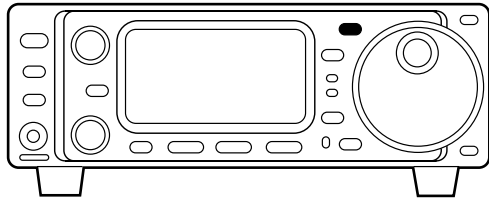

Hint!

The Band Stacking Register will memorize the last frequency used in the band, as well as the Mode, Filter, Tuner and AGC settings. This makes band hopping much easier.

2. Reducing interference (some functions may require an optional unit depending on version)

Your IC-703 has many features to reduce QRM and QRN from the desired signal.

a. Noise Reduction: The noise reduction system on your IC-703 is part of the DSP. This is used to reduce the hiss and QRM levels.

- ① Select S4 (DSP menu).
 - Push [DISPLAY] once or twice to select S.
 - Push [MENU] one or more times to select S4.
- ② Push [(F-2)NR] to activate the noise reduction function.
 - "DSP" and "NR" appear when the function is ON.

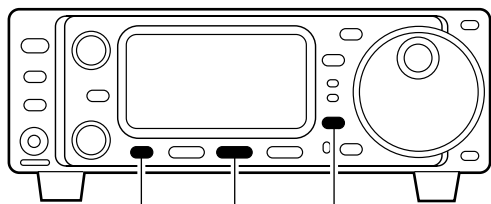

[MENU] [(F-2)] [DISPLAY]

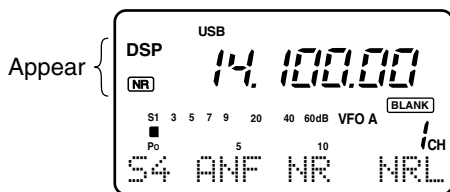

b. Adjusting the Noise Reduction: The noise reduction is completely variable on how much of the DSP Noise Reduction is used.

- ① Push [(F-3)NRL] to indicate the noise reduction level.
- ② Rotate the [M-CH] control to set the noise reduction level.
- ③ Push [(F-3)NRL] to exit the noise reduction level set mode.

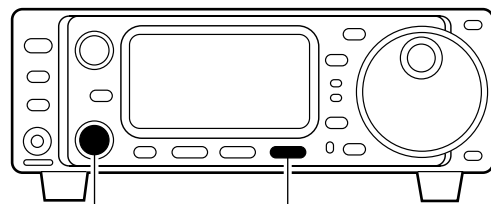

[M-CH] [(F-3)]

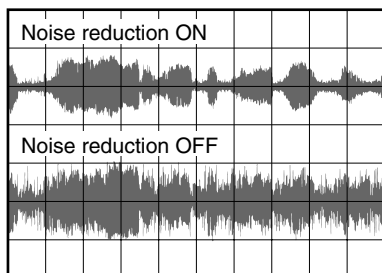
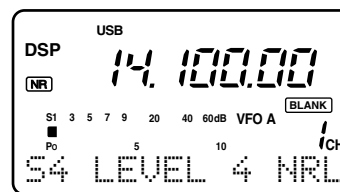

Hint!

How far you advance the NR control will determine how much the noise can be effectively reduced. Adjusting the noise reduction level too high may cause some distortion to occur on the received signal. The noise reduction level should only be set as high as is necessary. Use this setting, along with RF gain, NB (noise blanker, if needed), and IF filters as well, to minimize the effects of noise on the target signal.

c. Automatic Notch: The automatic notch will track up to heterodynes. This is helpful for eliminating annoying transmitter “tune up” tones on any band, and to minimize continuous tone “heterodynes” encountered on the 40 meter phone bands at night, for example. Once selected an icon will appear “ANF” on the display.

- ① Select S4.
 - Push [DISPLAY] once or twice to select S.
 - Push [MENU] one or more times to select S4.
- ② Push [(F-1)ANF] to activate the automatic notch filter.

NOTE: Your IC-703 is equipped with an AGC circuit. This allows the DSP to filter out interfering signals and QRM, while also taking this interference out of the AGC. Bottom line, this will either eliminate or greatly reduce the pumping of the AGC from the interfering signal.

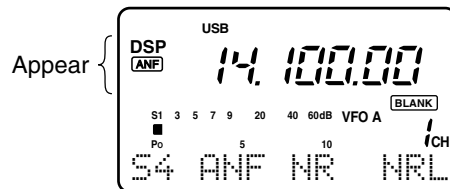
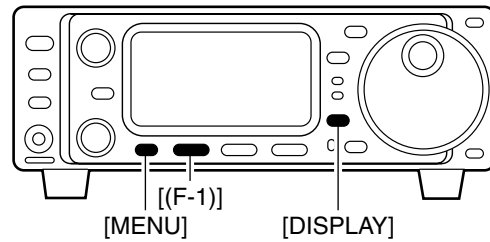

Hint!
The Automatic Notch will not operate in the CW, RTTY or SSB-D modes.

d. Noise Blanker: The noise blanker function reduces pulse-type noise such as that generated by automobile ignition systems. This function is not effective for FM modes or for non pulse-type noise.

- ① Select M3.
 - Push [DISPLAY] once or twice to select M.
 - Push [MENU] one or more times to select M3.
- ② Push [(F-2)NB] to activate the noise blanker.
 - “NB” appears when the function is ON.

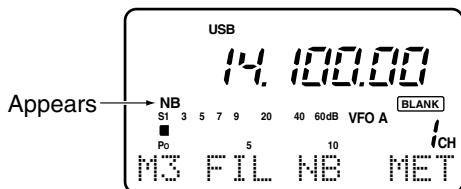
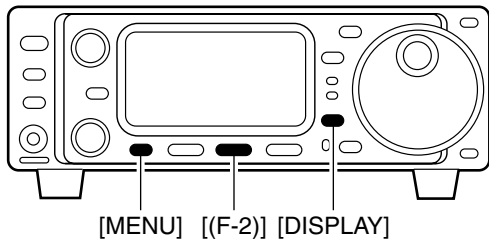

e. Adjusting the Noise Blanker: The noise blanker is completely variable on how much of the Noise Blanker is used.

- ① Push [(F-2)NB] for 1 sec. to enter the noise blanker level set mode.
- ② Rotate the main dial to set the noise blanker level.
- ③ Push [DISPLAY] to exit the noise blanker level set mode.

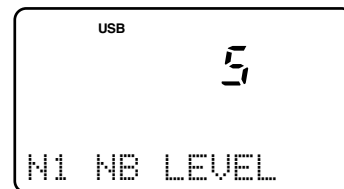
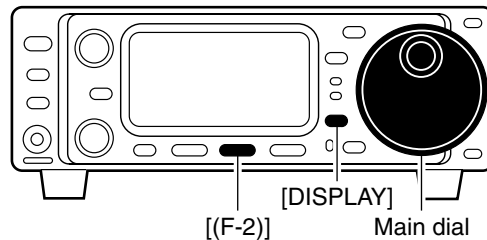

Hint!
When using the noise blanker, received signals may be distorted if the noise blanker level setting has been too high.

f. Filter:

One optional filter can be installed in the IC-703.

Narrow filters help reject interference from adjacent signals and obtain good selectivity.



Wide filters provide improved audio for SSB operation when no interfering signals are present.

Narrow filters for AM/FM modes are standard.

FILTER PRESETTING:

After you install a filter (see p. 87 for installation), you must specify the installed filter in initial set mode (item "22 OPT. FIL"; see p. 79).

FILTER ON/OFF:

- ① Select M3.
 - Push [DISPLAY] once or twice to select M.
 - Push [MENU] one or more times to select M3.
- ② Push [(F-1)FIL] momentarily to select the narrow filter; push for 1 sec. to select the wide filter.
 -  appears when the narrow filter is selected;  appears when the wide filter is selected.

NOTE: When selecting the narrow filter (or wide filter), the graphic passband is changed (see diagram below).

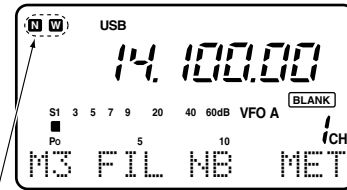
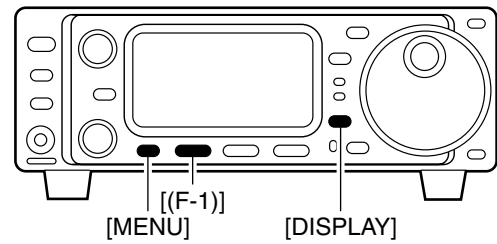
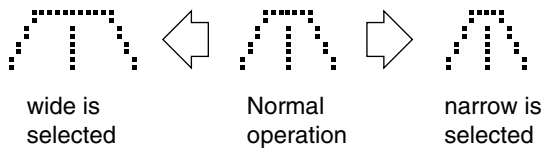

Either these appears when selected

We hope these pointers have been helpful. Now you are ready for the "Ready to call CQ?".

■ Ready to call CQ?

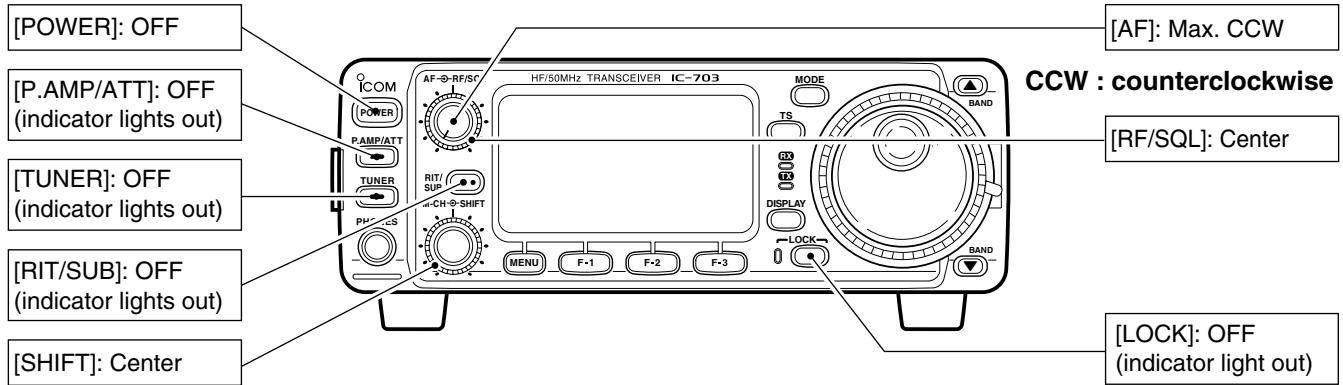

1. Setting up your Mic Gain

Microphone gain must be adjusted properly so that your signal does not distort when transmitted.

- ① Select SSB or another phone mode (AM or FM mode).
- ② Push [DISPLAY] for 1 sec. to select quick set mode.
- ③ Push [MENU] one or more times to select "Q2 MIC GAIN."
 - The ALC meter is selected automatically when operating in SSB mode.
- ④ While speaking into the microphone, rotate the main dial to adjust the microphone gain so that the ALC meter does not peak past the ALC zone.
 - While transmitting at your normal voice level, the ALC meter should read at about the middle of the ALC zone.
 - Be sure the mic gain is in the range of 2 to 5.
- ⑤ Push [DISPLAY] to exit quick set mode.

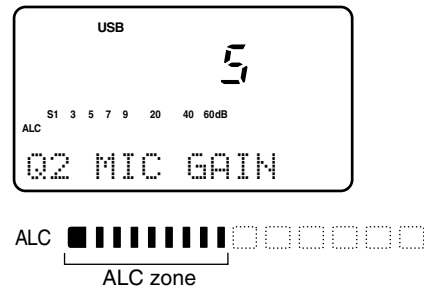
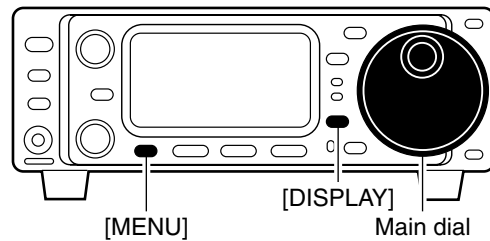

2. Speech compressor

The IC-703 has a built-in, low distortion speech compressor circuit. This circuit increases your average talk power in SSB mode and is especially useful for DX'ing when the receiving station is having difficulty copying your signal.

- ① Select USB or LSB mode.
- ② Select the ALC meter.
 - Push [DISPLAY] once or twice to select M.
 - Push [MENU] one or more times to select M3, then push [(F-3)MET] one or more times to select "ALC."
- ③ Select M4.
 - Push [MENU] one more time to select M4.
- ④ Push [(F-2)COM] to turn the speech compressor function ON.
 - "COM" appears.
- ⑤ Push [(F-2)COM] for 1 sec. to enter the compression level set mode (p. 54).
- ⑥ Rotate the main dial to set the speech compression level.

NOTE: When the ALC meter peaks at light the ALC zone, your transmitted voice may be distorted.

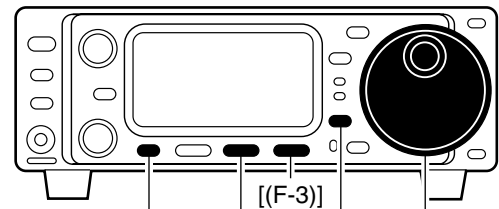

[MENU] [(F-2)] [(F-3)] Main dial

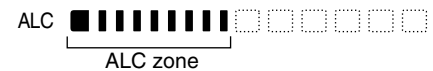
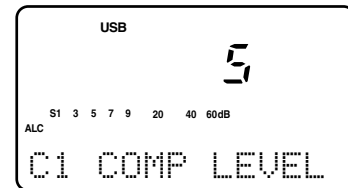

Hint!

Voice patterns and audio characteristics vary with each operator, therefore the Microphone gain, speech compression settings will be different for each operator. Actual on air experimenting is necessary to get just the right sound. It's best to test and adjust your audio on the air, while someone who knows what your real voice sounds like listens, and provides an opinion on your audio quality.

Verify you have selected a clear frequency and call out your CQ!

■ Front panel

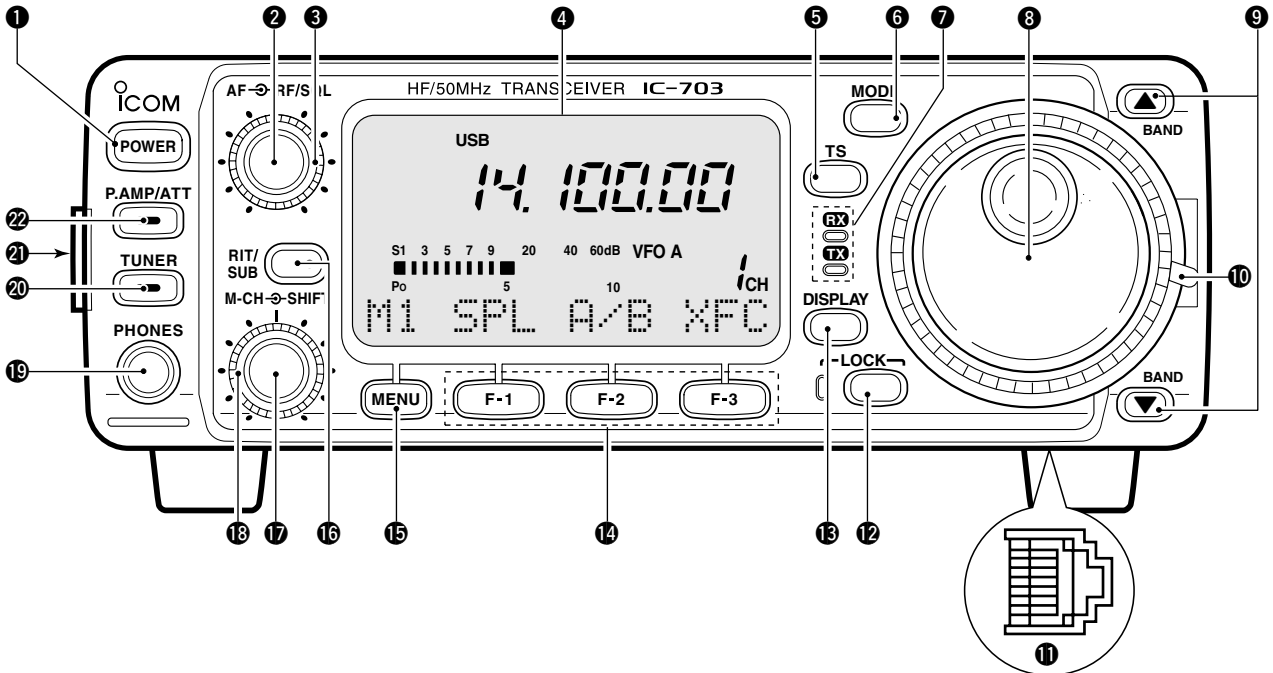

- 1 POWER SWITCH [POWER]** (p. 17)
 - ➔ While transceiver's power is OFF: Push to turn power ON.
 - Turn the DC power supply ON in advance.
 - ➔ While transceiver's power is ON:
 - Push momentarily to indicate the connected power supply voltage.
 - Push for 1 sec. to turn power OFF.

- 2 AF GAIN CONTROL [AF]** (inner control; p. 17)

Varies the audio output level from the speaker.

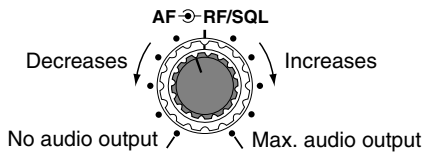

- 3 RF GAIN CONTROL/SQUELCH CONTROL [RF/SQL]** (outer control; p. 24)

Adjusts the RF gain and squelch threshold level. The squelch removes noise output from the speaker (closed condition) when no signal is received.

 - The squelch is particularly effective for FM. It is also available for other modes.
 - 12 to 13 o'clock position is recommended for any setting of the [RF/SQL] control.
 - The control can be set as 'Auto' (RF gain control in SSB, CW and RTTY; squelch control in AM and FM) or squelch control (RF gain is fixed at maximum) in initial set mode as follows. (p. 79)

MODE	SET MODE SETTING		
	AUTO	SQL	RF GAIN + SQL
SSB, CW RTTY	RF GAIN	SQL	RF GAIN + SQL
AM, FM	SQL	SQL	RF GAIN + SQL

• When setting as RF gain/squelch control

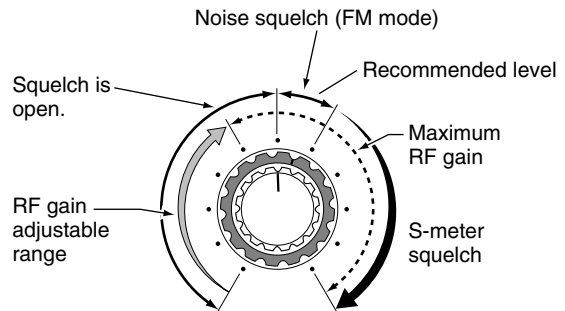

• When functioning as RF gain control (Squelch is fixed open; SSB, CW, RTTY only)

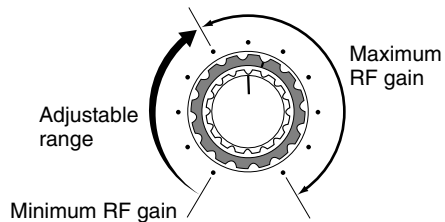

• When functioning as squelch control (RF gain is fixed at maximum.)

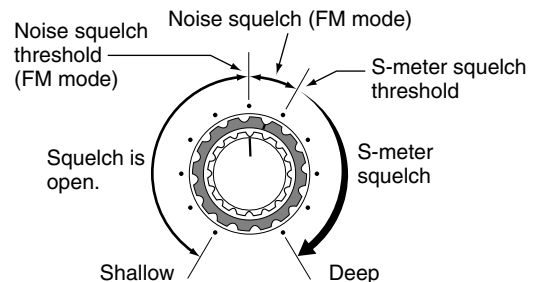

4 FUNCTION DISPLAY

Shows the operating frequency, dot matrix indications, selected memory channel, etc. See p. 9 for details.

5 TUNING STEP SWITCH [TS] (pgs. 19–21)

- ➔ While in SSB/CW/RTTY modes, push momentarily to turn the programmable tuning step ON and OFF. While in FM/AM mode push momentarily to toggle the programmable tuning step and 1 MHz quick tuning step.
- While the programmable tuning step indicator is displayed, the frequency can be changed in programmed kHz steps.

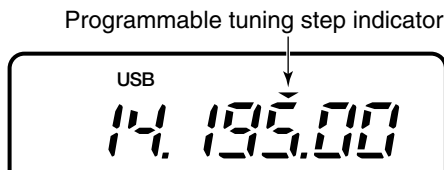

- 0.01 (FM/AM mode only), 0.1, 1, 5, 9, 10, 12.5, 20, 25 and 100 kHz tuning steps are available.
- 1 MHz quick tuning step are only available in FM and AM modes.
- ➔ While the programmable tuning step is OFF, turns the 1 Hz step ON and OFF when pushed for 1 sec.
 - 1 and 10 Hz steps are only available in SSB, CW and RTTY modes.
 - 1 Hz indication appears, and the frequency can be changed in 1 Hz steps.
- ➔ While the programmable tuning step is ON, enters the tuning step selection mode when pushed for 1 sec.

6 MODE SWITCH [MODE] (p. 23)

- ➔ Push momentarily to cycle through the operating modes:
USB/LSB ▶ CW ▶ RTTY/SSB-D ▶ FM/AM
- ➔ Push for 1 sec. to toggle the following operating modes:
USB ↔ LSB
CW ↔ Memory keyer mode
RTTY ↔ SSB-D (SSB data mode)
FM ↔ AM

7 RECEIVE/TRANSMIT INDICATORS [RX]/[TX]

- ➔ [RX]: Lights green while receiving a signal and when squelch is open.
- ➔ [TX]: Lights red while transmitting.

8 MAIN DIAL

Changes the displayed frequency, sets the values of selected initial set mode items, etc.

9 UP/DOWN (BAND) SWITCHES [▲/▼(BAND)]

- ➔ Push momentarily to select a band.
 - Can also be used to advance or back the quick set mode items, initial set mode items, etc.
- ➔ Push and hold to scroll through the bands continuously.

10 MAIN DIAL TENSION LATCH

Selects the main dial tension.
• 2 positions are available.

11 MICROPHONE CONNECTOR (p. 10)

Modular-type microphone connector—Accepts the supplied microphone (HM-103).
• The optional OPC-589 can be used to connect an 8-pin microphone such as the SM-8 or SM-20, if desired.
• A microphone connector is also available on the rear panel. DO NOT connect 2 microphones simultaneously.

12 LOCK SWITCH [LOCK]

- ➔ Push momentarily to toggle the dial lock function ON and OFF.
 - The dial lock function electronically locks the main dial.
- ➔ When the optional UT-102 VOICE SYNTHESIZER UNIT is installed (p. 86), push for 1 sec. to have the frequency, etc. announced.
 - UT-102 operation can be adjusted in the initial set mode (p. 82).



Lights while the lock function is activated.

13 DISPLAY SWITCH [DISPLAY] (p. 94)

- ➔ Push momentarily to select one of the three menu sets: M1 to M4, S1 to S4 and G1 to G4.
- ➔ Push for 1 sec. to enter the quick set mode.

14 MULTI-FUNCTION SWITCHES [F1] / [F2] / [F3]

- ➔ Push to select the function indicated in the dot matrix display above these switches. (pgs. 4–6, 94)
 - Functions vary depending on the menu set selected.
- ➔ Push to edit a character for memory keyer programming or memory name. (pgs. 35, 59)

15 MENU SWITCH [MENU] (p. 94)

- ➔ Push this switch one or more times to select menus within a menu set (M, S or G), or push to advance through the quick set mode and initial set mode displays.
- ➔ Push for 1 sec. to jump between two different function menu sets.

1 PANEL DESCRIPTION

16 RIT/SUB DIAL SWITCH [RIT/SUB] (pgs. 21, 47)

- ➔ Push to toggle the RIT or SUB DIAL function ON and OFF—initial set mode is used to select the desired action*.
 - Lights green when the SUB DIAL function is ON; lights red when the RIT function is ON.
 - Use the [M-CH] control to vary the RIT frequency or SUB DIAL frequency (see below).
- ➔ When the RIT function is ON, push for 1 sec. to add or subtract the shifted frequency to the operating frequency.



Lights red while the RIT function is activated; green while the SUB DIAL function is activated.

*Even if RIT is selected in initial set mode, RIT cannot be selected when operating AM or FM modes.

✓ What is the RIT function?

The RIT (Receiver Incremental Tuning) shifts the receive frequency without shifting the transmit frequency.

This is useful for fine tuning stations calling you on an off-frequency or when you prefer to listen to slightly different-sounding voice characteristics, etc.

17 SHIFT CONTROL [SHIFT] (outer control; p. 47)

Shifts the center frequency of the receiver's IF passband.

- Rotate the control clockwise to shift the center frequency higher, or rotate the control counterclockwise to shift the center frequency lower.
- When rotate the control, the IF passband is graphically displayed and changes in accordance with the [SHIFT] control.

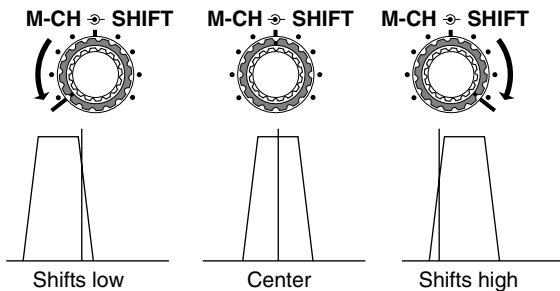

18 M-CH CONTROL [M-CH] (inner control)

- ➔ When the RIT or SUB DIAL functions are OFF, rotate to select a memory channel number (p. 56).
- ➔ Shifts the receive frequency while the RIT function is ON in SSB, CW and RTTY modes (see above or p. 47).
 - RIT variable range is ± 9.99 kHz
- ➔ Changes the operating frequency in the selected tuning steps while the SUB DIAL function is ON (p. 21).

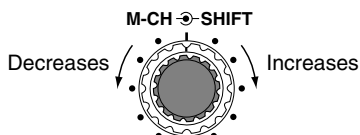

19 HEADPHONE JACK [PHONES] (p. 14)

Accepts headphones with 8–16 Ω impedance.

- When headphones are connected, no receive audio comes from the speaker.
- When the PHONES/SPEAKER switch on the back of the front panel is set to the [SPEAKER] position, an external speaker can be connected. This is convenient for mobile or outdoor operation.

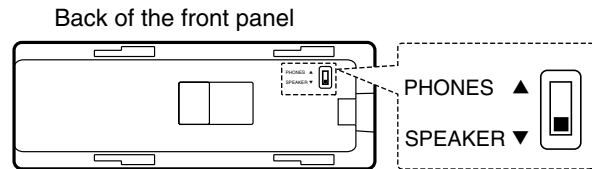

20 TUNER SWITCH [TUNER] (pgs. 64–66)

- ➔ Push momentarily to toggle the automatic antenna tuner function ON and OFF (bypass).
 - Lights red when the automatic antenna function is ON.
- ➔ Push this switch for 1 sec. to manually tune the antenna.
 - When the tuner cannot tune the antenna, the tuning circuit is bypassed automatically after 20 sec.

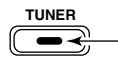

Lights while the automatic tuning function is activated.

21 FRONT PANEL LATCH (p. 12)

Pull away from the transceiver (towards yourself when looking at the front of the transceiver) to detach the front panel from the main body of the transceiver.

22 PRE AMP/ATTENUATOR SWITCH [P.AMP/ATT] (p. 46)

- ➔ Push momentarily to turn the preamp ON or OFF.
- ➔ Push for 1 sec. to turn the 20 dB attenuator ON; push momentarily to turn the attenuator OFF.
 - Lights green when the preamp is ON; lights red when the 20 dB attenuator is ON.



Lights green while the preamp is activated; lights red while the attenuator is activated.

✓ What is the preamp?

The preamp amplifies received signals in the front end circuit to improve the S/N ratio and sensitivity. Turn ON 'P.AMP' when receiving weak signals.

✓ What is the attenuator?

The attenuator prevents a desired signal from distorting when very strong signals are near the desired frequency, or when very strong electric fields, such as from a broadcasting station, are near your location.

Multi-function switches

◇ M1 functions

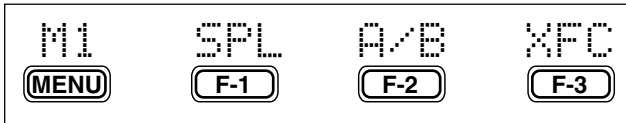

SPLIT OPERATION (p. 30)



- Push momentarily to toggle the split function ON and OFF. (p. 51)
 - “SPL” appears when the split function is ON.
- Push for 1 sec. to turn the quick split function ON. (p. 52)
 - The offset frequency must be programmed in advance using initial set mode. (p. 80)
 - The offset frequency is shifted from the displayed frequency.
 - The quick split function can be turned OFF using initial set mode. (p. 79)

VFO A/B SELECTION



- Push momentarily to toggle VFO A and VFO B in VFO mode. (p. 18)
- Push momentarily to toggle the transmission VFO and reception VFO during split operation. (p. 51)
- Push momentarily to toggle the transmit and receive frequencies (and modes) of memory channels when the split function is turned ON.
- Push for 1 sec. to equalize the frequency and operating mode of the two VFO's.
 - The rear (undisplayed) frequency and operating mode are equalized to the front (displayed) VFO frequency and operating mode.

TRANSMIT FREQUENCY CHECK (p. 51)



- Monitors the transmit frequency when pushed and held.
- While pushing this switch, the transmit frequency can be changed with the main dial.

◇ M2 functions

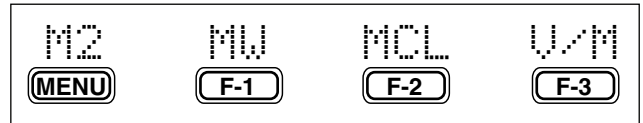

MEMORY WRITE (p. 57)



- Push for 1 sec. to store the selected read-out frequency and operating mode into the displayed memory channel.

MEMORY CLEAR (p. 58)



- Push for 1 sec. to clear the selected read-out memory channel contents.
 - “BLANK” appears.
 - This switch does not function in VFO mode.

VFO/MEMORY



- Push momentarily to toggle between VFO and memory modes. (p. 56)
- Push for 1 sec. to transfer the frequency and operating mode in the selected memory channel to a VFO. (p. 58)

◇ M3 functions

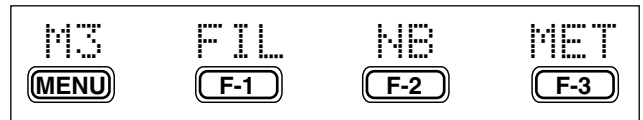

FILTER SELECTION (p. 49)



- Push to toggle the narrow filter (or wide filter—push for 1 sec.) ON and OFF.
 - “N” appears when the narrow filter is ON; “W” appears when the wide filter is ON.
 - An optional filter installation and presetting in initial set mode (p. 79) is necessary to use the following:
 - CW/RTTY narrow: FL-52A or FL-53A
 - SSB narrow: FL-222
 - SSB wide: FL-257

NOISE BLANKER (p. 48)



- Push momentarily to toggle the noise blanker ON and OFF.
 - “NB” appears when the noise blanker function is ON.
 - The noise blanker does not function in FM mode; “30 AM NB” item (p. 80) in initial set mode must be set to ON for the noise blanker to work in AM mode.
- Push for 1 sec. to enter the noise blanker level set mode.
 - The noise blanker level can be set in noise blanker level set mode (p. 46).

METER SELECTION (p. 52)

MET (F-3) Selects the type of meter displayed (during transmit) in the function display.

- Power, ALC or SWR metering can be selected.
- Only an S-meter is available for receive.

◇ M4 functions

DURING SSB/AM OPERATION:

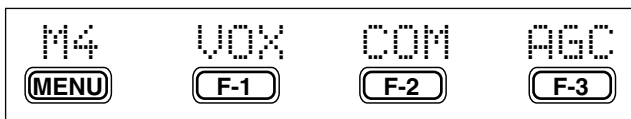

DURING CW OPERATION:

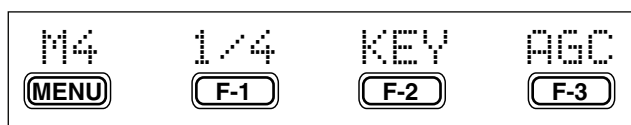

DURING RTTY OPERATION:

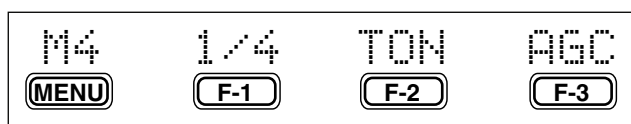

DURING SSB-D OPERATION:

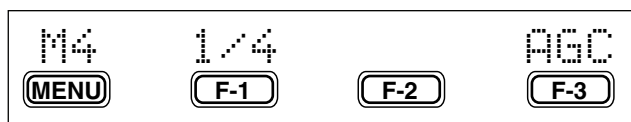

DURING FM OPERATION:

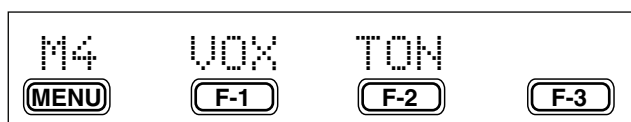

VOX FUNCTION (p. 53)

VOX (F-1) ➔ Push momentarily to toggle the VOX function ON and OFF.

- “VOX” appears when the VOX function is ON.
- ➔ Push for 1 sec. to enter the VOX set mode.
- The VOX delay, VOX gain and ANTI-VOX can be set in VOX set mode.

✓ What is the VOX function?

The VOX function (voice operated transmission) starts transmission without pushing the PTT switch when you speak into the microphone; then, automatically returns to receive when you stop speaking.

SPEECH COMPRESSOR (p. 54)

COM (F-2) ➔ Push momentarily to toggle the speech compressor ON and OFF.

- “COM” appears when the speech compressor is ON.
- ➔ Push for 1 sec. to enter the compression level set mode.
- The COMP gain can be set in compression level set mode.

AGC (p. 48)

AGC (F-3) Push to change the time constant of the AGC circuit.

- “FAGC” appears when the fast time constant is selected.

1/4 FUNCTION

1/4 (F-1) Push to toggle the 1/4 tuning function ON and OFF.

- When the 1/4 function is ON, a bar appears under the 1/4 indication and fine tuning can be used.

KEYER SET MODE (p. 32)

KEY (F-2) Push for 1 sec. to enter the keyer set mode.

- The break-in setting, break-in delay time, CW pitch, CW paddle type and dot/dash ratio can be set in the keyer set mode.

✓ What is the break-in function?

Full break-in (QSK) activates the receiver between transmitted dots and dashes. This is useful when operating in nets, or during DX pileups and during contests, when “fast exchanges” are common.

RTTY TONE SET MODE (p. 40)

TON (F-2) ➔ Push for 1 sec. to enter the RTTY tone set mode.

- The RTTY tone frequency, RTTY shift frequency and RTTY keying polarity can be set in RTTY tone set mode.

FM TONE OPERATION

TON (F-2) ➔ Push momentarily to select the subaudible tone encoder for repeater use, tone squelch function and OFF. (pgs. 43–45)

- “T” appears when the repeater tone function is ON. (pgs. 43, 45)
- “TSQL” appears when the tone squelch function is ON. (p. 43)
- ➔ Push for 1 sec. to enter the FM tone set mode. (p. 44)
- The repeater tone frequency, tone squelch frequency can be set in FM tone set mode.

◇ S1 functions

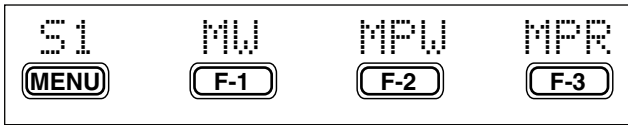

MEMORY WRITE (p. 57)

MW (F-1) Push for 1 sec. to store the selected readout frequency and operating mode into the displayed memory channel.

MEMO PAD WRITE (p. 60)

MPW (F-2) Push to store the the selected readout frequency and operating mode into a memo pad.

MEMO PAD READ (p. 60)

MPR (F-3) Push to call up a memo pad.

◇ S2 functions

DURING VFO MODE:

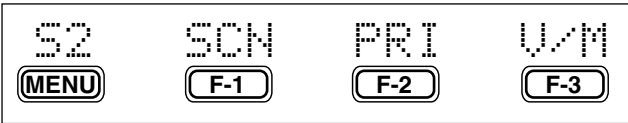

DURING MEMORY MODE:

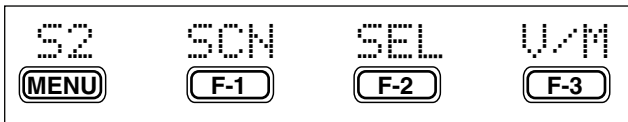

SCAN (pgs. 61–63)

SCN (F-1) Push to start or stop the scan function.

PRIORITY WATCH (p. 63)

PRI (F-2) Push to start or stop the priority watch.

VFO/MEMORY

V/M (F-3) ➤ Push momentarily to toggle between VFO and memory modes. (p. 56)
 ➤ Push for 1 sec. to transfer the frequency and operating mode in the selected memory channel to a VFO. (p. 58)

SELECT SCAN (p. 61)

SEL (F-2) Push to toggle the select setting ON and OFF for the selected memory channel.

◇ S3 functions

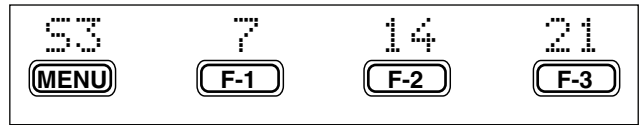

QUICK BAND CHANGE FUNCTION (p. 22)

This item provides access to the band stacking register. By default the 7, 14 and 21 MHz bands are displayed. Push [F-1], [F-2] or [F-3] for 1 sec. to select a new band if desired.

•A mode is memorized along with the frequency for each band.

◇ S4 functions

(UT-106 is required for some version)

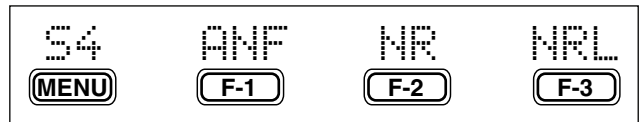

AUTOMATIC NOTCH FILTER (p. 50)

ANF (F-1) This function automatically attenuates beat tones, tuning signals, etc., even if they are moving.

NOISE REDUCTION (p. 50)

NR (F-2) This function reduces noise components and picks out desired signals which are buried in the noise.

NOISE REDUCTION LEVEL DISPLAY (p. 50)

NRL (F-3) This switch displays the noise reduction level when pushed.

■ Rear panel

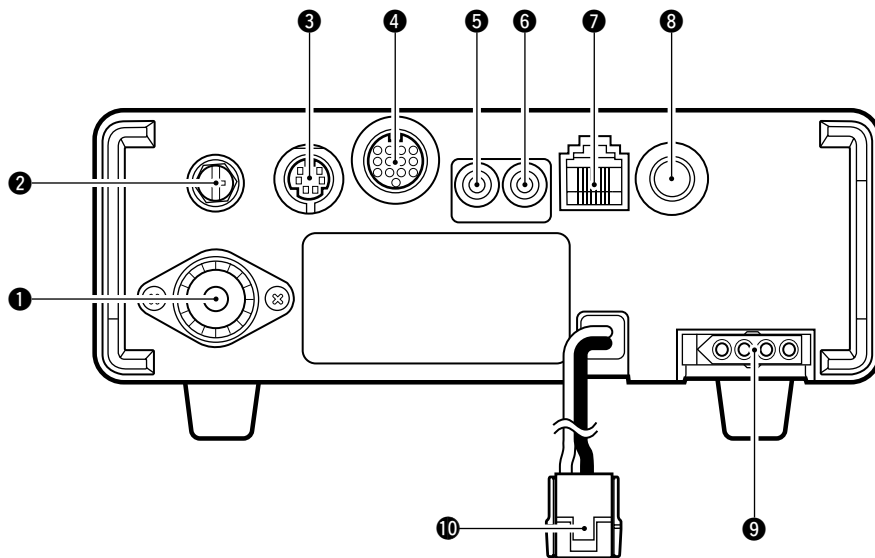

- 1 ANTENNA CONNECTOR [ANT]** (p. 13)
Accepts a 50 Ω antenna with a PL-259 connector.
- 2 GROUND TERMINAL [GND]** (p. 11)
Connect this terminal to a ground to prevent electrical shocks, TVI, BCI and other problems.
- 3 DATA SOCKET [DATA]** (pgs. 8, 14)
6-pin min DIN socket to connect a TNC (Terminal Node Controller), etc. for packet operation.
• See page at right for socket information.
- 4 ACCESSORY SOCKET [ACC]** (pgs. 8, 14)
Enables connection to external equipment such as a TNC for data communications, a linear amplifier or an automatic antenna selector/tuner, etc.
• See page at right for socket information.
- 5 EXTERNAL SPEAKER JACK [EXT SP]** (p. 14)
Accepts a 4–8 Ω speaker.
- 6 CI-V REMOTE CONTROL JACK [REMOTE]** (p. 71)
➔ Designed for use with a personal computer for remote control of the transceiver functions.
➔ Used for transceiver operation with another Icom CI-V transceiver or receiver.
- 7 MICROPHONE CONNECTOR [MIC]** (p. 13)
Accepts the supplied microphone (connected in parallel with the front panel's [MIC] connector).
• See p. 2 for microphone notes.
• See p. 10 for microphone connector information.

- 8 ELECTRONIC KEYS JACK [KEY]** (p. 28)
Accepts a paddle to activate the internal electronic keyer.
• Selection between the internal electronic keyer and straight key operation can be made in keyer set mode. (p. 32)

When connecting a straight key

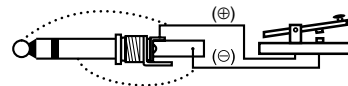

When connecting a paddle

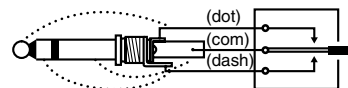

▨ If you use an external electronic keyer, make sure the voltage retained by the keyer is less than 0.4 V when the key is ON.

- 9 TUNER CONTROL SOCKET [TUNER]** (p. 14)
Accepts the control cable from an optional AH-4 HF/50 MHz AUTOMATIC ANTENNA TUNER.
- 10 DC POWER SOCKET [DC13.8V]** (p. 15)
Accepts 9.0–15.87 V DC through the supplied DC power cable.

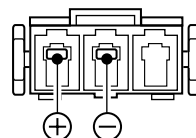

▨ **NOTE: DO NOT** use a cigarette lighter socket as a power source when operating in a vehicle. The plug may cause voltage drops and ignition noise may be superimposed onto transmit or receive audio.

◇ DATA socket

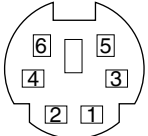
DATA	PIN No.	NAME	DESCRIPTION
 <p>Rear panel view</p>	1	DATA IN	Input terminal for data transmit. (1200 bps: AFSK/9600 bps: G3RUH, GMSK)
	2	GND	Common ground for DATA IN, DATA OUT and AF OUT.
	3	PTT P	PTT terminal for packet operation. Connect ground to transmit data.
	4	DATA OUT	Data out terminal for 9600 bps operation only.
	5	AF OUT	Data out terminal for 1200 bps operation only.
	6	SQ	Squelch out terminal. Becomes ground level when the transceiver receives a signal which opens the squelch. •To avoid unnecessary TNC transmission, connect squelch to the TNC to inhibit transmission when receiving signals. •Keep audio output at a normal level, otherwise a "SQ" signal will not be output.

◇ ACC socket

ACC	PIN No.	NAME	DESCRIPTION	SPECIFICATIONS
 <p>Rear panel view</p> <p>① brown ⑧ gray ② red ⑨ white ③ orange ⑩ black ④ yellow ⑪ pink ⑤ green ⑫ light blue ⑥ blue ⑬ light green ⑦ purple</p>	1	8 V	Regulated 8 V output.	Output voltage : 8 V ±0.3 V Output current : Less than 10 mA
	2	GND	Connects to ground.	—
	3	HSEND	Input/output pin. (HF/50 MHz only) Goes to ground when transmitting. When grounded, transmits.	Ground level : -0.5 V to 0.8 V Output current : Less than 20 mA Input current (Tx) : Less than 200 mA
	4	BDT	Data line for the optional AT-180.	—
	5	BAND	Band voltage output. (Varies with amateur band)	Output voltage : 0 to 8.0 V
	6	ALC	ALC voltage input.	Control voltage : -4 V to 0 V Input impedance : More than 10 kΩ
	7	NC	—	—
	8	13.8 V	13.8 V output when power is ON.	Output current : Max. 1 A
	9	TKEY	Key line for the optional AT-180.	—
	10	FSKK	Controls RTTY keying	"High" level : More than 2.4 V "Low" level : Less than 0.6 V Output current : Less than 2 mA
	11	MOD	Modulator input. Connects to a modulator.	Input impedance : 10 kΩ Input level : Approx. 100 mV rms
	12	AF	AF detector output. Fixed, regardless of [AF] position in default settings.	Output impedance : 4.7 kΩ Output level : 100–300 mV rms
	13	SQLS	Squelch output. Goes to ground when squelch opens.	SQL open : Less than 0.3 V/5 mA SQL closed : More than 6.0 V/100 μA

Color refers to the cable strands of the supplied cable.

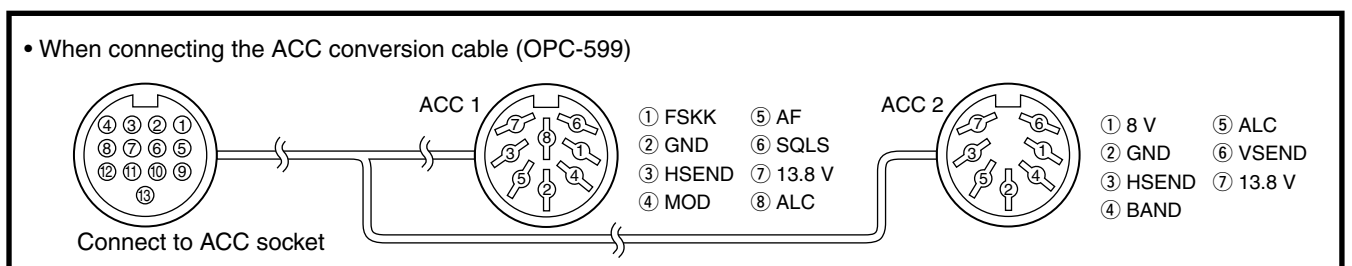

■ Function display

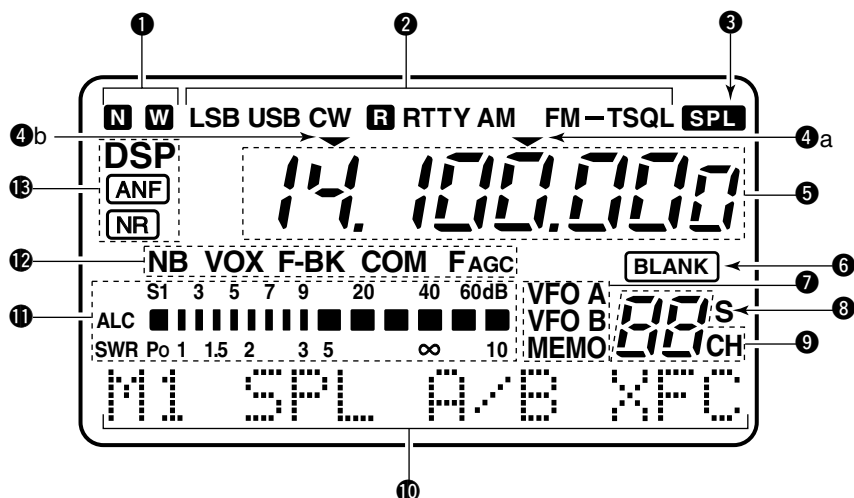

❶ NARROW/WIDE FILTER INDICATORS

- ➔ “N” appears when selecting AM narrow or FM narrow modes.
- ➔ When installing an optional narrow filter, narrow mode can be selected in CW, RTTY and SSB modes.
- When the SSB wide filter is installed, “W” appears during wide mode selection.

❷ MODE INDICATORS

- Show the selected operating mode.
- “R” appears when CW reverse or RTTY reverse mode is selected.

❸ SPLIT INDICATOR

Appears during split operation.

❹ PROGRAMMABLE/1 MHz TUNING STEP INDICATORS

- ➔ ❹a appears when the programmable tuning step is selected.
- ➔ ❹b appears when the 1 MHz quick tuning step is selected.

❺ FREQUENCY READOUT

Shows the operating frequency.

❻ BLANK MEMORY INDICATOR

- Appears when the displayed memory channel is not programmed (blank channel).
- This indicator appears both in VFO and memory modes.

❼ VFO/MEMORY INDICATORS

- ➔ VFO A or B appears when VFO mode is selected; MEMO appears when memory mode is selected.

❽ SELECT MEMORY CHANNEL INDICATOR

Appears when the selected memory channel is set as a select memory channel.

❾ MEMORY CHANNEL READOUT

Shows the selected memory channel.

❿ DOT MATRIX INDICATORS

These alphanumeric readouts show a variety of information such as current functions of the “F” keys [F1] to [F3], memory channel names, set mode items, etc. See p. 94 for an overview of these indicators.

⓫ METER READOUTS

- ➔ Shows receiving signal strength while receiving.
- ➔ Shows one of transmit power meter, ALC or SWR meter while transmitting.

⓬ FUNCTION INDICATORS

- ➔ “NB” appears when the noise blanker is activated.
- ➔ “VOX” appears when the VOX function is selected.
- ➔ “F-BK” appears when full break-in operation is selected and only “BK” appears when semi break-in operation is selected.
- ➔ “COM” appears when the speech compressor is activated.
- ➔ “FAGC” appears when the fast AGC function is selected.

⓭ DSP INDICATORS

Appear when the (optional*) DSP unit UT-106 is (installed and) activated.

* UT-106 DSP unit is optional for some version.

■ Microphone (HM-103)

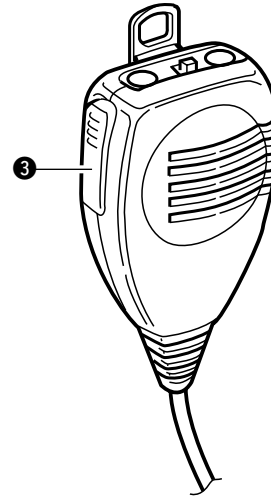
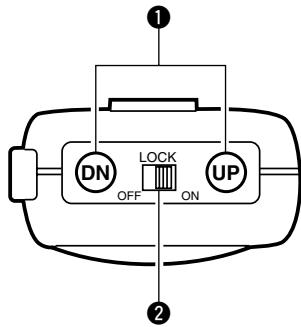

① UP/DOWN SWITCHES [UP]/[DN]

Change the operating frequency.

- Push and hold to change the frequency continuously.
- Tuning step is 50 Hz when no TS indicator appears.

② LOCK SWITCH [LOCK]

Locks the [UP]/[DN] switches.

③ PTT SWITCH [PTT]

Push and hold to transmit; release to receive.

TECHNICAL INFORMATION

• MICROPHONE CONNECTOR

Rear panel view

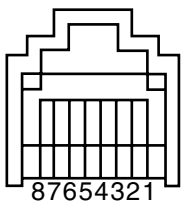

PIN NO.	FUNCTION	DESCRIPTION
1	+8 V DC output	Max. 10 mA
2	Frequency up	Ground
	Frequency down	Ground through 470 Ω
8	Squelch open	"LOW" level
	Squelch closed	"HIGH" level

- ① +8 V DC output
- ② Frequency up/down
- ③ AF output
- ④ PTT
- ⑤ GND (Microphone ground)
- ⑥ Microphone input
- ⑦ GND
- ⑧ Squelch switch

CAUTION: DO NOT short pin 1 to ground as this can damage the internal 8 V regulator.

• HM-103 SCHEMATIC DIAGRAM

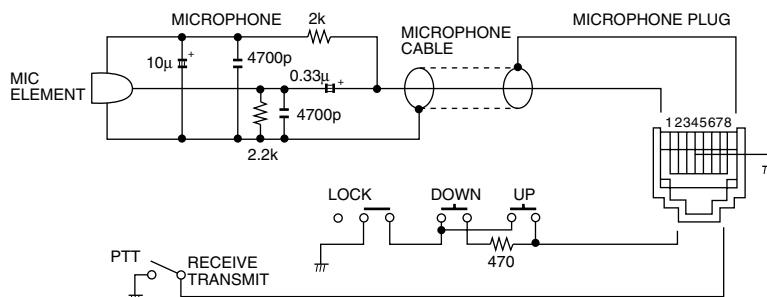

■ Unpacking

After unpacking, immediately report any damage to the delivering carrier or dealer. Keep the shipping cartons.

For a description and a diagram of accessory equipment included with the IC-703, see 'Supplied accessories' on p. ii of this manual.

■ Selecting a location

Select a location for the transceiver that allows adequate air circulation, free from extreme heat, cold, or vibrations, and away from TV sets, TV antenna elements, radios and other electromagnetic sources.

The base of the transceiver has an adjustable stand for desktop use. Set the stand to one of two angles depending on your operating conditions. (see description at right page)

■ Grounding

To prevent electrical shock, television interference (TVI), broadcast interference (BCI) and other problems, ground the transceiver through the GROUND terminal on the rear panel.

For best results, connect a heavy gauge wire or strap to a long earth-sunk copper rod. Make the distance between the [GND] terminal and ground as short as possible.

⚠ WARNING: NEVER connect the [GND] terminal to a gas or electric pipe, since the connection could cause an explosion or electric shock.

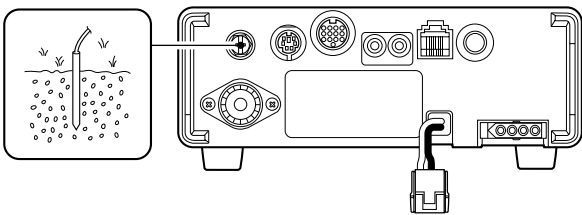

■ Antenna connection

For radio communications, the antenna is of critical importance, along with output power and sensitivity. Select antenna(s), such as a well-matched 50 Ω antenna, and feedline. 1.5:1 or better of Voltage Standing Wave Ratio (VSWR) is recommended for your desired band. Of course, the transmission line should be a coaxial cable.

⚠ CAUTION: Protect your transceiver from lightning by using a lightning arrester.

PL-259 CONNECTOR INSTALLATION EXAMPLE

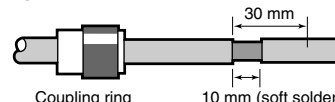
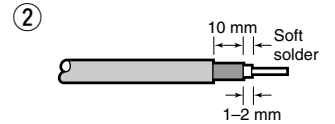
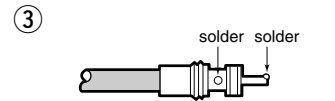
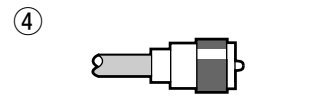
- ①  Slide the coupling ring down. Strip the cable jacket and soft solder.
- ②  Strip the cable as shown at left. Soft solder the center conductor.
- ③  Slide the connector body on and solder it.
- ④  Screw the coupling ring onto the connector body.

ANTENNA SWR

Each antenna is tuned for a specified frequency range and SWR may be increased out-of-range. When the SWR is higher than approx. 2.0:1, the transceiver's power drops to protect the final transistors. In this case, an antenna tuner is useful to match the transceiver and antenna. Low SWR allows full power for transmitting even when using the antenna tuner. The IC-703 has an SWR meter to monitor the antenna SWR continuously.

■ Installation

◇ Single body mounting

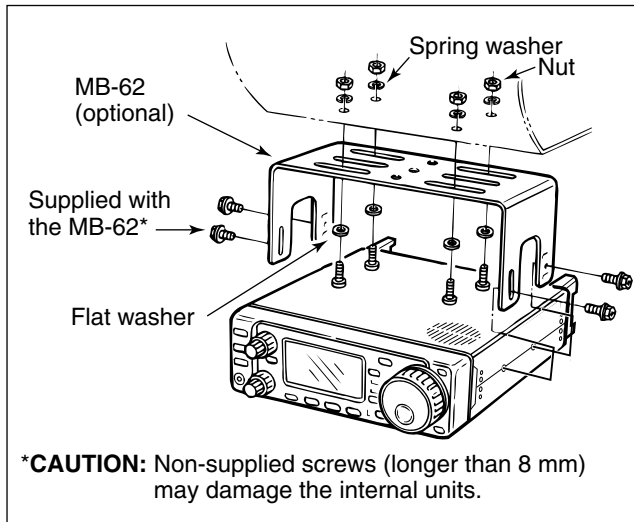

◇ Stand

To raise the stand:

With the transceiver upside down, pull the stand towards the rear panel and then upwards, as illustrated below.

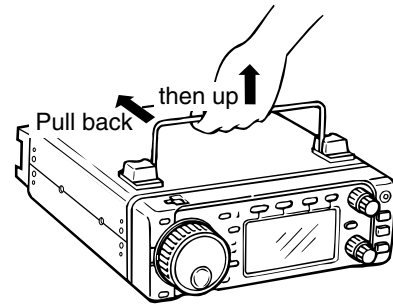

◇ Front panel separation

- ① While pulling the panel release button towards you, slide the front panel to the right (fig. 1).
- ② Attach the optional OPC-581 to the main body and tighten the supplied screw as in fig. 2.
- ③ Attach the other end of the OPC-581 to the detached front panel as in fig. 3.

CAUTION: NEVER detach/attach the front panel when connecting the DC power supply (or battery). Make sure the disconnecting DC power cable from the [13.8 V] receptacle on the transceiver rear panel.

fig. 1

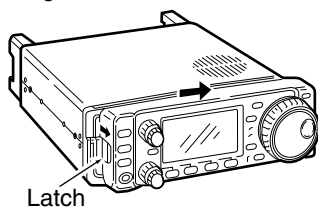

fig. 2

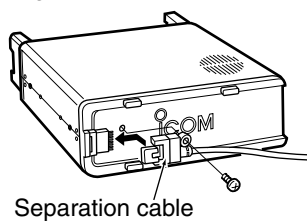
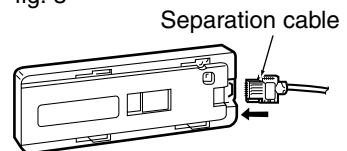

fig. 3



◇ Front panel mounting

- ① Attach the MB-63 to a flat surface using the two supplied screws (fig. 1).
- ② Fix the detached front panel to the MB-63 as illustrated in fig. 2.

BE CAREFUL of the orientation of the MB-63, otherwise, the front panel may become attached in the opposite direction.

fig. 1

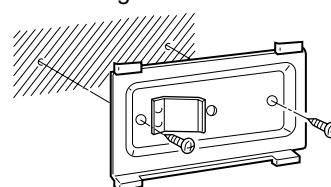
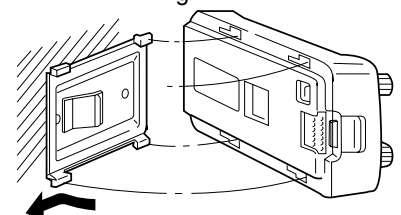
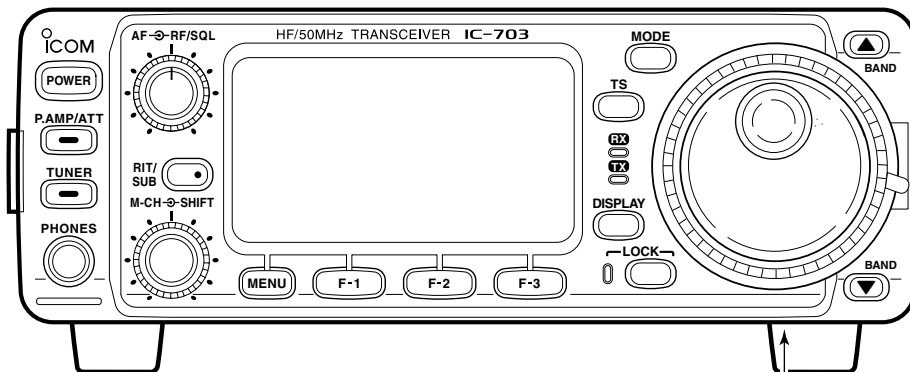

fig. 2



Required connections



MICROPHONE (p. 10)

HM-103

CW KEY (p. 28)

GROUND (p. 11)

Use the heaviest gauge wire or strap available and make the connection as short as possible. Grounding prevents electrical shocks, TVI and other problems.

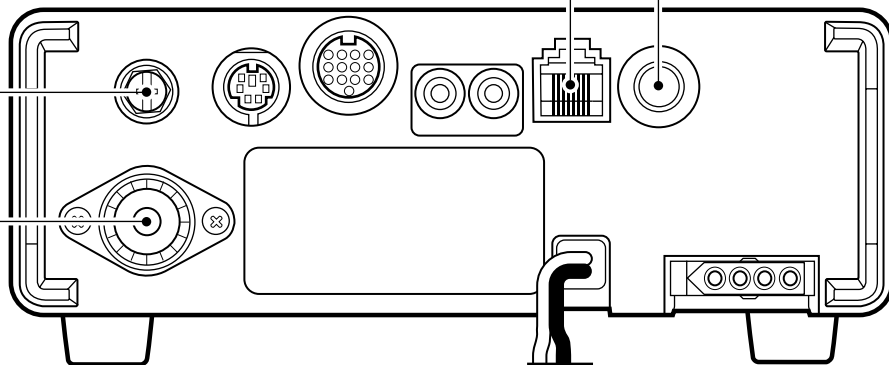

HF/50 MHz ANTENNA

Connects to DC 9.0–15.8 V power supply. See p. 15 for details.

Advanced connections

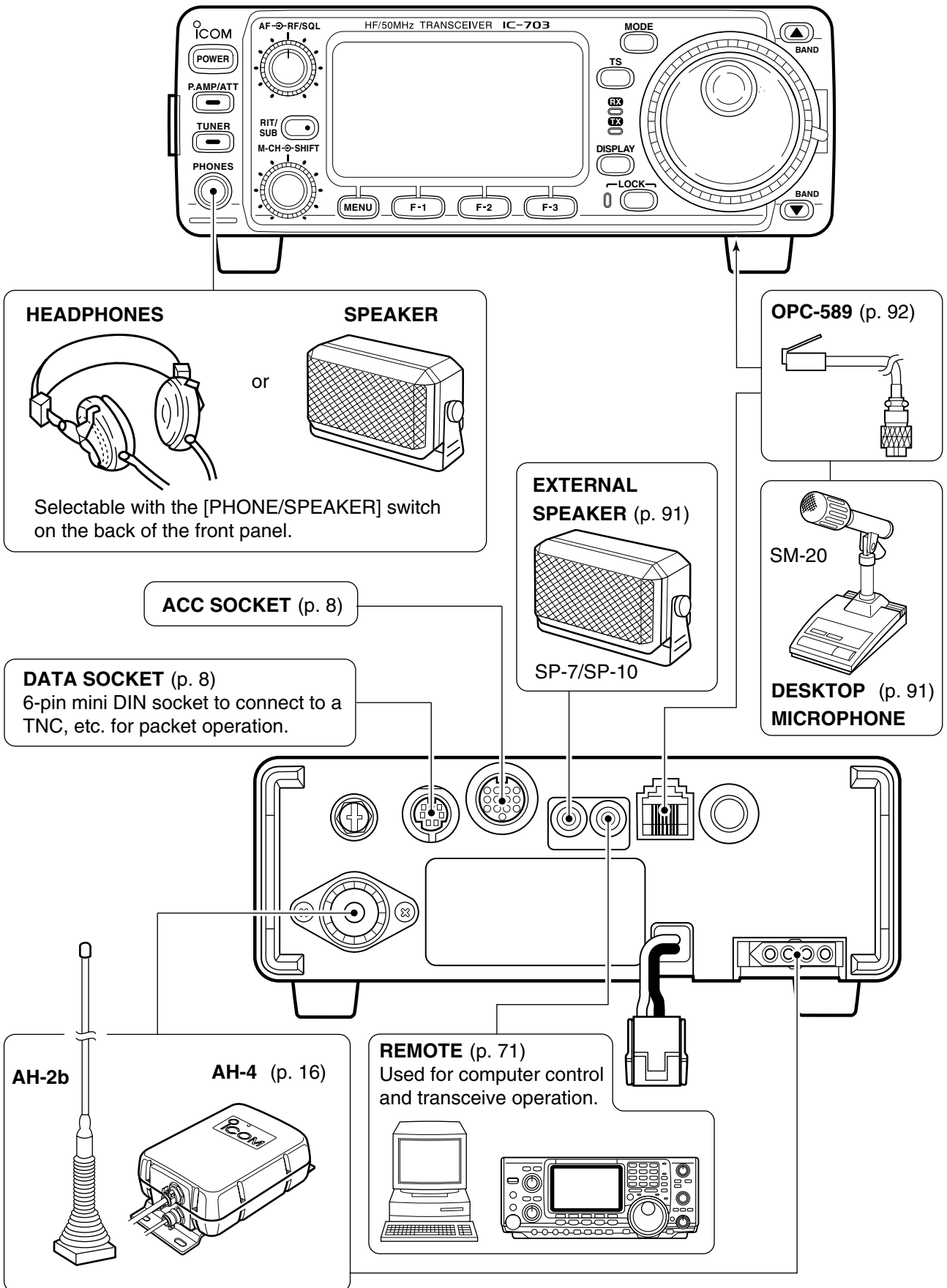

2

DC Power voltage

Depending on the applied voltage from the connected power supply, a boarder voltage of 11.0 V is set as the point where the IC-703 switches between normal operating mode (over 11.0 V), and battery operating mode (under 11.0 V: power save mode).

However when the connected voltage decreases from 13.8 V to **11.0V**, the IC-703 switches from normal mode to battery mode. Conversely the IC-703 switches back to normal mode from battery mode

when the voltage reaches **11.5 V**. This 0.5 V voltage difference prevents irregular switching between normal mode and battery mode, caused by the voltage drop which are current capacity, receiving or transmitting.

When 11.3 V voltage is applied, the IC-703 may activate the battery operating mode depending on the current capacity of the power supply.

DC Power supply connections

Use a 13.8 V DC power supply with at least 3 A capacity. when operating IC-703 with AC power. Refer to the diagram below for connection.

CAUTION:
Before connecting the DC power cable, check the following important items. Make sure:
• The [POWER] switch is OFF.

• Output voltage of the power source is 9.0–15.8 V when you use a non-Icom power supply.
• DC power cable polarity is correct.
Red: positive (+) terminal,
Black: negative (–) terminal

CONNECTING PS-125 DC POWER SUPPLY

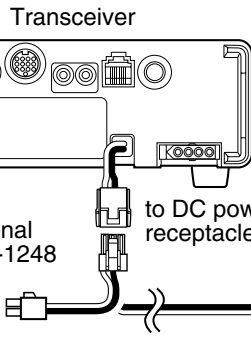
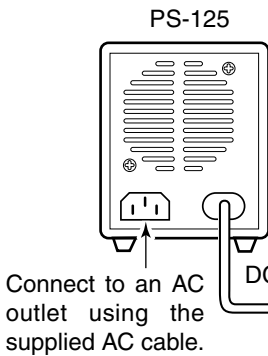

CONNECTING A DC POWER SUPPLY

*13.8 V; at least 3.0 A continuous

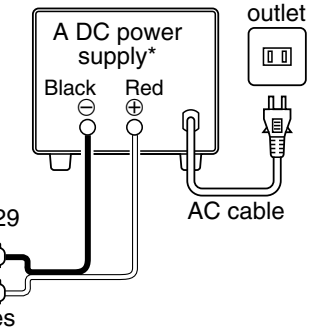

Battery connections

• **WARNING NEVER connect** to a battery without supplied DC fuse, otherwise a fire hazard occur.
• **NEVER connect** the transceiver directly to a 24 V battery.

• **DO NOT** use the cigarette lighter socket for power connections. (See p. 7 for details)
• Attach a rubber grommet when passing the DC power cable through a metal plate to prevent a short circuit.

CONNECTING A VEHICLE BATTERY

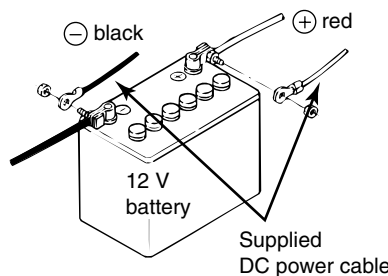
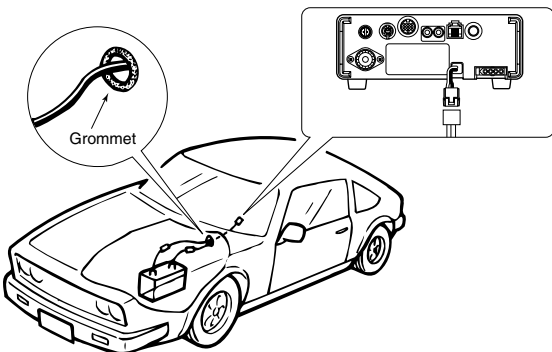

Note: Use terminals for the cable connections.

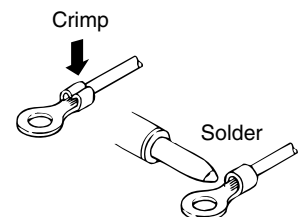

External antenna tuners and linear amplifier

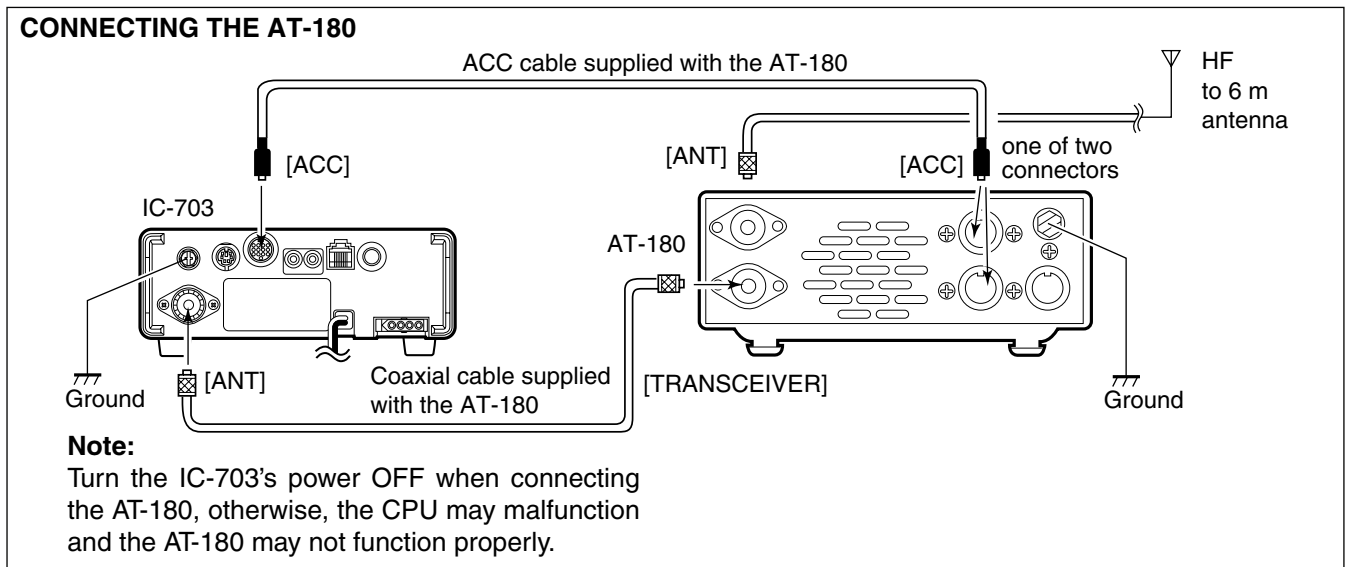
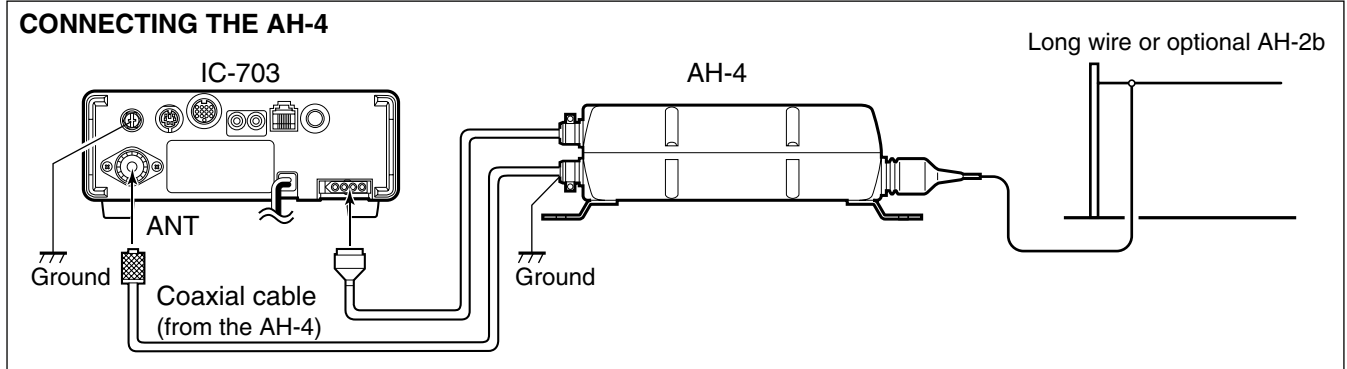

2

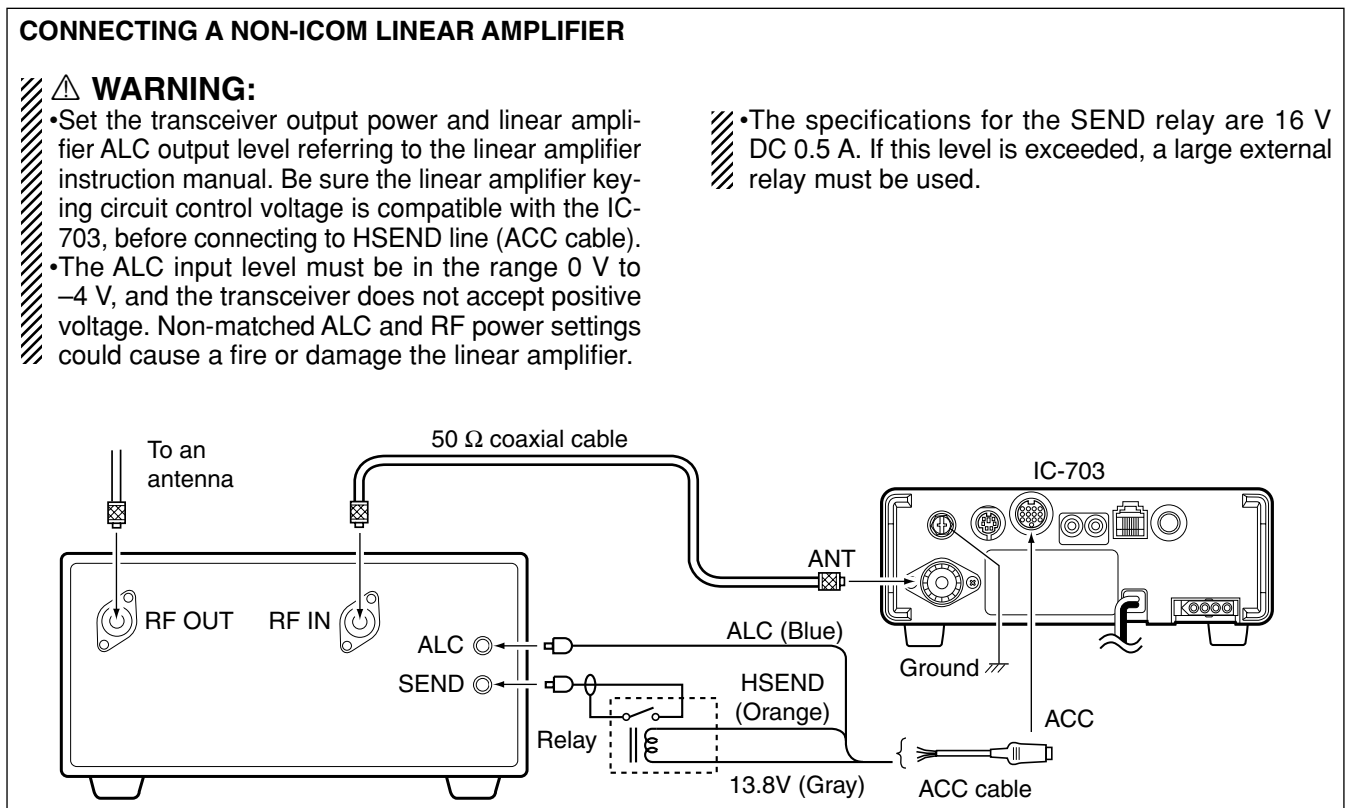

■ When first applying power (CPU resetting)

Before first applying power, make sure all connections required for your system are complete by referring to Chapter 2. Then, reset the transceiver using the following procedure.

Resetting **CLEARs** all programmed contents in memory channels and returns all initial set mode and quick set mode contents to their default values.

- ① Make sure the transceiver power is OFF.
- ② While pushing [▲] and [▼], push [POWER] to turn power ON.
 - “CLEAR ? OK” appears as shown at right.
- ③ Then push [F-3] for 1 sec.
 - The internal CPU is reset.
 - The display changes to ‘All indication,’ ‘RF power,’ ‘Power supply voltage’ and ‘Initial frequency and Mode’ as shown at right.

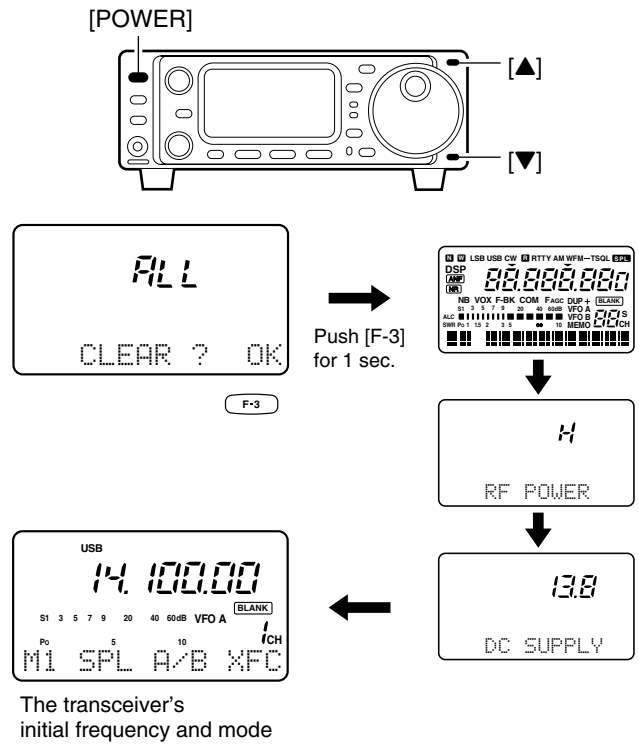

◇ M1 display selection

If you can't figure out how to return to the M1 display: While pushing [MENU], turn power ON.

■ Initial settings

After resetting the transceiver, set controls and switches as shown in the diagram below.

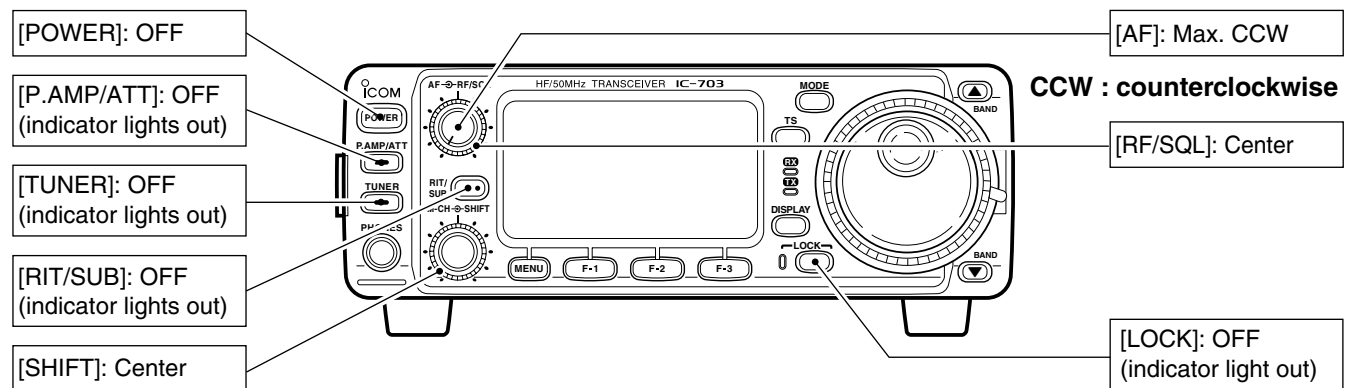

Turn power ON, then check the display. If any of the following indicators appear, turn them OFF as follows:

- Tuning step indicators, ▼, (SSB, CW or RTTY): Push [TS].
- MHz tuning step indicator, ▼, (FM or AM): Push [TS].
- 1 Hz frequency readout (SSB, CW or RTTY): Push and hold [TS].
- Memory mode indicator, MEMO: Use [(F-3)U/M] in the M2 display (p. 75).
- Split indicator, SPL: Use [(F-1)SPL] in the M1 display (p. 75).

VFO description

VFO is an abbreviation of Variable Frequency Oscillator, and traditionally refers to an oscillator. The IC-703's VFO can store a frequency and an operating mode.

You can call up a desired frequency to a VFO with the memo pad-read switch (p. 60) or with the memory transfer switch (p. 58). You can also change the frequency with the main dial and select an operating mode with the [MODE] switch or call up previously accessed frequency and modes with the band stacking register (p. 22).

The IC-703 has two VFOs, specially suited for split frequency operation. The VFOs are called VFO A and VFO B. You can use the desired VFO to call up a frequency and operating mode for operation.

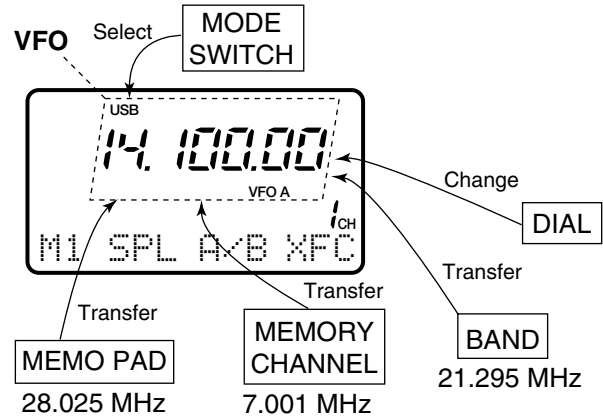

The differences between VFO and memory mode

VFO MODE

Each VFO shows a frequency and operating mode. If the frequency or operating mode is changed, the VFO automatically memorizes the new frequency or operating mode.

When the VFO is selected from another VFO or memory mode, the last-used frequency and operating mode for that VFO appear.

[EXAMPLE]

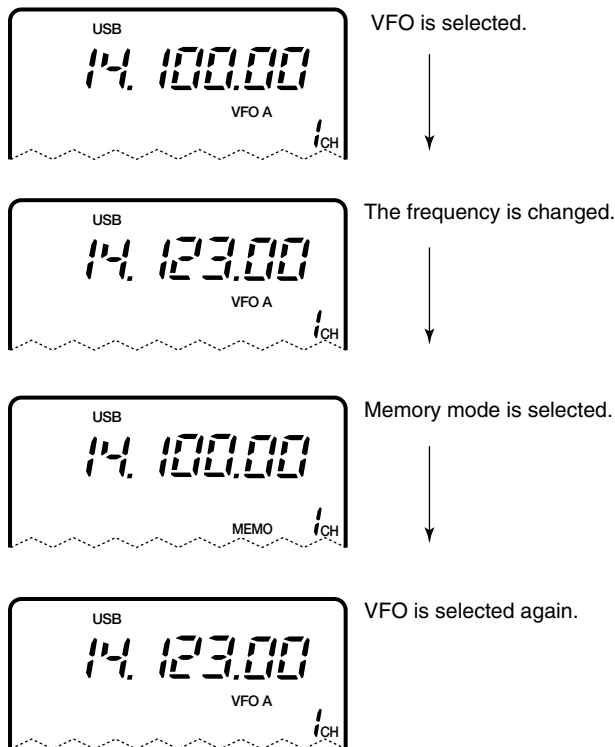

Changed frequency (14.123 MHz) appears.

MEMORY MODE (pgs. 56–60)

Each memory channel shows a frequency and operating mode like a VFO. Even if the frequency or mode is changed, the memory channel does not memorize the new frequency or operating mode.

When a memory channel is selected from another memory channel or VFO mode, the memorized frequency and operating mode appear.

[EXAMPLE]

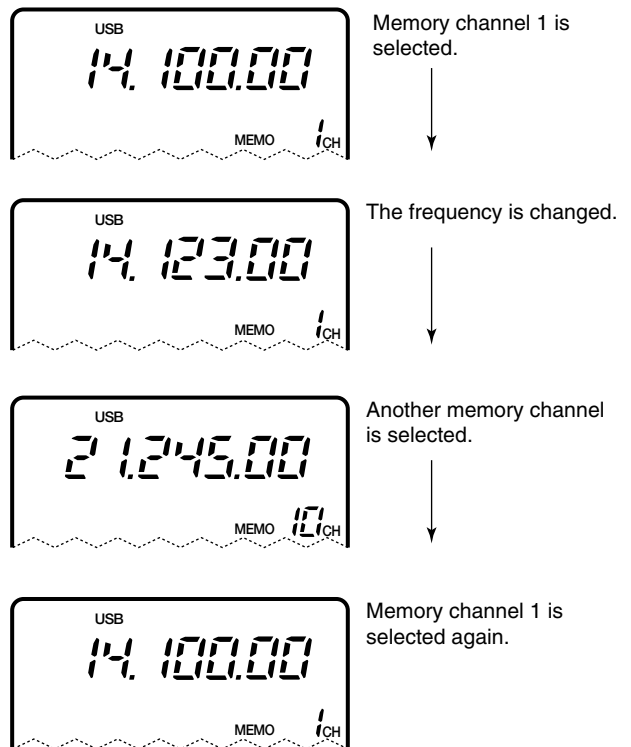

Changed frequency (14.123 MHz) does not appear and memorised frequency (14.100 MHz) appears instead.

■ Frequency setting

• Band selection

All HF ham bands, the 50 MHz band and a general coverage receiver band are included in the IC-703.

Push [(▲)BAND]/[(▼)BAND] to select the desired band.

• Pushing [(▲)BAND]/[(▼)BAND] continuously scrolls through the available bands.

▨ The band stacking register can also be used to select bands. Refer to p. 22.

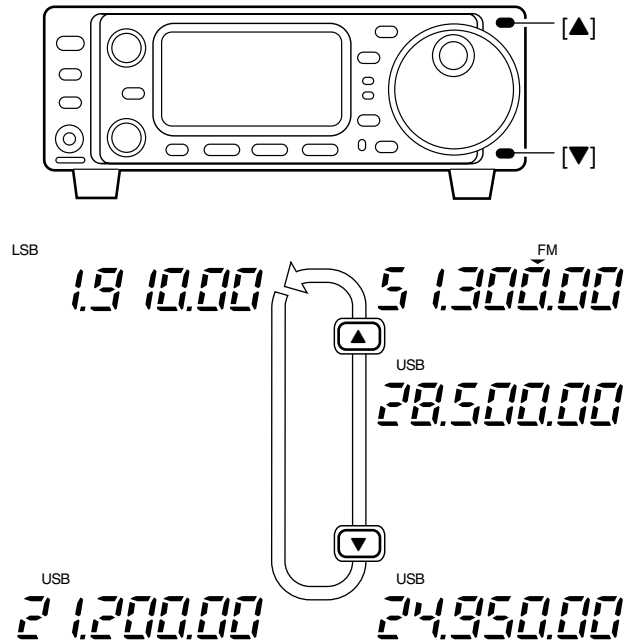

• Programmable tuning steps

Programmable tuning steps are available to suit your operating requirements.

These tuning steps are:

- Independently selectable for each mode
- Selectable from 0.01 (FM/AM only), 0.1, 1, 5, 9, 10, 12.5, 20, 25 and 100 kHz

- ① Push [TS] one or more times until the programmable tuning step indicator “▼” appears above the 1 kHz digit.
 - Rotating the main dial changes the frequency according to the set tuning step.
- ② Push [TS] for 1 sec. while the programmable tuning step indicator appears to enter the tuning step selection mode.
 - “Rotate DIAL” appears.
- ③ Rotate the main dial to set the desired tuning step.
 - Change the mode and select tuning steps for other modes, if desired.
- ④ Push [TS] to exit the tuning step selection mode.
- ⑤ Rotate the main dial to change the frequency according to the set tuning step.

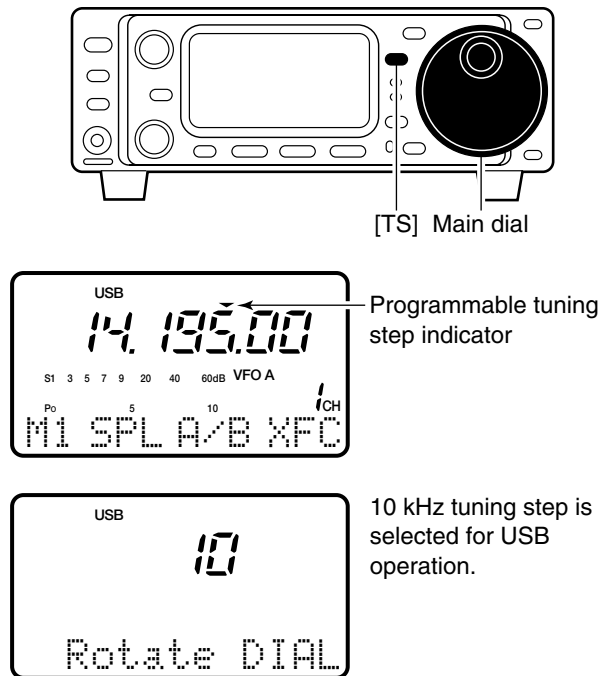

•1 Hz and 10 Hz tuning steps

When neither the quick tuning step or programmable tuning step “▼” appear, rotating the main dial changes the frequency in increments of 1 or 10 Hz. These tuning steps are only available in SSB, CW and RTTY modes.

- ① Select SSB, CW or RTTY mode if necessary.
- ② Push [TS] for 1 sec. to toggle between the 1 Hz and 10 Hz step settings.
 - When the 1 Hz step is selected, the 1 Hz digit appears in the frequency indication; when the 10 Hz step is selected, the 1 Hz digit disappears from the frequency indication.
 - Rotating the main dial changes the frequency 1 Hz or 10Hz tuning step.

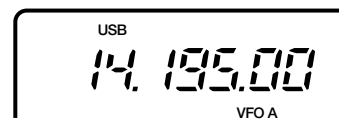
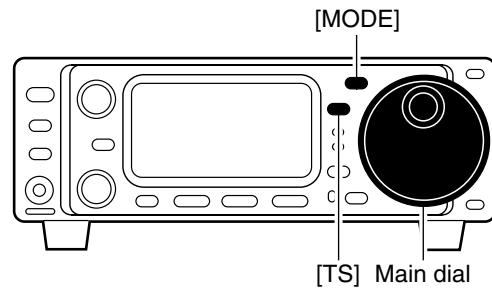

Rotating the main dial changes the frequency in 10 Hz steps.

Push **[TS]** for 1 sec.

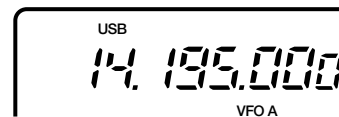

Rotating the main dial changes the frequency in 1 Hz steps.

•1 MHz quick tuning step

The quick tuning step function allows you to change the frequency in 1 MHz steps when rotating the main dial. This function is only available in FM and AM modes.

- ① Select FM or AM mode if necessary.
- ② Push [TS] momentarily to toggle between the 1 MHz tuning step and the programmable tuning step.
 - “▼” appears above the 1 MHz indicator when the 1 MHz tuning step is selected.
 - Rotating the main dial changes the frequency 1 MHz or set tuning step.

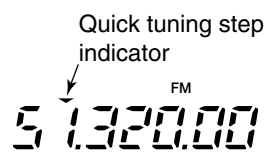
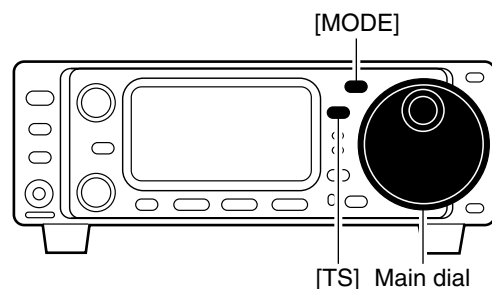

Rotating the main dial changes the frequency in 1 MHz steps.



• [TS] switch flow chart

SSB/CW/RTTY modes

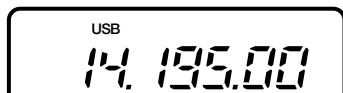

10 Hz tuning



momentarily

Any mode



Programmable step tuning
(100 Hz – 100 kHz)



momentarily

FM/AM modes



1 MHz tuning



1 sec.

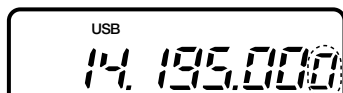

1 Hz tuning

Appears



momentarily

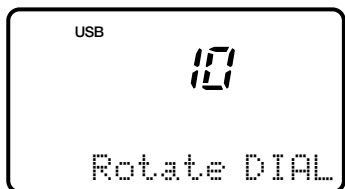

Selectable for each mode.

• Sub dial function

The sub dial function allows you to change the operating frequency using the [M-CH] control. This gives you more control in tuning since the [M-CH] knob is detented—each click changes the frequency according to the set tuning step. This function is always available in FM and AM modes. However, in SSB, CW and RTTY modes, the initial set mode item “21 SUB DIAL” (p.61), must be set to “FrEq.”

- ① Push [RIT/SUB] to turn the sub dial function ON.
 - The [SUB] indicator lights green; if it lights red, the RIT function is activated—sub dial function must be set in initial set mode in this case.
- ② Rotate [M-CH] to change the operating frequency according to the set tuning step.
- ③ Push [RIT/SUB] again to turn the function OFF.
 - The [SUB] indicator turns off.

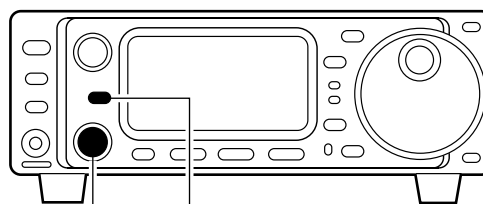

[M-CH] [RIT/SUB]

RIT/SUB Indicator lights green while the sub dial function is activated.

•Quick band change function

The quick band change function automatically stores the last frequency and mode used for each band in a band stacking register. This is convenient for contest operation, etc. The tables below show the quick band change default settings for each band.

- ① Select S3.
 - Push [DISPLAY] once or twice to select S.
 - Push [MENU] one or more times to select S3.
- ② Push [F-1], [F-2] or [F-3] to select a band stacking register.
 - The default settings for [F-1], [F-2], [F-3] are 7, 14, 21 MHz bands, respectively.
- ③ To change the settings for [F-1], [F-2] or [F-3] from their defaults, push [F-1], [F-2] or [F-3] for 1 sec. one or more times to until the desired band appears in the display above the corresponding switch.
 - The last-used frequency and mode for the selected band are displayed.

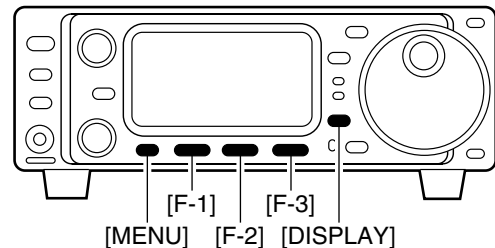

BAND	FREQUENCY	MODE
1.9 MHz	1.90000 MHz*1	CW
3.5 MHz	3.55000 MHz	LSB
7 MHz	7.05000 MHz	LSB
10 MHz	10.12000 MHz	CW
14 MHz	14.10000 MHz	USB
18 MHz	18.10000 MHz	USB
21 MHz	21.20000 MHz	USB
24 MHz	24.95000 MHz	USB
28 MHz	28.50000 MHz	USB
50 MHz*2	50.10000 MHz	USB
General*3	15.00000 MHz	USB

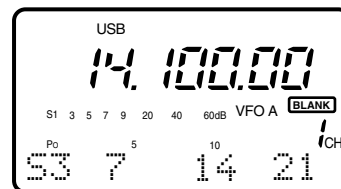

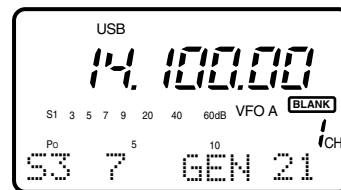

Display shows the default bands for the quick band change function.



Display shows [F-2] has been changed from its default of the 14 MHz band to the general receiver band.

*1 1.83000 MHz for Italy version (#10, #20).
 *2 50 MHz band is not available for some version.
 *3 General refers to the general coverage receiver (GEN in the display) and the range varies according to version.

■ Operating mode selection

The following modes are available in the IC-703:
SSB (LSB/USB), CW, CW- (CW reverse), RTTY and  RTTY (RTTY reverse), FM, AM.

• SSB (LSB/USB), CW, RTTY, SSB-D, FM and AM modes selection

To select the desired mode of operation, push [MODE] one or more times, then push [MODE] for 1 sec., if necessary. See the diagram at right for the order of selection.

• The selected mode is indicated in the function display.

• CW- (CW reverse) mode selection

- ① When selecting CW mode, push [DISPLAY] for 1 sec. to enter quick set mode.
- ② Push [MENU] one or more times to select item "03 CW REV" during CW mode.
 - [▲]/[▼] or [M-CH] can also be used.
- ③ Rotate the main dial to select CW reverse.
- ④ Push [DISPLAY] to exit quick set mode.
 - "CW-" appears.

• RTTY (RTTY reverse) mode selection

- ① When selecting RTTY mode, push [DISPLAY] for 1 sec. to enter quick set mode.
- ② Push [MENU] one or more times to select item "02 RTTY REV" during RTTY mode.
 - [▲]/[▼] or [M-CH] can also be used.
- ③ Rotate the main dial to select RTTY reverse.
- ④ Push [DISPLAY] to exit quick set mode.
 - " RTTY" appears.

Note: If a desired mode cannot be selected, it may be hidden using initial set mode (p. 76).

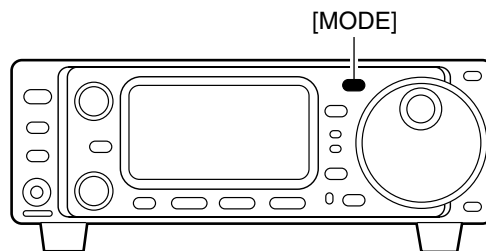

OPERATING MODE SELECTION

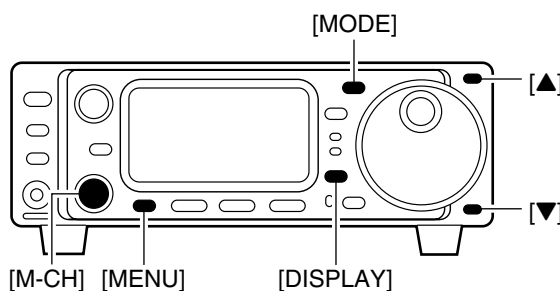
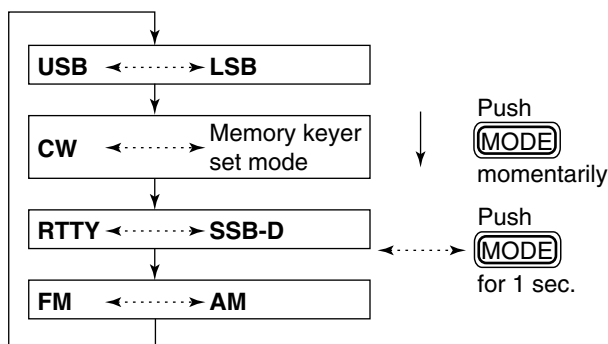

■ Volume setting

Rotate [AF] control to output a suitable audio level.

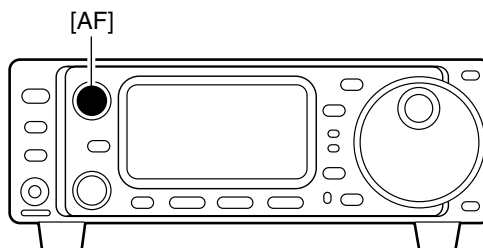
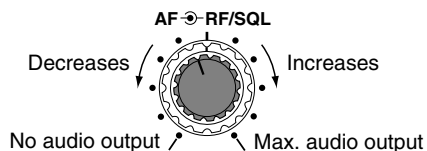

■ Squelch and receive (RF) sensitivity

Adjusts the RF gain and squelch threshold level. The squelch removes noise output from the speaker (closed position) when no signal is received.

- The squelch is particularly effective for FM mode. It is also available for other modes.
- The control can be set as the RF gain control only (squelch is fixed open) or squelch control (RF gain is fixed at maximum) in initial set mode (p. 79). See below right.
- The 11 to 12 o'clock position is recommended for any setting of the [RF/SQL] control.

SET MODE	OPERATION
RF+SQL (default)	Can be used in all modes. Functions as noise squelch or S-meter squelch in AM and FM modes; S-meter squelch only in other modes.
SQL	Operates as a squelch control. • RF gain is fixed at maximum sensitivity.
AUTO	Operates as an RF gain control in SSB, CW and RTTY modes. • Squelch is fixed open. Operates as a squelch control in AM and FM modes. • RF gain is fixed at maximum sensitivity.

Adjusting RF gain (Receive sensitivity)

Normally, [RF/SQL] is set to the 11 o'clock position. Rotate [RF/SQL] to the 11 o'clock position for maximum sensitivity.

- Rotating counterclockwise from the maximum position reduces sensitivity.
- The S-meter indicates receive sensitivity.

Adjusting squelch (Removing non-signal noise)

Rotate [RF/SQL] clockwise when receiving no signal, until the noise just disappears.

- [RX] indicator light goes out.
- Rotating [RF/SQL] past the threshold point invokes the S-meter squelch— this allows you to set a minimum signal level needed to open the squelch.

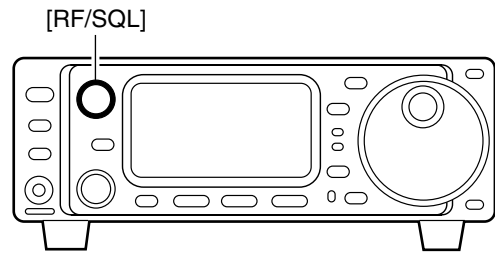

• When setting as RF gain/squelch control

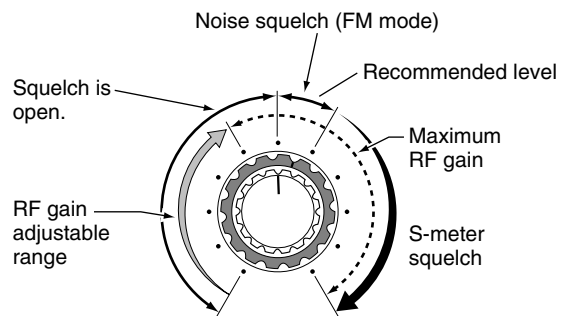

• When functioning as RF gain control (Squelch is fixed open; SSB, CW, RTTY only)

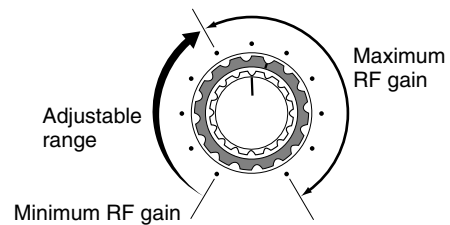

• When functioning as squelch control (RF gain is fixed at maximum)

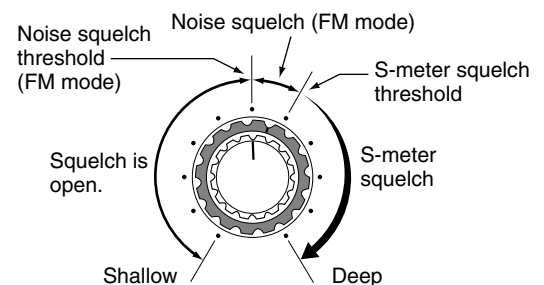

■ Dial lock function

The dial lock function prevents accidental changes caused by the tuning dial.

- ➔ Push [LOCK] to turn the dial lock function ON and OFF.
 - “LOCK” indicator lights while the dial lock function is activated.

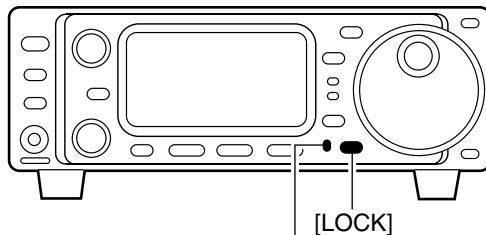

Lights while the dial lock function is activated.

■ Basic transmit operation

◇ Transmitting

Before transmitting, monitor your selected operating frequency to make sure transmitting won't cause interference to other stations on the same frequency. It's good Amateur practice to listen first, and then, even if nothing is heard, ask "is the frequency in use" once or twice, before you begin operating on that frequency.

- ① Push [PTT] (microphone) to transmit.
 - The [TX] indicator lights red.
- ② Release [PTT] (microphone) to return to receive.

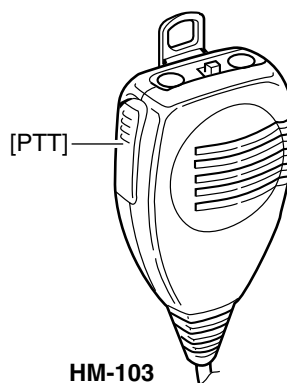

◇ Maximum output power

- ① Push [POWER] for 1 sec. to turn power OFF.
- ② While pushing [LOCK], push [POWER] to turn power ON and enter initial set mode.
- ③ Push [MENU] one or more times to select "1 MAX POWSET," if necessary.
 - [M-CH] or [▲]/[▼] can also be used.
- ④ Rotate the main dial to select the desired maximum output power.
 - Maximum output power is selectable "0.5," "1," "2.5," "5" or "10."
 - Default setting is "10."
- ⑤ Push [POWER] to turn power OFF, and ON again.

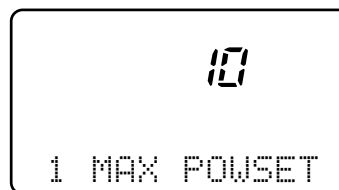
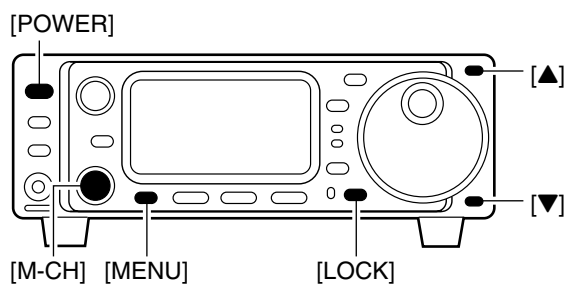

◇ **Setting output power** QUICK SET MODE

- ① Push [DISPLAY] for 1 sec. to select quick set mode.
- ② Push [MENU] one or more times to select "Q1 RF POWER."
- ③ Rotate the main dial to select the desired output.
 - Output power is displayed in 11 steps (L, 1–9 and H) but is continuously selectable.
- ④ Push [DISPLAY] to exit quick set mode.

• **Available power**

Power supply voltage	SSB/CW RTTY/FM	AM*
13.8 V (DC power mode)	0.1–10 W	0.1–4 W
9.6 V (Battery mode)	0.1–5 W	0.1–2 W

*Carrier power

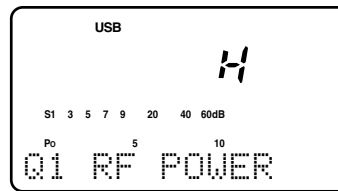
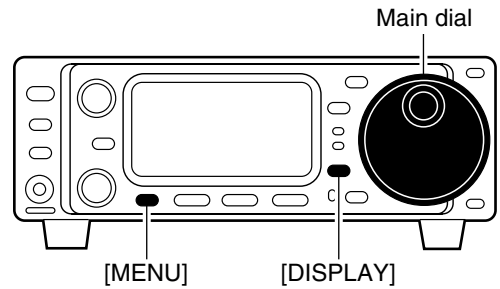

Maximum output power is selected.

◇ **Setting microphone gain** QUICK SET MODE

Microphone gain must be adjusted properly so that your signal does not distort when transmitted.

- ① Select SSB or another phone mode (AM or FM mode).
- ② Push [DISPLAY] for 1 sec. to select quick set mode.
- ③ Push [MENU] one or more times to select "Q2 MIC GAIN."
 - The ALC meter is selected automatically when operating in SSB mode.
- ④ While speaking into the microphone adjust the microphone gain so that the ALC meter does not peak past the ALC zone.
- ⑤ Push [DISPLAY] to exit quick set mode.

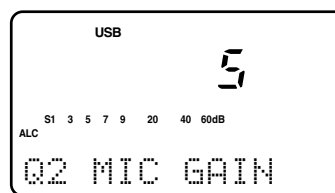
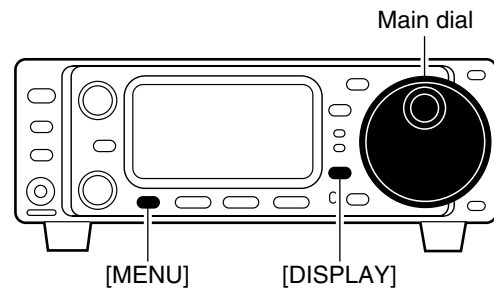

Microphone gain is set to 5.

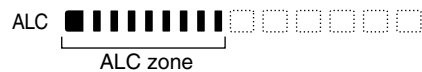

■ Operating SSB

- ① Push [(▲)BAND]/[(▼)BAND] to select the desired band.
- ② Push [MODE] momentarily or push for 1 sec. to select LSB or USB mode.
 - Below 10 MHz LSB is automatically selected; above 10 MHz USB is automatically selected.
- ③ Rotate [AF] control to set audio to a comfortable listening level.
- ④ Rotate the main dial to tune a desired signal.
 - S-meter indicates received signal strength.
- ⑤ Push [PTT] (microphone) to transmit.
 - The TX indicator lights red.
- ⑥ Speak into the microphone at your normal voice level.
 - Adjust 'MIC GAIN' at this step, if necessary. (p. 26)
- ⑦ Release [PTT] (microphone) to return to receive.

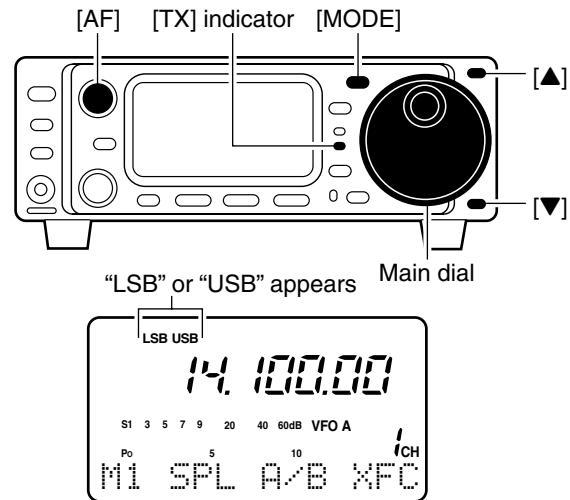

◇ Convenient functions for receive

• Preamp and attenuator (p. 46)

- ➔ Push [P.AMP/ATT] momentarily to set the preamp ON or OFF.
 - Lights green when the preamp is set to ON.
- ➔ Push [P.AMP/ATT] for 1 sec. to set the attenuator ON.
 - Push [P.AMP/ATT] momentarily to turn the attenuator OFF.
 - Lights red when the attenuator is set to ON.

• Noise blanker (p. 48)

- ➔ While "M3" is selected, push [(F-2)NB] to turn the noise blanker ON and OFF.
 - Push [DISPLAY] once or twice to select M.
 - Push [MENU] one or more times to select M3.
 - "NB" appears when the noise blanker is set to ON.
 - Push [(F-2)NB] for 1 sec. to enter the noise blanker set mode.

• IF shift (p. 47)

- ➔ Rotate [SHIFT] control.

• AGC (auto gain control) (p. 48)

- ➔ While "M4" is selected, push [(F-3)AGC] to select AGC fast and AGC slow.
 - Push [DISPLAY] once or twice to select M.
 - Push [MENU] one or more times to select M4.
 - "FAGC" appears when the fast time constant is selected.

• Noise reduction (p. 50)

- ➔ While "S4" is selected, push [(F-2)NR] to turn the noise reduction ON and OFF.
 - Push [DISPLAY] once or twice to select S.
 - Push [MENU] one or more times to select S4.
 - Push [(F-3)NRL] then rotate [M-CH] to adjust the noise reduction level.
 - "NR" appears when the noise reduction is set to ON.

• Auto notch filter (p. 50)

- ➔ While "S4" is selected, push [(F-1)ANF] to turn the auto notch filter function ON and OFF.
 - "ANF" appears when the noise reduction is set to ON.

◇ Convenient functions for transmit

• Speech compressor (p. 54)

- ➔ While "M4" is selected, push [(F-2)COM] to turn the speech compressor ON and OFF.
 - Push [DISPLAY] once or twice to select M.
 - Push [MENU] one or more times to select M4.
 - "COM" appears when the speech compressor is set to ON.
 - Push [(F-2)COM] for 1 sec. to enter the compression level set mode.

• Carrier frequency control (p. 75)

- ➔ While "Q3" is selected, rotate main dial to adjust the audio tone.
 - Push [DISPLAY] for 1 sec. to enter the quick set mode.
 - Push [MENU] one or more times to select Q3.

• VOX (voice operated transmit) (p. 53)

- ➔ While "M4" is selected, push [(F-1)VOX] to turn the VOX function ON and OFF.
 - Push [DISPLAY] once or twice to select M.
 - Push [MENU] one or more times to select M4.
 - "VOX" appears when the VOX function is set to ON.
 - Push [(F-1)VOX] for 1 sec. to enter the VOX set mode.

■ Operating CW

◇ Connections for CW

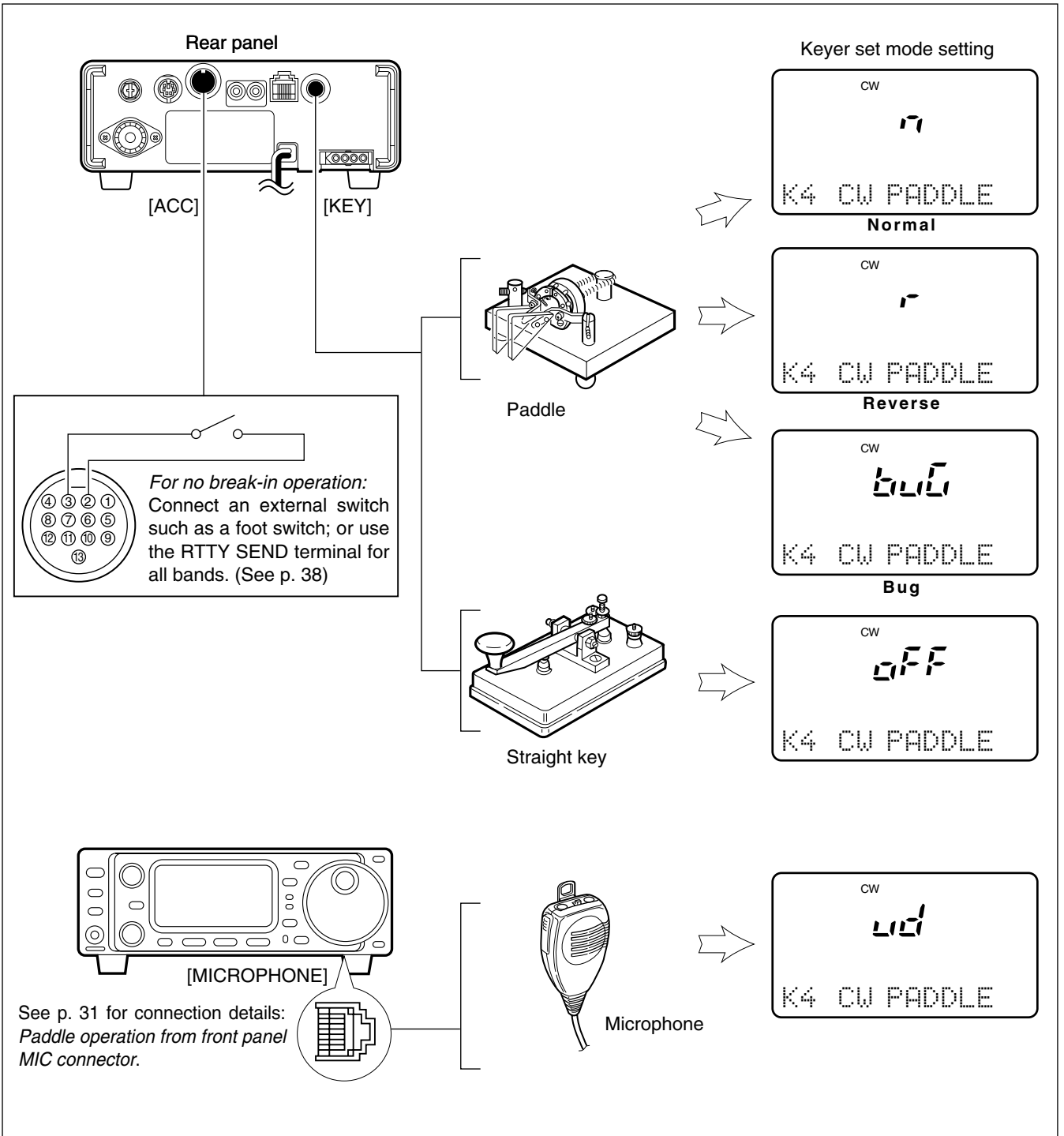

◇ CW operation

- ① Connect a paddle or straight key as at previous page.
- ② Push [(▲)BAND]/[(▼)BAND] to select the desired band.
- ③ Push [MODE] momentarily to select CW mode.
 - After CW mode is selected, push [MODE] for 1 sec. to toggle between CW and Memory keyer modes.
- ④ While the quick set mode item "03" is selected in CW mode, rotate main dial to select CW or CW \square mode.
 - Push [DISPLAY] for 1 sec. to enter the quick set mode.
 - Push [MENU] one or more times to select 03.
 - Push [DISPLAY] momentarily to return to normal operating mode.
- ⑤ Rotate [AF] control to set audio to a comfortable listening level.
- ⑥ Rotate the main dial to simultaneously tune a desired signal and its side tone.
- ⑦ Set CW setting in the keyer set mode.
 - Push [DISPLAY] once or twice to select M.
 - Push [MENU] one or more times to select M4.
 - Push [(F-2)KEY] for 1 sec. to enter the keyer set mode. (p. 32)
- ⑧ Set CW break-in operation as semi break-in, full break-in or OFF.
 - Push [MENU] one or more times to select "K1 BK-IN."
 - Rotate the main dial to select CW break-in operation.
 - ◆ FULL : full break-in
 - ◆ on : semi break-in
 - ◆ OFF : no break-in (ACC socket connection is necessary as at previous page.)
- ⑨ Set the CW delay time when semi break-in operation is selected.
 - Push [MENU] one or more times to select "K2 BK-IN DELAY."
 - Rotate the main dial to set the desired delay time (see p. 32 for details).
- ⑩ Keying to transmit, use the electric keyer or paddle to key your CW signals.
 - The TX indicator lights red.
 - The Po meter indicates transmitted CW signal strength.
- ⑪ Release keying to return to receive.

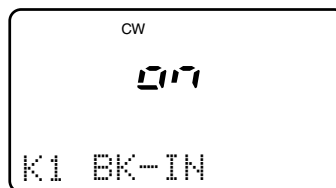
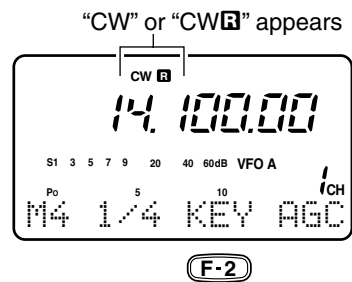
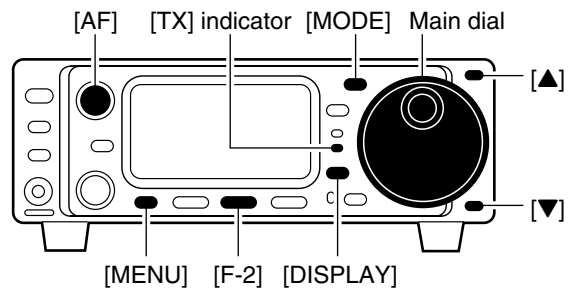

Semi break-in operation is selected.

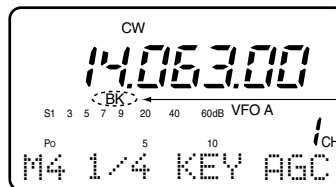

Appears

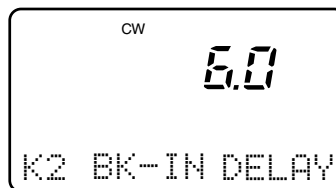

Delay time of 6.0 dots is selected for semi break-in operation.

◇ Convenient functions for receive

• Preamp and attenuator (p. 46)

- Push [P.AMP/ATT] momentarily to set the preamp ON or OFF.
 - Lights green when the preamp is set to ON.
- Push [P.AMP/ATT] for 1 sec. to set the attenuator ON.
 - Push [P.AMP/ATT] momentarily to turn the attenuator OFF.
 - Lights red when the attenuator is set to ON.

• Noise blanker (p. 48)

- While "M3" is selected, push [(F-2)NB] to turn the noise blanker ON and OFF.
 - Push [DISPLAY] once or twice to select M.
 - Push [MENU] one or more times to select M3.
 - "NB" appears when the noise blanker is set to ON.
 - Push [(F-2)NB] for 1 sec. to enter the noise blanker set mode.

• AGC (auto gain control) (p. 48)

- While "M4" is selected, push [(F-3)AGC] to select AGC fast and AGC slow.
 - Push [DISPLAY] once or twice to select M.
 - Push [MENU] one or more times to select M4.
 - "FAGC" appears when the fast time constant is selected.

• IF shift (p. 47)

- Rotate [SHIFT] control.

• Noise reduction (p. 50)

- While "S4" is selected, push [(F-2)NR] to turn the noise reduction ON and OFF.
 - Push [DISPLAY] once or twice to select S.
 - Push [MENU] one or more times to select S4.
 - Push [(F-3)NRL] then rotate [M-CH] to adjust the noise reduction level.
 - "NR" appears when the noise reduction is set to ON.

• Auto notch filter (p. 50)

- While "S4" is selected, push [(F-1)ANF] to turn the auto notch filter function ON and OFF.
 - "ANF" appears when the noise reduction is set to ON.

• 1/4 function

- While "M4" is selected, push [(F-1)1/4] to turn the 1/4 function ON and OFF.
 - Push [DISPLAY] once or twice to select M.
 - Push [MENU] one or more times to select M4.

◇ Convenient functions for transmit

• Break-in function (p. 32)

- While "M4" is selected, push [(F-2)KEY] for 1 sec. to enter the keyer set mode.
 - Push [DISPLAY] once or twice to select M.
 - Push [MENU] one or more times to select M4.
- Rotate the main dial to select the break-in OFF, semi break-in or full break-in.
 - "BK" or "F-BK" appears when the semi break-in or full break-in is set to ON, respectively.

◇ CW reverse mode

QUICK SET MODE

The CW  (CW Reverse) mode receives CW signals with a reverse side CW carrier point like that of LSB and USB modes. Use this mode when interference signals are near the desired signal and you want to change the interference tone.

- ① Select CW mode with [MODE].
- ② Push [DISPLAY] for 1 sec. to enter quick set mode.
- ③ Push [MENU] one or more times to select "03 CW REV," then rotate the main dial to select CW and CW  modes.
 - Check the interference tone.
- ④ Push [DISPLAY] momentarily to exit quick set mode.

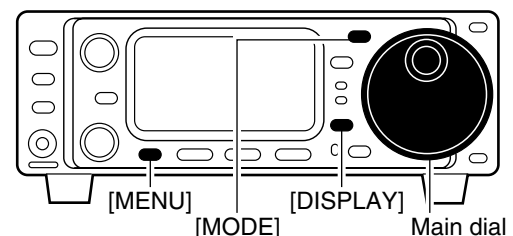

• Receive audio tone response

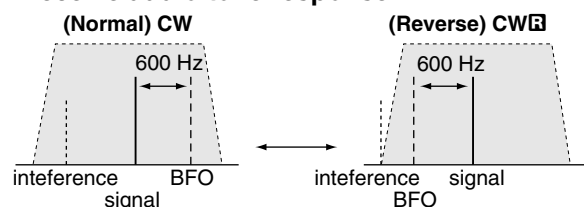

◇ CW pitch control

The received CW audio pitch and monitored CW audio pitch can be adjusted to suit your preferences (300 to 900 Hz) without changing the operating frequency.

- ① Enter the keyer set mode.
 - Push [DISPLAY] once or twice to select M.
 - Push [MENU] one or more times to select M4.
 - Push [(F-2)KEY] for 1 sec. to enter the keyer set mode.
- ② Push [MENU] one or more times to select "K3 CW PITCH," then rotate the main dial to set the desired pitch.
- ③ Push [DISPLAY] to exit the keyer set mode.

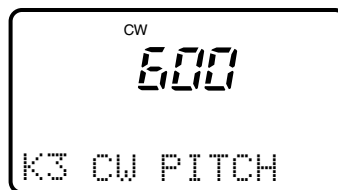
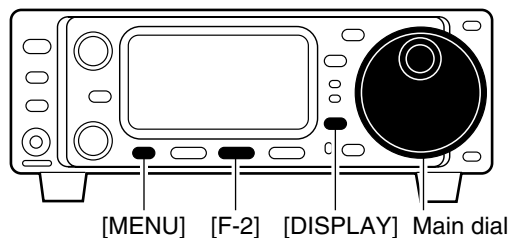

This shows the default setting for the CW pitch control (600 Hz).

◇ Electronic CW keyer

The IC-703 has an electronic keyer. Both keying speed and weight (the ratio of dot:space:dash) can be set.

•Setting the electronic keyer

- ① Enter the keyer set mode.
 - Push [DISPLAY] once or twice to select M.
 - Push [MENU] one or more times to select M4.
 - Push [(F-2)KEY] for 1 sec. to enter the keyer set mode.
- ② Push [MENU] one or more times to select "K4 CW PADDLE," then rotate the main dial to select the paddle type.
 - When "ud" is selected, the up/down switches on the microphone can be used as a paddle.
- ③ Push [MENU] one more time to select item "K5 RATIO," then rotate the main dial to select the desired weight.
 - Key weight can be selected from 2.8 to 4.5.
 - Check the selected ratio with the side tone function in CW mode.
- ④ Push [DISPLAY] momentarily to return to M4.
- ⑤ Push [DISPLAY] for 1 sec. to enter quick set mode.
- ⑥ Push [MENU] once or twice to select "Q2 KEY SPEED," then rotate the main dial to select the desired keying speed.
 - [M-CH] or [▲]/[▼] can also be used to select "Q2 KEY SPEED."
 - Keying speed can be selected from 6 to 60 wpm.
- ⑦ Push [DISPLAY] momentarily to return to M4.

Paddle operation from front panel MIC connector

Connect a CW paddle as at right to operate an electronic keyer from the front panel MIC connector.

- This function is available from the front panel mic connector only.
- Be sure to select item "n," "r," "buG" or "oFF" in K4 CW PADDLE in the keyer set mode. (p. 32)
- Connect straight key to "DOT" side.

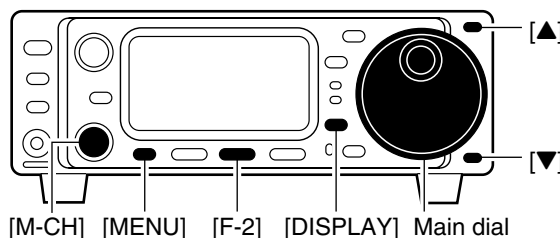

KEYING WEIGHT EXAMPLE: morse code "K"

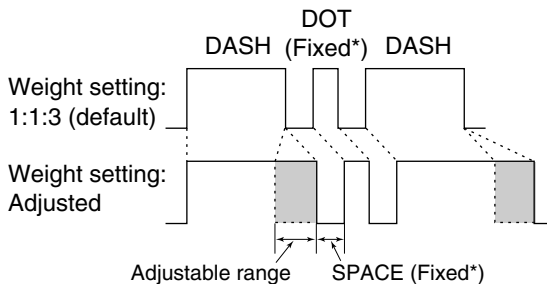

*SPACE and DOT length can be adjusted with "Q2 KEY SPEED" only.

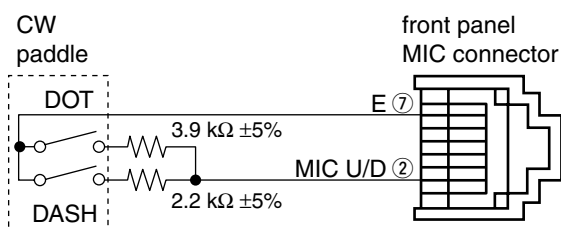

◇ CW side tone function

When the transceiver is in the receive condition (and the break-in function is OFF— below) you can listen to the tone of your CW signal without actually transmitting. This allows you to match your transmit signal exactly to another station's. This also convenient for CW practice. CW side tone level can be adjusted in the initial set mode (p. 77).

◇ Keyer set mode

While M4 is selected in CW mode, push [(F-2)KEY] for 1 sec. to enter the keyer set mode.

K1 BK-IN

This item sets the CW break-in operation. The break-in operation is selectable from off, on and FULL.

CW

OFF

The default is OFF.

K2 BK-IN DELAY

This item adjusts break-in delay time for CW semi break-in operation. The delay time is selectable from 2.0 to 13.0 (dots).

CW

7.5

The default is 7.5 dots.

K3 CW PITCH

This item sets the CW pitch. CW pitch is adjustable from 300 to 900 Hz in 10 Hz steps.

CW

600

The default is 600 Hz.

K4 CW PADDLE

This item adjusts the CW paddle type. Four selections are available.

- n : normal (for electronic keyer use)
- r : reverse (for electronic keyer use)
- buG : When using the electronic keyer, key down produces a "dash," releasing the key automatically produces a "dot(s)."
- oFF : Turns OFF the electronic keyer (for straight key use)
- ud : For using the microphone's [UP]/[DN] keys instead of the CW paddle.

CW

n

The default is "n," normal.

K5 RATIO

This item adjusts the CW key ratio (or weight). The ratio can be selected from 2.8 to 4.5.

CW

3.0

The default is 3.0.

Memory keyer functions

The transceiver has a number of convenient functions for the electronic keyer that can be accessed from the memory keyer menu.

- ① Select CW mode with [MODE].
- ② Push [MODE] for 1 sec. to select the memory keyer send menu.
 - Push [MODE] momentarily to return to normal CW operating mode.
- ③ Push [DISPLAY] to enter the memory keyer menu.
 - Push [DISPLAY] momentarily to return to the memory keyer send menu.

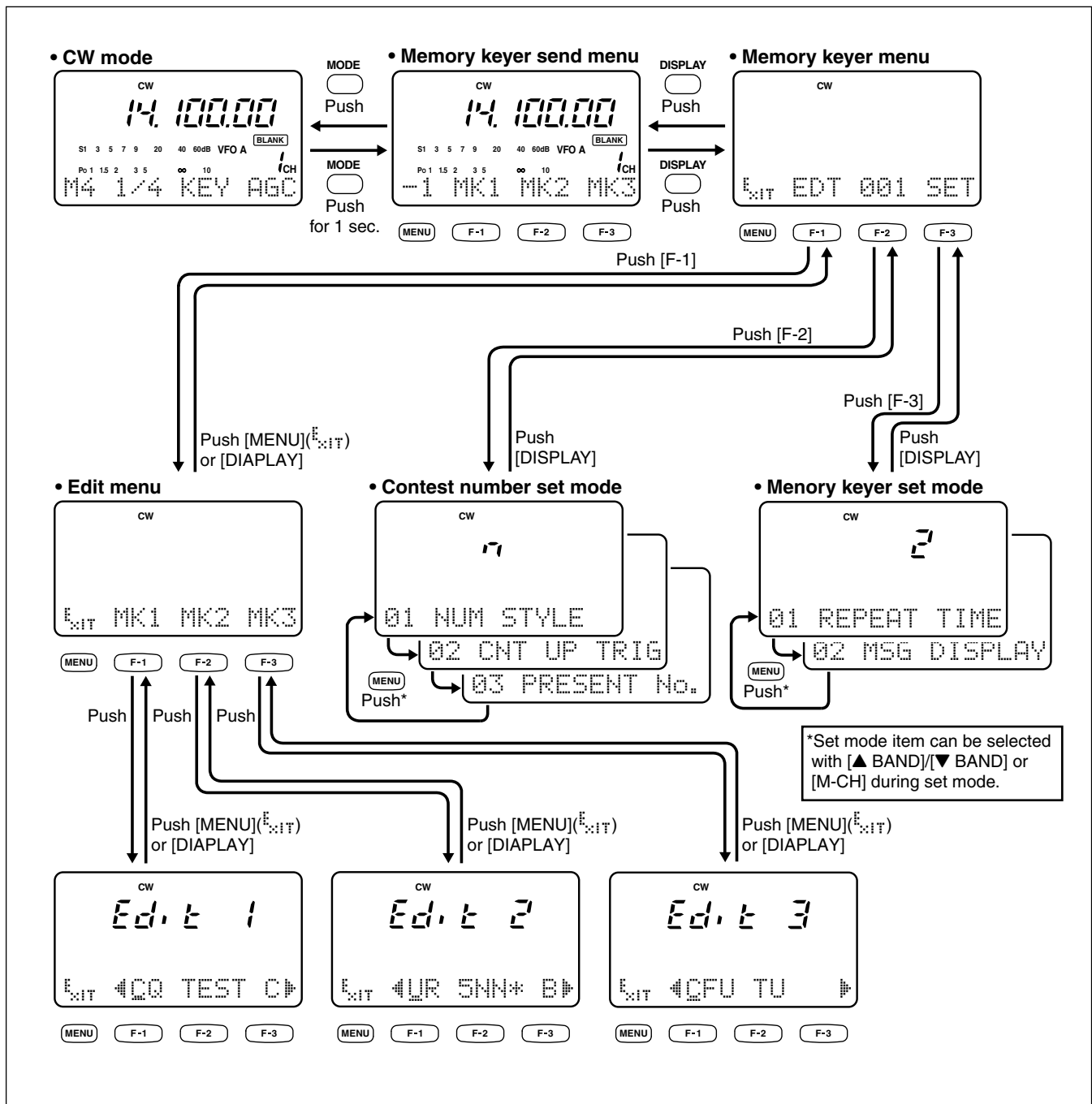
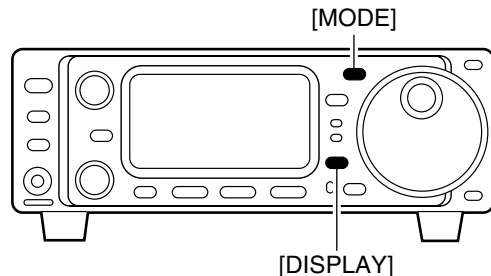

◇ Memory keyer send menu

Pre-set characters can be sent using the memory keyer send menu. Contents of the memory keyer are set using the edit menu.

• Transmitting

- ① Select CW mode with [MODE].
- ② Push [MODE] for 1 sec. to enter the memory keyer send menu.
- ③ Set the break-in function ON (p. 32).
 - When step ④ is performed during the break-in function OFF, monitors the memory keyer contents.
- ④ Push one of the function keys ([F-1]MK1) to [(F-3)MK3] to send the contents of the memory keyer.
 - Pushing a function key for 1 sec. repeatedly sends the contents and blinks "MK1," "MK2" or "MK3" indication; push any function key to cancel the transmission.
 - Keying with the connected straight key or paddle to [KEY] on the rear panel is also cancels the transmission.
 - Under bars (_ _ _) are indicated for the count up trigger set channel.
 - The contest number counter is incremented each time the contents are sent.
 - Push [MENU] to reduce the contest number count by 1 when resending contents to unanswered calls.
- ⑤ Push [MODE] momentarily to exit memory keyer send menu and return to normal CW mode indication.

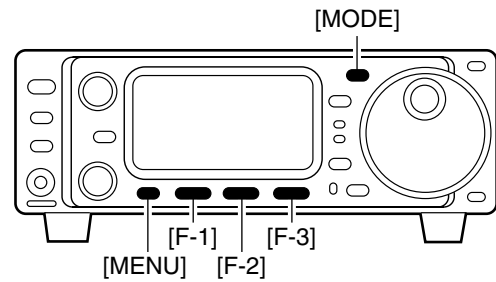

• Memory keyer send menu

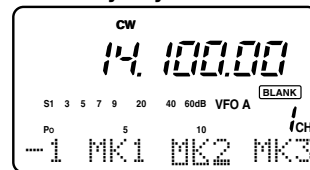

Sends [(F-1)MK1]–[(F-3)MK3] contents.

• Memory keyer send menu



Count up trigger indication

• MK1 send indication

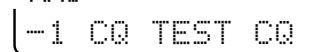

• MK2 send indication



Counter

• MK3 send indication



◇ Editing a memory keyer

The contents of the memory keyer memories can be set using the memory keyer edit menu. The memory keyer can memorize and re-transmit 3 CW key codes for often-used CW sentences, contest numbers, etc. Total capacity of the memory keyer is 50 characters per memory channel.

• Programming contents

- ① Select CW mode with [MODE].
- ② Enter the memory keyer menu.
 - Push [MODE] for 1 sec. to enter the memory keyer send menu.
 - Push [DISPLAY] momentarily to enter the memory keyer menu.
- ③ Push [(F-1)EDT] to enter the edit menu.
- ④ Push the multi-function key, [(F-1)MK1], [(F-2)MK2] or [(F-3)MK3], to select the desired memory keyer channel to be edited.
- ⑤ Input the desired character by rotating the main dial.
 - Selectable characters (with the main dial);

```

ABCDEFGHIJKLMN OPQRST
UVWXYZ / ? . , * ^
    
```

NOTE:

“^” is used to transmit a following word with no space such as AR. Put “^” before a text string such as ^AR, and the string “AR” is sent with no space.

“*” is used to insert the CW contest number. The contest number automatically increments by 1. This function is only available for one memory keyer channel at a time. Memory keyer channel MK2 used “*” by default.

Push [(F-2)] to erase characters.

- ⑥ Push [(F-1)←] or [(F-3)→] to move the cursor backwards or forwards, respectively.
- ⑦ Repeat steps ⑤ and ⑥ to input the desired characters.
- ⑧ Push [MENU] or [DISPLAY] three times to return to the keyer send menu.

Pre-programmed contents

CH	CONTENTS
MK1	CQ TEST CQ TEST DE ICOM ICOM T
MK2	UR 5NN* BK
MK3	CFM TU

• MK1 indication (default)

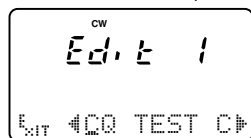

• MK2 indication (default)

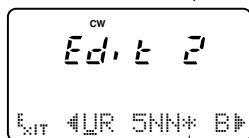

• MK3 indication (default)

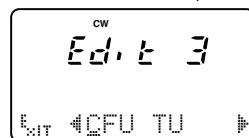

Contest number counter is set by entering an asterisk (*).

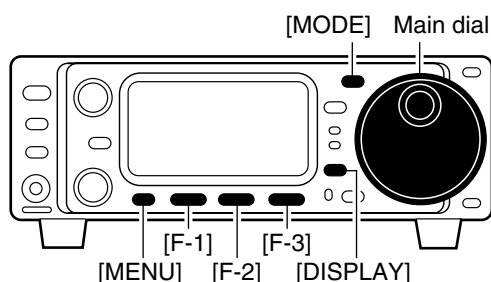

• Memory keyer menu

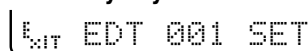

(F-1) Push

• Edit menu

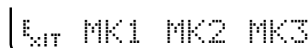

(F-3) Push

• MK3 indication (default)

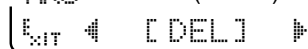

Displays “[DEL]” for 1 sec. then shows the default contents.

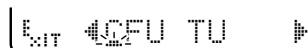

(F-2)

Push [F-2] to erase characters.

• Example display— when inputting QSL TU DE JA3YUA TEST into MK3

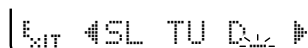
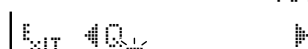

◇ Contest number set mode

This menu is used to set the contest (serial) number and count up trigger, etc.

•Setting contents

- ① Select CW mode with [MODE].
- ② Enter the memory keyer menu.
 - Push [MODE] for 1 sec. to enter the memory keyer send menu.
 - Push [DISPLAY] momentarily to enter the memory keyer menu.
- ③ Push [(F-2)001] to enter the contest number set mode.
- ④ Push [MENU] once or twice to select the desired set item.
 - [M-CH] or [▲]/[▼] can also be used.
- ⑤ Set the desired condition using the main dial.
- ⑥ Push [DISPLAY] twice to return to the memory keyer send menu.

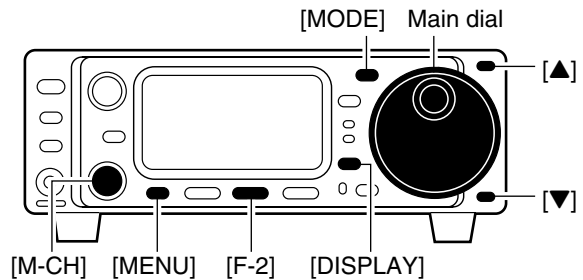

01 NUM STYLE (Number style)

This item sets the numbering system used for contest (serial) numbers— normal or morse cut numbers.

- n : Does not use morse cut number (default)
- 190.Ano : Sets 1 as A, 9 as N and 0 as O.
- 190.Ant : Sets 1 as A, 9 as N and 0 as T.
- 90.no : Sets 9 as N and 0 as O.
- 90.nt : Sets 9 as N and 0 as T.

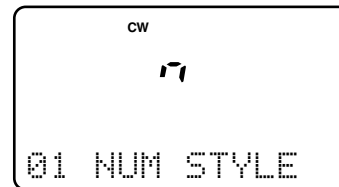

02 CNT UP TRIG (Count up trigger)

This selects which of the three memory slots will have the contest serial number exchange. The count up trigger allows the serial number automatically incremented after each complete serial number exchange is sent.

- 1 (MK1), 2 (MK2) and 3 (MK3) can be set. (default: 2)

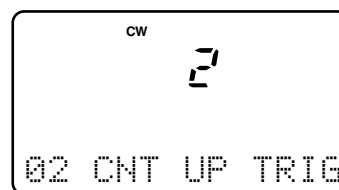

03 PRESENT No. (Present number)

This item shows the current number for the count up trigger channel set above.

- Rotate the tuning dial to change the number.

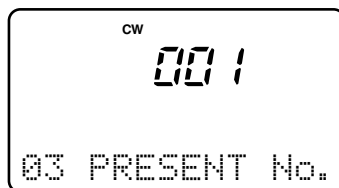

4 RECEIVE AND TRANSMIT

◇ Memory keyer set mode

This set mode is used to set the memory keyer repeat time and indication type of the messages.

•Setting contents

- ① Select CW mode with [MODE].
- ② Enter the memory keyer menu.
 - Push [MODE] for 1 sec. to enter the memory keyer send menu.
 - Push [DISPLAY] momentarily to enter the memory keyer menu.
- ③ Push [(F-3)SET] to enter the memory keyer set mode.
- ④ Push [MENU] to select the desired set item.
 - [M-CH] or [▲]/[▼] can also be used.
- ⑤ Set the desired condition using the main dial.
- ⑥ Push [DISPLAY] twice to return to the memory keyer send menu.

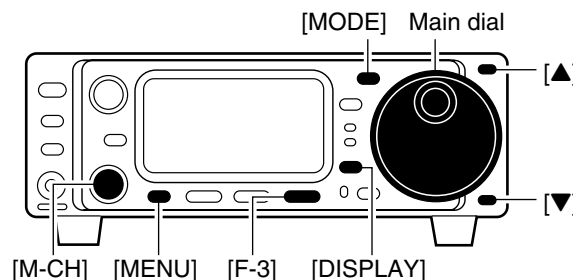

01 REPEAT TIME (Repeat time)

When sending CW using the repeat timer, this item sets the time between transmission.

- 1 to 60 sec. in 1 sec. steps can be selected.

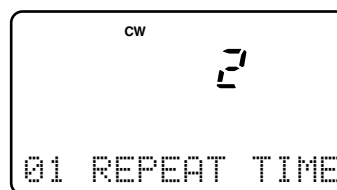

02 MSG DISPLAY (Message display)

This item sets the indication type of the messages (pre-set characters).

- n : Normal indication (default)
[(F-1)MK1], [(F-2)MK2], [(F-3)MK3]
- 3 : First three characters of the messages are indicated.
e.g. [(F-1)CQ], [(F-2)UR], [(F-3)CFM]
- 3.cn : First three characters of the messages and contest number are indicated.
e.g. [(F-1)CQ], [(F-2)001], [(F-3)CFM]



■ Operating RTTY

◇ Connections for RTTY (FSK)

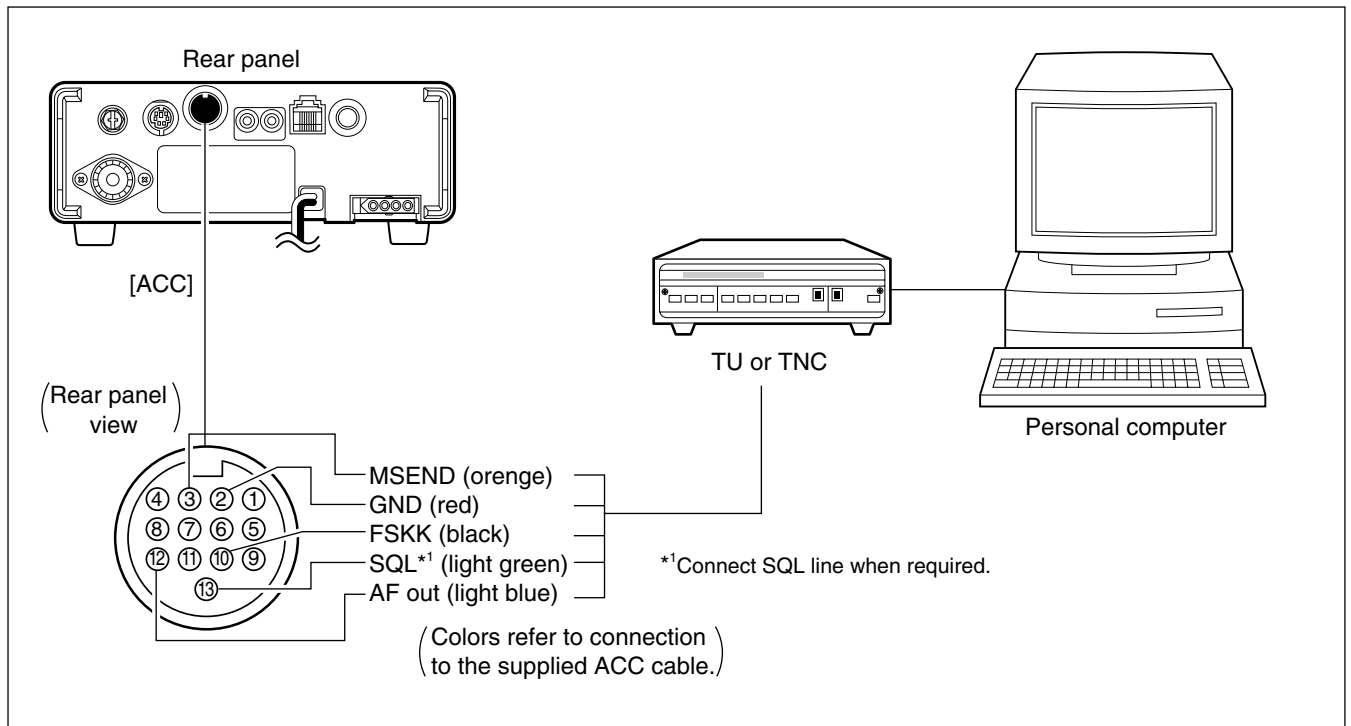

◇ RTTY (FSK) operation

- ① Connect a terminal unit as at above.
- ② Push [(▲)BAND]/[(▼)BAND] to select the desired band.
- ③ Push [MODE] momentarily to select RTTY mode.
 - After RTTY mode is selected, push [MODE] for 1 sec. to toggle between RTTY and SSB-D modes.
- ④ While the quick set mode item "02" is selected in RTTY mode, rotate main dial to select RTTY or **RTTY** mode.
 - Push [DISPLAY] for 1 sec. to enter the quick set mode.
 - Push [MENU] one or more times to select 02.
 - Push [DISPLAY] momentarily to return to normal operating mode.
- ⑤ Rotate [AF] to set audio to a comfortable listening level.
- ⑥ Select the desired FSK tone/shift frequencies and keying polarity as at page 40.
- ⑦ Rotate the main dial to tune a desired signal.
 - Use [(F-1)1/4] in the M4 display when critical setting is required.
 - S-meter indicates received signal strength.
 - If the received signal cannot be demodulated, try selecting **RTTY** mode (or RTTY mode).
- ⑧ Transmit a SEND signal from your TNC.
 - The TX indicator lights red.
 - The Po meter indicates transmitted RTTY signal strength.
- ⑨ Operate the connected PC or TNC (TU) to transmit RTTY (FSK) signals.

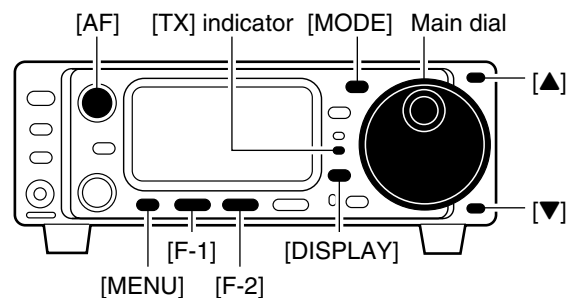

"RTTY" or "**RTTY**" appears

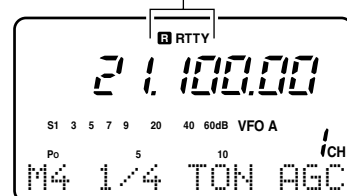

◇ Convenient functions for receive

• **Preamp and attenuator** (p. 46)

- ➔ Push [P.AMP/ATT] momentarily to set the preamp ON or OFF.
 - Lights green when the preamp is set to ON.
- ➔ Push [P.AMP/ATT] for 1 sec. to set the attenuator ON.
 - Push [P.AMP/ATT] momentarily to turn the attenuator OFF.
 - Lights red when the attenuator is set to ON.

• **Noise blanker** (p. 48)

- ➔ While "M3" is selected, push [(F-2)NB] to turn the noise blanker ON and OFF.
 - Push [DISPLAY] once or twice to select M.
 - Push [MENU] one or more times to select M3.
 - "NB" appears when the noise blanker is set to ON.
 - Push [(F-2)NB] for 1 sec. to enter the noise blanker set mode.

• **AGC (auto gain control)** (p. 48)

- ➔ While "M4" is selected, push [(F-3)AGC] to select AGC fast and AGC slow.
 - Push [DISPLAY] once or twice to select M.
 - Push [MENU] one or more times to select M4.
 - "FAGC" appears when the fast time constant is selected.

• **IF shift** (p. 47)

- ➔ Rotate [SHIFT] control.

• **Noise reduction** (p. 50)

- ➔ While "S4" is selected, push [(F-2)NR] to turn the noise reduction ON and OFF.
 - Push [DISPLAY] once or twice to select S.
 - Push [MENU] one or more times to select S4.
 - Push [(F-3)NRL] then rotate [M-CH] to adjust the noise reduction level.
 - "NR" appears when the noise reduction is set to ON.

• **Auto notch filter** (p. 50)

- ➔ While "S4" is selected, push [(F-1)ANF] to turn the auto notch filter function ON and OFF.
 - "ANF" appears when the noise reduction is set to ON.

• **1/4 function**

- ➔ While "M4" is selected, push [(F-1)1/4] to turn the 1/4 function ON and OFF.
 - Push [DISPLAY] once or twice to select M.
 - Push [MENU] one or more times to select M4.

◇ RTTY reverse mode

QUICK SET MODE

Received characters are occasionally garbled when the receive signal is reversed between MARK and SPACE. This reversal can be caused by incorrect TNC connections, settings, commands, etc.

To receive a reversed RTTY signal correctly, select **RTTY** (RTTY reverse) mode.

- ① Select RTTY mode with [MODE].
- ② Push [DISPLAY] for 1 sec. to enter quick set mode.
- ③ Push [MENU] one or more times to select "02 RTTY REV," then rotate the main dial to select RTTY and **RTTY** modes.
 - Check the interference tone.
- ④ Push [DISPLAY] momentarily to exit quick set mode.

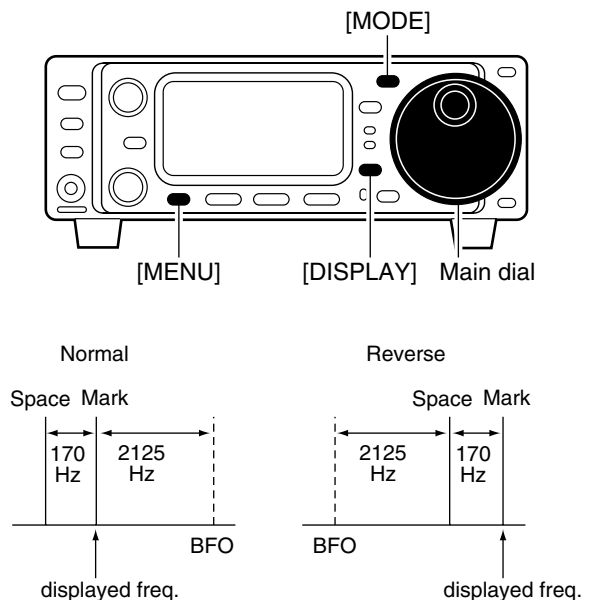

◇ Presetting for RTTY

Tone frequency

- ① Push [MODE] momentarily to select RTTY mode.
 - After RTTY mode is selected, push [MODE] for 1 sec. to toggle between RTTY and SSB-D modes.
- ② Enter the RTTY tone set mode.
 - Push [DISPLAY] once or twice to select M.
 - Push [MENU] one or more times to select M4.
 - Push [(F-2)TON] for 1 sec. to enter the RTTY tone set mode (below).
- ③ Push [MENU] one or more times to select "R1 RTTY TONE," then rotate the main dial to select the desired frequency.

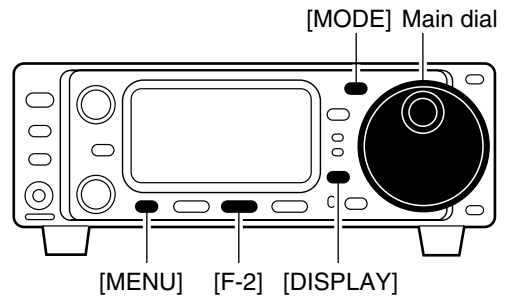

Shift frequency

- ① Enter the RTTY tone set mode as same as above.
- ② Push [MENU] one or more times to select "R2 RTTY SHIFT," then rotate the main dial to select the desired shift frequency.

RTTY keying

- ① Enter the RTTY tone set mode as same as above.
- ② Push [MENU] one or more times to select R3 RTTY KEYING; then rotate the main dial to select the desired keying polarity.

After presetting is finished, push [DISPLAY] momentarily to return the normal operating mode.



RTTY mark frequency is set to 2125 Hz.
2125, 1615 and 1275 Hz are available.



RTTY shift frequency is set to 170 Hz.
170/200/425 Hz are available.



RTTY keying is set to 'normal'.
normal :
key open=mark
key close=space
reverse:
key open=space
key close=mark

◇ RTTY tone set mode

While M4 is selected in RTTY mode, push [(F-2)TON] for 1 sec. to enter the RTTY tone set mode.

R1 RTTY TONE

This item selects the RTTY tone. RTTY tone is selected between 1275, 1615 and 2125 Hz.

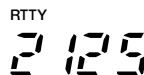

The default is 2125 Hz.

R2 RTTY SHIFT

This item adjusts the RTTY shift. There are 3 selectable values: 170, 200 and 425 Hz.



The default is 170 Hz.

R3 RTTY KEYING (RTTY only)

This item adjusts the RTTY keying. Normal or reverse keying can be selected.



The default is "n," normal.
Normal : key open=mark
Reverse : key open=space

■ Operating AM

- ① Push [(▲)BAND]/[(▼)BAND] to select the desired band.
- ② Push [MODE] momentarily or push for 1 sec. to select AM mode.
 - After FM or AM mode is selected, push [MODE] for 1 sec. to toggle between FM and AM modes.
- ③ Rotate [AF] control to set audio to a comfortable listening level.
- ④ Rotate the main dial to tune a desired signal.
 - S-meter indicates received signal strength.
 - The default tuning step for AM mode is 1 kHz; this can be changed using the tuning step program mode. (p.19)
- ⑤ Push [PTT] (microphone) to transmit.
 - The TX indicator lights red.
- ⑥ Speak into the microphone at your normal voice level.
 - Adjust 'MIC GAIN' at this step, if necessary. (p. 26)
- ⑦ Release [PTT] (microphone) to return to receive.

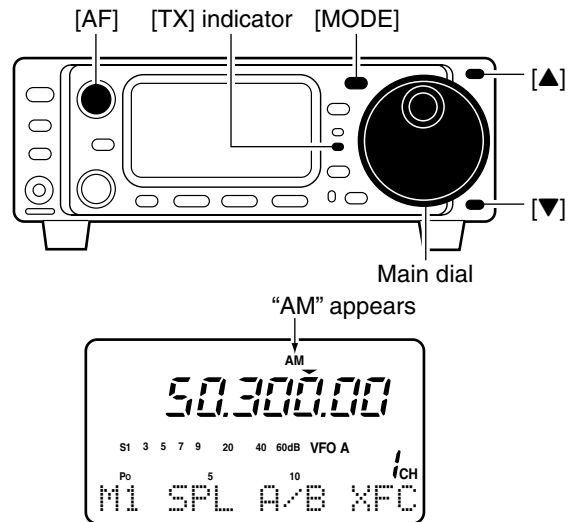

◇ Convenient functions for receive

• Preamp and attenuator (p. 46)

- ➔ Push [P.AMP/ATT] momentarily to set the preamp ON or OFF.
 - Lights green when the preamp is set to ON.
- ➔ Push [P.AMP/ATT] for 1 sec. to set the attenuator ON.
 - Push [P.AMP/ATT] momentarily to turn the attenuator OFF.
 - Lights red when the attenuator is set to ON.

• Noise blanker (p. 48)

- ➔ While "M3" is selected, push [(F-2)NB] to turn the noise blanker ON and OFF.
 - Push [DISPLAY] once or twice to select M.
 - Push [MENU] one or more times to select M3.
 - "NB" appears when the noise blanker is set to ON.
 - Push [(F-2)NB] for 1 sec. to enter the noise blanker set mode.
 - Initial set mode item "30 AM NB" (p. 80) must be set ON when noise blanker function is used in AM mode. (Default setting is ON.)

• IF shift (p. 47)

- ➔ Rotate [SHIFT] control.

• AGC (auto gain control) (p. 48)

- ➔ While "M4" is selected, push [(F-3)AGC] to select AGC fast and AGC slow.
 - Push [DISPLAY] once or twice to select M.
 - Push [MENU] one or more times to select M4.
 - "FAGC" appears when the fast time constant is selected.

• Noise reduction (p. 50)

- ➔ While "S4" is selected, push [(F-2)NR] to turn the noise reduction ON and OFF.
 - Push [DISPLAY] once or twice to select S.
 - Push [MENU] one or more times to select S4.
 - Push [(F-3)NRL] then rotate [M-CH] to adjust the noise reduction level.
 - "NR" appears when the noise reduction is set to ON.

• Auto notch filter (p. 50)

- ➔ While "S4" is selected, push [(F-1)ANF] to turn the auto notch filter function ON and OFF.
 - "ANF" appears when the noise reduction is set to ON.

◇ Convenient functions for transmit

• Speech compressor (p. 54)

- ➔ While "M4" is selected, push [(F-2)COM] to turn the speech compressor ON and OFF.
 - Push [DISPLAY] once or twice to select M.
 - Push [MENU] one or more times to select M4.
 - "COM" appears when the speech compressor is set to ON.
 - Push [(F-2)COM] for 1 sec. to enter the compression level set mode.

• VOX (voice operated transmit) (p. 53)

- ➔ While "M4" is selected, push [(F-1)VOX] to turn the VOX function ON and OFF.
 - Push [DISPLAY] once or twice to select M.
 - Push [MENU] one or more times to select M4.
 - "VOX" appears when the VOX function is set to ON.
 - Push [(F-1)VOX] for 1 sec. to enter the VOX set mode.

■ Operating FM

- ① Push [(▲)BAND]/[(▼)BAND] to select the desired band.
- ② Push [MODE] momentarily or for 1 sec. to select FM mode.
 - After FM or AM mode is selected, push [MODE] for 1 sec. to toggle between FM and AM modes.
- ③ Rotate [AF] control to set audio to a comfortable listening level.
- ④ Rotate the main dial to tune a desired signal.
 - S-meter indicates received signal strength.
 - The default tuning step for FM mode is 1 kHz; this can be changed using the tuning step program mode. (p.19)
- ⑤ Push [PTT] (microphone) to transmit.
 - The TX indicator lights red.
- ⑥ Speak into the microphone at your normal voice level.
 - Adjust 'MIC GAIN' at this step, if necessary. (p. 26)
- ⑦ Release [PTT] (microphone) to return to receive.

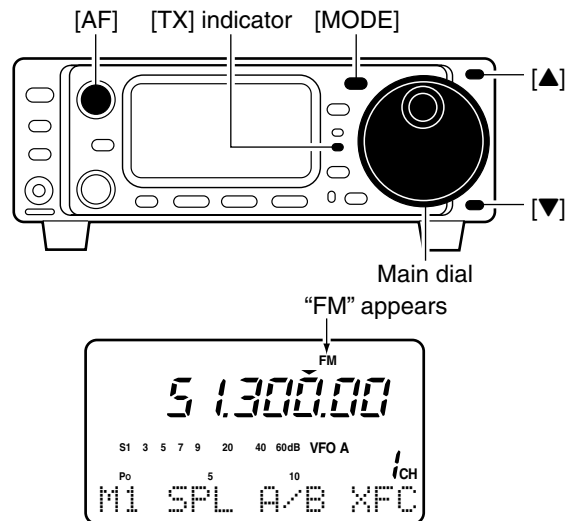

◇ Convenient functions for receive

• Preamp and attenuator (p. 46)

- ➔ Push [P.AMP/ATT] momentarily to set the preamp ON or OFF.
 - Lights green when the preamp is set to ON.
- ➔ Push [P.AMP/ATT] for 1 sec. to set the attenuator ON.
 - Push [P.AMP/ATT] momentarily to turn the attenuator OFF.
 - Lights red when the attenuator is set to ON.

• IF shift (p. 47)

- ➔ Rotate [SHIFT] control.

• Noise reduction (p. 50)

- ➔ While "S4" is selected, push [(F-2)NR] to turn the noise reduction ON and OFF.
 - Push [DISPLAY] once or twice to select S.
 - Push [MENU] one or more times to select S4.
 - Push [(F-3)NRL] then rotate [M-CH] to adjust the noise reduction level.
 - "NR" appears when the noise reduction is set to ON.

• Auto notch filter (p. 50)

- ➔ While "S4" is selected, push [(F-1)ANF] to turn the auto notch filter function ON and OFF.
 - "ANF" appears when the noise reduction is set to ON.

◇ Convenient functions for transmit

• VOX (voice operated transmit) (p. 53)

- ➔ While "M4" is selected, push [(F-1)VOX] to turn the VOX function ON and OFF.
 - Push [DISPLAY] once or twice to select M.
 - Push [MENU] one or more times to select M4.
 - "VOX" appears when the VOX function is set to ON.
 - Push [(F-1)VOX] for 1 sec. to enter the VOX set mode.

◇ Tone squelch operation

Tone squelch operation is a method of communications using selective calling. Only received signals having a matching tone will open the squelch. Before communicating using tone squelch, all members of your party must agree on the tone squelch frequency to use.

- ① Push [MODE] one or more times to select FM mode.
- ② Select M4.
 - Push [DISPLAY] once or twice to select M.
 - Push [MENU] one or more times to select M4.
- ③ Push [(F-2)TON] for 1 sec. to enter the FM tone set mode.
 - Push [MENU] one or more times to select "T2 TONE SQL."
- ④ Rotate the main dial to set the desired subaudible tone frequency.
 - See left table for available tone frequencies.
 - Push [DISPLAY] to exit the FM tone set mode.
- ⑤ Push [(F-2)TON] once or twice to turn the tone squelch function.
 - "TSQL" appears.
- ⑥ Communicate in the usual manner.
 - Push [PTT] to transmit; release to receive.

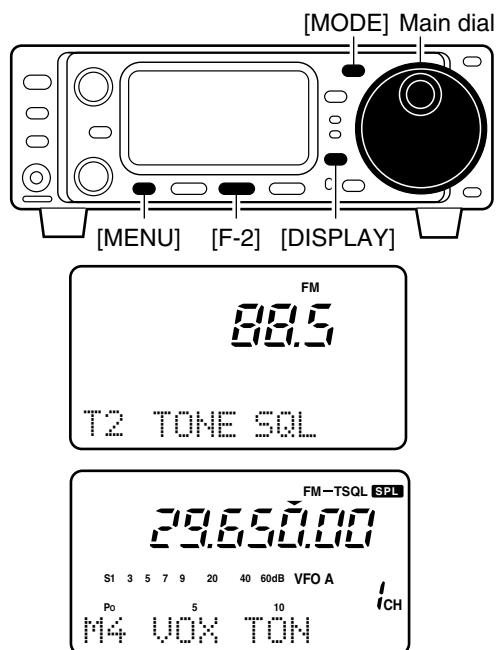

• Available tone squelch frequencies (Unit: Hz)

67.0	85.4	107.2	136.5	165.5	186.2	210.7	254.1
69.3	88.5	110.9	141.3	167.9	189.9	218.1	
71.9	91.5	114.8	146.2	171.3	192.8	225.7	
74.4	94.8	118.8	151.4	173.8	196.6	229.1	
77.0	97.4	123.0	156.7	177.3	199.5	233.6	
79.7	100.0	127.3	159.8	179.9	203.5	241.8	
82.5	103.5	131.8	162.2	183.5	206.5	250.3	

◇ Tone scan operation

By monitoring a signal that is being transmitted on a repeater input frequency, you can determine the tone frequency necessary to open a repeater.

- ① During tone squelch or repeater operation ("T" or "TSQL" is displayed, select M4.
 - Push [DISPLAY] once or twice to select M.
 - Push [MENU] one or more times to select M4.
- ② Push [(F-2)TON] for 1 sec. to enter the FM tone set mode.
 - Push [MENU] one or more times to select "T3 T-SQL SCN" during tone squelch operation or "T3 RPTR-T SCN" during repeater operation.
 - If tone squelch function or tone encoder has not been selected, this item does not appear.
- ③ Push [(F-3)SCN] to toggle the tone scan operation ON and OFF.
 - While scanning, tone frequencies are displayed instead of the operating frequency.
 - When a matched tone is detected, tone scan automatically stops, the matched tone is displayed and the repeater tone (or tone squelch tone) setting is automatically adjusted accordingly.
- ④ Push [DISPLAY] to exit the FM tone set mode.

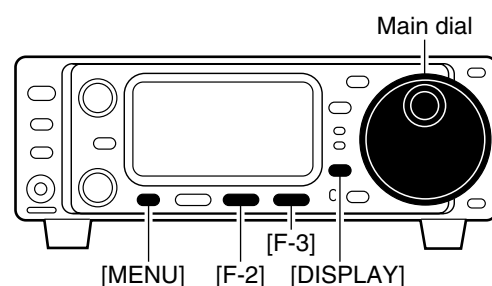

During tone squelch operation.

During repeater operation.

◇ FM tone set mode

While M4 is selected in FM mode, push [(F-2)TON] for 1 sec. to enter the FM tone set mode.

T1 RPTR TONE

This item selects a subaudible tone for FM-T mode operation to access a repeater. There are 50 tones available from 67.0 Hz to 254.1 Hz (see table at right).

FM
88.5

The default is 88.5 Hz.

• Available subaudible tone frequencies (Unit: Hz)

67.0	85.4	107.2	136.5	165.5	186.2	210.7	254.1
69.3	88.5	110.9	141.3	167.9	189.9	218.1	
71.9	91.5	114.8	146.2	171.3	192.8	225.7	
74.4	94.8	118.8	151.4	173.8	196.6	229.1	
77.0	97.4	123.0	156.7	177.3	199.5	233.6	
79.7	100.0	127.3	159.8	179.9	203.5	241.8	
82.5	103.5	131.8	162.2	183.5	206.5	250.3	

T2 TONE SOL

This item sets a subaudible tone for tone squelch use. The same subaudible tone frequencies as for repeater operation are available—see above

FM
88.5

The default is 88.5 Hz.

T3 RPTR-T SCN (Repeater tone scan)

During repeater operation, you can detect the tone frequency necessary to open a repeater. (see p. 45)

FM-T
88.5

The default is 88.5 Hz.

T3 T-SQL SCN (Tone squelch tone scan)

During tone squelch operation, you can detect the tone frequency necessary to communicate using tone squelch. (see p. 43)

FM-TSQL
88.5

The default is 88.5 Hz.

■ Repeater operation

A repeater amplifies received signals and re-transmits them at a different frequency. When using a repeater, the transmit frequency is shifted from the receive frequency by an offset frequency. A repeater can be accessed using split frequency operation with the shift frequency set to the repeater's offset frequency.

- ① Set the offset frequency and turn ON the quick split function in initial set mode in advance (pgs. 79, 80).
 - If the quick split function is turned OFF, both transmit and receive must be set separately.
- ② Push [MODE] one or more times to select FM mode, then set the receive frequency.
- ③ Select M1.
 - Push [DISPLAY] once or twice to select M.
 - Push [MENU] one or more times to select M1.
- ④ Push [(F-1)SPL] for 1 sec. to activate the split frequency function with the pre-selected offset.
- ⑤ Select M4.
 - Push [MENU] one or more times to select M4.
- ⑥ Push [(F-2)TON] for 1 sec. to enter the FM tone set mode.
 - If FM mode has not been selected, this item does not appear.
 - Push [MENU] one or more times to select "T1 RPTR TONE."
 - Rotate the main dial to set a subaudible tone frequency.
 - Push [DISPLAY] to exit the FM tone set mode.
- ⑦ Push [(F-2)TON] to turn the tone encoder.
 - "T" appears.
- ⑧ To check the repeater input frequency (direct signal from the other station), push and hold [(F-3)XFC] in the M1 display.
- ⑨ To return to simplex operation, push [(F-1)SPL] in the M1 display.

NOTE: The split function may not be turned off when you change the operating band, push [(F-1)SPL] again to turn off the split function after you finish the repeater operation.

CONVENIENT

Each memory channel can store a tone frequency and an offset frequency, as well as the operating frequency. Store repeater information into memory channels for quick and easy access to repeaters.

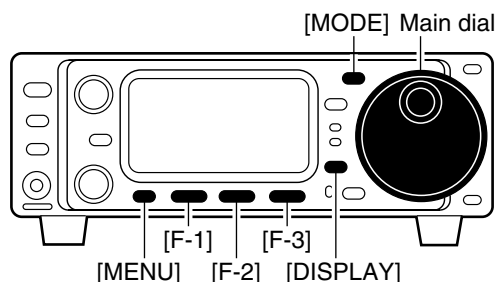

Turn the quick split function ON. (Initial set mode default is ON.)

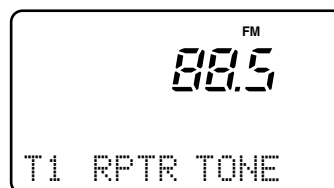

Set the tone frequency. See below table for available frequencies.

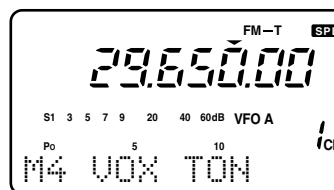

• Available subaudible tone frequencies (Unit: Hz)

67.0	85.4	107.2	136.5	165.5	186.2	210.7	254.1
69.3	88.5	110.9	141.3	167.9	189.9	218.1	
71.9	91.5	114.8	146.2	171.3	192.8	225.7	
74.4	94.8	118.8	151.4	173.8	196.6	229.1	
77.0	97.4	123.0	156.7	177.3	199.5	233.6	
79.7	100.0	127.3	159.8	179.9	203.5	241.8	
82.5	103.5	131.8	162.2	183.5	206.5	250.3	

Simple band scope

This function allows you to visually “sweep” an area surrounding the set frequency for other signals. Detected signals are indicated graphically in the dot matrix section of the display.

NOTE: Use the attenuator or turn OFF the preamp when using the band scope on a band containing a lot of noise.

- ① Set a mode and frequency.
- ② Select G1.
 - Push [DISPLAY] once or twice to select G.
 - Push [MENU] one or more times to select G1.
- ③ Push [F-1] one or more times to select the desired steps.
 - Each dot corresponds to a step for the indicated frequency.
 - 0.5k, 1k, 2k, 5k, 10k, 20k and 0.1M (100 kHz) can be set for the scope step.
- ④ Push [F-3] to start the sweep.
 - “_____” (below SWP) flashes while sweeping.
 - The receive audio is muted while sweeping.
- ⑤ Rotate the main dial if you want to monitor the displayed signals.
 - The sweep marker indicates the location of the displayed frequency in the sweep readout.
 - If the displayed frequency is outside of the sweep readout (determined by the sweep width), the sweep marker flashes.
- ⑥ Push [F-2] to return the frequency to the start of a sweep.
 - The sweep marker moves back to the center position.

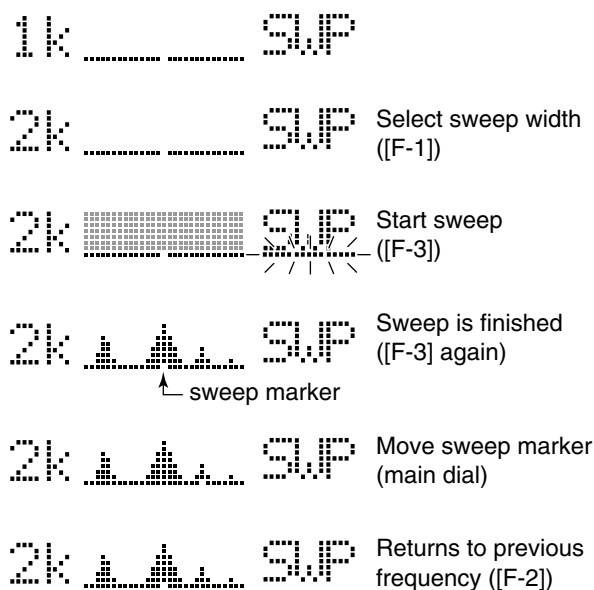
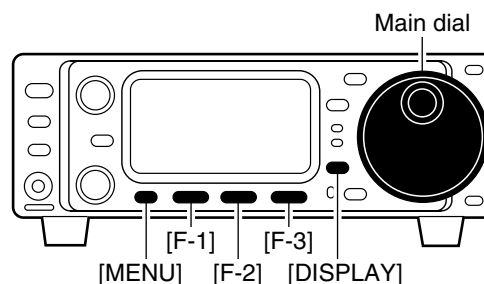

Preamp and attenuator

The *preamp* amplifies received signals in the front end circuit to improve the S/N ratio and sensitivity. Turn this function ON when receiving weak signals.

The *attenuator* prevents desired signals from distorting when very strong signals are near the desired frequency or when very strong electric fields, such as from broadcasting stations, are near your location.

Push [P.AMP/ATT] momentarily to turn the preamp ON and OFF; push for 1 sec. to turn the attenuator ON.

- Lights green when the preamp is ON; lights red when the 20 dB attenuator is ON.
- Only one of these functions can be activated at a time.



Lights green while the preamp is activated; lights red while the attenuator is activated.

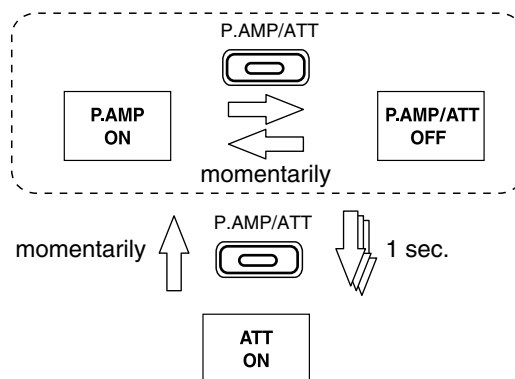
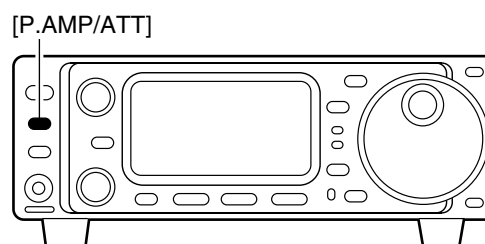

■ RIT function

The RIT (Receive Incremental Tuning) function compensates for off-frequencies of communicating stations. The function shifts the receive frequency up to ± 9.99 kHz in 10 Hz steps without moving the transmit frequency. "21 SUB DIAL" item in initial set mode must be set to RIT mode in advance. (p. 79)

- ① Push [RIT].
 - The [RIT] indicator lights red.
- ② Rotate the [M-CH] control to cancel the off-frequencies.
 - The transmit frequency is not shifted.
- ③ To cancel the RIT function, push [RIT] again.
 - The [RIT] switch indicator goes out.

• Calculate function

The shift frequency of the RIT function can be added/subtracted to the displayed frequency.

While the RIT indicator is lit, push and hold [RIT] for 1 sec.

NOTE: The RIT function is not available in FM or AM modes regardless of the Initial Set mode setting. (p. 79)

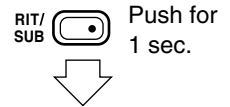
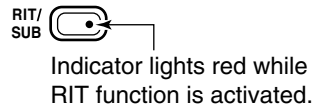
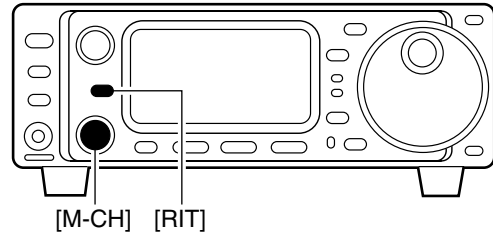

■ IF shift function

The IF shift function electronically changes the pass-band frequency of the IF (intermediate frequency) and cuts out higher or lower frequency components of the IF to reject interference. The function shifts the IF frequency up to ± 1.2 kHz in 15 Hz steps in SSB/CW/RTTY modes and up to ± 250 Hz in 3 Hz steps in CW-**N**/RTTY-**N** modes. The IF shift is not available in FM and AM modes.

(**N**: Narrow)

- ① Adjust the [SHIFT] control for a minimum interference signal level.
 - The audio tone may be changed while the IF shift is in use.
- ② Set the shift control to its center position when there is no interference.

• Graphic display

The IF shift is displayed graphically (for about 1 sec.) each time the shift control is rotated.

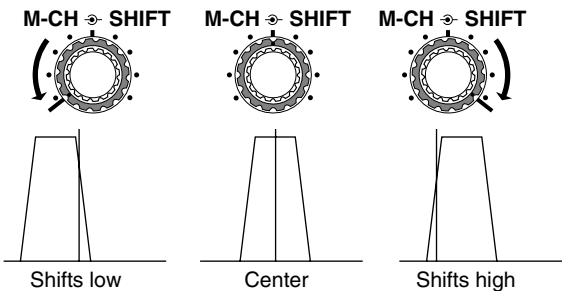
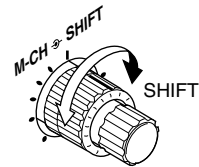
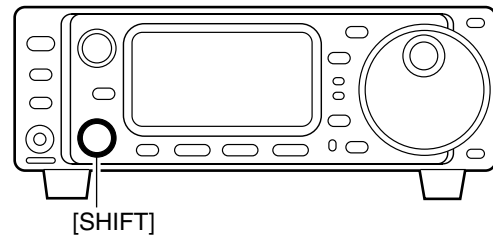
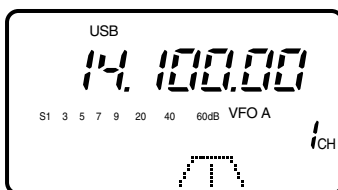

■ Noise blanker

The *noise blanker* reduces pulse-type noise such as that generated by automobile ignition systems. This function is not effective for FM mode or for non pulse-type noise. If you don't want to use the noise blanker for AM communications, the "30 AM NB" item in initial set mode must be turned OFF (ON is the default setting—p. 80).

- ① Select M3.
 - Push [DISPLAY] once or twice to select M.
 - Push [MENU] one or more times to select M3.
- ② Push [(F-2)NB] to toggle the noise blanker ON and OFF.
 - "NB" appears when the noise blanker is turned ON.
- ③ Push [(F-2)NB] for 1 sec. to enter the noise blanker level set mode (below).
- ④ Rotate the main dial to set the noise blanker level.
- ⑤ Push [DISPLAY] to exit the noise blanker level set mode.

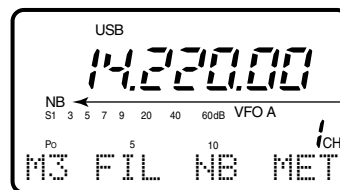
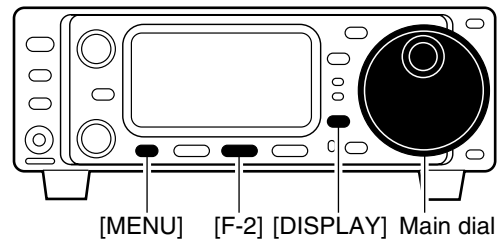

Appears when the noise blanker is turned ON.

◇ Noise blanker level set mode

While M3 is selected in all modes, push [(F-2)NB] for 1 sec. to enter the noise blanker level set mode.

M1 NB LEVEL

This item adjusts the noise blanker level. The noise blanker level can be adjusted from 0 to 10.

USB

5

The default is 5.

Although noise blanker level set mode is available in all modes, the noise blanker function is not effective for FM mode.

■ AGC time constant

The *AGC* (Automatic Gain Control) controls receiver gain to produce a constant audio output level even when the received signal strength is varied by fading, etc. Use AGC slow for normal phone operation; AGC fast for receiving data and searching for signals. AGC time constant cannot be changed in FM mode.

- ① Select M4.
 - Push [DISPLAY] once or twice to select M.
 - Push [MENU] one or more times to select M4.
- ② Push [(F-3)AGC] to toggle the AGC time constant between fast and slow.
 - "FAGC" appears when the fast time constant is selected.

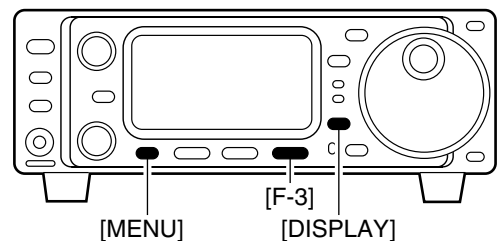

Appears when AGC fast is selected.

Optional filter selection

One optional filter can be installed in the IC-703.

Narrow filters help reject interference from adjacent signals and obtain good selectivity.

Wide filters provide improved audio for SSB operation when no interfering signals are present.

Consult the table below to select a filter most suitable for your operating needs.

Narrow filters for AM/FM modes are standard.

FILTER PRESETTING:

After you install a filter (see p. 87 for installation), you must specify the installed filter in initial set mode (item "22 OPT. FIL"; see p. 79).

FILTER ON/OFF:

- ① Select M3.
 - Push [DISPLAY] once or twice to select M.
 - Push [MENU] one or more times to select M3.
- ② Push [(F-1)FIL.] momentarily to select the narrow filter; push for 1 sec. to select the wide filter.
 - **N** appears when the narrow filter is selected; **W** appears when the wide filter is selected.

NOTE: When selecting the narrow filter (or wide filter), the graphic passband is changed. (see diagram below)

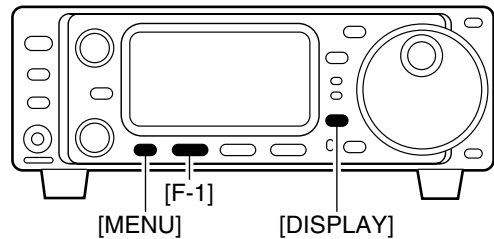
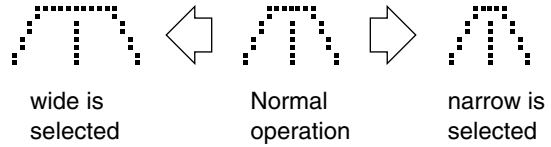

Filter variations

Name	Mode	Bandwidth
FL-53A*	CW, RTTY	250 Hz/-6 dB
FL-52A*	CW, RTTY	500 Hz/-6 dB
FL-222*	SSB, CW, RTTY	1.8 kHz/-6 dB
FL-65	SSB, CW, RTTY	2.3 kHz/-6 dB
FL-96**	SSB, CW, RTTY	2.8 kHz/-6 dB
FL-257*	SSB, CW, RTTY	3.3 kHz/-6 dB

*Optional filter.

**Although the FL-96 is not listed on the option list, IC-703 would take FL-96 as well as other optional filter.

Optional filter installation and selection tables

SSB, CW, RTTY

Bandwidth Filter	Narrow	Medium	Wide
No optional filter	————	FL-65 (2.3 k)	————
FL-52A	FL-52A (500)	FL-65 (2.3 k)	————
FL-53A	FL-53A (250)	FL-65 (2.3 k)	————
FL-96	————	FL-65 (2.3 k)	FL-96 (2.8 k)
FL-222	FL222 (1.8 k)	FL-65 (2.3 k)	————
FL-257	————	FL-65 (2.3 k)	FL-257 (3.3 k)

AM	Normal	CFWS455G (8 k)
	Narrow	FL-65 (2.4 k)
FM	Normal	Through (15 k)
	Narrow	CFWS455G (8 k)

■ Peak meter hold

INITIAL SET MODE

The peak meter hold function freezes the highest displayed bar segment in any meter function for about 0.5 sec. so that you can more easily read the meter. This function can be turned ON and OFF in initial set mode (item "23 PEAK HOLD" ; see p. 79).

[EXAMPLE]:

S1 3 5 7 9 20 40 60dB Initial reception of a signal results in an S-meter reading of 40 dB.



S1 3 5 7 9 20 40 60dB The highest indicated bar remains displayed for about 0.5 sec. even when the signal strength decreases.



■ DSP Functions (may require an optional unit depending on version—see p. 92)

◇ ANF (Automatic Notch Filter) function

This function automatically attenuates beat tones, tuning signals, etc., even if they are moving. The automatic notch filter functions in SSB, FM and AM modes.

- ① Select S4 (DSP menu).
 - Push [DISPLAY] once or twice to select S.
 - Push [MENU] one or more times to select S4.
- ② Push [(F-1)ANF] to toggle the automatic notch filter ON and OFF.
 - "DSP" and "ANF" appear when the function is ON.

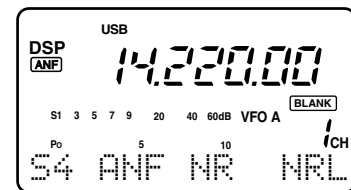
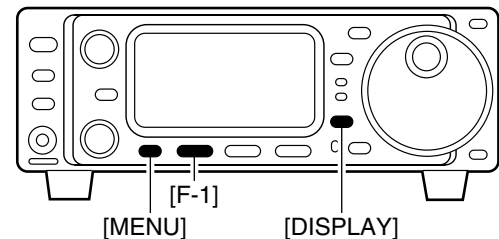

◇ NR (Noise Reduction) function

This function reduces noise components and picks out desired signals which are buried in noise. The received AF signals are converted to digital signals and then the desired signals are separated from the noise. The noise reduction function is available for all operating modes.

- ① Select S4 (DSP menu).
 - Push [DISPLAY] once or twice to select S.
 - Push [MENU] one or more times to select S4.
- ② Push [(F-2)NR] to toggle the noise reduction function ON and OFF.
 - "DSP" and "NR" appear when the function is ON.
- ③ Push [(F-3)NRL] to toggle the noise reduction level indication ON and OFF.
- ④ Rotate the [M-CH] control to set the noise reduction level.
 - Set the control for maximum readability. Deep rotation results in audio signal masking or distortion.

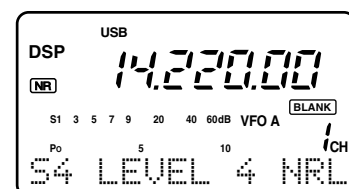
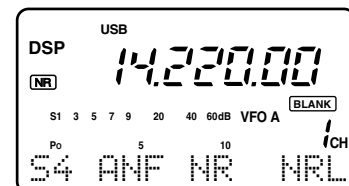
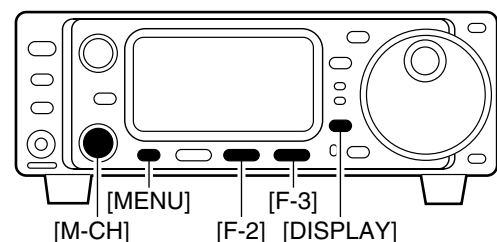

Split frequency operation

Split frequency operation allows you to transmit and receive on two different frequencies. Split frequency operation uses 2 frequencies, one in VFO A and the other in VFO B.

Following is an example of setting 7.057 MHz, CW mode in VFO A (for receiving) and 7.025 MHz, CW mode in VFO B (for transmitting).

- ① Select VFO A and set the frequency to 7.057 MHz/CW.
 - [(F-2)A/B] is available when M1 appears.
 - [(F-3)V/M] is available when M2 appears.
- ② Push or push and hold [(F-1)SPL] in the M1 display.
 - ➔ Push [SPL]: activates split only.
 - ➔ Push and hold [SPL]: activates the quick split next page.
- ③ To change the receive frequency, rotate the main dial; to change the transmit frequency, rotate the main dial while pushing [(F-3)XFC].
 - The transmit frequency can be monitored while pushing [(F-3)XFC].
 - Split operation is now set for receive on 7.057 MHz/CW and transmit on 7.025 MHz/CW.

To exchange the transmit and receive frequencies, push [(F-2)A/B] in M1.

CONVENIENT

The G3 display conveniently shows the transmit frequency during split frequency operation and pushing [(F-3)XFC] allows you to change the transmit frequency.

• Split lock function

The split lock function is convenient for changing only the transmit frequency. Otherwise, accidentally releasing the [(F-3)XFC] switch while rotating the main dial changes the receive frequency. The split lock's effectiveness can be selected in initial set mode (item "25 SPLIT LOCK") for both receive and transmit frequencies; or only the receive frequency. (p. 80)

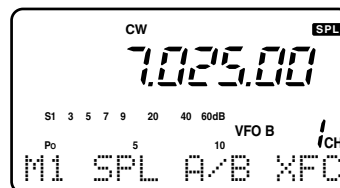
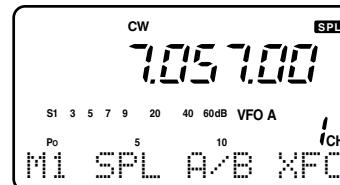
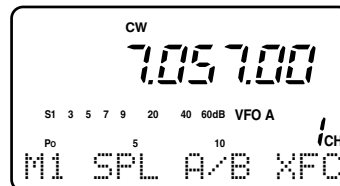
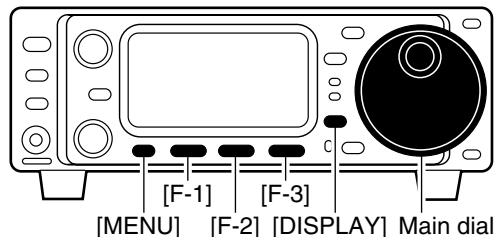

◇ Quick split function

In M1, when you push [(F-1)SPL] for 1 sec., split frequency operation is turned ON and VFO B is automatically changed according to the plus/minus pre-programmed shift frequency set in initial set mode (or equalized when 0 kHz is programmed as the split shift frequency). This shortens the time needed to start split frequency operation—great for DX'ing.

The quick split function is ON by default. If desired, it can be turned OFF in initial set mode (p. 79). In this case, pushing [(F-1)SPL] for 1 sec. has the same effect as pushing [(F-1)SPL] momentarily as in normal split operation.

PROGRAMMING SPLIT SHIFT FREQUENCY (p.80)

- ① Push [POWER] to turn power OFF.
- ② While pushing [LOCK], push [POWER] to turn power ON and enter initial set mode.
- ③ Select "26 SPL OFFSET" using [MENU], [M-CH] or the [▲]/[▼] keys, then rotate the main dial to select the desired split offset.
 - The split offset can be selected from -9.999 MHz to +9.999 MHz.

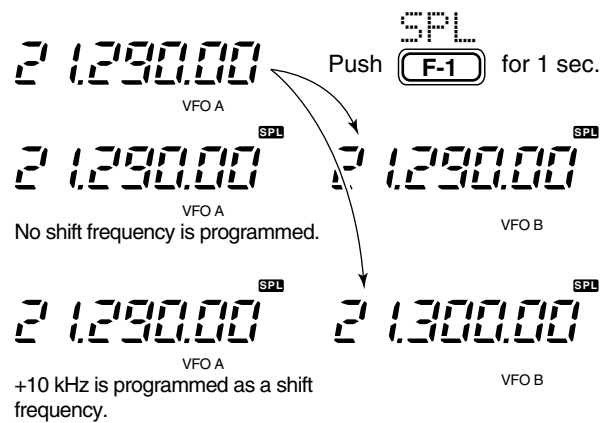
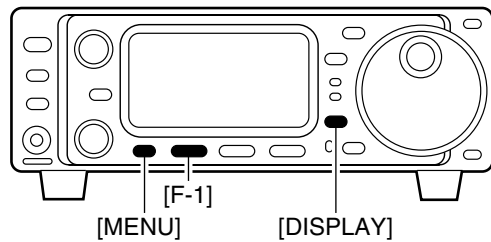

■ Meter selection

The bar meter in the function display acts as an S-meter for relative signal strength during receiving and can be selected for one of three types during transmitting.

- ① Select M3.
 - Push [DISPLAY] once or twice to select M.
 - Push [MENU] one or more times to select M3.
- ② Push [(F-3)MET] one or more times to select the desired meter function.
 - The display indication changes as in the table at right.

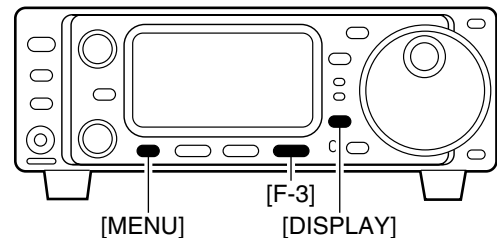

DISPLAY INDICATION	MEASUREMENT
Po	Indicates the relative RF output power.
ALC	Indicates the ALC level. When the meter movement shows the input signal level exceeds the allowable level, the ALC limits the RF power. In such cases, reduce the microphone gain (see above).
SWR	Indicates the SWR over the transmission line.

■ VOX operation

The VOX (Voice-operated Transmission) function toggles between transmit and receive with your voice. This function provides an opportunity to input log entries into your computer, etc., while operating.

- ① Select M4.
 - Push [DISPLAY] once or twice to select M.
 - Push [MENU] one or more times to select M4.
- ② Push [(F-1)VOX] to toggle the VOX function ON and OFF.
 - “VOX” appears when the function is ON.
- ③ Push [(F-1)VOX] for 1 sec. to enter the VOX set mode (below), then set the ‘VOX delay,’ ‘VOX gain’ and ‘ANTI-VOX’ if desired.
- ④ Select “VOX DELAY” in VOX set mode.
 - Push [MENU] one or more times to select U1.
 - While speaking into the microphone, adjust ‘VOX DELAY’ as desired.
- ⑤ Select “VOX GAIN” in VOX set mode.
 - Push [MENU] one or more times to select U2.
 - While speaking into the microphone, adjust ‘VOX GAIN’ until the transceiver is transmitting.
- ⑥ Select “ANTI VOX” in VOX set mode.
 - Push [MENU] one or more times to select U3.
 - If the receive audio from the speaker toggles the transceiver to transmit during receive, adjust the ‘ANTI-VOX’ to the point where it has no effect.
- ⑦ Push [DISPLAY] to exit VOX set mode.

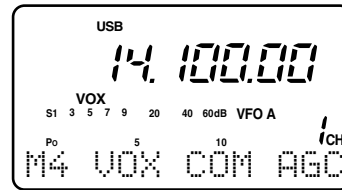
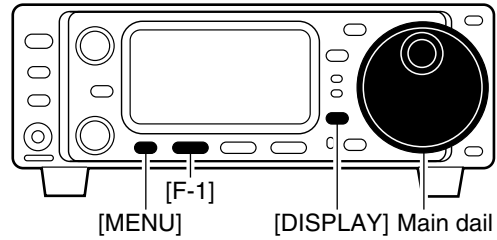

◇ VOX set mode

While M4 is selected in SSB/AM/FM modes, push [(F-1)VOX] for 1 sec. to enter the VOX set mode.

U1 VOX DELAY

This item adjusts the VOX (Voice-activated Transmit) delay time. The delay time can be adjusted from 0 to 2 sec. in 0.1 sec. steps.

USB

1.0 The default is 1.0 seconds.

U2 VOX GAIN

This item adjusts the VOX gain for the VOX (voice activated transmit) function.

USB

5 The default is 5.

U3 ANTI VOX

This item adjusts the ANTI-VOX gain for the VOX (voice activated transmit) function.

USB

5 The default is 5.

■ Speech compressor

The IC-703 has a built-in, low distortion speech compressor circuit. This circuit increases your average talk power in SSB mode and is especially useful for DX'ing when the receiving station is having difficulty copying your signal.

- ① Select USB or LSB mode.
- ② Select the mic gain display in quick set mode.
 - Push [DISPLAY] for 1 sec.
 - Push [MENU] one or more times to select "Q2 MIC GAIN."
 - The ALC meter is selected automatically when operating in SSB mode.
- ③ Adjust the mic gain.
- ④ Select the ALC meter.
 - Push [DISPLAY] once or twice to select M.
 - Push [MENU] one or more times to select M3, then push [(F-3)MET] one or more times to select "ALC."
- ⑤ Push [MENU] one or more times to select M4.
- ⑥ Push [(F-2)COM] to turn the speech compressor function ON.
 - "COM" appears.
- ⑦ Push [(F-2)COM] for 1 sec. to enter the compression level set mode (below).
- ⑧ Rotate the main dial to set the speech compression level.

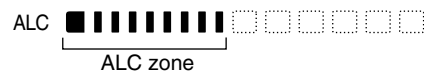
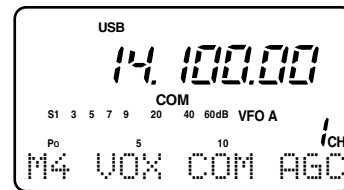
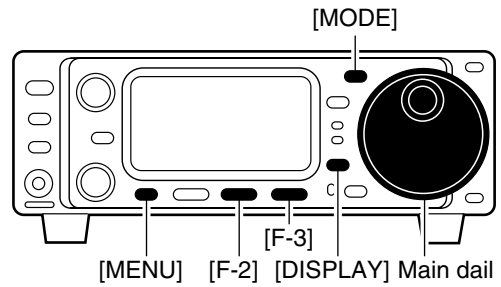

Adjust 'COMP LEVEL' so that the ALC meter reads within the ALC zone.

NOTE: When the ALC meter peaks above the ALC zone, your transmitted voice may be distorted.

◇ Compression level set mode

While M4 is selected in SSB/AM modes, push [(F-2)COM] for 1 sec. to enter the compression level set mode.

C1 COMP LEVEL

This item adjusts the speech compression level. The speech compression level can be adjusted from 0 to 10.

USB

5

The default is 5.

SWR

Measuring SWR

The IC-703 has a built-in circuit for measuring antenna SWR—no external equipment or special adjustments are necessary.

The IC-703 can measure SWR in 2 ways:
 (A) Spot measurement; or (B) Plot measurement.

(A) Spot measurement

- ① Confirm that the output power is over 5 W.
- ② Push [MENU] one or more times to select M3.
- ③ Push [(F-3)MET] to select the SWR meter.
- ④ Push [MODE] one or more times to select CW or RTTY operation.
 - Key down or push [PTT] to transmit; then read the actual SWR from the meter:
 - ➡ ≤ 1.5 well matched antenna
 - ➡ > 1.5 check antenna or cable connection, etc.

(B) Plot measurement

Plot measurement allows you to measure the SWR over an entire band.

- ① Confirm that the output power is over 5 W.
- ② Push [DISPLAY] once or twice to select G.
- ③ Push [MENU] one or more times to select G2.
- ④ Set the center frequency for the SWR to be measured.
- ⑤ Push and hold [(F-1)10k] one or more times to select the desired frequency pitch.
- ⑥ Push and hold [(F-2)] one or more times to select the desired step.
- ⑦ After selecting the desired pitch and step, push [(F-3)STR] to measure the SWR.
 - RTTY mode is selected automatically.
- ⑧ Push and hold [PTT] to display the SWR in a bar graph readout.
- ⑨ When [PTT] is released, the frequency marker and frequency indication move to the next frequency to be measured.

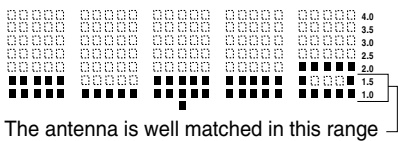

- ⑩ Repeat steps ⑧ and ⑨ to measure SWR over the entire frequency range.
- ⑪ When the measured SWR is less than 1.5, the antenna is well matched.

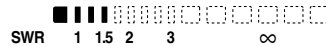
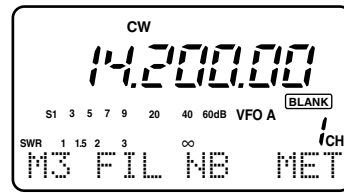
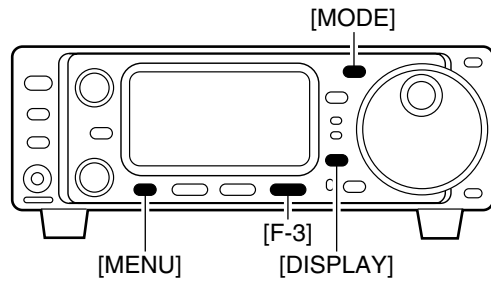

The best match is in this range.

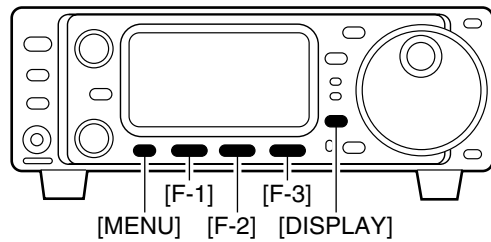

- Frequency span
- Step bar indication
- Frequency indication mark
- Measure start indicator

Span	Push [F-1] for 1 sec. to change the selected span.
Step bar	Push [F-2] to change the step bar (3, 5, 7 or 9 steps are available).
Marker	Indicates the currently active step bar.
Start	Flashes while the SWR is being measured.

Memory channels

The transceiver has 105 memory channels (includes 6 scan edge channels). Memory mode is useful for quickly changing to often-used frequencies.

NOTE: During split frequency operation, programmed memory contents can be called up to the SUB readout (dot matrix portion of the display).

All 105 memory channels are tuneable which means the programmed frequency can be tuned temporarily with the main dial, etc., in memory mode.

MEMORY CHANNEL	MEMORY CHANNEL NUMBER	CAPABILITY	TRANSFER TO VFO	OVER-WRITING	CLEAR
Regular (split memory)	1-99	Independent transmit and receive frequencies and one mode in each memory channel. In addition, tone frequencies can also be stored for repeater use.	Yes	Yes	Yes
Scan edges	1A-3B (3 pairs)	One frequency and one mode in each memory channel as scan edges for programmed scan.	Yes	Yes	No

Memory channel selection

- ① Select M2 functions.
 - Push [DISPLAY] once or twice to select M.
 - Push [MENU] one or more times to select M2.
- ② Push [(F-3)] to select memory mode.
- ③ Rotate [M-CH] to select the desired memory channel.
 - All memory channels including blank channels can be selected.
 - [UP]/[DN] on the microphone changes the frequency.
- ④ To return to VFO mode, push [(F-3)] again.

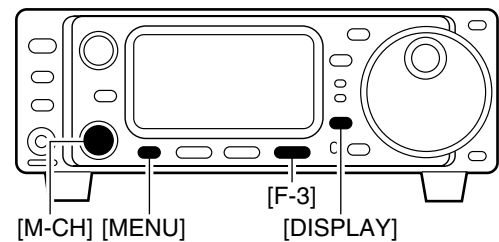

[EXAMPLE]: Selecting memory channel 17.

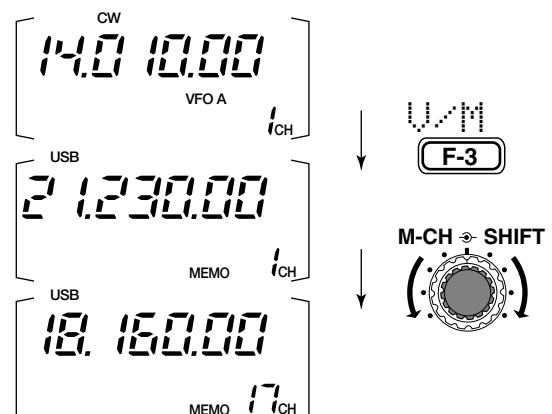

Memory programming

• Programming in VFO mode

- ① Select M2 functions.
 - Push [DISPLAY] once or twice to select M.
 - Push [MENU] one or more times to select M2.
- ② Set the desired frequency and operating mode in VFO mode.
 - If you want to program the split frequency function, program both receive and transmit frequencies into VFO A and B, then turn ON the split function.
 - If you want to program a repeater function, set a tone frequency (pgs. 44, 45) in addition to the receive/transmit frequencies.
- ③ Rotate [M-CH] to select the desired memory channel.
 - Select memory mode to confirm the contents, if desired.
 - “[BLANK]” appears if the selected memory channel is a blank channel (and does not have contents).
- ④ Push [(F-1)M] for 1 sec. to program the displayed frequency and operating mode into the memory channel.

To check the programmed contents, push [(F-3)M] to select memory mode.

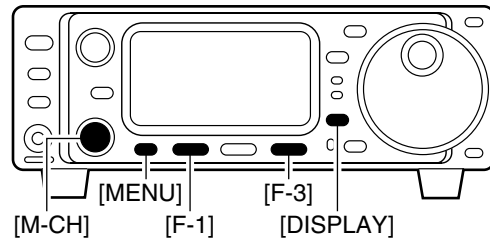

[EXAMPLE]: Programming 7.088 MHz/LSB into ch 12.

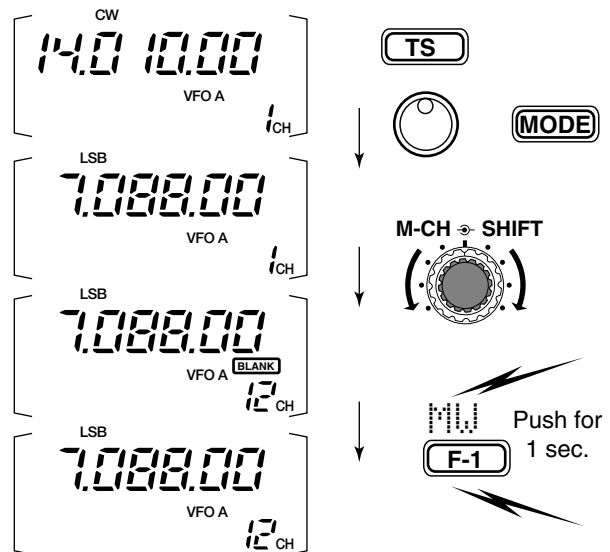

• Programming in memory mode

- ① Select M2 functions.
 - Push [DISPLAY] once or twice to select M.
 - Push [MENU] one or more times to select M2.
- ② Set the desired frequency and operating mode.
- ③ Push [(F-3)M] to select memory mode, then select the desired memory channel with [M-CH].
 - Push [▲]/[▼] when you want to program blank channels.
- ④ Push [(F-1)M] for 1 sec. to program the displayed frequency and operating mode into the memory channel.

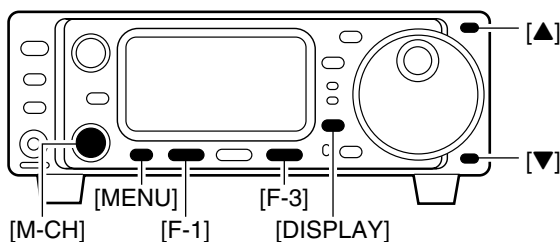

[EXAMPLE]: Programming 21.280 MHz/USB into ch 18.

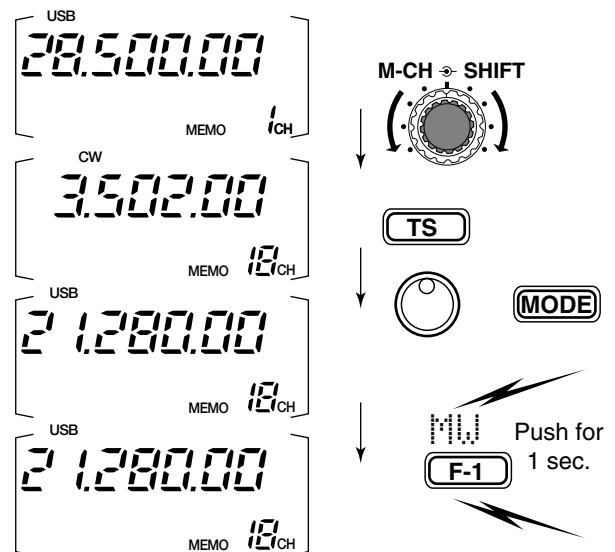

Memory clearing

Any unnecessary memory channels can be cleared. The cleared memory channels become blank channels.

- ① Select M2 functions.
 - Push [DISPLAY] once or twice to select M.
 - Push [MENU] one or more times to select M2.
- ② Push [(F-3)M] to select memory mode.
- ③ Rotate [M-CH] to select a memory channel to be cleared.
- ④ Push [(F-2)MCL] for 1 sec. to clear the contents.
 - The programmed frequency and operating mode disappear and "BLANK" appears.
- ⑤ To return to VFO mode, push [(F-3)M] again.

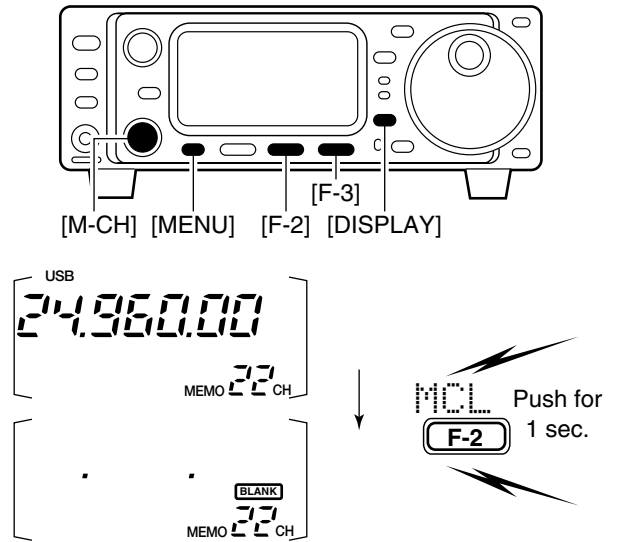

Frequency transferring

The frequency and operating mode can be transferred from memory mode to VFO mode.

- ① Select M2 functions.
 - Push [DISPLAY] once or twice to select M.
 - Push [MENU] one or more times to select M2.
- ② Select VFO mode with [(F-3)M].
- ③ Select a memory channel with [M-CH].
 - Select memory mode to confirm the memory channel's contents, if desired; then return to VFO mode.
 - "BLANK" appears if the selected memory channel is a blank channel (and does not have contents). In this case transferring is not possible.
- ④ Push [(F-3)M] for 1 sec. to transfer the frequency and operating mode.
 - Transferred frequency and operating mode appear in the display.

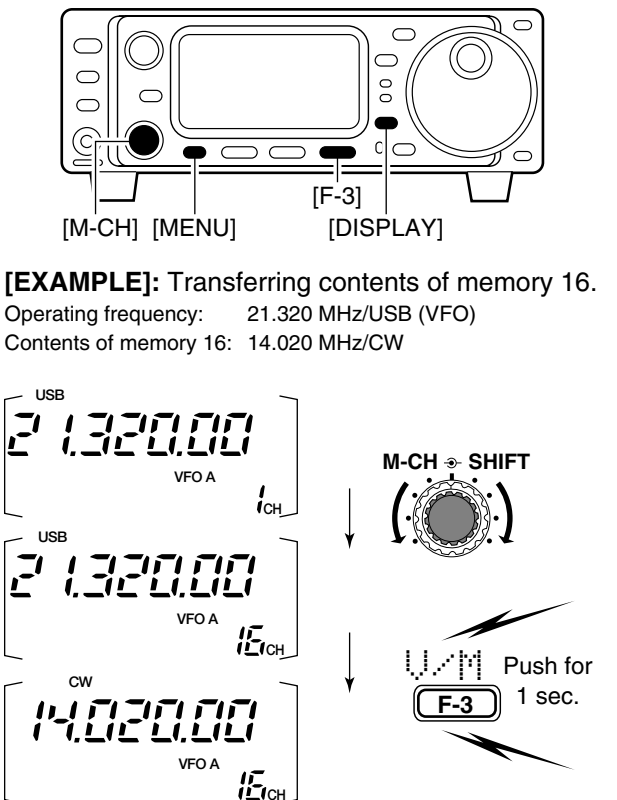

[EXAMPLE]: Transferring contents of memory 16.
 Operating frequency: 21.320 MHz/USB (VFO)
 Contents of memory 16: 14.020 MHz/CW

Memory names

All memory channels (including scan edges) can be tagged with alphanumeric names of up to 9 characters each.

All common keyboard characters (ASCII characters 33 to 126) can be used, including numerals and punctuation marks.

Calling up memory names

- ① Select the G4 display.
 - Push [DISPLAY] once or twice to select G.
 - Push [MENU] one or more times to select G4.
- ② Select a memory channel with [M-CH].

Editing (programming) memory names

- ① Call up the desired memory (channel) name as above.
- ② Push [(F-3)] to enter memory name edit mode.
 - “[DEL]” appears briefly, then a cursor blinking under the first character position.
- ③ Rotate the main dial to select the desired character, then advance the cursor position.
 - Pushing [(F-3)] moves the cursor to the right; [(F-1)] moves the cursor to the left.
 - Pushing [(F-2)] deletes the character.
- ④ Repeat this procedure until all desired characters have been selected.
- ⑤ Push [(MENU)] to exit memory name edit mode.
 - The G4 display re-appears and the programmed memory name is displayed.

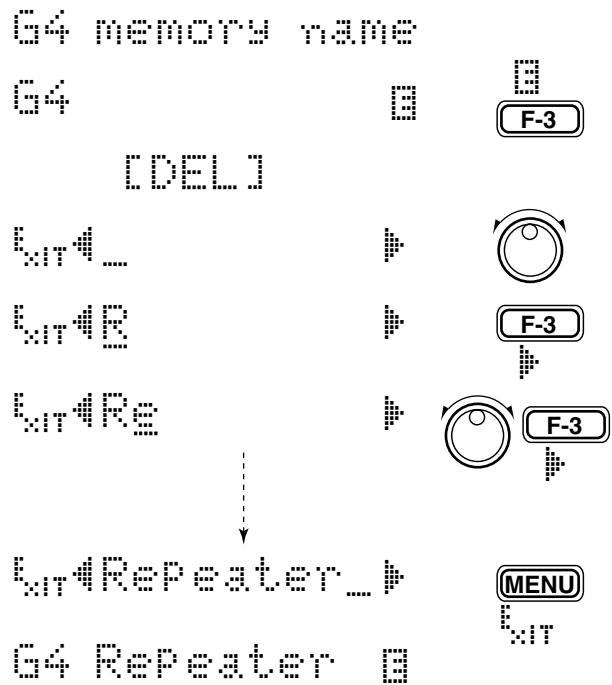
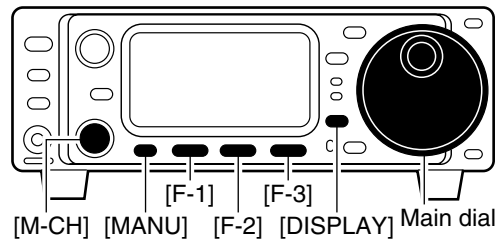

■ Memo pads

The transceiver has a memo pad function to store frequency and operating mode for easy write and recall. The memo pads are separate from memory channels.

The default number of memo pads is 5, however, this can be increased to 10 in initial set mode if desired (p. 80).

Memo pads are convenient when you want to memorize a frequency and operating mode temporarily, such as when you find a DX station in a pile-up or when a station is busy for a long time and you want to temporarily search for other stations.

Use the transceiver's memo pads instead of relying on hastily scribbled notes that are easily misplaced.

• Writing frequencies and operating modes into memo pads

- ① Select the S1 display.
 - Push [DISPLAY] once or twice to select S.
 - Push [MENU] one or more times to select S1.
- ② Push [(F-2)MPW] to program the frequency into a memo pad.

When you write a 6th frequency and operating mode, the oldest written frequency and operating mode are automatically erased to make room for the new settings.

NOTE: Each memo pad must have its own unique combination of frequency and operating mode; memo pads having identical settings cannot be written.

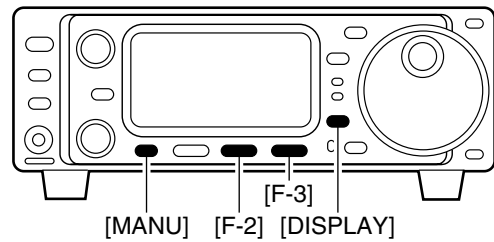

Displayed frequency and mode

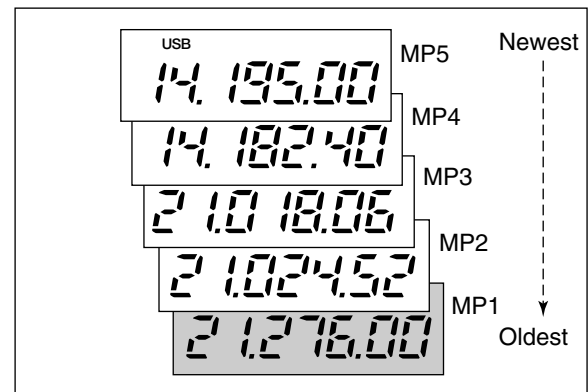
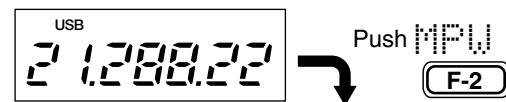

The oldest written frequency and mode are erased.

• Calling up a frequency from a memo pad

You can simply call up the desired frequency and operating mode of a memo pad by pushing [(F-3)MPR] in the S1 display.

- Make sure S1 is selected in advance.
- Both VFO and memory modes can be use.
- The frequency and operating mode are called up, starting from the most recently written.

When you call up a frequency and an operating mode from memo pads with [(F-3)MPR], the previously displayed frequency and operating mode are automatically stored in a temporary pad. The frequency and operating mode in the temporary pad can be recalled by pushing [(F-3)MPR] one or more times.

NOTE: If you change the frequency or operating mode called up from a memo pad, the frequency and operating mode in the temporary pad are erased.

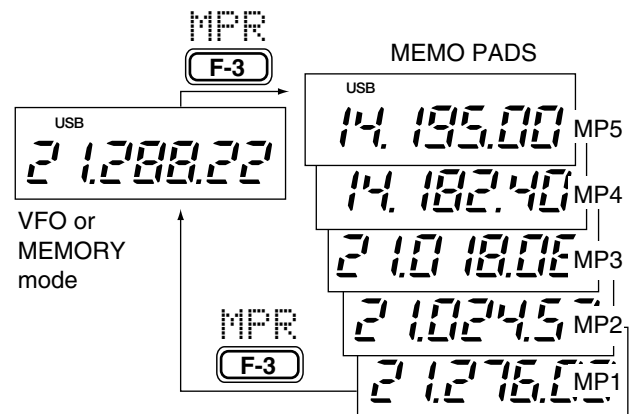

Scan types

PROGRAMMED SCAN

Repeatedly scans between two scan edge frequencies (scan edge memory channels 1A and 1B).

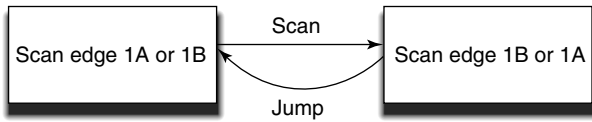

This scan operates in VFO mode.

PRIORITY WATCH

Checks for signals on a memory while operating on a VFO frequency.

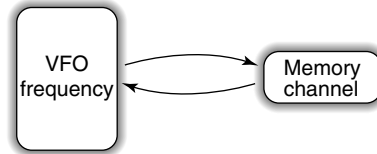

This scan operates in VFO mode.

MEMORY SCAN

Repeatedly scans all programmed memory channels.

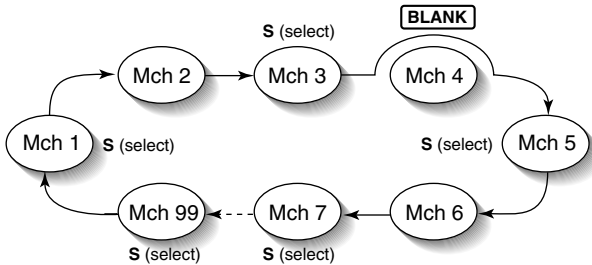

This scan operates in memory mode.

SELECTED MEMORY SCAN

Repeatedly scans all selected memory channels.

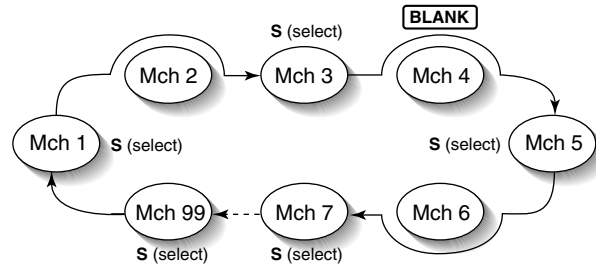

This scan operates in memory mode.

Preparation

Channels

For programmed scan: Program scan edge frequencies into scan edge memory channels 1A and 1B. (p. 57)

For memory scan: Program 2 or more memory channels except scan edge memory channels.

For memory select scan: Designate 2 or more memory channels as select memory channels—select a memory channel, then push [(F-2)SEL] in the S2 display (memory mode) to designate the channel as a select memory channel.

For priority watch: Program 1 memory channel to be watched.

Scan resume ON/OFF

You can select the scan to resume or cancel when detecting a signal, in initial set mode, item “27 SCAN RESUME”. Scan resume ON/OFF must be set before operating a scan. See p. 80 for ON/OFF setting and scan resume condition details.

Scan speed

Scan speed can be selected from 2 levels, high or low, in initial set mode. See p. 80 for details.

Squelch condition

SCAN STARTS WITH	PROGRAMMED SCAN	MEMORY SCANS PRIORITY WATCH
SQUELCH OPEN	The scan continues until it is stopped manually, and does not pause even if it detects signals.	Scan pauses on each channel when the scan resume is ON; not applicable when OFF.
	This is not applicable when the scan resume is OFF and a programmable step (more than 1 kHz) is selected.	
SQUELCH CLOSED	Scan stops when detecting a signal. If you set scan resume ON in initial set mode, the scan pauses for 10 sec. when detecting a signal, then resumes. When a signal disappears while scan is paused, scan resumes 2 sec. later.	

■ Programmed scan operation

- ① Select VFO mode.
- ② Select the desired operating mode.
 - The operating mode can also be changed while scanning.
- ③ Set [SQL] open or closed.
 - See page a left for squelch condition.
- ④ Select S2.
 - Push [DISPLAY] once or twice to select S.
 - Push [MENU] one or more times to select S2.
- ⑤ Push [(F-1)SON] to start the scan.
 - Decimal point blinks while scanning.
- ⑥ When the scan detects a signal, the scan turns OFF, pauses or ignores it depending on the resume setting and the squelch condition.
 - During scan [TS] can be used only when resume is ON.
- ⑦ To cancel the scan push [(F-1)SON].

/// **NOTE:** If the same frequencies are programmed into the scan edge memory channels 1A and 1B, programmed scan does not start.

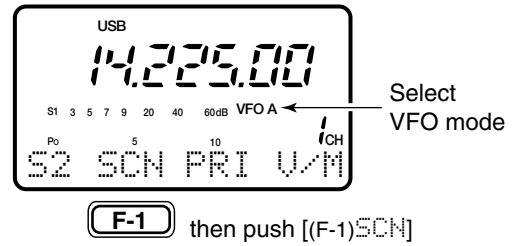
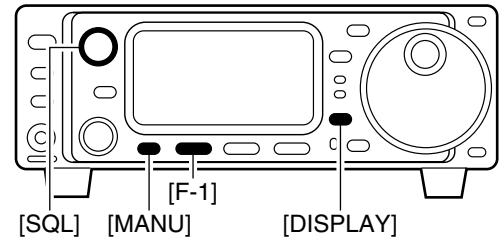

■ Memory scan operation

- ① Select memory mode.
- ② Close the squelch with [SQL].
- ③ Select S2.
 - Push [DISPLAY] once or twice to select S.
 - Push [MENU] one or more times to select S2.
- ④ Push [(F-1)SON] to start the scan.
 - Decimal point blinks while scanning.
- ⑤ When the scan detects a signal, the scan stops or pauses depending on the resume setting.
- ⑥ To cancel the scan push [(F-1)SON].

/// **NOTE:** Two or more memory channels must be programmed for memory scan to start.

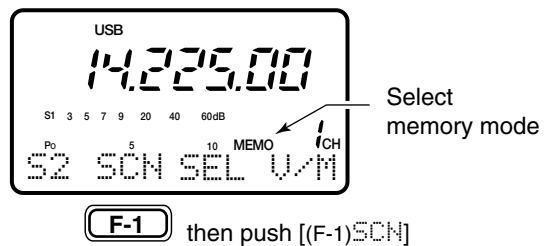
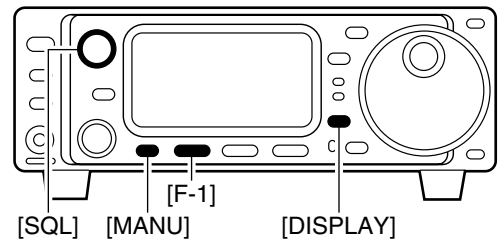

■ Select memory scan operation

- ① Select memory mode.
- ② Close the squelch with [SQL].
- ③ Select S2.
 - Push [DISPLAY] once or twice to select S.
 - Push [MENU] one or more times to select S2.
- ④ Push [(F-1)SON] to start the memory scan.
 - Decimal point blinks while scanning.
- ⑤ Push [(F-2)SEL] to change the memory scan to select memory scan.
 - Push [(F-2)SEL] for 2 sec. to clear all select memory channels.
- ⑥ When the scan detects a signal, the scan stops or pauses depending on the resume setting.
- ⑦ To cancel the scan push [(F-1)SON].

NOTE: Two or more memory channels must be designated as select memory channels for select memory scan to start (see p. 61).

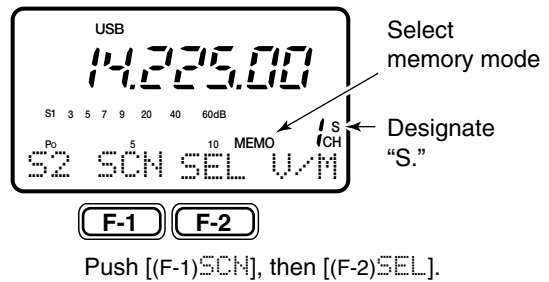
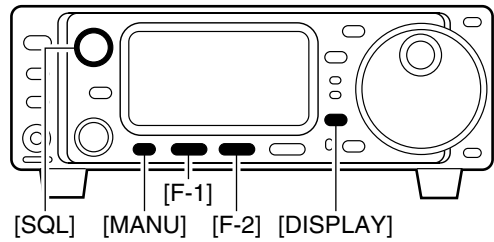

■ Priority watch

- ① Select VFO mode, then set a frequency.
- ② Close the squelch with [SQL].
- ③ Set the desired memory channel as the watching channel.
- ④ Select S2.
 - Push [DISPLAY] once or twice to select S.
 - Push [MENU] one or more times to select S2.
- ⑤ Push [(F-2)PRI] to start the priority watch.
 - Decimal point blinks while scanning.
- ⑥ When the scan detects a signal, the scan pauses for 10 sec. or until the signal disappears, depending on the resume setting.
- ⑦ To cancel the scan push [(F-2)PRI].

NOTE: The paused condition when detecting a signal differs depending on the scan resume condition. (p 80)

- resume on: pauses for 10 sec.
- resume off: pauses until the signal disappears.

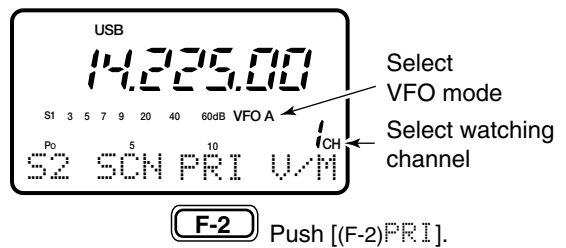
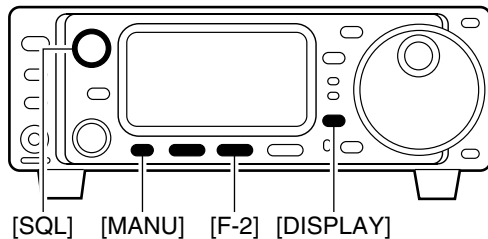

■ Antenna tuner operation

◇ Internal antenna tuner

The internal automatic antenna tuner matches the transceiver to the connected antenna automatically. Once the tuner matches an antenna, the latching relays combination are memorized as a preset point for each frequency range (100 kHz steps). Therefore, when you change the frequency range, the latching relays are automatically preset to the memorized combination.

CAUTION: NEVER transmit with the tuner ON when no antenna is connected. This will damage the transceiver. Be careful of the antenna selection.

◇ Tuner operation

Push [TUNER] to turn the internal antenna tuner ON. The antenna is tuned automatically when the antenna SWR is higher than 1.5:1.

- When the tuner is ON, the 'TUNER' indicator lights red.

• MANUAL TUNING

Push [TUNER] for 1 sec., to start manual tuning.

- A side tone is emitted and 'TUNER' indicator blinks while tuning.
- If the tuner cannot reduce the SWR to less than 1.5:1 after 20 sec. of tuning, the 'TUNER' indicator goes out.

• PTT TUNER START

The tuner is always tuned when the PTT is pushed after the frequency is changed (more than 1% from last-tuned frequency). This function removes the "push and hold [TUNER]" operation and activates for the first transmission on a new frequency.

This function can be turned ON in initial set mode (p. 81).

• TUNER RESET

[POWER]

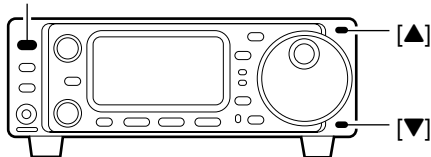

- ① Make sure the transceiver power is OFF.
- ② While pushing [▲] and [▼], push [POWER] to turn power ON.
 - "CLEAR ? OK" appears as shown below.
- ③ Rotate main dial to select tuner reset.

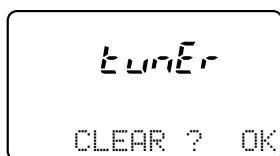

[F-3]

- ④ Then Push [F-3] for 1 sec to start tuner resetting.
 - The memorized tuner settings are reset.

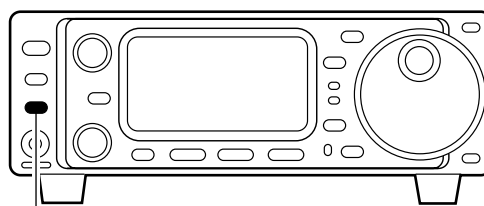

[TUNER]



Lights to indicate internal tuner is activated.

NOTES:

- The internal antenna tuner can tune the HF to 50 MHz bands.
- **NEVER** transmit without an antenna properly connected to antenna port in use.
- If the SWR is higher than about 1.5:1 when tuning above 100 kHz on an antenna's preset point, push [TUNER] for 1 sec. to start manual tuning.
- When strong impact is applied, the internal tuner may not work properly caused by the latching relay is off position. In this case, push [POWER] momentarily to reset the all latching relays while transceiver power is ON.

◇ If the tuner cannot tune the antenna

Check the following and try again:

- the antenna connection and feedline.
- the unaltered antenna SWR. (Less than 3:1 for HF bands; Less than 2.5:1 for 50 MHz band)
- the power source voltage/capacity.

If the tuner cannot reduce the SWR to less than 1.5:1 after checking the above, perform the following:

- repeat manual tuning several times.
- tune with a 50 Ω dummy load and re-tune the antenna.
- turn power OFF and ON.
- adjust the antenna cable length.

(This is effective for higher frequencies in some cases.)

- Some antennas, especially for low bands, have a narrow bandwidth. These antennas may not be tuned at the edge of their bandwidth, therefore, tune such an antenna as follows:

◇ **Optional external tuner operation**

The IC-703 automatically detects and selects an optional external tuner (AT-180/AH-4) when connected. In this case, the internal tuner switches to the through function.

▨ **NOTE:** When the connected power supply voltage is lower than 11.0 V, the transceiver automatically switches to the battery operating mode (power saving mode). In this case, the transceiver can not drive an external antenna tuner.

▨ **NOTE:** When connecting the optional antenna tuner AT-180, the IC-703's output power must be set maximum (10 W) both in quick set mode and initial set mode. Otherwise, the AT-180 may not be tuned correctly. (AT-180's minimum operating input power is 8 W.)

◇ **Optional AT-180 AUTOMATIC ANTENNA TUNER operation**

The AT-180 automatic antenna tuner matches the IC-703 to the connected antenna automatically. Once the tuner matches an antenna, the variable capacitor angles are memorized as a preset point for each frequency range (100 kHz steps). Therefore, when you change the frequency range, the variable capacitors are automatically preset to the memorized point.

▨ **CAUTION: NEVER** transmit with the tuner ON when no antenna is connected. This will damage the transceiver. Be careful of the antenna selection.

- The AT-180 can match both HF and 50 MHz bands. However, operation is different for the HF and 50 MHz bands.

TUNER OPERATION

• **For the HF band:**

Push [TUNER] to turn the tuner ON. The antenna is tuned automatically during transmission when the antenna SWR is higher than 1.5:1.

- When the tuner is OFF, the [TUNER] light goes out.

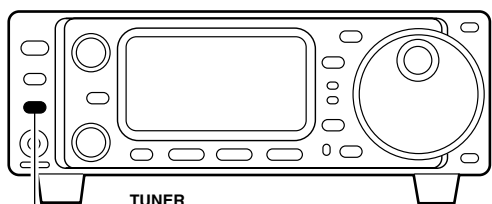

[TUNER]  Lights to indicate AT-180 is turned ON.

• **For the 50 MHz band:**

Push [TUNER] for 1 sec. to tune the antenna. If the [TUNER] light flashes slowly while transmitting, push and hold [TUNER] for 1 sec. again to re-tune the antenna.

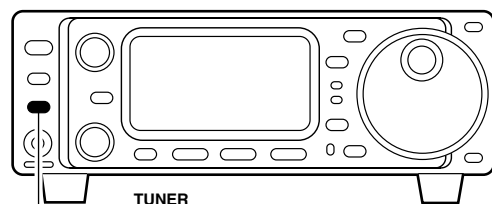

[TUNER]  Flashes to indicate re-tuning is necessary.

MANUAL TUNING

During SSB operation on HF bands at low voice levels, the AT-180 may not be tuned correctly. In such cases, manual tuning is helpful.

Push [TUNER] for 1 sec. to start manual tuning.

- CW mode is selected, a side tone is emitted, and the [TUNER] light flashes; then, the previous mode is selected.

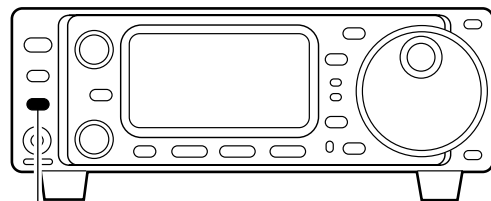

[TUNER]

Push and hold for 1 sec. to start manual tuning.

If the tuner cannot reduce the SWR to less than 1.5:1 after 20 sec. of tuning, the [TUNER] light goes out. In this case, check the following:

- the antenna connection and feedline
- the antenna SWR (p. 55; meter function)

Through inhibit (HF bands only)

The AT-180 has a through inhibit condition. When selecting this condition, the tuner can be used at poor SWR's. In this case, automatic tuning in the HF bands activates only when exceeding SWR 3:1. Therefore, manual tuning is necessary each time you change the frequency. Although termed "through inhibit," the tuner will be "through" if the SWR is higher than 3:1 after tuning.

CONVENIENT

• **Tuner sensitive condition (HF bands only)**

If you require critical tuning at any time during transmission, select the tuner sensitive condition. See p. 81 for selection.

• **Automatic tuner start (HF bands only)**

If you want to turn OFF the tuner under conditions of VSWR 1.5:1 or less, use "automatic tuner on" and turn the tuner OFF. See p. 81 for turning the function ON and OFF.

◇ **Optional AH-4 AUTOMATIC ANTENNA TUNER operation**

The AH-4 matches the IC-703 to a long wire antenna more than 7 m/23 ft long (3.5 MHz and above).

- See p. 16 for connection.
- See the AH-4 instruction manual for AH-4 installation and antenna connection details.

AH-4 setting example:

For mobile operation

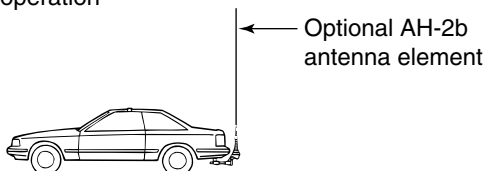

For outdoor operation

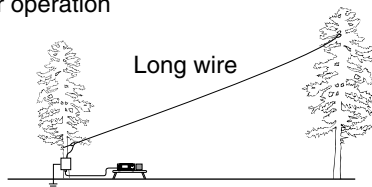

⚠ DANGER!: HIGH VOLTAGE!
NEVER touch the antenna element while tuning or transmitting.

NEVER operate the AH-4 without an antenna wire. The tuner and transceiver will be damaged.

NEVER operate the AH-4 when it is ungrounded.

Transmitting before tuning may damage the transceiver. Note that the AH-4 cannot tune when using a $\frac{1}{2} \lambda$ long wire or multiple of the operating frequency.

AH-4 operation

Tuning is required for each frequency. **Be sure** to re-tune the antenna before transmitting when you change the frequency—even slightly.

- ① Set the desired frequency in an HF band.
 - The AH-4 will not operate on frequencies outside of ham bands.

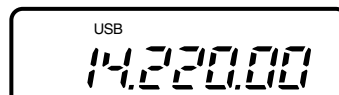

- ② Push [TUNER] for 1 sec.
 - The [TUNER] light flashes and "CW" appears while tuning.

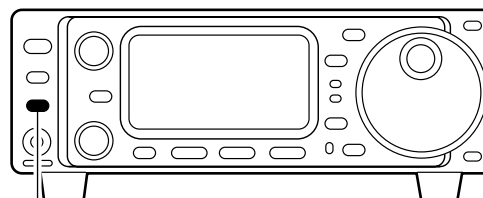

[TUNER]
 Push [TUNER] for 1 sec.

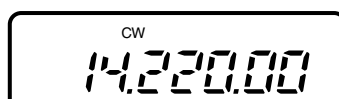

- ③ The [TUNER] light lights constantly when tuning is complete.
 - When the connected wire cannot be tuned, the [TUNER] light goes out, the AH-4 is bypassed and the antenna wire is connected to the antenna connector on the transceiver directly.

CONVENIENT

- ④ To bypass the AH-4 manually, push [TUNER].

•PTT tune function

The AH-4 is always tuned when the PTT is pushed after the frequency is changed (more than 1%). This function removes the "push and hold [TUNER]" operation and activates first transmission on the new frequency. This function is turned ON in initial set mode, item 34 (p. 81).

10 DATA COMMUNICATION

■ Connections for packet

◇ When connecting to [DATA] socket

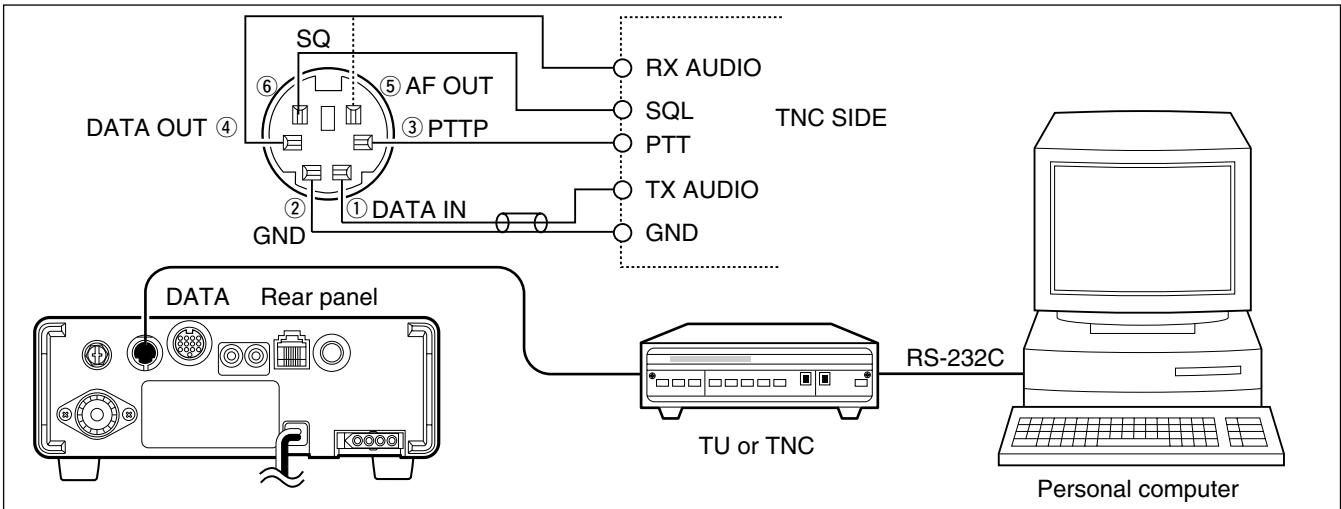

◇ When connecting to [ACC] socket

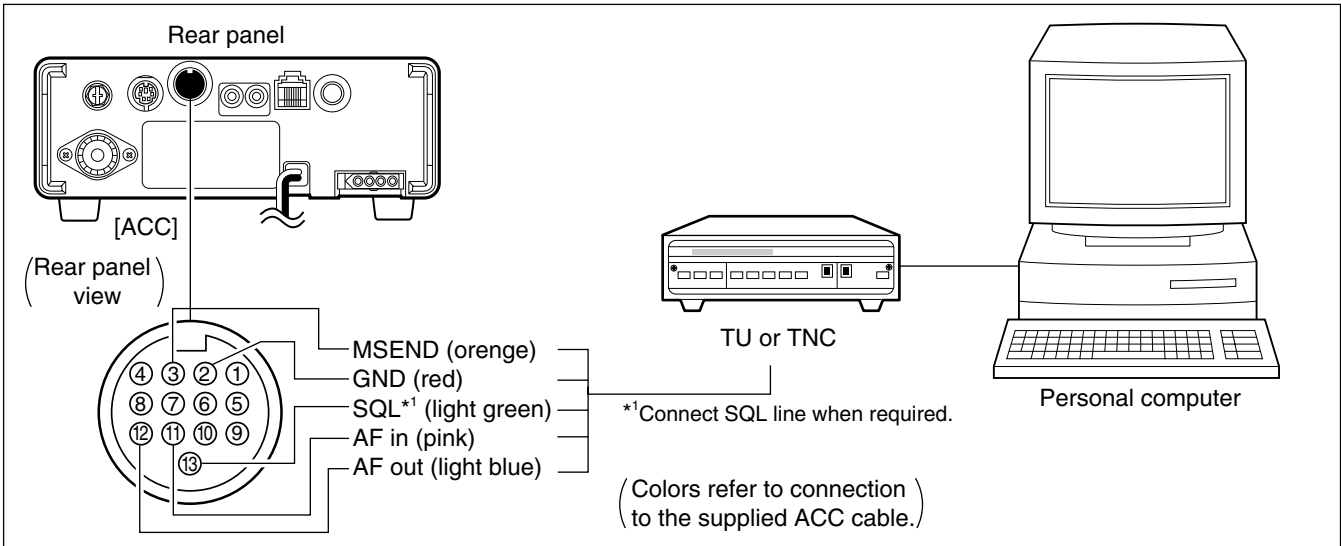

◇ When connecting to [MIC] connector

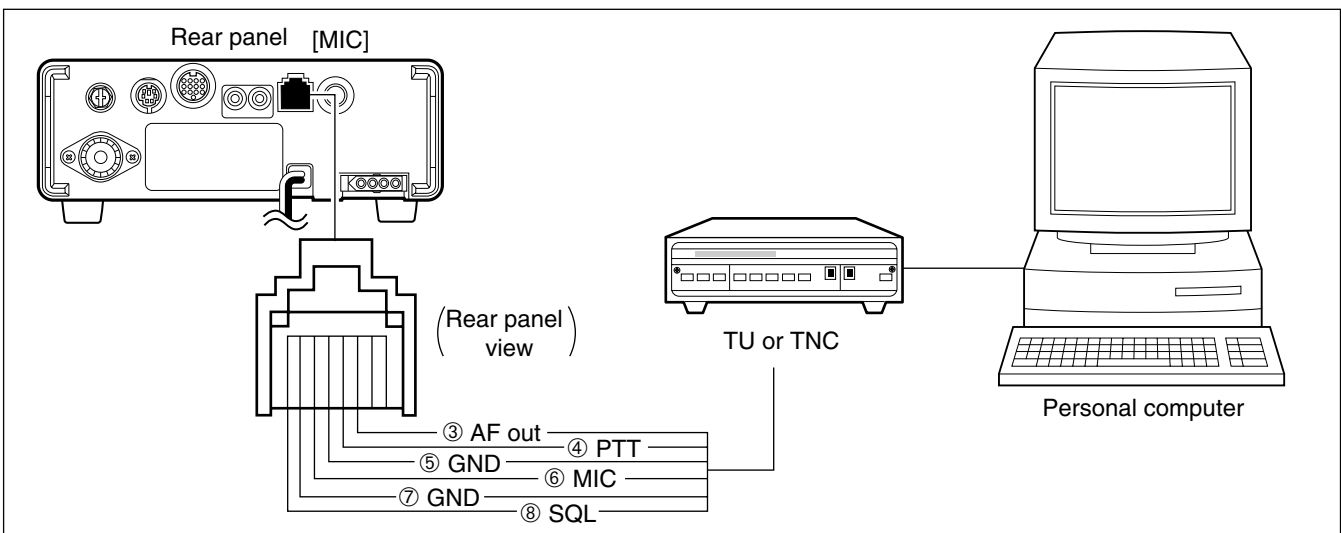

■ Packet (AFSK) operation

Before operating packet (AFSK) be sure to consult the operating manual that came with your TNC.

- ① Connect a TNC and PC as left page.
- ② Push [(▲)BAND]/[(▼)BAND] to select the desired band.
- ③ Push [MODE] momentarily to select SSB (LSB) mode (or select SSB-D mode).
 - After USB mode is selected, push [MODE] for 1 sec. to toggle between USB and LSB modes.
 - After RTTY mode is selected, push [MODE] for 1 sec. to toggle between RTTY and SSB-D modes.
 - Generally, LSB is used on the HF bands and FM is used for the 50 MHz band.
- ④ Rotate [AF] to set audio to a comfortable listening level.
- ⑤ Rotate the main dial to tune a desired signal.
 - S-meter indicates received signal strength.
- ⑥ Transmit your AFSK signals using your computer's keyboard.
 - The TX indicator lights red.

NOTE: When connecting a TNC to the ACC socket on the rear panel, select SSB-D mode or disconnect the microphone and adjust 'MIC GAIN' to 0 in quick set mode.

When SSB-D mode is selected, the audio input from the [MIC] connector is automatically cut, and the audio input from the [ACC] is used.

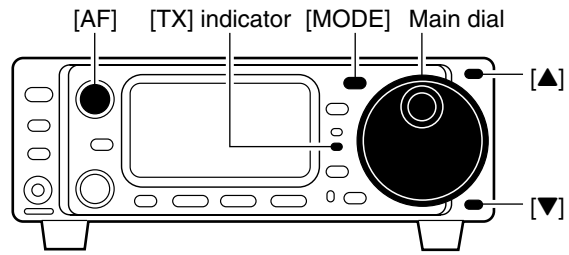

"USB" or "LSB" blinks when SSB-D mode is selected.

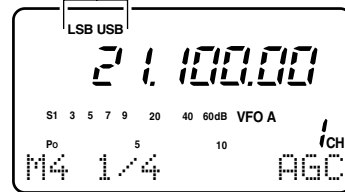

◇ Frequency indication during AFSK operation

When operating AFSK in SSB mode, the indicated frequency is the signals carrier point.

- **Example**— SSB-D mode
 Mark freq.: 2125 Hz
 Shift freq.: 200 Hz

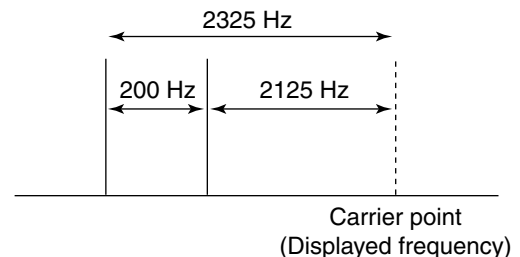

◇ **SSB-D mode selection**

- ① Push [MODE] one or more times to select RTTY mode.
- ② Push [MODE] for 1 sec. to SSB-D mode.
 - After RTTY mode is selected, push [MODE] for 1 sec. to toggle between RTTY and SSB-D modes.

NOTE: When SSB-D mode is selected, the audio input from the [MIC] connector is automatically cut, and the audio input from the [ACC] is used.

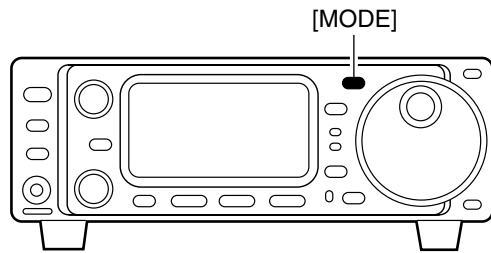

OPERATING MODE SELECTION

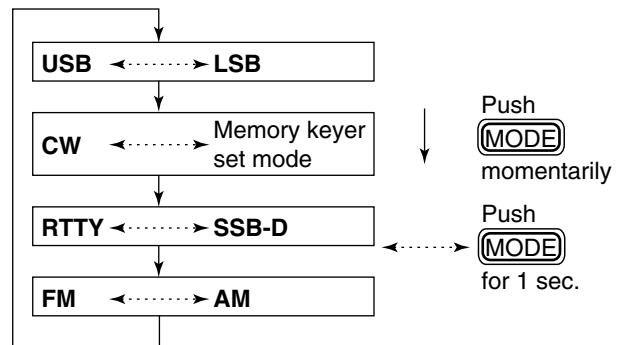

◇ **Carrier point setting**

QUICK SET MODE

- ① Select SSB-D mode with [MODE].
- ② Push [DISPLAY] for 1 sec. to enter quick set mode.
- ③ Push [MENU] one or more times to select "02 CAR SIDE," then rotate the main dial to select "U" (USB mode) or "L" (LSB mode).

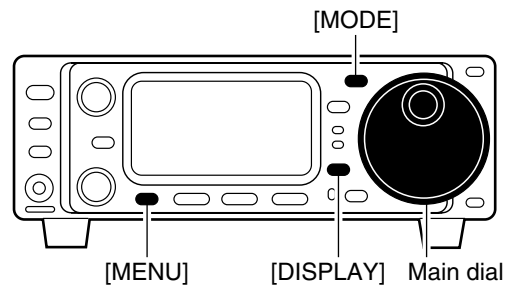

◇ Adjusting the transmit signal from the TNC

NOTE: For packet operation the transceiver can be set to one of two data speeds: 1200 bps or 9600 bps. Data speed is set in initial set mode (item "36 9600 MODE"; see p.81).

- ① Push [POWER] for 1 sec. to turn power OFF.
- ② While pushing [LOCK], push [POWER] to turn power ON.
 - Initial set mode is selected and one of its items appears.
- ③ Push [MENU] one or more times to select the item "36 9600 MODE."
 - [M-CH] or [▲]/[▼] can also be used.
- ④ Rotate the main dial to select the data speeds: 1200 bps or 9600 bps.
- ⑤ To exit initial set mode, push [POWER] for 1 sec. to turn power OFF.
- ⑥ Push [POWER] to turn power ON again.
 - The conditions selected in initial set mode are now effective.

When setting data transmission speed to 9600 bps, the DATA signal coming from the TNC is applied exclusively to the internal limiter circuitry to automatically maintain bandwidth.

NEVER apply data levels from the TNC of over 0.6 Vp-p, otherwise the transceiver will not be able to maintain the band width and may possibly interfere with other stations.

NOTE: Read the instructions supplied with your TNC carefully before attempting packet operation with the IC-703.

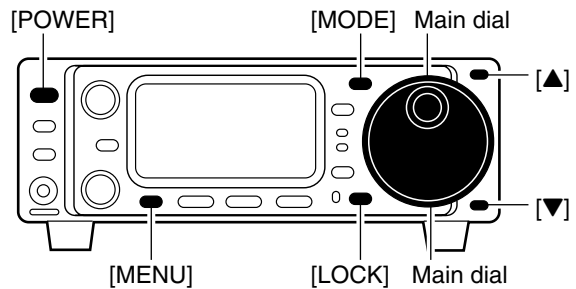

1. When using a level meter or synchroscope, adjust the TX audio level (DATA IN level) from the TNC as follows.

0.4 Vp-p (0.2 Vrms): recommended level
 0.2 Vp-p–0.5 Vp-p (0.1 Vrms–0.25 Vrms): acceptable level

2. When not using a measuring device.

- ① Connect the IC-703 to a TNC.
- ② Enter a test mode ("CAL", etc.) on the TNC, then transmit some test data.
- ③ *When the transceiver fails to transmit test data or transmits sporadically (TX indicator doesn't appear or flashes):*
 Decrease the TNC output level until the transmit indicator lights continuously.
When transmission is not successful even though the TX indicator lights continuously:
 Increase the TNC output level.

Remote jack (CI-V) information

CI-V connection example

The transceiver can be connected through an optional CT-17 CI-V LEVEL CONVERTER to a personal computer equipped with an RS-232C port. The Icom Communication interface-V (CI-V) controls the following functions of the transceiver.

Up to four Icom CI-V transceivers or receivers can be connected to a personal computer equipped with an RS-232C port. See p. 82 for setting the CI-V condition using initial set mode.

Data format

The CI-V system can be operated using the following data formats. Data formats differ according to command numbers. A data area is added for some commands.

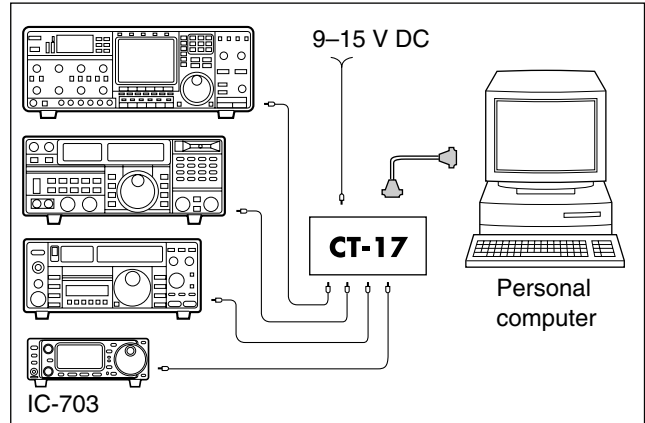

CONTROLLER TO IC-703

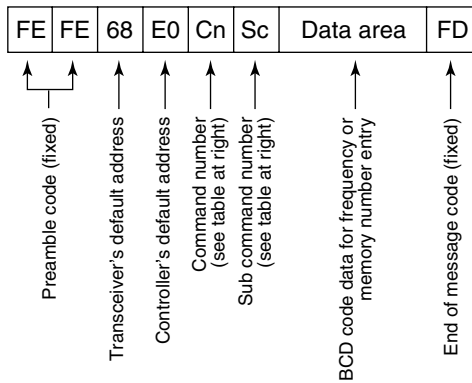

OK MESSAGE TO CONTROLLER

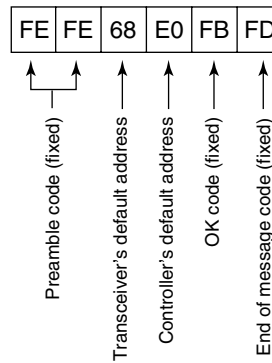

IC-703 TO CONTROLLER

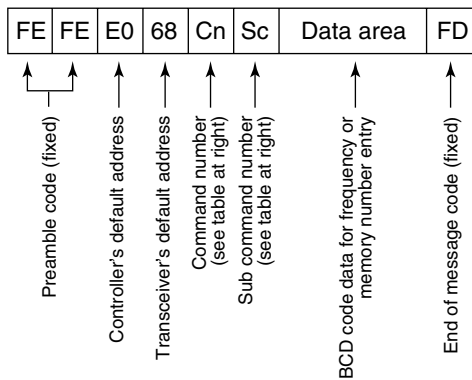

NG MESSAGE TO CONTROLLER

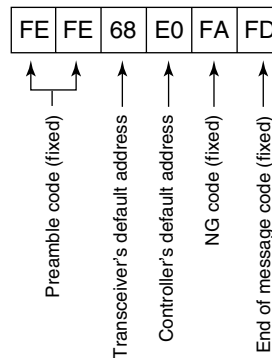

◇ Command table

Command	Sub command	Description
00	—	Send frequency data
01	Same as command 06	Send mode data
02	—	Read band edge frequencies
03	—	Read operating frequency
04	—	Read operating mode
05	—	Set operating frequency
06	00	Select LSB
	01	Select USB
	02	Select AM
	03	Select CW
	04	Select RTTY
	05	Select FM
	07	Select CW-R
	08	Select RTTY-R
07	—	Select VFO mode
	00	Select VFO A
	01	Select VFO B
	A0	Equalize VFO A and VFO B
	B0	Exchange VFO A and VFO B
08	—	Select memory mode
	0001–0105*	Select memory channel *1A=0100, 3b=0105
09	—	Memory write
0A	—	Memory to VFO
0B	—	Memory clear
0E	00	Scan stop
	01	Programmed/memory scan start
0F	00	Turn the split function OFF
	01	Turn the split function ON
10	00	Select 10 Hz (1 Hz) tuning step
	01	Select 100 Hz tuning step
	02	Select 1 kHz tuning step
	03	Select 5 kHz tuning step
	04	Select 9 kHz tuning step
	05	Select 10 kHz tuning step
	06	Select 12.5 kHz tuning step
	07	Select 20 kHz tuning step
	08	Select 25 kHz tuning step
	09	Select 100 kHz tuning step
11	—	Select/read attenuator (00=OFF, 20=ON (20 dB))
13	00	Announce with voice synthesizer
	01	(00=all data; 01=frequency and S-meter level; 02=operating mode)
	02	
14	01 + Level data	[AF] level setting (0=max. CCW to 255=max. CW)
	02 + Level data	[RF] level setting (0=max. CCW to 255=11 o'clock)
	03 + Level data	[SQL] level setting (0=11 o'clock to 255=max. CW)
	04 + Level data	[IF SHIFT] position setting (0=max. CCW; 128=center; 255=max. CW)
	06 + Level data	Noise reduction level setting (0=min. to 255=max.)
	07 + Level data	Twin PBT (inside) setting (0=max. CCW, 128=center, 255=max. CW)
	08 + Level data	Twin PBT (outside) setting (0=max. CCW, 128=center, 255=max. CW)
09 + Level data	CW pitch setting (0=300 Hz, 128=600 Hz, 255=900 Hz)	

Command	Sub command	Description	
14	0A + Level data	RF power setting (0=mini. to 255=max.)	
	0B + Level data	Microphone gain setting (0=mini. to 255=max.)	
	0C + Level data	Key speed setting (0=slow to 255=fast)	
	0E + Level data	COMP Level setting (0=0 to 10=10)	
	0F + Level data	Break-IN DELAY setting (20=2.0d to 130=13.0d)	
15	01	Read squelch condition	
	02	Read S-meter level	
	11	Read RF power meter	
	12	Read SWR meter	
	13	Read ALC meter	
16	02	Preamp (0=OFF; 1=preamp 1; 2=preamp 2)	
	12	AGC selection (1=Fast; 2=Slow)	
	22	Noise blanker (0=OFF; 1=ON)	
	40	Noise reduction (0=OFF; 1=ON)	
	41	Auto notch (0=OFF; 1=ON)	
	42	Subaudible tone (0=OFF; 1=ON)	
	43	Tone squelch (0=OFF; 1=ON)	
	44	Speech compressor (0=OFF; 1=ON)	
	45	Monitor (0=OFF; 1=ON)	
	46	VOX function (0=OFF; 1=ON)	
	47	Break-in (0=OFF; 1=semi break-in; 2=full break-in)	
	19	00	Read the transceiver ID
	1A	00	Send/read memory contents
01		Send/read band stacking register contents (see p. 73 for details)	
02		Send/read memory keyer contents (see p. 73 for details)	
0301		Send/read beep emission set (0=OFF, 1=ON)	
0302		Send/read band edge beep set (0=OFF, 1=ON)	
0303		Send/read beep output level set (0=min. to 255=max.)	
0304		Send/read beep limit set (0=OFF, 1=ON)	
0305		Send/read CW carrier point set (0=LSB, 1=USB)	
0306		Send/read CW side tone level set (0=min. to 255=max.)	
0307		Send/read CW side tone limit set (0=OFF, 1=ON)	
0308		Send/read 9600 bps mode set (0=OFF, 1=ON)	
0309		Send/read VOX gain set (0=min. to 255=max.)	
0310		Send/read anti VOX gain set (0=min. to 255=max.)	
0311	Send/read VOX delay time set (0=0 sec. to 20=2.0 sec.)		
0312	Send/read meter selection (0=Power, 1=SWR, 3=ALC)		
0313	Send/read SSB carrier frequency (00=-200 Hz to 40=200 Hz; 10 Hz steps)		

CW: Clockwise, CCW: Counter Clockwise

Command table (continued)

Command	Sub command	Description
1A	0314	Send/read RTTY marker frequency (0=1275 Hz, 1=1615 Hz, 2=2125 Hz)
	0315	Send/read RTTY shift width (0=170 Hz, 1=200 Hz, 2=425 Hz)
	0316	Send/read RTTY keying polarity (0=Normal, 1=Reverse)
	0317	Send/read noise blanker level (0=min. to 255=max.)
	0318	Send/read key type (0=Normal, 1=Reverse, 2=Bug, 3=OFF, 4=Mic. [UP]/[DN])
	0319	Send/read CW keyer dot/dash ratio (28=1:1:2.8 to 45=1:1:4.5)
	0320	Send/read CW keyer repeat time (01=1 sec. to 60=60 sec.)
	0321	Send/read CW keyer transmission indication (0=Normal, 1=First 3-character, 2= First 3-character+ contact number)
	0322	Send/read contact number style (0=Normal, 1=190→ANO, 2=190→ANT, 3=90→NO, 4=90→NT)
	0323	Send/read count up trigger channel (1=MK1, 2=MK2, 3=MK3)
	0324	Send/read present number (1-999)
	04	Send/read DATA mode (0=OFF, 1=ON)
1B	00	Set/read repeater tone frequency
	01	Set/read TSQL tone frequency
1C	00	Set/read the transceiver's condition (0=Rx; 1=Tx)
	01	Set/read antenna tuner condition (0=OFF, 1=ON, 2=Start tuning or while tuning)

◇ Band stacking register

To send or read the desired band stacking register's contents, combined code of the frequency band and register codes as follows are used.

For example, when sending/reading the contents in the 21 MHz band, the code "0701" is used.

• Frequency band code

Code	Freq. band	Frequency range (unit: MHz)
01	1.8	1.800000-1.999999
02	3.5	3.400000-4.099999
03	7	6.900000-7.499999
04	10	9.900000-10.499999
05	14	13.900000-14.499999
06	18	17.900000-18.499999
07	21	20.900000-21.499999
08	24	24.400000-25.099999
09	28	28.000000-29.999999
10	50	50.000000-54.000000
11	GENE	Other than above

• Register code

Code	Registered number
01	1

◇ Codes for memory keyer contents

To send or read the desired memory keyer contents, the channel and character codes as follows are used.

• Channel code

Code	Channel number
01	MK1
02	MK2
03	MK3

• Character's code

Character	ASCII code	Description
0-9	30-39	Numerals
A-Z	41-5A	Alphabetical characters
space	20	Word space
/	2F	Symbol
?	3F	Symbol
,	2C	Symbol
.	2E	Symbol
^	5E	e.g., to send \overline{BT} , enter ^4254
*	2A	Inserts contact number (can be used for 1 channel only)

◇ Codes for memory name contents

To send or read the desired memory name settings, the character codes, instructed codes for memory keyer contents as above, and follows are additionally used.

• Character's code— Alphabetical characters

Character	ASCII code	Character	ASCII code
a-z	61-7A	—	—

• Character's code— Symbols

Character	ASCII code	Character	ASCII code
!	21	#	23
\$	24	%	25
&	26	¥	5C
?	3F	"	22
'	27	`	60
+	2B	-	2D
:	3A	;	3B
=	3D	<	3C
>	3E	(28
)	29	[5B
]	5D	{	7B
}	7D		7C
_	5F	—	7E

■ General

Set mode is used for programming infrequently changed values or conditions of functions. The IC-703 has 2 separate set modes: *quick set mode* and *initial set mode*.

◇ Quick set mode operation

- ① While power is ON, push [DISPLAY] for 1 sec.
 - Quick set mode is selected and one of its items appears.
 - Quick set mode items vary depending on the selected operating mode (SSB, FM, etc.).
- ② Push [MENU] one or more times to select the desired item.
 - [M-CH] or [▲]/[▼] can also be used.
- ③ Rotate the main dial to set the values or conditions for the selected item.
- ④ Repeat steps ② and ③ to set other items.
- ⑤ To exit quick set mode, push [DISPLAY] momentarily.

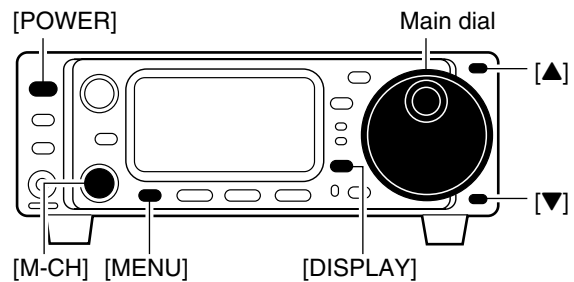

[DISPLAY EXAMPLE: QUICK SET MODE]

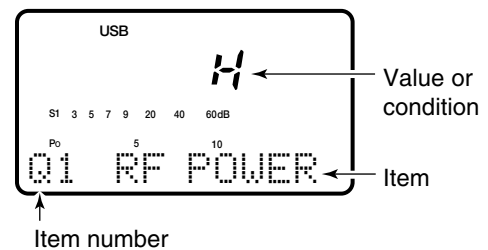

◇ Initial set mode operation

- ① Push [POWER] for 1 sec. to turn power OFF.
- ② While pushing [LOCK], push [POWER] to turn power ON.
 - Initial set mode is selected and one of its items appears.
- ③ Push [MENU] one or more times to select the desired item.
 - [M-CH] or [▲]/[▼] can also be used.
- ④ Rotate the main dial to set the values or conditions for the selected item.
- ⑤ Repeat steps ③ and ④ to set other items.
- ⑥ To exit initial set mode, push [POWER] for 1 sec. to turn power OFF.
- ⑦ Push [POWER] to turn power ON again.
 - The conditions selected in initial set mode are now effective.

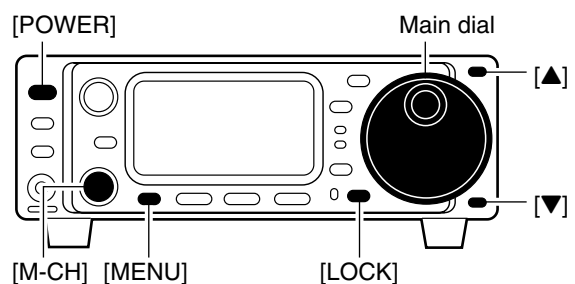

[DISPLAY EXAMPLE: INITIAL SET MODE]

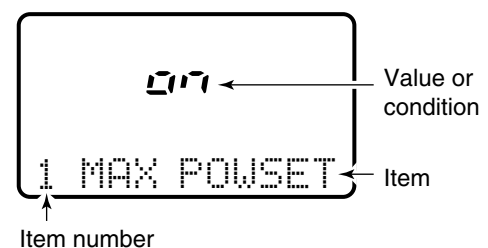

■ Quick set mode items

Mode	Set mode item	Default setting	Mode	Set mode item	Default setting
SSB	Q1 RF POWER	H	RTTY	Q1 RF POWER	H
	Q2 MIC GAIN	5 level		Q2 RTTY REV	n (normal)
	Q3 CARRIER Freq	0 [Hz]	SSB-D	Q1 RF POWER	H
CW	Q1 RF POWER	H	FM/AM	Q2 CAR SIDE	L (LSB side)
	Q2 KEY SPEED	20 [WPM]		Q1 RF POWER	H
	Q3 CW REV	n (normal)	Q2 MIC GAIN	5 level	

Q1 RF POWER (all modes)

This item adjusts the RF output power. The RF output power can be adjusted from L, 1 to 9 and H for indication, however, it can be adjusted continuously.

H

The default is H (maximum power). Note that while adjusting the output power, the power meter is displayed automatically.

Q2 MIC GAIN (SSB/AM/FM modes)

This item adjusts microphone gain from 1 to 10 for indication, however, it can be adjusted continuously.

5

The default is 5. Note that while adjusting mic gain, the ALC meter is displayed automatically.

Q2 KEY SPEED (CW mode)

This item adjusts the CW key speed. The key speed can be selected from 6 to 60 wpm.

CW

20

The default is 20 wpm.

Q2 RTTY REV (RTTY mode)

This item selects RTTY or **RTTY** (RTTY reverse) mode.

RTTY

n

The default is normal.

Q2 CAR SIDE (SSB-D mode)

This item selects the carrier point. USB mode or LSB mode are selectable.

LSB

L

The default is LSB mode.

Q3 CARRIER Freq (SSB mode)

This item adjusts the carrier frequency (BFO frequency), allowing you to change the audio characteristics. Selectable values are -200 to +200 Hz in 10 Hz steps.

USB

0

The default is 0 Hz.

Q3 CW REV (CW mode)

This item selects CW or **CW** (CW reverse) mode.

CW

n

The default is normal.

■ Initial set mode items

1 MAX POWSET (Max. output power setting)

This item selects maximum output power. The max. power is can be set 10, 5, 2.5, 1 or 0.5 W.



The default is 10 W.

2 PoSAVE MODE (Power save setting)

The power save mode reduces the current drain to conserve battery power. This function is convenience for battery operation.

AUTO : The power save function starts in 1:1 (200 msec.:200 msec.) ratio when no signal is received for 5 sec., then the ratio becomes in 1:4 (200 msec.:800 msec.) and 1:8 (200 msec.:1600 msec.) after no signal is received every 60 sec. are past.

(1 :) 1, 4, 8, 16:

The power save function activates selected ratio.

oFF : The power save function does not activate.

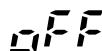

The default is OFF.

3 SIMPLE MODE (Simple mode setting)

This item select the simple mode and normal mode.

on : Simple mode is selected. (*) marked items in initial set mode are hidden, and push [DISPLAY] to select Main menu or Sub menu only, Graphic menu also hidden.

oFF : Normal mode is selected.



Simple mode ON



Simple mode OFF (default)

4 MODE SELECT (Mode Availavility)

This item is available in all modes, and allows you to simplify operation by inhibiting the selection of un-needed operating modes during normal operation. For example if you are operating mobile and only plan on using FM and AM modes, use "4 MODE SELECT" to inhibit access to all other modes (SSB, CW, RTTY), thereby making selection of AM or FM quick and easy.



The default is on for all operating modes. To toggle an operating mode on or off, push (or push and hold) [MODE] one or more times until the desired mode is displayed, then rotate the main dial to set on or off.

* 5 MODE POWSET (Output power setting for modes)

This item allows you to set the output power for each operating mode.

on : Output power can be set for each mode groups.

oFF: Same output power for every mode.

The mode groups are separated 'SSB-D/USB/LSB,' 'CW' and 'RTTY/AM/FM.'

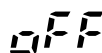

The default is OFF.

When "3 SIMPLE MODE" is set to ON, * marked items are undisplayed.

6 BEEP (Confirmation beeps)

A beep sounds each time a switch is pushed to confirm it. This function can be turned OFF for silent operation.

on

Confirmation beep ON (default)

off

Confirmation beep OFF

*** 7 BAND BEEP (Band edges beep)**

A beep sounds when an operating frequency enters or exits a transmit frequency range. This functions independent of the confirmation beep setting (above).

on

Band beep ON (default)

off

Band beep OFF

8 BEEP LEVEL (Beep level adjustment)

When "6 BEEP" is set ON, this item adjust the confirmation beep level. Adjustable levels are 0 to 10 in 1 steps.

5

The default is 5.

*** 9 BEEP LIMIT (Beep audio level limit)**

This item allows you to set a maximum volume level for confirmation beep tones. Confirmation beep tones are linked to the [AF] control until a specified volume level is reached—further rotation of the [AF] control will not increase the volume of the beep tones.

on

Beep limit ON (default)

off

Beep limit OFF

*** 10 CW NOR SIDE (CW carrier point setting)**

This item select the carrier point of CW mode from LSB and USB.

LSB

The carrier point is LSB side (default).

USB

The carrier point is USB side.

11 SID-T LEVEL (CW side tone level)

This item sets the CW side tone output level. Selectable levels are 0 to 10 in 1 steps.

5

The default is 5.

*** 12 SID-T LIMIT (CW side tone level limit)**

This item sets the CW side tone level limit. When the [AF] control is rotated above a specified level, the CW side tone does not increase.

on

CW side tone limit ON (default)

off

CW side tone limit OFF

on : CW side tone level is limited. (default)
off : CW side tone level is not limited.

*** 13 SYNC TUNING (SSB/CW frequency shift setting)**

This item selects the displayed frequency shift function from ON and OFF.

When this function is activated, the receiving signal can be kept in receive even when the operating mode is changed between SSB and CW.

oN : The displayed frequency shifts when the operating mode is changed between SSB and CW.
oFF: The displayed frequency does not shift. (default)

oN

Synchronous tuning ON

oFF

Synchronous tuning OFF (default)

▨ The frequency shifting value may differ according to the CW pitch setting.

14 BACK LIGHT (Display backlighting)

The function display backlighting can be set to high, low or OFF to suit ambient lighting.

Hl

Display backlighting set to high (default).

Lo

Display backlighting set to low.

15 KEY LIGHT (Key/switch backlighting)

The key/switch backlighting can be set to high, low or OFF to suit ambient lighting.

Hl

Key/switch backlighting set to high (default).

Lo

Key/switch backlighting set to low.

*** 16 LIGHT TIMER (Light timer setting)**

The Light timer can be set to AUTO, ON or OFF to suit lighting condition.

Auto

Default is Auto.

Auto: Automatically select "on" or "oFF" depends on power supply voltage. (default)

on : Lights when some operation is performed, goes out after 5 sec.

oFF : Lights continuously during transceiver power is ON.

17 LED BRIGHT (LED brightness)

The LED brightness control for front panel can be set to high or low.

Hl

LED brightness set to high.

Lo

LED brightness set to low (default).

*** 18 AUTO OFF (Automatic power OFF)**

The auto power OFF function can be used to automatically turn the transceiver OFF after a specified time of operation. This item can be set to 30 min., 60 min., 90 min., 120 min., or OFF.

oFF

Auto power OFF deactivates. (default)

20

Auto power OFF set to 20 min.

19 CURRENT IP (Current intercept point)

This item set the control of current intercept point for power saving.

Auto

Default is Auto.

Auto: Automatically select “on” or “oFF” depends on power supply voltage. (default)
 on : Power saving mode continuously.
 oFF : Priority to intercept point.

*** 20 RF/SQL (RF gain/squelch control)**

The [RF/SQL] control can be set as the squelch control (default), the RF/squelch control (USA version default) or automatic (acts as squelch in FM/AM modes; as RF in SSB/CW/RTTY modes). (See p. 24)

RF SQL

The [RF/SQL] control functions as RF gain and squelch control for all modes.

SQL

The [RF/SQL] control functions as squelch control only.

*** 21 SUB DIAL (Sub dial setting)**

When this item is set to “rit,” pushing [RIT/SUB] turns the RIT function ON (lights red)—rotating [M-CH] changes the RIT frequency; when this item is set to “FrEq,” pushing [RIT/SUB] turns the sub dial function ON (lights green)—rotating [M-CH] changes the operating frequency. Note that in FM and AM modes, pushing [RIT/SUB] always selects the sub dial function (lights green), regardless of this setting.

rit

Pushing [RIT/SUB] selects the RIT function (default).

FrEq

Pushing [RIT/SUB] selects the sub dial function.

22 OPT. FIL (Optional filter selection)

When an optional filter is installed, this selection is necessary, otherwise the filters cannot be selected. Selections available are FL-52A, FL-53A, FL-222, FL-257 and none (default). See p. 49 for usable filters for each mode and see p. 87 for filter installation.

no

No filters are selected (default).

FL - 52A

FL-52A (for CW narrow filter) is selected.

Although the FL-96 is not listed on the option list, IC-703 would take FL-96 as well as other optional filter.

*** 23 PEAK HOLD (Peak meter hold setting)**

When the peak hold function is ON, the highest activated segment of the meter remains visible for 0.5 sec.; when OFF, the meter functions normally.

on

Peak hold ON (default)

oFF

Peak hold OFF

*** 24 QUICK SPLIT (Quick split function)**

When this item is set to ON, pushing [(F-1)SPL] for 1 sec. in the M1 display sets the undisplayed VFO frequency to the displayed VFO frequency plus the split offset, and activates split operation.

on

Quick split function ON (default).

oFF

Quick split function OFF.

*** 25 SPLIT LOCK (Split lock function)**

When this item is ON, the main dial can be used to adjust the transmit frequency while pushing [(F-3)XFC] even when the lock function is activated.

OFF

Split lock function OFF (default)

ON

Split lock function ON

26 SPL OFFSET (Split offset frequency)

This item sets the offset (difference between transmit and receive frequencies) for the quick split function. Available offset frequencies are -9.999 to 9.999 MHz in 0.001 MHz (1kHz) steps.

0.000

Default is 0.000 MHz.

27 SCAN RESUME (Scan resume condition)

This item sets the scan resume function ON or OFF.

on : Scan resumes 10 sec. after stopping on a signal (or 2 sec. after a signal disappears);

off: Scan does not resume after stopping on a signal. For the priority watch, setting to OFF pauses the watch until signal disappears and scan resumes.

ON

Scan resume function is turned ON (default).

OFF

Scan resume function is turned OFF.

28 SCAN SPEED (Scanning speed)

This item sets the rate at which channels or frequencies are scanned during scan operations. High or low can be selected.

H I

Scan speed is set to high (default).

Lo

Scan speed is set to low.

29 U/D SPEED ([UP]/[DN] speed)

This item sets the rate at which frequencies are scanned through when the [UP]/[DN] switches of the microphone are pushed and held. High or low can be selected.

H I

Up/down speed is set to high (default).

Lo

Up/down speed is set to low.

*** 30 AM NB (Noise blanker in AM mode)**

When this item is set to ON, the noise blanker function is available in AM mode. This is useful when communicating in AM mode (the noise blanker function should not be used when listening to regular AM broadcasts as it may degrade the received audio).

ON

Noise blanker is available on AM mode. (default)

OFF

Noise blanker is not available on AM mode.

31 PAD CH (Available memo pads)

This item sets the number of memo pad channels available. 5 or 10 memo pads can be selected.

5

5 memo pads are available (default).

10

10 memo pads are available.

When "3 SIMPLE MODE" is set to ON, * marked items are undisplayed.

32 PWR ON CHK (Power on check function)

This item selects the indication ON or OFF when turning power ON.

on : The Transceiver briefly displays 'All indication,' 'RF power' and 'Power supply voltage' when turning power ON.

oFF: The display goes directly to frequency indication at power ON.

on

Power on check ON (default)

oFF

Power on check OFF

*** 33 A-TUNE STRT (Auto tune start function)**

The optional AT-180 ANTENNA TUNER has an automatic start capability which starts tuning if the SWR is higher than 1.5–3.

oFF: The tuner remains OFF even when the SWR is poor (1.5–3).

on : Automatic tune starts even when the tuner is turned OFF.

oFF

Auto tune function OFF (default).

on

Auto tune function ON.

NOTE: Even when "on" is selected, automatic tune does not start for the 50 MHz band.

*** 34 PTT TUNE (PTT tune function)**

This item set the PTT tuner start function ON or OFF. This function activates internal tuner and optional AT-180/AH-4 ANTENNA TUNER, when connected.

on : The tuner is always tuned when the PTT is pushed after the frequency is changed (more than 1% from last-tuned frequency). (Internal tuner or connected AT-180)

Tuning can be started automatically at the moment the PTT is pushed. (Connected AH-4)

oFF : PTT tuner start function OFF.

oFF

Tuning starts only when [TUNER] is pushed (default).

on

Tuning starts when pushing [PTT] on a new frequency.

*** 35 TUNER SW (Tuner switch condition)**

This item select BAND or ALL.

bAnd : [TUNER] switch ON/OFF condition is remained for each band.

ALL : [TUNER] switch ON/OFF condition is commonly remained for all band.

bAnd

The default is BAND.

ALL

36 9600 MODE (Packet data speed)

This item is used to change the communications speed for packet operation. The data socket speed can be set to 1200 or 9600 baud.

9600

Default is 9600 baud.

37 SPEECH LANG (Voice synthesizer language)

When the optional UT-102 VOICE SYNTHESIZER UNIT is installed, you can select between English and Japanese as the language.

EN

Voice synthesizer functions in English (default).

JPN

Voice synthesizer functions in Japanese.

38 SPEECH SPD (Voice synthesizer speed)

When the optional UT-102 VOICE SYNTHESIZER UNIT is installed, you can select the speech speed of synthesizer output between faster or slower.

HI

Speech speed is faster (default).

LO

Speech speed is slower.

39 S-LVL SPCH (S-meter level speech)

When an optional UT-102 SPEECH SYNTHESIZER UNIT is installed, the synthesizer can be set to read out the frequency/mode only, or both the frequency/mode and S-meter level.

ON

Voice synthesizer reads out both the frequency/mode and S-meter level (default).

OFF

Voice synthesizer reads out the frequency/mode only.

40 CI-V ADDRESS (CI-V address setting)

To distinguish equipment, each CI-V transceiver has its own Icom standard address in hexadecimal code. The IC-703's address is 68H.

When 2 or more IC-703's are connected to an optional CT-17 CI-V LEVEL CONVERTER, rotate the main dial to select a different address for each IC-703 in the range 01H to 7FH.

68H

Address set to 68H (default).

7FH

Address set to 7FH.

*** 41 CI-V BAUD (CI-V data transfer rate)**

This item sets the data transfer rate. When "Auto" is selected, the baud rate is automatically set according to the connected controller or remote controller.

Auto

Auto baud rate (default)

19200

19200 bps

*** 42 CI-V TRN (CI-V transceive)**

Transceiver operation is possible with the IC-703 connected to other Icom HF transceivers or receivers. When "on" is selected, changing the frequency, operating mode, etc. on the IC-703 automatically changes those of connected transceivers (or receivers) and vice versa.

ON

Transceive ON (default)

OFF

Transceive OFF

*** 43 CI-V 731 (CI-V operating frequency data length)**

When connecting the IC-703 to the IC-735 for transceiver operation, you must change the operating frequency data length to 4 bytes.

• This item MUST be set to "on" only when operating transceiver with the IC-735.

OFF

Frequency data set to 5 bytes (default).

ON

Frequency data set to 4 bytes.

When "3 SIMPLE MODE" is set to ON, * marked items are undisplayed.

■ Fuse replacement

If a fuse blows or the transceiver stops functioning, try to find the source of the problem, and replace the damaged fuse with a new, rated fuse.

CAUTION: Disconnect the DC power cable from the transceiver when changing a fuse.

The IC-703 has three of fuses (DC power cable fuses×2, circuitry fuse×1) installed for transceiver protection.

•Fuses F.G.B. 125 V 4 A

DC POWER CABLE FUSE REPLACEMENT

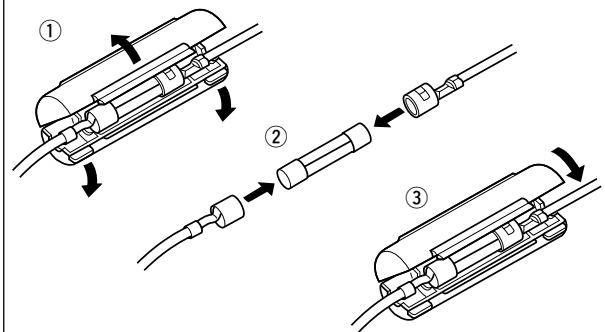

CIRCUITRY FUSE REPLACEMENT

The 13.8 V DC from the DC power cable is applied to all units in the IC-703, except for the power amplifier, through the circuitry fuse. This fuse is installed in the PA unit.

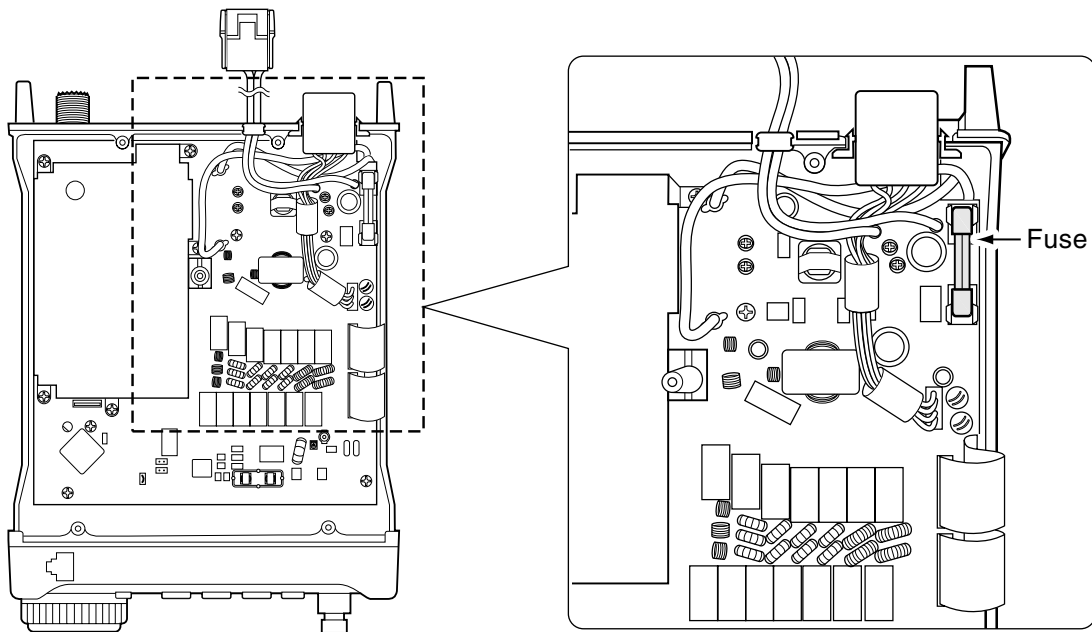

■ Memory backup

All of the CPU's memory is backed up by an EEPROM (Electrically-Erasable Programmable Read-Only Memory). All data you set, such as VFO, memory, set mode contents, etc. is stored in this EEPROM. There is no internal lithium battery.

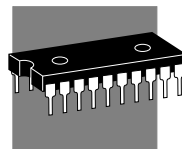

■ Cleaning



If the transceiver becomes dusty or dirty, wipe it clean with a dry, soft cloth.



AVOID the use of strong chemical solvents such as thinner, benzene or alcohol to clean the transceiver. These may damage the transceiver's surfaces.

The following chart is designed to help you correct problems which are not equipment malfunctions.

If you are unable to locate the cause of a problem or solve it through the use of this chart, contact your nearest Icom Dealer or Service Center.

	PROBLEM	POSSIBLE CAUSE	SOLUTION	REF.
POWER SUPPLY	Power does not come on when the [POWER] switch is pushed.	<ul style="list-style-type: none"> • DC power cable is improperly connected. • Fuse is blown. • Battery is exhausted if you are using a 12 V battery as the power source. 	<ul style="list-style-type: none"> • Reconnect the power cable correctly. • Check for the cause, then replace the fuse with a spare one. (Fuses are installed in two places. One is installed in the DC power cable and the other is installed in the PA unit.) • Check the battery voltage with the [POWER] pushed IN. 	<p>p. 15</p> <p>p. 83</p> <p>—</p>
	RECEIVE	No sound comes from the speaker.	<ul style="list-style-type: none"> • Volume level is set too low. • The squelch is closed. • The transceiver is in the transmitting condition. • An external speaker or headphones are connected. 	<ul style="list-style-type: none"> • Rotate [AF] clockwise to obtain a suitable listening level. • Rotate [SQL] counterclockwise to open the squelch. • Release [PTT] on the microphone or check the SEND line of an external unit, if connected. • Check the external speaker or headphone plug connection.
Sensitivity is low.		<ul style="list-style-type: none"> • The antenna is not connected properly. • The antenna feed line is cut or shorted. • The antenna is not properly tuned. • The attenuator function is activated. 	<ul style="list-style-type: none"> • Reconnect to the antenna connector. • Check the feed line and correct any improper conditions. • Push [TUNE] to manually tune the antenna. • Push [ATT] to turn the function OFF. 	<p>—</p> <p>—</p> <p>pgs. 64– 66</p> <p>p. 46</p>
Receive audio is distorted.		<ul style="list-style-type: none"> • The operating mode is not selected correctly. • The [SHIFT] control is set off-center. 	<ul style="list-style-type: none"> • Select a suitable operating mode. • Set [SHIFT] to the center position. 	<p>p. 23</p> <p>p. 47</p>
Receive signal is distorted with strong signals.		<ul style="list-style-type: none"> • Noise blanker function is activated. • Preamp is activated. 	<ul style="list-style-type: none"> • Push [(F-2)NE] in the M3 display to turn the function OFF. • Push [P.AMP] to turn the function OFF. 	<p>p. 48</p> <p>p. 46</p>

	PROBLEM	POSSIBLE CAUSE	SOLUTION	REF.
TRANSMIT	Transmitting is impossible.	<ul style="list-style-type: none"> The operating frequency is not set to a ham band. 	<ul style="list-style-type: none"> Set the frequency to a ham band. 	p. 19
	Output power is too low.	<ul style="list-style-type: none"> Power is set to a lower power than maximum. Microphone gain is set too low. The antenna is not connected properly. The antenna feed line is cut or shorted. The antenna is not properly tuned. The transceiver turning ON the battery operating mode. 	<ul style="list-style-type: none"> Set the output power in quick set mode/initial set mode. Set microphone gain to a suitable position using quick set mode. Reconnect the antenna connector. Check the feed line and correct any improper conditions. Push [TUNE] to manually tune the antenna. Check the battery voltage with the [POWER] pushed IN. 	pgs. 25, 26 p. 26 — — pgs. 64–66 pgs. 1, 25
	No contact possible with other stations.	<ul style="list-style-type: none"> RIT function is activated. Split function is activated. 	<ul style="list-style-type: none"> Push [RIT] to turn the function OFF. Push [(F-1)SPL] in the M1 display to turn the function OFF. 	p. 47 p. 51
	Repeater cannot be accessed.	<ul style="list-style-type: none"> Split function is not activated. An incorrect transmit frequency is set. Subaudible tone encoder is OFF and repeater requires a tone for access. Programmed subaudible tone frequency is wrong. 	<ul style="list-style-type: none"> Push [(F-1)SPL] in the M1 display to turn the function ON. Set the proper frequencies into VFO A and B or into one of the memory channels. Use [(F-2)TON] in the M4 display to select FM-T. Program the required frequency using FM tone set mode. 	p. 51 p. 19 p. 45 p. 44
	Transmitted signals are distorted.	<ul style="list-style-type: none"> Microphone gain is set too high. The compression level is set too high with the speech compressor ON. 	<ul style="list-style-type: none"> Set gain in quick set mode. Set compression level to a suitable position. 	p. 26 p. 54
DISPLAY	Displayed frequency does not change properly.	<ul style="list-style-type: none"> The dial lock function is activated. The internal CPU has malfunctioned. 	<ul style="list-style-type: none"> Push [LOCK] to deactivate the function. Reset the CPU. (While pushing [UP] and [DN] push [POWER] to turn power ON. 	p. 25 p. 17
SCAN	Programmed scan does not stop.	<ul style="list-style-type: none"> Squelch is open. 	<ul style="list-style-type: none"> Set squelch to the threshold position. 	p. 24
	Programmed scan does not start.	<ul style="list-style-type: none"> The same frequencies have been programmed in scan edge memory channels. 	<ul style="list-style-type: none"> Program different frequencies into scan edge memory channels. 	p. 62
	Memory scan does not start.	<ul style="list-style-type: none"> 2 or more memory channels have not been programmed. 	<ul style="list-style-type: none"> Program 2 or more memory channels. 	p. 62
	Memory select scan does not start.	<ul style="list-style-type: none"> 2 or more memory channels have not been designated as select channels. 	<ul style="list-style-type: none"> Designate 2 or more memory channels as select channels for the scan. 	p. 63

■ Opening the transceiver case

To remove the transceiver case unscrew the 18 screws (5 in the top panel, 5 in the bottom panel, 8 in the side panels: 4 pieces each) as shown in the diagram below.

Caution: Disconnect the DC power cable from the transceiver before performing any work on the transceiver.

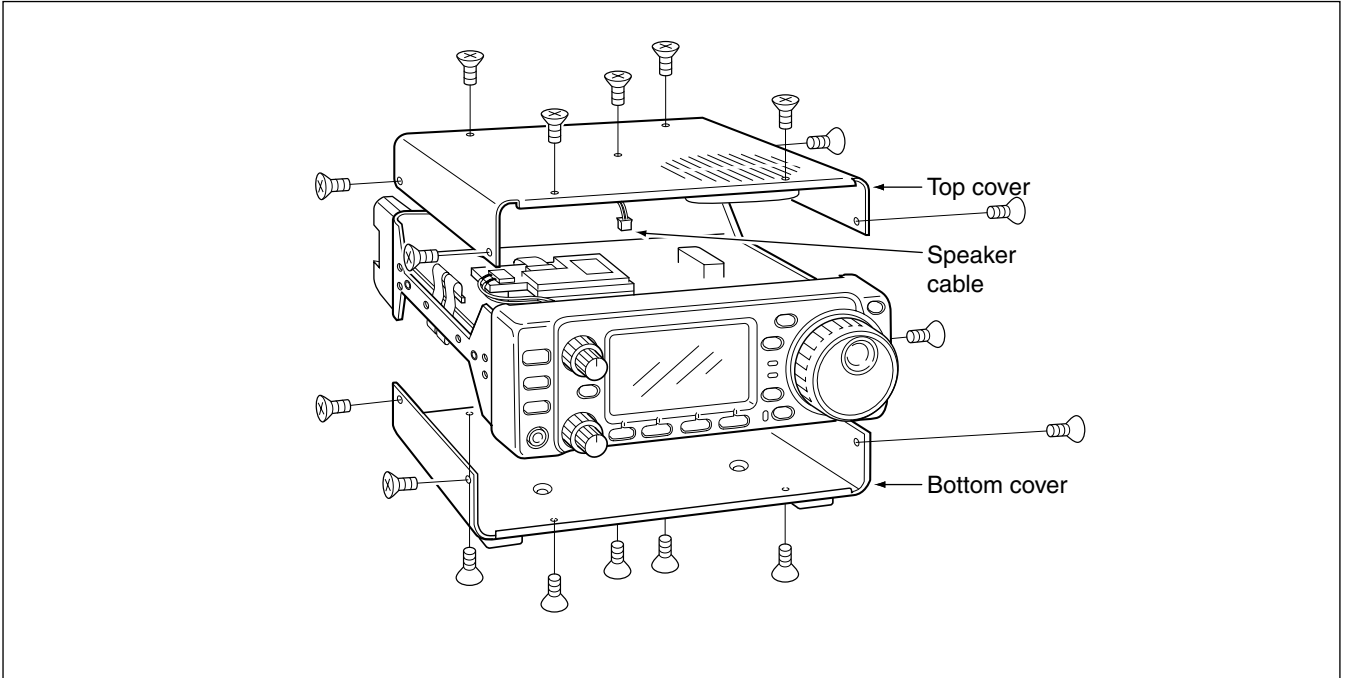

■ UT-102 VOICE SYNTHESIZER UNIT

The UT-102 announces the accessed band's frequency, mode, etc. (S-meter level can also be announced—p. 82) in a clear, electronically generated voice, in English (or Japanese).

- ① Remove the top cover as shown above.
- ② Connect the UT-102 as shown in the diagram at right (label side up).
- ③ Replace the top cover.

◆ Operation

- ① Select the desired announcing condition, such as speed, language, contents, in initial set mode. (p. 82)
- ② Push [LOCK] for 1 sec. (until "zero" is announced) to announces the selected contents.

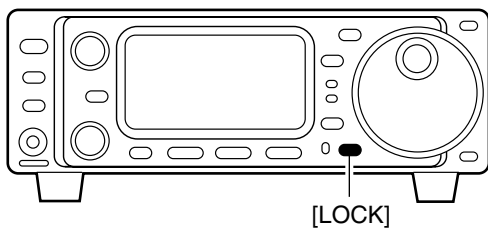
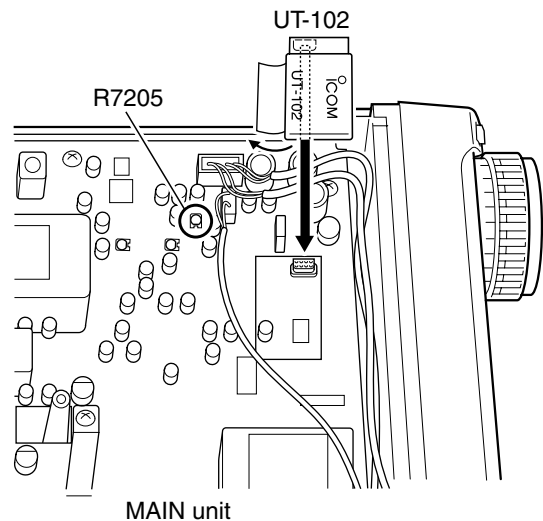

✓ **Adjusting the announcing audio level**
 ➔ Adjust the R7205 on the MAIN unit .

IF filter

Several IF filters are available for the IC-703. Choose a filter most appropriate to your operating needs.

NOTE: After filter installation, specify the installed filter using initial set mode (item 22, p.79). Otherwise, the installed filter will not function properly.

FL-52A CW/RTTY NARROW FILTER	500 Hz/−6 dB
FL-53A CW NARROW FILTER	250 Hz/−6 dB
FL-222 SSB NARROW FILTER	1.8 kHz/−6 dB
FL-257 SSB WIDE FILTER	3.3 kHz/−6 dB

- ① Remove the top cover as shown on the previous page.
- ② Disconnect the coaxial cable connectors, P2 and P4, then unscrew 10 screws on the MAIN unit.
 - Attach the grounding spring at the same place when returning.
- ③ Slide the MAIN unit in the direction of the arrow ①, then open the MAIN unit in the direction of the arrow ②.
 - Be careful for the flat cables.

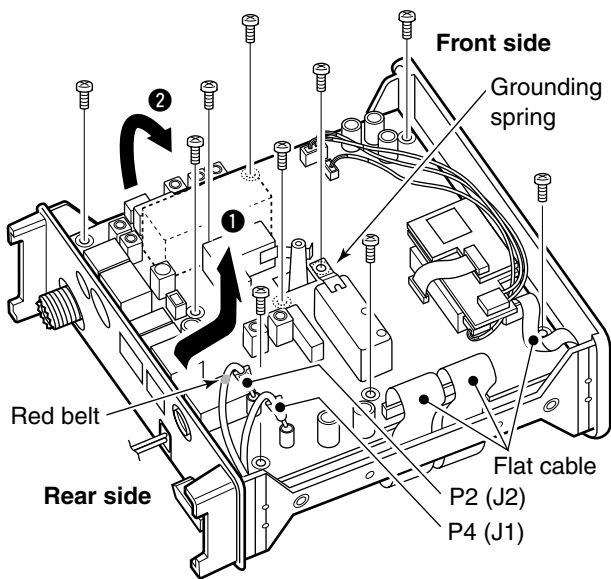

- ④ Install the desired filter as shown in the diagram below.

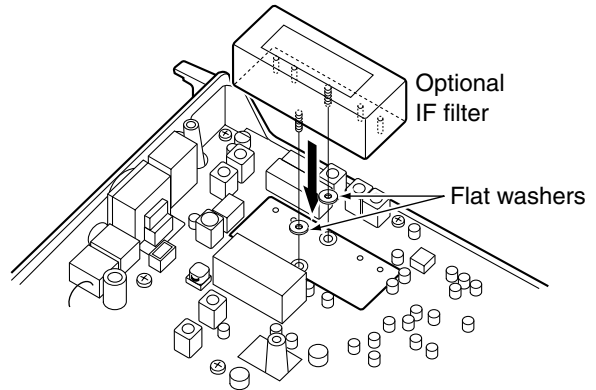

- ⑤ Tighten the nuts then solder the filter's pins.
- ⑥ Return the MAIN unit to the original position.

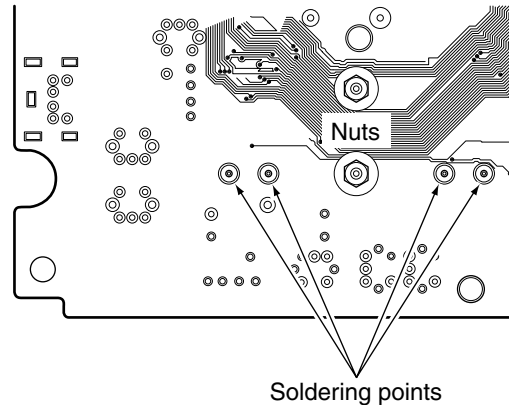

• Make sure to attach the grounding spring to the original position.

- ⑦ Connect P2 and P4 to J2 and J1, respectively.
- ⑧ Replace the top cover.

■ UT-106 DSP RECEIVER UNIT

- ① Open the transceiver top cover as shown on p. 86.
- ② Remove the 4-pin connector (P2451) from main CPU shielding case on the MAIN unit (top side) and plug it into J1 of the UT-106.

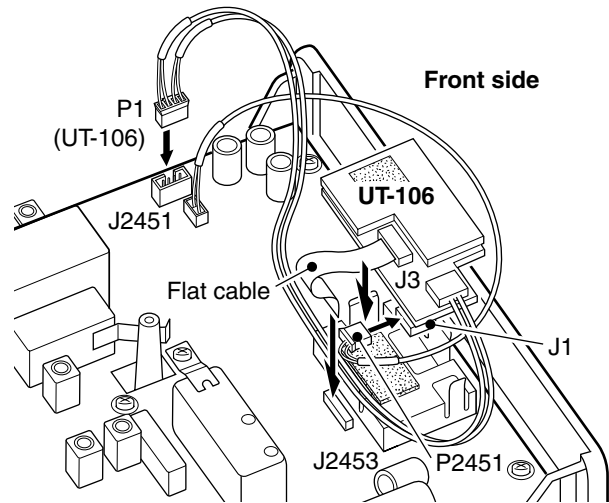
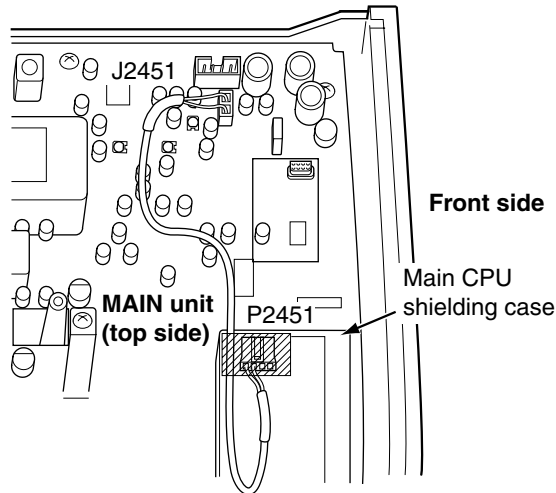

- ③ Plug the 4-pin connector (P1) from the UT-106 into J2451 on the MAIN unit.
- ④ Plug the supplied flat cable into J3 on the UT-106 and J2453 on the MAIN unit.
• Be careful of the orientation of the flat cable.
- ⑤ Attach the UT-106 to the main CPU shielding case, using the existing guide for alignment, as illustrated at right above

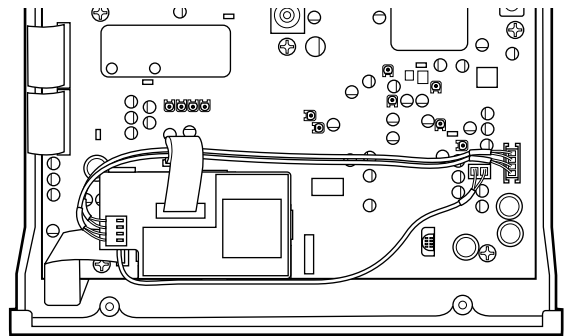

- ⑥ Reassemble the transceiver.

■ MB-72 CARRYING HANDLE

The optional MB-72 CARRYING HANDLE is convenient when carrying the transceiver for DX'peditions, field operation, etc.

- ① Tighten the supplied screws plus rubber feet as shown below.

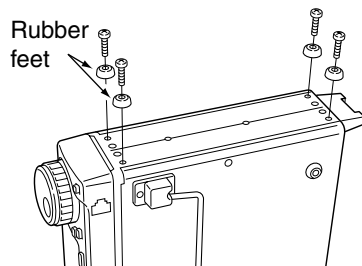

- ② Attach the MB-72 to the left side of the transceiver as shown below.

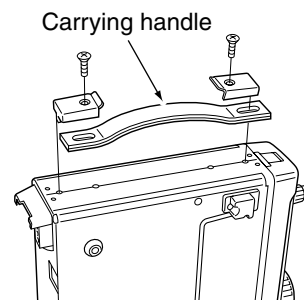

■ AT-180 internal switch description

The optional AT-180 has 3 operating conditions for HF band operation. Select a suitable condition according to your antenna system.

- ① Remove the top cover of the AT-180.
- ② Set the tuner switches to the desired positions according to the table below.

SW	Position	Operation
S1	A (default)	The tuner operating condition is set by S2 described below.
	B	THROUGH INHIBIT The tuner tunes the antenna even when the antenna has poor SWR (up to VSWR 3:1 after tuning). In this case, manual tuning is necessary each time you change the frequency although the tuner automatically starts tuning when the VSWR is higher than 3:1. This setting is called "through inhibit," however, the tuner is set to "through" if the VSWR is higher than 3:1 after tuning.
S2	C	TUNER SENSITIVE CONDITION The tuner tunes each time you transmit (except SSB mode). Therefore, the lowest SWR is obtained at any given time. For SSB mode, the same condition as the "D" position.
	D (default)	NORMAL CONDITION The tuner tunes when the SWR is higher than 1.5:1. Therefore, the tuner activates only when tuning is necessary.

• Specifications for the AT-180

- Frequency coverage : 1.9–54 MHz
- Input impedance : 50 Ω
- Maximum input power : 120 W
- Minimum tuning power : 8 W
- Matching impedance range : 16.7–150 Ω (HF band)
20–125 Ω (50 MHz band)
- Tuning accuracy : Less than SWR 1.5:1
- Insertion loss : Less than 1.0 dB (after tuning)
- Power supply requirements : 13.8 V DC/1 A (supplied from the transceiver's ACC socket)
- Dimensions (mm/in) : 167(W)×58.6(H)×225(D)
6⁹/₁₆(W)×2⁵/₁₇(H)×8⁷/₈(D)
- Weight : 2.4 kg; 5 lb 4 oz
- Supplied accessories : coaxial cable (1 m),
ACC cable (DIN 13 pins)

• AT-180 inside top cover

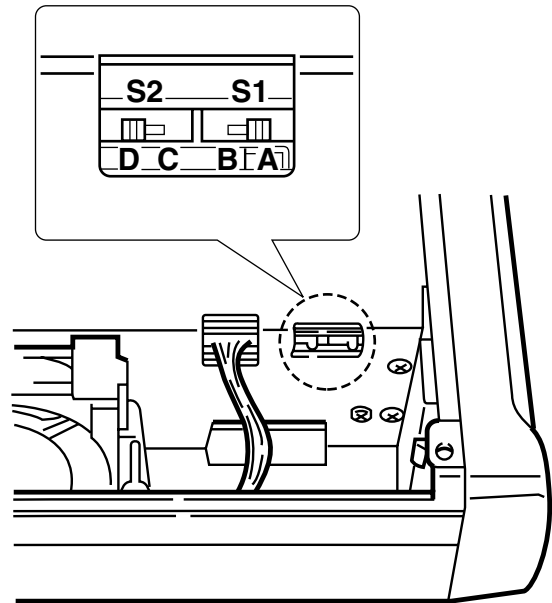

• Connector information for ACC(2) socket



PIN NO./ NAME	DESCRIPTION
① 8 V	Regulated 8 V output. (10 mA max.)
② GND	Connects to ground.
③ SEND	Input/output pin. Goes to ground when transmitting (20 mA max). When grounded, transmits.
④ BAND	Band voltage output. (Varies with amateur band; 0 to 8.0 V).
⑤ ALC	ALC output voltage (–4 to 0 V).
⑥ NC	No connection.
⑦ 13.8V	13.8 V output when power is ON (1 A max).

■ General

- Frequency coverage : Receive
30 kHz–60.00000 MHz*
- Transmit
1.800– 1.99999 MHz*
3.500– 3.9999 MHz*
7.000– 7.300 MHz*
10.100– 10.150 MHz
14.000– 14.350 MHz
18.068– 18.168 MHz
21.000– 21.450 MHz
24.890– 24.990 MHz
28.000– 29.700 MHz
50.000– 54.000 MHz*
- *Depending on version.
- Mode : SSB, CW, AM, FM, RTTY
- Number of memory channels : 105 (split memory: 99; scan edges: 6)
- Antenna connector : SO-239/50 Ω
- Usable temperature range : –10°C to +60°C (+14°F to +140°F)
- Frequency stability : Less than ±0.5 ppm
(0°C to +50°C; +32°F to +122°F).
- Power supply requirement : 9–15.87 V DC (negative ground)
- Current drain :
 - Transmit 2.0 A typ. (TX 5 W at 9.6 V DC)
3.0 A typ. (TX 10 W at 13.8 V DC)
 - Receive squelched max. audio 300 mA typ. (at 9.6 V DC)
450 mA typ. (at 9.6 V DC)
1.2 A (at 13.8V DC)
- Dimensions : 167(W)×58(H)×200(D) mm,
(projections not included) 6⁹/₁₆(W)×2⁵/₁₆(H)×7⁷/₈(D) in
- Weight : 2.0 kg (4 lb 4 oz)
- CI-V connector : 2-conductor 3.5 (d) mm (1/8")
- ACC connector : 13-pin

■ Transmitter

- Output power :
 - SSB, CW, FM, RTTY 0.1–5 W (at 9.6 V DC)
0.1–10 W (at 13.8 V DC)
 - AM 0.1–2 W (at 9.6 V DC)
0.1–4 W (at 13.8 V DC)
- Modulation system :
 - SSB Balanced modulation
 - AM Low level modulation
 - FM Variable reactance modulation
- Spurious emissions : Less than –60 dB*
*spurious freq.: below 30 MHz: –50 dB; above 50 MHz: –60 dB
- Carrier suppression : More than 40 dB
- Unwanted sideband : More than 50 dB
- Microphone connector : 8-pin modular jack (600 Ω)
- KEY connector : 3-conductor 6.35 (d) mm (1/4")

■ Receiver

- Receive system : Double-conversion superheterodyne
 - Intermediate frequencies:
 - 1st 64.455 MHz
 - 2nd 455 kHz
 - Sensitivity at pre-amp ON (typical):
- | Frequency range | SSB/CW/RTTY
10 dB S/N | AM
10 dB S/N | FM
12 dB SINAD |
|-----------------|--------------------------|-----------------|-------------------|
| 0.5–1.8 MHz | — | 13 μV | — |
| 1.8–28 MHz | 0.16 μV | 2.0 μV | — |
| 28–29.7 MHz | | | 0.5 μV |
| 50–54 MHz | 0.13 μV | 1.0 μV | 0.25 μV |
- Squelch sensitivity (threshold; preamp ON) :
 - SSB/CW/RTTY/AM Less than 5.6 μV
 - FM Less than 0.32 μV
 - Selectivity* (typical) :
 - SSB/CW More than 2.4 kHz/–6 dB
Less than 4.0 kHz/–60 dB
 - AM/FM-N More than 9.0 kHz/–6 dB
Less than 20.0 kHz/–50 dB
 - FM More than 15.0 kHz/–6 dB
Less than 30.0 kHz/–50 dB
 - *Without optional filter and with mid band selected.
 - Spurious and image rejection ratio:
 - HF bands More than 70 dB
 - 50 MHz band More than 65 dB (except IF through)
 - Audio output power : More than 0.5 W at 10% distortion
with an 8 Ω load (at 9.6 V DC)
More than 1.0 W at 10% distortion
with an 8 Ω load (at 13.8 V DC)
 - RIT variable range : ±9.99 kHz max.
 - PHONES connector : 3-conductor 3.5 (d) mm (1/8")/8 Ω
 - EXT SP connector : 2-conductor 3.5 (d) mm (1/8")/8 Ω

■ Antenna tuner

- Matching impedance range:
 - HF bands 16.7 to 150 Ω unbalanced
(Less than VSWR 3:1)
 - 50 MHz band 20 to 125 Ω unbalanced
(Less than VSWR 2.5:1)
- Tuning accuracy : VSWR 1.5:1 or less
- Insertion loss : Less than 1.0 dB (after tuning)

17 OPTIONS

AT-180 HF/50 MHz AUTOMATIC ANTENNA TUNER



Fully automatic antenna tuner with preset memories for each 100 kHz. Unique "automatic tuner on" function is available. See p. 89 for AT-180 specifications.

AH-4 HF AUTOMATIC ANTENNA TUNER



Specially designed to tune a long wire antenna for portable or mobile HF/50 MHz operation. The "PTT tune" function provides simple operation.

- Input power rating: 150 W

AH-2b ANTENNA ELEMENT



A 2.5 m long antenna element for mobile operation with the AH-4.

- Frequency coverage 7–54 MHz band with the AH-4

Optional filters



FL-52A CW/RTTY NARROW FILTER

(500 Hz/–6 dB)

FL-53A CW NARROW FILTER

(250 Hz/–6 dB)

FL-222 SSB NARROW FILTER

(1.8 kHz/–6 dB)

FL-257 SSB WIDE FILTER

(3.3 kHz/–6 dB)

HM-103 HAND MICROPHONE



Standard hand microphone.

SM-20 DESKTOP MICROPHONE



Includes [UP]/[DOWN] switches and a low cut function. The OPC-589 is necessary to use this microphone.

CT-17 CI-V LEVEL CONVERTER UNIT



For remote transceiver control using a personal computer equipped with an RS-232C port. You can change frequencies, operating mode, memory channels, etc., via your computer.

SP-7 EXTERNAL SPEAKER



Compact speaker for base station operation. Height can be adjusted for your convenience.

- Input impedance: 8 Ω
- Max. input power: 5 W

SP-10 EXTERNAL SPEAKER



External speakers suitable for mobile operation.

- SP-12: Slim-type; 8 Ω /3 W
- SP-10: Compact-type; 4 Ω /5 W

UT-102 VOICE SYNTHESIZER UNIT

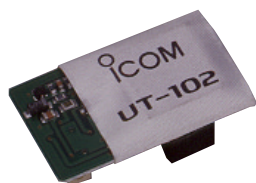

Announces the receive frequency, mode and S-meter level in a clear, electronically-generated voice in English (or Japanese).

MB-62 MOBILE MOUNTING BRACKET



Mounts the transceiver main body, with or without the front panel, inside a vehicle.

MB-63 MOUNTING BRACKET



Metal plate for attaching the front panel to a wall or other such flat surface.

MB-65 MOUNTING BASE



Allows you to conveniently vehicle-mount the front panel of the IC-703. An MB-63 must be used in combination with the MB-65.

MB-72 CARRYING HANDLE



Convenient when carrying the transceiver.

OPC-581/587 SEPARATION CABLE



Provide front panel detached operation for mobile installations or compact transceiver operation.

- OPC-581: 3.5 m (11.5 ft)
- OPC-587: 5 m (16.4 ft)

OPC-589 MICROPHONE ADAPTOR CABLE



Conversion between 8-pin modular and 8-pin metal connector for using a desktop microphone with the IC-703.

OPC-598 ACC 13-PIN CABLE



Required when using the AT-180.

OPC-599 ADAPTOR CABLE



13-pin, ACC connector to 7-pin + 8-pin ACC connector.

UT-106 DSP RECEIVER



Provides AF DSP functions such as noise reduction and auto notch. Built-in to some versions.

PS-125 DC POWER SUPPLY



Light weight switching regulator power supply. The OPC-1248 is necessary to use this power supply.

- Output voltage: 13.8 V
- Max. current drain: 25 A

LC-156 MULTI-BAG (with controller case)



BP-228 Ni-Cd BATTERY PACK (9.6 V, 2800 mAh)

Provides outdoor operation (max. output power 5 W).

OPC-1248 DC POWER ADAPTOR CABLE

Provides to connect PS-125. Connects 3-pin DC cable (OPC-1229) to 6-pin connector.

18 MENU GUIDE

 **LOCK** + power ON

Power OFF then ON to exit initial set mode. 

Initial set mode

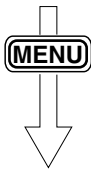

No.	Indication	Description	No.	Indication	Description
1	MAX POWSET	Max. output power setting	23	PEAK HOLD	Peak meter hold setting
2	POSAVE MODE	Power save setting	24	QUICK SPLIT	Quick split function
3	SIMPLE MODE	Simple mode setting	25	SPLIT LOCK	Split lock function
4	MODE SELECT	Mode availability	26	SPL OFFSET	Split offset frequency
5	MODE POWSET	Power setting for mode	27	SCAN RESUME	Scan resume condition
6	BEEP	Confirmation beeps	28	SCAN SPEED	Scanning speed
7	BAND BEEP	Band edge beeps	29	U/D SPEED	[UP]/[DN] speed
8	BEEP LEVEL	Beep level adjustment	30	AM NB	Noise blanker in AM mode
9	BEEP LIMIT	Beep audio level limit	31	PAD CH	Available memo pads
10	CW NOR SIDE	CW carrier point setting	32	PWR ON CHK	Power ON check function
11	SID-T LEVEL	CW side tone level	33	A-TUNE STRT	Auto tune start function
12	SID-T LIMIT	CW side tone level limit	34	PTT TUNE	PTT tune function
13	SYNC TUNING	Frequency shift setting	35	TUNER SW	Tuner switch condition
14	BACK LIGHT	Display backlighting	36	9600 MODE	Packet data speed
15	KEY LIGHT	Key/switch backlighting	37	SPEECH LANG	Voice synthesizer lang.
16	LIGHT TIMER	Light timer setting	38	SPEECH SPD	Voice synthesizer speed
17	LED BRIGHT	LED brightness	39	S-LVL SPCH	S-meter level speech
18	AUTO OFF	Automatic power OFF	40	CI-V ADDRES	CI-V address setting
19	CURRENT IP	Current intercept point	41	CI-V BAUD	Data transfer rate
20	RF/SQL	RF gain/squelch control	42	CI-V TRN	CI-V transceive
21	SUB DIAL	Sub dial setting	43	CI-V 731	CI-V data length
22	OPT. FIL	Optional filter selection			

*When "3 SIMPLE MODE" is set to ON,  box items are undisplayed.

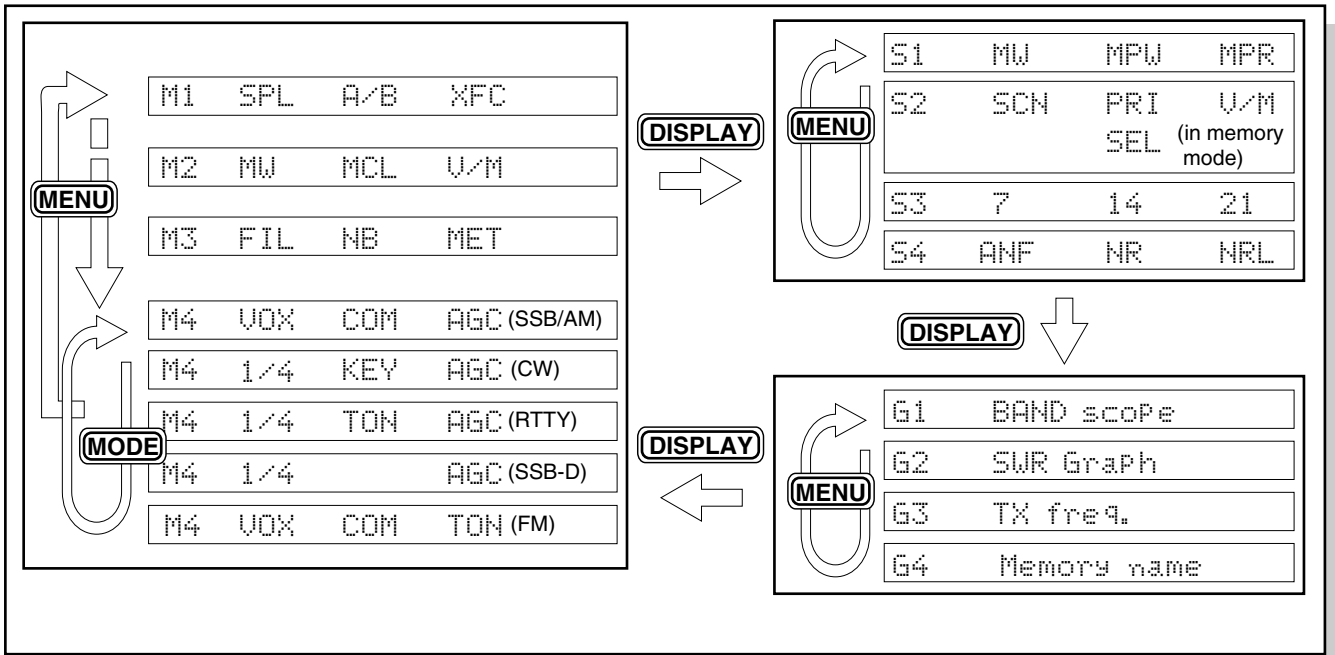

↑ **DISPLAY** **DISPLAY** ↓ For 1 sec.

Quick set mode

No.	SSB/AM/FM mode	CW mode	RTTY mode	SSB-D mode
Q1	RF POWER	RF POWER	RF POWER	RF POWER
Q2	MIC GAIN	KEY SPEED	RTTY REV	CAR SIDE
Q3	CARRIER Freq ^{*1}	CW REV	—	—

*1SSB mode only

INSTALLATION NOTES

For amateur base station installations it is recommended that the forwards clearance in front of the antenna array is calculated relative to the EIRP (Effective Isotropic Radiated Power). The clearance height below the antenna array can be determined in most cases from the RF power at the antenna input terminals.

As different exposure limits have been recommended for different frequencies, a relative table shows a guideline for installation considerations.

Below 30 MHz, the recommended limits are specified in terms of V/m or A/m fields as they are likely to fall within the near-field region. Similarly, the antenna may be physically short in terms of electrical length and that the installation will require some antenna matching device which can create local, high intensity magnetic fields. Analysis of such MF installations is best considered in association with published guidance notes such as the FCC OET Bulletin 65 Edition 97-01 and its annexes relative to amateur transmitter installations. The EC recommended limits are almost identical to the FCC specified 'uncontrolled' limits and tables exist that show pre-calculated safe distances for different antenna types for different frequency bands. Further information can be found at <http://www.arrl.org/>.

•Typical amateur radio installation

Exposure distance assumes that the predominant radiation pattern is forwards and that radiation vertically downwards is at unity gain (sidelobe suppression is equal to main lobe gain). This is true of almost every gain antenna today. Exposed persons are assumed to be beneath the antenna array and have a typical height to 1.8 m.

The figures assume the worst case emission of constant carrier.

For the bands 10 MHz and higher the following power density limits have been recommended:

10–50 MHz 2 W/sq m

EIRP clearance heights by frequency band

1 Watts	2.1 m
10 Watts	2.8 m
25 Watts	3.4 m
100 Watts	5 m
1000 Watts	12 m

Forward clearance, EIRP by frequency band

100 Watts	2 m
1000 Watts	6.5 m
10,000 Watts	20 m
100,000 Watts	65 m

In all cases any possible risk depends on the transmitter being activated for long periods. (actual recommendation limits are specified as an average during 6 minutes) Normally the transmitter is not active for long periods of time. Some radio licenses will require that a timer circuit automatically cuts the transmitter after 1–2 minutes etc.



Similarly some types of transmitter, SSB, CW, AM etc. have a lower 'average' output power and the assessed risk is even lower.



Versions of the IC-703 which display the "CE" symbol on the serial number seal, comply with the essential requirements of the European Radio and Telecommunication Terminal Directive 1999/5/EC.



This warning symbol indicates that this equipment operates in non-harmonised frequency bands and/or may be subject to licensing conditions in the country of use. Be sure to check that you have the correct version of this radio or the correct programming of this radio, to comply with national licensing requirement.

	DECLARATION OF CONFORMITY
<p>We Icom Inc. Japan 1-1-32, Kamiminami, Hirano-ku Osaka 547-0003, Japan</p>	
<p>Declare on our sole responsibility that this equipment complies with the essential requirements of the Radio and Telecommunications Terminal Equipment Directive, 1999/5/EC, and that any applicable Essential Test Suite measurements have been performed.</p>	
<p>Kind of equipment: <u>HF/50 MHz ALL MODE TRANSCEIVER</u></p>	
<p>Type-designation: <u>IC-703</u></p>	
<p>Version (where applicable): This compliance is based on conformity according to Annex III of the directive 1999/5/EC using the following harmonised standards:</p>	
<p>i) <u>Article 3.1a EN 60950 + A11</u></p>	
<p>ii) <u>Article 3.1b EN 301489-1 and EN 301489-15 (or ETS 300 684)</u></p>	
<p>iii) <u>Article 3.2 EN 301 783-2</u></p>	
<p>iv) _____</p>	
<p>v) _____</p>	
<p>CE </p> <p><u>Düsseldorf 14th Mar. 2003</u> Place and date of issue</p> <p>Icom (Europe) GmbH Himmelgeister straÙe 100 D-40225 Düsseldorf Authorized representative name</p> <p>T. Maebayashi General Manager</p> <p> Signature</p> <p>Icom Inc.</p>	

•Version and frequency coverage

Europe (#02, #12)	
Receive	Transmit
0.500–29.999 MHz	1.800– 1.999 MHz
50.000–54.000 MHz	3.500– 3.800 MHz
	7.000– 7.100 MHz
	10.100–10.150 MHz
	14.000–14.350 MHz
	18.068–18.168 MHz
	21.000–21.450 MHz
	24.890–24.990 MHz
	28.000–29.700 MHz
	50.000–52.000 MHz

Italy (#10, #20)	
Receive	Transmit
1.830– 1.850 MHz	1.830– 1.850 MHz
3.500– 3.800 MHz	3.500– 3.800 MHz
7.000– 7.100 MHz	7.000– 7.100 MHz
10.100–10.150 MHz	10.100–10.150 MHz
14.000–14.350 MHz	14.000–14.350 MHz
18.068–18.168 MHz	18.068–18.168 MHz
21.000–21.450 MHz	21.000–21.450 MHz
24.890–24.990 MHz	24.890–24.990 MHz
28.000–29.700 MHz	28.000–29.700 MHz

Count on us!

IC-703
#02, #12
(Europe)
HF+50 M

<Intended Country of Use>

GER FRA ESP SWE
 AUT NED POR DEN
 GBR BEL ITA FIN
 IRL LUX GRE SUI
 NOR

IC-703
#10, #20
(Italy)
HF only

<Intended Country of Use>

GER FRA ESP SWE
 AUT NED POR DEN
 GBR BEL ITA FIN
 IRL LUX GRE SUI
 NOR

Downloaded by

Amateur Radio Directory

Operation on the New 60 M Band

The new 60 M amateur band became available for use on July 3, 2003. Operation on this band is allowed on 5 discrete frequencies and must adhere to the following: 2.8 kHz bandwidth, USB mode, and transmit a maximum of 50 watts ERP (Effective Radiated Power).

■ Operation

It is the operator's responsibility to set all controls so that the transmission in the new band meets the stringent conditions under which we may use these frequencies.

703 Tuning Frequency	FCC Channel Center Frequency
5.33050 MHz	5.33200 MHz
5.34650 MHz	5.34800 MHz
5.36650 MHz	5.36800 MHz
5.37150 MHz	5.37300 MHz
5.40350 MHz	5.40500 MHz

NOTE: We recommend that you store these frequencies into the memory channel for easy recall.

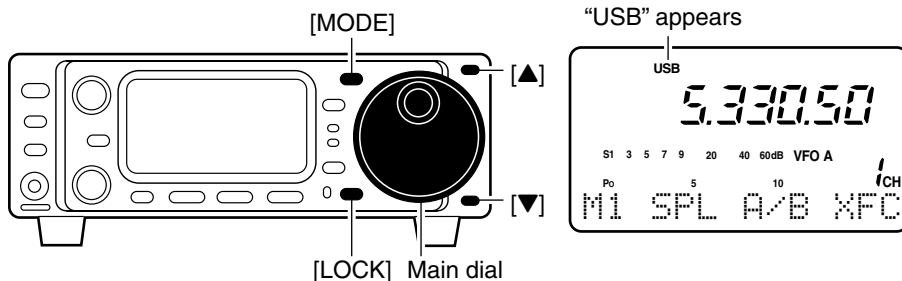

- ① Push [▲(BAND)] / [▼(BAND)] to select 5 MHz band.
- ② Push [MODE] momentarily to select USB mode.
 - When LSB is selected, push for 1 sec. to select USB mode.
- ③ Rotate the main dial to set the frequency exactly as shown in table above.
- ④ Push [LOCK] momentarily to set the dial lock function ON, if desired.

Then operate these frequencies.

Downloaded by

Amateur Radio Directory