

ICOM

INSTRUCTION MANUAL

HF/VHF TRANSCEIVER
IC-706

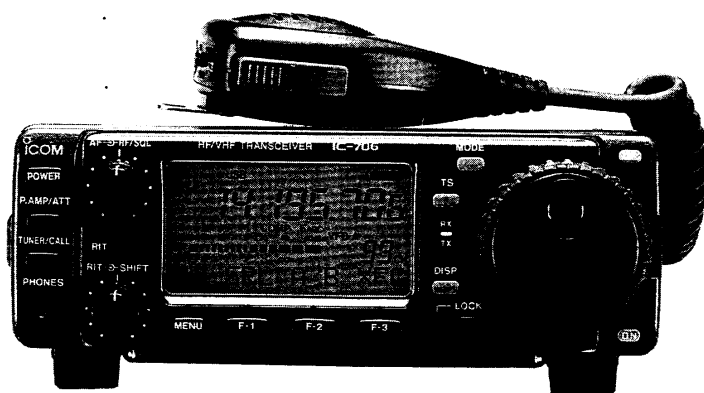

Downloaded by
RadioAmateur.EU

Icom Inc.

IMPORTANT

READ THIS INSTRUCTION MANUAL CAREFULLY before attempting to operate the transceiver.

SAVE THIS INSTRUCTION MANUAL. This instruction manual contains important safety and operating instructions for the IC-706.

PRECAUTIONS

⚠ WARNING HIGH VOLTAGE! NEVER attach an antenna or internal antenna connector during transmission. This may result in an electrical shock or burn.

⚠ NEVER apply AC to the [DC13.8V] socket on the transceiver rear panel. This could cause a fire or ruin the transceiver.

⚠ NEVER apply more than 16 V DC, such as a 24 V battery, to the [DC13.8V] socket on the transceiver rear panel. This could cause a fire or ruin the transceiver.

⚠ NEVER let metal, wire or other objects touch any internal part or connectors on the rear panel of the transceiver. This will cause electric shock.

⚠ NEVER expose the transceiver to rain, snow or any liquids.

NEVER allow children to play with the transceiver.

AVOID using or placing the transceiver in areas with temperatures below -10°C ($+14^{\circ}\text{F}$) or above $+60^{\circ}\text{C}$ ($+140^{\circ}\text{F}$). Be aware that temperatures on a vehicle's dashboard can exceed 80°C , resulting in permanent damage to the transceiver's front panel if left there for extended periods.

AVOID placing the transceiver in excessively dusty

environments or in direct sunlight.

AVOID placing the transceiver against walls or putting anything on top of the transceiver. This will obstruct heat dissipation.

During mobile operation, **DO NOT** operate the transceiver without running the vehicle's engine. When transceiver power is ON and your vehicle's engine is OFF, the vehicle's battery will soon become exhausted.

Make sure the transceiver power is OFF before starting the vehicle. This will avoid possible damage to the transceiver by ignition voltage spikes.

During maritime mobile operation, keep the transceiver and microphone as far away as possible from the magnetic navigation compass to prevent erroneous indications.

BE CAREFUL! The heatsink will become hot when operating the transceiver continuously for long periods.

Use Icom microphones only (supplied or optional). Other manufacturer's microphones have different pin assignments and connection to the IC-706 may damage the transceiver.

Beat signals may be heard on some frequencies. These will occur as a result of circuit construction.

EXPLICIT DEFINITIONS

WORD	DEFINITION
⚠ WARNING	Personal injury, fire hazard or electric shock may occur.
CAUTION	Equipment damage may occur.
NOTE	If disregarded, inconvenience only. No risk of personal injury, fire or electric shock.

The explicit definitions described at left apply to this instruction manual.

Downloaded by
RadioAmateur.EU

TABLE OF CONTENTS

IMPORTANT	i
PRECAUTIONS	i
EXPLICIT DEFINITIONS	i
TABLE OF CONTENTS	ii
UNPACKING	ii

1 PANEL DESCRIPTION 1-8

■ Front panel	1
■ Function switches	3
■ Rear and side panels	5
■ Function display	7
■ Microphone (HM-103)	8

2 INSTALLATION AND CONNECTIONS ... 9-14

■ Unpacking	9
■ Grounding	9
■ Antenna	9
■ Installation	10
■ Required connections	11
■ Advanced connections	12
■ Power supply connections	13
■ External antenna tuners and linear amplifier	14

3 FREQUENCY SETTING 15-18

■ When first applying power (CPU resetting)	15
■ Initial settings	15
■ VFO description	16
■ Frequency setting	17
■ Mode selection	18

4 RECEIVE AND TRANSMIT 19-32

■ Functions for receive	19
■ Functions for transmit	23
■ Split frequency operation	27
■ Functions for CW	29
■ Functions for RTTY	31

5 MEMORY AND SCAN OPERATION 33-38

■ Memory channels	33
■ Memory channel selection	33

■ Memory clearing	33
■ Memory/call programming	34
■ Frequency transferring	35
■ Memory names	35
■ Memo pads	36
■ Scan types	37
■ Preparation	37
■ Programmed scan operation	38
■ Memory scan operation	38
■ Select memory scan operation	38
■ Priority watch	38

6 REMOTE JACK (CI-V) INFORMATION 39

7 SET MODE 40-45

■ General	40
■ Quick set mode items	41
■ Initial set mode items	42

8 MAINTENANCE 46

■ Fuse replacement	46
■ Memory backup	46
■ Cleaning	46

9 TROUBLESHOOTING 47-48

10 OPTIONAL INSTALLATIONS/SETTINGS 49-51

■ Opening the transceiver case	49
■ UT-102 VOICE SYNTHESISER UNIT	49
■ CR-502 HIGH-STABILITY CRYSTAL UNIT	50
■ IF filters	50
■ AT-180 internal switch description	51

11 INTERNAL VIEWS 52

12 OPTIONS 53-54

13 SPECIFICATIONS 55

14 MENU GUIDE 56

UNPACKING

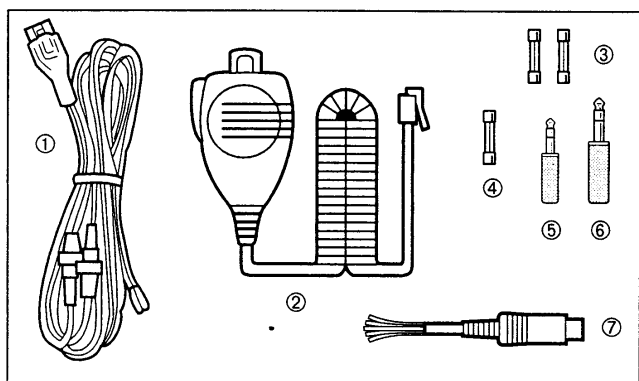

Accessories included with the IC-706:

	Qty.
① DC power cable (OPC-025D).....	1
② Hand microphone (HM-103).....	1
③ Spare fuse (30 A).....	2
④ Spare fuse (4 A).....	1
⑤ RTTY key plug.....	1
⑥ Electronic keyer plug.....	1
⑦ ACC cable.....	1

■ Front panel

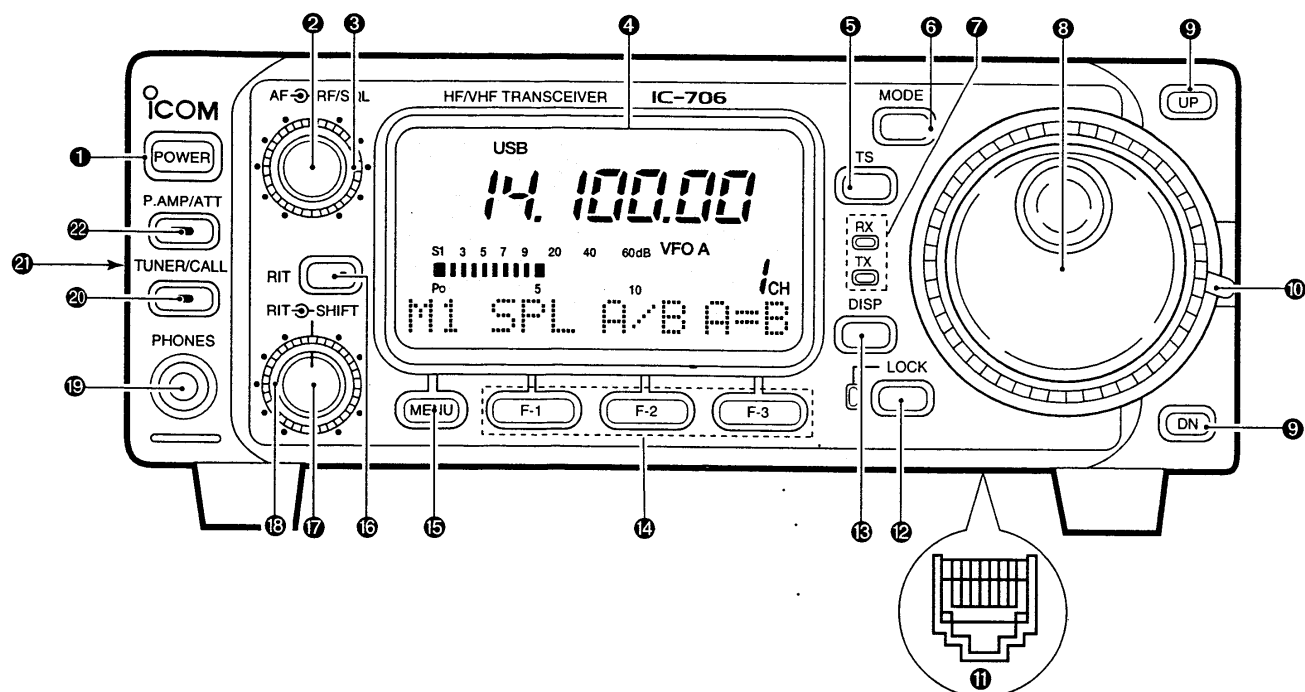

❶ POWER SWITCH [POWER] (p. 15)

Turns power ON and OFF.

- Push momentarily to turn power ON.
- Push for 2 sec. to turn power OFF.

❷ AF GAIN CONTROL [AF] (inner control; p. 15)

Rotate clockwise to increase the audio output from the speaker; rotate counterclockwise to decrease the audio output from the speaker.

❸ RF GAIN CONTROL/SQUELCH CONTROL [RF/SQL] (outer control; p. 21)

- Adjusts the squelch threshold level (to mute noise when receiving no signal) in all modes.
- This control can be used for RF gain control to adjust receiver gain manually.
 - RF gain selection can be set in initial set mode (p. 45).
 - RF gain is usable in SSB/CW/RTTY modes only.

NOTE: This control does not function in WFM mode.

❹ FUNCTION DISPLAY

Shows the operating frequency, dot matrix indications, selected memory channel, etc. See p. 7 for details.

❺ TUNING STEP/BAND SWITCH [TS]

- Push momentarily to cycle through the tuning steps:

10 Hz	↔	operating band	↔	programmable
(or 1 Hz)		(or 1 MHz)		step
- Push and hold for 2 sec. to toggle between the selection:

10 Hz	↔	1 Hz
Band	↔	1 MHz
Programmable step tuning		

❻ MODE SWITCH [MODE] (p. 18)

- Push momentarily to cycle through the operating modes:

USB ↔ CW ↔ AM ↔ FM
 (or LSB) (or CW-R) (or RTTY) (or WFM)

- Push and hold for 2 sec. to toggle between the following operating modes:

USB ↔ LSB
 CW ↔ CW-R
 AM ↔ RTTY
 FM ↔ WFM

❼ RECEIVE/TRANSMIT INDICATORS [RX]/[TX]

[RX] lights green while receiving (and squelch opens); [TX] lights red while transmitting.

❽ MAIN DIAL

Changes the displayed frequency, selects initial set mode items, etc.

❾ UP/DOWN SWITCHES [UP]/[DOWN]

- Push momentarily to select a memory channel.
- Push and hold to scroll through memory channels.
 - Can also be used to advance menu displays, initial set mode items, etc.

❿ MAIN DIAL TENSION LATCH

Selects the main dial tension.
 • 2 positions are available.

⓫ MICROPHONE CONNECTOR (p. 8)

Modular-type microphone connector—connects the supplied microphone (HM-103).
 • The optional OPC-589 can be used to connect an 8-pin microphone such as the SM-8 or SM-20, if desired.
 • A microphone connector is also available on the rear

panel. DO NOT connect 2 microphones simultaneously.

12 LOCK SWITCH [LOCK]

- ➔ Push momentarily to turn the dial lock function ON and OFF.
 - The dial lock function electronically locks the main dial.
- ➔ When the optional UT-102 VOICE SYNTHESIZER UNIT is installed, push for 2 sec. to have the frequency, etc. announced.
 - UT-102 operation can be adjusted in initial set mode (p. 43).

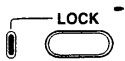

Lights while the lock function is activated.

13 DISPLAY SWITCH [DISP] (p. 56)

- ➔ Push momentarily to select one of the three menu sets: M1 to M4, S1 to S2 and G1 to G4.
- ➔ Push for 2 sec. to select quick set mode.

14 FUNCTION SWITCHES [F1]/[F2]/[F3] (pgs. 3, 4, 56)

- ➔ Push to select the function indicated in the dot matrix display above these switches.
- Functions vary depending on the menu set selected.

15 MENU SWITCH [MENU] (p. 56)

Push this switch one or more times to select menus within a menu set (M, S or G), or push to advance through the quick set mode and initial set mode displays.

16 RIT CONTROL [RIT] (inner control; p. 19)

- ➔ Shifts the receive frequency while the RIT function is ON (see below).
 - Rotate the control clockwise to increase the receive frequency, or rotate the control counterclockwise to decrease the receive frequency.
 - RIT variable range is ± 1.0 kHz.

17 SHIFT CONTROL [SHIFT] (outer control; p. 19)

- ➔ Shifts the center frequency of the receiver's IF passband.
 - Rotate the control clockwise to shift the center frequency higher, or rotate the control counterclockwise to shift the center frequency lower.
 - When the graphic menu display (G2) is selected, the IF passband is graphically displayed and changes in accordance with the [SHIFT] control (see p. 19).

18 RIT SWITCH [RIT] (p. 19)

- ➔ Push to turn the RIT function ON and OFF.
 - Use the [RIT] control to vary the RIT frequency (see above).
- ➔ Push and hold to add or subtract shifted frequency to the operating frequency when the RIT function is turned ON.



Lights while the RIT function is activated.

19 HEADPHONE JACK [PHONES] (p. 12)

- ➔ Accepts headphones with 4–16 Ω impedance.
 - When headphones are connected, no receive audio comes from the speaker.
 - When the PHONES/SPEAKER switch on the back of the front panel is set to the [SPEAKER] position, an external speaker can be connected. This is convenient for mobile or outdoor operation.

20 TUNER/CALL SWITCH [TUNER/CALL]

- (pgs. 25, 26)
 - ➔ During HF/50 MHz operation, push this switch momentarily to toggle the automatic antenna tuner function ON/OFF.
 - An optional antenna tuner must be connected.
 - ➔ During HF/50 MHz operation, push this switch for 2 sec. to manually tune the antenna.
 - An optional antenna tuner must be connected.
 - ➔ During 144 MHz operation, push this switch momentarily to select the call channel (or the previous channel/frequency when the call channel is already selected). (p. 33)



Lights while the automatic tuning function is activated.

21 FRONT PANEL LATCH (p. 10)

Push in to detach the front panel from the main body of the transceiver.

22 PREAMP/ATTENUATOR SWITCH [P.AMP/ATT]

- (p. 20)
 - ➔ Push momentarily to turn the preamp ON.
 - ➔ Push and hold to turn the 20 dB attenuator ON.
 - Lights green when the preamp is ON; lights red when the 20 dB attenuator is ON.



Lights green while the preamp is activated; lights red while the attenuator is activated.

Function switches

◇ M1 FUNCTIONS

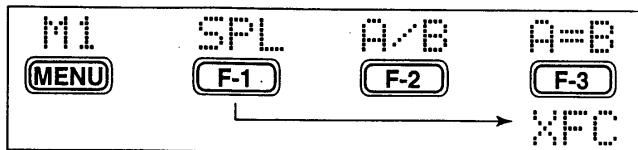

SPLIT OPERATION (p. 27)

SPL
F-1

- Toggles the split function ON and OFF.
- “SPLIT” appears when the split function is ON.
- The function of [F-3] changes to XFC when the split function is ON.

VFO A/B SELECTION (p. 16)

A/B
F-2

- Toggles between VFO A and VFO B in VFO mode.
- Toggles between transmission VFO and reception VFO during split operation.
- Toggles between the transmit and receive frequencies (and modes) of memory channels when the split function is turned ON.

VFO EQUALIZATION (p. 16)

A=B
F-3

- Equalizes the frequency and operating mode of the two VFO's.
- The rear (undisplayed) frequency and operating mode are equalized to the front (displayed) VFO frequency and operating mode.

TRANSMIT FREQUENCY CHECK (p. 27)

XFC
F-3

- Appears when the split function is turned ON—monitors the transmit frequency when pushed and held.
- While pushed, the transmit frequency can be changed with the main dial.

◇ M2 FUNCTIONS

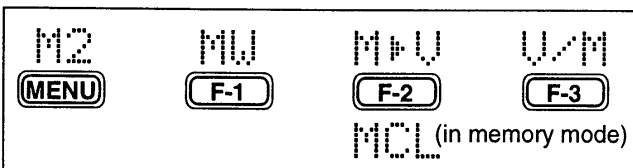

MEMORY WRITE (p. 34)

MW
F-1

- Stores the displayed frequency and operating mode into the displayed memory channel.

MEMORY TRANSFER (p. 35)

MFU
F-2

- Transfers the frequency and operating mode in the selected memory channel to a VFO.

VFO/MEMORY (p. 33)

V/M
F-3

- Toggles between VFO and memory modes.

MEMORY CLEAR (p. 33)

MCL
F-2

- Clears the selected memory channel's contents.
- “BLANK” appears.

◇ M3 FUNCTIONS

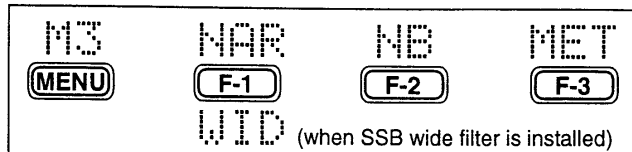

NARROW FILTER (p. 22)

NAR
F-1

- Toggles the narrow filter (or wide filter) ON and OFF.

or

WID
F-1

- “NAR” appears when the narrow filter is ON; “W” appears when the wide filter is ON.
- An optional narrow filter and presetting in initial set mode (p. 45) is necessary to use the following:

CW/RTTY narrow: FL-100 or FL-101
SSB narrow: FL-223
SSB wide: FL-103

NOISE BLANKER (p. 20)

NB
F-2

- Turns the noise blanker ON and OFF.
- The noise blanker does not function in AM and FM/WFM modes.

METER SELECTION (p. 23)

MET
F-3

- Selects the type of meter displayed (during transmit) in the function display.
- Power, ALC or SWR metering can be selected.
- Only an S-meter is available for receive.

◇ M4 FUNCTIONS

DURING SSB/AM OPERATION:

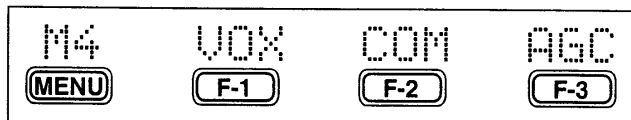

DURING CW OPERATION:

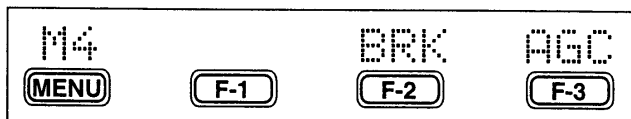

DURING RTTY OPERATION:

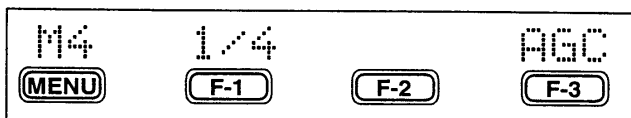

DURING FM OPERATION:

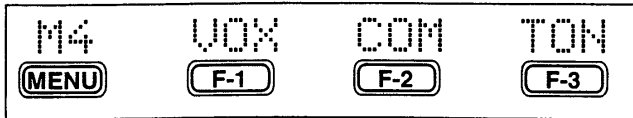

VOX FUNCTION (p. 24)

VOX (F-1) Toggles the VOX function ON and OFF.
 •The [VOX GAIN] and [ANTI VOX] are available on the side panel.
 •VOX delay can be set in quick set mode (p. 41).

SPEECH COMPRESSOR (p. 24)

COM (F-2) Toggles the speech compressor ON and OFF.
 •The [COMP GAIN] control is available on the side panel.

AGC (p. 20)

AGC (F-3) Changes the time constant of the AGC circuit.

BREAK-IN (p. 29)

BRK (F-2) Selects semi break-in, full break-in (QSK) and break-in OFF.
 •“BK” or “F-BK” appears when selecting semi break-in or full break-in, respectively.
 •An external switch, such as a foot switch, is necessary to connect to the ACC socket to use no break-in operation.

1/4 FUNCTION (p. 32)

1/4 (F-1) Toggles the 1/4 function ON and OFF.
 •When the 1/4 function is ON, a bar appears under the 1/4 indication and fine tuning can be used.

TONE OPERATION (p. 28)

TON (F-3) ➔ Toggles the subaudible tone encoder ON and OFF.
 ➔ Transmits a 1750 Hz tone burst when pushed and held during transmission.
 •Tone frequencies or tone burst can be set in quick set mode (p. 42).

◇ S1 FUNCTIONS

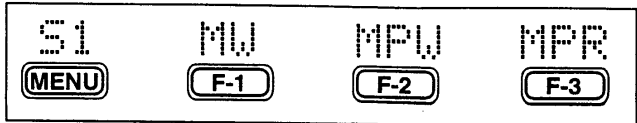

MW (F-1) **MEMORY WRITE (p. 34)**
 Stores the displayed frequency and operating mode into the displayed memory channel.

MPW (F-2) **MEMO PAD WRITE (p. 36)**
 Stores the displayed frequency and operating mode into a memo pad.

MPR (F-3) **MEMO PAD READ (p. 36)**
 Calls up a memo pad.

◇ S2 FUNCTIONS

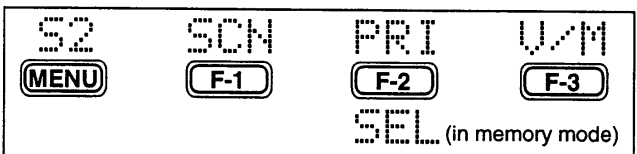

SCN (F-1) **SCAN (p. 38)**
 Starts and stops the scan function.

PRI (F-2) **PRIORITY WATCH (p. 38)**
 Starts and stops priority watch.

SEL (F-2) **SELECT SCAN (p. 38)**
 Toggles the select setting ON and OFF for the selected memory channel.

V/M (F-3) **VFO/MEMORY (p. 38)**
 Toggles between VFO and memory modes.

Rear and side panels

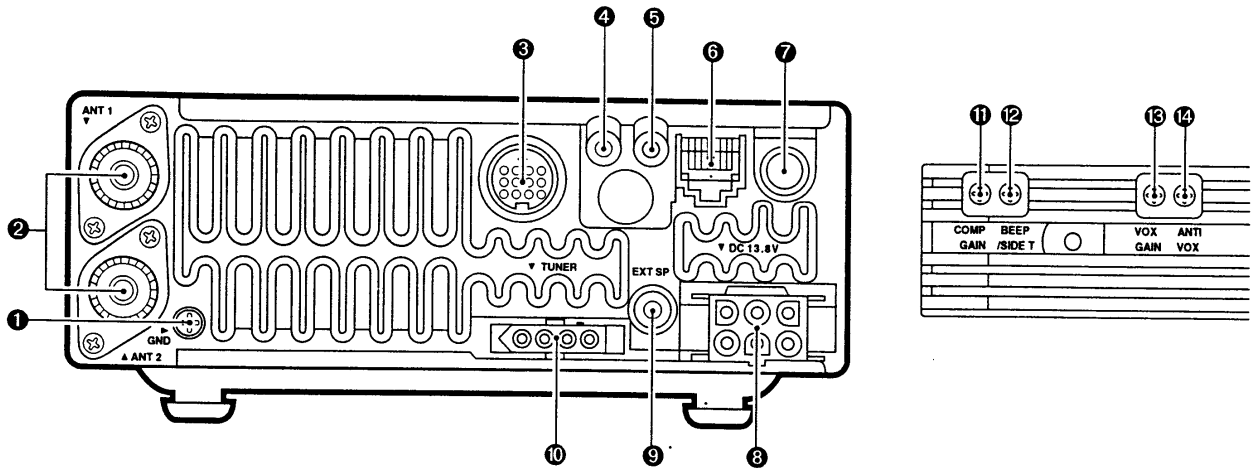

1 GROUND TERMINAL [GND] (p. 9)

Connect this terminal to a ground to prevent electrical shocks, TVI, BCI and other problems.

2 ANTENNA CONNECTORS [ANT 1], [ANT 2] (p. 11)

Accept a 50 Ω antenna with an PL-259 type plug.

- [ANT 1] is for connection to an HF/50 MHz antenna.
- [ANT 2] is for connection to 144 MHz antenna.
- These connectors are switched above or below 60 MHz.

3 ACCESSORY SOCKET [ACC] (p. 6)

Enables connection to external equipment such as a TNC for data communications, a linear amplifier or an automatic antenna selector/tuner, etc.

- See page at right for socket information.

4 RTTY JACK [RTTY] (p. 31)

Connects an external terminal unit for RTTY (FSK) operation.

- The keying polarity and mark/shift frequencies can be selected in quick set mode (p. 41).

5 CI-V REMOTE CONTROL JACK [REMOTE] (p. 39)

Designed for use with a personal computer for remote operation of transceiver functions.

6 MICROPHONE CONNECTOR [MIC] (p. 11)

Accepts the supplied microphone (connected in parallel with the front panel's [MIC] connector).

- See pgs. 1 and 2 for microphone notes.
- See p. 8 for microphone connector information.

7 ELECTRONIC KEYS JACK [ELEC-KEY] (p. 29)

Accepts a paddle to activate the internal electronic keyer.

- Selection between the internal electronic keyer and straight key operation can be made in quick set mode. (p. 42)

When connecting a straight key

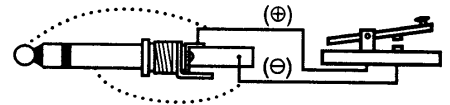

When connecting a paddle

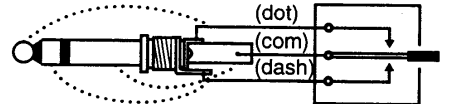

8 DC POWER SOCKET [DC13.8V] (p. 13)

Accepts 13.8 V DC through the supplied DC power cable.

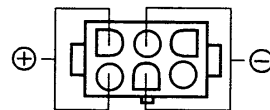

Rear panel view

9 EXTERNAL SPEAKER JACK [EXT SP] (p. 12)

Accepts a 4–16 Ω speaker.

10 TUNER CONTROL SOCKET [TUNER] (p. 12)

Accepts the control cable from an optional AH-3 HF AUTOMATIC ANTENNA TUNER.

11 SPEECH COMPRESSION LEVEL CONTROL [COMP GAIN] (p. 24)

Adjusts the compression level.

- This control is available only when the speech compressor is ON.

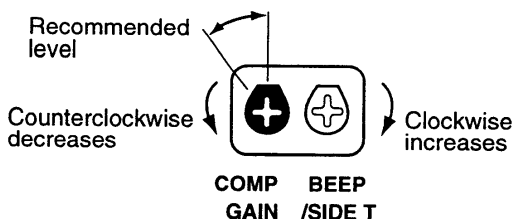

⑫ **BEEP/SIDETONE CONTROL [BEEP/SIDETONE]**
 Adjusts the beep tone and CW side tone audio levels.

⑬ **ANTI VOX CONTROL [ANTI VOX]** (p. 24)
 Adjusts anti VOX level to prevent the receive audio from activating the VOX.

⑭ **VOX GAIN CONTROL [VOX GAIN]** (p. 24)
 Adjusts the VOX sensitivity.

TECHNICAL INFORMATION

• **ACC SOCKET**

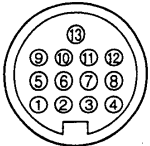
ACC	PIN NO.	NAME	DESCRIPTION	SPECIFICATIONS	COLOR
 <p>Rear panel view</p>	1	8 V	Regulated 8 V output.	Output voltage : 8 V ±0.3 V Output current : Less than 10 mA	brown
	2	GND	Connects to ground.	—	red
	3	SEND	Input/output pin. Goes to ground when transmitting. When grounded, transmits.	Ground level : -0.5 to 0.8 V Input current : Less than 20 mA	orange
	4	BDT	Data line for the optional AT-180.	—	yellow
	5	BAND	Band voltage output. (Varies with amateur band)	Output voltage : 0 to 8.0 V	green
	6	ALC	ALC voltage input.	Control voltage : -4 to 0 V Input impedance : More than 10 kΩ	blue
	7	NC	No connection.	—	purple
	8	13.8 V	13.8 V output when power is ON.	Output current : Max. 1 A	gray
	9	TKEY	Key line for the AT-180.	—	white
	10	FSKK	RTTY keying input. Connected in parallel to the [RTTY] jack.	Ground level : -0.5 to 0.8 V Input current : Less than 10 mA	black
	11	MOD	Modulator input.	Input impedance : 10 kΩ Input level : Approx. 100 mV rms	pink
	12	AF	AF detector output. Fixed, regardless of [AF] position.	Output impedance : 4.7 kΩ Output level : 100 to 350 mV rms	light blue
	13	SQLS	Squelch output. Goes to ground when squelch opens.	SQL open : Less than 0.3 V/5 mA SQL closed : More than 6.0 V/100 μA	light green

Color refers to the cable strands of the supplied ACC cable.

• **When connecting the ACC conversion cable (OPC-599)**

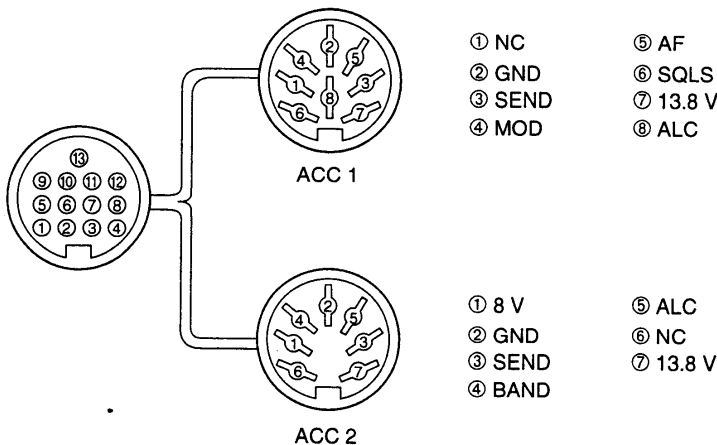

■ Function display

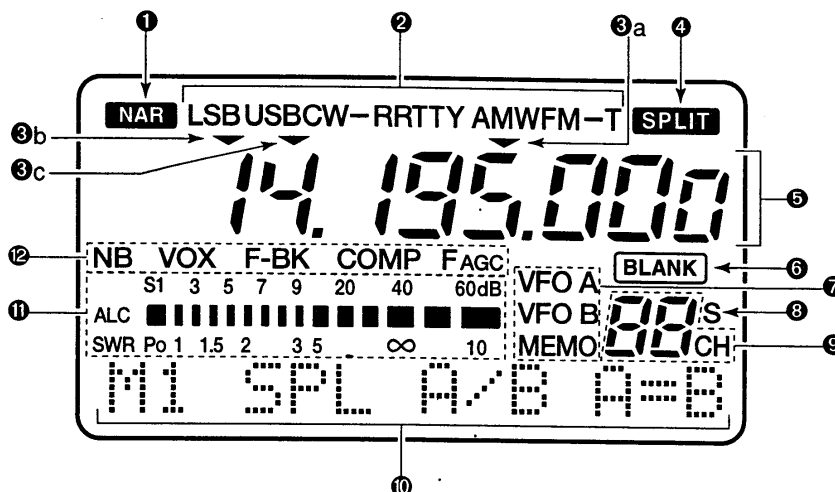

① NARROW FILTER INDICATOR

- Appears when selecting AM narrow or FM narrow modes.
- When installing an optional narrow filter, narrow mode can be selected in CW, RTTY and SSB modes.
 - When the SSB wide filter is installed, “W” (the W of WFM) appears during wide mode selection.

② MODE INDICATORS

Show the operating mode.

③ TUNING STEP/BAND SELECTION INDICATORS

- ③a appears when tuning with the preset tuning step.
- ③c appears when tuning with the 1 MHz step.
- Both ③b and ③c appear when changing bands.

④ SPLIT INDICATOR

Shows that the split frequency function is activated.

⑤ FREQUENCY READOUT

Shows the operating frequency.

⑥ BLANK INDICATOR

Shows that the displayed memory channel is not programmed.

- This indicator appears both in VFO and memory modes.

⑦ VFO/MEMORY INDICATORS

VFO A or B appears when VFO mode is selected; MEMO appears when memory mode is selected.

⑧ SELECT INDICATOR

Shows that the displayed memory channel is designated as a select memory channel.

⑨ MEMORY CHANNEL NUMBER READOUT

Shows the selected memory channel number.

⑩ DOT MATRIX INDICATORS

These alphanumeric readouts show a variety of information such as current functions of the “F” keys

[F1] to [F3], memory channel names, set mode items, etc. See p. 56 for an overview of these indicators.

⑪ METER READOUTS

- Functions as an S-meter while receiving.
- Functions as a power, ALC or SWR meter while transmitting.

▨ **NOTE:** The S-meter does not function in WFM mode and the SWR meter does not function in the 144 MHz band.

⑫ FUNCTION INDICATORS

- “NB” appears when the noise blanker is activated.
- “VOX” appears when the VOX function is selected.
- “F-BK” appears when full break-in operation is selected and only “BK” appears when semi break-in operation is selected.
- “COMP” appears when the speech compressor is activated.
- “FAGC” appears when the fast AGC function is selected.

■ Microphone (HM-103)

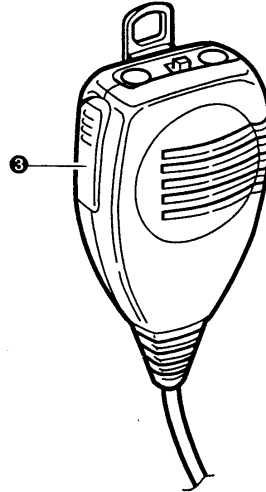
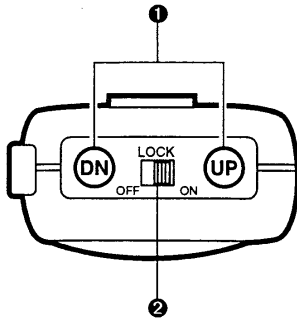

❶ UP/DOWN SWITCHES [UP]/[DN]

Change the operating frequency.

- Continuous pushing changes the frequency continuously.
- Tuning step is 50 Hz when no TS indicator appears.

❷ LOCK SWITCH [LOCK]

Locks the [UP]/[DN] switches.

❸ PTT SWITCH [PTT]

Push and hold to transmit; release to receive.

TECHNICAL INFORMATION

• MICROPHONE CONNECTOR

- ❶ +8 V DC output
- ❷ Frequency up/down
- ❸ AF output
- ❹ PTT
- ❺ GND (microphone ground)
- ❻ Microphone input
- ❼ GND
- ❽ Squelch switch

PIN NO.	FUNCTION	DESCRIPTION
1	+8 V DC output	Max. 10 mA
2	Frequency up	Ground
	Frequency down	Ground though 470 Ω
8	Squelch open	"LOW" level
	Squelch closed	"HIGH" level

Rear panel view

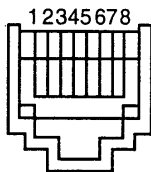

CAUTION: DO NOT short pin 1 to ground as this can damage the internal 8 V regulator.

Downloaded by RadioAmateur.EU

• HM-103 SCHEMATIC DIAGRAM

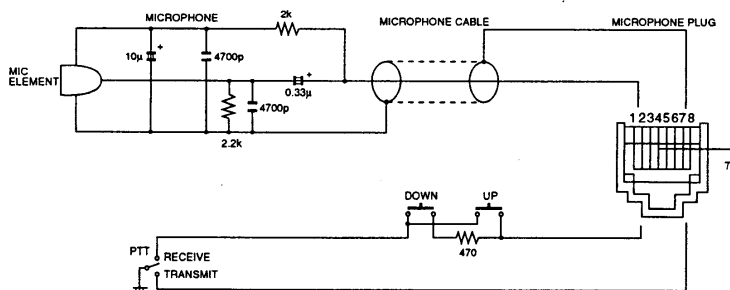

■ Unpacking

After unpacking, immediately report any damage to the delivering carrier or dealer. Keep the shipping cartons.

For a description and a diagram of accessory equipment included with the IC-706, see UNPACKING on p. ii of this manual.

■ Grounding

To prevent electrical shock, television interference (TVI), broadcast interference (BCI) and other problems, ground the transceiver through the GROUND terminal on the rear panel.

For best results, connect a heavy gauge wire or strap to a long earth-sunk copper rod. Make the distance between the GROUND terminal and ground as short as possible.

⚠ WARNING: NEVER connect the [GND] terminal to a gas or electric pipe, since the connection could cause an explosion or electric shock.

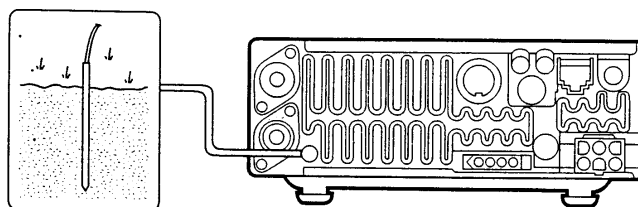

■ Antenna

Select antenna(s), such as a well-matched 50 Ω antenna, and feedline. The transmission line should be a coaxial cable. 1.5:1 or better of Voltage Standing Wave Ratio (VSWR) is recommended for your required band. Of course, the transmission line should be a coaxial cable.

CAUTION: Protect your transceiver from lightning using a lightning arrestor.

ANTENNA SWR

Each antenna is tuned for a specified frequency range and SWR may be increased out-of-range. When the SWR is higher than approx. 2.0:1, the transceiver's power drops to protect the final FETs. In this case, an optional antenna tuner is useful to match the transceiver and antenna. Low SWR allows full power for transmitting even when using the antenna tuner. The IC-706 has an SWR meter to monitor the antenna SWR continuously.

PL-259 CONNECTOR INSTALLATION EXAMPLE

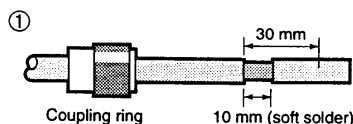

Slide the coupling ring down. Strip the cable jacket and soft solder.

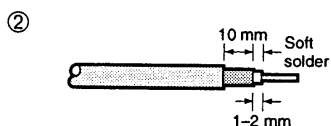

Strip the cable as shown at left. Soft solder the center conductor.

(10 mm \approx 3/8 in)

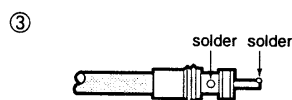

Slide the connector body on and solder it.

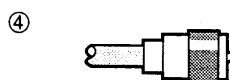

Screw the coupling ring onto the connector body.

■ Installation

◇ Single body mounting

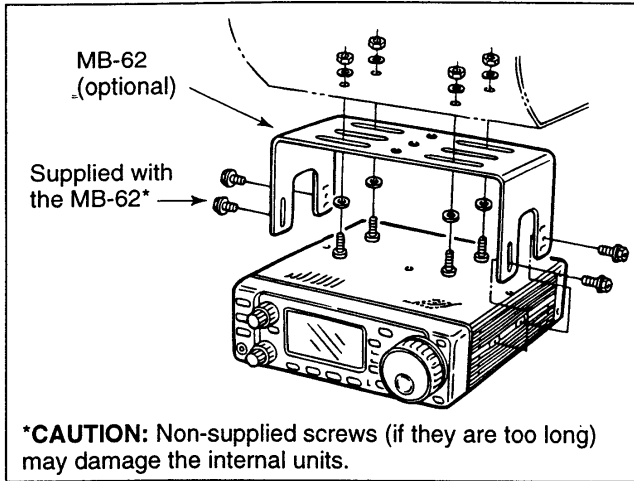

◇ Stand

To raise the stand:
With the transceiver upside down, pull the stand towards the rear panel and then upwards, as illustrated below.

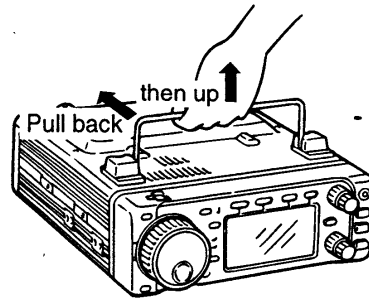

◇ Front panel separation

- ① While pulling the panel release button towards you, slide the front panel to the right (fig. 1).
- ② Attach the optional OPC-581 to the main body and tighten the supplied screw as in fig. 2.
- ③ Attach the other end of the OPC-581 to the detached front panel as in fig. 3.

fig. 1

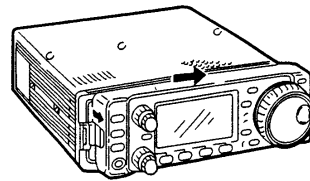
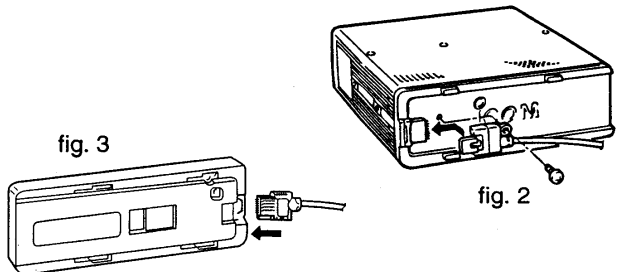

fig. 3



◇ Front panel mounting

- ① Attach the MB-63 to a flat surface using the two supplied screws (fig. 1).
- ② Fix the detached front panel to the MB-63 as illustrated in fig. 2.

Be careful of the orientation of the MB-63, otherwise, the front panel may become attached in the opposite direction.

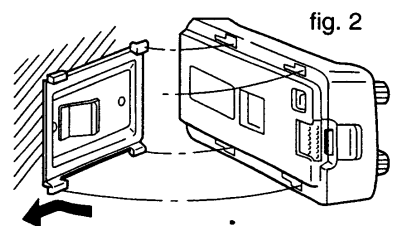
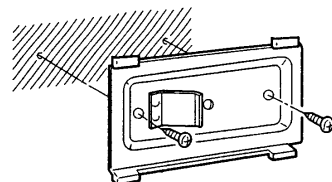

Required connections

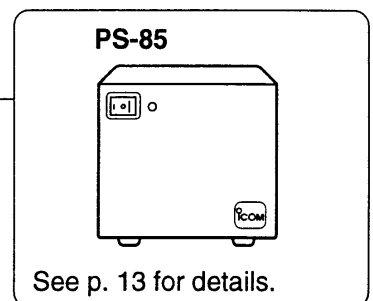
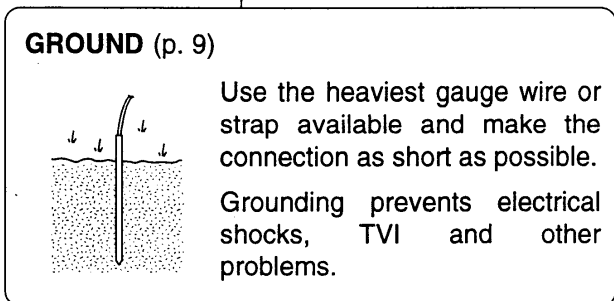
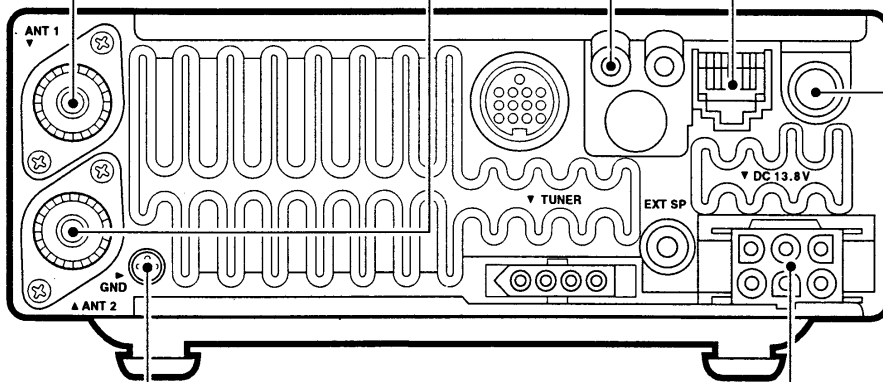
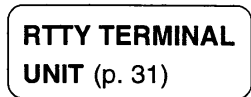
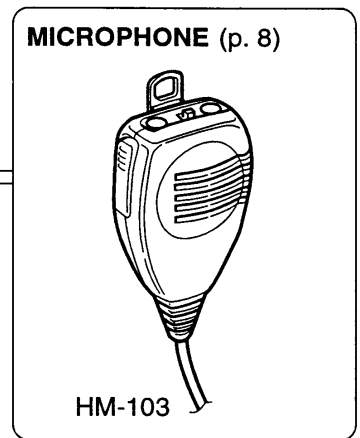
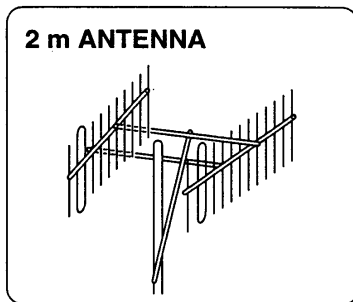
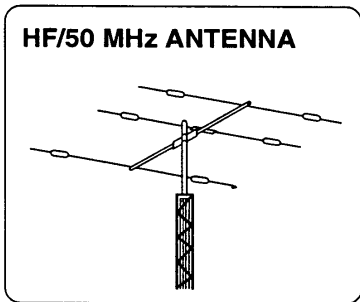
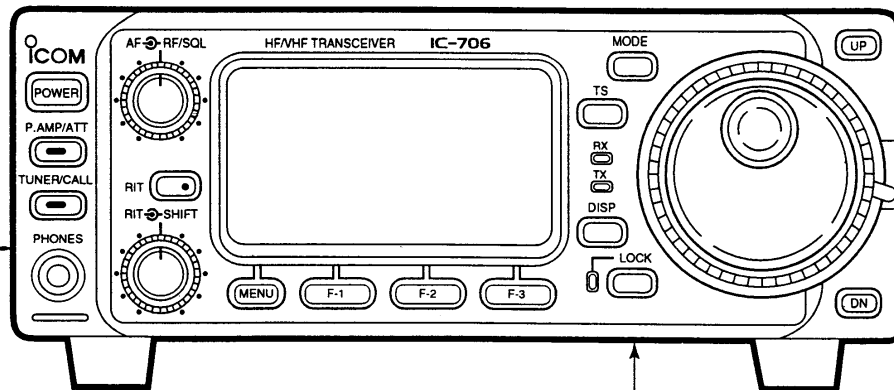

Advanced connections

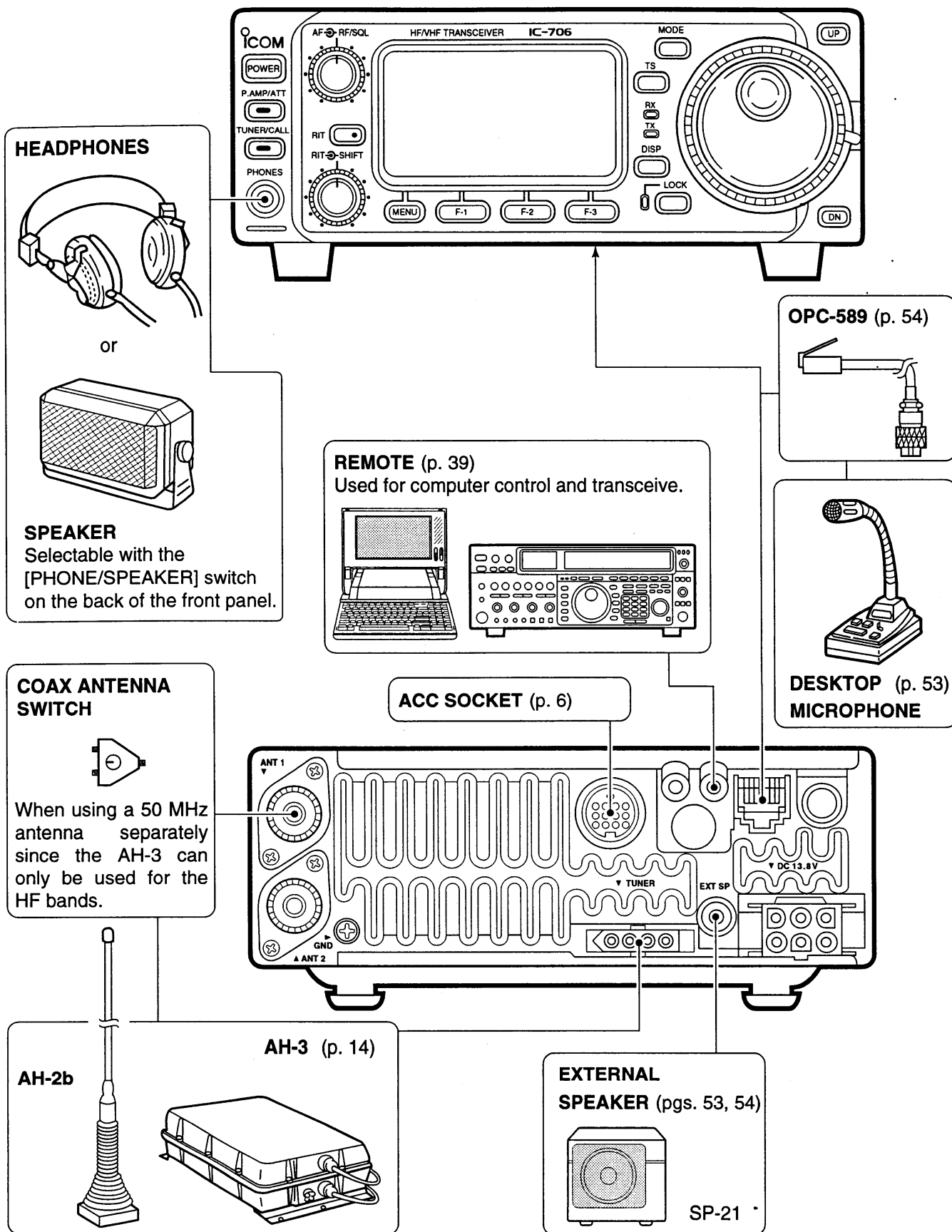

Power supply connections

Use the optional PS-85 DC POWER SUPPLY when operating the IC-706 with AC power. Refer to the diagram below for connection.

CAUTION: Before connecting the DC power cable, check the following important items. Make sure:

- The [POWER] switch is OFF.
- Output voltage of the power source is 12–15 V when you use a non-Icom power supply.
- DC power cable polarity is correct.
Red : positive (+) terminal
Black : negative (–) terminal

CONNECTING THE PS-85 DC POWER SUPPLY

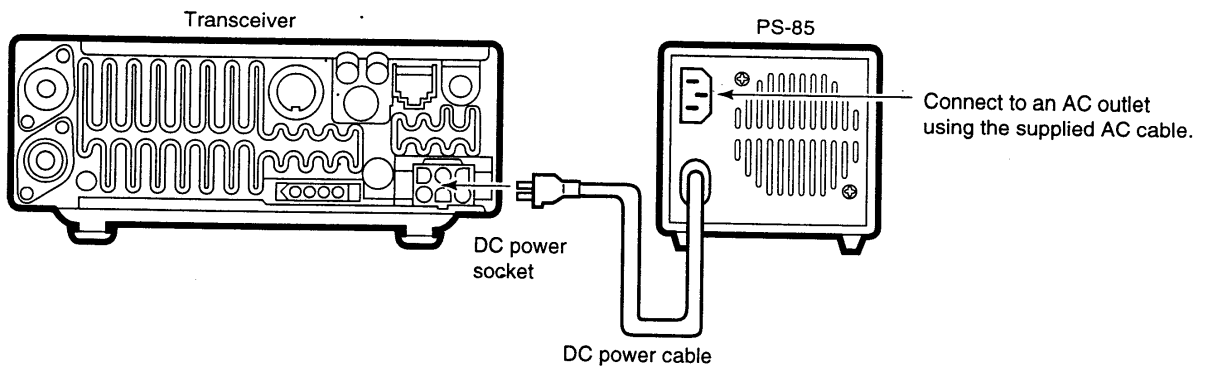

CONNECTING A NON-ICOM DC POWER SUPPLY

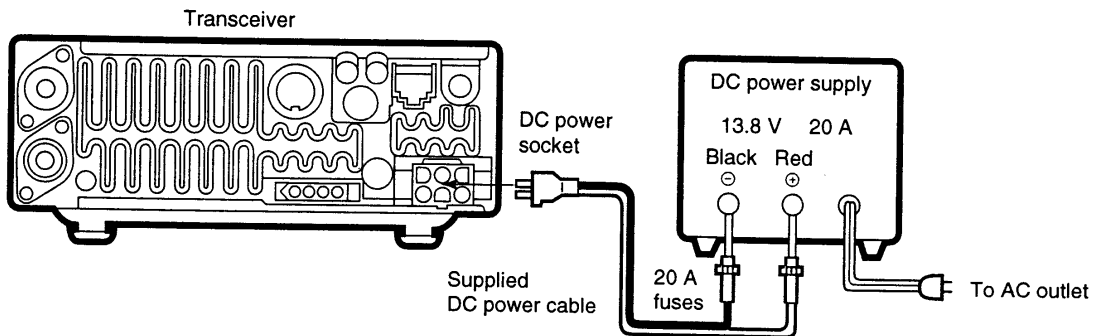

CONNECTING A VEHICLE BATTERY

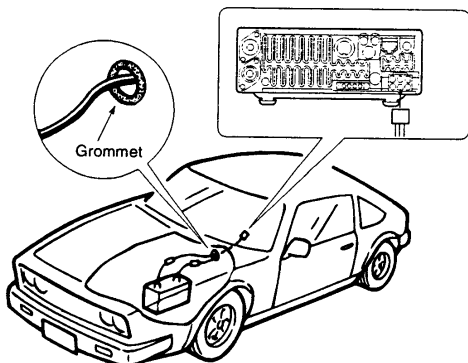

NEVER connect to a 24 V battery.

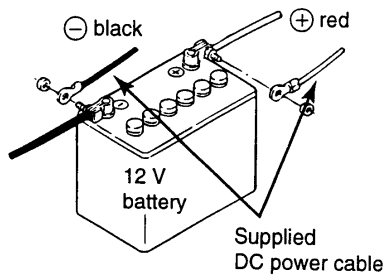

NOTE: Use terminals for the cable connections.

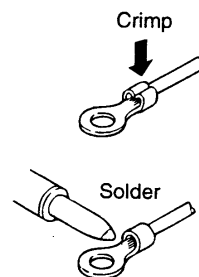

External antenna tuners and linear amplifier

CONNECTING THE AH-3

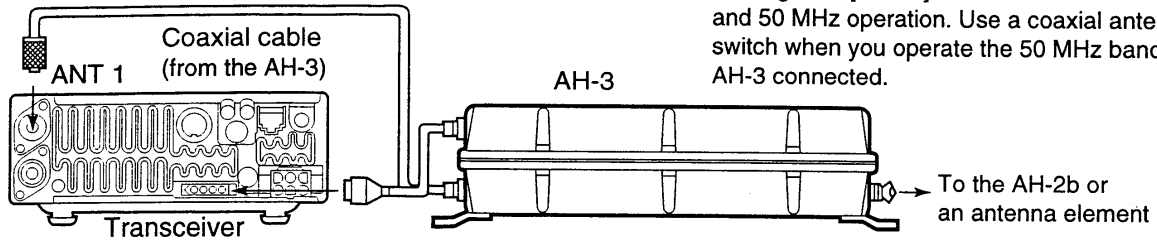

The AH-3 can be used for the HF bands only, although the [ANT 1] connector is used for both HF and 50 MHz operation. Use a coaxial antenna switch when you operate the 50 MHz band with the AH-3 connected.

CONNECTING THE AT-180

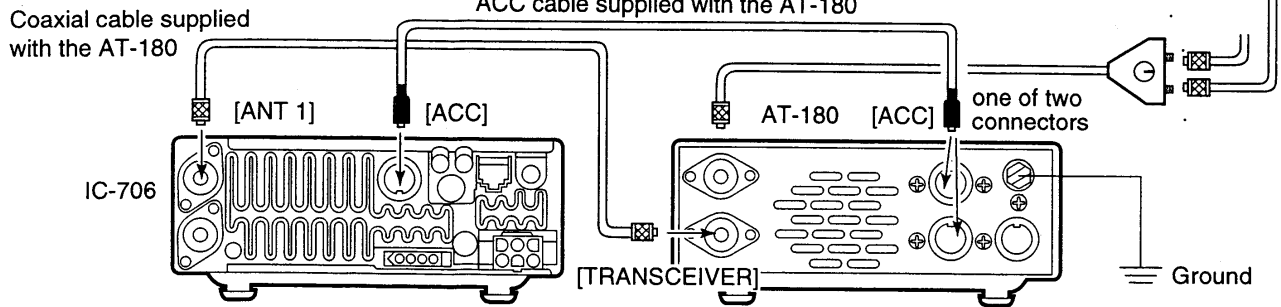

The AT-180 can be used for operation on all HF bands as well as the 50 MHz band. However, no one antenna may be able to operate over such a range. When using a coaxial antenna switch, connect it to the AT-180 [ANT] connector.

CONNECTING THE IC-4KL

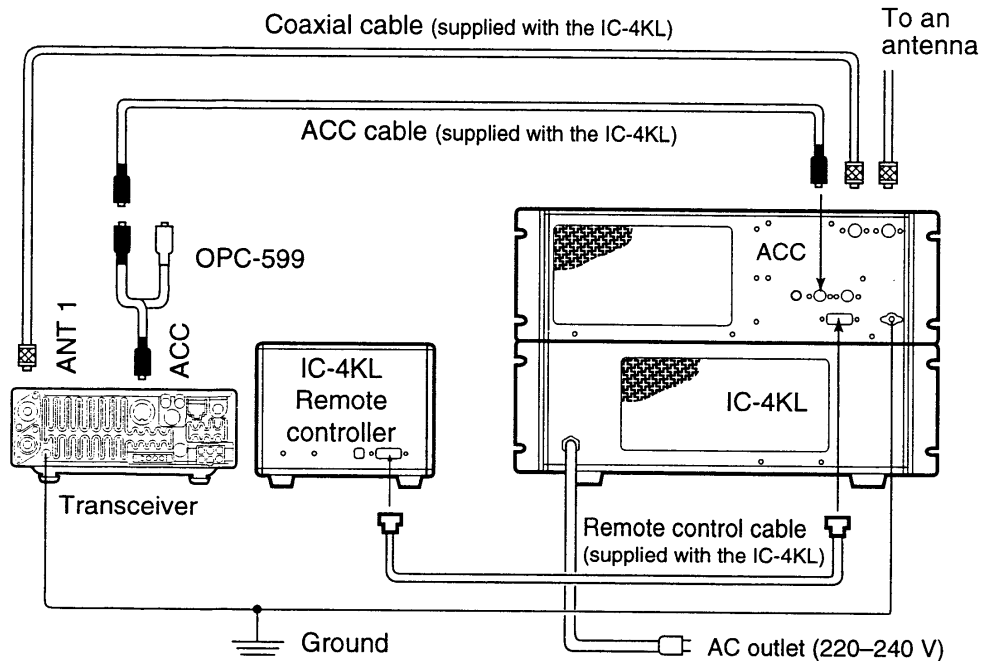

3

FREQUENCY SETTING

■ When first applying power (CPU resetting)

Before first applying power, make sure all connections required for your system are complete by referring to section 2. Then, reset the transceiver using the following procedure.

NOTE: Resetting **CLEAR**s all programmed contents in memory channels and returns all initial set mode and quick set mode contents to their default values.

- ① Make sure the transceiver power is OFF.
- ② While pushing [UP] and [DN], push [POWER] to turn power ON.
 - The internal CPU is reset.
 - The transceiver displays as shown at right when resetting is complete.

[POWER]

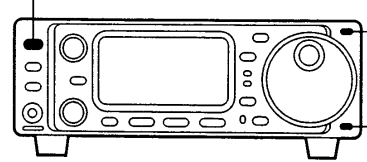

[UP]

[DN]

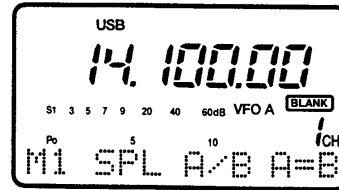

The transceiver displays its initial frequency and mode.

◇ M1 display selection

If you can't figure out how to return to the M1 display: While pushing [MENU], turn power ON.

■ Initial settings

After resetting the transceiver, set controls and switches as shown in the figure below.

CW : Clockwise
CCW : Counterclockwise

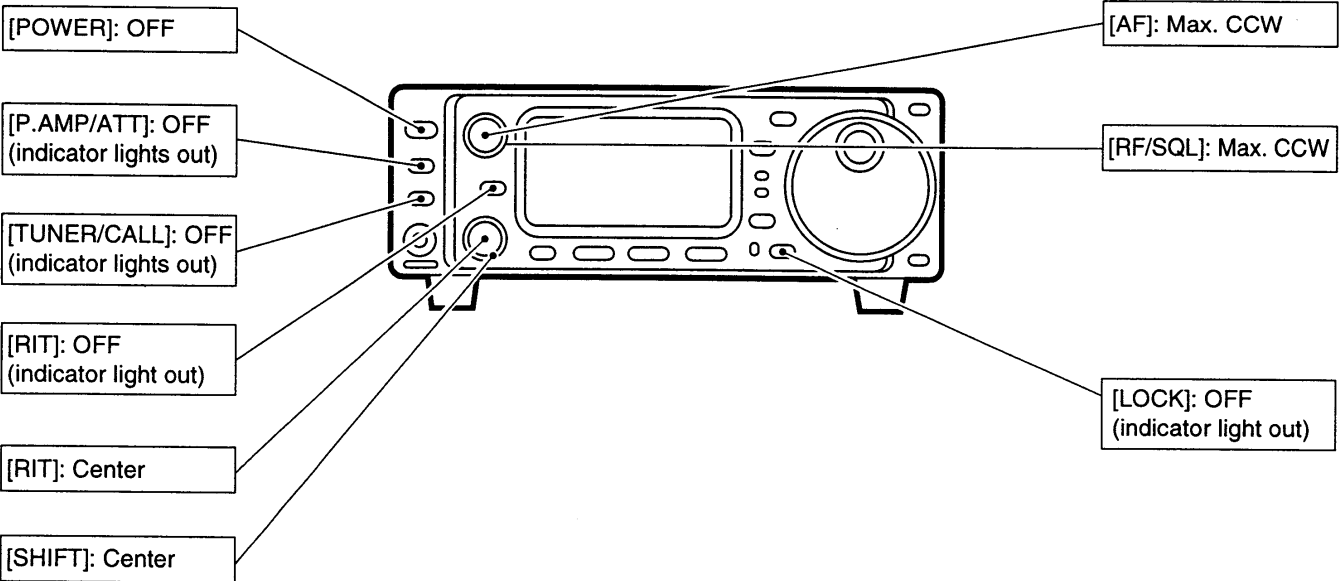

Turn power ON, then check the display. If any of the following indicators appear, turn them OFF as follows:

- Tuning step/band selection indicators, ▼, (any of three) : Push [TS] 1 or more times.
- 1 Hz frequency readout : Push and hold [TS].
- Memory mode indicator, MEMO : Use [(F-3)U/M] in the M2 display (p. 56).
- Split indicator, SPLIT : Use [(F-1)SPL] in the M1 display (p. 56).

VFO description

VFO is an abbreviation of Variable Frequency Oscillator, and traditionally refers to an oscillator. The IC-706's VFO can store a frequency and an operating mode.

You can call up a desired frequency to a VFO with the memo pad-read switch (p. 36) or with the memory transfer switch (p. 35). You can also change the frequency with the main dial and select an operating mode with the [MODE] switch.

The IC-706 has two VFOs, specially suited for split frequency operation. The VFOs are called VFO A and VFO B. You can use the desired VFO to call up a frequency and operating mode for operation.

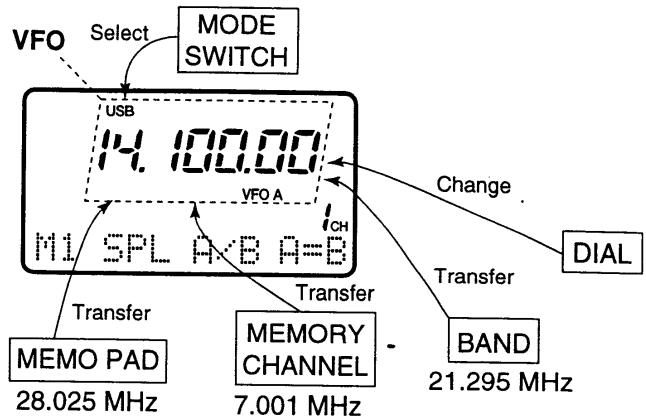

The differences between VFO and memory mode

VFO MODE

Each VFO shows a frequency and operating mode. If the frequency or operating mode is changed, the VFO automatically memorises the new frequency or operating mode.

When the VFO is selected from another VFO or memory mode, the last-used frequency and operating mode for that VFO appear.

[EXAMPLE]

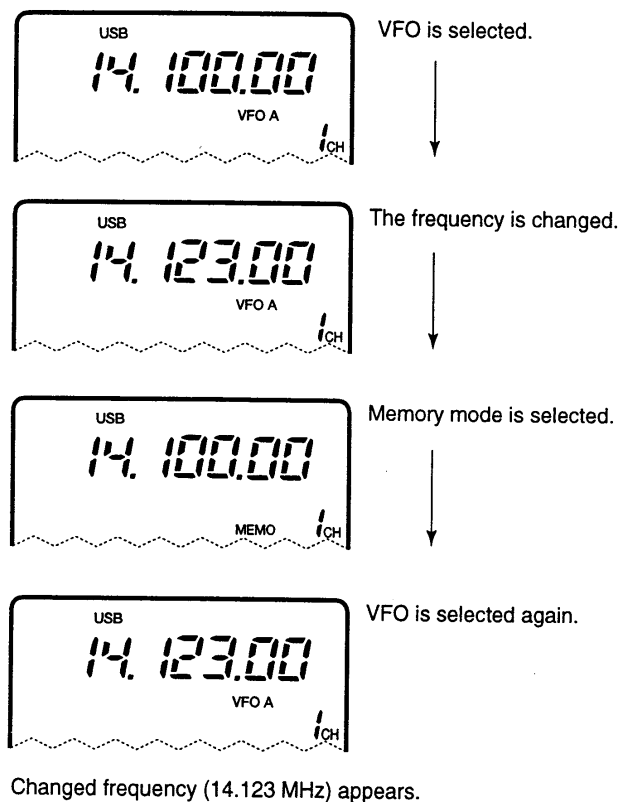

MEMORY MODE (pgs. 33–36)

Each memory channel shows a frequency and operating mode like a VFO. Even if the frequency or mode is changed, the memory channel does not memorise the new frequency or memory mode.

When a memory channel is selected from another memory channel or VFO mode, the memorised frequency and operating mode appear.

[EXAMPLE]

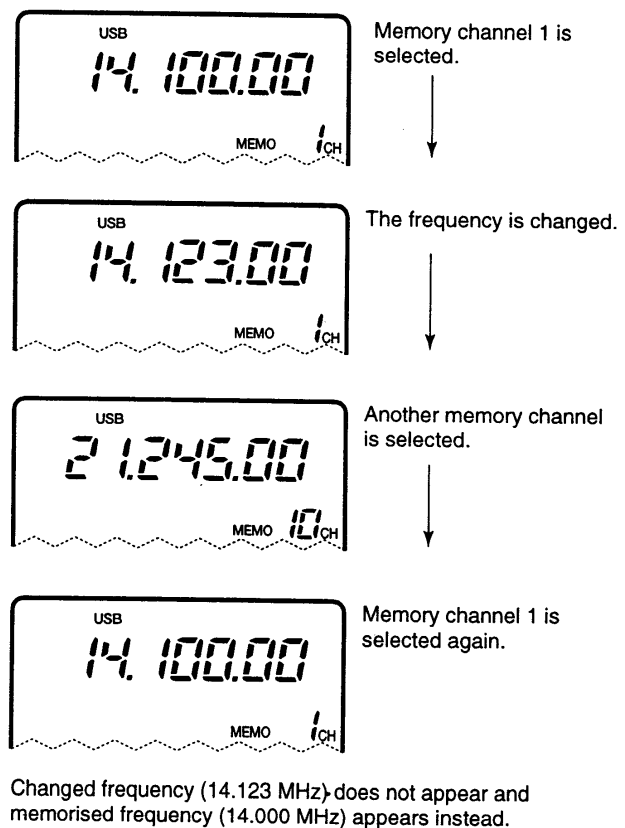

Frequency setting

Band selection

All HF ham bands, the 50 MHz band, the 144 MHz band and a general coverage receiver band are included in the IC-706.

- ① Push [TS] one or more times until two “▼” appear above the MHz and 10 MHz digits.
 - If the quick tuning step indicator (one “▼” above the MHz digit) appears, push and hold [TS] for 2 sec. to select the band indicators. See the [TS] flow chart on p. 18 for details.
- ② Rotate the main dial to select the desired band.

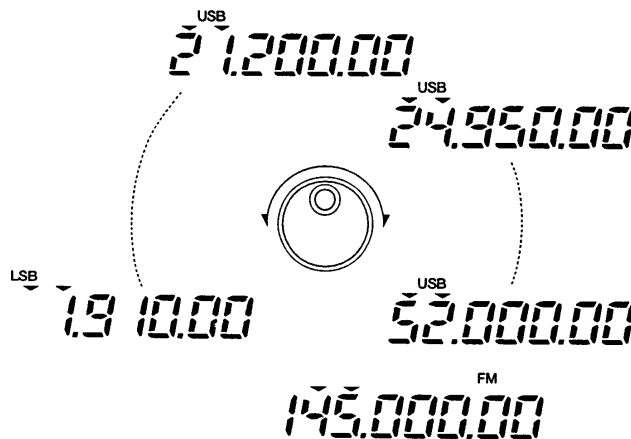

Tuning steps and tuning step selection

Programmable tuning steps are available for quick frequency setting in addition to the normal 1 or 10 Hz steps.

These tuning steps are:

- Independently selectable for each mode
- Selectable from 0.1, 1, 5, 9, 10, 12.5, 15, 20 and 100 kHz

- ① Push [TS] one or more times until the tuning step indicator, “▼,” appears above the 1 kHz digit.
 - Rotating the main dial changes the frequency according to the set tuning step.
- ② Push [TS] for 2 sec. while “▼” appears to enter the tuning step selection mode.
 - Rotate DIAL appears.
- ③ Rotate the main dial to set the desired tuning step.
 - Change the mode and select tuning steps for other modes, if desired.
- ④ Push [TS] to exit the tuning step selection mode.
 - The display returns to normal indication.
- ⑤ Rotate the main dial to change the frequency according to the set tuning step.

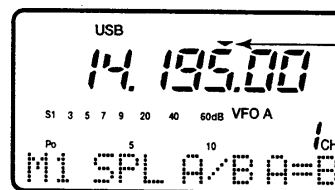

Tuning step indicator

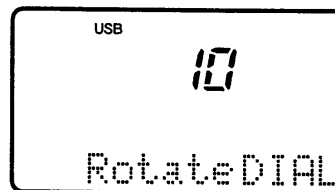

10 kHz tuning step is selected for USB operation.

1 Hz and 10 Hz tuning steps

When none of the tuning step or band changing indicators, “▼,” appear, rotating the main dial changes the frequency in the normal increments of 1 or 10 Hz.

- ① Push [TS] one or more times until none of the tuning step or band changing indicators appear.
- ② Push [TS] for 2 sec. to toggle between the 1 and 10 Hz step settings.
 - When the 1 Hz step is selected, the 1 Hz digit appears in the frequency indication; when the 10 Hz step is selected, the 1 Hz digit disappears in the frequency indication.

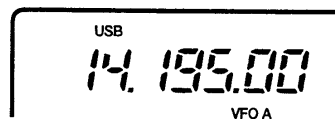

Rotating the main dial changes the frequency in 10 Hz steps.

Push [TS] for 2 sec.

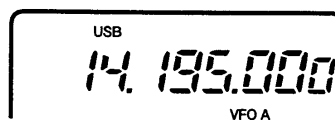

Rotating the main dial changes the frequency in 1 Hz steps.

• 1 MHz quick tuning step

The quick tuning step function allows you to change the frequency in 1 MHz steps when rotating the main dial.

- ① Push [TS] one or more times until “▼” appears above the MHz digit.
 - When the band changing indicators appear (two “▼” appear above the MHz and 10 MHz digits), push [TS] for 2 sec. to select the quick tuning step indicator.
- ② Rotate the main dial to change the frequency in 1 MHz steps.
- ③ To exit the quick tuning step condition, push [TS] for 2 sec. to select the band changing indicators or push [TS] once or twice to select one of the other tuning functions.

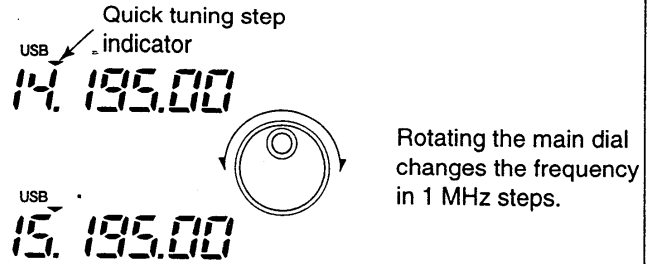

[TS] SWITCH FLOW CHART

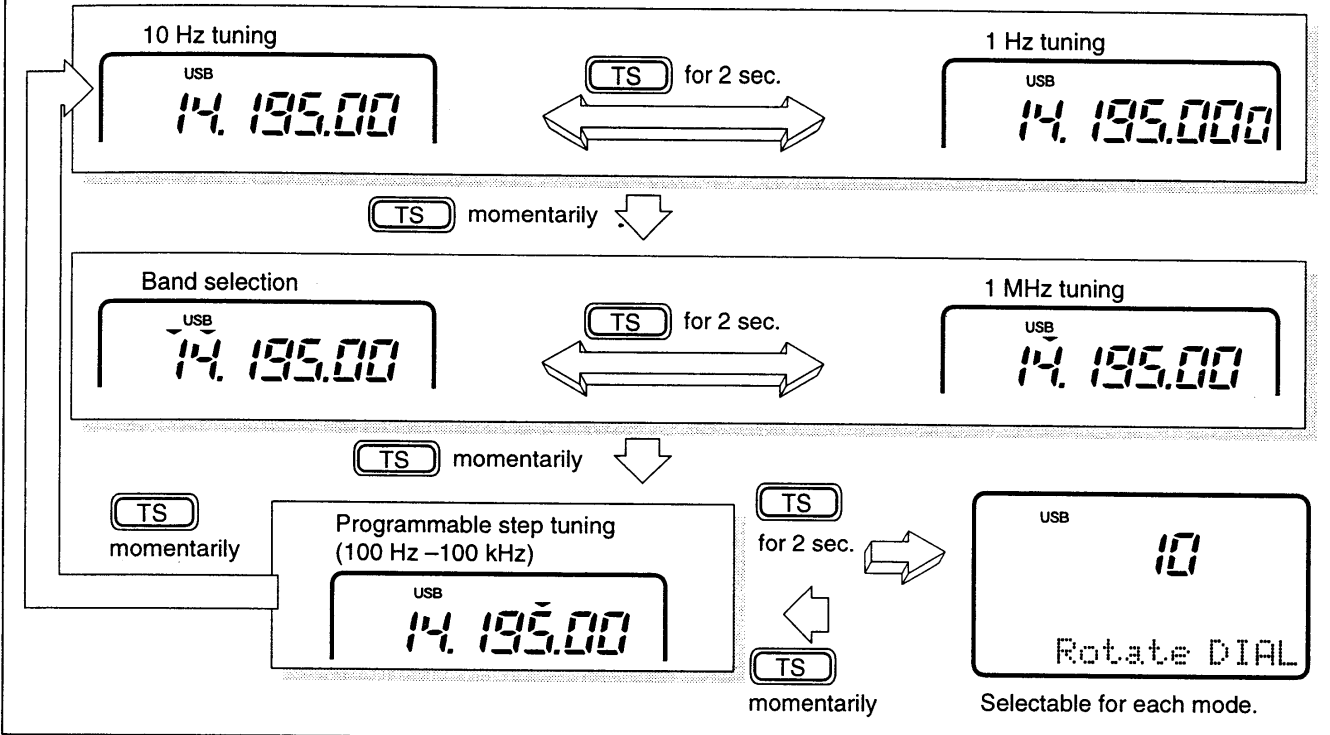

■ Mode selection

The following modes are available in the IC-706:

SSB (LSB/USB), CW, CW-R (CW reverse), FM, WFM (receive only), AM and RTTY.

To select the desired mode of operation push [MODE] one or more times, then push [MODE] for 2 sec., if necessary. See the diagram at right for the order of selection.

- The selected mode is indicated in the function display.

OPERATING MODE SELECTION

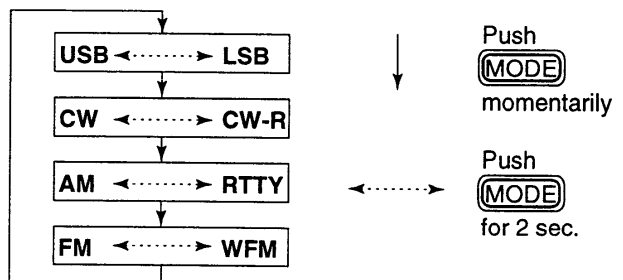

4 RECEIVE AND TRANSMIT

■ Functions for receive

◇ IF shift function

The IF shift function electronically changes the pass-band frequency of the IF (intermediate frequency) and cuts out higher or lower frequency components of the IF to reject interference. The function shifts the IF frequency up to ± 1.2 kHz in 15 Hz steps in SSB/CW/RTTY modes and up to ± 250 Hz in 3 Hz steps in CW-N/RTTY-N modes. The IF shift is not available in FM and AM modes.

- ① Adjust the [SHIFT] control for a minimum interference signal level.
 - The audio tone may be changed while the IF shift is in use.
- ② Set the shift control to its center position when there is no interference.

• Graphic display

The IF shift can be displayed graphically in graphic display mode.

- ① Select IF shift in graphic display mode.
 - Push [DISP] 1 or 2 times when M or S is displayed.
 - Push [MENU] one or more times to select the IF shift display, G2 (IF SHIFT appears briefly).
- ② The IF shift is graphically displayed and updated as the [SHIFT] control is rotated.

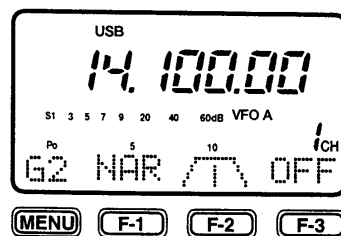
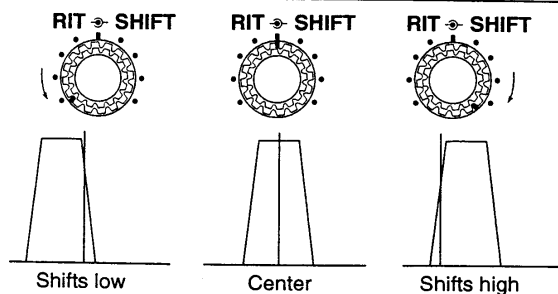

- OFF
 [F-3] : Push and hold to turn the IF shift function OFF temporarily.
- NAR
 [F-1] : When an optional filter is installed, push this switch to select it.

◇ RIT function

The RIT (Receive Incremental Tuning) function compensates for off-frequencies of communicating stations. The function shifts the receive frequency only, up to ± 1 kHz in 10 Hz steps without moving the transmit frequency.

- ① Push the [RIT] switch.
 - The [RIT] switch indicator lights.
- ② Rotate the [RIT] control to cancel the off-frequencies.
 - The transmit frequency is not shifted.
- ③ To cancel the RIT function, push [RIT] again.
 - The [RIT] switch indicator goes out.

• Calculate function

The shift frequency of the RIT function can be added/subtracted to the displayed frequency.

While the RIT indicator is lit, push and hold [RIT] for 2 sec.

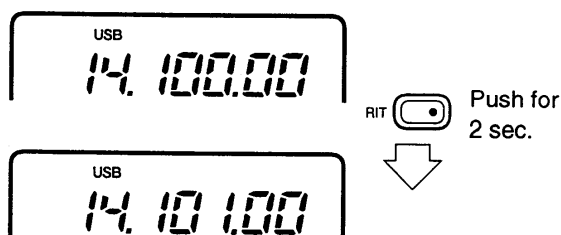
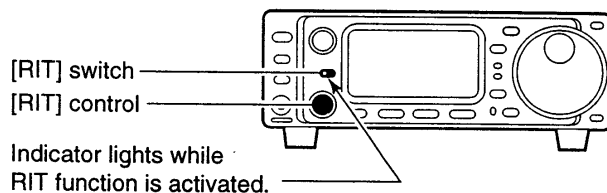

◇ Noise blanker

The *noise blanker* reduces pulse-type noise such as that generated by automobile ignition systems. This function is not effective for AM and FM modes or for non pulse-type noise.

- ① Select M3.
 - Push [DISP] 1 or 2 times when S or G is displayed.
 - Push [MENU] one or more times to select M3.
- ② Push [(F-2)NB] to toggle the noise blanker ON and OFF.
 - "NB" appears when the noise blanker is turned ON.

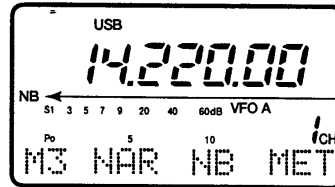

Appears when the noise blanker is turned ON.

◇ AGC time constant

The *AGC* (Automatic Gain Control) controls receiver gain to produce a constant audio output level even when the received signal strength is varied by fading, etc. Use AGC slow for normal phone operation; AGC fast for receiving data and searching for signals. AGC time constant cannot be changed in FM mode.

- ① Select M4.
 - Push [DISP] 1 or 2 times when S or G is displayed.
 - Push [MENU] one or more times to select M4.
- ② Push [(F-3)AGC] to toggle the AGC time constant between fast and slow.
 - "FAGC" appears when the fast time constant is selected.

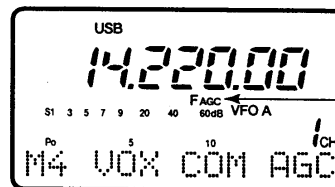

Appears when AGC fast is selected.

◇ Preamp and attenuator

The *preamp* amplifies received signals in the front end circuit to improve the S/N ratio and sensitivity. Turn this function ON when receiving weak signals.

The *attenuator* prevents desired signals from distorting when very strong signals are near the desired frequency or when very strong electric fields, such as from broadcasting stations, are near your location.

Push [P.AMP/ATT] momentarily to turn the preamp ON and OFF; push and hold to turn the attenuator ON.

- Lights green when the preamp is ON; lights red when the 20 dB attenuator is ON.
- Only one of these functions can be activated at a time.



Lights green while the preamp is activated; lights red while the attenuator is activated.

◇ Peak meter hold

INITIAL SET MODE

The peak meter hold function freezes the highest displayed bar segment in any meter function for about 0.5 sec. so that you can more easily read the meter. This function can be turned ON and OFF in initial set mode (see p. 43).

[EXAMPLE]:

S1 3 5 7 9 20 40 60dB Initial reception of a signal results in an S-meter reading of 40 dB.

S1 3 5 7 9 20 40 60dB The highest indicated bar remains displayed for about 0.5 sec. even when the signal strength decreases.

◆ RF gain and squelch

The IC-706 uses the same control, [RF/SQL], to adjust one of either the RF gain or the squelch. [RF/SQL] adjusts either the RF gain or the squelch depending on the operating mode selected and the condition of the RF gain item in initial set mode (see the table at right).

The *RF (Radio Frequency) gain* is used to adjust the receiver gain.

- This control should be set to the center position for normal use.
- Shallow rotation moves the S-meter to the right indicating the signal strength which can be received.

The *SQUELCH* removes noise output from the speaker (closed condition) when no signal is received. The squelch is particularly effective for FM. It is also available for the other modes.

- When operating in FM, first rotate the control fully counterclockwise. Then, rotate the control clockwise to the point where the noise just disappears. This is the best position. The squelch does not open for weak signals when it is set too deep.
- A segment appears in the S-meter to indicate the squelch level.

• [RF/SQL] control priority

Initial set mode setting	USB, LSB, CW, RTTY	AM, FM
RF gain OFF	SQL	SQL
RF gain ON	RF GAIN	SQL

NOTE: Squelch and RF gain functions are not effective in WFM mode.

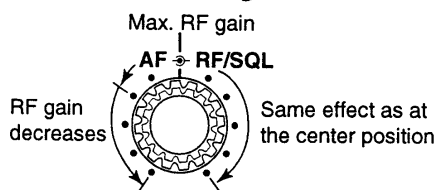

NOTE: The recommended position for RF gain is the center position since this sets RF gain to the max. and squelch just closed.

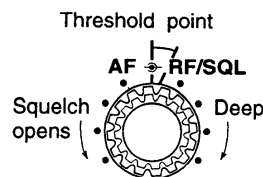

◆ Simple band scope

This function allows you to visually “sweep” an area surrounding the set frequency for other signals. Detected signals are indicated graphically in the dot matrix section of the display.

- ① Set a mode and frequency.
- ② Select G1.
 - Push [DISP] 1 or 2 times if M or S appears.
 - Push [MENU] one or more times to select G1.
- ③ Push [F-1] one or more times to select the desired steps.
 - Each dot corresponds to a step for the indicated frequency.
 - 0.5, 1, 2, 5, 10 and 20 kHz can be set for the scope step.
- ④ Push [F-3] to start the sweep.
 - “—” (below SWP) flashes while sweeping.
 - The receive audio is muted while sweeping.
- ⑤ Rotate the main dial if you want to monitor the displayed signals.
 - The sweep marker indicates the location of the displayed frequency in the sweep readout.
 - If the displayed frequency is outside of the sweep readout (determined by the sweep width), the sweep marker flashes.
- ⑥ Push [F-2] to return the frequency to the start of a sweep.
 - The sweep marker moves back to the center position.

NOTE: Use the attenuator or turn OFF the preamp when using the band scope on a band containing a lot of noise.

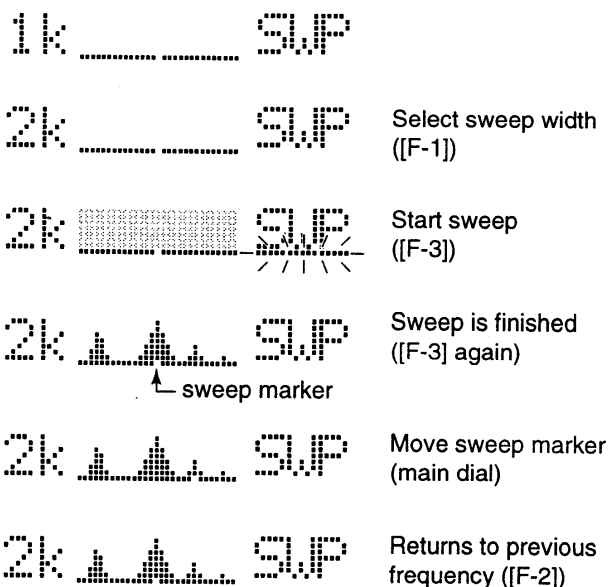

◆ Optional filter selection

One optional filter can be installed in the IC-706.

Narrow filters help reject interference from adjacent signals and obtain good selectivity.

Wide filters provide improved audio for SSB operation when no interfering signals are present.

Consult the table at right to select a filter most suitable for your operating needs.

Narrow filters for AM/FM modes are standard.

MODE	NAR OFF	NAR (or WIDE) ON				
		No opt. filter	FL-100 (CW)	FL-101 (CW)	FL-103 (SSB wide)	FL-223 (SSB nar)
SSB	2.3 kHz	N/A	N/A	N/A	2.8 kHz	1.9 kHz
CW, RTTY	2.3 kHz	N/A	500 Hz	250 Hz	2.8 kHz	1.9 kHz
AM	6.0 kHz	2.3 kHz	←	←	←	←
FM	15 kHz	8 kHz	←	←	←	←

FILTER PRESETTING:

After you install a filter (see p. 50 for installation), you must specify the installed filter in initial set mode (item 19 OPTIONAL FIL; see p. 45).

FILTER ON/OFF:

- ① Select M3.
 - Push [DISP] 1 or 2 times if M or S appears.
 - Push [MENU] one or more times to select M3.
- ② Push [(F-1)NAR].
 - When the FL-103 SSB WIDE FILTER is installed, WID appears instead of NAR (except in AM/FM modes).
 - **NAR** (or W) appears.

/// NAR selection is also possible in the G2 IF SHIFT menu. When selecting the narrow filter, the graphic passband is narrowed (see diagram at right).

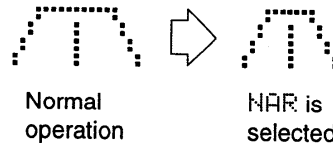

■ Functions for transmit

◇ Output power and mic gain

• Setting output power

- ① Push [DISP] for 2 sec. to select quick set mode.
- ② Push [MENU] one or more times to select Q1 RF POWER.
- ③ Rotate the main dial to select the desired output.
 - Output power is displayed in 11 steps (L, 1–9 and H) but is continuously selectable.
- ④ Push [DISP] to exit quick set mode.

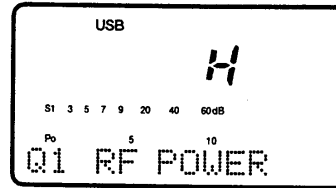

Maximum output power is selected.

• Available power

BAND	SSB/CW/RTTY/FM	AM*
HF	5–100 W	2–40 W
50 MHz	5–100 W	2–40 W
144 MHz	1–10 W	1–4 W

*Carrier power

• Setting microphone gain

Microphone gain must be adjusted properly so that your signal does not distort when transmitted.

- ① Select SSB or another phone mode.
- ② Push [DISP] for 2 sec. to select quick set mode.
- ③ Push [MENU] one or more times to select Q2 MIC GAIN.
 - The ALC meter is selected automatically when operating in SSB mode.
- ④ While speaking into the microphone adjust the mic gain so that the ALC meter does not peak past the ALC zone.
- ⑤ Push [DISP] to exit quick set mode.

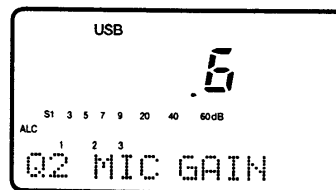

Microphone gain is set to 6.

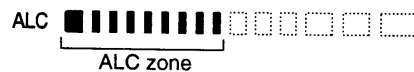

◇ Meter function

The bar meter in the function display acts as an S-meter (for relative signal strength, except in WFM mode) during receive and can be selected for one of three types during transmit.

- ① Select M3.
 - Push [DISP] 1 or 2 times when S or G appears.
 - Push [MENU] one or more times to select M3.
- ② Push [(F-3)MET] one or more times to select the desired meter function.
 - The display indication changes as in the table at right.

DISPLAY INDICATION	MEASUREMENT
Po	Indicates the relative RF output power.
ALC	Indicates the ALC level. When the meter movement shows the input signal level exceeds the allowable level, the ALC limits the RF power. In such cases, reduce the microphone gain (see above).
SWR	Indicates the SWR over the transmission line.

/// NOTE: The SWR meter cannot be used for the 144 MHz band since the meter activates for the [ANT 1] connector only.

◇ Speech compressor

The IC-706 has a built-in, low distortion speech compressor circuit. This circuit increases your average talk power in SSB mode and is especially useful for DX'ing when the receiving station is having difficulty copying your signal.

- ① Select USB or LSB mode.
- ② Select the ALC meter.
 - Push [DISP] 1 or 2 times to select M, if necessary.
 - Push [MENU] one or more times to select M3, then push [(F-3)MET] one or more times to select "ALC."
- ③ Select the mic gain display in quick set mode.
 - Push [DISP] for 2 sec.
 - Push [MENU] one or more times to select Q2 MIC GAIN.
- ④ Adjust the mic gain.
 - While transmitting at your normal voice level, the ALC meter should read at about the middle of the ALC zone.
 - Be sure the mic gain is in the range of 2 to 5.
- ⑤ Select M4.
 - Push [DISP] 1 or 2 times to select M, if necessary.
 - Push [MENU] one or more times to select M4.
- ⑥ Push [(F-2)COM], then adjust [COMP GAIN] so that the ALC meter reads within the ALC zone whether you speak softly or loudly.

When the ALC meter peaks above the ALC zone, your transmitted voice may be distorted.

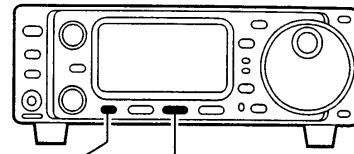

[MENU] [(F-2)COM]

[COMP GAIN]

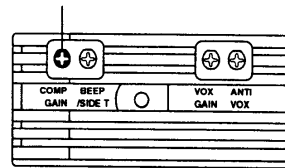

Adjust [COMP GAIN] so that the ALC meter reads within the ALC zone.

◇ VOX operation

The VOX (Voice-operated Transmission) function toggles between transmit and receive with your voice. This function provides an opportunity to input log entries into your computer, etc., while operating.

- ① Set [VOX GAIN] and [ANTI-VOX] on the transceiver's side panel max. counterclockwise.
- ② Select M4, then turn the VOX function ON.
 - Push [DISP] 1 or 2 times when 5 or 6 appears.
 - Push [MENU] one or more times to select M4.
 - Push [(F-1)VOX] to turn the function ON.
- ③ Select VOX DELAY in quick set mode.
 - Push [DISP] for 2 sec. then push [MENU] one or more times to select Q3.
- ④ While speaking into the microphone, rotate [VOX GAIN] clockwise until the transceiver is transmitting.
- ⑤ Adjust the delay time as desired with the main dial (while VOX DELAY is indicated).
- ⑥ If the receive audio from the speaker toggles the transceiver to transmit during receive, adjust the [ANTI-VOX] control to the point where it has no effect.
- ⑦ Push [DISP] to exit quick set mode.

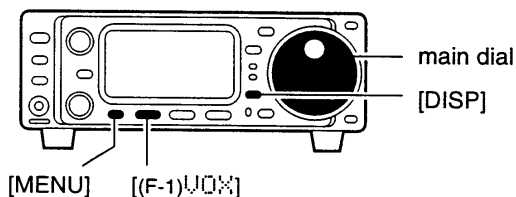

[MENU] [(F-1)VOX]

[VOX GAIN] [ANTI VOX]

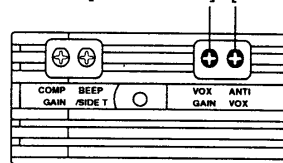

◇ Optional AT-180 AUTOMATIC ANTENNA TUNER operation

The AT-180 automatic antenna tuner matches the IC-706 to the connected antenna automatically. Once the tuner matches an antenna, the variable capacitor angles are memorized as a preset point for each frequency range (100 kHz steps). Therefore, when you change the frequency range, the variable capacitors are automatically preset to the memorized point.

CAUTION: NEVER transmit with the tuner ON when no antenna is connected. This will damage both the transceiver and the antenna tuner.

NOTE:

- The AT-180 cannot be used for the 144 MHz band.
- When operating on the 144 MHz band, pushing the tuner switch selects the call channel (p. 33).
- The AT-180 can match both HF and 50 MHz bands. However, operation is different for the HF and 50 MHz bands.

TUNER OPERATION

•For the HF band:

Push [TUNER] to turn the tuner ON. The antenna is tuned automatically during transmission when the antenna SWR is higher than 1.5:1.

[TUNER/CALL]

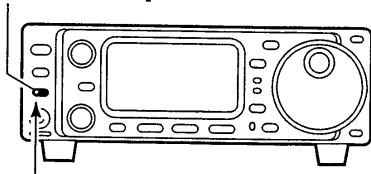

Lights to indicate the AT-180 is turned ON.

- When the tuner is OFF, the [TUNER] light goes out.

•For the 50 MHz band:

Push and hold [TUNER] to tune the antenna. If the [TUNER] light flashes slowly while transmitting, push and hold [TUNER] again to re-tune the antenna.

[TUNER/CALL]

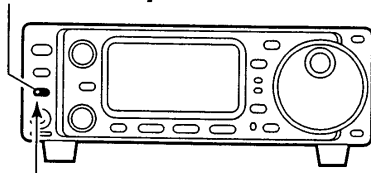

Flashes to indicate re-tuning is necessary.

MANUAL TUNING

During SSB operation on HF bands at low voice levels, the AT-180 may not be tuned correctly. In such cases, manual tuning is helpful.

Push and hold [TUNER] for 1 sec. to start manual tuning.

- CW mode is selected, a side tone is emitted, and the [TUNER] light flashes; then, the previous mode is selected.

[TUNER/CALL]

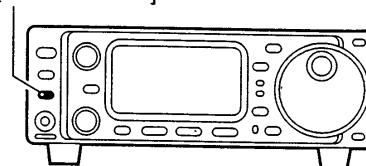

Push and hold for 1 sec. to start manual tuning.

If the tuner cannot reduce the SWR to less than 1.5:1 after 20 sec. of tuning, the [TUNER] light goes out. In this case, check the following:

- the antenna connection and feedline
- the antenna SWR (p. 23; meter function)

Through inhibit (HF bands only)

The AT-180 has a through inhibit condition. When selecting this condition, the tuner can be used at poor SWR's. In this case, automatic tuning in the HF bands activates only when exceeding SWR 3:1. Therefore, manual tuning is necessary each time you change the frequency. Although termed "through inhibit," the tuner will be "through" if the SWR is higher than 3:1 after tuning.

CONVENIENT

•Tuner sensitive condition (HF bands only)

If you require critical tuning at any time during transmission, select the tuner sensitive condition. See p. 51 for selection.

•Automatic tuner start (HF bands only)

If you require to turn OFF the tuner under conditions of VSWR 1.5:1 or less, use "automatic tuner on" and turn the tuner OFF. See p. 44 for turning the function ON and OFF.

◇ Optional AH-3 AUTOMATIC ANTENNA TUNER operation

The AH-3 matches the IC-706 to a long wire antenna more than 3 m/10 ft long (3.5 MHz and above) or more than 12 m/40 ft long (1.8 MHz and above).

- See p. 14 for connection.
- See the AH-3 instruction manual for AH-3 installation and antenna connection details.

AH-3 setting example:

For mobile operation

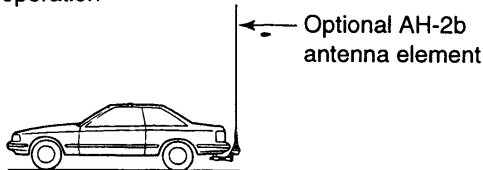

For outdoor operation

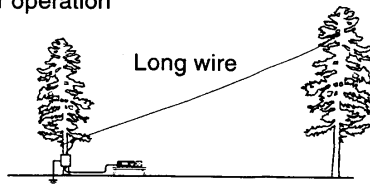

⚠ WARNING: HIGH VOLTAGE!
NEVER touch the antenna element while tuning or transmitting.

NEVER operate the AH-3 without an antenna wire. The tuner and transceiver will be damaged.

NEVER operate the AH-3 when it is ungrounded.

Transmitting before tuning may damage the transceiver. Note that the AH-3 cannot tune when using a $\frac{1}{2} \lambda$ long wire or multiple of the operating frequency.

/// **NOTE:** The AH-3 can be used for HF bands only. It cannot be used for the 50 MHz or 144 MHz bands.

AH-3 operation

Tuning is required for each frequency. **Be sure** to re-tune the antenna before transmitting when you change the frequency—even slightly.

- ① Set the desired frequency in an HF band.
 - The AH-3 will not operate on frequencies outside of ham bands.

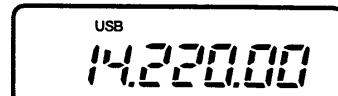

- ② Push and hold [TUNER] for 2 sec.
 - The [TUNER] light flashes and "CW" appears while tuning.

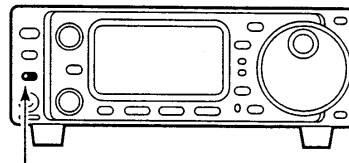

Push [TUNER] for 2 sec.

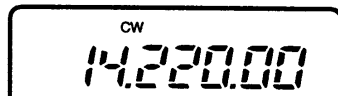

- ③ The [TUNER] light lights constantly when tuning is complete.
 - When the connected wire cannot be tuned, the [TUNER] light goes out, the AH-3 is bypassed and the antenna wire is connected to the antenna connector on the transceiver directly.
- ④ To bypass the AH-3 manually, push [TUNER].

CONVENIENT

•PTT tune function

The AH-3 is always tuned when the PTT is pushed after the frequency is changed (more than 1%). This function removes the "push and hold [TUNER]" operation and activates first transmission on the new frequency. This function is turned ON in quick set mode, item 13 (p. 44).

Split frequency operation

Split frequency operation allows you to transmit and receive on two different frequencies (in the same band). Split frequency operation uses 2 frequencies, one in VFO A and the other in VFO B.

Following is an example of setting 7.057 MHz, CW mode in VFO A (for receive) and 7.025 MHz, CW mode in VFO B (for transmit).

① Select VFO A and set the frequency to 7.057 MHz/CW.

- [(F-2)A/B] is available when M1 appears.
- [(F-3)U/M] is available when M2 appears.

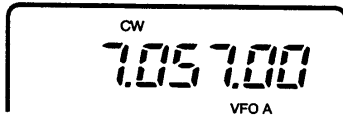

② Push or push and hold [(F-1)SPL] in the M1 display.

- ➔ Push [SPL]: activates split only.
- ➔ Push and hold [SPL]: activates the quick split below.

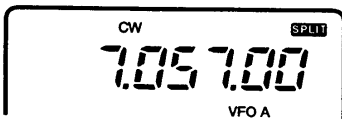

③ To change the receive frequency, rotate the main dial; to change the transmit frequency, rotate the main dial while pushing [(F-3)XFC].

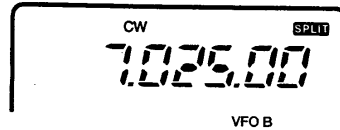

- The transmit frequency can be monitored while pushing [(F-3)XFC].
- Split operation is now set for receive on 7.057 MHz/CW and transmit on 7.025 MHz/CW.

To exchange the transmit and receive frequencies, push [(F-2)A/B] in M1.

NOTE: The split function can be used only when both the receive and transmit frequencies (VFO A and B) are in the same band.

CONVENIENT

The G3 display conveniently shows the transmit frequency during split frequency operation and [(F-3)XFC] allows you to change the transmit frequency.

Split lock function

The split lock function is convenient for changing only the transmit frequency. Otherwise, accidentally releasing the [(F-3)XFC] switch while rotating the main dial changes the receive frequency. The split lock's effectiveness can be selected in initial set mode (item 18) for both receive and transmit frequencies; or only the receive frequency. (p. 44)

Quick split function

In M1, when you push [(F-1)SPLIT] for 2 sec., split frequency operation is turned ON and VFO B is automatically changed according to the plus/minus pre-programmed shift frequency set in initial set mode (or equalized when 0 kHz is programmed as the split shift frequency). This shortens the time needed to start split frequency operation—great for DX'ing.

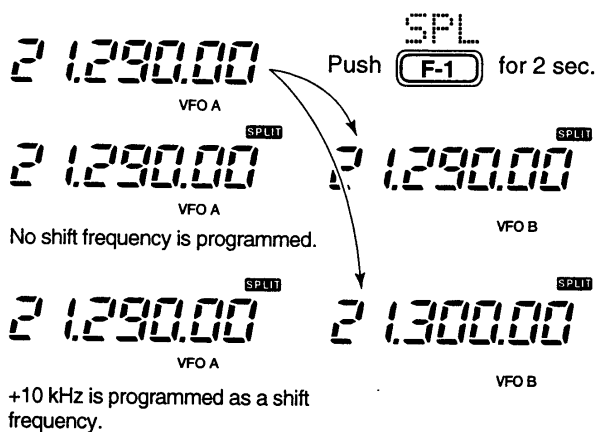

The quick split function is ON by default. If desired, it can be turned OFF in initial set mode (p. 44). In this case, pushing [(F-1)SPL] for 2 sec. has the same effect as pushing [(F-1)SPL] momentarily as in normal split operation.

PROGRAMMING SPLIT SHIFT FREQUENCY

- ① Push [POWER] to turn power OFF.
- ② While pushing [LOCK], push [POWER] to turn power ON and enter initial set mode.
- ③ Select "SPL OFFSET" using [MENU] or the [UP]/[DN] keys, then rotate the main dial to select the desired split offset.
 - The split offset can be selected from -4000 kHz to +4000 kHz.



NOTE: This setting is not valid for FM operation. This is because FM operation uses the duplex setting for repeater operation (page opposite).

◇ Repeater operation

A repeater amplifies received signals and retransmits them at a different frequency. When using a repeater, the transmit frequency is shifted from the receive frequency by an offset frequency. A repeater can be accessed using split frequency operation with the shift frequency set to the repeater's offset frequency.

- ① Set the offset frequency and turn ON the quick split function in initial set mode in advance (p. 44).
 - If the quick split function is turned OFF, both transmit and receive must be set separately.
- ② Push [MODE] to select FM mode, then set the receive frequency.
- ③ Select a suitable tone frequency or the 1750 Hz tone burst in quick set mode.
 - ➔ Push [DISP] for 2 sec., then push [MENU] one or more times to select "Q4 FM TONE."
 - If FM mode has not been selected, this item does not appear.
 - ➔ Rotate the main dial to set a subaudible tone frequency or the 1750 Hz tone burst function.
 - ➔ Push [DISP] to exit quick set mode.
- ④ Push [(F-1)SPL] for 2 sec. (in the M1 display) to activate the split frequency function (duplex function) with the pre-selected offset.
 - When a subaudible tone frequency (excepting 1750 Hz) is selected in ③, "FM-T" is selected simultaneously.
- ⑤ Push and hold [PTT] to transmit; release [PTT] to receive.
 - When a 1750 Hz tone burst is selected, push and hold [(F-3)TON] in the M4 display while pushing [PTT] to send the 1750 Hz tone burst.
- ⑥ To check the repeater input frequency (direct signal from the other station), push and hold [(F-3)XFC] in the M1 display.
- ⑦ To return to simplex operation, push [(F-1)SPL].

CONVENIENT

Each memory channel can store a tone frequency (subaudible tones or a tone burst) and an offset frequency, as well as the operating frequency. Store repeater information into memory channels for quick and easy access to repeaters.

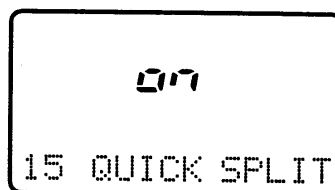

Turn the quick split function ON. (Initial set mode default is ON.)

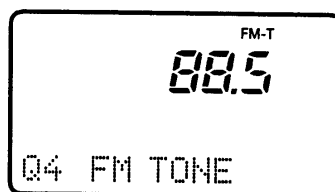

Set the tone frequency (quick set mode).

See p. 42 for setting details and available frequencies.



PROGRAMMING DUPLEX SHIFT FREQUENCY

- ① Push [POWER] to turn power OFF.
- ② While pushing [LOCK], push [POWER] to turn power ON and enter initial set mode.
- ③ Select "DUP OFFSET" using [MENU] or the [UP]/[DN] keys, then rotate the main dial to select the desired duplex offset.
 - The duplex offset can be selected from -4000 kHz to +4000 kHz.

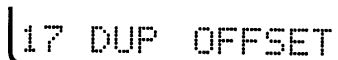

■ Functions for CW

◇ Connections for CW

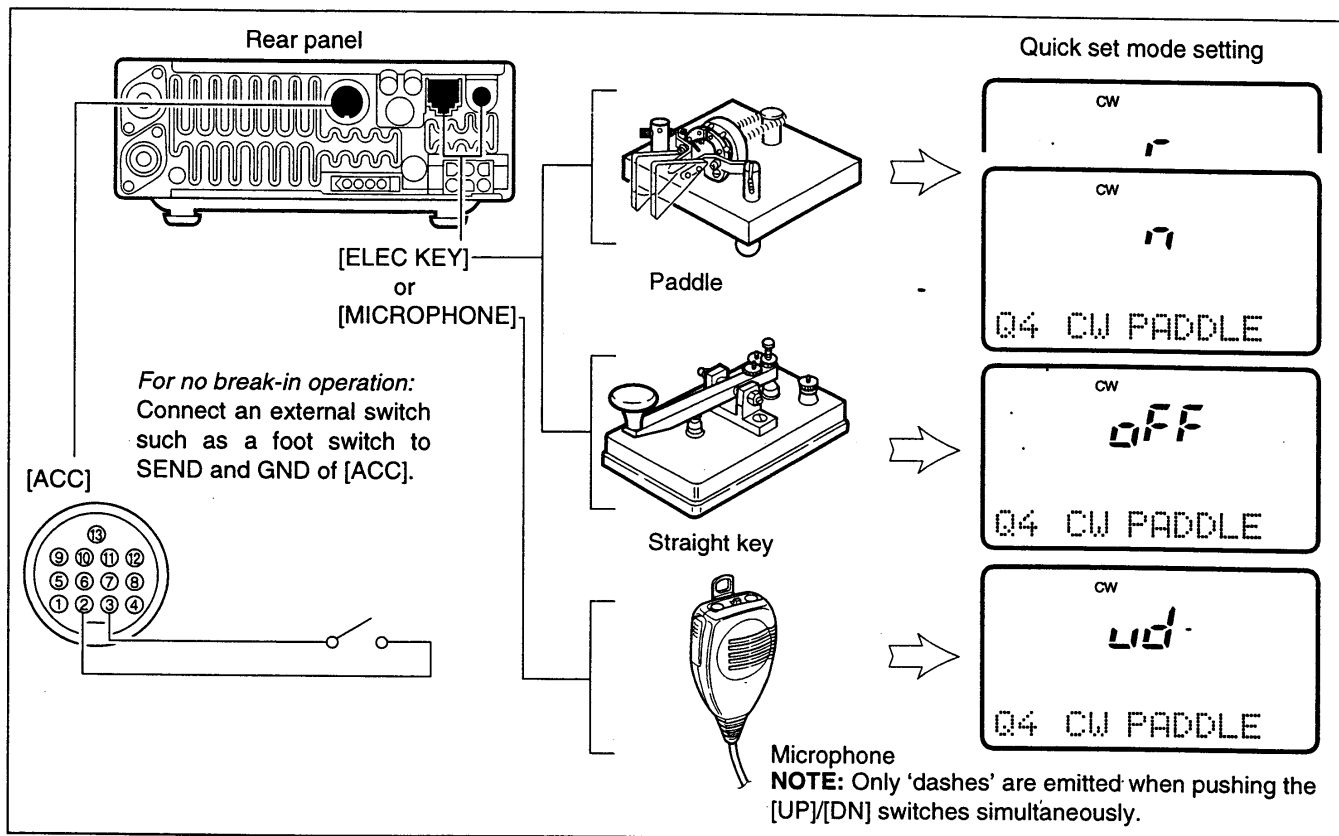

◇ CW operation

- ① Connect a paddle or straight key as above.
- ② Select CW (or CW-R) mode with [MODE].
- ③ Set CW break-in operation as semi break-in, full break-in or OFF.
 - Push [DISP] one or two times to select M, if necessary.
 - Push [MENU] one or more times to select M4.
 - Push [(F-2)BRK] one or more times to select the desired condition:
 - ▶ "F-BK": full break-in
 - ▶ "BK": semi break-in
 - ▶ No indicator: no break-in (ACC socket connection is necessary as above.)
- ④ Set the CW delay time when semi break-in operation is selected.
 - ▶ Push [DISP] for 2 sec. to select quick set mode; push [MENU] one or more times to select Q3 BK-IN DELAY; then rotate the main dial to set the desired delay time (see p. 41 for details).

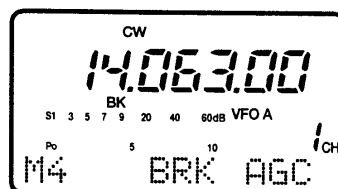

CW mode and semi break-in operation is selected.

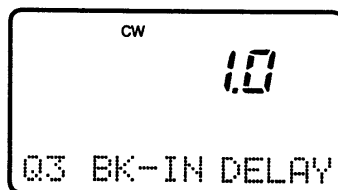

Delay time of 1.0 sec. is selected in quick set mode for semi break-in operation.

◇ CW pitch control QUICK SET MODE

The received CW audio pitch and monitored CW audio pitch can be adjusted to a comfortable frequency (300 to 900 Hz) without changing the operating frequency.

- ① Push [MODE] one or more times to select CW mode.
- ② Select CW PITCH in quick set mode.
 - Push [DISP] for 2 sec. then push [MENU] one or more times.
- ③ Rotate the main dial to set the desired pitch.

- ④ Push [DISP] to exit quick set mode.

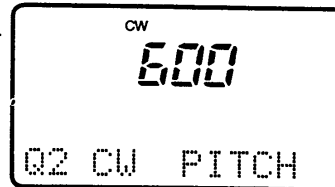

This shows the default setting for the CW pitch control (600 Hz).

◇ CW reverse mode

The CW-R (CW Reverse) mode receives CW signals with a reverse side CW carrier point like that of LSB and USB modes. Use this mode when interference signals are near the desired signal and you want to change the interference tone.

- ① Push [MODE] one or more times to select CW mode.
- ② Push and hold to toggle between CW and CW-R modes.
 - Check the interference tone.

• Receive audio tone response

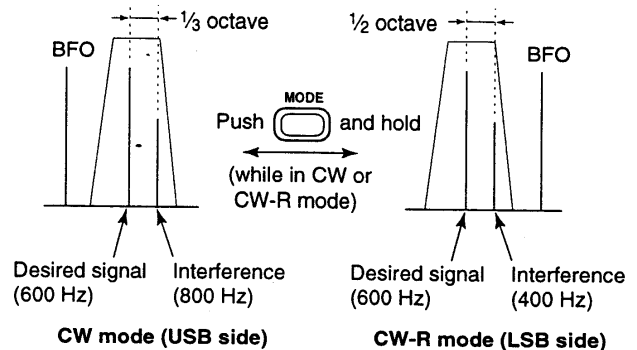

◇ Electronic CW keyer QUICK SET MODE

The IC-706 has an electronic keyer. Both keying speed and weight (the ratio of dot:space:dash) can be set in quick set mode.

• Setting the electronic keyer

- ① Select CW mode with [MODE].
- ② Push [DISP] for 2 sec. to enter quick set mode.
- ③ Push [MENU] one or more times to select item 04 CW PADDLE, then rotate the main dial to select the paddle type.
 - When "ud" is selected, the up/down switches on the microphone can be used as a paddle.
- ④ Push [MENU] two more times to select item 06 RATIO, then rotate the main dial to select the desired weight.
 - Key weight can be selected from 2.8 to 4.5.
 - Check the selected ratio with the side tone function in CW mode.
- ⑤ Push [DISP] momentarily to exit quick set mode.

KEYING WEIGHT EXAMPLE: morse code "K"

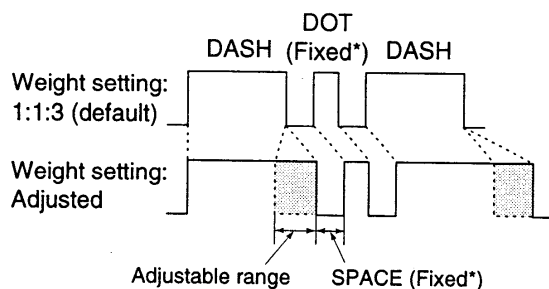

*SPACE and DOT length can be adjusted with "05 KEY SPEED" only.

■ Functions for RTTY

◇ Connections for RTTY (FSK)

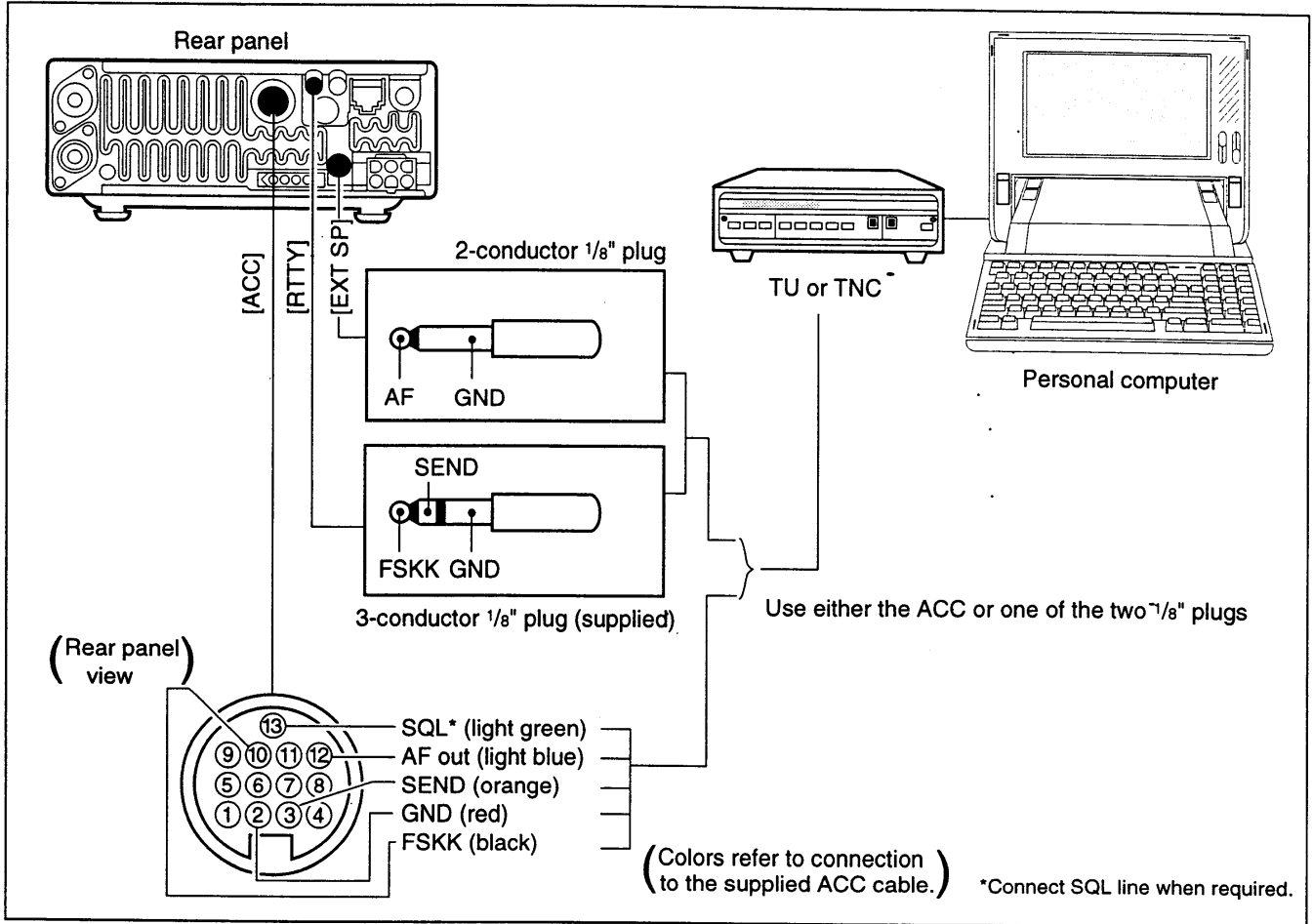

◇ Connections for AFSK

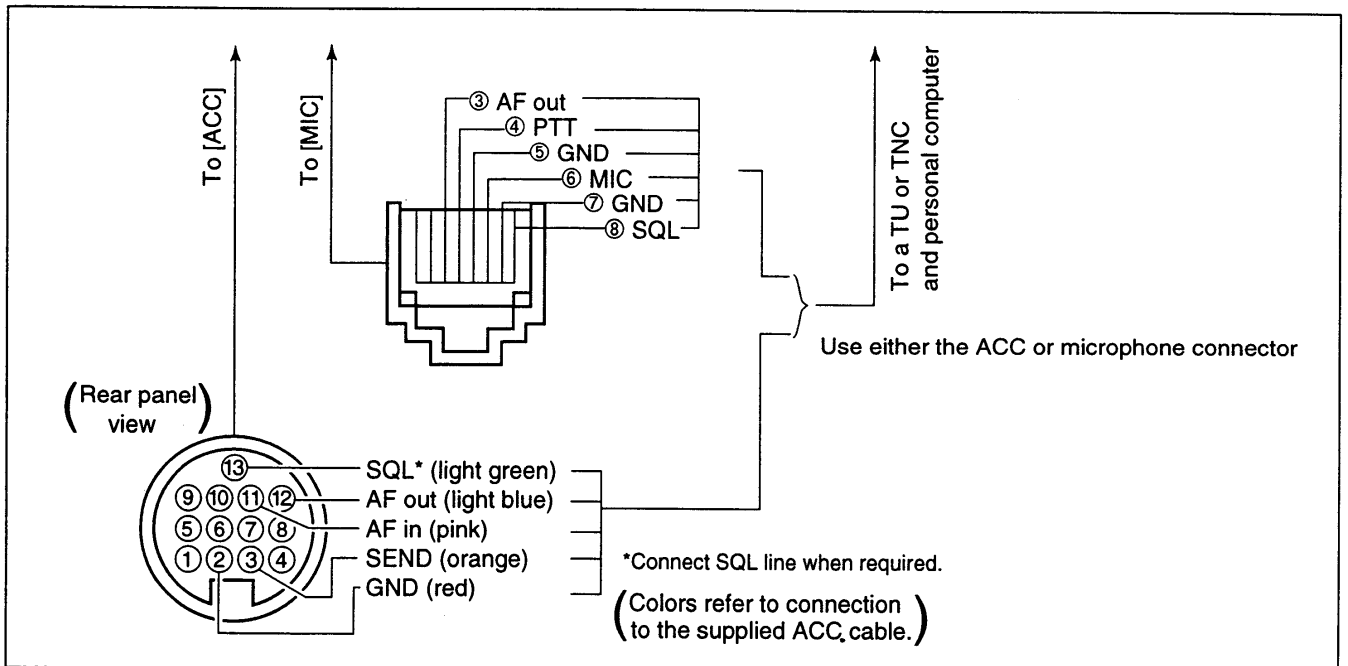

◇ RTTY (FSK) operation

- ① Connect a terminal unit as above.
- ② Select RTTY mode with [MODE].
 - Push [MODE] to select AM or RTTY mode.
 - Push and hold [MODE] to select RTTY when AM is selected above.
- ③ Select the desired FSK tone/shift frequencies and keying polarity as below.
- ④ Set the desired frequency with the main dial.
 - Use [(F-1)1/4] in the M4 display when critical setting is required.
- ⑤ Operate the connected PC or TNC (TU).

PRESETTING FOR RTTY

Tone frequency

- ① Push [DISP] for 2 sec. to select quick set mode.
- ② Push [MENU] one or more times to select Q2 RTTY TONE; then rotate the main dial to select the desired tone frequency (p. 41).

Shift frequency

- ① Push [DISP] for 2 sec. to select quick set mode.
- ② Push [MENU] one or more times to select Q3 RTTY SHIFT; then rotate the main dial to select the desired shift frequency (p. 41).

RTTY keying

- ① Push [DISP] for 2 sec. to select quick set mode.
- ② Push [MENU] one or more times to select Q4 RTTY KEYING; then rotate the main dial to select the desired keying polarity (p. 41).

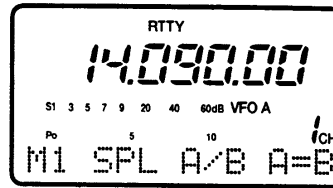

RTTY mode is selected.

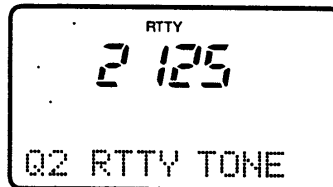

RTTY mark frequency is set to 2125 Hz.

2125 and 1615 Hz are available.



RTTY shift frequency is set to 170 Hz.

170/200/425 Hz are available.

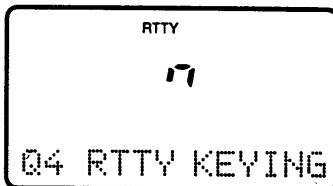

RTTY keying is set to 'normal'.

normal: key open=mark
key close=space

reverse: key open=space
key close=mark

Memory channels

The transceiver has 101 memory channels (plus 1 call channel). Memory mode is useful for quickly changing to often-used frequencies.

All 101 memory channels are tuneable which means the programmed frequency can be tuned temporarily with the main dial, etc., in memory mode.

NOTE: During split frequency operation, programmed memory contents can be called up to the SUB readout (dot matrix portion of the display).

MEMORY CHANNEL	MEMORY CHANNEL NUMBER	CAPABILITY	TRANSFER TO VFO	OVER-WRITING	CLEAR
Regular (split memory)	1-99	Independent transmit and receive frequencies and one mode in each memory channel. In addition, tone frequencies (or 1750 Hz tone burst) can also be stored for repeater use.	Yes	Yes	Yes
Scan edges	P1, P2	One frequency and one mode in each memory channel as scan edges for programmed scan.	Yes	Yes	No
Call channel	C	Same as regular, however, only the 144 MHz band can be programmed.	Yes	Yes	No

Memory channel selection

- ① Select M2 functions.
 - Push [DISP] 1 or 2 times to select M1.
 - Push [MENU] one or more times to select M2.
- ② Push [(F-3) U/M] to select memory mode.
- ③ Push [UP]/[DN] one or more times to select the desired memory channel.
 - All memory channels including blank channels can be selected.
 - [UP]/[DN] on the microphone changes the frequency.
- ④ To return to VFO mode, push [(F-3) U/M] again.

[EXAMPLE]: Selecting memory channel 17.

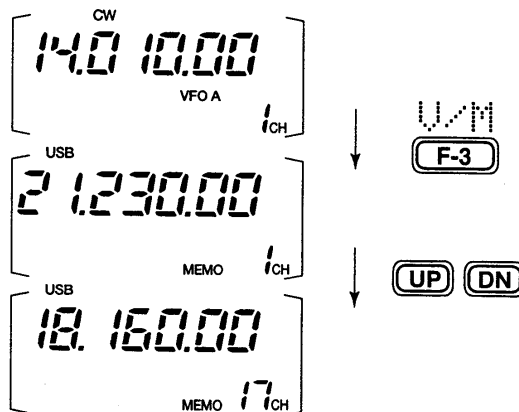

Memory clearing

Any unnecessary memory channels can be cleared. The cleared memory channels become blank channels.

- ① Push [(F-3) U/M] in the M2 display to select memory mode.
- ② Push [UP]/[DN] one or more times to select a memory channel to be cleared.
- ③ Push [MCL (F-2)] for 2 sec. to clear the contents.
 - The programmed frequency and operating mode disappear and "BLANK" appears.
- ④ To return to VFO mode, push [(F-3) U/M] again.

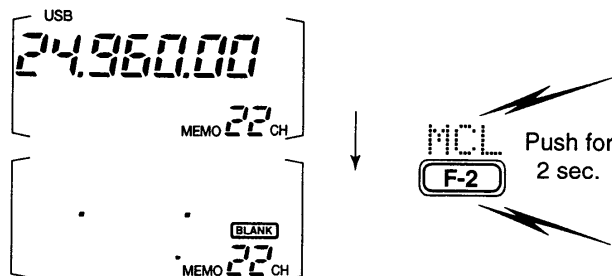

Memory/call programming

• Programming in VFO mode

- ① Select M2 functions.
 - Push [DISP] 1 or 2 times to select M1.
 - Push [MENU] one or more times to select the M2 functions.
- ② Set the desired frequency and operating mode in VFO mode.
 - If you want to program the split frequency function, program both receive and transmit frequencies into VFO A and B, then turn ON the split function.
 - If you want to program a repeater function, set a tone frequency (p. 42) in addition to the receive/transmit frequencies.
- ③ Push [UP]/[DN] on the front panel one or more times to select the desired memory channel.
 - Select memory mode to confirm the contents, if desired.
 - "BLANK" appears if the selected memory channel is a blank channel (and does not have contents).
- ④ Push [(F-1)M] for 2 sec. to program the displayed frequency and operating mode into the memory channel.

To check the programmed contents, push [(F-3)M] to select memory mode.

[EXAMPLE]: Programming 7.088 MHz/LSB into ch 12.

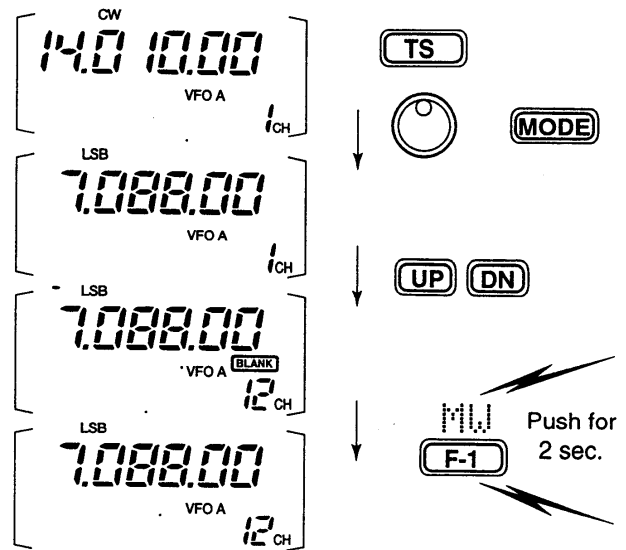

• Programming in memory mode

- ① Select M2 functions.
 - Push [DISP] 1 or 2 times to select M1.
 - Push [MENU] one or more times to select the M2 functions.
- ② Select memory mode, then select the desired memory channel with [UP]/[DN].
 - Blank memory channels cannot be programmed using this method. Use the programming method described above for blank channels.
- ③ Set the desired frequency and operating mode.
- ④ Push [(F-1)M] for 2 sec. to program the displayed frequency and operating mode into the memory channel.

[EXAMPLE]: Programming 21.280 MHz/USB into ch 18.

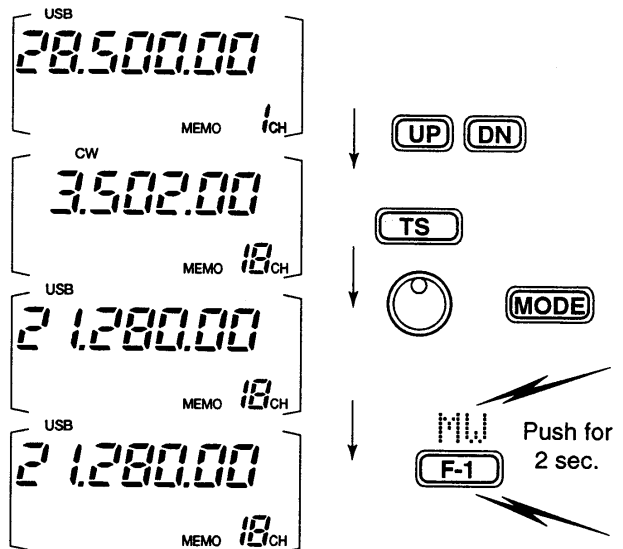

Frequency transferring

The frequency and operating mode can be transferred from memory mode to VFO mode.

- ① Select VFO mode with [(F-3)] in the M2 display.
- ② Select a memory channel with [UP]/[DN].
 - Select memory mode to confirm the memory channel's contents, if desired; then return to VFO mode.
 - "[BLANK]" appears if the selected memory channel is a blank channel (and does not have contents). In this case transferring is not possible.
- ③ Push [(F-2)] for 2 sec. to transfer the frequency and operating mode.
 - Transferred frequency and operating mode appear in the display.
 - "" does not appear in memory mode.

[EXAMPLE]: Transferring contents of memory 16.
 Operating frequency: 21.320 MHz/USB (VFO)
 Contents of memory 16: 14.020 MHz/CW

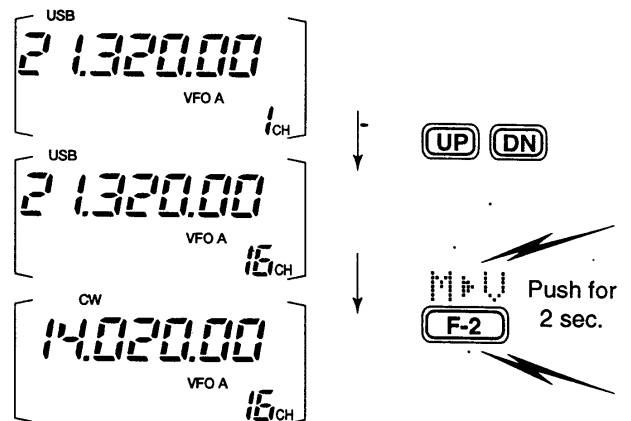

Memory names

All memory channels (including scan edges and the call channel) can be tagged with alphanumeric names of up to 9 characters each.

All common keyboard characters (ASCII characters 33 to 126) can be used, including numerals and punctuation marks.

Calling up memory names

- ① Select the G4 display.
 - ➔ Push [DISP] 1 or 2 times to select G.
 - ➔ Push [MENU] one or more times to select the G4 display.
- ② Select a memory channel with [UP]/[DN].

Editing (programming) memory names

- ① Call up the desired memory (channel) name as above.
- ② Push [(F-3)] to enter memory name edit mode.
 - "name edit" appears briefly, then a flashing cursor appears under the first character position.
- ③ Rotate the main dial to select the desired character, then advance the cursor position.
 - [(F-3)] increments the cursor position; [(F-1)] decrements the cursor position.
 - [(F-2)] overwrites the character with a space.
- ④ Repeat this procedure until all desired characters have been selected.
- ⑤ Push [(MENU)] to exit memory name edit mode.
 - The G4 display reappears and the programmed memory name is displayed.

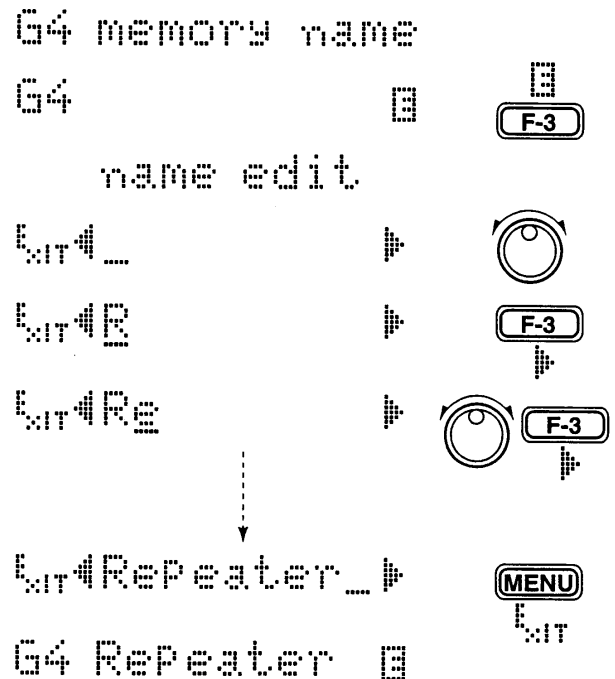

■ Memo pads

The transceiver has a memo pad function to store frequency and operating mode for easy write and recall. The memo pads are separate from memory channels.

The default number of memo pads is 5, however, this can be increased to 10 in initial set mode if desired (p. 44).

Memo pads are convenient when you want to memorise a frequency and operating mode temporarily, such as when you find a DX station in a pile-up or when a station is busy for a long time and you want to temporarily search for other stations.

Use the transceiver's memo pads instead of relying on hastily scribbled notes that are easily misplaced.

• Writing frequencies and operating modes into memo pads

- ① Select the S1 display.
 - Push [DISP] 1 or 2 times to select S.
 - Push [MENU] one or more times to select S1.
- ② Push [(F-2)MFW] to program the frequency into a memo pad.

When you write a 6th frequency and operating mode, the oldest written frequency and operating mode are automatically erased to make room for the new settings.

NOTE: Each memo pad must have its own unique combination of frequency and operating mode; memo pads having identical settings cannot be written.

Displayed frequency and mode

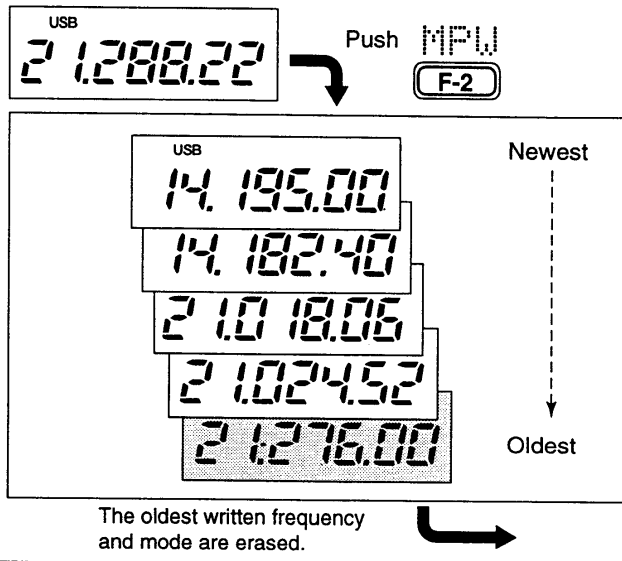

• Calling up a frequency from a memo pad

You can simply call up the desired frequency and operating mode of a memo pad by pushing [(F-3)MFR] in the S1 display.

- Make sure S1 is selected in advance.
- Both VFO and memory modes can be used.
- The frequency and operating mode are called up, starting from the most recently written.

When you call up a frequency and an operating mode from memo pads with [(F-3)MFR], the previously displayed frequency and operating mode are automatically stored in a temporary pad. The frequency and operating mode in the temporary pad can be recalled by pushing [(F-3)MFR] one or more times.

- You may think there are 6 memo pads because 6 different frequencies (5 are in memo pads and 1 is in the temporary pad) are called up by [(F-3)MFR].

NOTE: If you change the frequency or operating mode called up from a memo pad, the frequency and operating mode in the temporary pad are erased.

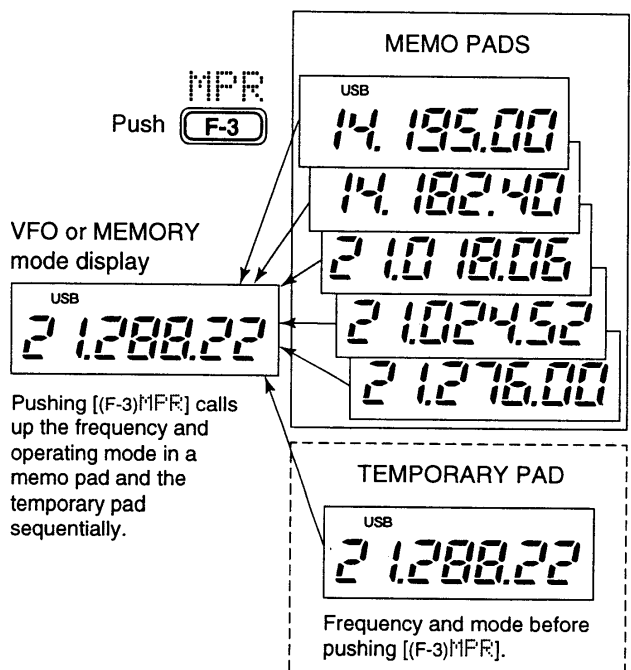

Scan types

PROGRAMMED SCAN

Repeatedly scans between two scan edge frequencies (scan edge memory channels P1 and P2).

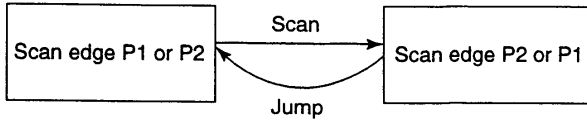

This scan operates in VFO mode.

PRIORITY WATCH

Checks for signals on a memory or call channel while operating on a VFO frequency.

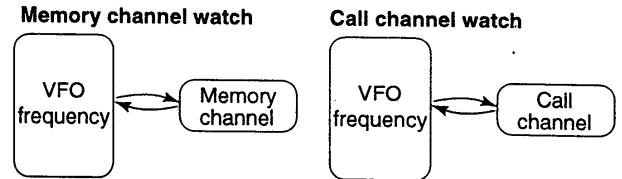

This scan operates in VFO mode.

MEMORY SCAN

Repeatedly scans all programmed memory channels.

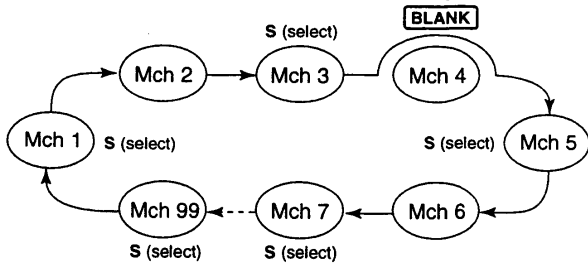

This scan operates in memory mode.

SELECTED MEMORY SCAN

Repeatedly scans all selected memory channels.

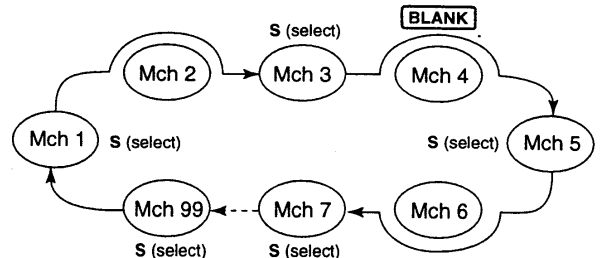

This scan operates in memory mode.

Preparation

Channels

For programmed scan: Program scan edge frequencies into scan edge memory channels P1 and P2 (p. 33).

For memory scan: Program 2 or more memory channels except scan edge memory channels.

For memory select scan: Designate 2 or more memory channels as select memory channels—select a memory channel, then push [(F-2)SEL] in the S2 display (memory mode) to designate the channel as a select memory channel.

For priority watch: Program 1 memory channel to be watched.

Scan resume ON/OFF

You can select the scan to resume or cancel when detecting a signal, in initial set mode, item 9. Scan resume ON/OFF must be set before operating a scan. See p. 43 for ON/OFF setting and scan resume condition details.

Scan speed

Scan speed can be selected from 2 levels, high or low, in initial set mode. See p. 43 for details.

Squelch condition

SCAN STARTS WITH	PROGRAMMED SCAN	MEMORY SCANS PRIORITY WATCH
SQUELCH OPEN	<p>The scan continues until it is stopped manually, and does not pause even if it detects signals.</p> <p>This is not applicable when the scan resume is OFF and a programmable step (more than 1 kHz) is selected.</p>	<p>Scan pauses on each channel when the scan resume is ON; not applicable when OFF.</p>
SQUELCH CLOSED	<p>Scan stops when detecting a signal.</p> <p>If you set scan resume ON in initial set mode, the scan pauses for 10 sec. when detecting a signal, the resumes. When a signal disappears while scan is paused, scan resumes 2 sec. later.</p>	

■ Programmed scan operation

- ① Select VFO mode.
- ② Select the desired operating mode.
 - The operating mode can also be changed while scanning.
- ③ Set [SQL] open or closed.
 - See page a left for squelch condition.
- ④ Select S2, then push [(F-1)SCN] to start the scan.
 - Decimal point blinks while scanning.
- ⑤ When the scan detects a signal, the scan turns OFF, pauses or ignores it depending on the resume setting and the squelch condition.
 - During scan [TS] can be used only when resume is ON.
- ⑥ To cancel the scan push [(F-1)SCN].

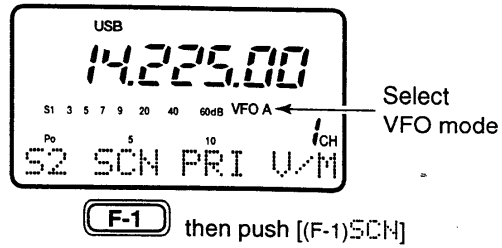

NOTE: If the same frequencies are programmed into the scan edge memory channels P1 and P2, programmed scan does not start.

■ Memory scan operation

- ① Select memory mode.
- ② Close the squelch with [SQL].
- ③ Select S2, then push [(F-1)SCN] to start the scan.
 - Decimal point blinks while scanning.
- ④ When the scan detects a signal, the scan stops or pauses depending on the resume setting.
- ⑤ To cancel the scan push [(F-1)SCN].

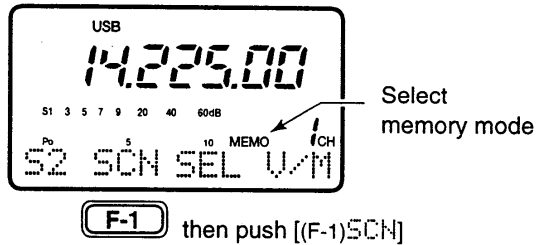

NOTE: 2 or more memory channels must be programmed for memory scan to start.

■ Select memory scan operation

- ① Select memory mode.
- ② Close the squelch with [SQL].
- ③ Select S2, then push [(F-1)SCN] to start the memory scan.
 - Decimal point blinks while scanning.
- ④ Push [(F-2)SEL] to change the memory scan to select memory scan.
- ⑤ When the scan detects a signal, the scan stops or pauses depending on the resume setting.
- ⑥ To cancel the scan push [(F-1)SCN].

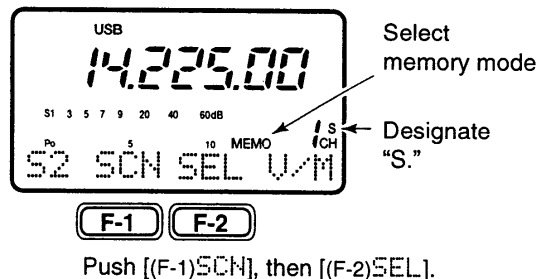

NOTE: 2 or more memory channels must be designated as select memory channels for select memory scan to start.

■ Priority watch

- ① Select VFO mode, then set a frequency.
- ② Close the squelch with [SQL].
- ③ Set the desired memory channel as the watching channel.
- ④ Select S2, then push [(F-2)PRI] to start the watch.
 - Decimal point blinks while scanning.
- ⑤ When the scan detects a signal, the scan pauses for 10 sec. or until the signal disappears, depending on the resume setting.
- ⑥ To cancel the scan push [(F-2)PRI].

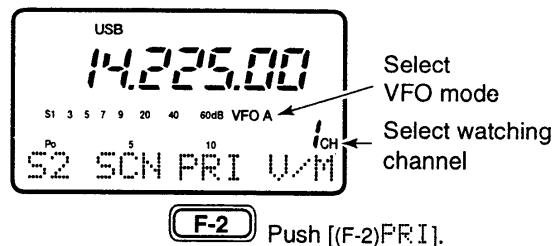

NOTE: The paused condition when detecting a signal differs depending on the scan resume condition.

- resume on: pauses for 10 sec.
- resume off: pauses until the signal disappears.

◆ CI-V connection example

The transceiver can be connected through an optional CT-17 LEVEL CONVERTER to a personal computer equipped with an RS-232C port. The Icom Communication interface-V (CI-V) controls the following functions of the transceiver.

Up to four Icom CI-V transceivers or receivers can be connected to a personal computer equipped with an RS-232C port. See p. 45 for setting the CI-V condition using initial set mode.

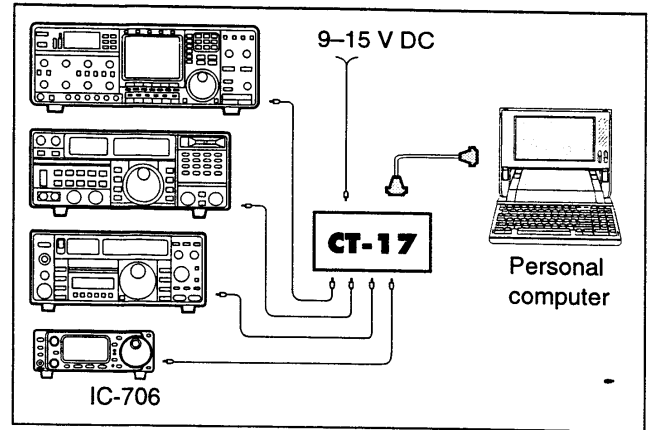

◆ Data format

The CI-V system can be operated using the following data formats. Data formats differ according to command numbers. A data area is added for some commands.

CONTROLLER TO IC-706

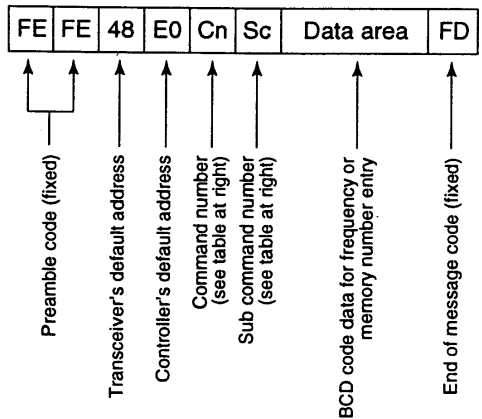

OK MESSAGE TO CONTROLLER

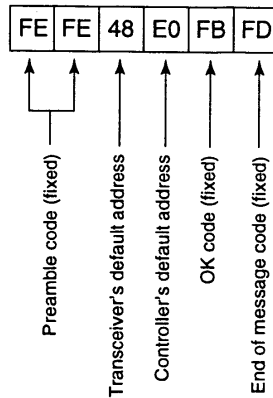

COMMAND TABLE

Description	Cn	Sc	
Frequency control	05	Data	
Operating mode and IF filter control	06	LSB	00**
		USB	01**
		AM	02**
		CW	03**
		RTTY	04**
		FM	05**
WFM	06		
VFO mode		-	
VFO A	07	00	
VFO B		01	
A=B		A0	
A/B		B0	
Memory mode	08	-	
Memory selection		mc**	
Memory write	09	-	
Memory to VFO	0A	-	
Memory clear	0B	-	
Scan stop	0E	00	
Scan start		01	
Split OFF	0F	00	
Split ON		01	
[TS] OFF (10 Hz step)	10	00	
[TS] ON			
100 Hz step		01	
1 kHz step		02	
5 kHz step		03	
9 kHz step		04	
10 kHz step		05	
12.5 kHz step		06	
20 kHz step		07	
25 kHz step	08		
100 kHz step	09		

IC-706 TO CONTROLLER

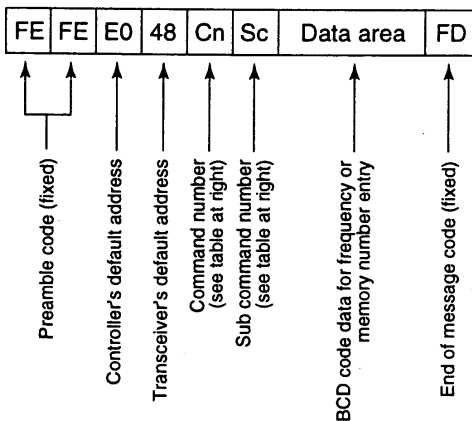

NG MESSAGE TO CONTROLLER

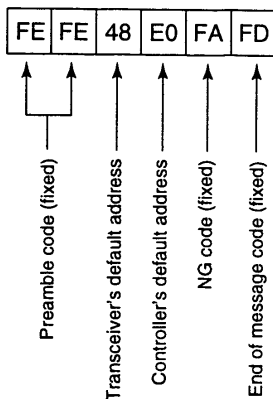

Downloaded by RadioAmateur.EU

**Add "02" to select narrow IF filters.
**Memory channel number (BCD)
P1=0100, P2=0101.

■ General

Set mode is used for programming infrequently changed values or conditions of functions. The IC-706 has 2 separate set modes: *quick set mode* and *initial set mode*.

◇ Quick set mode operation

- ① While power is ON, push [DISP] for 1 sec.
 - Quick set mode is selected and one of its items appears.
 - Quick set mode items vary depending on the operating mode (SSB, FM, etc.) selected.
- ② Push [MENU] one or more times to select the desired item.
 - [UP]/[DN] can also be used.
- ③ Rotate the main dial to set the values or conditions for the selected item.
- ④ Repeat steps ② and ③ to set other items.
- ⑤ To exit quick set mode, push [DISP] momentarily.

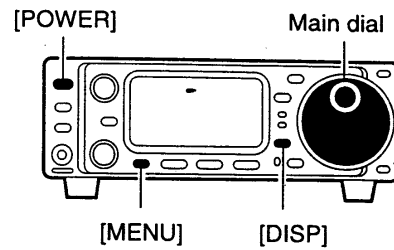

[DISPLAY EXAMPLE: QUICK SET MODE]

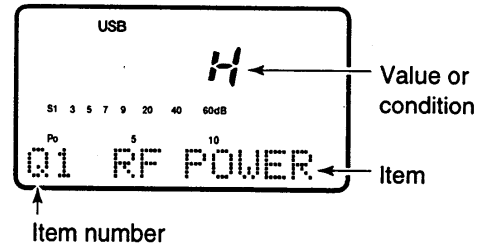

◇ Initial set mode operation

- ① Push [POWER] for 2 sec. to turn power OFF.
- ② While pushing [LOCK] push [POWER] to turn power ON.
 - Initial set mode is selected and one of its items appears.
- ③ Push [MENU] one or more times to select the desired item.
 - [UP]/[DN] can also be used.
- ④ Rotate the main dial to set the values or conditions for the selected item.
- ⑤ Repeat steps ③ and ④ to set other items.
- ⑥ To exit initial set mode, push [POWER] for 2 sec. to turn power OFF.
- ⑦ Push [POWER] to turn power ON again.
 - The conditions selected in initial set mode are now effective.

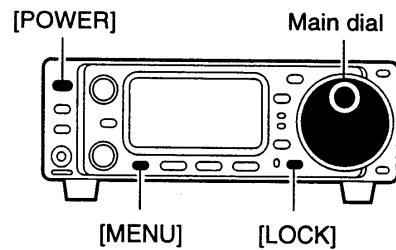

[DISPLAY EXAMPLE: INITIAL SET MODE]

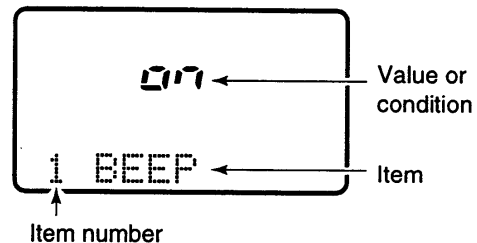

■ Quick set mode items

<p>Q1 RF POWER (all modes)</p> <p>This item adjusts the RF output power. The RF output power can be adjusted from L, 1 to 9 and H for indication, however, it can be adjusted continuously.</p>	<p>H</p>	<p>The default is H (maximum power). Note that while adjusting the output power, the power meter is displayed automatically.</p>
<p>Q2 MIC GAIN (SSB/AM/FM only)</p> <p>This item adjusts microphone gain from 1 to 10 for indication, however, it can be adjusted continuously.</p>	<p>5</p>	<p>The default is 5. Note that while adjusting mic gain, the ALC meter is displayed automatically.</p>
<p>Q2 CW PITCH (CW only)</p> <p>This item adjusts the CW pitch. CW pitch is adjustable from 300 to 900 Hz in 10 Hz steps.</p>	<p>^{CW} 600</p>	<p>The default is 600 Hz.</p>
<p>Q2 RTTY TONE (RTTY only)</p> <p>This item selects the RTTY tone. RTTY tone is toggled between 1615 and 2125 Hz.</p>	<p>^{RTTY} 2125</p>	<p>The default is 2125 Hz.</p>
<p>Q3 VOX DELAY (SSB/AM/FM only)</p> <p>This item adjusts the VOX (Voice-activated Transmit) delay time. The delay time can be adjusted from 0 to 2 sec. in 0.1 sec. units.</p>	<p>^{USB} 1.0</p>	<p>The default is 1.0 seconds.</p>
<p>Q3 BK-IN DELAY (CW only)</p> <p>This item adjusts break-in delay time for CW semi break-in operation. The delay time is selectable from 0 to 2 sec. in 0.1 sec. units.</p>	<p>^{CW} 1.0</p>	<p>The default is 1.0 seconds.</p>
<p>Q3 RTTY SHIFT (RTTY only)</p> <p>This item adjusts the RTTY shift. There are 3 selectable values: 170, 200 and 425 Hz.</p>	<p>^{RTTY} 170</p>	<p>The default is 170 Hz.</p>
<p>Q4 CARRIER FREQ (SSB only)</p> <p>This item adjusts the carrier frequency (BFO frequency), allowing you to change the audio characteristics. Selectable values are -200 to +200 Hz in 10 Hz steps.</p>	<p>^{USB} 0</p>	<p>The default is 0 Hz.</p>
<p>Q4 RTTY KEYING (RTTY only)</p> <p>This item adjusts the RTTY keying. Normal or reverse keying can be selected.</p>	<p>^{RTTY} n</p>	<p>The default is "n," normal. Normal : key open=mark Reverse : key open=space</p>

Q4 FM TONE (FM only)

This item selects a subaudible tone for FM-T mode operation to access a repeater. There are 50 tones available from 67.0 Hz to 254.1 Hz (see table at right).

In addition, there is a 1750 Hz tone burst function available for European repeaters. When "1750" is selected, [(F-3)TON] in M4 transmits a tone burst signal during transmission.

FM
88.5

The default is 88.5 Hz.

•Available subaudible tones

Unit: Hz

67.0	79.7	94.8	110.9	131.8	156.7	171.3	186.2	203.5	229.1
69.3	82.5	97.4	114.8	136.5	159.8	173.8	189.9	206.5	233.6
71.9	85.4	100.0	118.8	141.3	162.2	177.3	192.8	210.7	241.8
74.4	88.5	103.5	123.0	146.2	165.5	179.9	196.6	218.1	250.3
77.0	91.5	107.2	127.3	151.4	167.9	183.5	199.5	225.7	254.1

Q4 CW PADDLE (CW only)

This item adjusts the CW paddle type. Four selections are available.

- n : normal (for electronic keyer use)
- r : reverse (for electronic keyer use)
- oFF : Turns OFF the electronic keyer (for straight key use)
- ud : For using the microphone's [UP]/[DN] keys instead of the CW paddle.

CW

n

The default is "n," normal.

Q5 KEY SPEED (CW only)

This item adjusts the CW key speed. The key speed can be selected from 6 to 60 wpm.

CW

20

The default is 20 wpm.

Q6 RATIO (CW only)

This item adjusts the CW key ratio (or weight). The ratio can be selected from 2.8 to 4.5.

CW

3.0

The default is 3.0.

■ Initial set mode items

1 BEEP (confirmation beep)

A beep sounds each time a switch is pushed to confirm it. This function can be turned OFF for silent operation.

on

Confirmation beep ON
(default)

oFF

Confirmation beep OFF

2 BAND BEEP (band beep)

A beep sounds when an operating frequency enters or exits an amateur band. This functions independent of the confirmation beep setting (above).

on

Band beep ON
(default)

oFF

Band beep OFF

3 AUTO OFF (auto power OFF)

The auto power OFF function can be used to automatically turn the transceiver OFF after a specified time of operation. This item can be set to 20 min., 40 min., 60 min., or OFF.

oFF

Auto power OFF
deactivates. (default)

20

Auto power OFF set to
20 min.

7 SET MODE

4 PEAK HOLD (peak hold)

When the peak hold function is ON, the highest activated segment of the meter remains visible for 0.5 sec.; when OFF, the meter functions normally.

ON

Peak hold ON
(default)

OFF

Peak hold OFF

5 BACK LIGHT (display backlighting)

The function display backlighting can be set to high, low or OFF to suit ambient lighting.

Hi

Display backlighting set to
high (default).

Lo

Display backlighting set to
low.

6 SPEECH LANG (voice synthesiser language)

When the optional UT-102 VOICE SYNTHESISER UNIT is installed, you can select between English and Japanese as the language.

Eng

Voice synthesizer functions
in English (default).

Jpn

Voice synthesizer functions
in Japanese.

7 SPEECH SPD (voice synthesiser speed)

When the optional UT-102 VOICE SYNTHESISER UNIT is installed, you can select between faster or slower synthesiser output.

Hi

Voice synthesizer output
is faster (default).

Lo

Voice synthesizer output
is slower.

8 S-LVL SPCH (S-level speech)

When an optional UT-102 SPEECH SYNTHESISER UNIT is installed, the synthesiser can be set to read out the frequency/mode only, or both the frequency/mode and S-meter level.

ON

Voice synthesizer reads out
both the frequency/mode
and S-meter level (default).

OFF

Voice synthesizer reads out
the frequency/mode only.

9 SCAN RESUME (scan resume)

This item sets the scan resume function ON or OFF. **ON**: scan resumes 10 sec. after stopping on a signal (or 2 sec. after a signal disappears); **OFF**: scan does not resume after stopping on a signal. For the priority watch, setting to OFF pauses the watch until signal disappears and scan resumes.

ON

Scan resume function is
turned ON (default).

OFF

Scan resume function is
turned OFF.

10 SCAN SPEED (scan speed)

This item sets the rate at which channels or frequencies are scanned during scan operations. High or low can be selected.

Hi

Scan speed is set to high
(default).

Lo

Scan speed is set to low.

11 U/D SPEED (up/down speed)

This item sets the rate at which frequencies are scanned through when the [UP]/[DN] switches are pushed and held. High or low can be selected.

Hi

Up/down speed is set to
high (default).

Lo

Up/down speed is set to low.

12 A-TUNE STRT (auto tuner start)

The optional AT-180 ANTENNA TUNER has an automatic start capability which starts tuning if the SWR is higher than 1.5–3.

When “oFF” is selected, the tuner remains OFF even when the SWR is poor (1.5–3).

When “on” is selected, automatic tune starts even when the tuner is turned OFF.

oFF

Auto tune function OFF (default).

on

Auto tune function ON.

NOTE: Even when “on” is selected, automatic tune does not start for the 50 MHz band.

13 PTT TUNE (PTT tune function)

When an optional AH-3 ANTENNA TUNER is connected, tuning can be started automatically at the moment the PTT is pushed.

oFF

Tuning starts only when [TUNER] is pushed (default).

on

Tuning starts when pushing [PTT] on a new frequency.

14 PAD CH (available memo pads)

This item sets the number of memo pad channels available. 5 or 10 memo pads can be set.

5

5 memo pads are available (default).

10

10 memo pads are available.

15 QUICK SPLIT (quick split function)

When this item is set to ON, pushing [SPL] for 2 sec. sets the undisplayed VFO frequency to the displayed VFO frequency plus the split offset or duplex offset, and activates split operation.

on

Quick split function ON (default).

oFF

Quick split function OFF.

16 SPL OFFSET (split offset)

This item sets the offset (difference between transmit and receive frequencies) for the quick split function. Note that this setting is not valid in FM mode.

-4000

Split offset is set to minus (-) 4000 kHz.

4000

Split offset is set to plus (+) 4000 kHz.

17 DUP OFFSET (duplex offset)

This item sets the offset in the same manner as above. However, this setting is used for FM only and is used to input the repeater offset for a desired band.

-4000

Duplex offset is set to minus (-) 4000 kHz.

4000

Duplex offset is set to plus (+) 4000 kHz.

18 SPLIT LOCK (split lock)

When this item is ON the main dial can be used to adjust the transmit frequency (XFC) even while the lock function is activated.

oFF

Split lock function OFF (default)

on

Split lock function ON

19 OPTION FIL (optional filters)

When an optional filter is installed, this selection is necessary, otherwise the filters cannot be selected. Selections available are FL-100, FL-101, FL-103, FL-223 and none (default). See p. 22 for usable filters for each mode and see p. 50 for filter installation.

no

No filters are selected (default).

FL -223

FL-223 (for LSB/USB mode) is selected.

20 RF GAIN (RF gain)

When this item is set to ON, the [RF/SQ] control can be used as the [RF] gain control in USB/LSB, CW/CW-R and RTTY modes and as the [SQL] control in FM and AM modes. When this item is set to OFF, the control functions as the [SQL] control regardless of the operating mode selected.

off

The [RF/SQ] control functions as a squelch control (default).

on

RF gain can be adjusted using the squelch control.

NOTE: Both squelch and RF gain do not function in WFM mode

21 CI-V ADDRES (CI-V address)

To distinguish equipment, each CI-V transceiver has its own Icom standard address in hexadecimal code. The IC-706's address is 48H.

When 2 or more IC-706's are connected to an optional CT-17 CI-V LEVEL CONVERTER, rotate the main dial to select a different address for each IC-706 in the range 01H to 7FH.

48H

Address set to 48H (default).

7FH

Address set to 7FH.

22 CI-V BAUD (CI-V data rate)

This item sets the data transfer rate. When "Aut" is selected, the baud rate is automatically set according to the connected controller or remote controller.

Aut

Auto baud rate (default)

19200

19200 bps

23 CI-V TRN (CI-V transceive)

Transceive operation is possible with the IC-706 connected to other Icom HF transceivers or receivers. When "on" is selected, changing the frequency, operating mode, etc. on the IC-706 automatically changes those of connected transceivers (or receivers) and vice versa.

on

Transceive ON (default)

off

Transceive OFF

24 CI-V 731 (CI-V operating frequency data length)

When connecting the IC-706 to the IC-735 for transceive operation, you must change the operating frequency data length to 4 bytes.

• This item MUST be set to "on" only when operating transceiver with the IC-735.

off

Frequency data set to 5 bytes (default).

on

Frequency data set to 4 bytes.

■ Fuse replacement

If a fuse blows or the transceiver stops functioning, try to find the source of the problem, and replace the damaged fuse with a new, rated fuse.

CAUTION: Disconnect the DC power cable from the transceiver when changing a fuse.

The IC-706 has 2 types of fuses installed for transceiver protection.

- DC power cable fuses 30 A
- Circuitry fuse F.G.M.B. 125 V 4 A

DC POWER CABLE FUSE REPLACEMENT

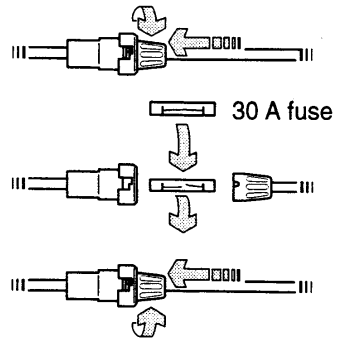

CIRCUITRY FUSE REPLACEMENT

The 13.8 V DC from the DC power cable is applied to all units in the IC-706, except for the power amplifier, through the circuitry fuse. This fuse is installed in the PA unit.

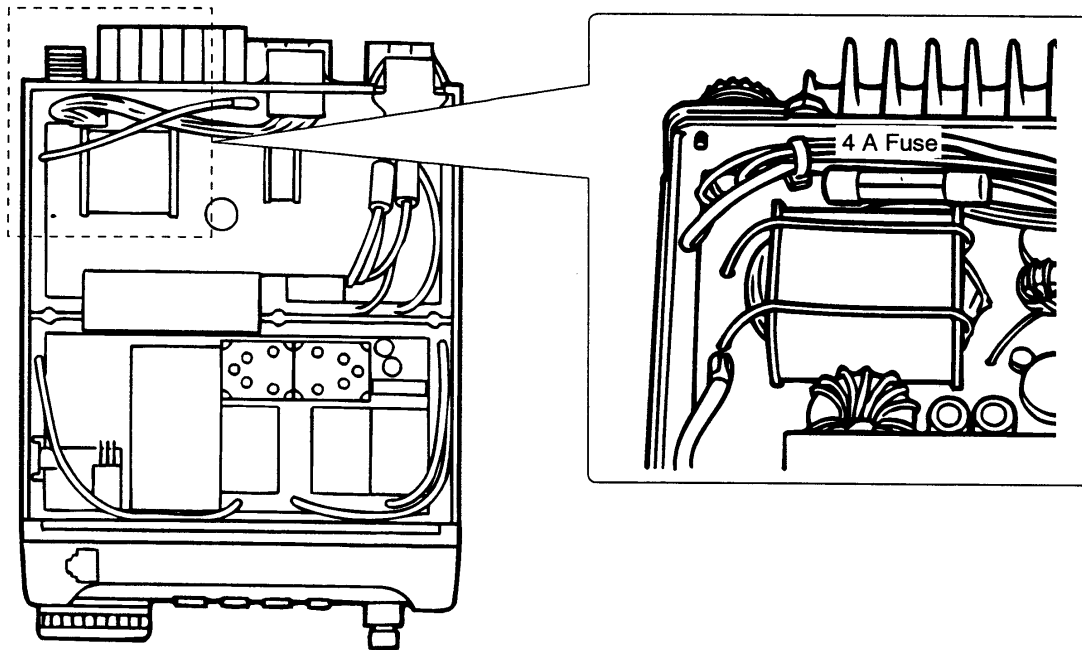

■ Memory backup

All of the CPU's memory is backed up by an EEPROM (Electrically-Erasable Programmable Read-Only Memory). All data you set, such as VFO, memory, set mode contents, etc. is stored in this EEPROM. There is no internal lithium battery.

Downloaded by **RadioAmateur.EU**

■ Cleaning

If the transceiver becomes dusty or dirty, wipe it clean with a dry, soft cloth.



AVOID the use of strong chemical solvents such as thinner, benzine or alcohol to clean the transceiver. These may damage the transceiver's surfaces.

The following chart is designed to help you correct problems which are not equipment malfunctions.

If you are unable to locate the cause of a problem or solve it through the use of this chart, contact your nearest Icom Dealer or Service Center.

	PROBLEM	POSSIBLE CAUSE	SOLUTION	REF.
POWER SUPPLY	Power does not come on when the [POWER] switch is pushed.	<ul style="list-style-type: none"> • DC power cable is improperly connected. • Fuse is blown. 	<ul style="list-style-type: none"> • Reconnect the power cable correctly. • Check for the cause, then replace the fuse with a spare one. (Fuses are installed in two places. One is installed in the DC power cable and the other is installed in the PA unit.) 	<p>p. 13</p> <p>p. 46</p>
		<ul style="list-style-type: none"> • Battery is exhausted if you are using a 12 V battery as the power source. 	<ul style="list-style-type: none"> • Check the battery voltage with the [POWER] pushed IN. 	—
RECEIVE	No sound comes from the speaker.	<ul style="list-style-type: none"> • Volume level is set too low. 	<ul style="list-style-type: none"> • Rotate [AF] clockwise to obtain a suitable listening level. 	p. 1
		<ul style="list-style-type: none"> • The squelch is closed. 	<ul style="list-style-type: none"> • Rotate [SQL] counterclockwise to open the squelch. 	p. 1
		<ul style="list-style-type: none"> • The transceiver is in the transmitting condition. 	<ul style="list-style-type: none"> • Release [PTT] on the microphone or check the SEND line of an external unit, if connected. 	—
		<ul style="list-style-type: none"> • An external speaker or headphones are connected. 	<ul style="list-style-type: none"> • Check the external speaker or headphone plug connection. • Check the speaker ON/OFF switch or speaker A/B switch, when an optional SP-20 EXTERNAL SPEAKER is in use. 	<p>p. 12</p> <p>p. 12</p>
RECEIVE	Sensitivity is low.	<ul style="list-style-type: none"> • The antenna is not connected properly. • The antenna feed line is cut or shorted. 	<ul style="list-style-type: none"> • Reconnect to the antenna connector. • Check the feed line and correct any improper conditions. 	—
		<ul style="list-style-type: none"> • The antenna for another band is selected. 	<ul style="list-style-type: none"> • Select an antenna suitable for the operating frequency. Make sure that [ANT1] is used for frequencies less than 60 MHz and [ANT2] is used for frequencies of 60 MHz and above. 	p. 14
		<ul style="list-style-type: none"> • The antenna is not properly tuned. 	<ul style="list-style-type: none"> • Push [TUNE] to manually tune the antenna. 	pgs. 25, 26
		<ul style="list-style-type: none"> • The attenuator function is activated. 	<ul style="list-style-type: none"> • Push [ATT] to turn the function OFF. 	p. 20
RECEIVE	Receive audio is distorted.	<ul style="list-style-type: none"> • The operating mode is not selected correctly. 	<ul style="list-style-type: none"> • Select a suitable operating mode. 	p. 18
		<ul style="list-style-type: none"> • The [SHIFT] control is set off-center. 	<ul style="list-style-type: none"> • Set [SHIFT] to the center position. 	p. 19
RECEIVE	Receive signal is distorted with strong signals.	<ul style="list-style-type: none"> • Noise blanker function is activated. • Preamp is activated. 	<ul style="list-style-type: none"> • Push [NB] to turn the function OFF. • Push [P.AMP] to turn the function OFF. 	<p>p. 20</p> <p>p. 20</p>

	PROBLEM	POSSIBLE CAUSE	SOLUTION	REF.
TRANSMIT	Transmitting is impossible.	<ul style="list-style-type: none"> The operating frequency is not set to a ham band. The split frequency function is turned ON with different bands in VFO A and VFO B. 	<ul style="list-style-type: none"> Set the frequency to a ham band. Turn OFF the split frequency function. 	<p>p. 17</p> <p>p. 27</p>
	Output power is too low.	<ul style="list-style-type: none"> Power is set to a lower power than maximum. Microphone gain is set too low. The antenna is not connected properly. The antenna feed line is cut or shorted. An antenna for another band is selected. The antenna is not properly tuned. 	<ul style="list-style-type: none"> Set the output power in quick set mode. Set microphone gain to a suitable position using quick set mode. Reconnect the antenna connector. Check the feed line and correct any improper conditions. Select an antenna suitable for the operating frequency. Push [TUNE] to manually tune the antenna when an optional antennal tuner is connected. 	<p>p. 41</p> <p>p. 41</p> <p>—</p> <p>—</p> <p>p. 14</p> <p>pgs. 25, 26</p>
	No contact possible with other stations.	<ul style="list-style-type: none"> RIT function is activated. Split function is activated. 	<ul style="list-style-type: none"> Push RIT to turn the function OFF. Push [SPLIT] to turn the function OFF. 	<p>p. 19</p> <p>p. 27</p>
	Repeater cannot be accessed.	<ul style="list-style-type: none"> Split function is not activated. An incorrect transmit frequency is set. Subaudible tone encoder is OFF and repeater requires a tone for access. Programmed subaudible tone frequency is wrong. 1750 Hz tone burst cannot be transmitted even when [TCH] is pushed during transmission. 	<ul style="list-style-type: none"> Push [SPLIT] to turn the function ON. Set the proper frequencies into VFO A and B or into one of the memory channels. Use [TCH] to select FM-T. Program the required frequency using quick set mode. Set "1750" in quick set mode. 	<p>p. 28</p> <p>p. 17</p> <p>p. 28</p> <p>p. 42</p> <p>p. 42</p>
	Transmitted signals are distorted.	<ul style="list-style-type: none"> Microphone gain is set too high. [COMP LEVEL] is rotated too far clockwise with the speech compressor ON. 	<ul style="list-style-type: none"> Set gain in quick set mode. Set [COMP LEVEL] to a suitable position. 	<p>p. 41</p> <p>p. 5</p>
	Displayed frequency does not change properly.	<ul style="list-style-type: none"> The dial lock function is activated. The internal CPU has malfunctioned. 	<ul style="list-style-type: none"> Push [LOCK] to deactivate the function. Reset the CPU. (While pushing [UP] and [DN] push [POWER] to turn power ON. 	<p>p. 2</p> <p>p. 15</p>
SCAN	Programmed scan does not stop.	<ul style="list-style-type: none"> Squelch is open. 	<ul style="list-style-type: none"> Set squelch to the threshold position. 	<p>p. 21</p>
	Programmed scan does not start.	<ul style="list-style-type: none"> The same frequencies have been programmed in scan edge memory channels P1 and P2. 	<ul style="list-style-type: none"> Program different frequencies into scan edge memory channels P1 and P2. 	<p>p. 38</p>
	Memory scan does not start.	<ul style="list-style-type: none"> 2 or more memory channels have not been programmed. 	<ul style="list-style-type: none"> Program 2 or more memory channels. 	<p>p. 34</p>
	Memory select scan does not start.	<ul style="list-style-type: none"> 2 or more memory channels have not been designated as select channels. 	<ul style="list-style-type: none"> Designate 2 or more memory channels as select channels for the scan. 	<p>p. 38</p>

10 OPTIONAL INSTALLATIONS/SETTINGS

■ Opening the transceiver case

To remove the transceiver case unscrew the 10 screws (5 in the top panel and 5 in the bottom panel) as shown in the diagram below.

CAUTION: DISCONNECT the DC power cable from the transceiver before performing any work on the transceiver.

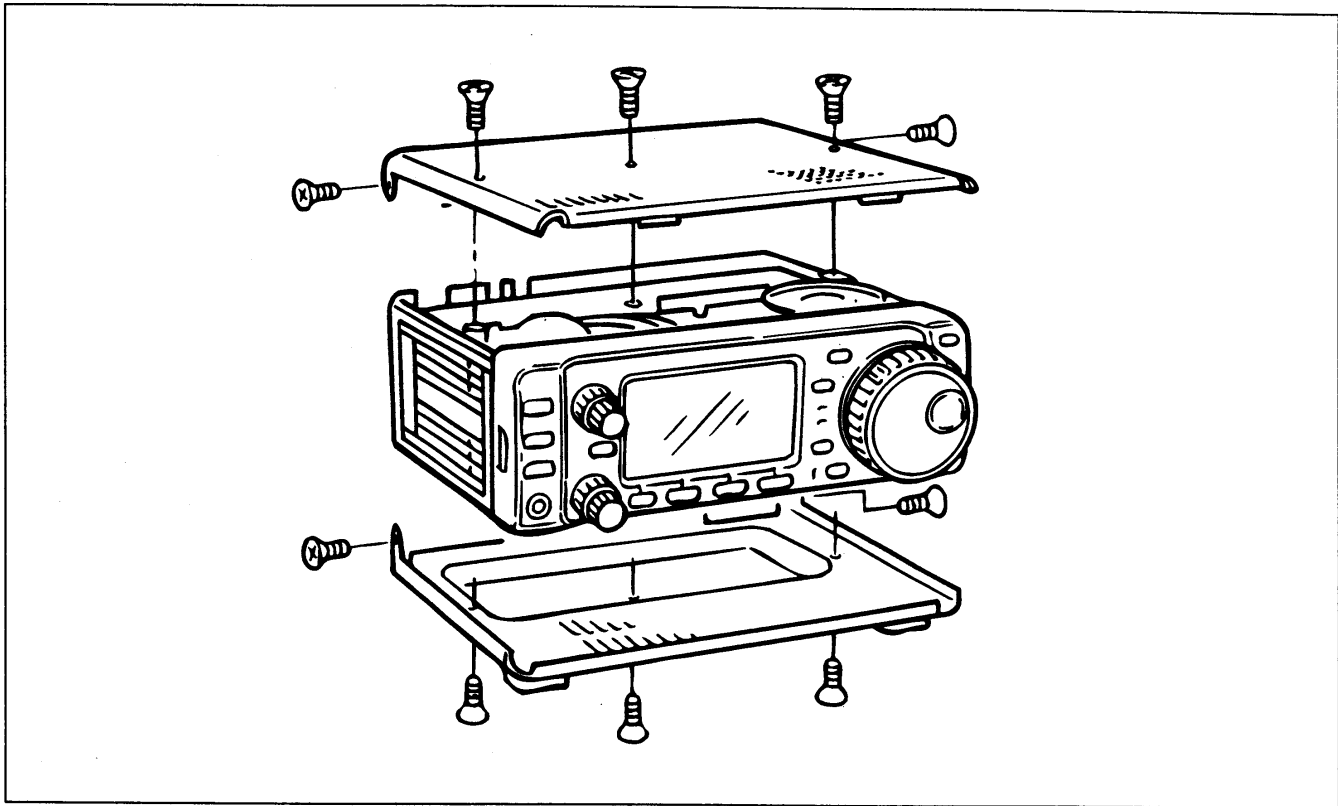

■ UT-102 VOICE SYNTHESIZER UNIT

The UT-102 announces the accessed band's frequency, mode, etc. (S-meter level can also be announced—p. 43) in a clear, electronically generated voice, in English (or Japanese).

- ① Remove the top cover as shown above.
- ② Connect the UT-102 as shown in the diagram at right.
- ③ Replace the top cover.

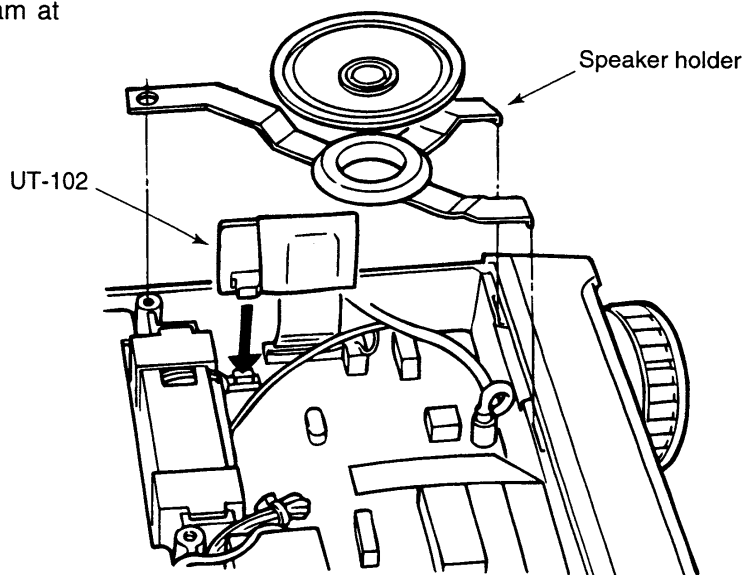

■ CR-502 HIGH-STABILITY CRYSTAL UNIT

By installing the CR-502, the total frequency stability of the transceiver will be improved.

CR-502 frequency stability: ± 0.5 ppm
 (-30°C to +60°C;
 -22°F to +140°F)

- ① Remove the bottom cover as shown on the opposite page.
- ② Cut the leads of R153 and L35 (in a shielded box) on the PLL unit.
- ③ Put the CR-502 in the space available as shown in the diagram, then solder its feet into place (6 points).
- ④ Adjust the reference frequency using a frequency counter.
- ⑤ Return the shield case and bottom cover to their original positions.

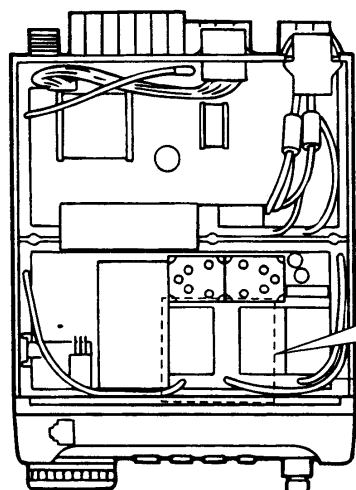

J9 reference freq. check point (60.00 MHz)

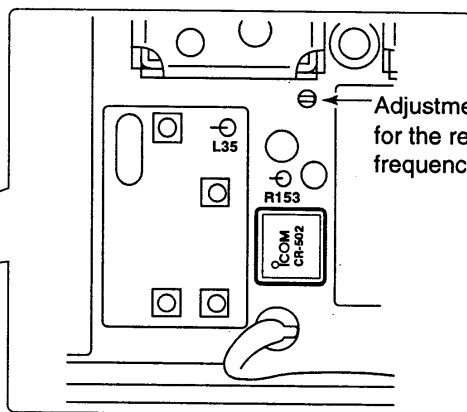

Adjustment point for the reference frequency.

■ IF filters

Several IF filters are available for the IC-706, however, there is only 1 filter space available. Choose a filter most appropriate to your operating needs.

NOTE: After filter installation, specify the installed filter using initial set mode (item 19). Otherwise, the installed filter will not function properly.

FL-100 CW NARROW FILTER	500 Hz/-6 dB
FL-101 CW NARROW FILTER	250 Hz/-6 dB
FL-103 SSB WIDE FILTER	2.8 kHz/-6 dB
FL-223 SSB NARROW FILTER	1.9 kHz/-6 dB

- ① Remove the top cover as shown on the opposite page.
- ② Install the desired filter as shown in the diagram below.
 - These filters can be installed in either direction.
- ③ Replace the top cover.

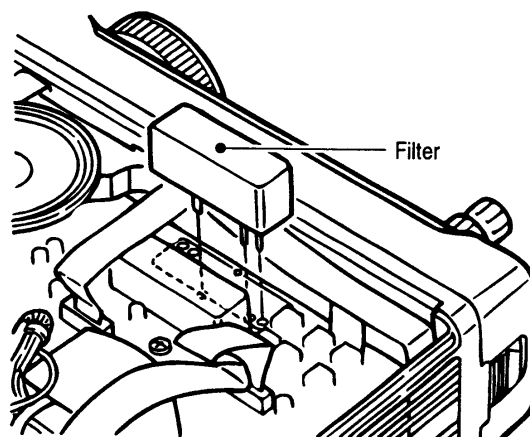

Filter

■ AT-180 internal switch description

The optional AT-180 has 3 operating conditions for HF band operation. Select a suitable condition according to your antenna system.

- ① Remove the top cover of the AT-180.
- ② Set the tuner switches to the desired positions according to the table below.

SW	Position	Operation
S1	A (default)	The tuner operating condition is set by S2 described below.
	B	<i>THROUGH INHIBIT</i> The tuner tunes the antenna even when the antenna has poor SWR (up to VSWR 3:1 after tuning). In this case, manual tuning is necessary each time you change the frequency although the tuner automatically starts tuning when the VSWR is higher than 3:1. This setting is called "THROUGH INHIBIT," however, the tuner is set to "THROUGH," if the VSWR is higher than 3:1 after tuning.
S2	C	<i>TUNER SENSITIVE CONDITION</i> The tuner tunes each time you transmit (except SSB mode). Therefore, the lowest SWR is obtained at any given time. For SSB mode, the same condition as the "D" position.
	D (default)	<i>NORMAL CONDITION</i> The tuner tunes when the SWR is higher than 1.5:1. Therefore, the tuner activates only when tuning is necessary.

• AT-180 inside top cover

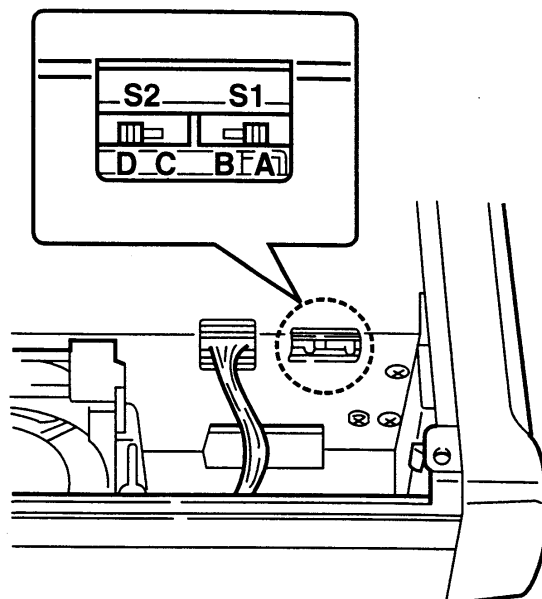

• Specifications for the AT-180

- Frequency coverage : 1.9–54 MHz
- Input impedance : 50 Ω
- Maximum input power : 120 W
- Minimum tuning power : 8 W
- Matching impedance : 16.7–150 Ω (HF band)
range 20–125 Ω (50 MHz band)
- Tuning accuracy : Less than SWR 1.5:1
- Insertion loss : Less than 1.0 dB
(after tuning)
- Power supply requirements : 13.8 V DC/1 A (supplied from the transceiver's ACC socket)
- Dimensions (mm/in) : 167(W) x 58.6(H) x 225(D)
6⁹/₁₆(W) x 2⁵/₁₇(H) x 8⁷/₈(D)
- Weight : 2.4 kg; 5 lb 4 oz
- Supplied accessories : coaxial cable (1 m),
ACC cable (DIN 13 pins)

◇ Top view

CAUTION:
The transceiver has been thoroughly tested and adjusted at the factory before being shipped. The transceiver warranty does not cover any problems caused by unauthorized internal adjustment.

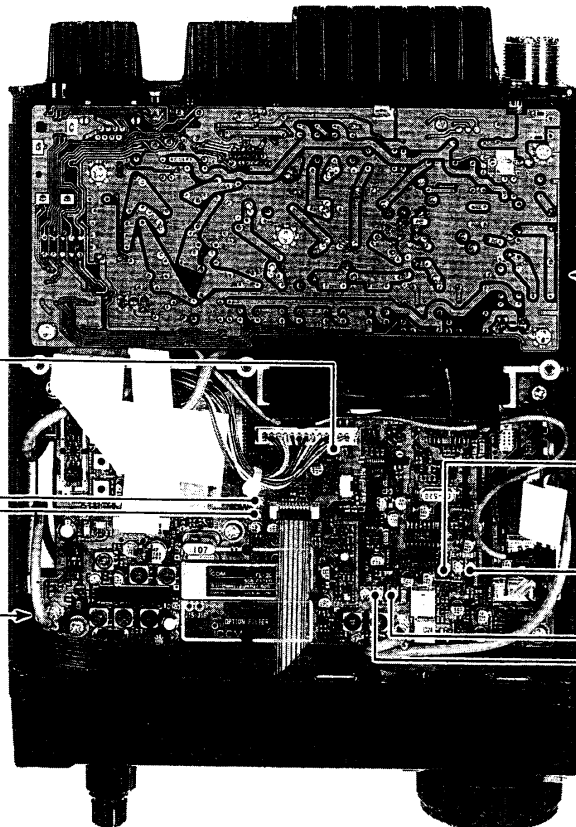

144 MHz Tx power adj. (R338)

50 MHz Tx power adj. (R98)

HF Tx power adj. (R95)

MAIN unit

FILTER unit

FM max. deviation (R274)
(MIC GAIN: 5, 100 mV input)

FM 3.5 kHz deviation (R260)
(MIC GAIN: 5, 10 mV input)

R193 } carrier suppression
R191 }

This photo was taken with the internal speaker removed.

◇ Bottom view

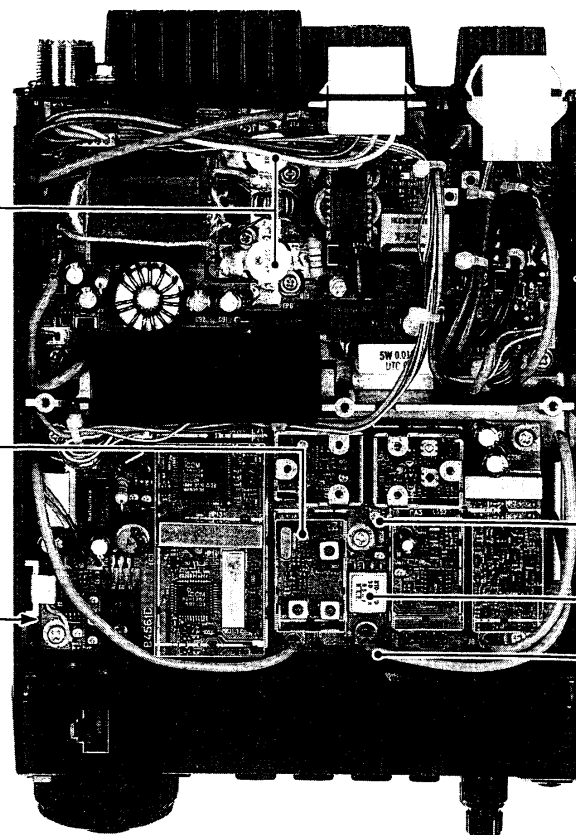

Final amplifier
(MRF255 x 2)

Reference freq. adj. (L34)
(when no optional crystal is installed)

PLL unit

PA unit

Reference freq. adj. (R60)
(when optional crystal is installed)

Optional crystal (CR-502)

Reference freq. check point
(cable from J9; 60.000 MHz)

IC-4KL HF 1 kW LINEAR AMPLIFIER

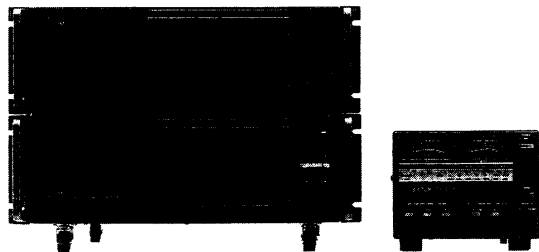

Full-duty 1 kW linear amplifier including an automatic antenna tuner. Has automatic tuning and band selection capability. Full break-in (QSK) operation is possible. The amplifier/power supply unit and the remote control unit are separated. The OPC-599 is necessary to connect the IC-706 to the IC-4KL.

AT-180 HF/50 MHz AUTOMATIC ANTENNA TUNER



Fully automatic antenna tuner with preset memories for each 100 kHz. Unique "automatic tuner on" function is available. See p. 51 for AT-180 specifications.

AH-3 HF AUTOMATIC ANTENNA TUNER

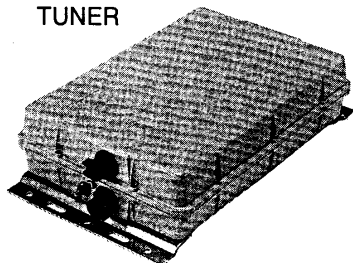

Specially designed to tune a long wire antenna for portable or mobile HF operation. The "PTT tune" function provides simple operation.

- Input power rating: 150 W

AH-2b ANTENNA ELEMENT



A 2.5 m long antenna element for mobile operation with the AH-3.

- Frequency coverage 3.5–28 MHz band with the AH-3

EX-627 AUTOMATIC ANTENNA SELECTOR

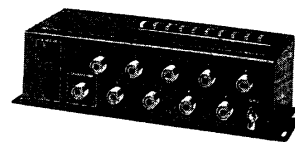

Automatically selects the antenna for the selected HF ham band. Manual selection is possible for the 50 MHz band.

- Max. input power: 100 W PEP

PS-85 DC POWER SUPPLY

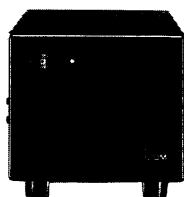

Light weight switching regulator system power supply.

- Output voltage: 13.8 V DC
- Max. current drain: 20 A

SM-8 DESKTOP MICROPHONE



Including 2 connection cables for simultaneous connection of 2 transceivers. Has [UP]/[DOWN] switches. The OPC-589 is necessary to use this microphone.

SM-20 DESKTOP MICROPHONE



Includes [UP]/[DOWN] switches and a low cut function. The OPC-589 is necessary to use this microphone.

MB-62 MOBILE MOUNTING BRACKET

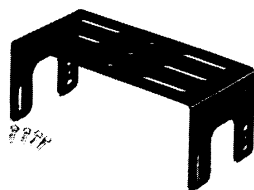

Mounts the transceiver main body, with or without the front panel, inside a vehicle.

MB-63 MOUNTING BRACKET



Metal plate for attaching the front panel to a wall or other such flat surface.

SP-21 EXTERNAL SPEAKER

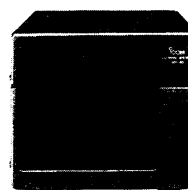

External speaker designed for base station operation.

- Input impedance: 8 Ω
- Max. input power: 5 W

SP-20 EXTERNAL SPEAKER

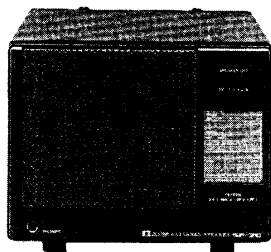

Equipped with 4 types of audio filters, a headphone jack and can be connected to 2 transceivers.

- Input impedance: 8 Ω
- Max. input power: 5 W

**SP-12 EXTERNAL SPEAKER
SP-10 EXTERNAL SPEAKER**

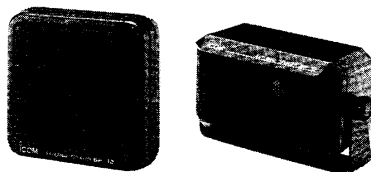

SP-12 SP-10

External speakers suitable for mobile operation.

- SP-12: Slim-type; 8 Ω/3 W
- SP-10: Compact-type; 4 Ω/5 W

SP-7 EXTERNAL SPEAKER

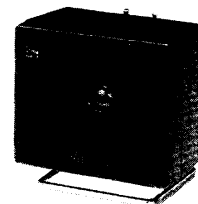

Compact speaker for base station operation. Height can be adjusted for your convenience.

- Input impedance: 8 Ω
- Max. input power: 5 W

CT-16 SATELLITE INTERFACE UNIT

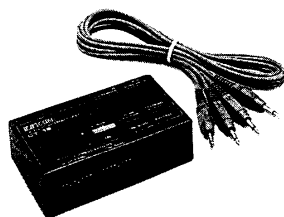

Easy tuning when connecting another Icom VHF transceiver for instant satellite communications.

CT-17 CI-V LEVEL CONVERTER UNIT

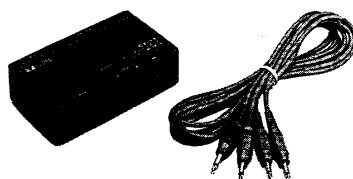

For remote transceiver control using a personal computer equipped with an RS-232C port. You can change frequencies, operating mode, memory channels, etc., via your computer.

OPC-581 SEPARATION CABLE

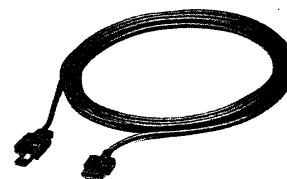

Provides front panel detached operation for mobile installations or compact transceiver operation.

- Cable length: 3.5 m (11.5 ft)

OPC-589 MICROPHONE ADAPTER CABLE



Conversion between 8-pin modular and 8-pin metal connector for using a desktop microphone with the IC-706.

FL-100 CW NARROW FILTER (500 Hz/−6 dB)

FL-101 CW NARROW FILTER (250 Hz/−6 dB)

FL-103 SSB WIDE FILTER (2.8 kHz/−6 dB)

FL-223 SSB NARROW FILTER (1.9 kHz/−6 dB)

CR-502 HIGH-STABILITY CRYSTAL UNIT

Digitally controlled TCXO for improved frequency stability.

- Frequency stability: ±0.5 ppm
- (−30°C to +60°C; −22°F to +140°F)

UT-102 VOICE SYNTHESIZER UNIT

OPC-599 ADAPTER CABLE

13-pin, ACC connector to 7-pin + 8-pin ACC connector.

13 SPECIFICATIONS

■ GENERAL

- Frequency coverage : Receive
 - 300 kHz–200 MHz
 - Range restricted in some versions
 - Specifications guaranteed:
 - 500 kHz–29.995 MHz*
 - 50 MHz–54 MHz
 - 144 MHz–148 MHz
 - *Except out-of-ham range.
- Transmit
 - 1.800–1.9999 MHz*¹
 - 3.500–3.9999 MHz*²
 - 7.000–7.300 MHz*³
 - 10.100–10.150 MHz
 - 14.000–14.350 MHz
 - 18.068–18.168 MHz
 - 21.000–21.450 MHz
 - 24.890–24.990 MHz
 - 28.000–29.700 MHz
 - 50.000–54.000 MHz*⁴
 - 144.000–148.000 MHz*⁵
 - *¹1.810–1.850 MHz France version
 - *²3.500–3.800 MHz France version
 - *³7.000–7.100 MHz France version
 - *⁴50.000–52.000 MHz Denmark version
 - *⁵144.000–146.000 MHz all European versions
- Mode : SSB, CW, AM, FM, WFM, RTTY
(WFM is for receive only)
- Number of memory : 102 (split memory: 99; scan edge: 2; channels call channel: 1)
- Antenna impedance : 50 Ω nominal
- Usable temperature : –10°C to +60°C (+14°F to +140°F) range
- Frequency stability : Less than ±7 ppm from 1 min. to 60 min. after power ON. After that, rate of stability change is less than ±1 ppm/hr. at +25°C (+77°F). Temperature fluctuations (0°C to +50°C; +32°F to +122°F) less than ±5 ppm.
- Power supply requirement : 13.8 V DC ±15% (20 A)
- Current drain : Transmit 20 A
Receive squelched 1.5 A
max. audio 1.7 A
- Dimensions : 167(W) x 58(H) x 200(D) mm
6⁹/₁₆(W) x 2⁹/₃₂(H) x 7⁷/₈(D) in
(projections not included)
- Weight : 2.5 kg (5.5 lb)

■ TRANSMITTER

- Output power :
 - HF SSB, CW, FM, RTTY 5–100 W
 - AM 2–40 W
 - 50 MHz SSB, CW, FM, RTTY 5–100 W
 - AM 2–40 W
 - 144 MHz SSB, CW, FM, RTTY 1–10 W
 - AM 1–4 W
- Spurious emissions :
 - HF Less than –50 dB
 - 50 MHz Less than –60 dB
 - 144 MHz Less than –60 dB
- Carrier suppression : More than 40 dB
- Unwanted sideband : More than 50 dB
- Microphone impedance : 600 Ω

■ RECEIVER

- Receive system :
 - SSB, CW, AM, RTTY Double-conversion superheterodyne FM
 - WFM Triple-conversion superheterodyne
- Intermediate frequencies:

MODE	1st	2nd	3rd
SSB	69.0115 MHz	9.0115 MHz	—
AM	69.0100 MHz	9.0100 MHz	—
CW/RTTY	69.0106 MHz	9.0106 MHz	—
FM	69.0115 MHz	9.0115 MHz	455 kHz
WFM	70.7000 MHz	10.7000 MHz	—

- Sensitivity (pre-amp ON):
 - SSB, CW 1.8–29.9950 MHz*
(for 10 dB S/N) Less than 0.16 μV
 - 50–54 MHz Less than 0.16 μV
 - 144–148 MHz Less than 0.16 μV
 - AM 0.5–1.8 MHz
(for 10 dB S/N) Less than 13.0 μV
 - 1.8–29.9950 MHz* Less than 2.0 μV
 - 50–54 MHz Less than 2.0 μV
 - 144–148 MHz Less than 2.0 μV
 - FM 28.0–29.7 MHz
(for 12 dB SINAD) Less than 0.5 μV
 - 50–54 MHz Less than 0.3 μV
 - 144–148 MHz Less than 0.3 μV
 - WFM 76–108 MHz
(for 12 dB SINAD) Less than 10.0 μV
- *Some frequency ranges outside of the ham bands are not guaranteed.
- Squelch sensitivity (pre-amp ON) :
 - SSB Less than 5.6 μV at threshold
 - FM Less than 0.3 μV at threshold
- Selectivity :
 - SSB, CW More than 2.3 kHz/–6 dB
 - Less than 4.0 kHz/–60 dB
 - AM More than 6.0 kHz/–6 dB
 - Less than 20.0 kHz/–40 dB
 - FM More than 12.0 kHz/–6 dB
 - Less than 30.0 kHz/–50 dB
 - FM narrow More than 8.0 kHz/–6 dB
- Spurious and image : More than 70 dB (HF bands only) rejection ratio
- Audio output power : More than 2.0 W at 10% distortion with an 8 Ω load
- RIT variable range : ±1.0 kHz max.

Downloaded by
RadioAmateur.EU

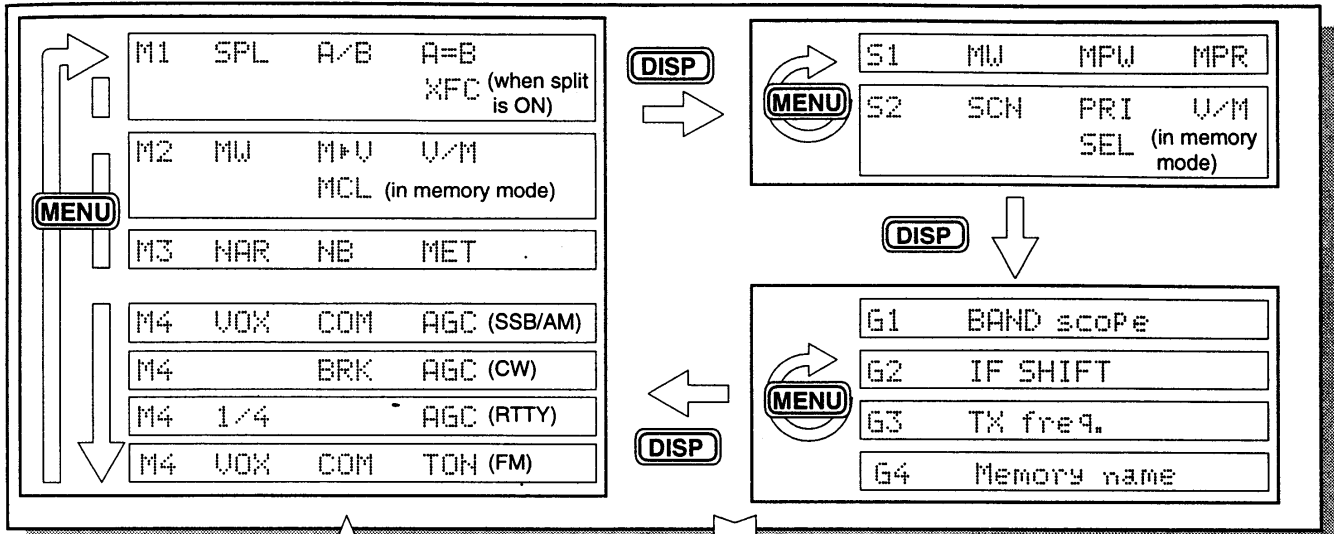

DISP
DISP For 2 sec.

Quick set mode

No.	SSB/AM/FM mode	CW mode	RTTY mode
Q1	RF POWER	RF POWER	RF POWER
Q2	MIC GAIN	CW PITCH	RTTY TONE
Q3	VOX DELAY	BK-IN DELAY	RTTY SHIFT
Q4	SSB only: CARRIER Freq FM only: FM TONE	CW PADDLE	RTTY KEYING
Q5	---	KEY SPEED	---
Q6	---	RATIO	---

LOCK + power ON
Power OFF then ON to exit initial set mode.

Initial set mode



No.	Indication	Description	No.	Indication	Description
1	BEEP	Confirmation beeps	13	PTT TUNE	PTT tune function
2	BAND BEEP	Band edge beeps	14	PAD CH	No. of memory pads
3	AUTO OFF	Auto power OFF function	15	QUICK SPLIT	Quick split function
4	PEAK HOLD	Meter peak function	16	SPL OFFSET	Quick split offset
5	BACK LIGHT	Display backlighting	17	DUP OFFSET	Duplex offset
6	SPEECH LANG	Speech synthesizer lang.	18	SPLIT LOCK	Split lock function
7	SPEECH SPD	Speech synthesizer speed	19	OPTION FIL	Optional filter selection
8	S-LVL SPCH	Speech synthesizer S-meter	20	RF GAIN	RF gain control
9	SCAN RESUME	Scan resume condition	21	CI-V ADDRES	CI-V address assignment
10	SCAN SPEED	Scanning speed	22	CI-V BAUD	Data transfer rate
11	U/D SPEED	[UP]/[DN] speed	23	CI-V TRN	CI-V transceive
12	A-TUNE START	Auto tune start function	24	CI-V 731	CI-V 731

Count on us!

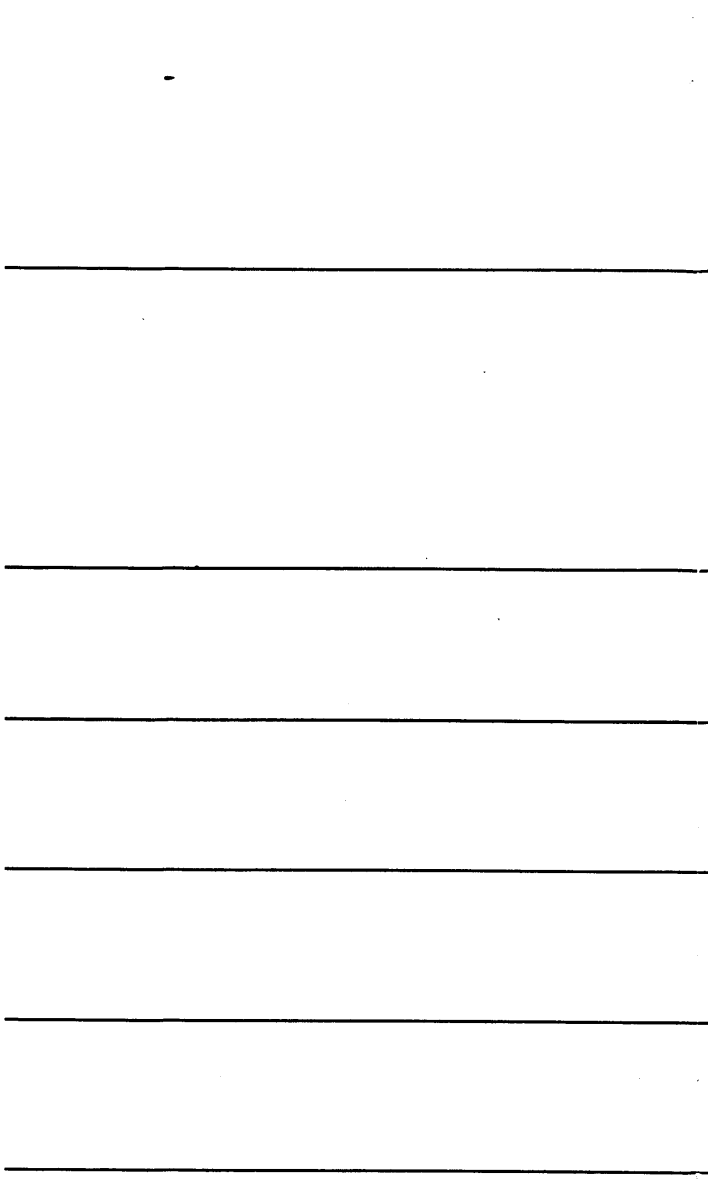
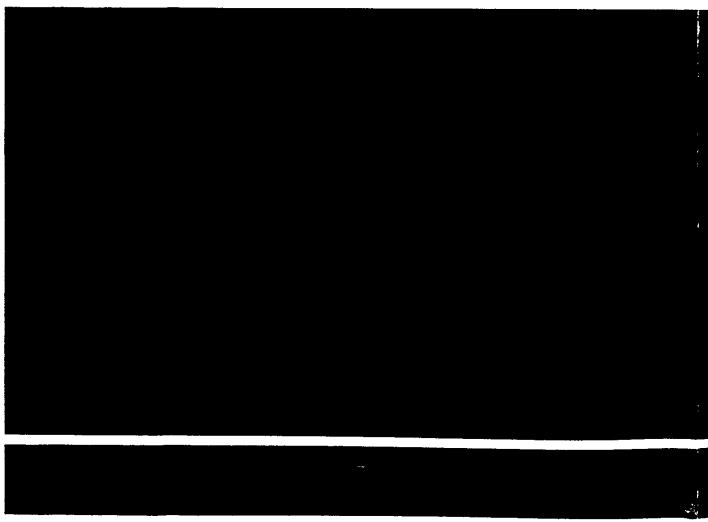

Downloaded by
RadioAmateur.EU