



INSTRUCTION MANUAL

HF/50 MHz TRANSCEIVER **IC-7200**



IMPORTANT

READ THIS INSTRUCTION MANUAL CAREFULLY before attempting to operate the transceiver.

SAVE THIS INSTRUCTION MANUAL. This manual contains important safety and operating instructions for the IC-7200.

FOREWORD

We understand that you have a choice of many different radios in the market place. We want to take a couple of moments of your time to thank you for making the IC-7200 your radio of choice, and hope you agree with Icom's philosophy of "technology first." Many hours of research and development went into the design of your IC-7200.

◆ FEATURES

- IF DSP features
- Digital Twin PBT
- Manual notch function
- ± 0.5 ppm of high frequency stability
- Simple operation
- Tough and compact body
- Standard voice synthesizer

EXPLICIT DEFINITIONS

| WORD | DEFINITION |
|------------------|---|
| ⚠ WARNING | Personal injury, fire hazard or electric shock may occur. |
| CAUTION | Equipment damage may occur. |
| NOTE | If disregarded, inconvenience only. No risk of personal injury, fire or electric shock. |

Icom, Icom Inc. and the ICOM logo are registered trademarks of Icom Incorporated (Japan) in the United States, the United Kingdom, Germany, France, Spain, Russia and/or other countries. Microsoft, Windows and Windows Vista are either registered trademarks or trademarks of Microsoft Corporation in the United States and/or other countries. All other products or brands are registered trademarks or trademarks of their respective holders.

SUPPLIED ACCESSORIES

The transceiver comes with the following accessories.

| | Qty. |
|--|------|
| ① Hand microphone (HM-36) | 1 |
| ② DC power cable (OPC-1457) | 1 |
| ③ Spare fuse (ATC 5 A) | 1 |
| ④ Spare fuse (ATC 30 A) | 2 |
| ⑤ ACC cable | 1 |
| ⑥ 3.5 (d) mm plug | 1 |
| ⑦ 6.3 (d) mm Electronic keyer plug | 1 |
| ⑧ Microphone hanger | 1 |
| ⑨ Jack cap (for [PHONES]) | 1 |

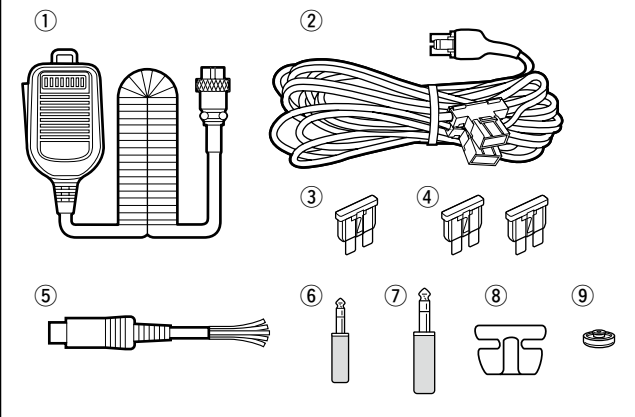

FCC INFORMATION

• FOR CLASS B UNINTENTIONAL RADIATORS:

This equipment has been tested and found to comply with the limits for a Class B digital device, pursuant to part 15 of the FCC Rules. These limits are designed to provide reasonable protection against harmful interference in a residential installation. This equipment generates, uses and can radiate radio frequency energy and, if not installed and used in accordance with the instructions, may cause harmful interference to radio communications. However, there is no guarantee that interference will not occur in a particular installation. If this equipment does cause harmful interference to radio or television reception, which can be determined by turning the equipment off and on, the user is encouraged to try to correct the interference by one or more of the following measures:

- Reorient or relocate the receiving antenna.
- Increase the separation between the equipment and receiver.
- Connect the equipment into an outlet on a circuit different from that to which the receiver is connected.
- Consult the dealer or an experienced radio/TV technician for help.

PRECAUTIONS

⚠ **WARNING RF EXPOSURE!** This device emits Radio Frequency (RF) energy. Extreme caution should be observed when operating this device. If you have any questions regarding RF exposure and safety standards please refer to the Federal Communications Commission Office of Engineering and Technology's report on Evaluating Compliance with FCC Guidelines for Human Radio Frequency Electromagnetic Fields (OET Bulletin 65).

⚠ **WARNING HIGH VOLTAGE! NEVER** touch an antenna or internal antenna connector during transmission. This may result in an electrical shock or burn.

⚠ **WARNING! NEVER** operate the transceiver while driving a vehicle. Safe driving requires your full attention—anything less may result in an accident.

⚠ **NEVER** apply AC power to the [DC13.8V] socket on the transceiver rear panel. This could cause a fire or damage the transceiver.

⚠ **NEVER** apply more than 16 V DC, such as a 24 V battery, to the [DC13.8V] socket on the transceiver rear panel. This could cause a fire or damage the transceiver.

⚠ **NEVER** let metal, wire or other objects touch any internal part or connectors on the rear panel of the transceiver. This may result in an electric shock or this could cause a fire or damage the transceiver.

⚠ **NEVER** expose the transceiver to rain, snow or any liquids.

DO NOT use or place the transceiver in areas with temperatures below -10°C ($+14^{\circ}\text{F}$) or above $+60^{\circ}\text{C}$ ($+140^{\circ}\text{F}$). Be aware that temperatures on a vehicle's dashboard can exceed $+80^{\circ}\text{C}$ ($+176^{\circ}\text{F}$), resulting in permanent damage to the transceiver if left there for extended periods.

DO NOT place the transceiver in excessively dusty environments or in direct sunlight.

DO NOT place the transceiver against walls or put anything on top of the transceiver. This will obstruct heat dissipation.

Place unit in a secure place to avoid inadvertent use by children.

During mobile operation, **NEVER** place the transceiver where air bag deployment may be obstructed.

During mobile operation, **DO NOT** place the transceiver where hot or cold air blows directly onto it.

During mobile operation, **DO NOT** operate the transceiver without running the vehicle's engine. When the transceiver's power is ON and your vehicle's engine is OFF, the vehicle's battery will quickly become exhausted.

Make sure the transceiver power is OFF before starting the vehicle engine. This will avoid possible damage to the transceiver by ignition voltage spikes.

During maritime mobile operation, keep the transceiver and microphone as far away as possible from the magnetic navigation compass to prevent erroneous indications.

BE CAREFUL! The rear panel will become hot when operating the transceiver continuously for long periods.

BE CAREFUL! If a linear amplifier is connected, set the transceiver's RF output power to less than the linear amplifier's maximum input level, otherwise, the linear amplifier will be damaged.

Use Icom microphones only (supplied or optional). Other manufacturer's microphones have different pin assignments, and connection to the IC-7200 may damage the transceiver.

For U.S.A. only

Caution: Changes or modifications to this transceiver, not expressly approved by Icom Inc., could void your authority to operate this transceiver under FCC regulations.

TABLE OF CONTENTS

| | |
|---|--------------|
| IMPORTANT | i |
| FOREWORD | i |
| EXPLICIT DEFINITIONS | i |
| SUPPLIED ACCESSORIES | i |
| FCC INFORMATION | i |
| PRECAUTIONS | ii |
| TABLE OF CONTENTS | iii-iv |
| 1 PANEL DESCRIPTION | 1-11 |
| ■ Front panel | 1 |
| ◇ Keypad | 5 |
| ■ Function display | 7 |
| ■ Rear panel..... | 9 |
| ◇ ACC socket information | 10 |
| ■ Microphones..... | 11 |
| ◇ HM-36 | 11 |
| ◇ SM-20 | 11 |
| 2 INSTALLATION AND CONNECTIONS | 12-20 |
| ■ Unpacking | 12 |
| ■ Selecting a location | 12 |
| ■ Grounding | 12 |
| ■ Antenna connection | 12 |
| ■ Required connections..... | 13 |
| ■ Advanced connections | 14 |
| ■ Power supply connections..... | 15 |
| ■ Connecting the DC Power Supply | 15 |
| ■ Battery connections..... | 15 |
| ■ External antenna tuners | 16 |
| ■ Linear amplifier connections..... | 17 |
| ■ Connections for CW | 18 |
| ■ Connections for RTTY | 19 |
| ◇ Connections for RTTY (FSK) | 19 |
| ◇ Connections for RTTY (AFSK)..... | 19 |
| ■ Connections for SSTV or PSK31 | 20 |
| ◇ When connecting to the [ACC] socket..... | 20 |
| ◇ When connecting to the [MIC] connector | 20 |
| ◇ When connecting to the [USB] jack..... | 20 |
| 3 BASIC OPERATION | 21-32 |
| ■ Before first applying power | 21 |
| ■ Applying power (CPU resetting) | 21 |
| ■ VFO description..... | 22 |
| ■ VFO operation | 22 |
| ◇ Selecting the VFO A/B | 22 |
| ◇ VFO equalization..... | 22 |
| ■ Selecting VFO/memory mode | 23 |
| ◇ Differences between VFO mode and | |
| memory mode | 23 |
| ■ Selecting an operating band | 24 |
| ◇ Using the band stacking register..... | 24 |
| ■ Frequency setting..... | 25 |
| ◇ Using the main dial | 25 |
| ◇ Direct frequency entry with keypad..... | 25 |
| ◇ Programmable tuning steps | 26 |
| ◇ Selecting the programmable tuning step..... | 26 |
| ◇ 1 Hz and 10 Hz tuning steps..... | 27 |
| ◇  switch flow chart | 27 |
| ◇ Auto tuning step function | 28 |
| ◇ ¼ tuning function | |
| (SSB data/CW/RTTY only) | 28 |
| ◇ Band edge warning beep | 28 |
| ■ Volume setting | 29 |
| ■ Operating mode selection | 29 |
| ■ Dial lock function | 29 |
| ■ RF gain and Squelch..... | 30 |
| ■ Meter function | 30 |
| ■ Basic transmit operation..... | 31 |
| ◇ Transmitting..... | 31 |
| ◇ Output power and Microphone gain settings... | 31 |
| ■ Voice synthesizer function..... | 32 |
| 4 RECEIVE AND TRANSMIT | 33-43 |
| ■ Operating SSB | 33 |
| ◇ Convenient functions for receive | 33 |
| ◇ Convenient functions for transmit..... | 34 |
| ◇ About 5 MHz band operation | |
| (USA version only) | 34 |
| ■ Operating CW | 35 |
| ◇ Convenient functions for receive | 36 |
| ◇ Convenient functions for transmit..... | 36 |
| ◇ CW reverse mode | 37 |
| ◇ CW pitch control..... | 37 |
| ◇ CW side tone function..... | 38 |
| ◇ Keying speed setting..... | 38 |
| ■ Operating RTTY (FSK)..... | 39 |
| ◇ Convenient functions for receive | 39 |
| ◇ RTTY reverse mode | 40 |
| ◇ Twin peak filter | 40 |
| ◇ RTTY decode set mode | 41 |
| ■ Operating AM | 42 |
| ◇ Convenient functions for receive | 42 |
| ◇ Convenient functions for transmit..... | 42 |
| ■ Data mode (SSTV/PSK31) operation..... | 43 |

| | | | |
|--|--------------|---|--------------|
| 5 FUNCTIONS FOR RECEIVE..... | 44–52 | 9 ANTENNA TUNER OPERATION | 67–69 |
| ■ RIT function..... | 44 | ■ Optional AT-180 AUTOMATIC ANTENNA TUNER | |
| ■ Preamp and attenuator | 45 | operation | 67 |
| ■ AGC function..... | 45 | ◇ Tuner operation | 67 |
| ◇ AGC time constant selection..... | 45 | ◇ Manual tuning | 67 |
| ■ Twin PBT operation | 46 | ■ AT-180 internal switch description | 68 |
| ■ IF filter selection | 47 | ■ Optional AH-4 AUTOMATIC ANTENNA TUNER | |
| ◇ IF filter selection..... | 47 | operation | 69 |
| ◇ Filter passband width setting | 48 | ◇ AH-4 operation..... | 69 |
| ◇ IF filter shape (SSB/CW only)..... | 48 | 10 SET MODE | 70–82 |
| ■ Noise blanker | 49 | ■ General | 70 |
| ◇ Noise blanker settings..... | 49 | ◇ Quick set mode operation | 70 |
| ■ Noise reduction | 50 | ◇ Set mode operation..... | 70 |
| ◇ Noise reduction level setting | 50 | ■ Quick set mode | 71 |
| ■ Notch function | 51 | ■ Set mode..... | 74 |
| ◇ Auto notch function | 51 | ◇ Paddle operation from [MIC] connector | 82 |
| ◇ Manual notch function..... | 51 | 11 MAINTENANCE | 83–84 |
| ◇ Manual notch filter setting | 52 | ■ Fuse replacement | 83 |
| 6 FUNCTIONS FOR TRANSMIT | 53–60 | ◇ DC power cable fuse replacement..... | 83 |
| ■ VOX function..... | 53 | ◇ Circuitry fuse replacement | 83 |
| ◇ Adjusting the VOX function..... | 53 | ■ Memory backup..... | 84 |
| ◇ VOX set mode | 54 | ■ Resetting the CPU | 84 |
| ■ Break-in function | 55 | ■ Cleaning..... | 84 |
| ◇ Semi break-in operation..... | 55 | 12 TROUBLESHOOTING..... | 85–86 |
| ◇ Full break-in operation | 56 | 13 OPTION INSTALLATIONS | 87 |
| ■ Speech compressor | 57 | ■ MB-116 HANDLES installation | 87 |
| ◇ Compression level setting | 57 | ■ MB-117 CARRYING HANDLE installation..... | 87 |
| ■ Split frequency operation | 58 | ■ MB-118 MOBILE MOUNTING BRACKET installation.. | 87 |
| ◇ Quick split function..... | 59 | 14 CONTROL COMMAND | 88–91 |
| ◇ Split lock function | 59 | ■ Remote jack (CI-V) information..... | 88 |
| ■ Measuring SWR..... | 60 | ◇ CI-V connection example..... | 88 |
| 7 MEMORY OPERATION..... | 61–64 | ◇ Data format | 88 |
| ■ Memory channels..... | 61 | ◇ Command table..... | 89 |
| ■ Memory channel selection | 61 | ◇ Band stacking register | 91 |
| ■ Memory programming | 62 | ◇ Data mode with filter width setting | 91 |
| ◇ Programming in VFO mode | 62 | 15 SPECIFICATIONS | 92 |
| ◇ Programming in memory mode..... | 62 | ■ General | 92 |
| ■ Frequency copying | 63 | ■ Transmitter..... | 92 |
| ◇ Copying in memory mode | 63 | ■ Receiver | 92 |
| ■ Memory clearing | 64 | 16 OPTIONS..... | 93–94 |
| 8 SCAN OPERATION..... | 65–66 | 17 ABOUT CE | 95–96 |
| ■ Scan types | 65 | 18 BAND VOLTAGE MODIFICATION..... | 97 |
| ■ Preparation..... | 65 | ■ Band voltage modification | 97 |
| ■ Programmed scan operation (VFO mode) | 66 | | |
| ■ Memory scan operation (Memory mode) | 66 | | |

| |
|----|
| 1 |
| 2 |
| 3 |
| 4 |
| 5 |
| 6 |
| 7 |
| 8 |
| 9 |
| 10 |
| 11 |
| 12 |
| 13 |
| 14 |
| 15 |
| 16 |
| 17 |
| 18 |

Front panel

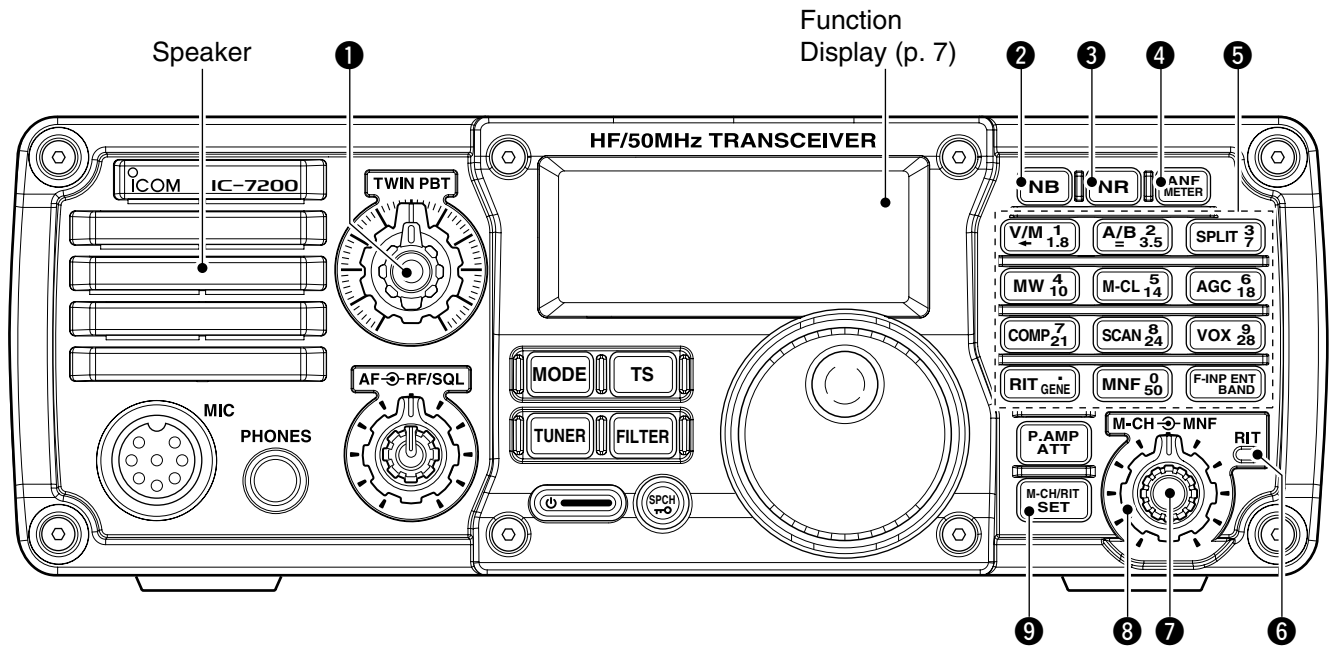

1 PASSBAND TUNING CONTROLS [TWIN PBT]

Adjust the receiver's DSP filter passband width. (p. 46)

- The limit of the variable range depends on the passband width and mode. The limit of the variable range is half of the passband width, and PBT is adjustable in 200 Hz (AM) or 50 Hz (other models) steps.
- Rotate both [TWIN PBT] controls (PBT1 and PBT2) to the same position shifts the IF.

✓ What is the PBT control?

Generally, the PBT electronically narrows the IF passband width to reject interference. This transceiver uses the DSP circuit for the PBT function.

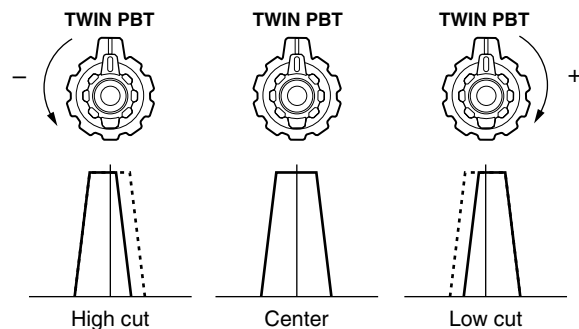
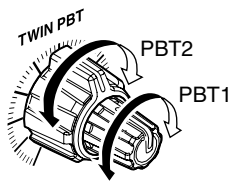

2 NOISE BLANKER KEY [NB] (p. 49)

- ➔ Push to turn the noise blanker function ON or OFF.
 - "[NB]" appears on the display.
- ➔ Push and hold for 1 sec to enter the noise blanker set mode for setting the noise blanker level and blank time; push again to return to normal operation.
 - When entering the noise blanker set mode, the noise blanker function is automatically turned ON.

✓ What is the noise blanker?

The noise blanker reduces pulse-type noise such as that generated by automobile ignition systems. This function is not effective against non pulse-type noise.

3 NR KEY [NR] (p. 50)

- ➔ Push to turn the noise reduction function ON or OFF.
 - "[NR]" appears on the display.
- ➔ Push and hold for 1 sec. to enter the noise reduction level set mode; push again to return to normal operation.
 - When entering the noise reduction set mode, the noise reduction function is automatically turned ON.

✓ What is the Noise Reduction function?

The Noise Reduction (NR) function removes random noise from the receiver passband. The level is adjustable to allow maximum clarity without harming the intelligibility of the desired signal. Noise Reduction should generally not be used with digital modes.























4 ANF/METER KEY  (p. 51)

- ➔ Push to turn the Automatic Notch Filter function ON or OFF in SSB and AM modes.
 - “ANF” appears on the display.
- ➔ Push and hold for 1 sec. to toggle the meter function; (pgs. 30, 60)
PO → SWR → ALC
 - **PO** : indicates the relative RF output power.
 - **SWR** : indicates the SWR over the transmission line.
 - **ALC** : Indicates ALC level.

✓ **What is the Automatic Notch Filter?**

The Automatic Notch Filter is a narrow DSP filter that automatically identifies and attenuates beat tones, tuning signals, CW, etc., even if they are moving and removes them from the receiver passband while preserving the desired signal's frequency response.

5 KEYPAD

- ➔ , , , , , , , , ,  and  keys are available. (p. 5)
- ➔ After pushing and holding  for 1 sec., push a key on the keypad to select the operating band. (p. 24)
 - The band stacking register is available.
 -  selects the general coverage band.
- ➔ After pushing , push a key on the keypad to enter a numeric frequency. After entering, push . (p. 25)
 - e.g. To enter 14.195 MHz;
Push , , , , , , 
and .

6 RIT CONTROL INDICATOR (pgs. 44, 61)

Lights orange when **[M-CH]** control (7) acts as the RIT control.

7 M-CH/RIT CONTROL [M-CH] (inner control)

- ➔ While in the set mode/quick set mode, rotate to select the set mode item. (p. 70)
- ➔ This control can act as the memory channel control or RIT control.
 - The RIT function should be turned ON in advance to activate this control as RIT control. (p. 44)
 - “RIT” appears when the RIT function is turned ON.
 - The RIT control indicator (6) lights orange when this control is activated as the RIT control.

During [M-CH] acts as the M-CH control:

Rotate to select a memory channel (p. 61).

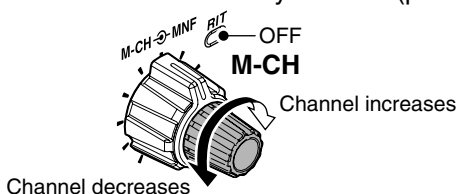

During [M-CH] acts as RIT control:

Rotate to shift the receive frequency (p. 44).

- Rotate the control clockwise to increase the frequency, or rotate the control counterclockwise to decrease the frequency.
- The shift frequency range is ±9.999 kHz in 1 Hz steps (or ±9.99 kHz in 10 Hz steps).

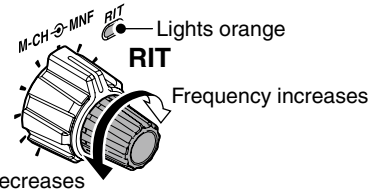

✓ **What is the RIT function?**

The RIT (Receiver Incremental Tuning) shifts the receive frequency without shifting the transmit frequency. This is useful for fine tuning for stations calling you off-frequency or when you prefer to listen to slightly different sounding voice characteristics, etc.

- About the **[M-CH]** control activation:

| | | | |
|---|------------|-----------------------------------|------------------------------------|
| | | RIT control indicator (6 on p. 2) | |
| | | Lights | OFF |
|  indicator (6 on p. 8) | Appears | Acts as the RIT control | Acts as the memory channel control |
| | Disappears | N/A | |

8 MANUAL NOTCH FILTER CONTROL [MNF]

(outer control; p. 51)

Rotate to adjust the notch filter frequency to reject an interfering signal while the manual notch function is ON.

- The filter width can be set to narrow, middle or wide in the manual notch filter set mode.

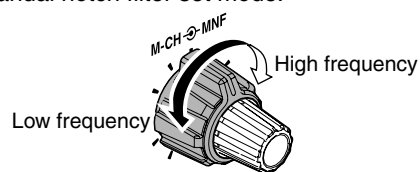

✓ **What is the Manual Notch Filter?**

The Manual Notch Filter is an adjustable narrow DSP filter that removes tones from CW, SSB, AM or RTTY signals while preserving the desired signal's frequency response.

9 M-CH/RIT•SET KEY 

- ➔ Push to toggle the **[M-CH]** control activation between memory channel control and RIT control.
 - The RIT function should be turned ON in advance. (p. 44)
 - The RIT control indicator (6) lights orange when the **[M-CH]** control functions as the RIT control.
- ➔ Push and hold for 1 sec. to enter the quick set mode. (p. 70)
- ➔ During quick set mode, push and hold for 1 sec. to enter the set mode (p. 70)
- ➔ During quick set mode or set mode, push to return to normal operation. (p. 70)

1 PANEL DESCRIPTION

■ Front panel (Continued)

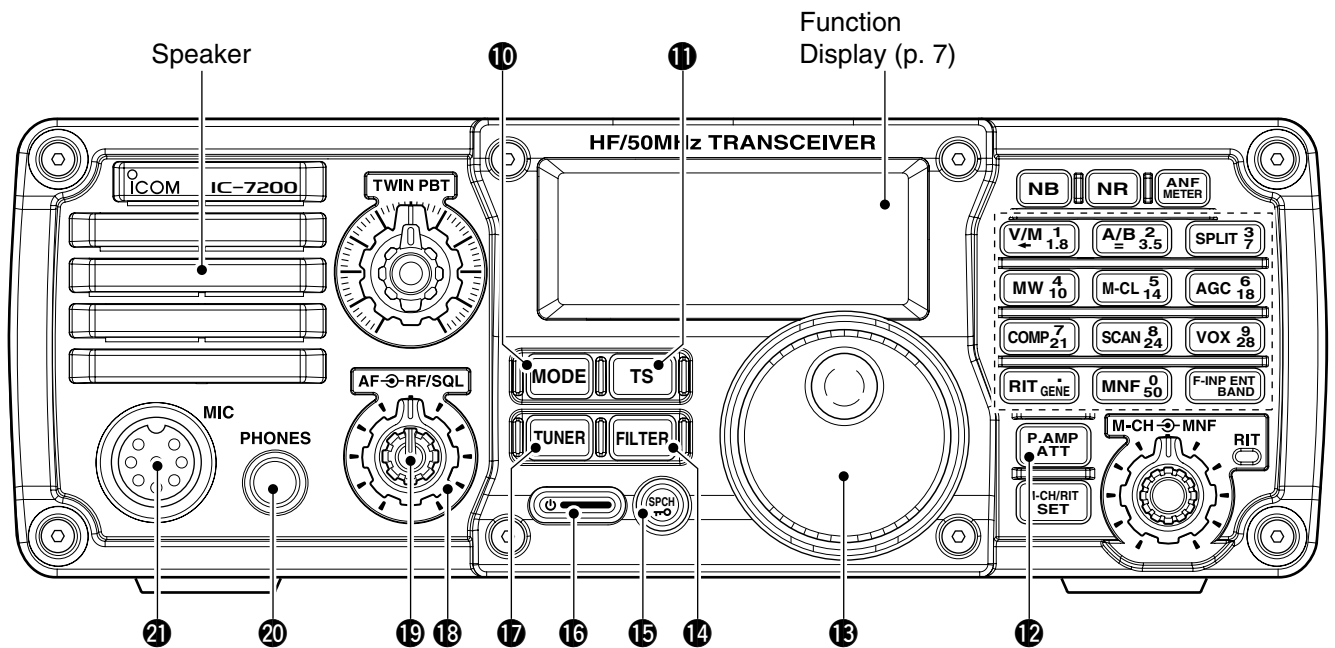

10 MODE KEY **MODE** (p. 29)

- ➔ Push momentarily to cycle through the operating modes:
USB/LSB → CW/CW-R → RTTY/RTTY-R → AM
- ➔ Push and hold for 1 sec. to toggle the following operating modes:
USB ↔ LSB (p. 33)
CW ↔ CW-R (Reverse) (p. 35)
RTTY ↔ RTTY-R (Reverse) (p. 39)
 - “CW-R” or “RTTY-R” appears on the display when reverse mode is selected.

▨ Undesired modes can be inhibited in set mode. (p. 81)

11 TUNING STEP KEY **TS** (pgs. 26, 27)

- ➔ Push to turn the programmable tuning step ON or OFF.
 - “▼” appears above the 1 kHz indicator when the programmable tuning step is turned ON and the frequency can be changed in programmed kHz steps.
- ➔ While the programmable tuning step is turned ON (“▼” appears), push and hold for 1 sec. to enter tuning step set mode; push again to return to normal operation.
 - 0.1, 1, 5, 9 and 10 kHz programmable tuning steps are available.
- ➔ While the programmable tuning step is turned OFF, push and hold for 1 sec. to turn the 1 Hz step ON and OFF.
 - 1 Hz indication appears, and the frequency can be changed in 1 Hz steps.

12 PREAMP/ATTENUATOR KEY **P.AMP ATT** (p. 45)

- ➔ Push to turn the preamp ON or OFF.
 - “P.AMP” appears on the display.
- ➔ Push and hold for 1 sec. to turn the 20 dB attenuator ON; push momentarily to turn the attenuator OFF.
 - “ATT” appears on the display.

✓ What is the preamp?

The preamp amplifies signals in the receiver front end (input) circuit to improve the sensitivity. Turn the preamp ON when receiving weak signals.

✓ What is the attenuator?

The attenuator prevents a strong undesired signal near the desired frequency or near your location, such as from a broadcast station, from causing distortion or spurious signals.

13 MAIN DIAL [DIAL]

Changes the displayed frequency and selects values for selected set mode items, etc.

14 FILTER KEY **FILTER** (p. 47)

- ➔ Push momentarily to cycle the IF filter settings between wide, middle and narrow for the selected operating mode.
- ➔ Push and hold for 1 sec. to enter the filter set mode.

15 SPCH•LOCK KEY 

- ➔ Push to announce the selected frequency and S-meter level by the speech synthesizer. (p. 32)
 - The parameters to be announced can be selected in the set mode. (p. 77)
- ➔ Push and hold for 1 sec. to turn the dial lock function ON or OFF. (p. 29)
 - The dial lock function electronically locks the main dial.
 - “” appears while the dial lock function is ON.

16 POWER KEY 

- ➔ Push to turn power ON.
 - Turn the DC power supply ON in advance.
- ➔ Push and hold for 1 sec. to turn power OFF.

17 TUNER KEY  (p. 67)

- ➔ Push to turn the automatic antenna tuner function ON or OFF.
 - An optional antenna tuner must be connected.
 - “**TUNE**” appears on the display.
- ➔ Push and hold for 1 sec. to manually tune the antenna tuner.
 - An optional antenna tuner must be connected.
 - When the tuner cannot tune the antenna, the tuning circuit is bypassed automatically after 20 sec.

18 RF GAIN/SQUELCH CONTROL [RF/SQL]
(outer control; p. 30)

- ➔ Adjusts the RF gain and squelch threshold level.

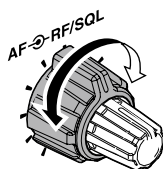

- ➔ The squelch removes noise output from the speaker (closed condition) when no signal is received.
 - The squelch is available for all modes.
 - The control can be set as the squelch plus RF gain controls, squelch control only (RF gain is fixed at maximum) or Auto (RF gain control in SSB, CW and RTTY; squelch control in AM) in set mode.

| MODE | SET MODE SETTING | | |
|-----------------|------------------|-----|---------------|
| | AUTO | SQL | RF + SQL |
| SSB, CW RTTY | RF GAIN | SQL | RF GAIN + SQL |
| AM | SQL | SQL | RF GAIN + SQL |

• When functioning as RF GAIN/SQL control

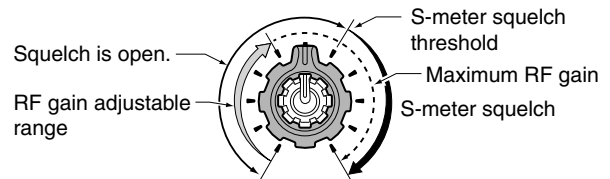

• When functioning as RF GAIN control
(Squelch is fixed open; SSB, CW, RTTY only)

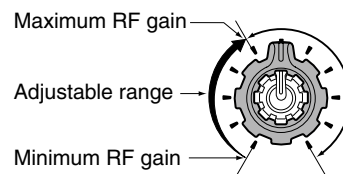

• When functioning as SQL control
(RF gain is fixed at maximum.)

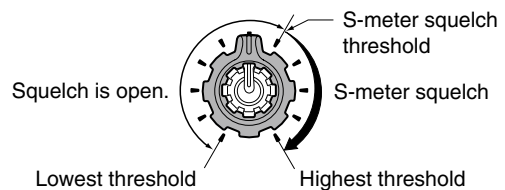

19 AF CONTROL [AF] (inner control; p. 29)

Varies the audio output level from the speaker.

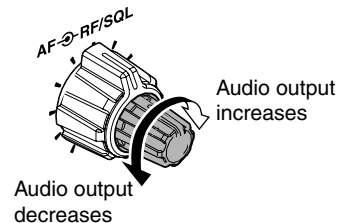

20 HEADPHONE JACK [PHONES]

Accepts headphones with 8–16 Ω impedance.

- Output power: 5 mW with an 8 Ω load.
- When headphones are connected, no receive audio comes from the speaker.





21 MICROPHONE CONNECTOR [MIC]



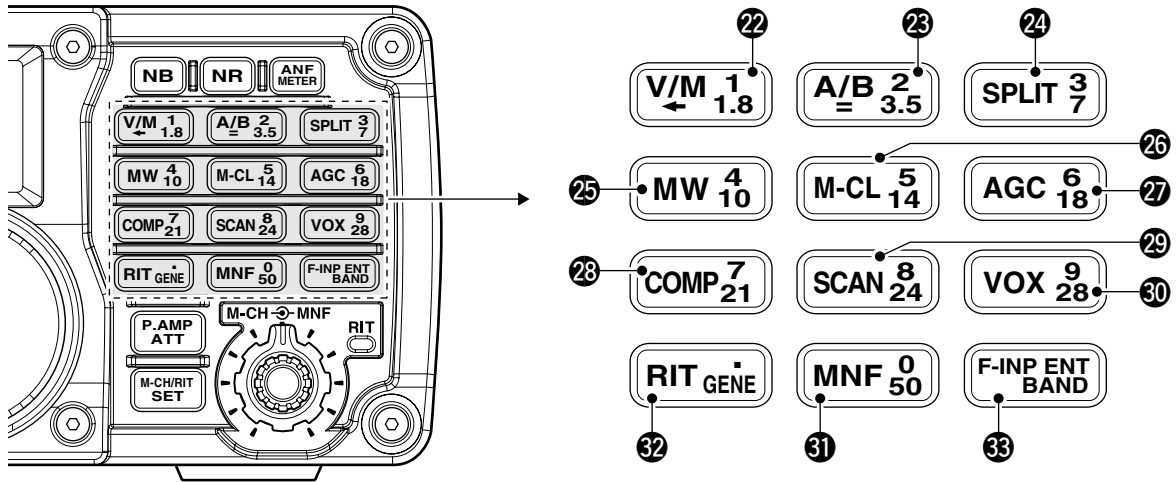

Accepts supplied or optional microphone.





- See p. 11 for appropriate microphones and microphone connector information.





◆ Keypad



- 22 VFO/MEMORY/1/1.8 MHz BAND KEY**
-  ➔ Push to toggle the operating mode between VFO mode or memory mode. (pgs. 23, 61)
 - ➔ Push and hold for 1 sec. to copy the memory contents to VFO. (p. 63)
 -  ➔ Push , then push this key to input the number '1.' (p. 25)
 - ➔ Push and hold  for 1 sec., then push this key to select the 1.8 MHz band. (p. 24)

- 23 VFO SELECT/EQUALIZATION/2/3.5 MHz BAND KEY**
-  ➔ Push to toggle between VFO A and VFO B. (p. 22)
 - ➔ Push and hold for 1 sec. to equalize the frequency and operating mode of the two VFO's. (p. 22)
 - The undisplayed VFO frequency and operating mode are set the same as the displayed VFO frequency and operating mode.
 -  ➔ Push , then push this key to input the number '2.' (p. 25)
 - ➔ Push and hold  for 1 sec., then push this key to select the 3.5 MHz band. (p. 24)

- 24 SPLIT/3/7 MHz BAND KEY**
-  ➔ Push to toggle the split function ON and OFF. (p. 58)
 - "SPLIT" appears on the display.
 - ➔ Push and hold for 1 sec. to activate the quick split function. (p. 59)
 - The VFO B frequency and operating mode are set the same as the VFO A frequency and operating mode.
 - The quick split function can be turned OFF in the set mode. (p. 76)
 -  ➔ Push , then push this key to input the number '3.' (p. 25)
 - ➔ Push and hold  for 1 sec., then push this key to select the 7 MHz band. (p. 24)

- 25 MEMORY WRITE/4/10 MHz BAND KEY**
-  Push and hold for 1 sec. to store the displayed VFO frequency and operating mode into the selected memory channel. (p. 62)
 -  ➔ Push , then push this key to input the number '4.' (p. 25)
 - ➔ Push and hold  for 1 sec., then push this key to select the 10 MHz band. (p. 24)

26 MEMORY CLEAR/5/14 MHz BAND KEY

- M-CL** ➔ Push and hold for 1 sec. to clear the displayed memory channel contents in memory mode. (p. 64)
- “**BLANK**” appears above the memory channel number.
- ➔ Push and hold for 1 sec., to select a default condition or value when in set mode/quick set mode. (p. 70)
- 5**
14 ➔ Push **F-INP ENT BAND**, then push this key to input the number ‘5.’ (p. 25)
- ➔ Push and hold **F-INP ENT BAND** for 1 sec., then push this key to select the 14 MHz band. (p. 24)

27 AGC/6/18 MHz BAND KEY

- AGC** ➔ Push to toggle the time constant for the AGC circuit fast and slow. (p. 45)
- “**F.AGC**” appears on the display when fast AGC is selected; no indication appears when slow AGC is selected
- ➔ Push and hold for 1 sec. to turn the AGC function OFF.
- “**AGC-OFF**” appears on the display.
- 6**
18 ➔ Push **F-INP ENT BAND**, then push this key to input the number ‘6.’ (p. 25)
- ➔ Push and hold **F-INP ENT BAND** for 1 sec., then push this key to select the 18 MHz band. (p. 24)

28 SPEECH COMPRESSOR/7/21 MHz BAND KEY

- COMP** ➔ Push to turn the speech compressor function ON or OFF. (p. 57)
- “**COMP**” appears on the display.
- ➔ Push and hold for 1 sec. to enter the speech compression level set mode; push again to return to normal operation.
- 7**
21 ➔ Push **F-INP ENT BAND**, then push this key to input the number ‘7.’ (p. 25)
- ➔ Push and hold **F-INP ENT BAND** for 1 sec., then push this key to select the 21 MHz band. (p. 24)

29 SCAN/8/24 MHz BAND KEY

- SCAN** ➔ Push to start/stop the programmed/memory scan in VFO/memory mode. (p. 66)
- “**SCAN**” appears on the display during scanning.
- 8**
24 ➔ Push **F-INP ENT BAND**, then push this key to input the number ‘8.’ (p. 25)
- ➔ Push and hold **F-INP ENT BAND** for 1 sec., then push this key to select the 24 MHz band. (p. 24)

30 VOX/9/28 MHz BAND KEY

- VOX** ➔ Push to turn the VOX function ON or OFF. (p. 53)
- ➔ Push and hold for 1 sec. to enter VOX set mode; push again to return to normal operation.
- 9**
28 ➔ Push **F-INP ENT BAND**, then push this key to input the number ‘9.’ (p. 25)
- ➔ Push and hold **F-INP ENT BAND** for 1 sec., then push this key to select the 28 MHz band. (p. 24)

✓ What is the VOX function?

The VOX function (Voice-Operated Transmission) activates the transmitter when you speak into the microphone and automatically returns to receive when you stop speaking.

31 MANUAL NOTCH FILTER/0/50 MHz BAND KEY

- MNF** ➔ Push to turn the manual notch filter function ON or OFF. (p. 51)
- “**MNF**” appears on the display.
- ➔ Push and hold for 1 sec. to enter the manual notch set mode; push again to return to normal operation. (p. 52)
- Before entering the set mode, the manual notch filter function is turned ON.
- 0**
50 ➔ Push **F-INP ENT BAND**, then push this key to input the number ‘0.’ (p. 25)
- ➔ Push and hold **F-INP ENT BAND** for 1 sec., then push this key to select the 50 MHz band. (p. 24)

32 RIT/•/GENERAL BAND KEY

- RIT** ➔ Push to turn the RIT (Receiver Incremental Tuning) function ON or OFF. (p. 44)
- “**RIT**” appears on the display.
 - RIT frequency can be adjusted with [M-CH] control when RIT mode is selected.
- ➔ Push and hold for 1 sec. to add the RIT shift frequency to the operating frequency. (p. 44)
- Available only when the XFC (transmit frequency check function) is turned OFF. (p. 76)
- **GENE** ➔ Push **F-INP ENT BAND**, then push this key to input the number ‘• (decimal point).’ (p. 25)
- ➔ Push and hold **F-INP ENT BAND** for 1 sec., then push this key to select the general coverage band. (p. 24)

33 FREQUENCY INPUT/ENTER/BAND KEY

- F-INP ENT BAND** ➔ Push to enter the direct frequency input condition. (p. 25)
- ➔ Push and hold for 1 sec., then push a key on the keypad to select the operating band. (p. 24)
- **•** selects the general coverage band.

Function display

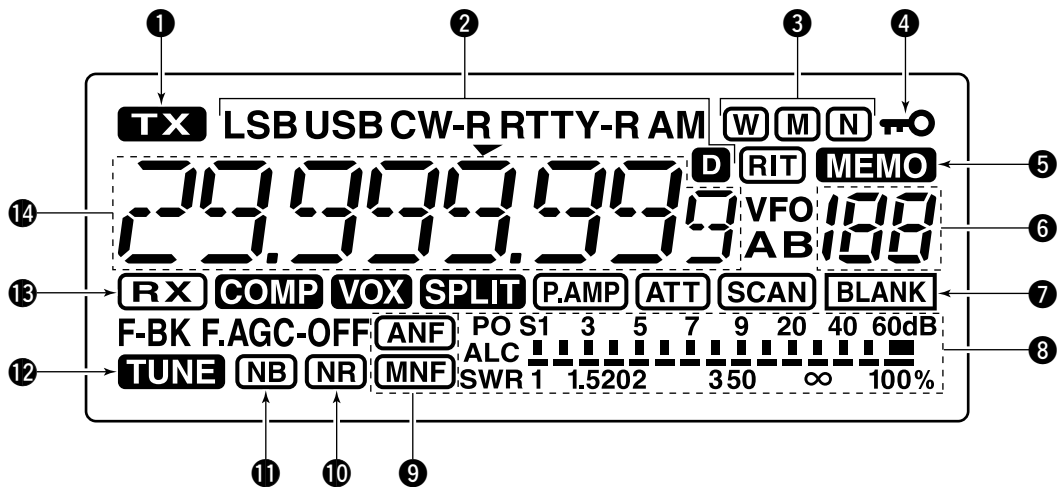

- 1 TRANSMIT INDICATOR**
Appears while transmitting.
- 2 MODE INDICATORS**
Shows the selected operating mode.
 - “**D**” appears when SSB/AM data mode is selected. (p. 71)
 - “**-R**” appears when CW reverse or RTTY reverse mode is selected. (pgs. 29, 35, 39)
- 3 IF FILTER INDICATORS** (p. 47)
Shows the selected IF filter.
 - ➔ “**W**” appears when the wide IF filter is selected.
 - ➔ “**M**” appears when the normal IF filter is selected.
 - ➔ “**N**” appears when the narrow IF filter is selected.
- 4 LOCK INDICATOR** (p. 29)
Appears when the dial lock function is activated.
- 5 MEMORY INDICATOR** (p. 61)
Appears when memory mode is selected.
- 6 MEMORY CHANNEL NUMBER READOUT**
(p. 61)
Shows the selected memory channel number.
- 7 BLANK INDICATOR** (p. 62)
Appears when the selected memory channel is blank.
 - This indicator appears both in VFO and memory mode.
- 8 SIGNAL/SQL/RF-GAIN METER**
 - ➔ Shows receiving signal strength while receiving.
 - ➔ Shows either transmit power meter (Po), SWR or ALC while transmitting. (p. 30)
- 9 NOTCH INDICATORS** (p. 51)
 - ➔ “**ANF**” appears when the automatic notch function is activated.
 - ➔ “**MNE**” appears when the manual notch function is activated.
- 10 NOISE REDUCTION INDICATOR** (p. 50)
Appears when the noise reduction is activated.
- 11 NOISE BLANKER INDICATOR** (p. 49)
Appears when the noise blanker is activated.
- 12 TUNE INDICATOR** (p. 67)
 - ➔ Appears when the optional automatic antenna tuner is activated.
 - ➔ Blinks while tuning.
- 13 RECEIVE INDICATOR**
Appears while receiving a signal or when the squelch is open.
- 14 FREQUENCY READOUT**
Shows the operating frequency.

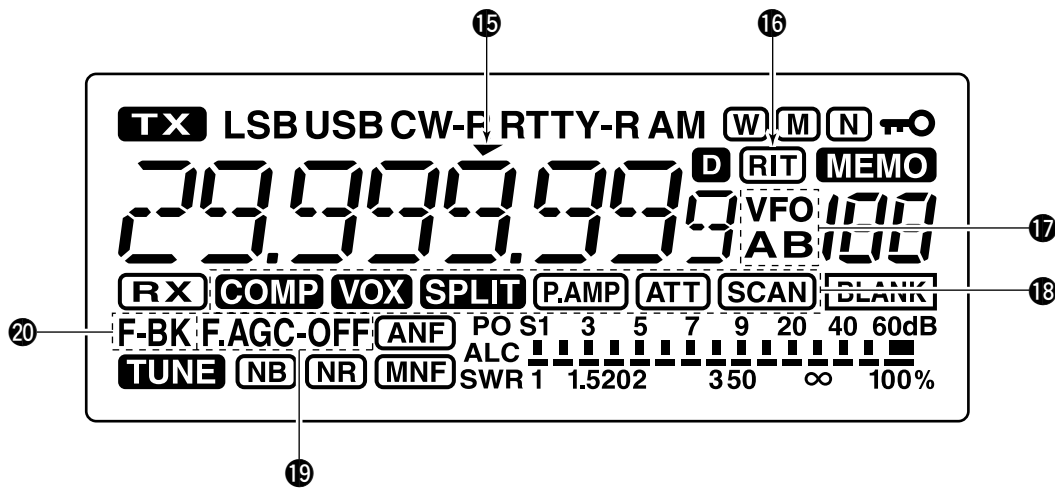

15 PROGRAMMABLE TUNING STEP INDICATOR

Appears when the programmable tuning step is selected. (p. 26)

16 RIT INDICATOR (p. 44)

Appears when the RIT function is activated.

17 VFO INDICATORS (p. 22)

“VFO A” or “VFO B” appears when VFO mode is selected.

18 FUNCTION INDICATORS

- ➔ “**COMP**” appears when the speech compressor is activated in SSB mode.
- ➔ “**VOX**” appears when the VOX function is activated.
- ➔ “**SPLIT**” appears during split frequency operation.
- ➔ “**P.AMP**” appears when preamp is activated.
- ➔ “**ATT**” appears when the attenuator function is activated.
- ➔ “**SCAN**” appears during scan.
 - Blinks when scan is paused.

19 AGC INDICATORS (p. 45)

Shows the selected AGC time constant.
 • “F.AGC” for AGC fast; “AGC-OFF” for AGC OFF; no indicator; for AGC slow.

20 BREAK-IN INDICATORS (p. 55)

- ➔ “**BK**” appears when the semi break-in function is activated.
- ➔ “**F-BK**” appears when the full break-in function is activated.

■ Rear panel

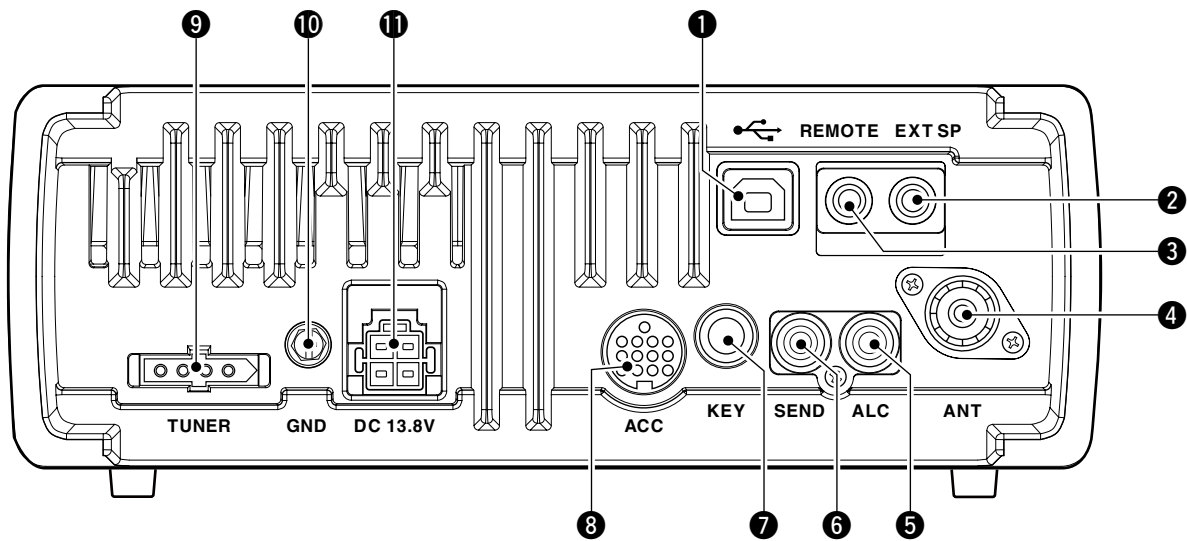

1 USB JACK []

Connect an USB cable to be used for the modulation input (p. 20), the transceiver operation with PC and the received audio import to the PC.

CAUTION:

For Windows® XP/2000:

NEVER install the driver before connecting an USB cable between the transceiver and PC.

For Windows Vista™:

NEVER connect an USB cable until the driver installation has been complete.

About the USB driver:

Icom HP (<http://www.icom.co.jp/world/support/index.html>) gives the USB driver and the installation guide download service.

The following items are required:

PC

- Microsoft® Windows® XP/2000 or Microsoft® Windows Vista™ installed
- With USB port

Other items

- USB cable (third party's)
- PC software

About the modulation input:

Select "U" (USB) in the set mode item 'Modulation input (Data OFF)' or 'Modulation input (Data ON)'. And the modulation input level from USB jack can be set in the set mode item 'USB Level.' (p. 77)

2 EXTERNAL SPEAKER JACK [EXT SP]

(pgs. 14, 93)

Connect a 4–8 Ω external speaker, if desired.

- When an external speaker is connected, the internal speaker does not function.

3 CI-V REMOTE CONTROL JACK [REMOTE]

(pgs. 14, 88)

- ➔ Designed for use with a PC for remote control of the transceiver functions.
- ➔ Used for transceiver operation with another Icom CI-V transceiver or receiver.

4 ANTENNA CONNECTOR [ANT]

Accepts a 50 Ω antenna with a PL-259 connector and a 50 Ω coaxial cable.

5 ALC INPUT JACK [ALC]

Connects to the ALC output jack of a non-Icom linear amplifier.

6 SEND CONTROL JACK [SEND]

Goes to ground while transmitting to control external equipment such as a linear amplifier.
• Max. control level: 16 V DC/0.5 A

7 ELECTRONIC KEYSER JACK [KEY]

Accepts a key or paddle connector for the internal electronic keyer.
• The keyer type selection between the internal electronic keyer and straight key operation can be made in set mode.

When connecting a straight key

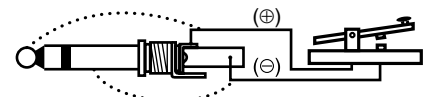

When connecting a paddle

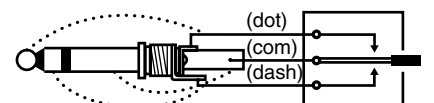

/// If you use an external electronic keyer, make sure the output voltage of the keyer is less than 0.4 V when keying the transmitter.

8 ACCESSORY SOCKET [ACC]

Enables connection to external equipment such as a TNC for data communications, a linear amplifier or an automatic antenna tuner, etc.
 • See below for socket wiring information.

9 TUNER CONTROL SOCKET [TUNER] (p. 16)

Accepts the control cable from an optional AH-4 HF/50 MHz AUTOMATIC ANTENNA TUNER.

10 GROUND TERMINAL [GND] (p. 12)

Connect this terminal to a ground to prevent electrical shocks, TVI, BCI and other problems.

11 DC POWER SOCKET [DC 13.8V] (p. 15)

Accepts 13.8 V DC through the supplied DC power cable.

Rear panel view

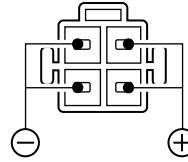

ACC socket information

• ACC socket

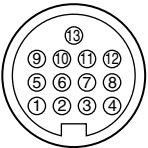
| ACC | PIN No. | NAME | DESCRIPTION | SPECIFICATIONS |
|--|---------|------------|---|---|
|  <p>Rear panel view</p> <p>① brown ⑧ gray ② red ⑨ white ③ orange ⑩ black ④ yellow ⑪ pink ⑤ green ⑫ light blue ⑥ blue blue ⑦ purple ⑬ light green</p> <p>Color refers to the cable strands of the supplied cable.</p> | 1 | NC (8 V*) | (*If the modification (p. 97) is performed, regulated 8 V output.) | Output voltage : 8 V ± 0.3 V Output current : Less than 10 mA |
| | 2 | GND | Connects to ground. | |
| | 3 | HSEND | Input/output pin. Grounded when transmits. | Ground level : -0.5 V to 0.8 V Output current : Less than 20 mA Input current (Tx) : Less than 200 mA |
| | 4 | BDT | Data line for the optional AT-180. | |
| | 5 | NC (BAND*) | (*If the modification (p. 97) is performed, band voltage output.) | Output voltage : 0 to 8.0 V |
| | 6 | ALC | ALC voltage input. | Control voltage : -4 V to 0 V Input impedance : More than 10 kΩ |
| | 7 | NC | | |
| | 8 | 13.8 V | 13.8 V output when power is ON. | Output current : Max. 1 A |
| | 9 | TKEY | Key line for the optional AT-180. | |
| | 10 | FSKK | Controls RTTY keying | "High" level : More than 2.4 V "Low" level : Less than 0.6 V Output current : Less than 2 mA |
| | 11 | MOD | Modulator input. | Input impedance : 10 kΩ Input level : Approx. 100 mV rms |
| | 12 | AF | AF detector output. Fixed level, regardless of the [AF] control position. | Output impedance : 4.7 kΩ Output level : 100-300 mV rms |
| | 13 | SQLS | Squelch output. Grounded when squelch opens. | SQL open : Less than 0.3 V/5 mA SQL closed : More than 6.0 V/100 μA |

• When connecting the ACC conversion cable (OPC-599)

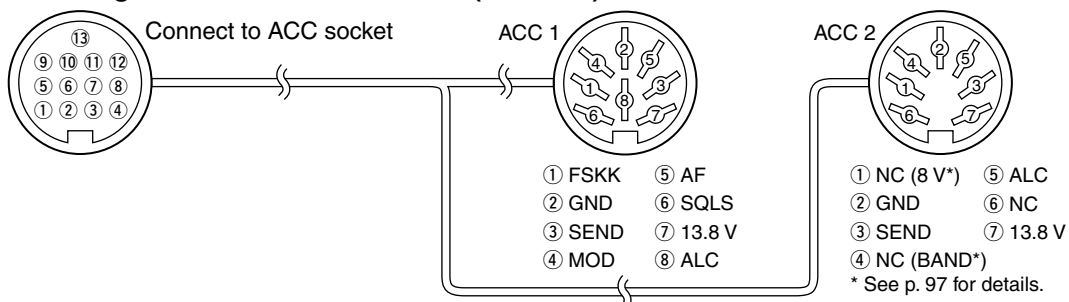

Microphones

◇ HM-36

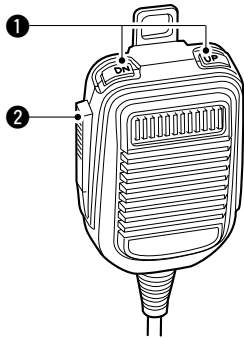

◇ SM-20 (Option)

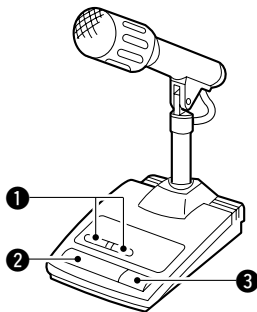

1 UP/DOWN SWITCHES [UP]/[DN]

Change the selected readout frequency or memory channel.

- Pushing the switch continuously changes the frequency or memory channel number continuously.
- The [UP]/[DN] switch can simulate a key paddle. Select in set mode (U/D KEY; Mic Up/Down Keyer). (p. 80)
- While pushing and holding [RIT]*, push the [UP]/[DN] switch to control the transmit readout frequency while in split frequency operation.

* Available only when the XFC (transmit frequency check) function is turned ON. (p. 76)

2 PTT SWITCH

Push and hold to transmit; release to receive.

3 PTT LOCK SWITCH (SM-20 only)

Push to lock the PTT switch to the transmission condition.

• MICROPHONE CONNECTOR (Front view)

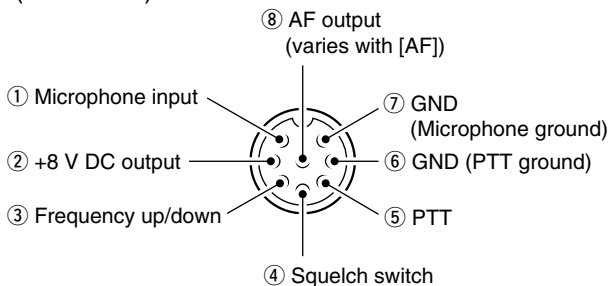

| [MIC] PIN NO. | FUNCTION | DESCRIPTION |
|---------------|----------------|----------------------|
| 2 | +8 V DC output | Max. 10 mA |
| 3 | Frequency up | Ground |
| | Frequency down | Ground through 470 Ω |
| 4 | Squelch open | "LOW" level |
| | Squelch close | "HIGH" level |

CAUTION: DO NOT short pin 2 to ground as this can damage the internal 8 V regulator. DC voltage is applied to pin 1 for microphone operation. Use caution when using a non-Icom microphone.

• HM-36 SCHEMATIC DIAGRAM

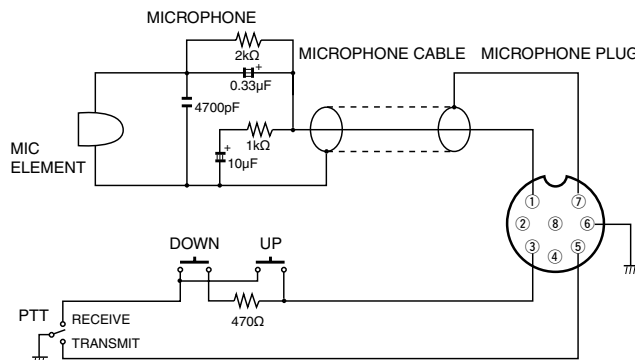

■ Unpacking

After unpacking, immediately report any damage to the delivering carrier or dealer. Keep the shipping cartons.

For a description and a diagram of accessory equipment included with the IC-7200, see 'Supplied accessories' on p. i of this manual.

■ Selecting a location

Select a location for the transceiver that allows adequate air circulation, free from extreme heat, cold, or vibrations, and away from TV sets, TV antenna elements, radios and other electromagnetic sources.

The base of the transceiver has an adjustable stand for desktop use. Set the stand to one of two angles depending on your operating conditions.

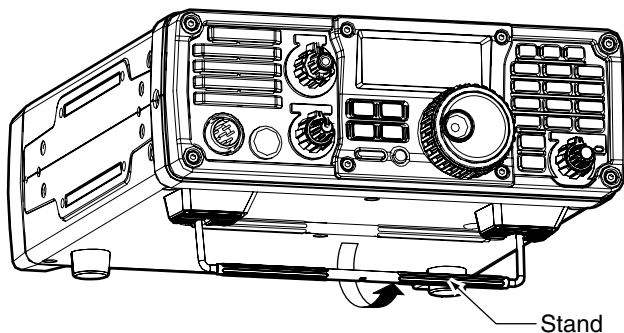

Stand

■ Grounding

To prevent electrical shock, television interference (TVI), broadcast interference (BCI) and other problems, ground the transceiver through the GROUND terminal on the rear panel.

For best results, connect a copper or copper-plated ground rod driven into the earth. Make the distance between the [GND] terminal and ground as short and straight as possible.

WARNING: NEVER connect the [GND] terminal to a gas or electric conduit, since the connection could cause an explosion or electric shock.

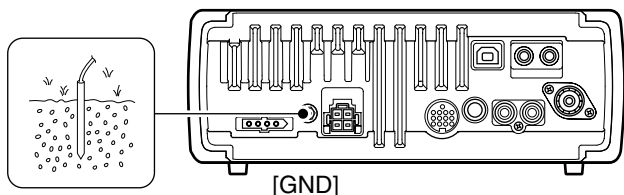

[GND]

■ Antenna connection

For radio communications the antenna is of critical importance for output power and sensitivity. Use well-matched 50 Ω antennas and coaxial feedline. An SWR (standing wave ratio) of 1.5:1 or lower is recommended when transmitting.

CAUTION: Protect your transceiver from lightning by using a lightning arrestor.

PL-259 CONNECTOR INSTALLATION EXAMPLE

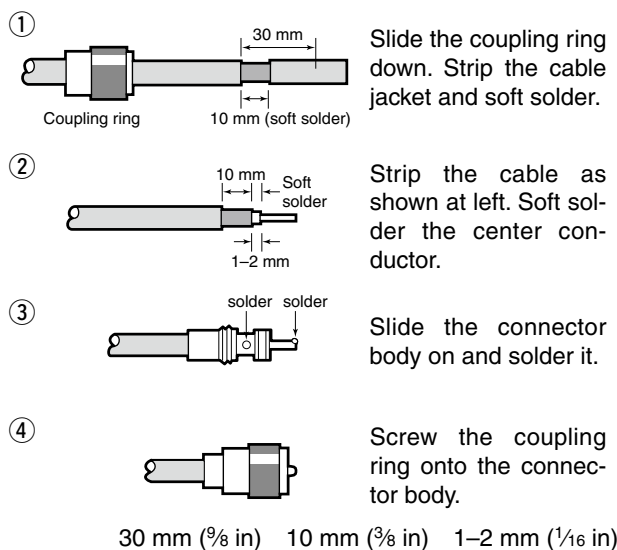

Antenna SWR

Each antenna is tuned for a specified frequency range and SWR may be increased out-of-range. When the SWR is higher than approx. 2.0:1, the transceiver's power drops to protect the final transistor. In this case, an optional antenna tuner is useful to match the transceiver and antenna. Low SWR allows full power for transmitting even when using the antenna tuner. The IC-7200 has an SWR meter to monitor the antenna SWR continuously.

Required connections

• Front panel

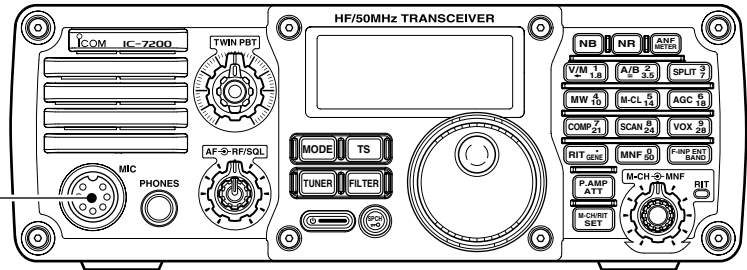
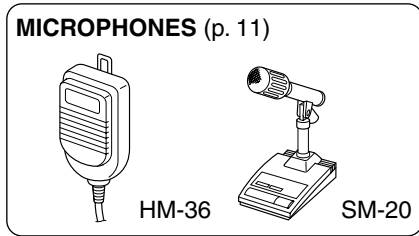

• Rear panel

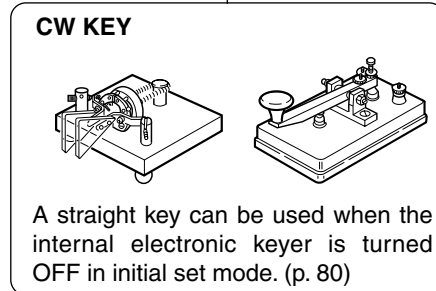
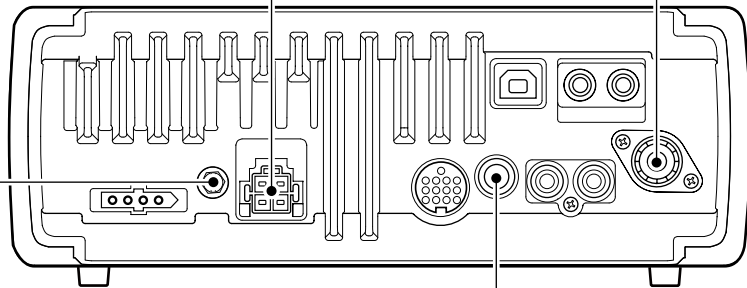
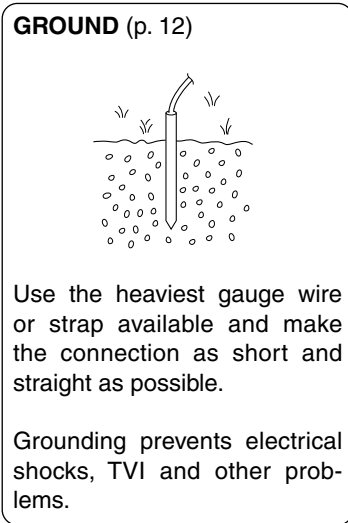
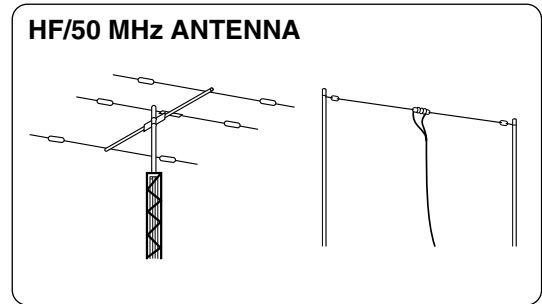
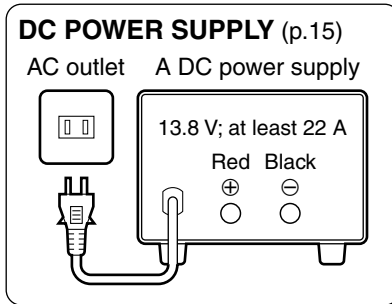

Advanced connections

• Front panel

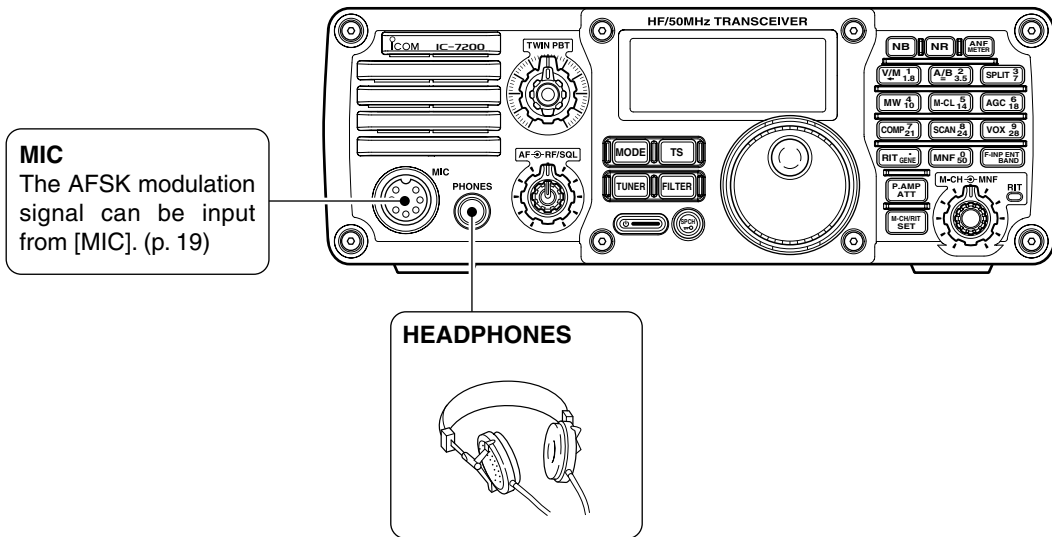

• Rear panel

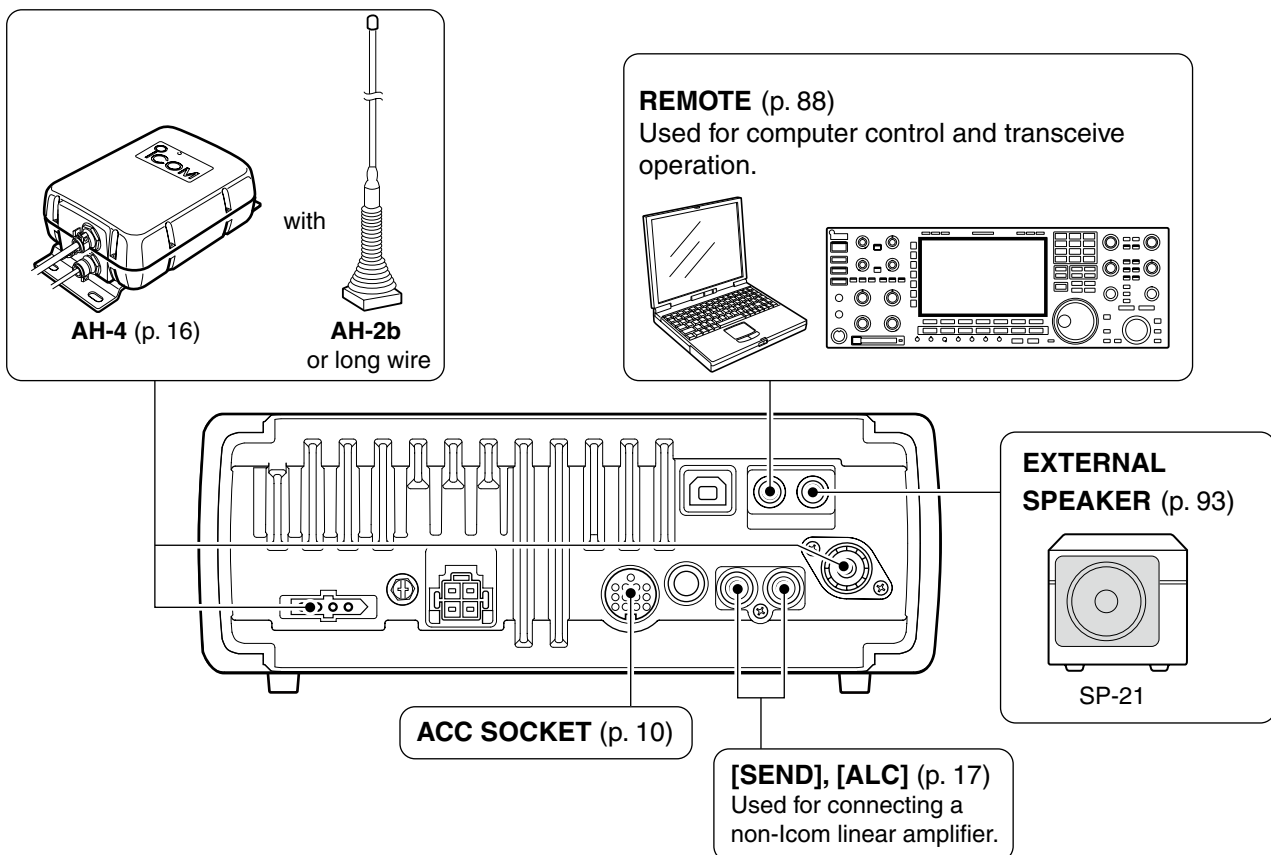

Power supply connections

Use a DC power supply with a 22 A capacity when operating the transceiver with AC power. Refer to the diagrams below.

CAUTION: Before connecting the DC power cable, check the following important items. Make sure:

- The  switch is OFF.
- Output voltage of the power source is 12–15 V.
- DC power cable polarity is correct.
Red : Positive ⊕ terminal
Black : Negative ⊖ terminal

Connecting the DC Power Supply

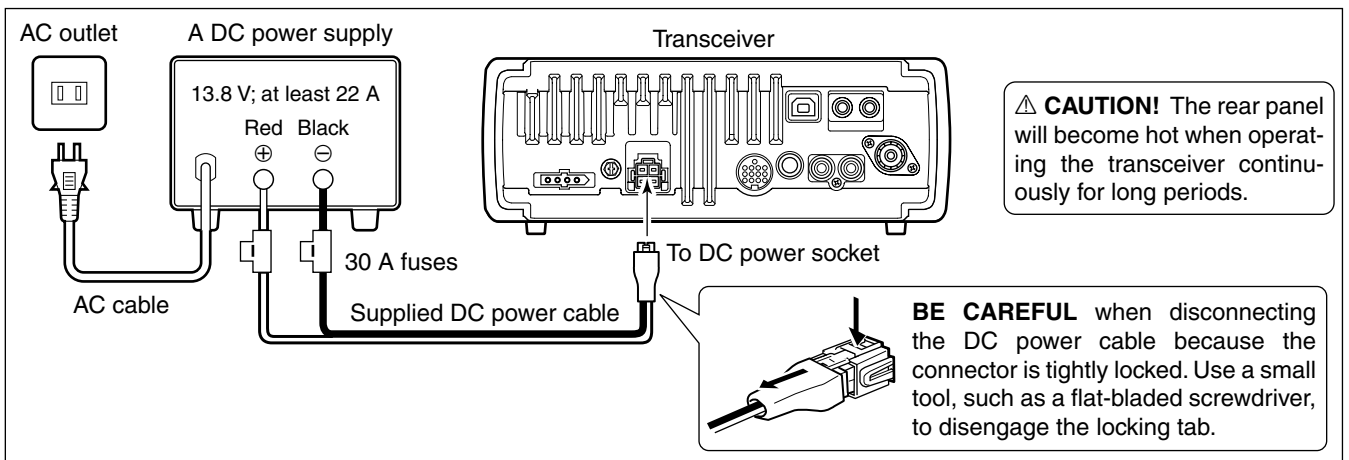

Battery connections

- **WARNING NEVER** connect to a battery without supplying a DC fuse, otherwise a fire hazard occurs.
- **NEVER** connect the transceiver to a 24 V battery.

The transceiver may not receive well on some frequencies when installed in a hybrid vehicle, or any type of electric vehicle (fuel cell vehicle). This is because vehicle's electric components such as the inverter system generate a lot of electric noise.

- **DO NOT** use a cigarette lighter socket as a power source when operating in a vehicle. The plug may cause voltage drops and ignition noise may be superimposed onto transmit or receive audio.
- Use a rubber grommet when passing the DC power cable through a metal plate to prevent a short circuit.

The IC-7200 is not certified for vehicle installation in European countries.

CONNECTING A VEHICLE BATTERY

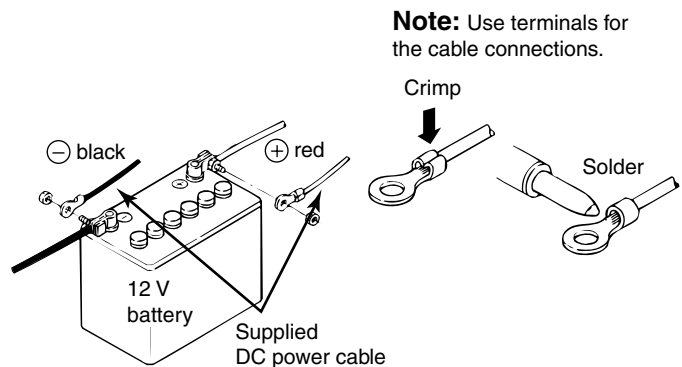
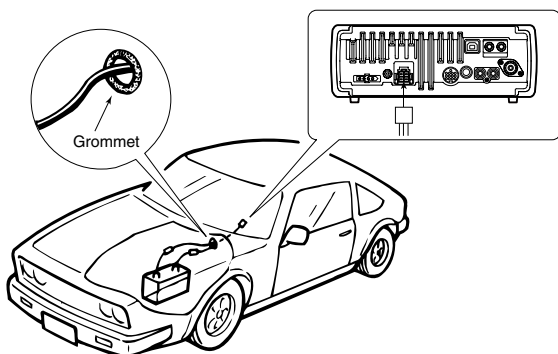

External antenna tuners

CONNECTING THE AH-4

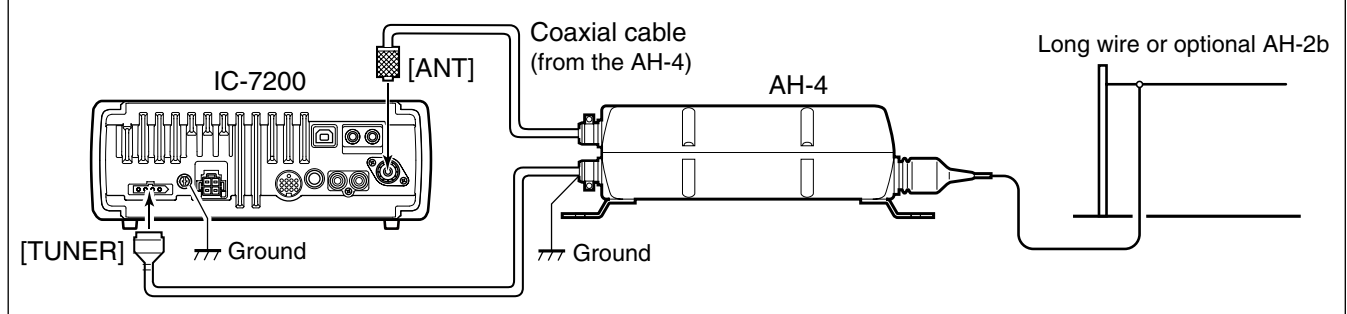

CONNECTING THE AT-180

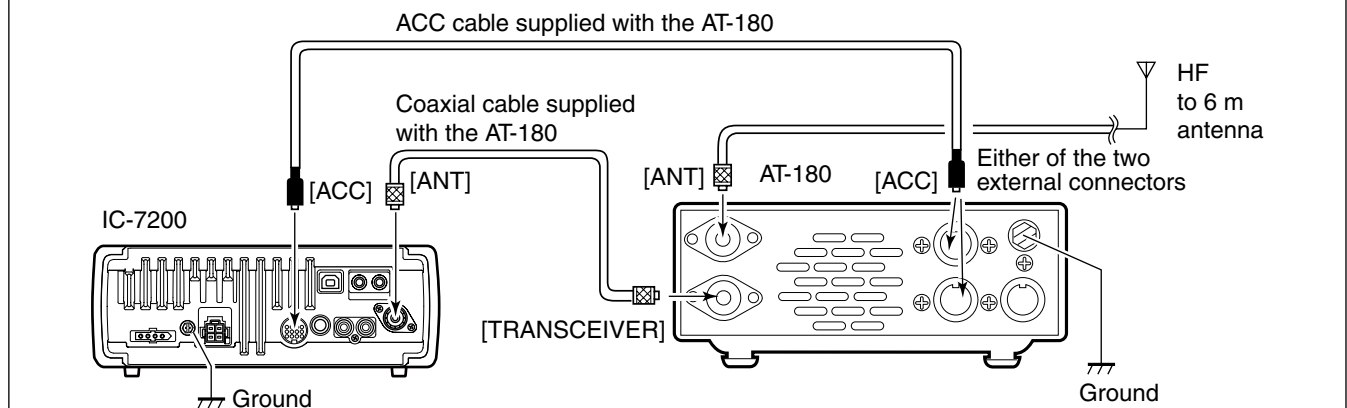

- Turn the IC-7200's power OFF when connecting the AT-180, otherwise, the CPU may malfunction and the AT-180 may not function properly.

Linear amplifier connections

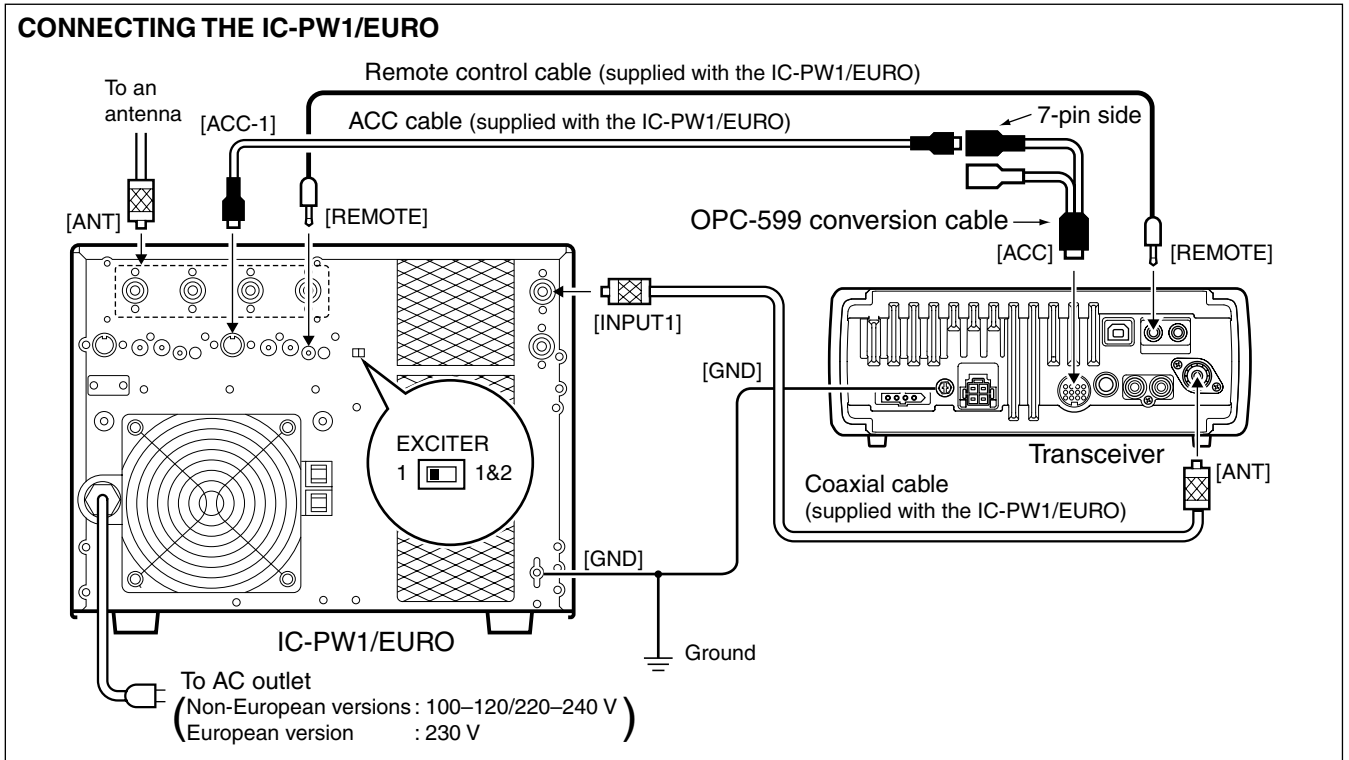

CONNECTING A NON-ICOM LINEAR AMPLIFIER

WARNING:

- Set the transceiver output power and linear amplifier ALC output level by referring to the linear amplifier instruction manual. Be sure the linear amplifier keying circuit control voltage is compatible with the IC-7200, before connecting to the [SEND] connector.
- The ALC input level must be in the range +0 V to –4 V, and the transceiver does not accept positive voltage. Non-matched ALC and RF power settings could cause a fire or damage the linear amplifier.

The IC-7200 SEND line is rated at 16 V/200 mA DC. If this level is exceeded, a larger external relay must be used.

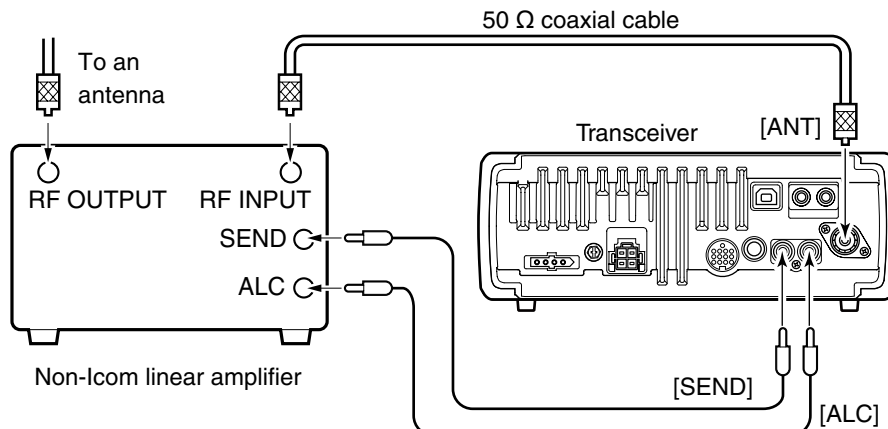

■ Connections for CW

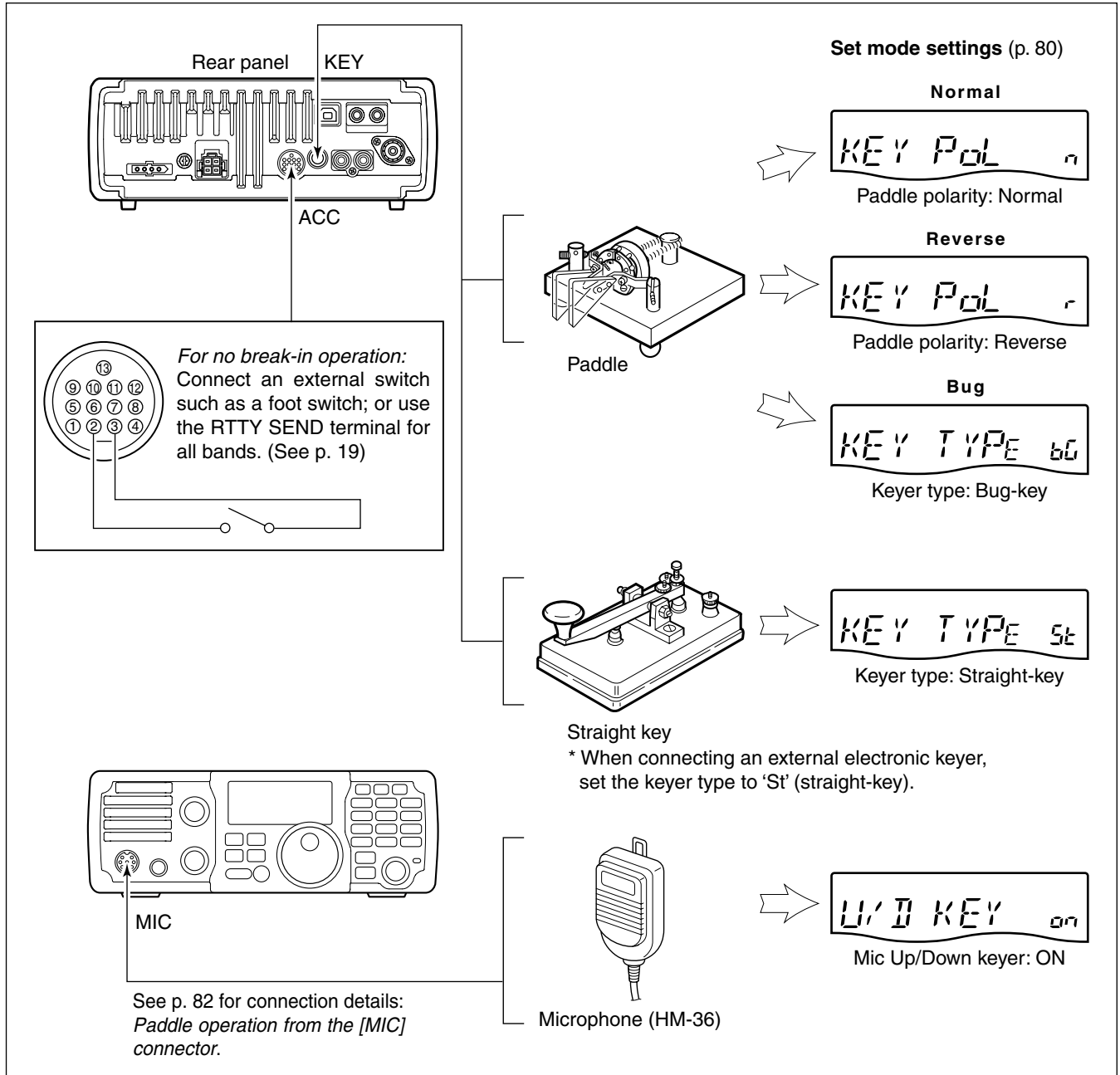

■ Connections for RTTY

◇ Connections for RTTY (FSK)

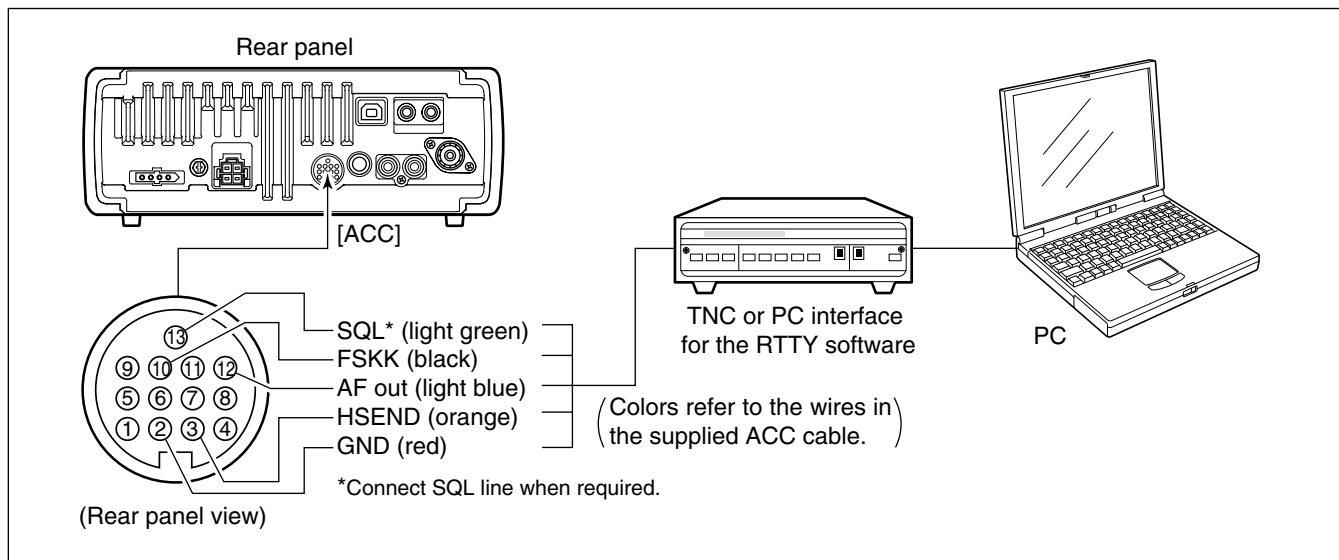

◇ Connections for RTTY (AFSK)

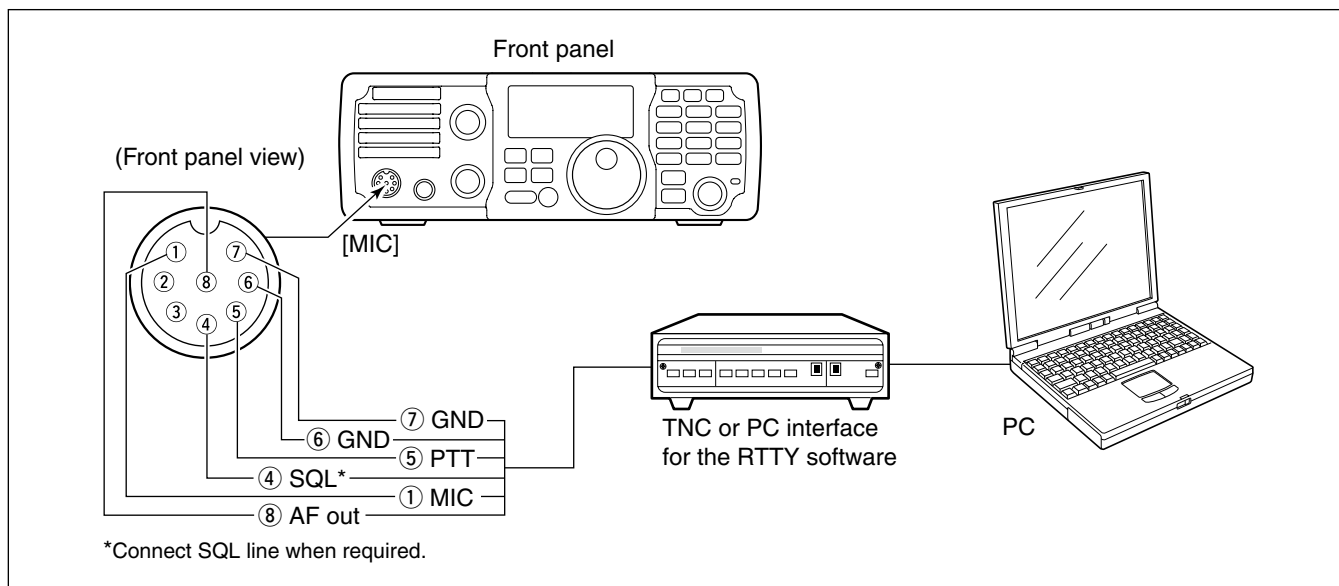

■ Connections for SSTV or PSK31

◇ When connecting to the [ACC] socket

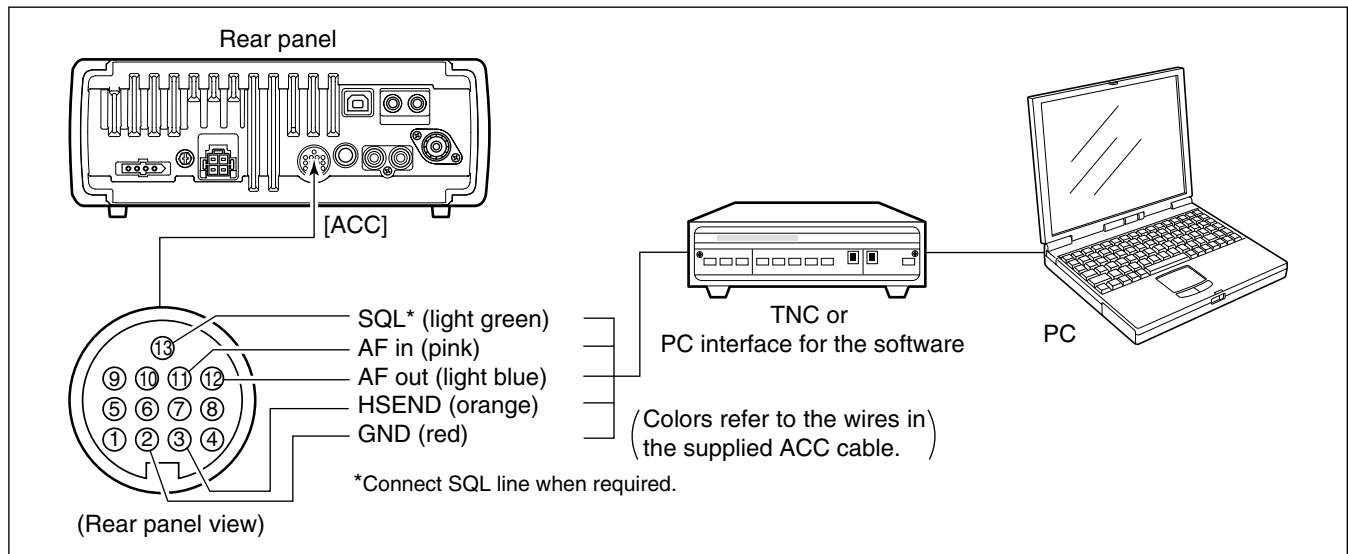

2

◇ When connecting to the [MIC] connector

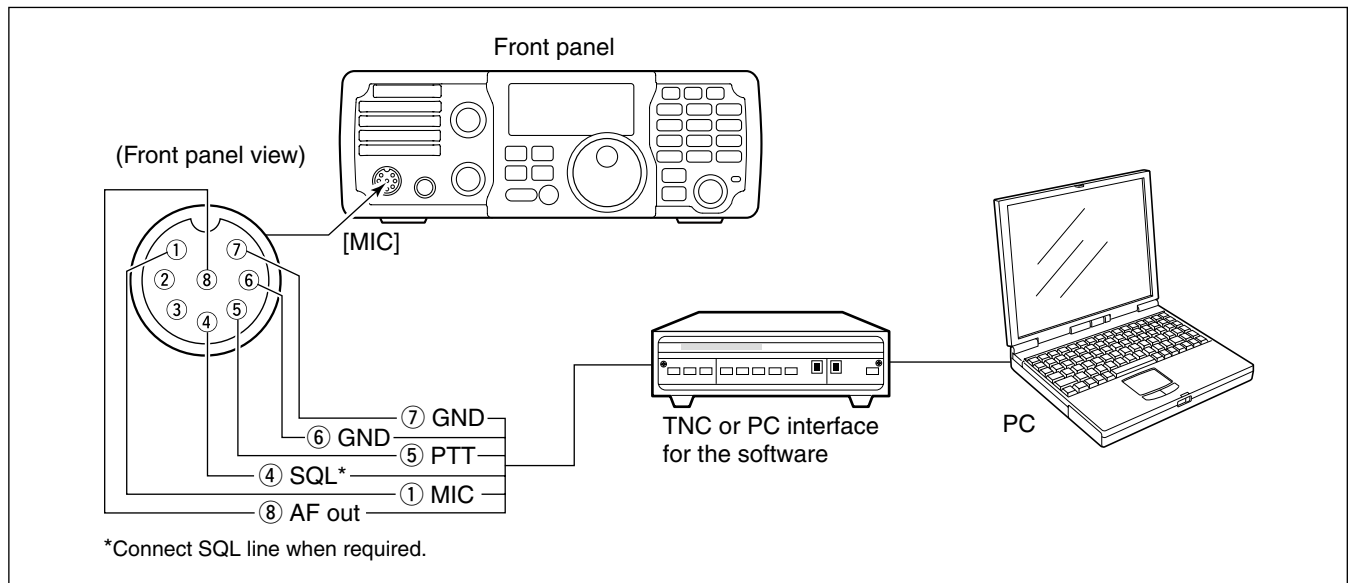

◇ When connecting to the [USB] jack

Connect an USB cable (third party's) between the transceiver's USB jack and PC. (p. 9)

- Icom HP (<http://www.icom.co.jp/world/support/index.html>) gives the USB driver and the installation guide download service.

3

BASIC OPERATION

Before first applying power

Before first applying power, make sure all connections required for your system are complete by referring to Chapter 2.

After all connections have been done, set controls and switch as shown in the figure below.

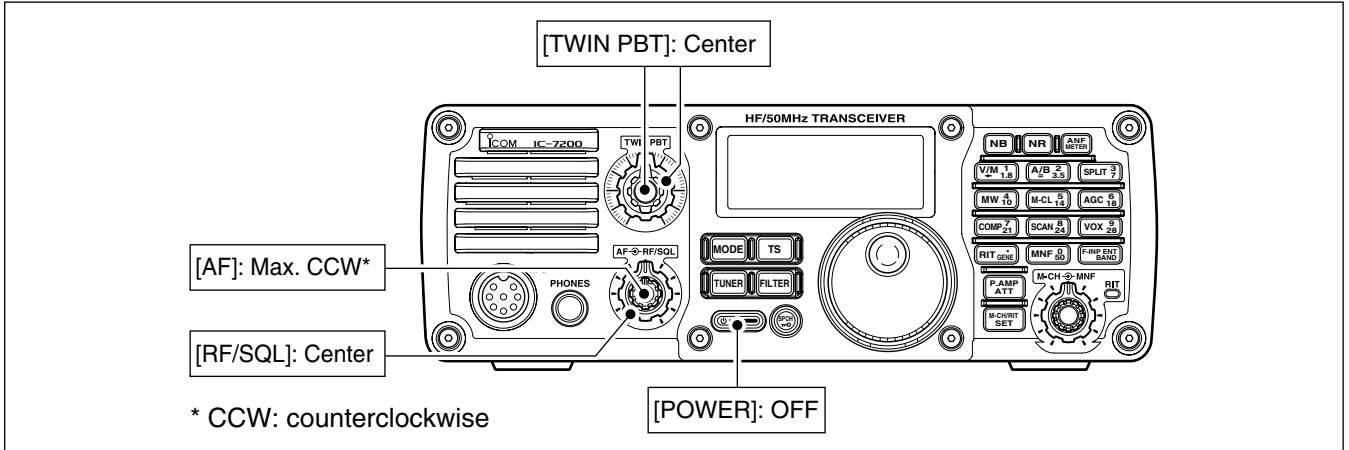

Applying power (CPU resetting)

First applying power:

Reset the transceiver using the following procedure.

Resetting **CLEARs** all programmed contents in memory channels and returns the quick set mode/set mode to default values.

- ① Make sure the transceiver power is OFF.
- ② While pushing and holding **F-INP ENT BAND** and **M-CL**, push **POWER** to turn power ON.
 - The internal CPU is reset.
 - The transceiver displays its initial VFO frequencies when resetting is complete.
- ③ All quick set mode/set mode settings are returned to the default values. (p. 70)

Normal applying power:

Push **POWER** to turn power ON, then check the display. If any of indicators appear, turn them OFF if necessary. (See the appropriate page for details).

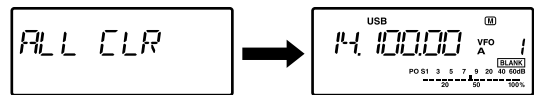
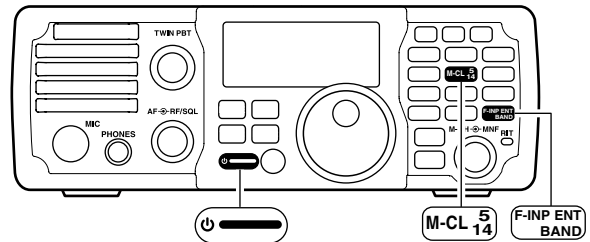

Under cooler temperatures, the LCD may appear dark and unstable after turning power ON. This is normal and does not indicate any equipment malfunction.

VFO description

VFO is an abbreviation of Variable Frequency Oscillator, and traditionally refers to an oscillator.

The IC-7200 VFO can store a frequency and an operating mode.

You can call up a desired frequency to the VFO with the keypad or the memory copy function (p. 63). You can also change the frequency with **[DIAL]** and select an operating mode with **[MODE]** or call up previously accessed frequency and modes with the band stacking register (p. 24).

The IC-7200 has two VFOs, specially suited for split frequency operation. The VFOs are called VFO A and VFO B. You can use the desired VFO to call up a frequency and operating mode for operation.

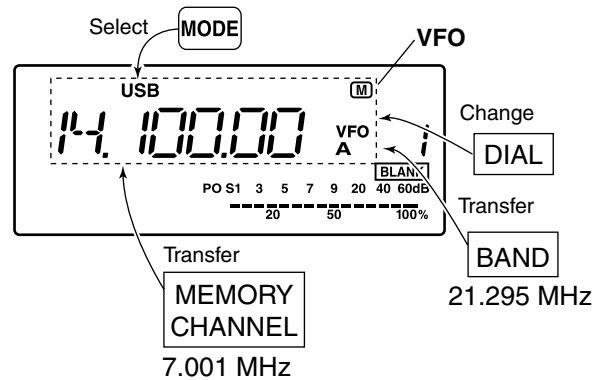

VFO operation

Selecting the VFO A/B

➔ Push **[A/B]** to toggle VFO A or VFO B.

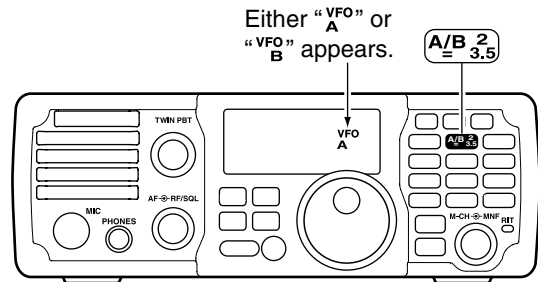

VFO equalization

➔ Push and hold **[A/B]** for 1 sec. to set the undisplayed VFO frequency and mode to the displayed VFO frequency

- 3 beeps sound when the VFO equalization is completed.

CONVENIENT

Use two VFOs as a quick memory

When you find a new station, but you wish to continue searching, the two VFO systems can be used for quick memory storage.

- ➊ Push and hold **[A/B]** for 1 sec. to store the displayed frequency into the undisplayed VFO.
- ➋ Continue searching for stations.
- ➌ Push **[A/B]** to retrieve the stored frequency.
- ➍ To continue searching for a station, push **[A/B]** again.

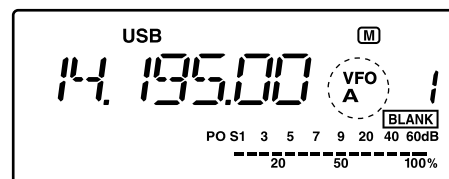

➔ Push and hold **[A/B]** for 1 sec., then push **[A/B]** again.

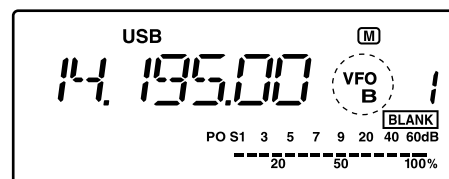

■ Selecting VFO/memory mode

➔ Push  to toggle between VFO and memory modes.

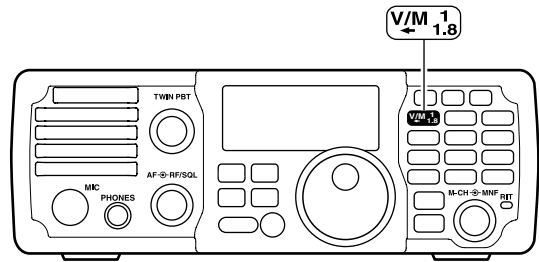

◇ Differences between VFO mode and memory mode

VFO MODE

Each VFO shows a frequency and operating mode. If the frequency or operating mode is changed, the VFO automatically memorizes the new frequency or operating mode.

When the VFO is selected from another VFO or memory mode, the last used frequency and operating mode for that VFO appears.

[EXAMPLE]

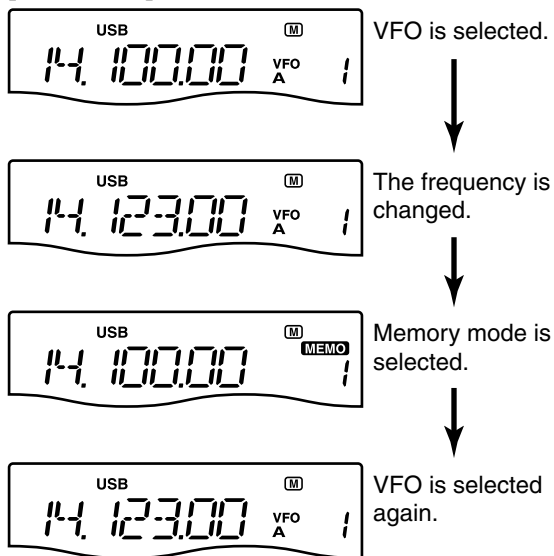

Changed frequency (14.123 MHz) appears.

MEMORY MODE (pgs. 61–64)

Each memory channel shows a frequency and operating mode like a VFO. Even if the frequency or mode is changed, the memory channel does not memorize the new frequency or operating mode.

When the memory channel is selected from another memory channel or VFO mode, the memorized frequency and operating mode appear even if the memory channel settings, frequency and mode, are changed before selecting another memory channel or VFO mode.

[EXAMPLE]

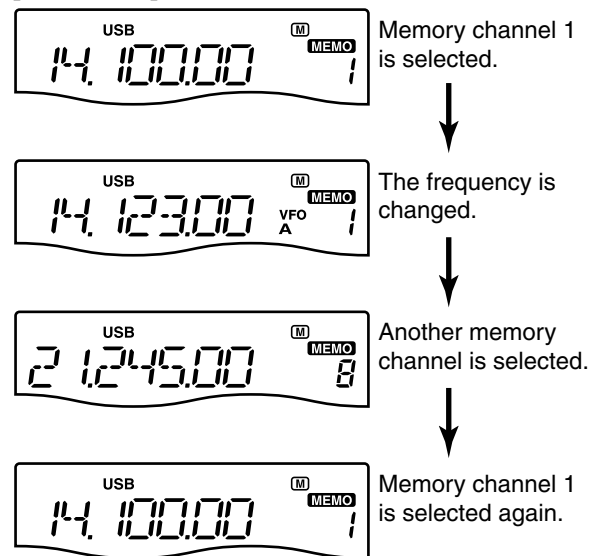

Changed frequency (14.123 MHz) does not appear and memorized frequency (14.100 MHz) appears instead.

■ Selecting an operating band

The transceiver has a band stacking register. This function automatically memorizes the last operating frequency and mode used on a particular band. This is convenient for contest operation.

See the table below for a list of the bands available and the default settings for each register.

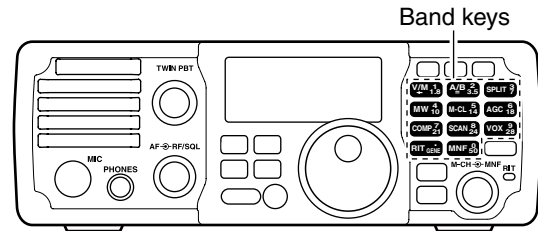

| BAND | REGISTER | BAND | REGISTER |
|---------|-------------------|---------|-------------------|
| 1.8 MHz | 1.900000 MHz CW | 21 MHz | 21.200000 MHz USB |
| 3.5 MHz | 3.550000 MHz LSB | 24 MHz | 24.950000 MHz USB |
| 7 MHz | 7.050000 MHz LSB | 28 MHz | 28.500000 MHz USB |
| 10 MHz | 10.120000 MHz CW | 50 MHz | 50.100000 MHz USB |
| 14 MHz | 14.100000 MHz USB | General | 15.000000 MHz USB |
| 18 MHz | 18.100000 MHz USB | | |

3

◇ Using the band stacking register

- ① Push and hold **F-INP ENT BAND** for 1 sec. to enter the band selection mode.
- ② Push **5/14** to select 14 MHz band.
 - The last operated frequency and mode are memorized.
- ③ Push **MODE** to select an operating mode; rotate **[DIAL]** to select an operating frequency.

[Example]: 14 MHz band

| | | |
|----------------|----------------------|-----------------------|
| V/M 1 ← 1.8 | A/B 2 = 3.5 | SPLIT 3 7 |
| MW 4 10 | M-CL 5 14 | AGC 6 18 |
| COMP 7 21 | SCAN 8 24 | VOX 9 28 |
| RIT GENE | MNF 0 50 | F-INP ENT BAND |

Frequency setting

The transceiver has several tuning methods for convenient frequency tuning.

Using the main dial

- After pushing and holding **F-INP ENT BAND** for 1 sec., push the desired band key to select the corresponding band.
 - When you push **GENE**, the general coverage receiver band is selected.



- Rotate **[DIAL]** to set the desired frequency.

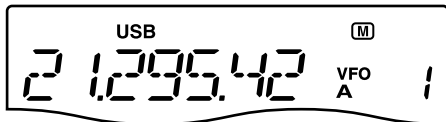

If the dial lock function is activated, "🔒" (lock indicator) appears, and **[DIAL]** does not function.
 ➔ Push and hold **SPCH** for 1 sec. to deactivate the lock function. (see p. 29 for details)

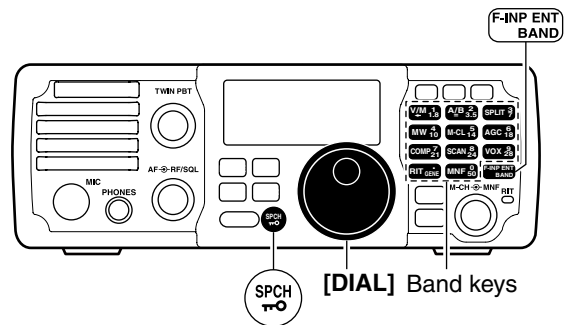

Direct frequency entry with keypad

The transceiver has a keypad for direct frequency entry as described at right.

- Push **F-INP ENT BAND**.
- Input the desired frequency with the numeral keys on the keypad.
 - Push **GENE** to input "." (decimal point) between the MHz digits and kHz digits.
- Push **F-INP ENT BAND** to set the input frequency.
 - To cancel the input, push **M-CH/RIT SET** (or any key except keypad).

[EXAMPLE]

• 14.025 MHz

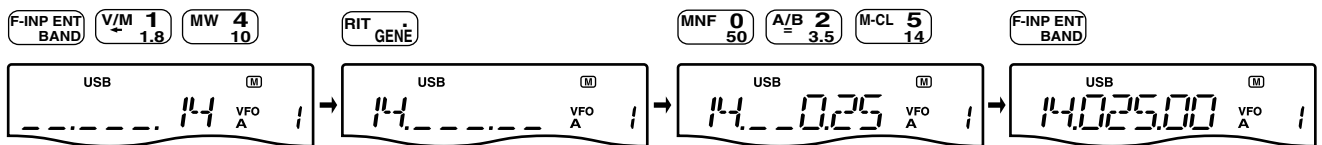

• 706 kHz

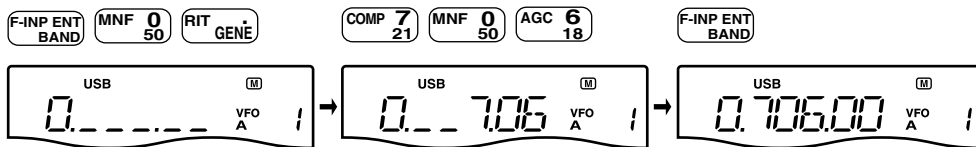

• 21.280 MHz → 21.245 MHz

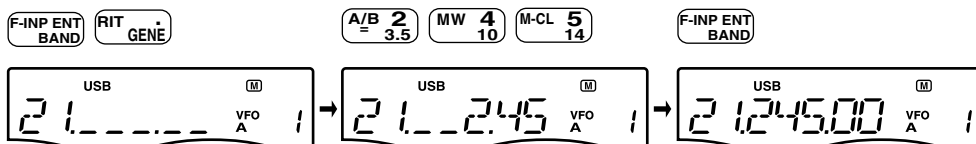

◇ Programmable tuning steps

The operating frequency can be changed in steps of (0.1, 1, 5, 9 or 10 kHz selectable) for quick tuning.

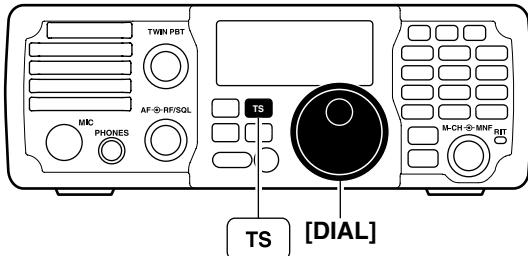

- ① Push **[TS]** to turn the programmable tuning function ON.

• “▼” appears.

Programmable tuning step indicator



- ② Rotate **[DIAL]** to change the frequency in programmed kHz steps.
- ③ Push **[TS]** again to turn the programmable tuning function OFF.
- “▼” disappears.
- ④ Rotate **[DIAL]** for normal tuning, if desired.

◇ Selecting the programmable tuning step

Programmable tuning steps are available to suit your operating requirements.

These tuning steps are:

- Selectable from 0.1, 1, 5, 9 and 10 kHz

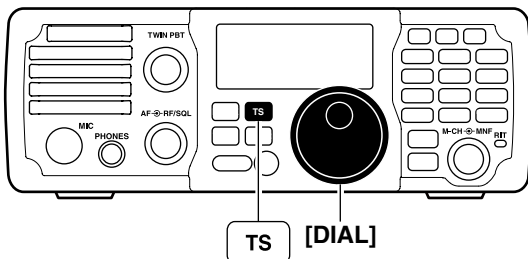

- ① Push **[TS]** to turn the programmable tuning function ON.

• “▼” appears.

Programmable tuning step indicator



- ② Push and hold **[TS]** for 1 sec. to enter the tuning step set mode.



- ③ Rotate **[DIAL]** to select the desired tuning step from 0.1, 1, 5, 9 or 10 kHz.
- ④ Push **[TS]** to exit the tuning step set mode.
- ⑤ Rotate **[DIAL]** to change the frequency according to the set tuning step.
- ⑥ Push **[TS]** to turn the programmable tuning function OFF.
- “▼” disappears.

◇ 1 Hz and 10 Hz tuning steps

When the programmable tuning step “▼” disappears, rotating [DIAL] changes the frequency in increments of 1 or 10 Hz.

NOTE: The frequency is changed in 50 Hz step when the [UP]/[DN] switches of the microphone are used for the frequency setting (when the programmable tuning step is not selected; “▼” disappears.)

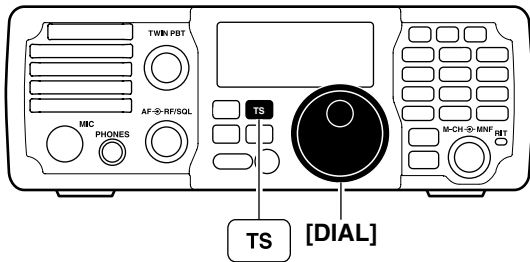

- Push and hold [TS] for 1 sec. to toggle between the 1 Hz and 10 Hz step settings.
 - When the 1 Hz step is selected, the 1 Hz digit appears in the frequency indication; when the 10 Hz step is selected, the 1 Hz digit disappears from the frequency indication.
 - Rotating [DIAL] changes the frequency in 1 Hz or 10Hz tuning step.

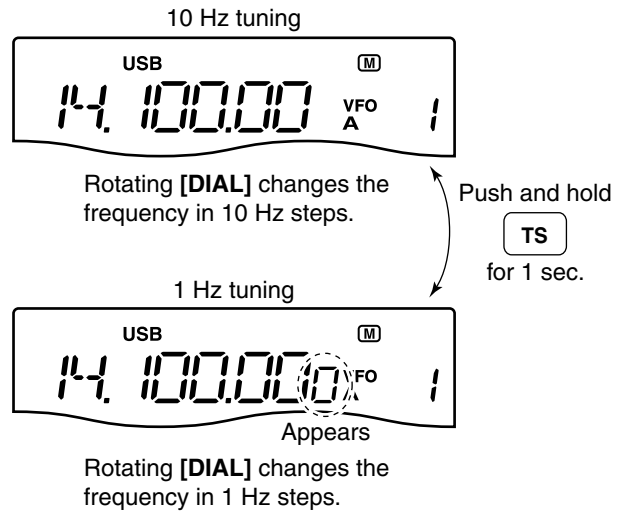

◇ [TS] switch flow chart

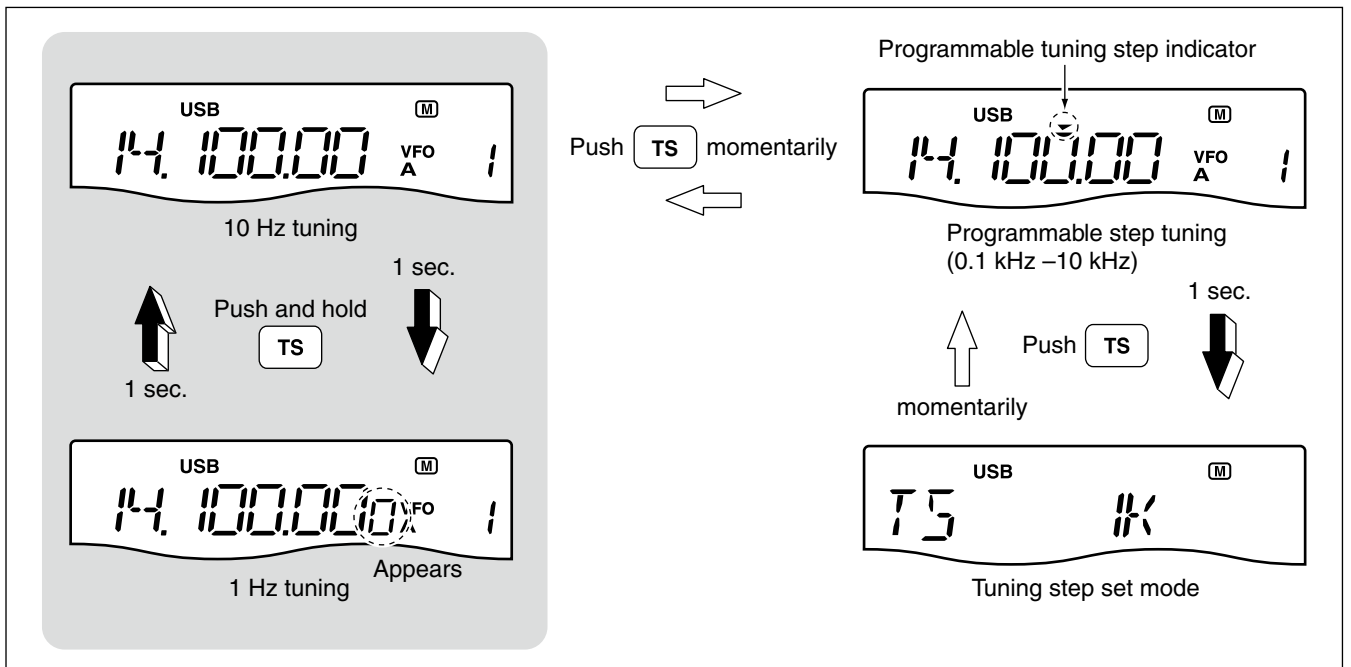

◇ Auto tuning step function

When rotating the tuning dial rapidly, the tuning speed accelerates automatically as selected.

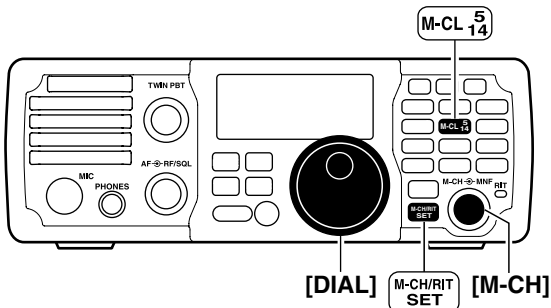

- ① Push and hold **[M-CH/RIT SET]** for 1 sec. twice to enter the set mode.
- ② Rotate **[M-CH]** to select "AUTo TS."
- ③ Rotate **[DIAL]** to select the desired tuning speed from HI (High), Lo (Low) and oF (OFF).
 - HI : Approx. 5 times faster when the tuning step is set to 1 kHz or smaller steps; approx. 2 times faster when the tuning step is set to 5 kHz or larger steps.
 - Lo : Approx. 2 times faster
 - oF : Auto tuning step is turned OFF
 - Push and hold **[M-CL]** for 1 sec. to select a default condition or value.



When "HI" is selected (default)

- ④ Push **[M-CH/RIT SET]** to exit the set mode and return to normal operation.

◇ 1/4 tuning function (SSB data/CW/RTTY only)

While operating in SSB data/CW/RTTY, the 1/4 tuning function is available for critical tuning. Dial sensitivity is reduced to 1/4 of normal when the 1/4 function is in use.

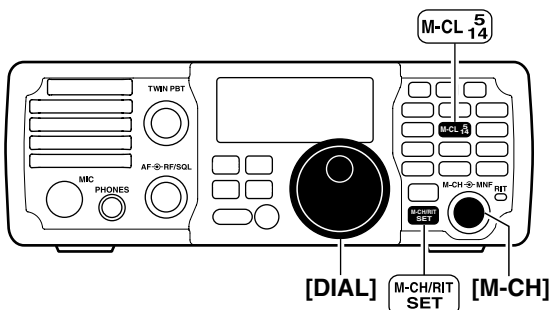

- ① Push and hold **[M-CH/RIT SET]** for 1 sec. twice to enter the set mode.
- ② Rotate **[M-CH]** to select "DIAL 1/4."
- ③ Rotate **[DIAL]** to select the 1/4 tuning function ON and OFF.
 - Push and hold **[M-CL]** for 1 sec. to select a default condition or value.



When "OFF" is selected (default)

- ④ Push **[M-CH/RIT SET]** to exit the set mode and return to normal operation.

NOTE: This function is only available when the programmable tuning step is OFF (p. 26).

◇ Band edge warning beep

When selecting a frequency that lies outside of a band's specified frequency range, a warning beep sounds.

This function can be turned OFF in set mode, if desired.

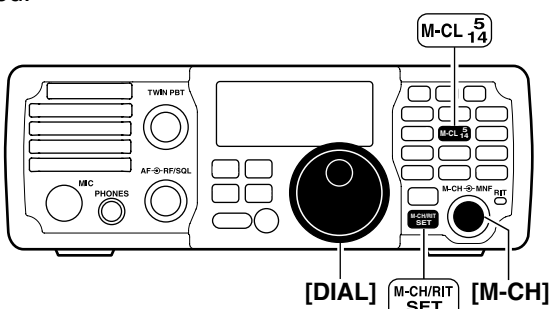

- ① Push and hold **[M-CH/RIT SET]** for 1 sec. twice to enter the set mode.
- ② Rotate **[M-CH]** to select "BAND BEP."
- ③ Rotate **[DIAL]** to select the band edge warning beep function ON and OFF.
 - Push and hold **[M-CL]** for 1 sec. to select a default condition or value.

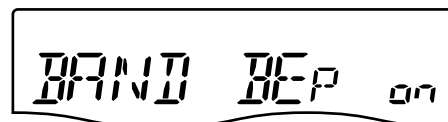

When "ON" is selected (default)

- ④ Push **[M-CH/RIT SET]** to exit the set mode and return to normal operation.

Volume setting

Rotate the [AF] control clockwise to increase; counterclockwise to decrease the audio output level.

- Set a suitable audio level.

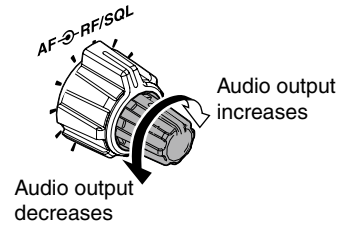
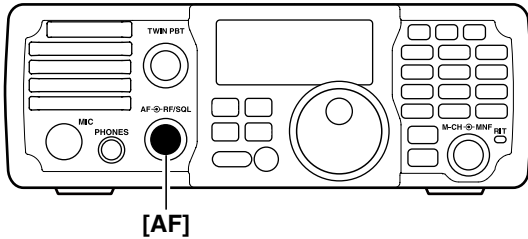

Operating mode selection

The following modes are available in the IC-7200: SSB (USB/LSB), SSB data (USB data/LSB data), CW, CW-R (CW Reverse), RTTY, RTTY-R (RTTY Reverse), AM and AM data modes.

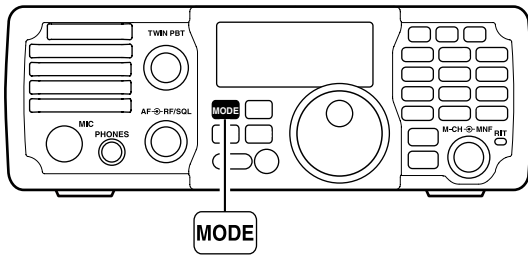

- ➔ Push **MODE** one or more times to select desired operation mode.
- ➔ Push and hold **MODE** for 1 sec. to toggle between USB and LSB. (SSB mode only)
- ➔ Push and hold **MODE** for 1 sec. to toggle between CW and CW Reverse or RTTY and RTTY Reverse. (CW and RTTY mode only)
- ➔ SSB data (USB data/LSB data) or AM data mode can be selected in the quick set mode. (p. 71)
 - The selected mode is indicated in the function display.

NOTE: If a desired operating mode cannot be selected, it may be disabled in the set mode. (p. 81)

OPERATING MODE SELECTION

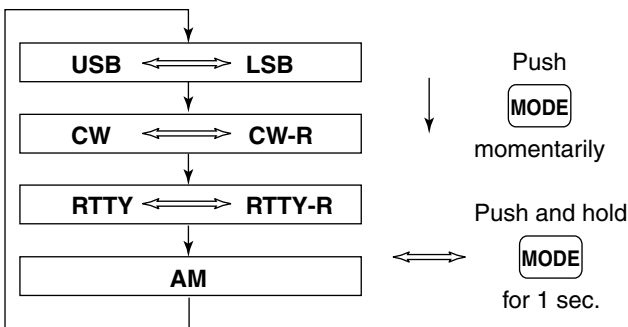

Dial lock function

The dial lock function prevents accidental changes caused by [DIAL].

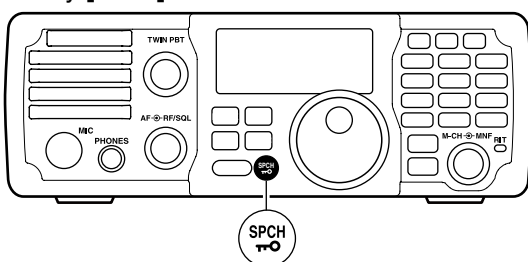

- ➔ Push and hold **SPCH** for 1 sec. to turn the dial lock function ON and OFF.
 - “**LO**” appears while the dial lock function is activated.

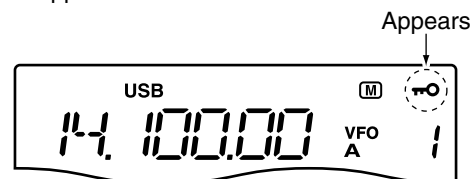

RF gain and Squelch

The [RF/SQL] control adjusts the RF gain and squelch threshold level. The squelch stops noise output from the speaker (closed position) when no signal is received.

- The 12 o'clock position is recommended for any setting of the [RF/SQL] control.
- The [RF/SQL] control can be set as the RF gain control only (squelch is fixed open) or squelch control (RF gain is fixed at maximum) in the set mode (p. 75). See the table as below.

| MODE | SET MODE SETTING | | |
|-----------------|------------------|-----|---------------|
| | AUTO | SQL | RF + SQL |
| SSB, CW RTTY | RF GAIN | SQL | RF GAIN + SQL |
| AM | SQL | SQL | RF GAIN + SQL |

○ Adjusting RF gain (Receive sensitivity)

Normally, the [RF/SQL] control is set to the 12 o'clock position.

Rotate the [RF/SQL] control to the 11 o'clock position for maximum sensitivity.

- Rotate the [RF/SQL] control clockwise to increase, counterclockwise to decrease the receiver sensitivity.
- The S-meter indicates receive sensitivity.

○ Adjusting squelch (Removing non-signal noise)

Rotate the [RF/SQL] control to the 1 o'clock position to invoke the S-meter squelch— this allows you to set the minimum signal level needed to open the squelch.

- A segment appears in the S-meter to indicate the S-meter squelch level.

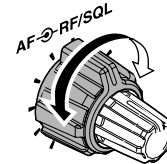
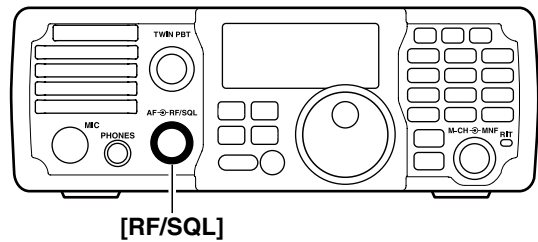

- When functioning as RF GAIN/SQL control

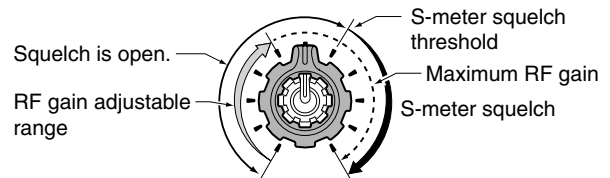

- When functioning as RF GAIN control

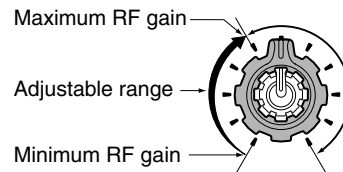

- When functioning as SQL control

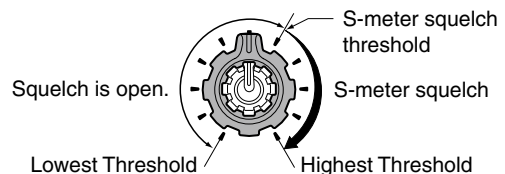

Meter function

The transceiver has 3 transmit meter functions for your convenience. Select the desired meter from RF power (Po), ALC and SWR.

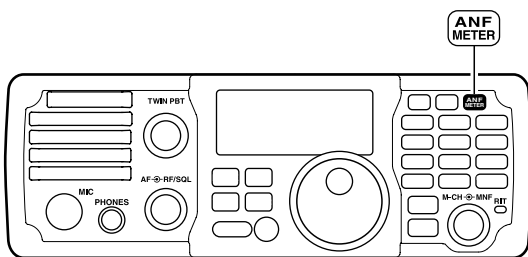

- ➔ Push and hold **ANF METER** for 1 sec. to toggle between RF power (Po), SWR and ALC.

- The display indication changes as the following table.

| DISPLAY INDICATION | MEASUREMENT |
|--------------------|---|
| Po | Indicates the relative RF output power. |
| SWR | Indicates the SWR on the transmission line. |
| ALC | Indicates the ALC level. When the meter movement shows the input signal level exceeds the allowable level, the ALC limits the RF power. In such cases, reduce the MIC gain setting (see p. 31) in the quick set mode. |

Basic transmit operation

Before transmitting, monitor your selected operating frequency to make sure transmitting won't cause interference to other stations on the same frequency.

It's good Amateur practice to listen first. On the HF bands, even if nothing is heard, ask "is the frequency in use" once or twice, before you begin operating on that frequency.

Transmitting

- ① Push **[PTT]** (microphone) to transmit.
 - "**TX**" appears.
- ② Release **[PTT]** (microphone) to return to receive.
 - "**TX**" disappears.

Appears while transmitting



Output power and Microphone gain settings

If a linear amplifier is connected such as the IC-PW1/EURO, set the output power using the ALC meter (see at "Microphone gain setting" as below) to the ALC zone (ALC meter reading should be within this zone), otherwise the linear amplifier will not work properly.

Output power setting

- ① Push and hold **[M-CH/RIT SET]** for 1 sec. to enter the quick set mode.
- ② Rotate **[M-CH]** to select "RF POWER."
- ③ Rotate **[DIAL]** to select the desired output setting.
 - Output power is displayed in 101 steps (Low, 1–100.)
- ④ Push **[M-CH/RIT SET]** to exit the quick set mode and return to normal operation.

Available power

SSB/CW/RTTY : 2–100 W
 AM : 1–25 W* (*Carrier power)

Microphone gain setting

Microphone gain must be adjusted properly so that your signal does not distort when transmitted.

- ① Select SSB or AM mode.
- ② Push and hold **[ANF METER]** for 1 sec. several times to select the ALC meter.
- ③ Push and hold **[M-CH/RIT SET]** for 1 sec. to enter the quick set mode.
- ④ Rotate **[M-CH]** to select "MIC GAIN."
- ⑤ Push **[PTT]** (microphone) to transmit.
 - Speak into the microphone at your normal voice level.
- ⑥ While speaking into the microphone, rotate **[DIAL]** so that the ALC meter reading does not go outside the ALC zone.
 - Microphone gain is adjusted in 1% steps (0% to 100%).
- ⑦ Release **[PTT]** (microphone) to return to receive.
- ⑧ Push **[M-CH/RIT SET]** to exit the quick set mode and return to normal operation.

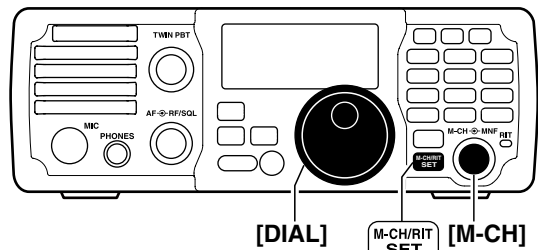

When maximum output power "100" is selected (default)



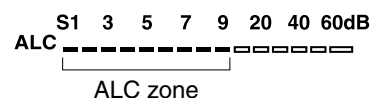

When "50" is selected (default)

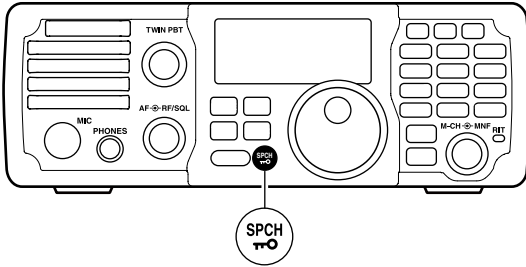

■ Voice synthesizer function

The IC-7200 has a voice synthesizer. This function announces the S-meter level, operating frequency and mode (S-meter level's announcement can be deactivated—p. 77) in a clear, electronically generated voice, in English (or Japanese).



- ① Select the desired parameters to be announced, such as Audio level, speed, language, contents, in the set mode. (p. 77)
- ② Push  to announce the selected contents.
 - Push again to stop the announcement.

■ Operating SSB

- ① Push and hold **F-INP ENT BAND** for 1 sec., then push a band key to select the desired band.
- ② Push **MODE** to select SSB mode.
 - After SSB mode is selected, push and hold **MODE** for 1 sec. to toggle between LSB and USB modes.
 - Below 10 MHz LSB is automatically selected; above 10 MHz USB is automatically selected.
- ③ Rotate **[DIAL]** to tune in a desired signal.
 - The S-meter indicates received signal strength when a signal is received.
- ④ Rotate the **[AF]** control to set audio to a comfortable listening level.
- ⑤ Push **[PTT]** (microphone) to transmit.
 - **TX** appears.
- ⑥ Speak into the microphone at your normal voice level.
 - Adjust 'MIC Gain' at this step, if necessary. (p. 71)
- ⑦ Release **[PTT]** (microphone) to return to receive.

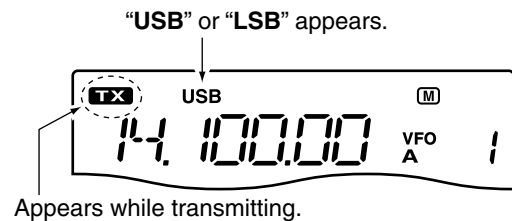
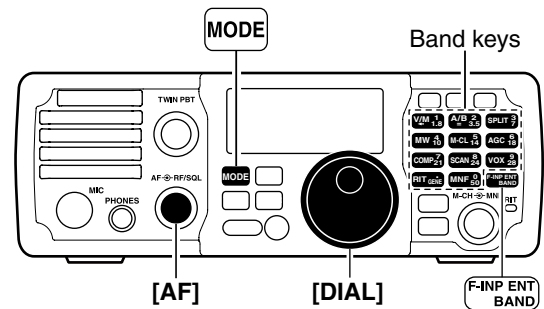

◆ Convenient functions for receive

- **Preamp and attenuator** (p. 45)
 - ➔ Push **P.AMP ATT** to turn the preamp ON or OFF.
 - **P.AMP** appears when the preamp is set to ON.
 - ➔ Push and hold **P.AMP ATT** for 1 sec. to turn the attenuator ON.
 - Push **P.AMP ATT** to turn the attenuator OFF.
 - **ATT** appears when the attenuator is set to ON.
- **Twin PBT (passband tuning)** (p. 46)
 - ➔ Rotate **[TWIN PBT]** (controls—inner/outer).
- **AGC (auto gain control)** (p. 45)
 - ➔ Push **AGC** once or twice to select the time constant for the AGC circuit fast and slow.
 - **F.AGC** appears when the fast time constant is selected, and no indicator appears when the slow time constant is selected, respectively.
 - ➔ Push and hold **AGC** for 1 sec. to turn the AGC function OFF.
 - **AGC-OFF** appears on the display.
- **Noise blanker** (p. 49)
 - ➔ Push **NB** to turn the noise blanker ON or OFF.
 - **NB** appears when the noise blanker is set to ON.
 - ➔ Push and hold **NB** for 1 sec. to enter the noise blanker set mode, then rotate **[DIAL]** to adjust the threshold level, or the blank time.
 - Rotate **[M-CH]** to select an item.
- **Noise reduction** (p. 50)
 - ➔ Push **NR** to turn the noise reduction ON or OFF.
 - **NR** appears when the noise reduction is ON.
 - ➔ Push and hold **NR** for 1 sec. to enter the noise reduction level set mode, then rotate **[DIAL]** to adjust the noise reduction level.
- **Manual notch filter** (pgs. 51, 52)
 - ➔ Push **MNF** to turn the manual notch filter ON or OFF.
 - **MNF** appears when the manual notch filter is set to ON.
 - ➔ Push and hold **MNF** for 1 sec. to enter the manual notch filter set mode, then rotate **[DIAL]** to select the filter width from narrow, middle and wide.
- **Auto notch filter** (p. 51)
 - ➔ Push **ANF METER** to turn the auto notch filter ON or OFF.
 - **ANF** appears when the auto notch filter is set to ON.

◇ Convenient functions for transmit

• VOX (voice operated transmit) (p. 53)

- ➔ Push **[VOX]** to turn the VOX function ON or OFF.
 - “**VOX**” appears when the VOX function is ON.
- ➔ Push and hold **[VOX]** for 1 sec. to enter the VOX set mode, then rotate **[DIAL]** to adjust the VOX gain, anti VOX gain or VOX delay.
 - Rotate **[M-CH]** to select an item.

• Speech compressor (p. 57)

- ➔ Push **[COMP]** to turn the speech compressor ON or OFF.
 - “**COMP**” appears when the speech compressor is ON.
- ➔ Push and hold **[COMP]** for 1 sec. to enter the compression level set mode, then rotate **[DIAL]** to adjust the compression level.

◇ About 5 MHz band operation (USA version only)

Operation on the 5 MHz band is allowed on 5 discrete frequencies and must adhere to the following:

- USB mode
- Maximum of 50 watts ERP (Effective Radiated Power)
- 2.8 kHz bandwidth

It is the operator's responsibility to set all controls so that the transmission in this band meets the stringent conditions under which we may use these frequencies.

NOTE: We recommend that you store these frequencies, mode and filter settings into the memory channel for easy recall.

| IC-7200 Display Frequency* | FCC Channel Center Frequency* |
|-------------------------------|----------------------------------|
| 5.33050 MHz | 5.33200 MHz |
| 5.34650 MHz | 5.34800 MHz |
| 5.36650 MHz | 5.36800 MHz |
| 5.37150 MHz | 5.37300 MHz |
| 5.40350 MHz | 5.40500 MHz |

*The channel center frequencies that are specified by the FCC, show the center frequency of their passband. However, the IC-7200 displays carrier point frequency, so set 1.5 kHz below from FCC channel center frequency.

To assist you in operating the 5 MHz band correctly within the rules specified by the FCC, transmission is impossible on any 5 MHz band frequency other than the 5 frequencies indicated in the table above.

■ Operating CW

- ① Connect a paddle, straight key or external electronic keyer as on page 18.
- ② Push and hold **F-INP ENT BAND** for 1 sec., then push a band key to select the desired band.
- ③ Push **MODE** to select CW mode.
 - After CW mode is selected, push and hold **MODE** for 1 sec. to toggle between CW and CW-R modes.
- ④ Rotate **[DIAL]** to tune in a desired signal with the desired tone frequency.
 - The S-meter indicates received signal strength when signal is received.
- ⑤ Rotate the **[AF]** control to set audio to a comfortable listening level.
- ⑥ Set CW break-in operation and the CW delay time in the set mode. (p. 79)

- ① Push and hold **M-CH/RIT SET** for 1 sec. twice to enter the set mode.
- ② Rotate **[M-CH]** to select “BK-IN” to set the CW break-in operation.
- ③ Rotate **[DIAL]** to select the CW break-in operation from full break-in, semi break-in or OFF.
 - FL : full break-in
 - SE : semi break-in
 - OF : break-in OFF
- ④ Rotate **[M-CH]** to select “BK-DELAY” to select the CW delay time when semi break-in operation is selected in step ③.
- ⑤ Rotate **[DIAL]** to set the desired delay time.
- ⑥ Continue to set the keyer settings in the set mode, if necessary. (p. 80)
- ⑦ Push **M-CH/RIT SET** to exit the set mode and return to normal operation.

- ⑦ Keying to transmit, use the paddle, straight key or external electronic keyer to send your CW signals.
 - “TX” appears.
 - The Po meter indicates the transmit power strength.
- ⑧ Stop keying to return to receive.

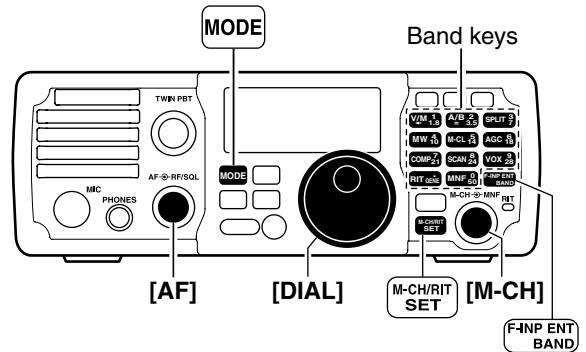

“CW” or “CW-R” appears.

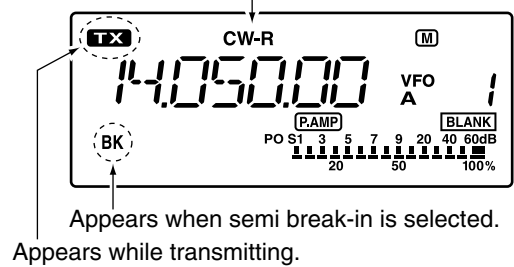

◇ Convenient functions for receive

• Preamp and attenuator (p. 45)

- ➔ Push **[P.AMP ATT]** to turn the preamp ON or OFF.
 - “P.AMP” appears when the preamp is set to ON.
- ➔ Push and hold **[P.AMP ATT]** for 1 sec. to turn the attenuator ON.
 - Push **[P.AMP ATT]** to turn the attenuator OFF.
 - “ATT” appears when the attenuator is set to ON.

• Twin PBT (passband tuning) (p. 46)

- ➔ Rotate **[TWIN PBT]** (controls—inner/outer).

• AGC (auto gain control) (p. 45)

- ➔ Push **[AGC]** once or twice to select the time constant for the AGC circuit fast and slow.
 - “F.AGC” appears when the fast time constant is selected, and no indicator appears when the slow time constant is selected, respectively.
- ➔ Push and hold **[AGC]** for 1 sec. to turn the AGC function OFF.
 - “AGC-OFF” appears on the display.

• Noise blanker (p. 49)

- ➔ Push **[NB]** to turn the noise blanker ON or OFF.
 - “NB” appears when the noise blanker is set to ON.
- ➔ Push and hold **[NB]** for 1 sec. to enter the noise blanker set mode, then rotate **[DIAL]** to adjust the threshold level, or the blank time.
 - Rotate **[M-CH]** to select an item.

• Noise reduction (p. 50)

- ➔ Push **[NR]** to turn the noise reduction ON or OFF.
 - “NR” appears when the noise reduction is ON.
- ➔ Push and hold **[NR]** for 1 sec. to enter the noise reduction level set mode, then rotate **[DIAL]** to adjust the noise reduction level.

• Manual notch filter (pgs. 51, 52)

- ➔ Push **[MNF]** to turn the manual notch filter ON or OFF.
 - “MNF” appears when the manual notch filter is set to ON.
- ➔ Push and hold **[MNF]** for 1 sec. to enter the manual notch filter set mode, then rotate **[DIAL]** to select the filter width from narrow, middle and wide.

• ¼ function (p. 78)

- ① Push and hold **[M-CH/RIT SET]** for 1 sec. twice to enter the set mode.
- ② Rotate **[M-CH]** to select “DIAL ¼”.
- ③ Rotate **[DIAL]** to turn the ¼ function ON or OFF.
- ④ Push **[M-CH/RIT SET]** to exit the set mode and return to normal operation.

• CW pitch control (p. 37)

- ① Push and hold **[M-CH/RIT SET]** for 1 sec. to enter the quick set mode.
- ② Rotate **[M-CH]** to select “CW PITCH”.
- ③ Rotate **[DIAL]** to set the desired CW pitch from 300 to 900 Hz in 10 Hz steps.
- ④ Push **[M-CH/RIT SET]** to exit the quick set mode and return to normal operation.

◇ Convenient functions for transmit

• Break-in function (p. 55)

- ① Push and hold **[M-CH/RIT SET]** for 1 sec. twice to enter the set mode.
- ② Rotate **[M-CH]** to select “BK-IN”.
- ③ Rotate **[DIAL]** to select the CW break-in operation from full break-in, semi break-in or OFF.
 - FL : Full break-in
 - SE : Semi break-in
 - OF : Break-in OFF
- ④ Push **[M-CH/RIT SET]** to exit the set mode and return to normal operation.

• Keying speed setting (p. 38)

- ① Push and hold **[M-CH/RIT SET]** for 1 sec. to enter the quick set mode.
- ② Rotate **[M-CH]** to select “KEY SPD”.
- ③ Rotate **[DIAL]** to adjust the CW key speed from 6 to 60 wpm.
- ④ Push **[M-CH/RIT SET]** to exit the quick set mode and return to normal operation.

◇ CW reverse mode

The CW-R (CW Reverse) mode receives CW signals on the reverse sideband like that of LSB and USB modes.

Use when interference is near the desired signal and you want to shift the tone of the interfering signal.

- ① Push **MODE** several times to select CW mode.
- ② Push and hold **MODE** for 1 sec. to select CW or CW-R mode.
 - Check the interference tone.

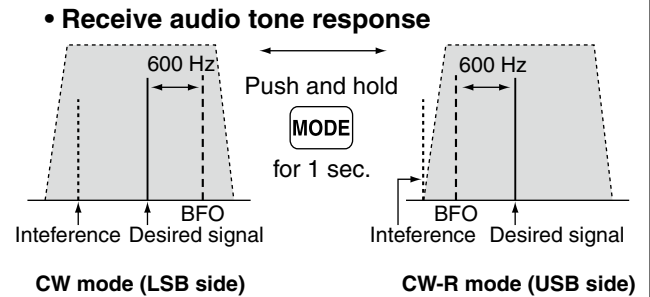
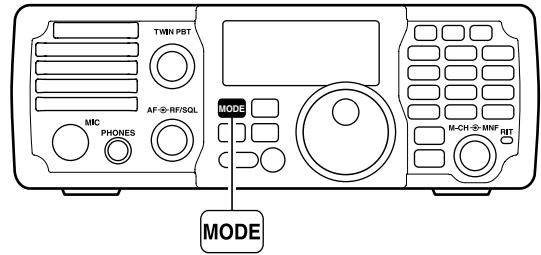

◇ CW pitch control

The received CW audio pitch and monitored CW audio pitch can be adjusted to suit your preferences (300 to 900 Hz) without changing the operating frequency.

- ① When CW (CW-R) mode is selected, push and hold **M-CH/RIT SET** for 1 sec. to enter the quick set mode.
- ② Rotate **[M-CH]** to select "CW PITCH", then rotate **[DIAL]** to set the desired pitch.
 - CW pitch is adjusted in 10 Hz steps (300 to 900 Hz).
- ③ Push **M-CH/RIT SET** to exit the quick set mode and return to normal operation.

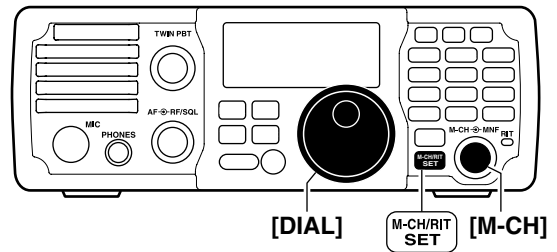

This shows the default setting for the CW pitch control (600 Hz).

◇ CW side tone function

When the transceiver is in receive (and the break-in function is OFF— pgs. 55, 56) you can listen to the tone of your CW signal without actually transmitting.

This allows you to spot your transmit signal exactly compared to another station's. This also convenient for CW practice.

- ① When CW (CW-R) mode is selected, push and hold **M-CH/RIT SET** for 1 sec. to enter the quick set mode.
- ② Rotate **[M-CH]** to select "SIDE LVL", then rotate **[DIAL]** to adjust the side tone level.
 - Side tone level is adjusted in 1% steps (0% to 100%).
- ③ Push **M-CH/RIT SET** to exit the quick set mode and return to normal operation.

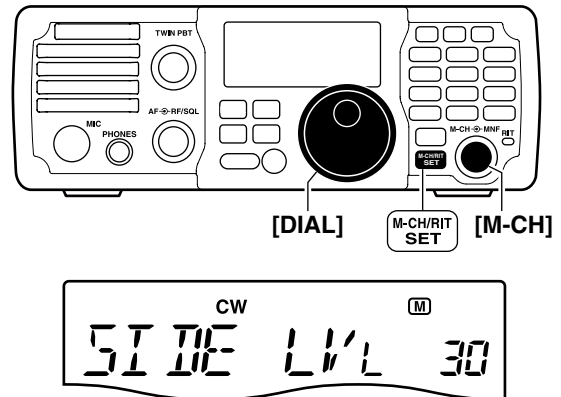

◇ Keying speed setting

The transceiver's internal electronic keyer speed can be adjusted from 6 to 60 wpm.

- ① When CW (CW-R) mode is selected, push and hold **M-CH/RIT SET** for 1 sec. to enter the quick set mode.
- ② Rotate **[M-CH]** to select "KEY SPD", then rotate **[DIAL]** to adjust the keying speed.
- ③ Push **M-CH/RIT SET** to exit the quick set mode and return to normal operation.

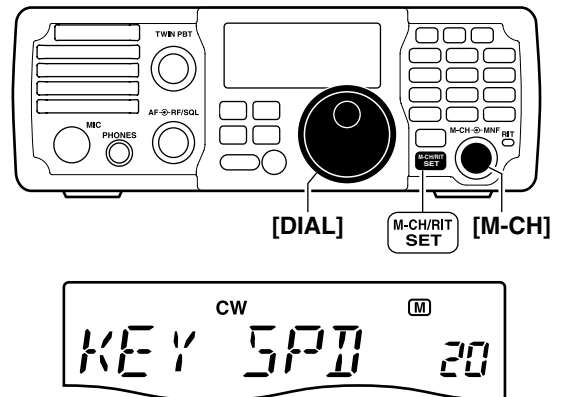

■ Operating RTTY (FSK)

When using your RTTY terminal or TNC, consult the manual that comes with the RTTY terminal or TNC.

- ① Push and hold **F-INP ENT BAND** for 1 sec., then push a band key to select the desired band.
- ② Push **MODE** to select RTTY mode.
 - After RTTY mode is selected, push and hold **MODE** for 1 sec. to toggle between RTTY and RTTY-R modes.
- ③ Rotate **[DIAL]** to tune in a desired signal.
 - The S-meter indicates received signal strength when signal is received.
 - If the received signal cannot be demodulated, try selecting RTTY-R mode (or RTTY mode).
- ④ Transmit a SEND signal from your TNC.
 - “**TX**” appears.
 - The Po meter indicates the transmitted RTTY signal strength.
- ⑤ Use the connected PC or TNC (TU) to transmit RTTY (FSK) signals.

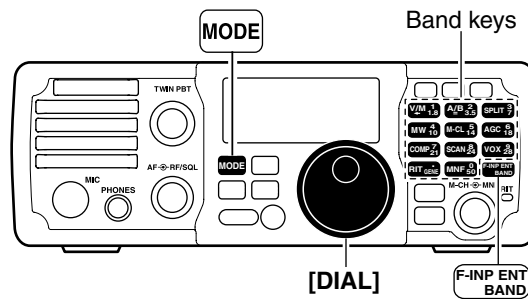

Appears while transmitting.
“RTTY” or “RTTY-R” appears.



◇ Convenient functions for receive

• Preamp and attenuator (p. 45)

- ➔ Push **P.AMP ATT** to turn the preamp ON or OFF.
 - “**P.AMP**” appears when the preamp is set to ON.
- ➔ Push and hold **P.AMP ATT** for 1 sec. to turn the attenuator ON.
 - Push **P.AMP ATT** to turn the attenuator OFF.
 - “**ATT**” appears when the attenuator is set to ON.

• Twin PBT (passband tuning) (p. 46)

- ➔ Rotate **[TWIN PBT]** (controls-inner/outer).

• AGC (auto gain control) (p. 45)

- ➔ Push **AGC** once or twice to select the time constant for the AGC circuit fast and slow.
 - “**F.AGC**” appears when the fast time constant is selected, and no indicator appears when the slow time constant is selected, respectively.
- ➔ Push and hold **AGC** for 1 sec. to turn the AGC function OFF.
 - “**AGC-OFF**” appears on the display.

• Noise blanker (p. 49)

- ➔ Push **NB** to turn the noise blanker ON or OFF.
 - “**NB**” appears when the noise blanker is set to ON.
- ➔ Push and hold **NB** for 1 sec. to enter the noise blanker set mode, then rotate **[DIAL]** to adjust the threshold level, or the blank time.
 - Rotate **[M-CH]** to select an item.

• Noise reduction (p. 50)

- ➔ Push **NR** to turn the noise reduction ON or OFF.
 - “**NR**” appears when the noise reduction is ON.
- ➔ Push and hold **NR** for 1 sec. to enter the noise reduction level set mode, then rotate **[DIAL]** to adjust the noise reduction level.

• Manual notch filter (pgs. 51, 52)

- ➔ Push **MNF** to turn the manual notch filter ON or OFF.
 - “**MNF**” appears when the manual notch filter is set to ON.
- ➔ Push and hold **MNF** for 1 sec. to enter the manual notch filter set mode, then rotate **[DIAL]** to select the filter width from narrow, middle and wide.

• ¼ function (p. 78)

- ① Push and hold **M-CH/RIT SET** for 1 sec. twice to enter the set mode.
- ② Rotate **[M-CH]** to select “**DIAL ¼**”.
- ③ Rotate **[DIAL]** to turn the ¼ function ON or OFF.
- ④ Push **M-CH/RIT SET** to exit the set mode and return to normal operation.

◇ RTTY reverse mode

Received characters are occasionally garbled when the receive signal is reversed between MARK and SPACE. This reversal can be caused by incorrect TNC connections, settings, commands, etc.

To receive a reversed RTTY signal correctly, select RTTY-R (RTTY reverse) mode.

- ① Push **MODE** to select RTTY mode.
- ② After RTTY mode is selected, push and hold **MODE** for 1 sec. to toggle between RTTY and RTTY-R modes.

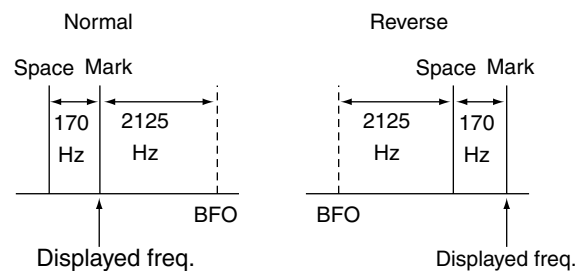
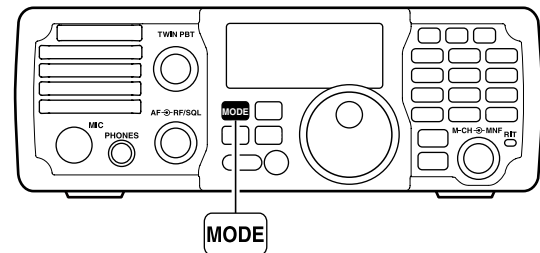

◇ Twin peak filter

The twin peak filter changes the receive frequency response by boosting two particular frequencies (2125 and 2295 Hz) for better copying of desired RTTY signals.

- ① Push **MODE** to select RTTY mode.
 - After RTTY mode is selected, push and hold **MODE** for 1 sec. to toggle between RTTY and RTTY-R modes.
- ② Push and hold **M-CH/RIT SET** for 1 sec. to enter the quick set mode.
- ③ Rotate **[M-CH]** to select "TPF", then rotate **[DIAL]** to select the twin peak filter function ON or OFF.
 - The received audio volume may become greater when the twin peak filter is turned ON.
- ④ Push **M-CH/RIT SET** to exit the quick set mode and return to normal operation.

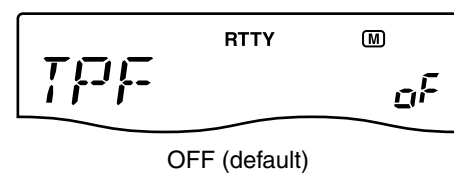
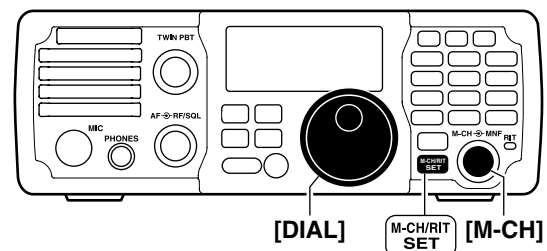

◇ RTTY decode set mode

Set the RTTY key polarity, shift width and mark tone.

- ① When RTTY (RTTY-R) mode is selected, push and hold **M-CH/RIT SET** for 1 sec. to enter the quick set mode.
- ② Rotate **[M-CH]** to select the desired set item.
- ③ Rotate **[DIAL]** to adjust the desired value or condition.
 - Push and hold **M-CL** for 1 sec. to return to the default value.
- ④ Push **M-CH/RIT SET** to exit the quick set mode and return to normal operation.

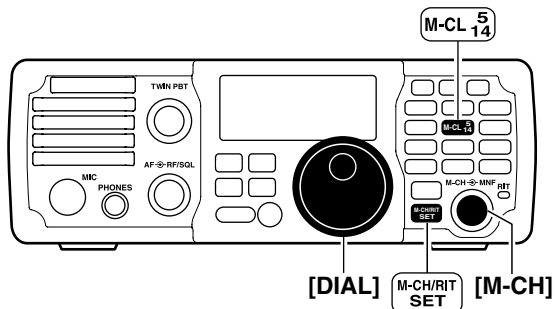

RTTY mark tone (RTTY mode)

This item selects the RTTY mark frequency. RTTY mark frequency is switched between 1275, 1615 and 2125 Hz.

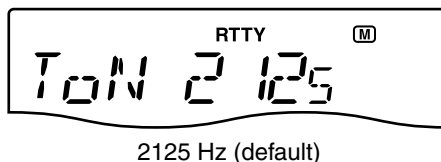

RTTY shift width (RTTY mode)

This item adjusts the RTTY shift width. There are 4 selectable values: 170, 200, 425 and 850 Hz.

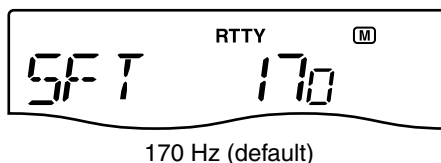

RTTY key polarity (RTTY mode)

This item selects the RTTY keying polarity. Normal or reverse keying polarity can be selected. When reverse polarity is selected, Mark and Space are reversed.

- n (normal) : Key open/close = Mark/Space
- r (reverse) : Key open/close = Space/Mark

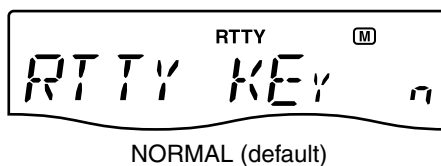

■ Operating AM

- ① Push and hold **[F-INP ENT BAND]** for 1 sec., then push a band key to select the desired band.
- ② Push **[MODE]** to select AM mode.
- ③ Rotate **[DIAL]** to tune in a desired signal.
 - The S-meter indicates received signal strength when a signal is received.
 - The default tuning step for AM mode is 1 kHz; this can be changed using the tuning step program mode. (p. 26)
- ④ Rotate the **[AF]** control to set audio to a comfortable listening level.
- ⑤ Push **[PTT]** (microphone) to transmit.
 - “**TX**” appears.
- ⑥ Speak into the microphone at your normal voice level.
 - Adjust ‘MIC Gain’ at this step, if necessary. (p. 71)
- ⑦ Release **[PTT]** (microphone) to return to receive.

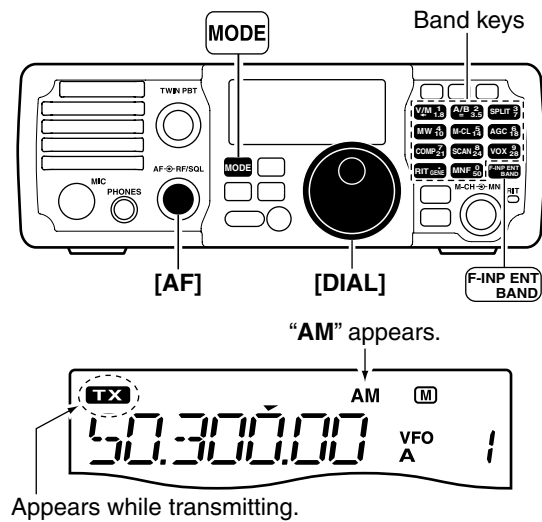

◇ Convenient functions for receive

- **Preamp and attenuator** (p. 45)
 - ➔ Push **[P.AMP ATT]** to turn the preamp ON or OFF.
 - “**P.AMP**” appears when the preamp is set to ON.
 - ➔ Push and hold **[P.AMP ATT]** for 1 sec. to turn the attenuator ON.
 - Push **[P.AMP ATT]** to turn the attenuator OFF.
 - “**ATT**” appears when the attenuator is set to ON.
- **AGC (auto gain control)** (p. 45)
 - ➔ Push **[AGC]** once or twice to select the time constant for the AGC circuit fast and slow.
 - “**F.AGC**” appears when the fast time constant is selected, and no indicator appears when the slow time constant is selected, respectively.
 - ➔ Push and hold **[AGC]** for 1 sec. to turn the AGC function OFF.
 - “**AGC-OFF**” appears on the display.
- **Noise blanker** (p. 49)
 - ➔ Push **[NB]** to turn the noise blanker ON or OFF.
 - “**NB**” appears when the noise blanker is set to ON.
 - ➔ Push and hold **[NB]** for 1 sec. to enter the noise blanker set mode, then rotate **[DIAL]** to adjust the threshold level, or the blank time.
 - Rotate **[M-CH]** to select an item.
- **Twin PBT (passband tuning)** (p. 46)
 - ➔ Rotate **[TWIN PBT]** (controls–inner/outer).
- **Noise reduction** (p. 50)
 - ➔ Push **[NR]** to turn the noise reduction ON or OFF.
 - “**NR**” appears when the noise reduction is ON.
 - ➔ Push and hold **[NR]** for 1 sec. to enter the noise reduction level set mode, then rotate **[DIAL]** to adjust the noise reduction level.
- **Manual notch filter** (pgs. 51, 52)
 - ➔ Push **[MNF]** to turn the manual notch filter ON or OFF.
 - “**MNF**” appears when the manual notch filter is set to ON.
 - ➔ Push and hold **[MNF]** for 1 sec. to enter the manual notch filter set mode, then rotate **[DIAL]** to select the filter width from narrow, middle and wide.
- **Auto notch filter** (p. 51)
 - ➔ Push **[ANF METER]** to turn the auto notch filter ON or OFF.
 - “**ANF**” appears when the auto notch filter is set to ON.

◇ Convenient functions for transmit

- **VOX (voice operated transmit)** (p. 53)
 - ➔ Push **[VOX]** to turn the VOX function ON or OFF.
 - “**VOX**” appears when the VOX function is ON.
 - ➔ Push and hold **[VOX]** for 1 sec. to enter the VOX set mode, then rotate **[DIAL]** to adjust the VOX gain, anti VOX gain or VOX delay.
 - Rotate **[M-CH]** to select an item.

■ Data mode (SSTV/PSK31) operation

When operating SSTV or PSK31 with your PC software, consult the manual that is supplied with the software.

- ① Connect a PC to the transceiver. (p. 20)
- ② Push and hold **F-INP ENT BAND** for 1 sec., then push a band key to select the desired band.
- ③ Push **MODE** to select SSB or AM mode.
 - After SSB mode is selected, push and hold **MODE** for 1 sec. to toggle between USB and LSB modes.
- ④ Turn data mode ON in the quick set mode.

- ① Push and hold **M-CH/RIT SET** for 1 sec. to enter the quick set mode.
- ② Rotate **[M-CH]** to select "DATA" to set the data mode.
- ③ Rotate **[DIAL]** to select the data mode ON or OFF.
 - "D" appears when the data mode is turned ON.
- ④ Push **M-CH/RIT SET** to exit the quick set mode and return to normal operation.

- ⑤ Rotate **[DIAL]** to tune in a desired signal and decoded correctly.
 - The S-meter indicates received signal strength when a signal is received.
 - Also use the tuning indicator of the software.
 - During SSB data mode, ¼ tuning function can be used for critical tuning.
- ⑥ Use the PC (software) to transmit.
 - When operating in SSB data mode, adjust the AF output level from PC so that the ALC meter reading doesn't go outside the ALC zone.

NOTE: When the data mode is selected, the audio input from the **[ACC]** connector* is used for transmission instead of **[MIC]** connector. The speech compressor function is turned OFF for the SSB data mode transmission.
 * The desired connector can be selected in the set mode. (p. 77)

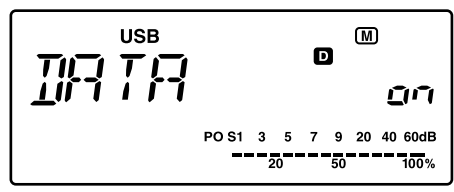
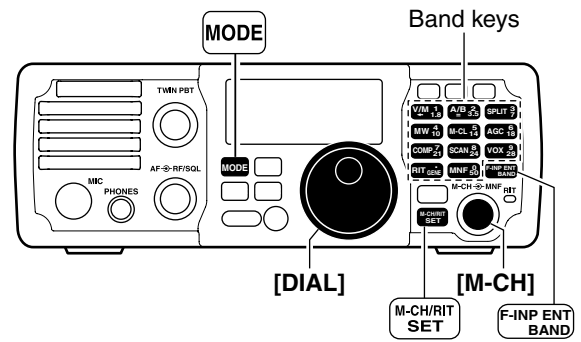

Data mode: ON (default: OFF)

Either "USB" or "LSB" appears.

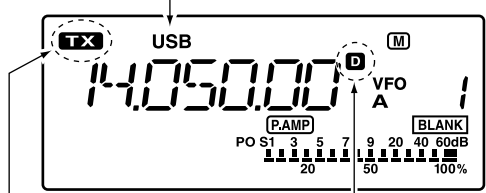

Appears while transmitting. Appears

✓ For your information
 Carrier point frequency is displayed when SSB data mode is selected.
 See the diagram below for the tone-pair example.

• **Example**— LSB/LSB data mode
 Mark freq.: 2125 Hz
 Shift freq.: 200 Hz

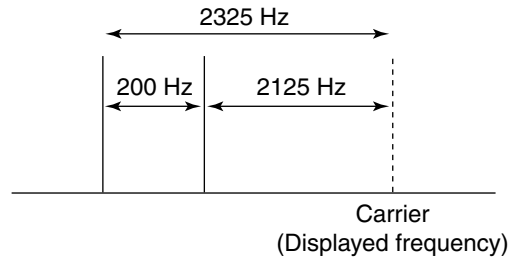

■ RIT function

The RIT (Receive Incremental Tuning) function compensates for stations transmitting off-frequency or when you prefer to listen to slightly different-sounding voice characteristics, etc.

The function shifts the receive frequency up to ± 9.999 kHz in 1 Hz steps (10 Hz steps when cancelling the 1 Hz step readout) without moving the transmit frequency.

- ① Push **[RIT]** to turn the RIT function ON.
 - “**[RIT]**” and the shift frequency are indicated.
 - The shift frequency is indicated for approx. 1 sec., then returns to the operating frequency.
 - The RIT control indicator lights orange.
 - If the RIT control indicator does not light, push **[M-CH/RIT SET]**. (See below for details)
- ② Rotate the **[M-CH]** control to compensate for off-frequency stations.
 - The transmit frequency is not shifted.
 - The shift frequency is indicated for about 1 sec. when rotating the **[M-CH]** control.
- ③ To cancel the RIT function, push **[RIT]** again.
 - “**[RIT]**” disappears.
 - The RIT control indicator goes out.

/// About the **[M-CH]** control:

The **[M-CH]** control selects the memory channel and also shifts the RIT frequency. Pushing **[M-CH/RIT SET]** toggles the **[M-CH]** control as M-CH selector or RIT controller.
 RIT controller: RIT control indicator lights orange.
 M-CH selector: RIT control indicator goes out.

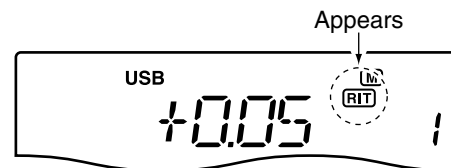
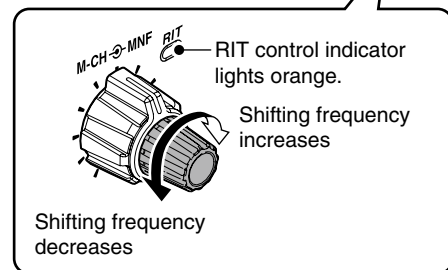
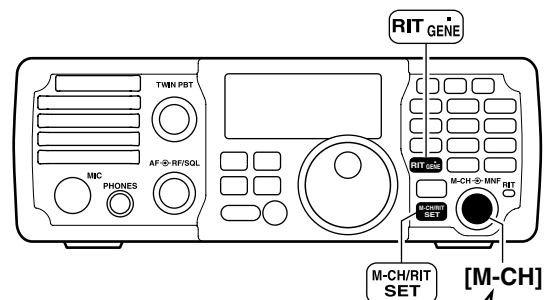

• RIT monitor function

When the XFC (transmit frequency check function) is ON (p. 76), pushing and holding **[RIT]** allows you to monitor the operating frequency directly (RIT is temporarily cancelled).

• Calculate function

The shift frequency of the RIT function can be added/subtracted to the displayed frequency.

When the RIT function is ON, push and hold **[RIT]*** for 1 sec.

- The RIT frequency is automatically reset.

* Available only when the XFC (transmit frequency check function) is turned OFF. (p. 76)

■ Preamp and attenuator

The preamp amplifies received signals in the receiver input (front end) circuit to improve the S/N ratio and sensitivity. Turn this function ON when receiving weak signals.

The attenuator prevents very strong signals near the desired frequency, such as nearby broadcast stations or very strong amateur signals, from causing distortion of a desired signal.

- ➔ Push **P.AMP ATT** momentarily to turn the preamp ON and OFF; push and hold for 1 sec. to turn the attenuator ON.
 - “**P.AMP**” appears when the preamp is ON; “**ATT**” appears when the 20 dB attenuator is ON.
 - Only one of these functions can be activated at a time.

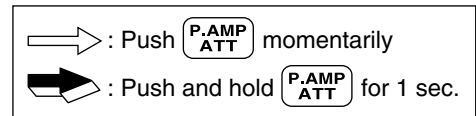
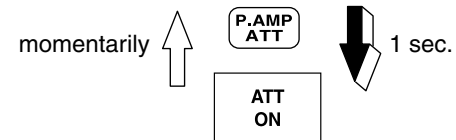
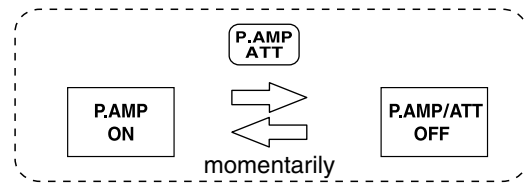
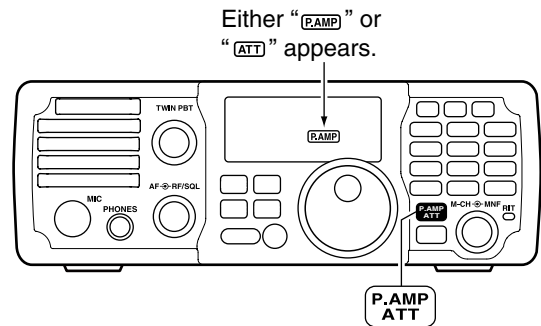

■ AGC function

The AGC (auto gain control) controls receiver gain to produce a constant audio output level even when the received signal strength is varied by fading, etc.

◇ AGC time constant selection

- ① Push **MODE** once or twice to select the desired mode.
- ② Push **AGC** once or twice to select AGC fast or AGC slow.
 - “**F.AGC**” appears for AGC fast; no indicator for AGC slow is selected, respectively.
- ③ Push and hold **AGC** for 1 sec. to turn the AGC OFF.
 - “**AGC-OFF**” appears for AGC OFF.

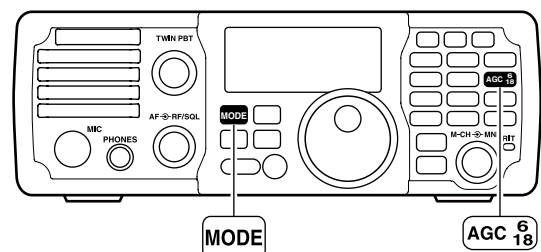

■ Twin PBT operation

The general PBT (Passband Tuning) function electronically narrows the IF passband width by shifting the IF frequency slightly outside of the IF filter passband to reject interference. This transceiver uses the DSP circuit for the PBT function.

By rotating both **[TWIN PBT]** controls (inner/outer; PBT1 and PBT2) with the same position, PBT functions as an IF shift control.

The limit of the variable range depends on the passband width and mode. The limit of the variable range is half of the passband width, and PBT is adjustable in 200 Hz (AM) or 50 Hz (other models) steps.

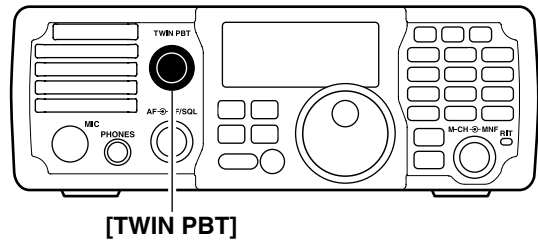

- The **[TWIN PBT]** controls should normally be set to the center positions (PBT setting is cleared) when there is no interference.
- When PBT is used, the audio tone may be changed.
- While rotating the **[TWIN PBT]** controls, noise may occur. This comes from the DSP unit and does not indicate an equipment malfunction.

PBT OPERATION EXAMPLE

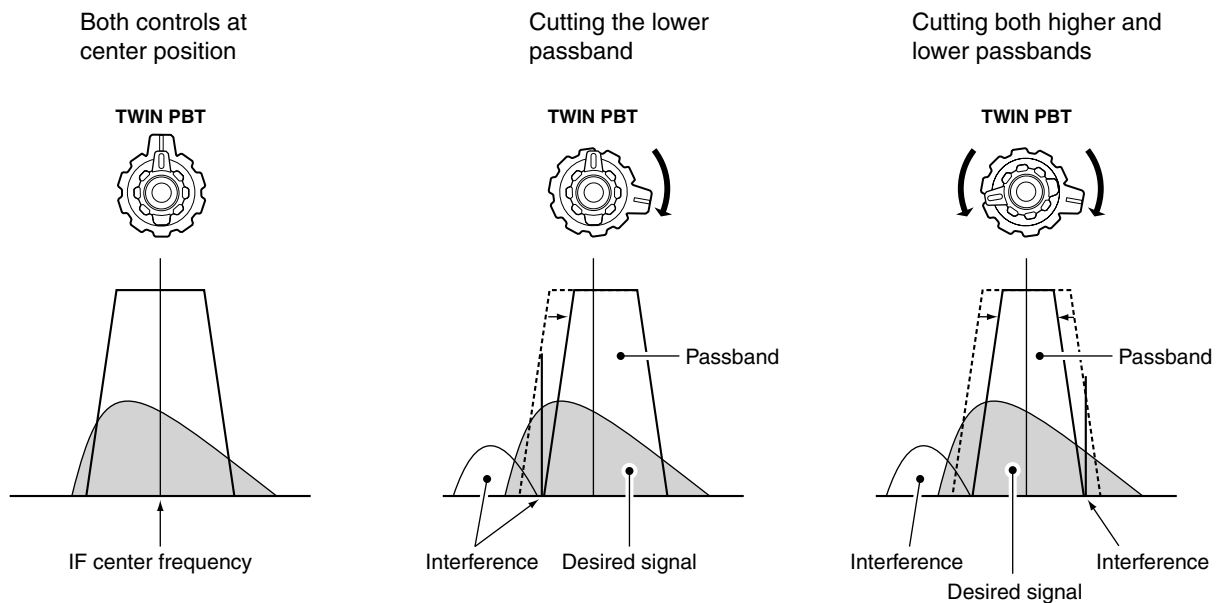

■ IF filter selection

The transceiver has 3 passband IF filter widths for each mode.

For SSB and CW modes, the passband width can be set from 50 to 3600 Hz in 50 or 100 Hz steps. A total of 41 passband widths are available.

For RTTY mode, the passband width can be set from 50 to 2700 Hz in 50 or 100 Hz steps. A total of 32 passband widths are available.

For AM mode, the passband width can be set from 200 to 8000 Hz in 200 Hz steps. A total of 40 passband widths are available.

/// The filter selection is automatically memorized in each mode.

◇ IF filter selection

- ① Push **MODE** several times to select the desired mode.
- ② Push **FILTER** several times to select the IF filter from Wide, Middle or Narrow.
 - The selected IF filter indicator (“**W**”, “**M**” or “**N**”) appears in the LCD.

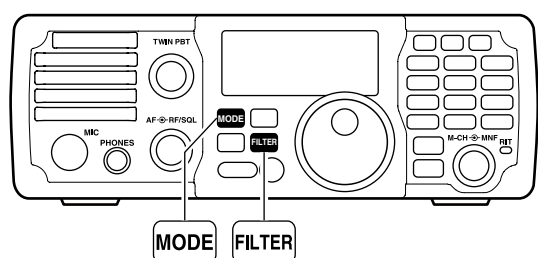

Selected IF filter indicator

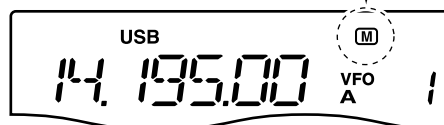

◇ Filter passband width setting

- ① Push **MODE** several times to select the desired mode.
- ② Push and hold **FILTER** for 1 sec. to enter filter set mode.
- ③ Rotate **[M-CH]** to select “FIL.”
- ④ Push **FILTER** several times to select the desired IF filter.
- ⑤ Rotate **[DIAL]** to set the desired passband width.
 - The passband width can be set within the range as shown in the table at right below.
 - Push and hold **M-CL** for 1 sec. to return to the default value.
- ⑥ Repeat steps ④ and ⑤ if desired.
- ⑦ Push and hold **FILTER** for 1 sec. to exit the filter set mode.

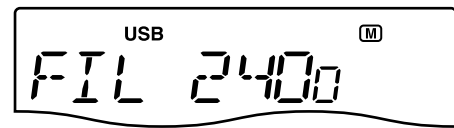
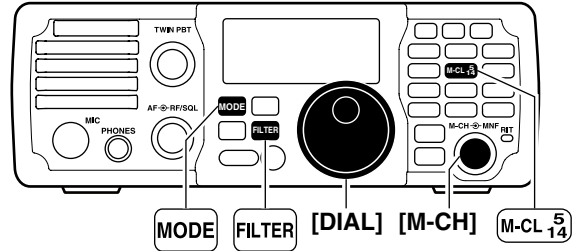

| Mode | Filter | Default | Range (Steps) |
|-----------------|--------|---------|--|
| SSB | Wide | 3000 Hz | 50–500 Hz (50 Hz)/ 600–3600 Hz (100 Hz) |
| | Middle | 2400 Hz | |
| | Narrow | 1800 Hz | |
| SSB Data/ CW | Wide | 1200 Hz | 50–500 Hz (50 Hz)/ 600–3600 Hz (100 Hz) |
| | Middle | 500 Hz | |
| | Narrow | 250 Hz | |
| RTTY | Wide | 2400 Hz | 50–500 Hz (50 Hz)/ 600–2700 Hz (100 Hz) |
| | Middle | 500 Hz | |
| | Narrow | 250 Hz | |
| AM/ AM Data | Wide | 8000 Hz | 200–8000 Hz (200 Hz) |
| | Middle | 6000 Hz | |
| | Narrow | 3000 Hz | |

When the IF passband width is set to minimum by the **[TWIN PBT]** controls (when one control is max. counterclockwise, and the other one is max. clockwise; p. 46), a sound may not come from the speaker depending on the IF filter passband width setting. This is not a transceiver’s malfunction.

◇ IF filter shape (SSB/CW only)

The type of DSP filter shape for SSB and CW can be selected independently from soft and sharp.

- ① Push **MODE** several times to select SSB or CW mode.
- ② Push and hold **FILTER** for 1 sec. to enter filter set mode.
- ③ Rotate **[M-CH]** to select “SHAPE.”
- ④ Push **FILTER** several times to select the desired IF filter from Wide, Middle or Narrow.
- ⑤ Rotate **[DIAL]** to select the desired filter shape, either soft or sharp
 - Push and hold **M-CL** for 1 sec. to return to the default value.
- ⑥ Push and hold **FILTER** for 1 sec. to exit the filter set mode.

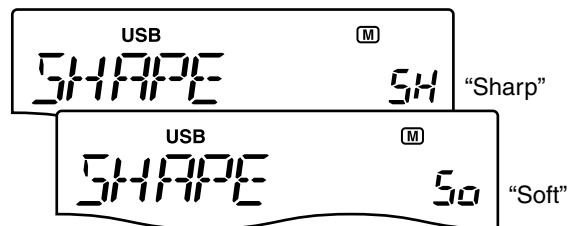
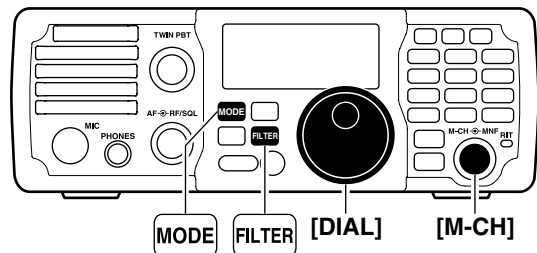

■ Noise blanker

The noise blanker eliminates pulse-type noise such as from car ignition systems.

- ➔ Push **[NB]** to turn the noise blanker ON or OFF.
- “**[NB]**” appears when the NB function is ON.

When using the noise blanker, received signals may be distorted if they are excessively strong or the noise type is other than impulse. Nearby strong signals can also cause the noise blanker to create distortion. Turn the noise blanker function OFF, or adjust the noise blanker level to a shallower setting (see below) in this case.

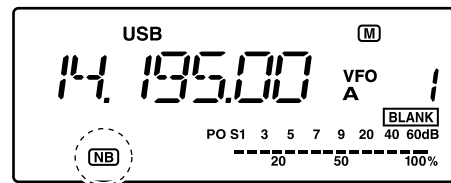
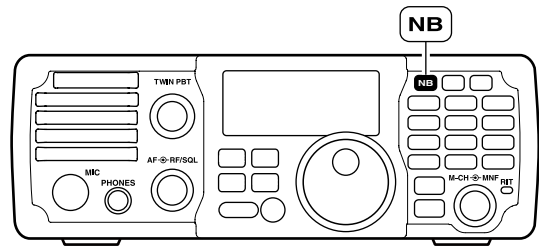

Appears

◇ Noise blanker settings

- ① Push and hold **[NB]** for 1 sec. to enter the noise blanker set mode.
 - The noise blanker is turned ON and “**[NB]**” appears.
- ② Rotate **[M-CH]** to select the desired set item.
- ③ Rotate **[DIAL]** to adjust the desired condition.
 - Push and hold **[M-CL]** for 1 sec. to return to the default value.
- ④ Push **[NB]** to exit the noise blanker set mode.
- ⑤ Push **[NB]** to turn the noise blanker OFF if necessary.
 - “**[NB]**” disappears.

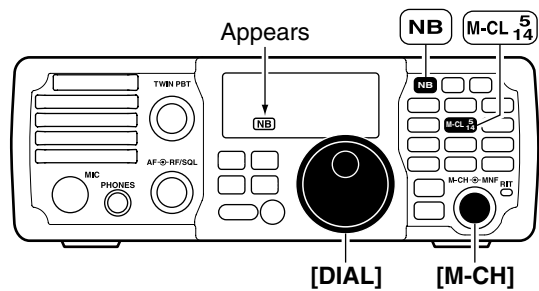

NB LEVEL

This item adjusts the noise blanker level. The noise blanker attenuation level can be adjusted from 0% to 100%.

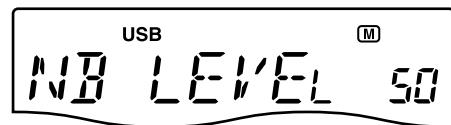

50% (default)

NB WIDTH

This item allows adjustment of the blank time for noise blanker to match the pulse width. The noise blanker width can be adjusted from 1% to 100%.



50% (default)

■ Noise reduction

The noise reduction enhances desired signals in the presence of noise by using the DSP circuit to remove random noise. The amount of enhancement is adjustable.

- ➔ Push **NR** to turn the noise reduction ON or OFF.
 - “**NR**” appears when the NR function is ON.

▨ The noise reduction level can result in audio signal masking. Set the noise reduction level for maximum readability as described below.

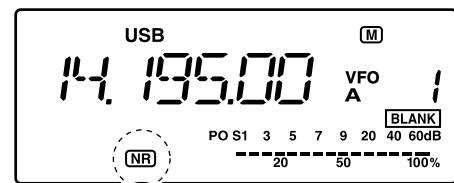
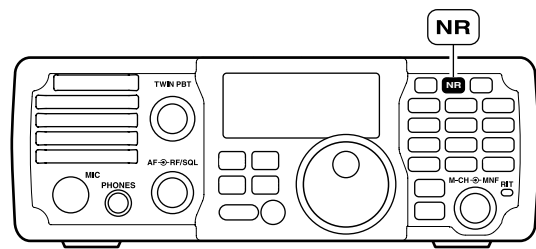

Appears

Noise reduction OFF
NR Level 0

Noise components

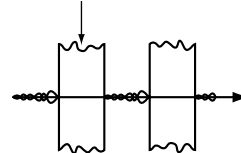

Noise reduction is activated
NR Level 4 (default)

Desired signal (CW)

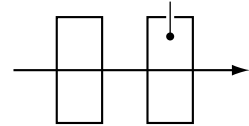

◇ Noise reduction level setting

- ① Push and hold **NR** for 1 sec. to enter the noise reduction level set mode.
 - The noise reduction is turned ON and “**NR**” appears.
- ② Rotate **[DIAL]** to adjust the noise reduction level.
 - The noise reduction level can be adjusted from 0 to 15.
 - Push and hold **M-CL** for 1 sec. to return to the default value.
- ③ Push **NR** to exit the noise reduction set mode.
- ④ Push **NR** to turn the noise reduction OFF if necessary.
 - “**NR**” disappears.

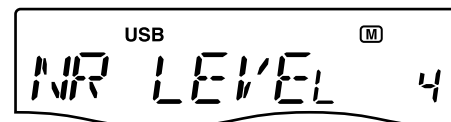
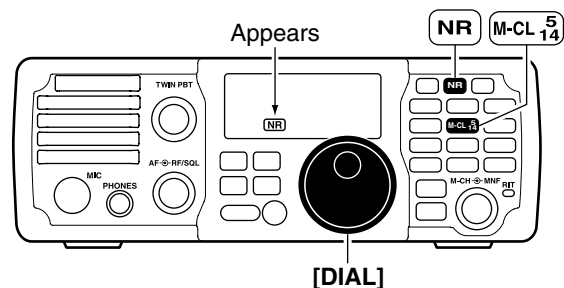

4 (default)

Notch function

This transceiver has auto and manual notch functions.

The auto notch function automatically attenuates beat tones, tuning signals, changing frequency, etc., even if they are moving.

The manual notch can be set to attenuate a frequency via the [MNF] control.

- ➔ Push **[ANF METER]** to turn the auto notch function ON or OFF.
 - “**[ANF]**” appears when the auto notch function is ON.
 - The auto notch function is available while in SSB or AM mode.
- ➔ Push **[MNF]** to turn the manual notch function ON or OFF.
 - “**[MNF]**” appears when the manual notch function is ON.
 - While in SSB or AM mode, either the auto or manual notch function can be turned ON. These functions are selected by pushing **[ANF METER]** or **[MNF]**.
 - Manual notch filter setting is described on the next page.

Auto notch function

The auto notch can be used in SSB and AM modes.

- ➔ Push **[ANF METER]** to turn the automatic notch function ON or OFF.

- “**[ANF]**” appears when the auto notch function is ON.

Auto notch OFF

Auto notch ON

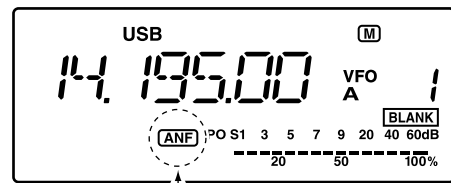
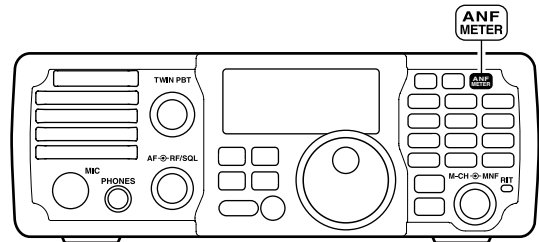
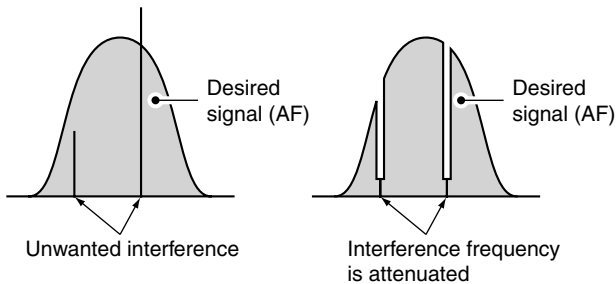

Appears

Manual notch function

- ➔ Push **[MNF]** to turn the manual notch function ON or OFF.

- “**[MNF]**” appears when the manual notch function is ON.
- Set to attenuate a frequency for manual notch via the [MNF] control.
- Set the frequency for manual notch filtering via the manual notch filter set mode. (described on the next page)

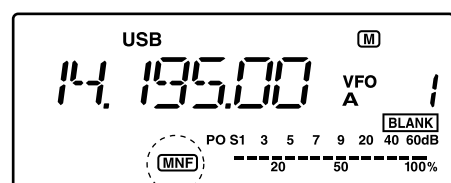
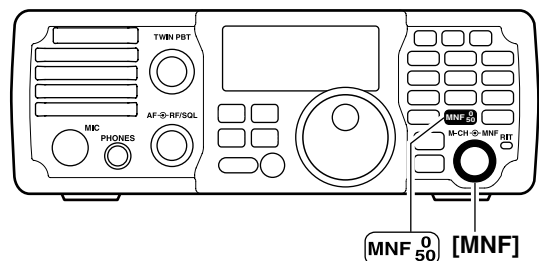

Appears

◇ Manual notch filter setting

- ① Push and hold **MNF** for 1 sec. to enter the manual notch filter set mode.
 - The manual notch function is turned ON and “**MNF**” appears.
- ② Rotate **[DIAL]** to select the filter width from narrow, middle and wide.
 - Push and hold **M-CL** for 1 sec. to return to the default value.
- ③ Push **MNF** to exit the manual notch filter set mode.
- ④ Push **MNF** to turn the manual notch function OFF if necessary.
 - “**MNF**” disappears.

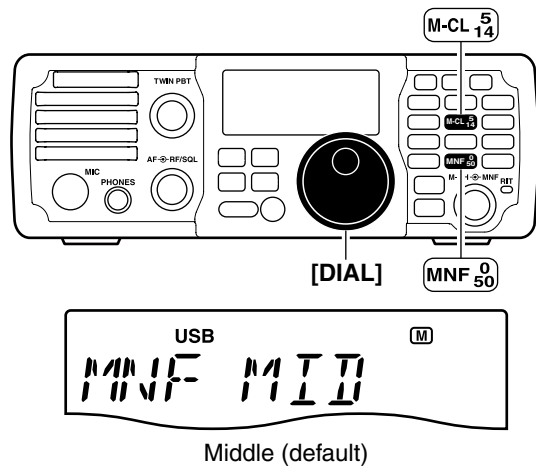

While adjusting the manual notch filter, noise may be heard. This comes from the DSP unit and does not indicate an equipment malfunction.

■ VOX function

The VOX (Voice-Operated Transmission) function uses your voice to switch between transmit and receive. This function provides an opportunity for hands-free operation or to input log entries into your computer, etc., while operating.

- ① Push **MODE** to select a phone mode (SSB or AM).
 - When SSB mode is selected, push and hold **MODE** for 1 sec. to toggle between USB and LSB modes.
- ② Push **VOX** to toggle the VOX function ON and OFF.
 - “**VOX**” appears when the VOX function is ON.

The VOX gain, ANTI-VOX and VOX delay can be set in VOX set mode. (See below.)

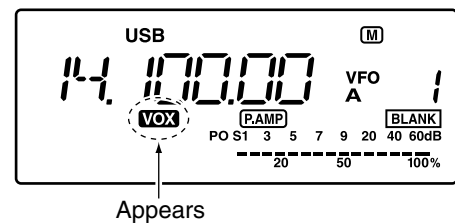
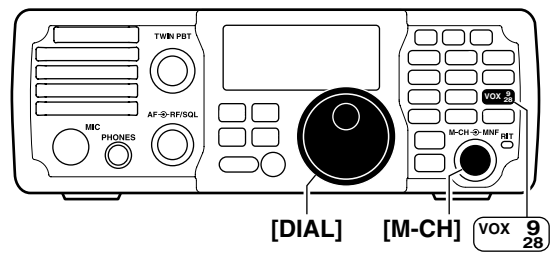

◇ Adjusting the VOX function

- ① Push **MODE** to select a phone mode (SSB or AM).
 - When SSB mode is selected, push and hold **MODE** for 1 sec. to toggle between USB and LSB modes.
- ② Push **VOX** to toggle the VOX function ON and OFF.
 - “**VOX**” appears when the VOX function is ON.
- ③ Adjust the VOX functions in the VOX set mode.

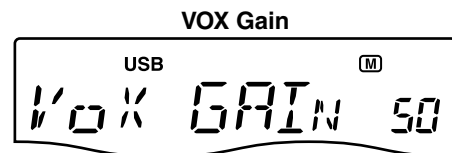
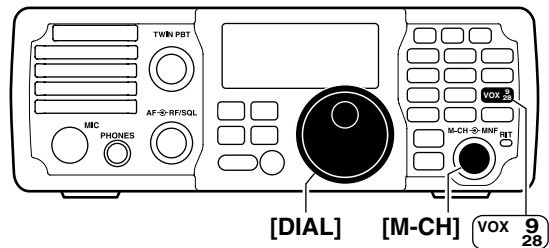

50% (default)

- ① Push and hold **VOX** for 1 sec. to enter the VOX set mode.
- ② Rotate **[M-CH]** to select “**VoX GAIN.**”
- ③ While speaking into the microphone with your normal voice level, rotate **[DIAL]** to the point where the transceiver is continuously transmitting.
- ④ Rotate **[M-CH]** to select “**ANTI-Vox.**”
- ⑤ During receive, rotate **[DIAL]** to adjust the anti-VOX gain to the point where the transceiver does not switch to transmit due to received audio from the speaker.
- ⑥ Rotate **[M-CH]** to select “**VoX DELY.**”
- ⑦ Rotate **[DIAL]** to adjust the VOX delay for a convenient interval before returning to receive.
- ⑧ Push **VOX** to exit the VOX set mode. and return to normal operation.

◇ VOX set mode

VOX GAIN

This item adjusts the VOX gain for the VOX (Voice-Operated Transmission) function. Higher values make the VOX function more sensitive to your voice.

This setting can be adjusted from 0% to 100% in 1% steps.

- Push and hold **M-CL** for 1 sec. to return to the default value.



50% (default)

ANTI-VOX

This item adjusts the ANTI-VOX gain for the VOX (Voice-Operated Transmission) function. Higher values make the VOX function less sensitive to receiver output audio from a speaker or headphones.

This setting can be adjusted from 0% to 100% in 1% steps.

- Push and hold **M-CL** for 1 sec. to return to the default value.

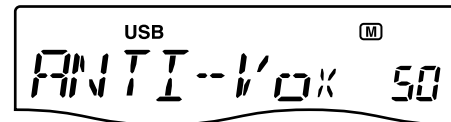

50% (default)

VOX DELAY

This item adjusts the VOX (Voice-Operated Transmission) delay time. VOX Delay is the amount of time the transmitter stays on after you stop speaking.

The delay time can be adjusted from 0 to 2.0 sec. in 0.1 sec. steps.

- Push and hold **M-CL** for 1 sec. to return to the default value.



0.2 sec. (default)

■ Break-in function

The break-in function is used in CW mode to automatically switch the transceiver between transmit and receive when keying. The IC-7200 is capable of full break-in or semi break-in. Break-in operation is also referred to as QSK.

◇ Semi break-in operation

During semi break-in operation, the transceiver immediately transmits when keying, then automatically returns to receive after a pre-set delay time has passed from when you stop keying. This is similar to VOX operation for voice.

- ① Push **MODE** to select CW or CW-R mode.
 - When CW mode is selected, push and hold **MODE** for 1 sec. to toggle between CW and CW-R modes.

- ② Set the semi break-in function ON in the set mode.

- ① Push and hold **M-CH/RIT SET** for 1 sec. twice to enter the set mode.
- ② Rotate **[M-CH]** to select “BK-IN” to set the CW break-in operation.
- ③ Rotate **[DIAL]** to select “SE.”
 - FL : Full break-in
 - SE : Semi break-in
 - OF : Break-in OFF
- ④ Rotate **[M-CH]** to select “BK-DELAY” to select the CW delay time when semi break-in operation is selected in step ③.
- ⑤ Rotate **[DIAL]** to set the desired delay time.
 - The delay time is selectable from 0.2 to 13.0 (dots) in 0.1 (dots) steps.
- ⑥ Push **M-CH/RIT SET** to exit the set mode and return to normal operation.

- ③ “BK” appears on the LCD.

/// When using a paddle, set “KEY SPD” in the quick set mode to adjust the keying speed. (p. 72)

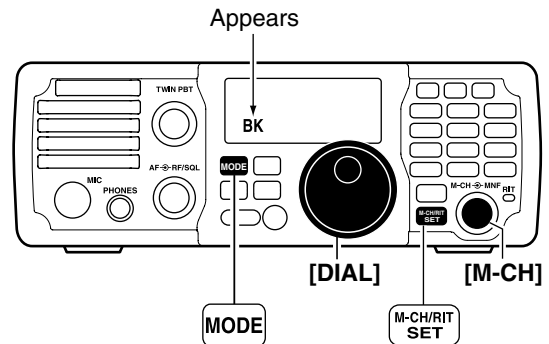

Semi break-in operation



7.5 dots

◇ Full break-in operation

During full break-in operation, the transceiver automatically switches to receive between keying dots and dashes so that the operator can hear activity on the channel when transmitting.

- ① Push **MODE** to select CW or CW-R mode.
 - When CW mode is selected, push and hold **MODE** for 1 sec. to toggle between CW and CW-R modes.
- ② Set the full break-in function ON in the set mode.

- ① Push and hold **M-CH/RIT SET** for 1 sec. twice to enter the set mode.
- ② Rotate **[M-CH]** to select “BK-IN” to set the CW break-in operation.
- ③ Rotate **[DIAL]** to select “FL.”
 - FL : full break-in
 - SE : semi break-in
 - OF : break-in OFF
- ④ Push **M-CH/RIT SET** to exit the set mode and return to normal operation.

- ③ “F-BK” appears on the LCD.

When using a paddle, set “KEY SPD” in the quick set mode to adjust the keying speed. (p. 72)

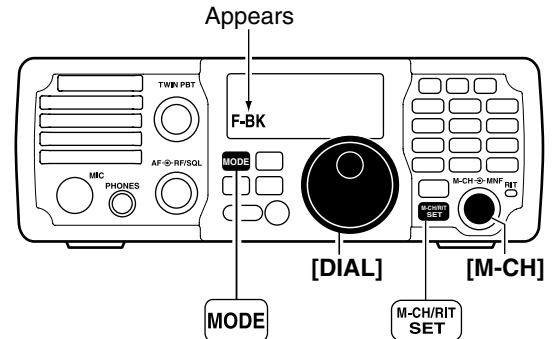

Full break-in operation

■ Speech compressor

The IC-7200 has a built-in, low distortion speech compressor circuit. This circuit increases your average talk power in SSB mode and is especially useful for DX-ing or noisy conditions when the receiving station is having difficulty copying your signal.

- ① Push **MODE** to select an SSB mode.
 - When SSB mode is selected, push and hold **MODE** for 1 sec. to toggle between USB and LSB modes.
- ② Push **COMP** to turn the speech compressor function ON and OFF.
 - “**COMP**” appears when the speech compressor function is ON.

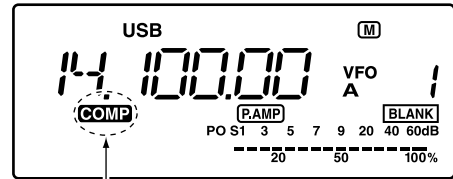
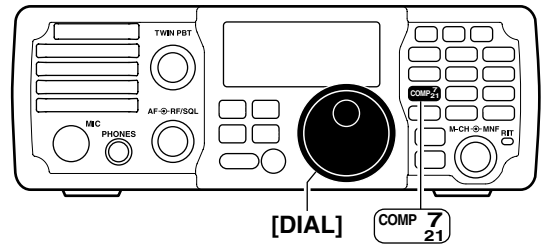

Appears

◇ Compression level setting

• Microphone gain setting

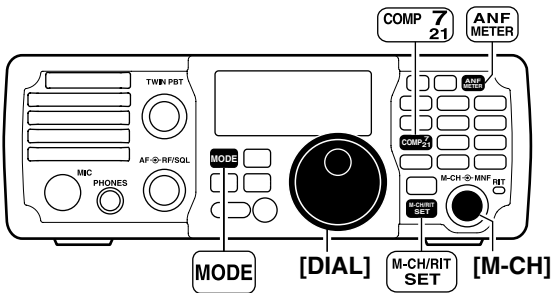

- ① Push **MODE** to select an SSB mode.
 - When SSB mode is selected, push and hold **MODE** for 1 sec. to toggle between USB and LSB modes.
- ② Push **COMP** to turn the speech compressor function OFF, if it's ON.
 - “**COMP**” disappears.
- ③ Push and hold **ANF METER** for 1 sec. several times to select ALC meter.
 - “**ALC**” appears.
- ④ Adjust the MIC gain in the quick set mode.

- ① Push and hold **M-CH/RIT SET** for 1 sec. to enter the quick set mode.
- ② Rotate **[M-CH]** to select “**MIC GAIN**” to set the microphone gain.
- ③ While transmitting, speak at a normal voice level and rotate **[DIAL]** to adjust the microphone gain so that the ALC meter reads within the ALC zone.
 - Push and hold **M-CL** for 1 sec. to return to the default value.
- ④ Push **M-CH/RIT SET** to exit the quick set mode and return to normal operation.

• Compression level setting

- ① Push and hold **ANF METER** for 1 sec. several times to select ALC meter.
 - “**ALC**” appears.
- ② Push and hold **COMP** for 1 sec. to enter the speech compression level set mode.
 - The speech compressor function is turned ON and “**COMP**” appears.
 - ▨ You can enter the speech compression level set mode before selecting ALC meter in step ①.
- ③ While transmitting, speak at a normal voice level and rotate **[DIAL]** to adjust the speech compression level so that the ALC meter reads within the ALC zone, whether you speak softly or loudly.
 - The speech compression level can be adjusted from 0 to 10.
 - Push and hold **M-CL** for 1 sec. to return to the default value.

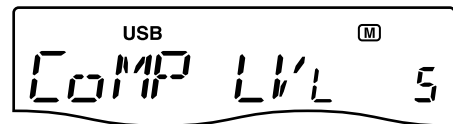

Level 5 (default)

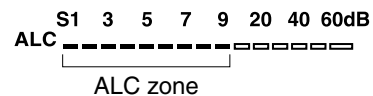

- ④ Push **COMP** to exit the speech compression level set mode and return to normal operation.
- ⑤ Push **COMP** to turn the speech compressor function OFF if necessary.
 - “**COMP**” disappears.

▨ **NOTE:** When the ALC meter peaks above the ALC zone, your transmitted voice may be distorted.

Split frequency operation

Split frequency operation allows you to transmit and receive in the same mode on two different frequencies. The split frequency operation is performed using 2 frequencies in VFO A and VFO B.

/// The transmit and receive frequencies must be in the same band

The following is an example of setting 7.0620 MHz for receiving and 7.0750 MHz for transmitting.

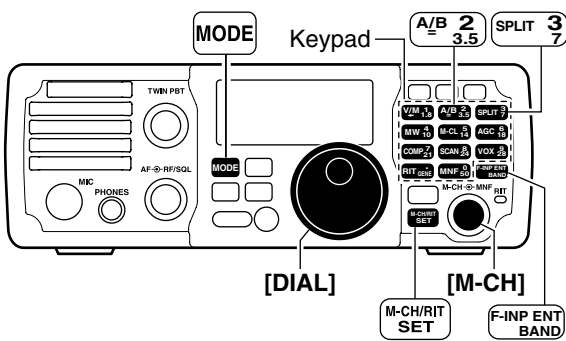

- ① Push **A/B** to select VFO A.
- ② Set the frequency to 7.0620 MHz and mode to LSB. (pgs. 25, 29)
- ③ Push **SPLIT** to turn the split function ON.
 - “**SPLIT**” appears on the LCD.

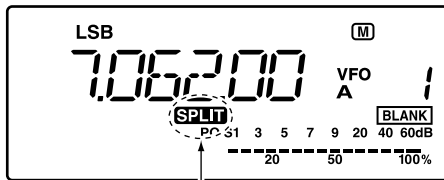

Appears

- ④ Push and hold **A/B** for 1 sec. to equalize the undisplayed VFO B frequency and operating mode with the displayed VFO A.
- ⑤ Push **A/B** to select the VFO B.
- ⑥ Set the frequency to 7.0750 MHz (LSB). (p. 25)

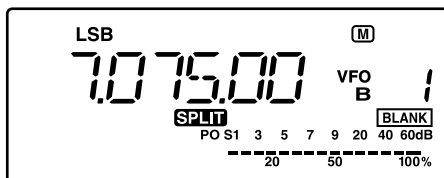

- ⑦ Push **A/B** to return to the VFO A.
- ⑧ Now you can receive on 7.0620 MHz and transmit on 7.0750 MHz.

/// To swap the transmit and receive frequencies, push **A/B** to exchange the VFO A and VFO B.

CONVENIENT!

○ QUICK SPLIT FUNCTION (p. 59)

When you push and hold **SPLIT** for 1 sec., the split function is activated, and the undisplayed VFO is set the same as the displayed VFO. (This operation is same as the steps ③ and ④ as at left.)

This shortens the time needed to start split frequency operation.

Quick split function is turned ON by default but can be turned OFF in the set mode (p. 76).

○ XFC FUNCTION (p. 76)

When the XFC (transmit frequency check) function is ON, the transmit frequency can be changed (this operation is same as the steps ⑤ and ⑥ as at left.)

/// **NOTE:** When the XFC function is ON, the RIT calculation function (p. 44) is not available.

- ① Set the XFC (transmit frequency check) function ON in the set mode.

- ① Push and hold **M-CH/RIT SET** for 1 sec. twice to enter the set mode.
- ② Rotate **[M-CH]** to select “XFC.”
- ③ Rotate **[DIAL]** to select ON.
- ④ Push **M-CH/RIT SET** to exit the set mode and return to normal operation.

- ② While pushing and holding **RIT**, the transmit frequency is indicated. And rotate **[DIAL]** to set the transmit frequency.

◇ Quick split function

When you find a DX station, an important consideration is how to set the split frequency.

When you push and hold **[SPLIT]** for 1 sec., the split function is activated, and the undisplayed VFO is set the same as the displayed VFO.

This shortens the time needed to start split frequency operation.

Quick split operation is turned ON by default but can be turned OFF in the set mode (p. 76).

The following is an example of setting 7.0620 MHz for receiving and 7.0750 MHz for transmitting.

- ① Select VFO A.
 - Pushing **[A/B]** toggles VFO A and VFO B.
- ② Set the frequency to 7.0620 MHz and mode to LSB. (pgs. 25, 29)
- ③ Push and hold **[SPLIT]** for 1 sec. to turn the split function ON and equalize the undisplayed VFO B frequency and operating mode with the displayed VFO A.
 - “**SPLIT**” appears on the LCD.
- ④ Set the XFC (transmit frequency check) function ON in the set mode. (pgs. 58, 76)
 - The default setting is OFF.
- ⑤ While pushing and holding **[RIT]**, rotate **[DIAL]** to set the transmit frequency to 7.0750 MHz.
- ⑥ Now you can receive on 7.0620 MHz and transmit on 7.0750 MHz.

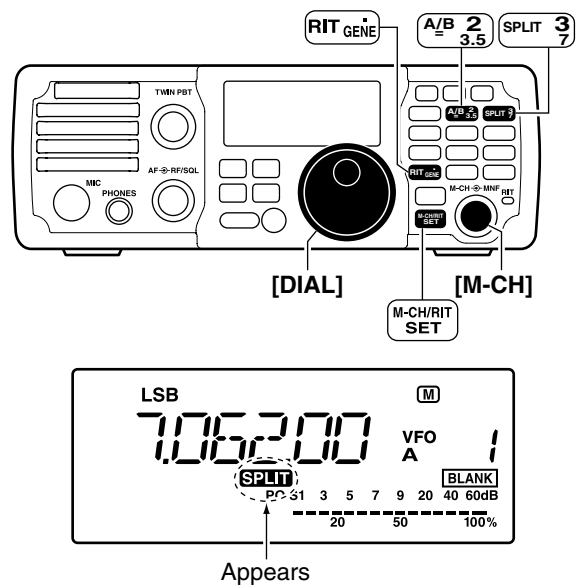

◇ Split lock function

Accidentally releasing **[RIT]** while rotating **[DIAL]** changes the receive frequency. To prevent this, use both the split lock and dial lock functions to change the transmit frequency only. The split lock function cancels the dial lock function while pushing and holding **[RIT]** during split frequency operation.

The dial lock's effectiveness during split frequency operation can be selected in the set mode for both receive and transmit frequencies; or only the receive frequency. (p. 76)

When the split lock function is ON, the transmit frequency cannot be adjusted by rotating **[DIAL]** while transmitting even if the lock function is not activated.

- ① Set the split lock function ON in the set mode.
 - ① Push and hold **[M-CH/RIT SET]** for 1 sec. twice to enter the set mode.
 - ② Rotate **[M-CH]** to select “**SPLIT LK.**”
 - ③ Rotate **[DIAL]** to select ON.
 - ④ Push **[M-CH/RIT SET]** to exit the set mode and return to normal operation.
- ② During split operation, push and hold **[SPCH]** for 1 sec. to turn the dial lock function ON.
 - “**TO**” appears on the LCD.
- ③ While pushing and holding **[RIT]***, the transmit frequency and mode are indicated. And Rotate **[DIAL]** to set the transmit frequency.

*XFC function is should be turned ON in advance. (p. 76)

■ Measuring SWR

The IC-7200 has a built-in circuit for measuring antenna SWR—no external equipment is necessary.

- ① Push **MODE** to select CW or RTTY mode.
- ② Confirm that the output power is over 30 W.
- ③ Push and hold **ANF METER** for 1 sec. several times to select the SWR meter.
- ④ Push **[PTT]** to transmit; then read the actual SWR from the meter.
 - ≤ 1.5 well-matched antenna
 - > 1.5 may indicate an antenna out of its well-matched frequency range. If much larger than 2.0, check antenna and cable connections, etc.

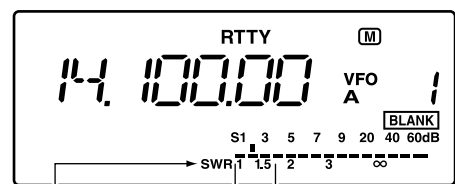
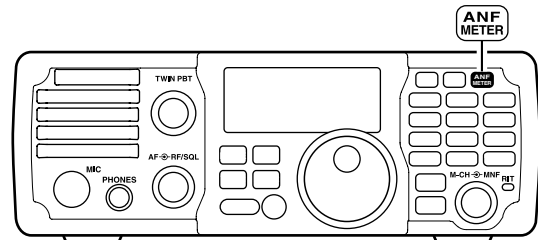

Appears The best match is in this range.

Memory channels

The transceiver has 201 memory channels including 2 scan edge channels. Memory mode is very useful for quickly changing to often-used frequencies.

All 201 memory channels are tuneable which means the programmed frequency can be tuned temporarily with **[DIAL]**, etc., in memory mode.

| MEMORY CHANNEL | MEMORY CHANNEL NUMBER | CAPABILITY | COPY TO VFO | OVER-WRITING | CLEAR |
|---------------------------|-----------------------|--|-------------|--------------|-------|
| Regular memory channels | 1-199 | Independent transmit and receive frequencies and mode in each memory channel. | Yes | Yes | Yes |
| Scan edge memory channels | P1, P2 | One frequency and one mode in each memory channel as scan edges for programmed scan. | Yes | Yes | No |

Memory channel selection

- Push **[V/M]** to select memory mode.
 - "**MEMO**" appears.
- Rotate **[M-CH]** to select the desired memory channel.
 - If the RIT control indicator lights orange, push **[M-CH/RIT SET]** to set the **[M-CH]** control to memory channel control. (See below for details)
 - All memory channels including blank channels can be selected.
 - **[UP]/[DN]** on the microphone also selects the memory channels. (The only programmed memory channels are selectable.)

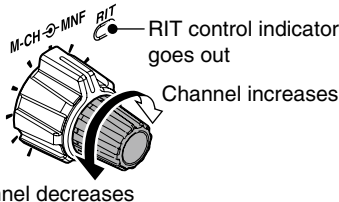

About the [M-CH] control:

When the RIT control indicator lights orange, the memory channels cannot be selected with rotating the **[M-CH]** control because the **[M-CH]** control acts as the RIT control. So, push **[M-CH/RIT SET]** to set the **[M-CH]** control to memory channel control (RIT control indicator goes out).

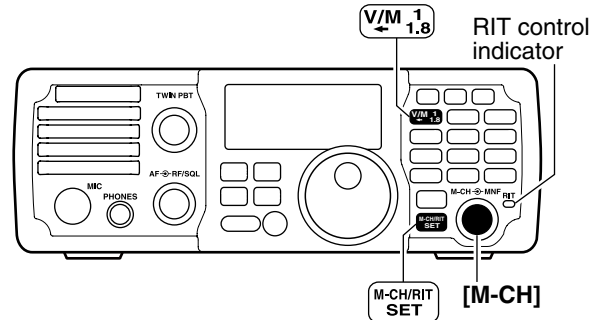

[EXAMPLE]: Selecting memory channel 17.

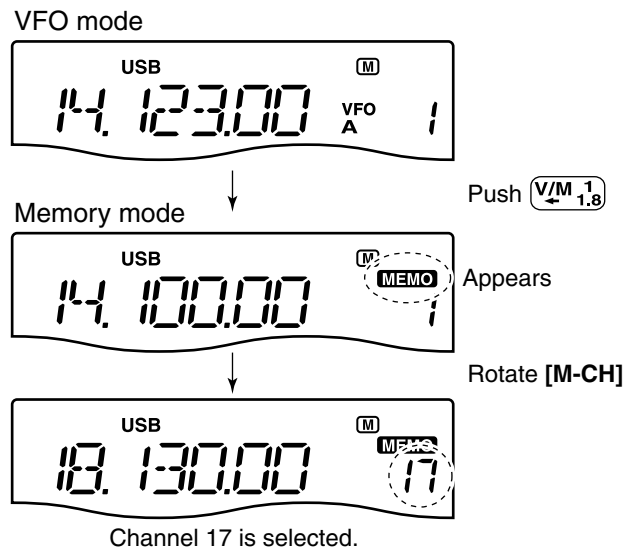

Memory programming

Memory channel programming can be performed either in VFO mode or in memory mode.

Programming in VFO mode

- ① Push **[V/M]** to select VFO mode.
- ② Rotate **[DIAL]**, and push **[MODE]** to set the desired frequency and operating mode.
- ③ Rotate **[M-CH]** to select the desired memory channel.
 - If the RIT control indicator lights orange, push **[M-CH/RIT SET]**. (p. 61)
 - “**BLANK**” appears if the selected memory channel is a blank channel (one without any stored frequencies).

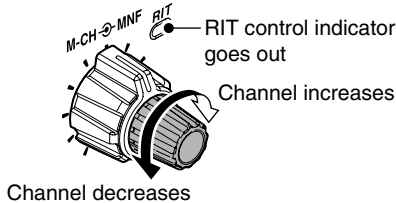

- ④ Push and hold **[MW]** for 1 sec. to program the displayed frequency and operating mode into the selected memory channel.
 - 3 beeps are emitted when memory programming is successful.

[EXAMPLE]: Programming 7.088 MHz/LSB into ch 12.

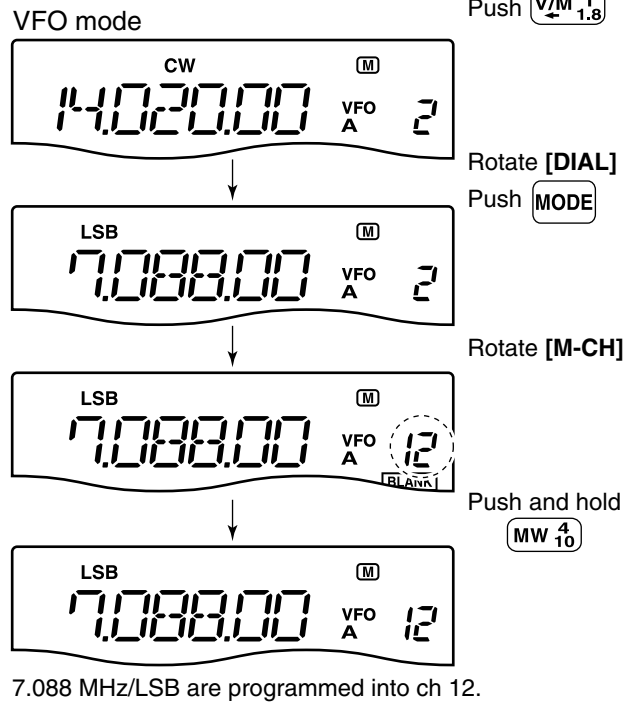

Programming in memory mode

- ① Push **[V/M]** to select memory mode.
- ② Rotate **[M-CH]** to select the desired memory channel.
 - If the RIT control indicator lights orange, push **[M-CH/RIT SET]**. (p. 61)
 - Memory channel contents appear in the display.

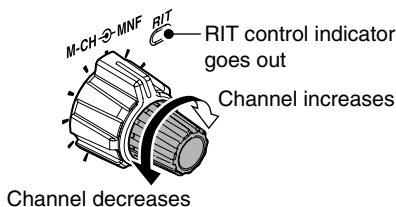

- ③ Rotate **[DIAL]**, and push **[MODE]** to set the desired frequency and operating mode.
 - To program a blank channel, use direct frequency entry with the keypad. (p. 25)
- ④ Push and hold **[MW]** for 1 sec. to program the displayed frequency and operating mode into the memory channel.
 - 3 beeps are emitted when memory programming is successful.

[EXAMPLE]: Programming 21.280 MHz/USB into ch 18.

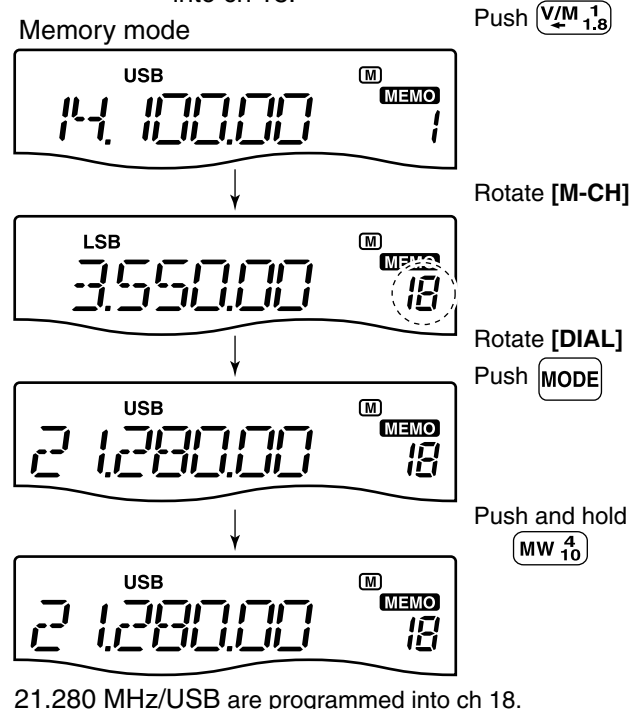

Frequency copying

The frequency and operating mode in a memory channel can be copied to the VFO.

Copying in memory mode

This is useful for copying a memory channel's contents (frequency and operating mode) to a VFO while operating in memory mode.

This is useful when searching for signals around a memory channel frequency.

NOTE: While operating in VFO mode, pushing and holding $\left[\begin{array}{c} \text{V/M} \\ \leftarrow \end{array} \right]$ for 1 sec. also copy the selected memory channel's contents (frequency and operating mode) to a VFO.

When you have changed the frequency or operating mode in the selected memory channel:

- **Displayed** frequency and mode are copied.
- **Programmed** frequency and mode in the memory channel are not copied, and they remain in the memory channel.

- 1 Push $\left[\begin{array}{c} \text{V/M} \\ \leftarrow \end{array} \right]$ to select memory mode.
- 2 Rotate **[M-CH]** to select the desired memory channel to be copied.
 - If the RIT control indicator lights orange, push $\left[\begin{array}{c} \text{M-CH/RIT} \\ \text{SET} \end{array} \right]$. (p. 61)
 - Set the frequency or operating mode if required.
 - "[BLANK]" appears if the selected memory channel is a blank channel (and does not have contents). In this case copying is not possible.

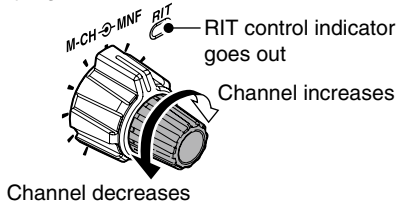

- 3 Push and hold $\left[\begin{array}{c} \text{V/M} \\ \leftarrow \end{array} \right]$ for 1 sec. to copy the frequency and operating mode.
 - 3 beeps are emitted when the copying is successful.
 - Displayed frequency and operating mode are copied.
- 4 To return to VFO mode, push $\left[\begin{array}{c} \text{V/M} \\ \leftarrow \end{array} \right]$.
 - Copied frequency and operating mode appear in the display.

You can return to VFO mode before copying the frequency and operating mode in step ③.

[EXAMPLE]: Copying contents of memory 16.

Operating frequency : 14.020 MHz/CW
 Contents of memory 16 : 14.018 MHz/CW



Rotate **[M-CH]**

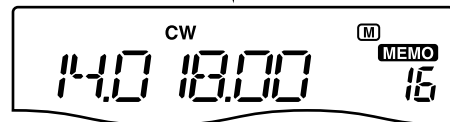

Push and hold $\left[\begin{array}{c} \text{V/M} \\ \leftarrow \end{array} \right]$ 1 for 1 sec., then push $\left[\begin{array}{c} \text{V/M} \\ \leftarrow \end{array} \right]$ 1.8.

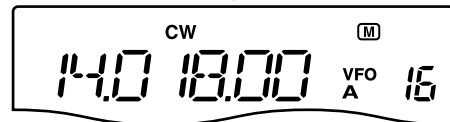

Memory clearing

Any unnecessary memory channels can be cleared. The cleared memory channels become blank channels.

- ① Push **V/M** to select memory mode.
- ② Rotate **[M-CH]** to select the desired memory channel to be cleared.
 - If the RIT control indicator lights orange, push **M-CH/RIT SET**. (p. 61)
- ③ Push and hold **M-CL** for 1 sec. to clear the contents.
 - The programmed frequency and operating mode disappear and "BLANK" appears.
 - 3 beeps are emitted when memory clearing is successful.
- ④ To return to VFO mode, push **V/M**.

NOTE: Be careful!— the contents of cleared memories CANNOT be recalled.

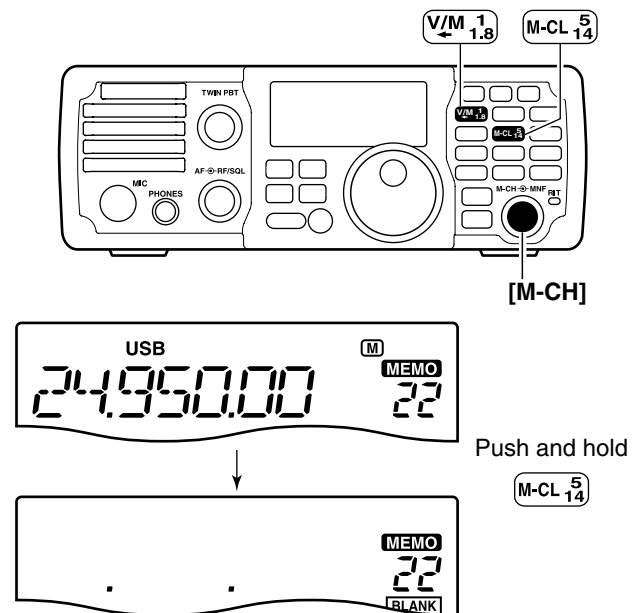

■ Scan types

PROGRAMMED SCAN

Repeatedly scans between two scan edge frequencies (scan edge memory channels P1 and P2).

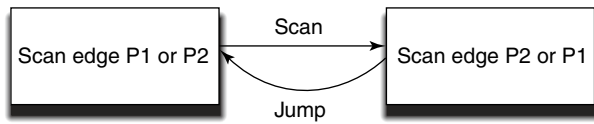

This scan operates in VFO mode.

MEMORY SCAN

Repeatedly all programmed memory channels that are not blank.

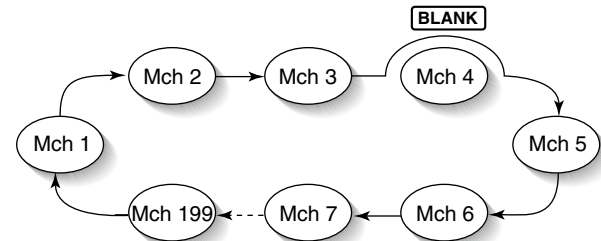

This scan operates in memory mode.

■ Preparation

• Channels

For programmed scan:

Program scan edge frequencies into scan edge memory channels P1 and P2. (p. 66)

For memory scan:

Program two or more memory channels except scan edge memory channels.

• Scan resume ON/OFF

You can select the scan to resume or cancel when detecting a signal in the set mode.

Scan resume ON/OFF must be set before operating a scan. See p. 78 for ON/OFF setting and scan resume condition details.

• Scan speed

Scan speed can be selected from 2 levels, high or low, in the set mode. See p. 78 for details.

• Squelch condition

○ Scan starts with squelch open

For programmed scan:

When tuning step is 1 kHz or less:

The scan continues until it is stopped manually with pushing **[SCAN]**, and does not pause* even if signals are detected.

* The scan is paused when the squelch is closed and then opened (scan resumes after 10 sec. has passed when the scan resume is ON; scan is cancelled when OFF).

When tuning step is more than 5 kHz:

The scan pauses on each step when the scan resume is ON; not applicable when OFF.

For memory scan:

Scan pauses on each channel when the scan resume is ON; not applicable when OFF.

○ Scan starts with squelch closed

Scan stops when a signal is detected.

If you set scan resume ON in the set mode, the scan pauses for 10 sec. when detecting a signal, then resumes. When a signal disappears while scan is paused, scan resumes 2 sec. later.

/// **NOTE:** If the **[RF/SQL]** control function is set as "AUTO," the squelch is always open in SSB, CW and RTTY modes. (pgs. 4, 30, 75)

Programmed scan operation (VFO mode)

Programmed scan searches for signals between scan edge memory channels P1 and P2. The default frequencies for these memories are 0.500000 MHz and 29.99999 MHz, respectively. See p. 62 for scan edges programming.

- ① Push **V/M** to select VFO mode.
- ② Push **MODE** to select the desired operating mode.
 - The operating mode can be changed while scanning.
- ③ Push **TS** to select a tuning step.
 - The tuning step cannot be changed while scanning. (The programmed tuning function can be turned ON or OFF while scanning.)
- ④ Set the **[RF/SQL]** control open or closed.
 - See the left page for squelch condition.
- ⑤ Push **SCAN** to start the scan.
 - “**SCAN**” appears while scanning.
- ⑥ When the scan detects a signal, the scan turns OFF, pauses or ignores it depending on the resume setting and the squelch condition.
- ⑦ To cancel the scan, push **SCAN**.

NOTE: If the same frequencies are programmed into both scan edge memory channels P1 and P2, programmed scan does not start.

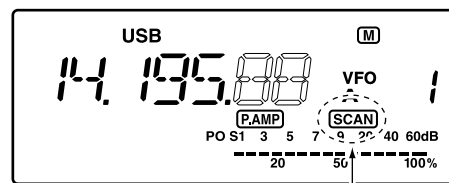
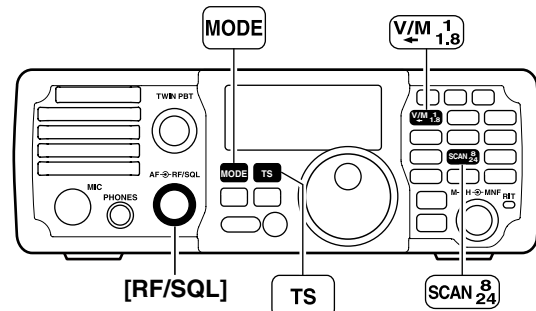

Appears

Memory scan operation (Memory mode)

Memory scan searches through memory channel 1 to 199 for signals. Blank (unprogrammed) memory channels are skipped.

- ① Push **V/M** to select memory mode.
- ② Close the squelch with the **[RF/SQL]** control.
- ③ Push **SCAN** to start the scan.
 - “**SCAN**” appears while scanning.
- ④ When the scan detects a signal, the scan stops or pauses depending on the resume setting.
- ⑤ To cancel the scan push **SCAN**.
 - Rotating **[DIAL]** during scan also cancels scan operation.

NOTE: Two or more memory channels must be programmed for memory scan to start.

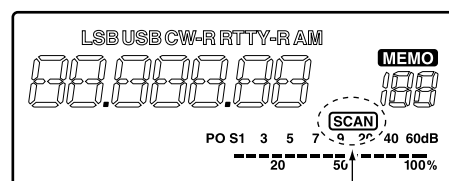
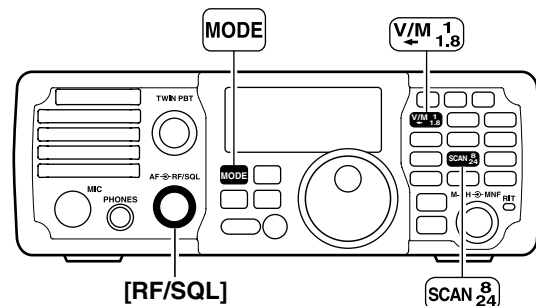

Appears

■ Optional AT-180 AUTOMATIC ANTENNA TUNER operation

The AT-180 automatic antenna tuner matches the IC-7200 to the connected antenna automatically. Once the tuner matches an antenna, the variable capacitor settings are memorized as a preset point for each frequency range (100 kHz steps). Therefore, when you change the frequency range, the variable capacitors are automatically preset to the memorized point.

NOTE:

- The AT-180 can match both HF and 50 MHz bands. However, operation is different for the HF and 50 MHz bands.
- When connecting the AT-180, the IC-7200's output power must be more than 10 W. Otherwise, the AT-180 may not be tuned correctly. (AT-180's minimum operating input power is 8 W.)

CAUTION: NEVER transmit with the tuner ON when no antenna is connected. This will damage both the transceiver and antenna tuner.

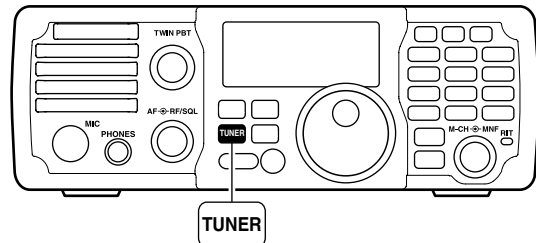

◇ Tuner operation

• For the HF band:

Push **TUNER** to turn the tuner ON. The antenna is tuned automatically during transmission when the antenna SWR is higher than 1.5:1.

- When the tuner is ON, "**TUNE**" indication appears.

• For the 50 MHz band:

Push and hold **TUNER** for 1 sec. to tune the antenna. If "**TUNE**" indicator blinks slowly while transmitting, push and hold **TUNER** for 1 sec. again to re-tune the antenna.

◇ Manual tuning

During SSB operation on HF bands at low voice levels, the AT-180 may not be tuned correctly. In such cases, manual tuning is helpful.

Push and hold **TUNER** for 1 sec. to start manual tuning.

- When CW mode is selected, a side tone is emitted, and "**TUNE**" indicator blinks; then, the previous mode is selected.

If the tuner cannot reduce the SWR to less than 1.5:1 after 20 sec. of tuning, "**TUNE**" indicator disappears. In this case, check the following:

- the antenna connection and feedline
- the antenna SWR (p. 30; meter function, p. 60; Measuring SWR)

Through inhibit (HF bands only)

The AT-180 has a through inhibit condition. When selecting this condition, the tuner can be used at poor SWR's. In this case, automatic tuning in the HF bands activates only when exceeding SWR 3:1. Therefore, manual tuning is necessary each time you change the frequency. Although termed "through inhibit," the tuner will be set to the "through" configuration if the SWR is higher than 3:1 after tuning.

CONVENIENT

• Tuner sensitive condition (HF bands only)

If you require critical tuning at any time during transmission, select the tuner sensitive condition. See p. 68 for selection.

• Automatic tuner start (HF bands only)

If you want to turn OFF the tuner under conditions of VSWR 1.5:1 or less, use "automatic tuner on" and turn the tuner OFF. See p. 76 for the automatic tuner function.

• PTT tune function (p. 76)

The AT-180 is tuned when [PTT] is pushed after the frequency is changed (more than 1%) if the AT-180 is turned ON. This function removes the "push and hold **TUNER**" operation and activates first transmission on the new frequency.

This function is turned ON in the set mode.

■ AT-180 internal switch description

The optional AT-180 has 3 operating configurations for HF band operation. Select a suitable configurations according to your antenna system.

- ① Remove the top cover of the AT-180.
- ② Set the tuner switches to the desired positions according to the table below.

| SW | Position | Operation |
|----|----------------|--|
| S1 | A (default) | The tuner operating condition is set by S2 described below. |
| | B | THROUGH INHIBIT The tuner tunes the antenna even when the antenna has poor SWR (up to VSWR 3:1 after tuning). In this case, manual tuning is necessary each time you change the frequency although the tuner automatically starts tuning when the VSWR is higher than 3:1. This setting is called "through inhibit," however, the tuner is set to "through" if the VSWR is higher than 3:1 after tuning. |
| S2 | C | TUNER SENSITIVE CONDITION The tuner tunes each time you transmit (except SSB mode). Therefore, the lowest SWR is obtained at any given time. For SSB mode, the same condition as the "D" position. |
| | D (default) | NORMAL The tuner tunes when the SWR is higher than 1.5:1. Therefore, the tuner activates only when tuning is necessary. |

• Specifications for the AT-180

- Frequency coverage : 1.8–54 MHz
- Input impedance : 50 Ω
- Maximum input power : 120 W
- Minimum tuning power : 8 W
- Matching impedance range : 16.7–150 Ω (HF band)
20–125 Ω (50 MHz band)
- Tuning accuracy : Less than SWR 1.5:1
- Insertion loss : Less than 1.0 dB (after tuning)
- Power supply requirements: 13.8 V DC/1 A (supplied from the transceiver's ACC socket)
- Dimensions (mm/in) : 167(W) × 58.6(H) × 225(D)
6⁹/₁₆(W) × 2⁵/₁₇(H) × 8⁷/₈(D)
- Weight (approx.) : 2.3 kg; 5 lb 1¹/₈ oz
- Supplied accessories : Coaxial cable (1 m),
ACC cable (DIN 13 pins)

• AT-180 inside top cover

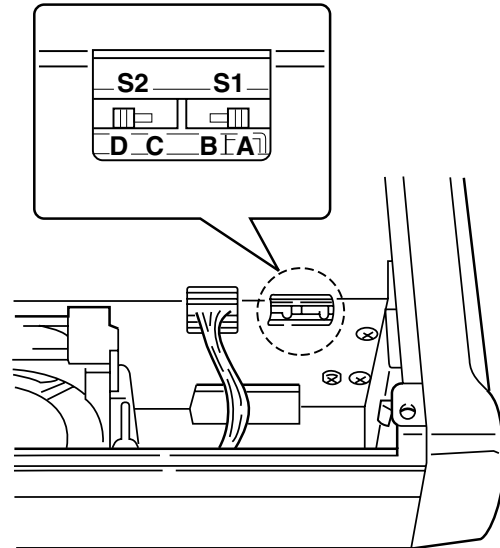

• Connector information for ACC(2) socket

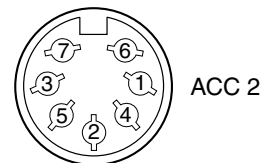

| PIN NO./ NAME | DESCRIPTION |
|---------------|---|
| ① NC (8 V*) | (*If the modification is performed (p. 97), regulated 8 V output.) (10 mA max.) |
| ② GND | Connects to ground. |
| ③ SEND | Input/output pin. Goes to ground when transmitting (20 mA max). When grounded, transmits. |
| ④ NC (BAND*) | (*If the modification is performed (p. 97), band voltage output.) |
| ⑤ ALC | ALC output voltage (–4 to 0 V). |
| ⑥ NC | No connection. |
| ⑦ 13.8 V | 13.8 V output when power is ON (1 A max). |

■ Optional AH-4 AUTOMATIC ANTENNA TUNER operation

The AH-4 matches the IC-7200 to a long wire antenna more than 7 m/23 ft long (3.5 MHz and above).

- See p. 14 for connection.
- See the AH-4 instruction manual for AH-4 installation and antenna connection details.

AH-4 setting example:

For mobile operation

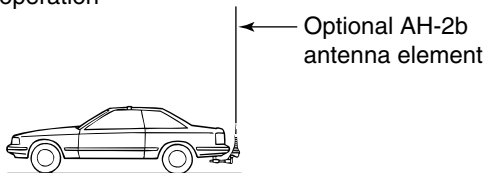

For outdoor operation

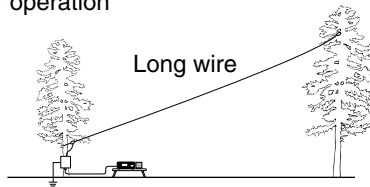

⚠ DANGER!: HIGH VOLTAGE!
NEVER touch the antenna element while tuning or transmitting.

NEVER operate the AH-4 without an antenna wire. The tuner and transceiver will be damaged.

NEVER operate the AH-4 when it is ungrounded.

Transmitting before tuning may damage the transceiver. Note that the AH-4 cannot tune when using a $\frac{1}{2}\lambda$ long wire or on a multiple of that frequency.

◇ AH-4 operation

Tuning is required for each frequency. **Be sure** to re-tune the antenna before transmitting when you change the frequency—even slightly.

- ① Set the desired frequency in an HF band.
 - The AH-4 will not operate on frequencies outside of ham bands.
- ② Push and hold **TUNER** for 1 sec.
 - “**TUNE**” indicator blinks while tuning.
- ③ “**TUNE**” indicator is still ON after the tuning is completed.
 - When the connected wire cannot be tuned, “**TUNE**” indicator goes out, and the AH-4 is bypassed and the antenna wire is connected to the antenna connector on the transceiver directly.
- ④ To bypass the AH-4 manually, push **TUNER**.
 - “**TUNE**” indicator goes out.

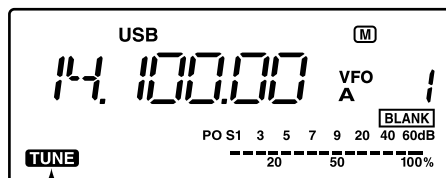

Appears when the antenna tuner ON.
 Blinks while tuning.

CONVENIENT

• PTT tune function (p. 76)

The AH-4 is always tuned when [PTT] is pushed after the frequency is changed (more than 1%). This function removes the “push and hold **TUNER**” operation and activates first transmission on the new frequency.

This function is turned ON in the set mode.

■ General

Set mode is used for programming infrequently changed values or conditions of functions.

The IC-7200 has 2 separate set modes: **quick set mode** and **set mode**.

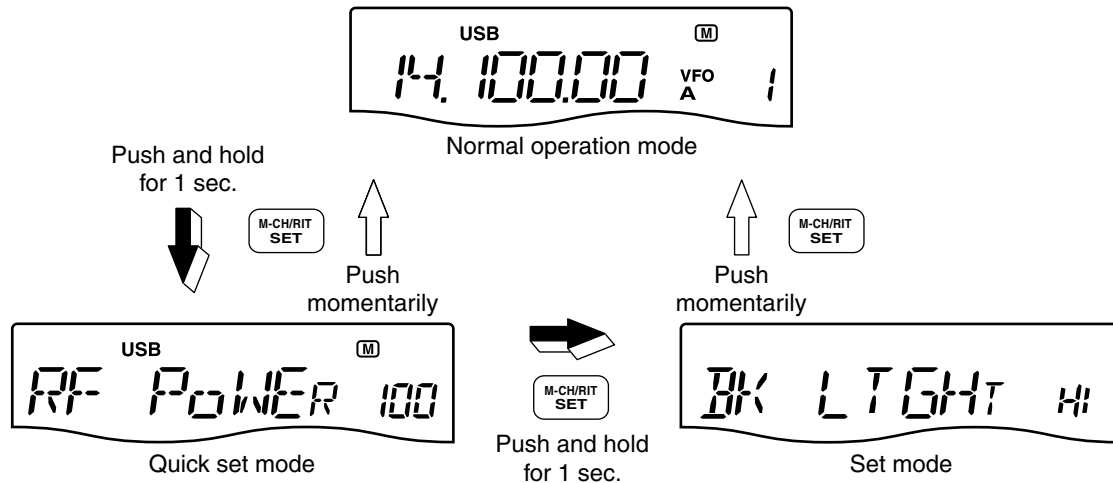

◇ Quick set mode operation

- ① Push and hold **M-CH/RIT SET** for 1 sec. to enter the quick set mode.
- ② Rotate **[M-CH]** to select the desired item.
- ③ Set the desired condition or value using **[DIAL]**.
 - Push and hold **M-CL** for 1 sec. to select the default condition or value.
- ④ Repeat ② and ③ to set other items.
- ⑤ Push **M-CH/RIT SET** to exit the quick set mode and return to normal operation.

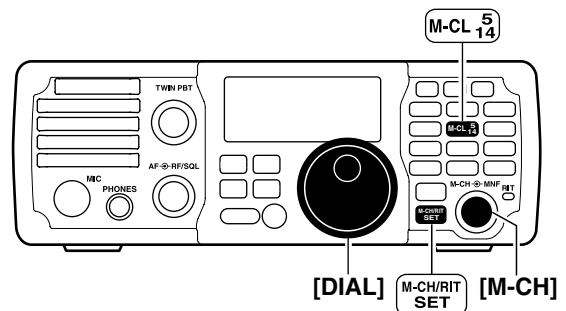

◇ Set mode operation

- ① Push and hold **M-CH/RIT SET** for 1 sec. to enter the quick set mode.
- ② Repeat step ① again to enter the set mode.
- ③ Rotate **[M-CH]** to select the desired item.
- ④ Set the desired condition or value using **[DIAL]**.
 - Push and hold **M-CL** for 1 sec. to select the default condition or value.
- ⑤ Repeat ③ and ④ to set other items.
- ⑥ Push **M-CH/RIT SET** to exit the set mode and return to normal operation.

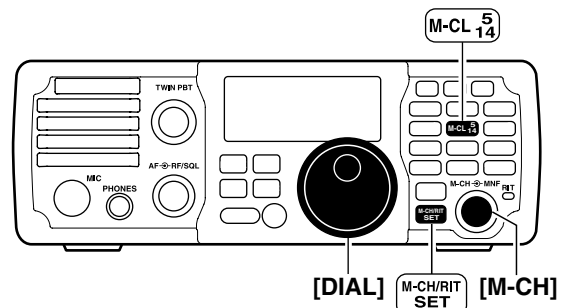

■ Quick set mode

| Mode | Set mode item | Default setting |
|------|-------------------|-----------------|
| SSB | RF POWER | 100% |
| | MIC GAIN | 50% |
| | DATA MODE | OFF |
| CW | RF POWER | 100% |
| | KEY SPEED | 20WPM |
| | CW PITCH | 600Hz |
| | SIDE TONE LEVEL | 30% |
| | SIDE TONE LIMIT | ON |
| RTTY | RF POWER | 100% |
| | TWIN PEAK FILTER | OFF |
| | RTTY MARK TONE | 2125Hz |
| | RTTY SHIFT | 170Hz |
| | RTTY KEY POLARITY | NORMAL |
| AM | RF POWER | 100% |
| | MIC GAIN | 50% |
| | DATA MODE | OFF |

RF power (all modes)

This item adjusts the RF output power. The RF output power can be adjusted from L (Low), 1% to 100% in 1% steps.



100% (default)

Mic gain (SSB/AM modes)

This item adjusts microphone gain from 0% to 100% in 1% steps.

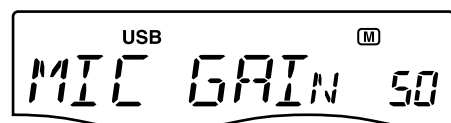

50% (default)

Data mode (SSB/AM modes)

This item turns the data mode ON or OFF. When the data mode is turned ON, the audio input from the [ACC] connector* is used for transmission instead of [MIC] connector and the speech compressor function is turned OFF.

* The desired connector can be selected. (p. 77)

on : Data mode operation is enabled.

(“**D**” appears.)

oF : Data mode operation is disabled.

(“**D**” disappears.)

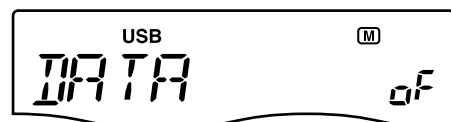

OFF (default)

Key speed (CW mode)

This item adjusts the CW key speed. The key speed can be selected from 6 to 60* wpm.
 * 39, 43, 45, 47, 49, 51, 53, 55, 56, 58 and 59 cannot be selected.

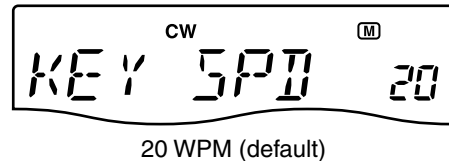

CW pitch (CW mode)

This item adjusts the CW receive pitch. The pitch can be selected from 300 to 900 Hz in 10 Hz steps.

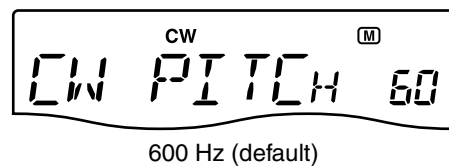

Side tone level (CW mode)

This item adjusts the CW side tone level from 0% to 100% in 1% steps.

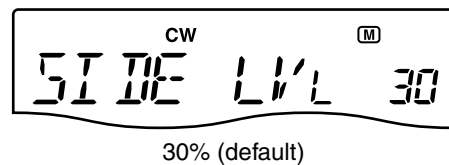

Side tone level limit (CW mode)

Turn the CW side tones output level limiting capability ON and OFF.
 When this item is set to ON, the CW side tone is linked to the [AF] control until rotation of the [AF] control reaches to the specified level—further rotation will not increase the volume of the CW side tones.
 on : CW side tone level is limited with the [AF] control.
 oF : CW side tone level is linked to the [AF] control.

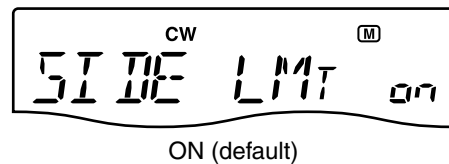

Twin peak filter (RTTY mode)

This item turns the twin peak filter ON or OFF.
 on : Twin peak filter is ON.
 oF : Twin peak filter is OFF.

/// **NOTE:** The RTTY mark frequency (2125 Hz) and shift width (170 Hz) are automatically set when the twin peak filter is ON.

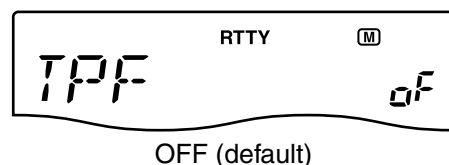

RTTY mark tone (RTTY mode)

This item selects the RTTY mark frequency. There are 3 selectable values: 1275, 1615 and 2125 Hz.

/// **NOTE:** 2125 Hz is automatically set when the twin peak filter is ON.

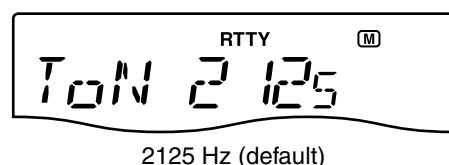

■ Quick set mode (Continued)

RTTY shift width (RTTY mode)

This item adjusts the RTTY shift width. There are 4 selectable values: 170, 200, 425 and 850 Hz.

/// **NOTE:** 170 Hz is automatically set when the twin peak filter is ON.

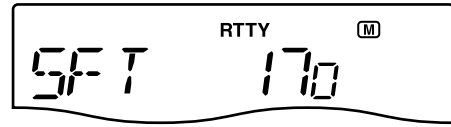

170 Hz (default)

RTTY key polarity (RTTY mode)

This item selects the RTTY keying polarity. Normal or reverse keying polarity can be selected.

When reverse polarity is selected, Mark and Space are reversed.

n (normal) : Key open/close = Mark/Space

r (reverse) : Key open/close = Space/Mark

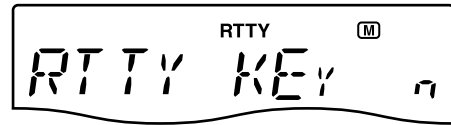

NORMAL (default)

■ Set mode

| Set mode item | Default setting | Set mode item | Default setting |
|-----------------------------|-----------------|--------------------------------|--|
| LCD BACKLIGHT | HIGH | SCAN RESUME | ON |
| BEEP | ON | MAIN DIAL AUTO TS | HIGH |
| BAND EDGE BEEP | ON | DIAL ¼ | OFF |
| BEEP LEVEL | 50% | MIC UP/DOWN SPEED | HIGH |
| BEEP LEVEL LIMIT | ON | SSB/CW SYNCHRONOUS TUNING | OFF |
| RF/SQL CONTROL | RF + SQL | CW NORMAL SIDE | LSB |
| METER PEAK HOLD | ON | BREAK-IN | OFF |
| QUICK SPLIT | ON | BREAK-IN DELAY | 7.5 DOTS |
| SPLIT LOCK | OFF | DOT/DASH RATIO | 1:1:3.0 |
| XFC | OFF | PADDLE POLARITY | NORMAL |
| AUTO TUNE | OFF | KEYER TYPE | ELEC-KEY |
| PTT TUNE | OFF | MIC UP/DOWN KEYER | OFF |
| MODULATION INPUT (DATA OFF) | MIC/ACC | MODE SELECT (SSB) | ON |
| MODULATION INPUT (DATA ON) | ACC | MODE SELECT (CW) | ON |
| USB LEVEL | 50% | MODE SELECT (RTTY) | ON |
| SPEECH LEVEL | 50% | MODE SELECT (AM) | ON |
| SPEECH LANGUAGE | ENGLISH | CI-V BAUD RATE | AUTO |
| SPEECH SPEED | HIGH | CI-V ADDRESS | 76H |
| SPEECH S-LEVEL | ON | CI-V TRANSCEIVE | ON |
| SPEECH [MODE] KEY | OFF | REFERENCE FREQUENCY ADJUSTMENT | Default setting is different for each transceiver. |
| SCAN SPEED | HIGH | | |

LCD Backlight

This item adjusts the brightness of the LCD from HI (High), Lo (Low) or oF (Off).



High (default)

Beep

A beep sounds each time a key is pushed to confirm it. This function can be turned OFF for silent operation.

on : Confirmation beep ON
oF : Confirmation beep OFF

The volume level can be set in "Beep Level" as below.



ON (default)

■ Set mode (Continued)

Band Edge Beep

A beep sounds when an operating frequency enters or exits an amateur band. This function is independent from “Beep” (the confirmation beep) setting as above.

- on : Band edge beep ON
- oF : Band edge beep OFF

The volume level can be set in “Beep Level” as below.

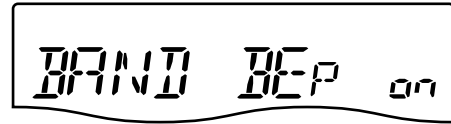

ON (default)

Beep Level

This item sets the maximum volume level for the confirmation beep and band edge beep tones from 0% to 100% in 1% steps.

When beep tones are set to OFF, this setting has no effect.

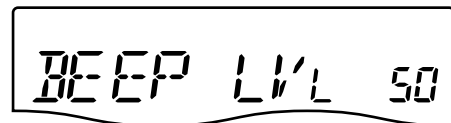

50% (default)

Beep Level Limit

Turn the beep tones output level limiting capability ON and OFF for the confirmation and band edge beep tones. When this item is set to ON, the beep tones are linked to the [AF] control until rotation of the [AF] control reaches to the specified level—further rotation will not increase the volume of the beep tones.

- on : Beep level is limited with the [AF] control
- oF : Beep level is linked to the [AF] control

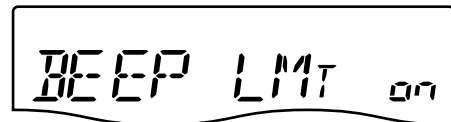

ON (default)

RF/SQL Control

The [RF/SQL] control can be set as the RF/squelch control, the squelch control only (RF gain is fixed at maximum) or Auto (RF gain control in SSB, CW and RTTY; squelch control in AM).

See pgs. 4, 30 for details.

- rS (RF+SQL) : [RF/SQL] control is set as the RF/squelch control
- Sq (SQL) : [RF/SQL] control is set as the squelch control
- At (AUTO) : [RF/SQL] control is set as the RF gain control in SSB, CW and RTTY; squelch control in AM



RF + SQL (default)

Meter Peak Hold

This item turns the meter peak hold function ON or OFF.

- on : The highest activated segment of the meter remains visible for 0.5 sec.
- oF : The meter functions normally.

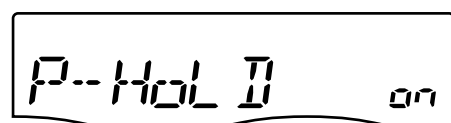

ON (default)

Quick Split

This item turns the quick split function ON or OFF.

When this item is set to ON, push and hold **SPLIT** for 1 sec. to set the undisplayed VFO frequency and operating mode are set the same as the displayed VFO frequency and operating mode.

See pgs. 58, 59 for details.

on : The quick split function ON

oF : The quick split function OFF

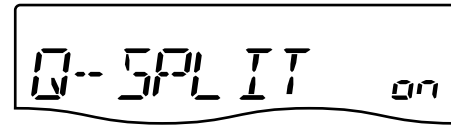

ON (default)

Split Lock

This item turns the split lock function ON or OFF.

When this item is set to ON, the transmit frequency can be adjusted by rotating **[DIAL]** while pushing and holding **RIT*** even if the lock function is activated.

* The transmit frequency check function ("XFC"; as below) must be turned ON in advance.

See p. 59 for split frequency operation details.

NOTE: When the split lock function is ON, the transmit frequency cannot be adjusted by rotating **[DIAL]** while pushing and holding **[PTT]** even if the lock function is not activated.

on : The split lock function ON

oF : The split lock function OFF



OFF (default)

XFC

This item turns the XFC (transmit frequency check) function ON or OFF.

on : The transmit frequency can be monitored while pushing and holding **RIT**

oF : The transmit frequency check function OFF

NOTE: When the XFC function is turned ON, the RIT calculation function (p. 44) is not available.



OFF (default)

Auto Tune

The optional AT-180 ANTENNA TUNER has an automatic start capability which starts tuning if the SWR is higher than 1.5:1.

on : The automatic tune starts even when the tuner is turned OFF during HF bands operation.

oF : The tuner remains OFF even when the SWR is poor (1.5:1)



OFF (default)

■ Set mode (Continued)

PTT Tune

Tuning of the internal antenna tuner can be started automatically at the moment [PTT] is pushed after the operating frequency is changed (more than 1% from last-tuned frequency).

When an optional AT-180 ANTENNA TUNER is connected, the tuner function must be turned ON in advance.

on : Tuning starts when [PTT] is pushed on a new frequency.

oF : Tuning starts only when **TUNER** is pushed.



OFF (default)

Modulation input (Data OFF)

Selects the desired connector(s) for modulation input when SSB data/AM data mode is not in use.

M (MIC) : Use the signals from [MIC].

A (ACC) : Use the signals from [ACC] (pin11).

M A (MIC/ACC): Use the signals from [MIC] and [ACC] (pin11).

U (USB) : Use the signals from [USB].



MIC/ACC (default)

Modulation input (Data ON)

Selects the desired connector(s) for modulation input when SSB data/AM data mode is in use.

M (MIC) : Use the signals from [MIC].

A (ACC) : Use the signals from [ACC] (pin11).

M A (MIC/ACC): Use the signals from [MIC] and [ACC] (pin11).

U (USB) : Use the signals from [USB].

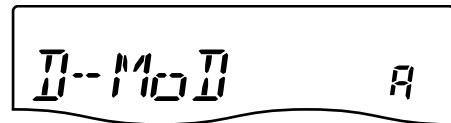

ACC (default)

USB Level

Sets the input modulation level of the USB jack, within 0% to 100% in 1% steps.

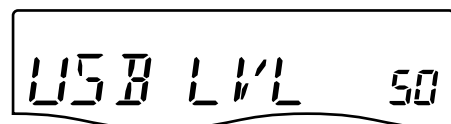

50% (default)

Speech Level

This item adjusts the volume level for the speech function from 0% to 100% in 1% steps.

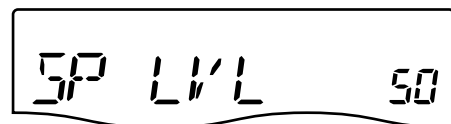

50% (default)

Speech S-level

Signal level, frequency and mode can be announced by the voice synthesizer. The signal level announcement can be deactivated if desired.

When "oF" is selected, the signal level is not announced.

on : Signal level announcement

oF : No signal level announcement

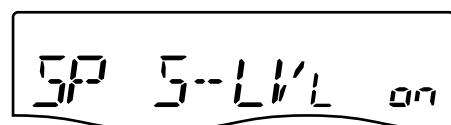

ON (default)

Speech MODE Key

This item selects whether the operating mode announced with the speech synthesizer when MODE is pushed.

When "on" is selected, the selected operating mode is announced at pushing MODE.

on : Operating model announcement with MODE.

oF : No operating mode announcement with MODE.

OFF (default)

Scan Speed

This item sets the rate at which channels or frequencies are scanned during scan operations.

High and low can be selected.

HI : Fast scan.

Lo : Slow scan.

High (default)

Scan Resume

This item turns the scan resume function ON or OFF.

on : Scan resumes 10 sec. after stopping on a signal (or 2 sec. after a signal disappears).

oF : Scan does not resume after stopping on a signal.

ON (default)

Main Dial Auto TS

This item sets the auto tuning step function. When rotating [DIAL] rapidly, the tuning step rate adapts as selected.

There are 2 type of auto tuning steps: HI (Fastest) and Lo (Faster).

HI : Approx. 5 times faster when the tuning step is set to 1 kHz or smaller steps; approx. 2 times faster when the tuning step is set to 5 kHz or larger steps.

Lo : Approx. 2 times faster

oF : Auto tuning step is turned OFF.

High (default)

Dial ¼

This item turns the ¼-speed tuning function ON or OFF in CW, RTTY and SSB data modes.

on : The ¼-speed tuning function ON for critical tuning. While operating in CW/RTTY/SSB data, the dial sensitivity is reduced to ¼ of normal.

oF : The ¼-speed tuning function OFF.

OFF (default)

/// **NOTE:** This function is only available when the programmable tuning step is OFF (p. 26).

■ Set mode (Continued)

Mic Up/Down Speed

This item sets the rate at which frequencies are scanned when the microphone [UP]/[DN] keys are pushed and held.

- HI : High speed (50 tuning steps/sec.)
- Lo : Low speed (25 tuning steps/sec.)

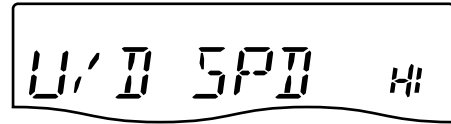

High (default)

SSB/CW Synchronous Tuning

This item turns the displayed frequency shift function from ON or OFF.

When this function is set to ON, the received signal will remain the same even when the operating mode is changed between SSB and CW.

The amount of frequency shift will change according to the CW pitch setting.

- on : The displayed frequency shifts when the operating mode is changed between SSB and CW.
- oF : The displayed frequency does not shift.



OFF (default)

CW Normal Side

Selects the carrier point of CW mode from LSB and USB.

- L (LSB) : LSB is the normal mode.
- U (USB) : USB is the normal mode.

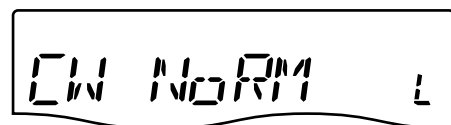

LSB (default)

Break-In

This item selects break-in type for CW operation.

Full break-in (QSK) activates the receiver between transmitted dots and dashes. This is useful when operating contests, when "fast responses" are common.

Semi break-in keeps the receiver quiet between dots and dashes and automatically returns to receive after a pre-set time from when you stop keying.

When break-in is turned off, the key or paddle can generate side tones (selectable in quick set mode) but will not transmit.

- oF : No break-in operation.
- SE (Semi) : Semi break-in operation.
- FL (Full) : Full break-in operation.



OFF (default)

Break-In Delay

This item adjusts break-in delay time for CW semi break-in operation.

The delay time is selectable from 0.2 to 13.0 (dots) in 0.1 (dots) steps.



7.5 dots (default)

Dot/Dash Ratio

This item sets the internal electronic keyer dot/dash ratio. 1:1:2.8 to 1:1:4.5 (in 0.1 steps) can be selected.

Keying weight example: Morse code "K"

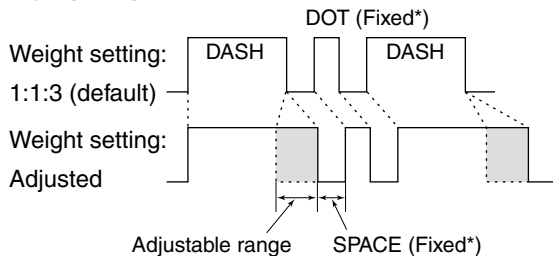

*SPACE and DOT length can be adjusted with "Key speed" only in the quick set mode.



1:1:3.0 (default)

Paddle Polarity

This item sets the paddle polarity.

n (Normal) : Normal polarity.
r (Reverse) : Reverse polarity.



Normal (default)

Keyer Type

This item selects the keyer type for the [KEY] connector on the rear panel.

EL : Internal electronic keyer is selected.
bG : Internal electronic keyer is activated as BUG key.
St : Internal electronic keyer is turned OFF, and a straight key or external electronic keyer can be used.

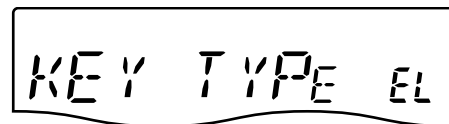

ELEC-KEY (default)

Mic Up/Down Keyer

This item allows you to set the microphone [UP]/[DN] switches to be used as a paddle.

on : [UP]/[DN] switches can be used as a paddle for CW mode operation.
oF : [UP]/[DN] switches cannot be used as a paddle for CW mode operation.

NOTE: When "ON" is selected, the frequency and memory channel cannot be changed using the [UP]/[DN] switches.

See p. 82 for the CW paddle connection to the MIC connector.

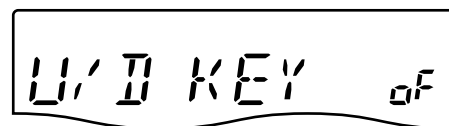

OFF (default)

■ Set mode (Continued)

Mode Select (SSB)

This item inhibits the selection of SSB (LSB/USB) modes, and allows you to simplify operation. For example if you are operating mobile and only plan on using AM mode, set all other modes (SSB, CW, RTTY) to OFF, thereby making selection of AM quick and easy.

- on : SSB modes are selectable.
- oF : SSB modes are inhibited.

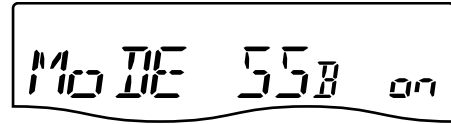

ON (default)

Mode Select (CW)

This item inhibits the selection of CW/CW-R modes, and allows you to simplify operation.

- on : CW modes are selectable.
- oF : CW modes are inhibited.

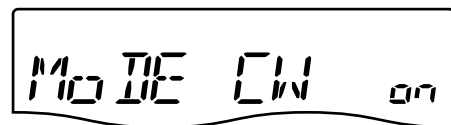

ON (default)

Mode Select (RTTY)

This item inhibits the selection of RTTY/RTTY-R modes, and allows you to simplify operation.

- on : RTTY modes are selectable.
- oF : RTTY modes are inhibited.

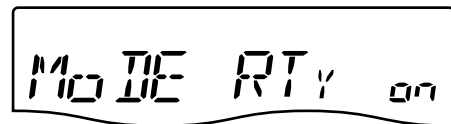

ON (default)

Mode Select (AM)

This item inhibits the selection of AM mode, and allows you to simplify operation.

- on : AM modes are selectable.
- oF : AM modes are inhibited.

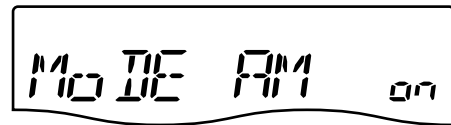

ON (default)

CI-V Baud Rate

Sets the CI-V data transfer rate. 300, 1200, 4800, 9600, 19200 bps and Auto are available. When Auto is selected, the baud rate is automatically set according to the connected controller or remote controller.



Auto (default)

CI-V Address

To distinguish equipment, each CI-V transceiver has its own Icom standard address in hexadecimal code.

The IC-7200's address is 76h.

When 2 or more IC-7200s are connected to an optional CT-17 CI-V LEVEL CONVERTER, rotate [DIAL] to select a different address for each IC-7200 in the range 01h to 7Fh.

76 : Address of 76h

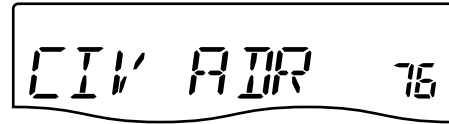

76h (default)

CI-V Transceive

Transceive operation is possible with the IC-7200 connected to other Icom HF transceivers or receivers.

When "ON" is selected, changing the frequency, operating mode, etc. on the IC-7200 automatically changes those of connected transceivers (or receivers) and vice versa.

on : Transceive ON

oF : Transceive OFF

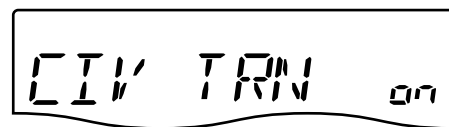

ON (default)

Reference Frequency Adjustment

Adjusts the internal reference signal frequency within 0% to 100% range in 1% steps during frequency calibration.

⚡ **NOTE:** Default setting is different for each transceiver.

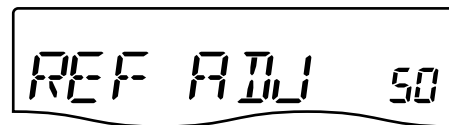
**◇ Paddle operation from [MIC] connector**

Connect a CW paddle as at right to operate an electronic keyer from the [MIC] connector.

- Be sure to select "Paddle Polarity," "Keyer Type" and "Mic Up/Down Keyer" in the set mode. (p. 80)
- Connect straight key to "DOT" side.
- Push both of "DOT" and "DASH" to activate the squeeze operation.

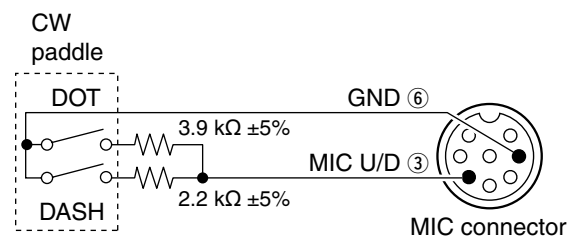

11 MAINTENANCE

■ Fuse replacement

If a fuse blows or the transceiver stops functioning, try to find the source of the problem, and replace the damaged fuse with a new, adequately rated fuse.

CAUTION: Disconnect the DC power cable from the transceiver when changing a fuse.

The IC-7200 has two fuses (DC power cable fuses) installed for transceiver protection.

- DC power cable fuses ATC 30 A
- Circuitry fuse ATC 5 A

◇ DC power cable fuse replacement

Refer the figure illustrated at right for the DC power cable fuse replacement.

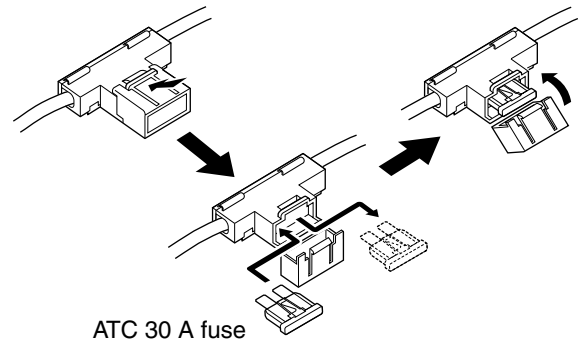

◇ Circuitry fuse replacement

The 13.8 V DC from the DC power cable is applied to all units in the IC-7200, except for the power amplifier, through the circuitry fuse. This fuse is installed in the PA unit.

- ① Remove the 11 screws, then remove the bottom cover and the PA shielding plate as shown below.

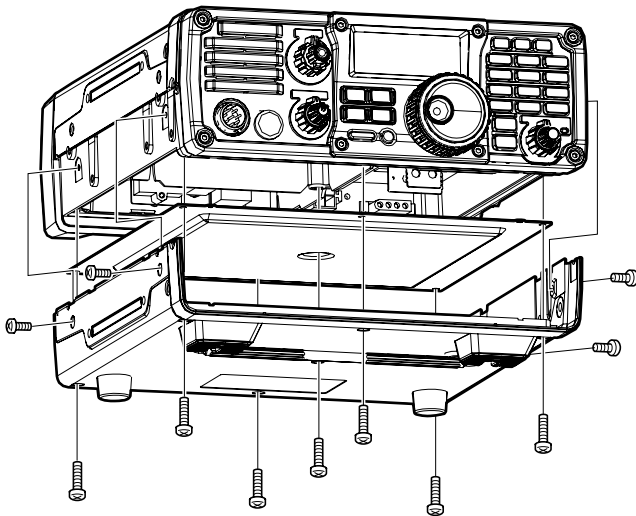

- ③ Replace the circuitry fuse as shown in the diagram as below.

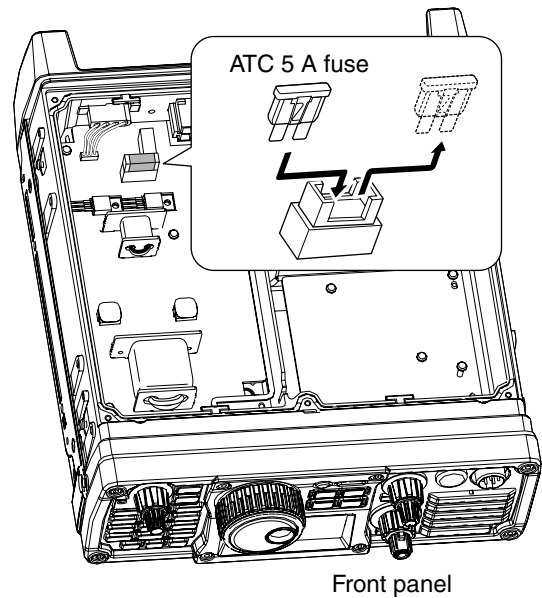

- ④ Replace the PA shielding plate, bottom cover and screws to their original position.

Be sure the gasket is seated correctly, and do not protrude from the transceiver when the PA shielding plate is replaced.

Memory backup

All of the CPU's memory is backed up by an EEPROM (Electrically-Erasable Programmable Read-Only Memory). All data you set, such as VFO, memory, set mode contents, etc. are stored in this EEPROM. There is no internal lithium battery.

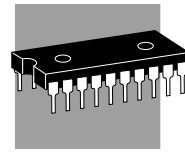

Resetting the CPU

- ① Make sure the transceiver power is OFF.
- ② While pushing and holding **F-INP ENT BAND** and **M-CL**, push **POWER** to turn power ON.
 - The internal CPU is reset, and all memory data are cleared.
 - The transceiver displays its initial VFO frequencies when resetting is complete.
- ③ All quick set mode/set mode settings are returned to default values. (p. 70)

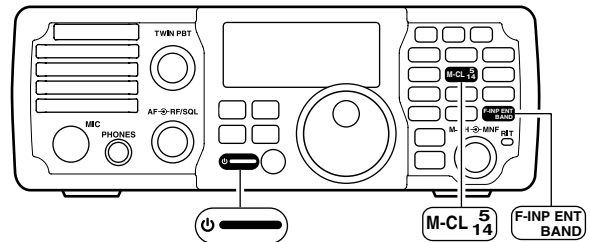

Resetting **CLEAR**s all programmed contents in memory channels and returns default values in quick set mode/set mode.

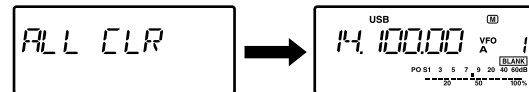

Cleaning



If the transceiver becomes dusty or dirty, wipe it clean with a dry, soft cloth.



AVOID the use of strong chemical solvents such as paint, thinner, benzene or alcohol to clean the transceiver. These may damage the transceiver's surfaces.

12 TROUBLESHOOTING

The following chart is designed to help you correct problems which are not equipment malfunctions.

If you are unable to locate the cause of a problem or solve it through the use of this chart, contact your nearest Icom Dealer or Service Center.

| | PROBLEM | POSSIBLE CAUSE | SOLUTION | REF. |
|---|--|--|---|---|
| POWER SUPPLY | Power does not come on when [PWR] is pushed. | <ul style="list-style-type: none"> • DC power cable is improperly connected. • Fuse is blown. • Battery is exhausted if you are using a 12 V battery as the power source. | <ul style="list-style-type: none"> • Reconnect the power cable correctly. • Check for the cause, then replace the fuse with a spare one. (Fuse is installed in the DC power cable) • Check the battery voltage. | <p>p. 15</p> <p>p. 83</p> <p>—</p> |
| | RECEIVE | No sound comes from the speaker. | <ul style="list-style-type: none"> • Volume level is set too low. • The squelch level is closed. • The transceiver is in the transmit mode. • An external speaker or headphones are connected. | <ul style="list-style-type: none"> • Rotate [AF] clockwise to obtain a suitable listening level. • Rotate [RF/SQL] to 12 o'clock position to open the squelch. • Release [PTT] on the microphone or check the SEND line of an external unit, if connected. • Check the external speaker or headphone plug connection. |
| Sensitivity is too low, and only strong signals are audible. | | <ul style="list-style-type: none"> • The antenna is not connected properly. • The antenna feed line is cut or shorted. • The antenna is not properly tuned. • The attenuator function is activated. • The antenna for another band is selected. | <ul style="list-style-type: none"> • Reconnect to the antenna connector. • Check the feed line and correct any improper conditions. • Push [TUNER] to manually tune the antenna. • Push [PAMP ATT] to turn the function OFF. • Select an antenna suitable for the operating frequency. | <p>—</p> <p>—</p> <p>p. 67</p> <p>p. 45</p> <p>p. 67</p> |
| Receive audio is distorted. | | <ul style="list-style-type: none"> • The operating mode is not selected correctly. | <ul style="list-style-type: none"> • Select a suitable operating mode. | <p>p. 29</p> |
| Receive signal is distorted by strong signals. | | <ul style="list-style-type: none"> • The noise reduction is activated and the noise reduction level is too high. • Noise blanker function is activated. • Preamp is activated. | <ul style="list-style-type: none"> • Set the noise reduction level for maximum readability. • Push [NB] to turn the function OFF. • Push [PAMP ATT] to turn the function OFF. | <p>p. 50</p> <p>p. 49</p> <p>p. 45</p> |
| The shift frequency of the RIT function cannot be added/subtracted. | | <ul style="list-style-type: none"> • The XFC (transmit frequency check function) is turned ON. | <ul style="list-style-type: none"> • Turn the XFC (transmit frequency check function) OFF in set mode. | <p>p. 76</p> |

| | PROBLEM | POSSIBLE CASE | SOLUTION | REF. |
|----------|--|---|---|---|
| TRANSMIT | Transmitting is impossible. | <ul style="list-style-type: none"> The operating frequency is not set in a ham band. | <ul style="list-style-type: none"> Set the frequency in a ham band. | p. 25 |
| | Output power is too low. | <ul style="list-style-type: none"> Power is set to a lower power than maximum. Microphone gain is set too low. The antenna is not connected properly. The antenna feed line is cut or shorted. The antenna is not properly tuned. The antenna for another band is selected. | <ul style="list-style-type: none"> Set the output power in quick set mode. Set microphone gain to a suitable level in quick set mode. Reconnect the antenna connector. Check the feed line and correct any improper conditions. Push TUNER to manually tune the antenna or test with dummy load. Select an antenna suitable for the operating frequency. | <p>p. 71</p> <p>p. 71</p> <p>—</p> <p>—</p> <p>p. 67</p> <p>p. 67</p> |
| | No contact possible with other stations. | <ul style="list-style-type: none"> RIT function is activated. Split function is activated. | <ul style="list-style-type: none"> Push RIT to turn the function OFF. Push SPLIT to turn the function OFF. | <p>p. 44</p> <p>p. 58</p> |
| | Transmitted signals are distorted. | <ul style="list-style-type: none"> Microphone gain is set too high. The compression level is set too high with the speech compressor ON. | <ul style="list-style-type: none"> Set microphone gain to a suitable level in quick set mode. Set compression level to a suitable position. | <p>p. 71</p> <p>p. 57</p> |
| DISPLAY | Displayed frequency does not change properly. | <ul style="list-style-type: none"> The dial lock function is activated. The internal CPU has malfunctioned. | <ul style="list-style-type: none"> Push SPCH to deactivate the function. Reset the CPU. | <p>p. 29</p> <p>pgs. 21, 84</p> |
| SCAN | Programmed scan does not stop. | <ul style="list-style-type: none"> [RF/SQL] is assigned to RF gain control and squelch is open. | <ul style="list-style-type: none"> Reset [RF/SQL] control assignment and set it to the threshold point. | p. 30 |
| | Programmed scan does not start. | <ul style="list-style-type: none"> The same frequencies have been programmed in scan edge memory channels. | <ul style="list-style-type: none"> Program different frequencies into scan edge memory channels. | p. 62 |
| | Memory scan does not start. | <ul style="list-style-type: none"> 2 or more memory channels have not been programmed. | <ul style="list-style-type: none"> Program 2 or more memory channels. | p. 62 |
| MEMORY | The memory channels cannot be selected with rotating the [M-CH] control. | <ul style="list-style-type: none"> The [M-CH] control acts as the RIT control mode. | <ul style="list-style-type: none"> Push M-CH/RIT SET to set the [M-CH] control to memory channel control. (RIT control indicator goes out). | p. 61 |

13 OPTION INSTALLATIONS

■ MB-116 HANDLES installation

The optional MB-116 HANDLES are convenient when moving the transceiver and can protect the face and radio knobs during transport.

- ➔ Attach the MB-116 to the both sides of the transceiver with the supplied screws (M4 × 9).

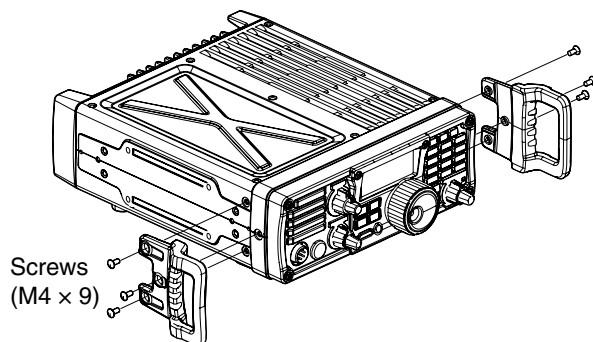

■ MB-117 CARRYING HANDLE installation

The optional MB-117 CARRYING HANDLE is convenient when carrying the transceiver for DX-peditions, field operation, etc.

- ① Attach the rubber feet to the [FOOT] holes on the right side of the transceiver with the supplied screws (M4 × 12).
- ② Attach the MB-117 to the [CARRYING HANDLE] holes on the left side of the transceiver with the supplied screws (M3 × 10).

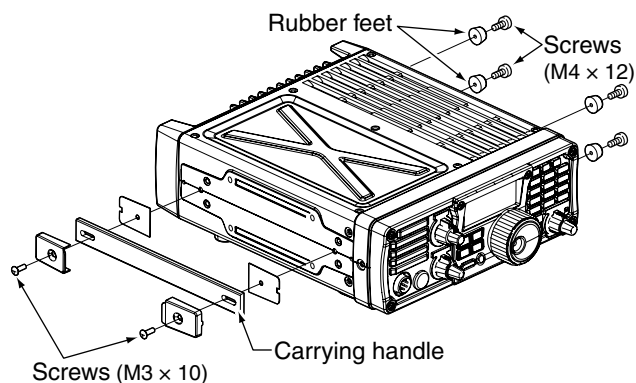

■ MB-118 MOBILE MOUNTING BRACKET installation

The universal mounting bracket allows overhead mounting.

- Mount the transceiver securely with the 4 supplied screws (5 × 20) to a thick surface which can support more than 5.5 kg (12.1 lb).

CAUTION: Non-supplied bolts (longer than 8 mm) may damage the internal units.

NEVER install the MB-118 with the non-supplied screws and bolts.

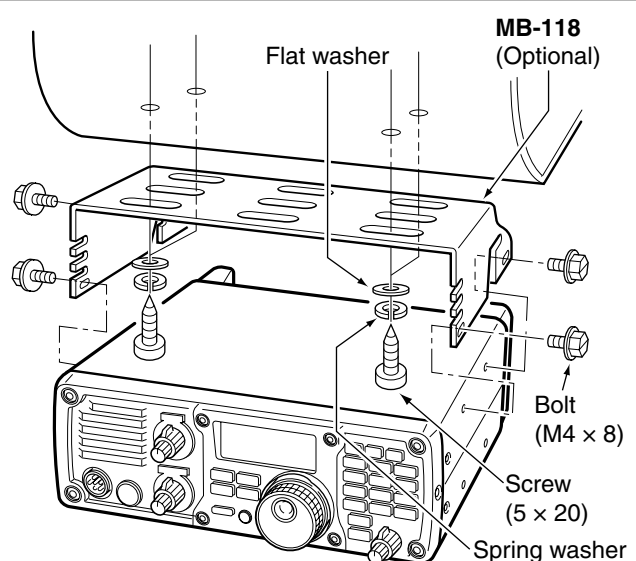

Remote jack (CI-V) information

CI-V connection example

The transceiver can be connected through an optional CT-17 CI-V LEVEL CONVERTER to a personal computer equipped with an RS-232C port. The Icom Communication interface-V (CI-V) controls the following functions of the transceiver.

Up to four Icom CI-V transceivers or receivers can be connected to a personal computer equipped with an RS-232C port. See pgs. 81, 82 for setting the CI-V condition using set mode.

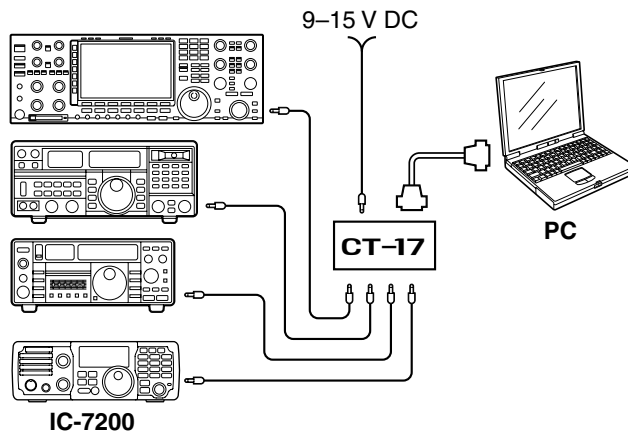

Data format

The CI-V system can be operated using the following data formats. Data formats differ according to command numbers. A data area is added for some commands.

CONTROLLER TO IC-7200

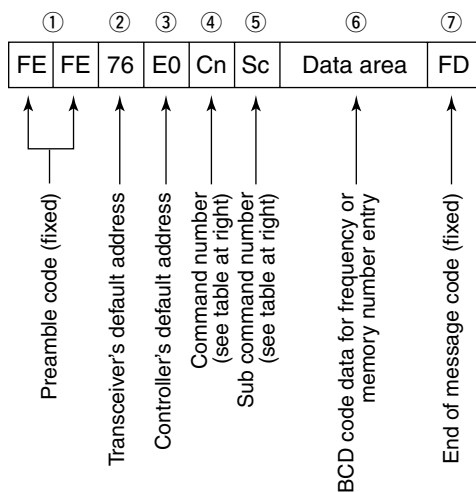

OK MESSAGE TO CONTROLLER



IC-7200 TO CONTROLLER

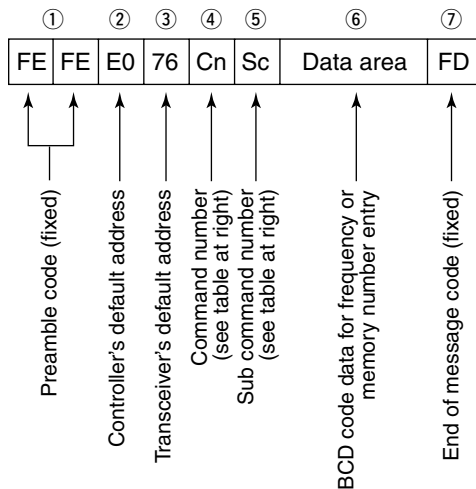

NG MESSAGE TO CONTROLLER



◆ Command table

| Command | Sub command | Description |
|---------|-------------|---|
| 00 | — | Send frequency data. (for transceive operation) |
| 01 | 00 | Select LSB mode (for transceive operation) |
| | 01 | Select USB mode (for transceive operation) |
| | 02 | Select AM mode (for transceive operation) |
| | 03 | Select CW mode (for transceive operation) |
| | 04 | Select RTTY mode (for transceive operation) |
| | 07 | Select CW-R mode (for transceive operation) |
| | 08 | Select RTTY-R mode (for transceive operation) |
| | 02 | — |
| 03 | — | Read operating frequency |
| 04 | — | Read operating mode |
| 05 | — | Set operating frequency |
| 06 | 00 | Select LSB mode |
| | 01 | Select USB mode |
| | 02 | Select AM mode |
| | 03 | Select CW mode |
| | 04 | Select RTTY mode |
| | 07 | Select CW-R mode |
| | 08 | Select RTTY-R mode |
| | 07 | — |
| 00 | | Select VFO A |
| 01 | | Select VFO B |
| A0 | | Equalize VFO A and VFO B |
| B0 | | Exchange VFO A and VFO B |
| 08 | — | Select memory mode |
| | 0001–0201* | Select memory channel *P1=0200, P2=0201 |
| 09 | — | Memory write |
| 0A | — | Memory to VFO |
| 0B | — | Memory clear |
| 0E | 00 | Scan stop |
| | 01 | Programmed/memory scan start |
| | 02 | Programmed scan start |
| | 22 | Memory scan start |
| | D0 | Set scan resume OFF |
| | D3 | Set scan resume ON |
| | 0F | 00 |
| 01 | | Turn the split function ON |
| 10 | 00 | Select 10 Hz (or 1 Hz) tuning step |
| | 01 | Select 100 Hz tuning step |
| | 02 | Select 1 kHz tuning step |
| | 03 | Select 5 kHz tuning step |
| | 04 | Select 9 kHz tuning step |
| | 05 | Select 10 kHz tuning step |
| 11 | — | Set/read attenuator. (0=OFF, 20=ON (20 dB)) |
| 13 | 00 | Announce with voice synthesizer |
| | 01 | (00=all data 01=frequency and S-meter; 02=receive mode) |
| | 02 | |

| Command | Sub command | Description |
|---------|---|--|
| 14 | 01 | [AF] level setting (0=max. CCW to 255=max. CW) |
| | 02 | [RF] level setting (0=max. CCW to 255=11 o'clock) |
| | 03 | [SQL] level setting (0=11 o'clock to 255=max. CW) |
| | 06 | NR level setting (0=0% to 255=100%) |
| | 07 | Inside [PBT] setting (0= max. CCW, 128=center, 255=max. CW) |
| | 08 | Outside [PBT] setting (0= max. CCW, 128=center, 255=max. CW) |
| | 09 | CW Pitch setting (0=300 Hz to 255=900 Hz (5 Hz steps)) |
| | 0A | RF power setting (0=minimum to 255=100%) |
| | 0B | MIC gain setting (0=0% to 255=100%) |
| | 0C | Key speed level setting (0=6 wpm to 255=60 wpm) |
| | 0D | [MNF] setting (0=max. CCW, 128=center, 255=max. CW) |
| | 0E | COMP level setting (0=0 to 255=10) |
| | 0F | Break-IN delay setting (0=2.0 d to 255=13.0 d) |
| | 12 | NB level setting (0=0% to 255=100%) |
| | 16 | VOX gain setting (0=0% to 255=100%) |
| | 17 | Anti VOX gain setting (0=0% to 255=100%) |
| | 15 | 01 |
| 02 | | Read S-meter level |
| 11 | | Read RF power meter |
| 12 | | Read SWR meter |
| 13 | | Read ALC meter |
| 16 | 02 | Preamp (0=OFF, 1=ON) |
| | 12 | AGC selection (0=OFF, 1=Fast, 2=Slow.) |
| | 22 | Noise blanker (0=OFF, 1=ON) |
| | 40 | Noise reduction (0=OFF, 1=ON) |
| | 41 | Auto notch (0=OFF, 1=ON) |
| | 44 | Speech compressor (0=OFF, 1=ON) |
| | 46 | VOX function (0=OFF, 1=ON) |
| | 47 | Break-IN function (0=OFF, 1=semi BK-IN, 2=full BK-IN) |
| | 48 | Manual notch (0=OFF, 1=ON) |
| | 4F | Twin peak filter (0=OFF, 1=ON) |
| 50 | Dial lock function (0=OFF, 1=ON) | |
| 19 | 00 | Read the transceiver ID |
| 1A | 00 | Set/read memory contents An additional code, 0001–0201 (0200=P1, 0201=P2), must be added to specify the memory channel. |
| | 01 | Set/read band stacking register contents (see p. 91 for details) |
| | 02 | Set/read the selected filter width (SSB, CW, RTTY: 0=50 Hz to 40/31=3600/2700 Hz; AM: 0=200 Hz to 39=8 kHz) |
| | 0301 | Set/read RF power setting (0=minimum to 255=100%) |
| 0302 | Set/read MIC gain setting (0=0% to 255=100%) | |

| Command | Sub command | Description |
|---------|-------------|---|
| 1A | 0303 | Set/read Key speed level setting (0=6 wpm to 255=60 wpm) |
| | 0304 | Set/read CW Pitch setting (0=300 Hz to 120=900 Hz; 5 Hz steps) |
| | 0305 | Set/read CW side tone setting (0=0% to 255=100%) |
| | 0306 | Set/read CW side tone level limit (0=OFF, 1=ON) |
| | 0307 | Set/read Twin peak filter (0=OFF, 1=ON) |
| | 0308 | Set/read RTTY mark frequency (0=1275 Hz, 1=1615 Hz, 2=2125 Hz) |
| | 0309 | Set/read RTTY shift width (0=170 Hz, 1=200 Hz, 2=425 Hz, 3=850 Hz) |
| | 0310 | Set/read RTTY keying polarity (0=Normal, 1=Reverse) |
| | 0311 | Set/read LCD brightness (0=OFF, 1=Dark, 2=Bright) |
| | 0312 | Set/read confirmation beep (0=OFF, 1=ON) |
| | 0313 | Set/read band edge beep (0=OFF, 1=ON) |
| | 0314 | Set/read beep gain (0=0% to 255=100%) |
| | 0315 | Set/read beep gain limit (0=OFF, 1=ON) |
| | 0316 | Set/read [RF/SQL] control set (0=Auto, 1=SQL, 2=RF+SQL) |
| | 0317 | Set/read meter peak hold (0=OFF, 1=ON) |
| | 0318 | Set/read quick split set (0=OFF, 1=ON) |
| | 0319 | Set/read split lock set (0=OFF, 1=ON) |
| | 0320 | Set/read transmit frequency monitor with [RIT] key set (0=OFF, 1=ON) |
| | 0321 | Set/read tuner auto start set (0=OFF, 1=ON) |
| | 0322 | Set/read PTT tune start set (0=OFF, 1=ON) |
| | 0323 | Set/read MOD input connector during DATA OFF (0=MIC, 1=ACC, 2=MIC+ACC, 3=USB) |
| | 0324 | Set/read MOD input connector during DATA ON (0=MIC, 1=ACC, 2=MIC+ACC, 3=USB) |
| | 0325 | Set/read MOD input gain from USB (0=0% to 255=100%) |
| | 0326 | Set/read speech level (0=0% to 255=100%) |
| | 0327 | Set/read speech language (0=English, 1=Japanese) |
| | 0328 | Set/read speech speed (0=Slow, 1=Fast) |
| | 0329 | Set/read S-level speech (0=OFF, 1=ON) |
| | 0330 | Set/read speech capability with [MODE] key operation (0=OFF, 1=ON) |
| | 0331 | Set/read scan speed set (0=Slow, 1=Fast) |
| | 0332 | Set/read scan resume set (0=OFF, 1=ON) |

| Command | Sub command | Description |
|---------|--|--|
| 1A | 0333 | Set/read main dial auto TS (0=OFF, 1=Low, 2=High) |
| | 0334 | Set/read 1/4 dial speed set (0=OFF, 1=ON) |
| | 0335 | Set/read mic. UP/DOWN speed (0=Low, 1=High) |
| | 0336 | Set/read SSB/CW synchronous tuning function (0=OFF, 1=ON) |
| | 0337 | Set/read CW carrier point set (0=LSB, 1=USB) |
| | 0338 | Set/read break-in set (0=OFF, 1=semi BK-IN, 2=full BK-IN) |
| | 0339 | Set/read break-in delay time set (20=2.0 d to 130=13.0 d) |
| | 0340 | Set/read CW keyer dot/dash ratio (28=1:1:2.8 to 45=1:1:4.5) |
| | 0341 | Set/read CW paddle polarity (0=Normal, 1=Reverse) |
| | 0342 | Set/read CW keyer type (0=Straight, 1=Bug-key, 2=ELEC Key) |
| | 0343 | Set/read MIC UP/DOWN keyer (HM-36) set (0=OFF, 1=ON) |
| | 0344 | Set/read SSB mode selectability (0=OFF: inhibition, 1=ON: selectable) |
| | 0345 | Set/read CW mode selectability (0=OFF: inhibition, 1=ON: selectable) |
| | 0346 | Set/read RTTY mode selectability (0=OFF: inhibition, 1=ON: selectable) |
| | 0347 | Set/read AM mode selectability (0=OFF: inhibition, 1=ON: selectable) |
| | 0348 | Set/read CI-V transceive set (0=OFF, 1=ON) |
| | 0349 | Set/read reference frequency set (0=0% to 255=100%) |
| | 0350 | Set/read noise blanker level set (0=0% to 255=100%) |
| | 0351 | Set/read noise blanker width set (0=0% to 255=100%) |
| | 0352 | Set/read NR level set (0=0 to 15=15) |
| | 0353 | Set/read VOX gain set (0=0% to 255=100%) |
| | 0354 | Set/read Anti-VOX gain set (0=0%, 255=100%) |
| | 0355 | Set/read VOX delay set (0=0.0 sec. to 20=2.0 sec.) |
| | 0356 | Set/read speech compressor level (0=0 to 10=10) |
| 04 | Send/read DATA mode with filter set (see next page for detail) | |
| 05 | Set/read DSP filter shape (0=Sharp, 1=Soft) | |
| 06 | Set/read manual notch width (0=Wide, 1=Mid., 2=Nar.) | |
| 1C | 00 | Set/read the transceiver's condition (0=Rx, 1=Tx) |
| | 01 | Set/read antenna tuner condition (0=OFF, 1=ON, 2=Start tuning or while tuning) |

◇ **Band stacking register**

To send or read the desired band stacking register's contents, a combination of the frequency band and the register codes ("01" is fixed as the register code) as follows are used.

For example, when sending/reading the contents in the 21 MHz band, the code "0701" is used.

• **Frequency band codes**

| CODE | BAND | FREQUENCY RANGE |
|------|---------|-----------------------|
| 01 | 1.8 MHz | 1.800000 – 1.999999 |
| 02 | 3.5 MHz | 3.400000 – 4.099999 |
| 03 | 7 MHz | 6.900000 – 7.499999 |
| 04 | 10 MHz | 9.900000 – 10.499999 |
| 05 | 14 MHz | 13.900000 – 14.499999 |
| 06 | 18 MHz | 17.900000 – 18.499999 |
| 07 | 21 MHz | 20.900000 – 21.499999 |
| 08 | 24 MHz | 24.400000 – 25.099999 |
| 09 | 28 MHz | 28.000000 – 29.999999 |
| 10 | 50 MHz | 50.000000 – 54.000000 |
| 11 | General | Other than above |

◇ **Data mode with filter width setting**

The following data sequence is used when sending or reading the data mode with filter width setting.

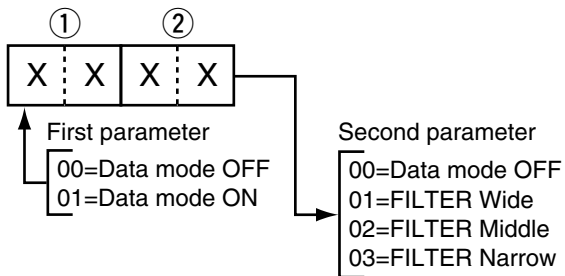

■ General

- Frequency coverage :
 - Receive
30 kHz–60.000000 MHz*1*2
 - Transmit
1.800–1.999999 MHz*2, 3.500–3.999999 MHz*2
5.33050*3, 5.34650*3, 5.36650*3,
5.37150*3, 5.40350*3,
7.000–7.300 MHz*2, 10.100–10.150 MHz,
14.000–14.350 MHz, 18.068–18.168 MHz,
21.000–21.450 MHz, 24.890–24.990 MHz,
28.000–29.700 MHz, 50.000–54.000 MHz*2,
*1Some frequency bands are not guaranteed.
*2Depending on version. *3USA version only.
- Mode : SSB, CW, RTTY, AM
- Number of memory CH : 201 (split memory: 199; scan edges: 2) channels
- Antenna connector : SO-239
- Antenna impedance : 50 Ω (unbalanced)
- Usable temperature range : –10°C to +60°C (+14°F to +140°F)
- Frequency stability : Less than ±0.5 ppm
- Power supply requirement : 13.8 V DC±15% (negative ground)
- Current drain : Transmit (at 100 W) 22 A
Receive squelched 1.3 A
max. audio 2.0 A
- Dimensions : 241(W) × 84(H) × 281(D) mm,
(projections not included) 9½(W) × 3⅝(H) × 11¼(D) in
- Weight (approx.) : 5.5 kg (12.1 lb)
- CI-V connector : 2-conductor 3.5 (d) mm (⅛")
- ACC connector : 13-pin

■ Transmitter

- Output power
 - SSB, CW, RTTY : 2–100 W
 - AM : 1–25 W* (*Carrier power)
- Modulation system
 - SSB : Digital PSN modulation
 - AM : Digital Low power modulation
- Spurious emissions
 - HF bands : Less than –50 dB
 - 50 MHz band : Less than –63 dB
- Carrier suppression : More than 50 dB
- Unwanted sideband : More than 50 dB
- Microphone connector : 8-pin connector (600 Ω)
- KEY connector : 3-conductor 6.3 (d) mm (¼")

■ Receiver

- Receive system : Triple-conversion superheterodyne
- Intermediate frequencies
 - 1st : 64.455 MHz
 - 2nd : 455 kHz
 - 3rd : 15.625 kHz
- Sensitivity (10dB S/N, preamp: ON, Filter shape: sharp)
 - SSB, CW : Less than 0.16 μV
(1.8–29.7 MHz)
Less than 0.13 μV
(50 MHz band)
 - AM : Less than 13 μV
(0.5–1.799 MHz)
Less than 2 μV
(1.8–29.7 MHz)
Less than 1 μV
(50 MHz band)
- Squelch sensitivity (SSB, threshold, preamp ON) : Less than 5.6 μV
- Selectivity
 - SSB* (BW=2.4 kHz) : More than 2.4 kHz/–6 dB
Less than 3.6 kHz/–60 dB
 - CW* (BW=500 Hz) : More than 500 Hz/–6 dB
Less than 900 Hz/–60 dB
 - RTTY (BW=350 Hz) : More than 360 Hz/–6 dB
Less than 650 Hz/–60 dB
 - AM (BW=6 kHz) : More than 6.0 kHz/–6 dB
Less than 15.0 kHz/–60 dB
*IF filter shape is set to SHARP.
- Spurious and image rejection ratio : More than 70 dB
(except ½ IF through on 50 MHz band)
- Audio output power : More than 2.0 W at 10% distortion with an 8 Ω load (at 13.8 V DC)
- RIT variable range : ±9.999 kHz
- PHONES connector : 3-conductor 6.3 (d) mm (¼")/8 Ω
- EXT SP connector : 2-conductor 3.5 (d) mm (⅛")/8 Ω

16 OPTIONS

AT-180 HF/50 MHz AUTOMATIC ANTENNA TUNER



Fully automatic antenna tuner with preset memories for each 100 kHz. Unique "automatic tuner on" function is available. See p. 68 for AT-180 specifications.

AH-4 HF AUTOMATIC ANTENNA TUNER



Specially designed to tune a long wire antenna for portable or mobile HF/50 MHz operation. The "PTT tune" function provides simple operation.

- Input power rating: 150 W

AH-2b ANTENNA ELEMENT



A 2.5 m long antenna element for mobile operation with the AH-4.

- Frequency coverage 7–54 MHz band with the AH-4

HM-36 HAND MICROPHONE



Hand microphone equipped with [UP]/[DOWN] switches.

SM-20 DESKTOP MICROPHONE



Includes [UP]/[DOWN] switches and a low cut function.

CT-17 CI-V LEVEL CONVERTER UNIT



For remote transceiver control using a personal computer equipped with an RS-232C port. You can change frequencies, operating mode, memory channels, etc., via your computer.

SP-10 EXTERNAL SPEAKER



External speakers suitable for mobile operation.

SP-10: Compact-type; 4 Ω/5 W

SP-20 EXTERNAL SPEAKER



4 audio filters; headphone jack; can connect to 2 transceivers.

- Input impedance: 8 Ω
- Max. input power: 5 W

SP-21 EXTERNAL SPEAKER



Designed for base station operation.

- Input impedance: 8 Ω
- Max. input power: 5 W

MB-116 HANDLE



Convenient when moving the transceiver and provides front panel protection during transport.

MB-117 CARRYING HANDLE



Convenient when carrying the transceiver.

MB-118 MOBILE MOUNTING BRACKET

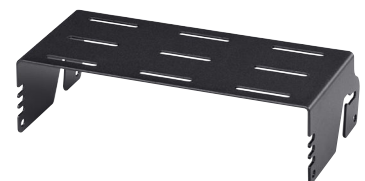

For mounting the transceiver in a vehicle.

OPC-598 ACC 13-PIN CABLE



Required when using the AT-180.
 • 7 m (22 ft)

OPC-599 ADAPTOR CABLE



13-pin, ACC connector to 7-pin + 8-pin ACC connector.

AH-710 FOLDED DIPOLE ANTENNA

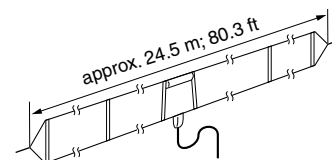

Covers from 1.9–30 MHz bands. Has an SO-239 connector. 30 m (98.4 ft) coaxial cable with PL-259 connector is supplied.

IC-PW1/EURO HF/50 MHz ALL BAND 1 kW LINEAR AMPLIFIER



Full-duty 1 kW linear amplifier including an automatic antenna tuner. Has automatic tuning and band selection capability. Full break-in (QSK) operation is possible. The amplifier/power supply unit and the remote control unit are separated. An optional OPC-599 is required for connection.

INSTALLATION NOTES

For amateur base station installations it is recommended that the forward clearance in front of the antenna array is calculated relative to the EIRP (Effective Isotropic Radiated Power). The clearance height below the antenna array can be determined in most cases from the RF power at the antenna input terminals.

As different exposure limits have been recommended for different frequencies, a relative table shows a guideline for installation considerations.

Below 30 MHz, the recommended limits are specified in terms of V/m or A/m fields as they are likely to fall within the near-field region. Similarly, the antennas may be physically short in terms of electrical length and that the installation will require some antenna matching device which can create local, high intensity magnetic fields. Analysis of such MF installations is best considered in association with published guidance notes such as the FCC OET Bulletin 65 Edition 97-01 and its annexes relative to amateur transmitter installations.

The EC recommended limits are almost identical to the FCC specified 'uncontrolled' limits and tables exist that show pre-calculated safe distances for different antenna types for different frequency bands. Further information can be found at <http://www.arrl.org/>.

• Typical amateur radio installation

Exposure distance assumes that the predominant radiation pattern is forward and that radiation vertically downwards is at unity gain (sidelobe suppression is equal to main lobe gain). This is true of almost every gain antenna today. Exposed persons are assumed to be beneath the antenna array and have a typical height of 1.8 m.

The figures assume the worst case emission of a constant carrier.

For the bands 10 MHz and higher the following power density limits have been recommended:

10–50 MHz 2 W/sq m

Vertical clearance by EIRP output

| | |
|------------|-------|
| 1 Watts | 2.1 m |
| 10 Watts | 2.8 m |
| 25 Watts | 3.4 m |
| 100 Watts | 5 m |
| 1000 Watts | 12 m |

Forward clearance by EIRP output

| | |
|---------------|-------|
| 100 Watts | 2 m |
| 1000 Watts | 6.5 m |
| 10,000 Watts | 20 m |
| 100,000 Watts | 65 m |

In all cases any possible risk depends on the transmitter being activated for long periods. (actual recommendation limits are specified as an average during 6 minutes) Normally the transmitter is not active for long periods of time. Some radio licenses will require that a timer circuit automatically cuts off the transmitter after 1–2 minutes etc.

Similarly some modes of transmission, SSB, CW, AM etc. have a lower 'average' output power and the assessed risk is even lower.



Versions of the IC-7200 which display the "CE" symbol on the serial number seal, comply with the essential requirements of the European Radio and Telecommunication Terminal Directive 1999/5/EC.



This warning symbol indicates that this equipment operates in non-harmonised frequency bands and/or may be subject to licensing conditions in the country of use. Be sure to check that you have the correct version of this radio or the correct programming of this radio, to comply with national licensing requirement.

• List of Country codes (ISO 3166-1)

| | Country | Codes | | Country | Codes |
|----|----------------|-------|----|----------------|-------|
| 1 | Austria | AT | 18 | Liechtenstein | LI |
| 2 | Belgium | BE | 19 | Lithuania | LT |
| 3 | Bulgaria | BG | 20 | Luxembourg | LU |
| 4 | Croatia | HR | 21 | Malta | MT |
| 5 | Czech Republic | CZ | 22 | Netherlands | NL |
| 6 | Cyprus | CY | 23 | Norway | NO |
| 7 | Denmark | DK | 24 | Poland | PL |
| 8 | Estonia | EE | 25 | Portugal | PT |
| 9 | Finland | FI | 26 | Romania | RO |
| 10 | France | FR | 27 | Slovakia | SK |
| 11 | Germany | DE | 28 | Slovenia | SI |
| 12 | Greece | GR | 29 | Spain | ES |
| 13 | Hungary | HU | 30 | Sweden | SE |
| 14 | Iceland | IS | 31 | Switzerland | CH |
| 15 | Ireland | IE | 32 | Turkey | TR |
| 16 | Italy | IT | 33 | United Kingdom | GB |
| 17 | Latvia | LV | | | |



DECLARATION OF CONFORMITY

We Icom Inc. Japan
1-1-32, Kamiminami, Hirano-ku
Osaka 547-0003, Japan



Declare on our sole responsibility that this equipment complies with the essential requirements of the Radio and Telecommunications Terminal Equipment Directive, 1999/5/EC, and that any applicable Essential Test Suite measurements have been performed.

Düsseldorf 30th Jun. 2008
Place and date of issue

Kind of equipment: HF/50 MHz TRANSCEIVER

Icom (Europe) GmbH
Himmelgeisterstraße 100
D-40225 Düsseldorf

Authorized representative name

Type-designation: IC-7200

Y. Furukawa
General Manager

Version (where applicable):

This compliance is based on conformity with the following harmonised standards, specifications or documents:

- i) EN 301 489-1 v1.6.1 (September 2005)
- ii) EN 301 489-15 v1.2.1 (August 2002)
- iii) EN 301 783-2 v1.1.1 (September 2000)
- iv) EN 60950-1 : 2001

Signature

Icom Inc.

• Version and frequency coverage

| |
|----------------------|
| Europe (#03) |
| Receive |
| 0.500–29.700000 MHz |
| 50.000–54.000000 MHz |
| Transmit |
| 1.810– 1.999999 MHz |
| 3.500– 3.800000 MHz |
| 7.000– 7.100000 MHz |
| 10.100–10.150000 MHz |
| 14.000–14.350000 MHz |
| 18.068–18.168000 MHz |
| 21.000–21.450000 MHz |
| 24.890–24.990000 MHz |
| 28.000–29.700000 MHz |
| 50.000–52.000000 MHz |

| |
|----------------------|
| France (#04) |
| Receive |
| 0.500–29.700000 MHz |
| 50.000–54.000000 MHz |
| Transmit |
| 1.810– 1.850000 MHz |
| 3.500– 3.800000 MHz |
| 7.000– 7.100000 MHz |
| 10.100–10.150000 MHz |
| 14.000–14.350000 MHz |
| 18.068–18.168000 MHz |
| 21.000–21.450000 MHz |
| 24.890–24.990000 MHz |
| 28.000–29.700000 MHz |
| 50.200–51.200000 MHz |

| |
|----------------------|
| Italy (#05) |
| Receive |
| 1.830– 1.850000 MHz |
| 3.500– 3.800000 MHz |
| 7.000– 7.200000 MHz |
| 10.100–10.150000 MHz |
| 14.000–14.350000 MHz |
| 18.068–18.168000 MHz |
| 21.000–21.450000 MHz |
| 24.890–24.990000 MHz |
| 28.000–29.700000 MHz |
| 50.000–51.000000 MHz |
| Transmit |
| 1.830– 1.850000 MHz |
| 3.500– 3.800000 MHz |
| 7.000– 7.200000 MHz |
| 10.100–10.150000 MHz |
| 14.000–14.350000 MHz |
| 18.068–18.168000 MHz |
| 21.000–21.450000 MHz |
| 24.890–24.990000 MHz |
| 28.000–29.700000 MHz |
| 50.000–51.000000 MHz |

| |
|----------------------|
| Spain (#06) |
| Receive |
| 0.500–29.700000 MHz |
| 50.000–54.000000 MHz |
| Transmit |
| 1.830– 1.850000 MHz |
| 3.500– 3.800000 MHz |
| 7.000– 7.200000 MHz |
| 10.100–10.150000 MHz |
| 14.000–14.350000 MHz |
| 18.068–18.168000 MHz |
| 21.000–21.450000 MHz |
| 24.890–24.990000 MHz |
| 28.000–29.700000 MHz |
| 50.000–52.000000 MHz |

| |
|-----------------------|
| Europe-1 (#07) |
| Receive |
| 0.500–29.700000 MHz |
| 50.000–54.000000 MHz |
| Transmit |
| 1.810– 1.999999 MHz |
| 3.500– 3.800000 MHz |
| 7.000– 7.200000 MHz |
| 10.100–10.150000 MHz |
| 14.000–14.350000 MHz |
| 18.068–18.168000 MHz |
| 21.000–21.450000 MHz |
| 24.890–24.990000 MHz |
| 28.000–29.700000 MHz |
| 50.000–52.000000 MHz |

18 BAND VOLTAGE MODIFICATION

■ Band voltage modification

If you want to connect an external unit which can be controlled by the band voltage from [ACC] connector, the modification is necessary as at right.

The band voltage appears from pin 5 of [ACC] connector after modification (①) is completed, or the regulated 8 V appears from pin 1 of [ACC] connector after modification (②) is completed.

▨ Performing this modification is the customer's responsibility. Icom does not guarantee this modification's result.

▨ **CAUTION:** Disconnect the DC power cable from the transceiver before any work on the transceiver.

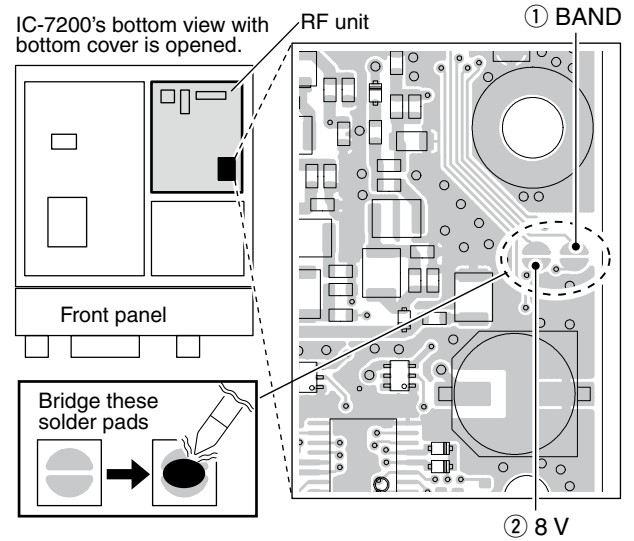

• Band voltage generator circuit

The below circuit is just for reference.

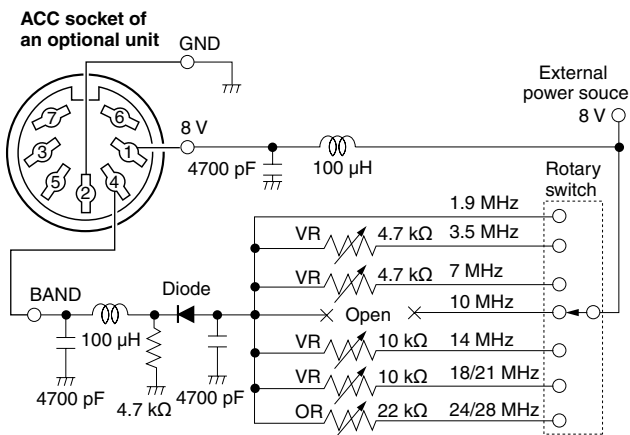

The following band voltage table is for reference only. Please adjust and confirm against the actual operating condition.

| BAND | VOLTAGE |
|-----------|----------------|
| 1.9 MHz | Non-adjustment |
| 3.5 MHz | 6.1 V |
| 7 MHz | 5.1 V |
| 10 MHz | Non-adjustment |
| 14 MHz | 4.1 V |
| 18/21 MHz | 3.1 V |
| 24/28 MHz | 2.1 V |

Count on us!

IC-7200 #03
(Europe)

< Intended Country of Use >
AT BE CY CZ DK EE
FI FR DE GR HU IE
IT LV LT LU MT NL
PL PT SK SI ES SE
GB IS LI NO CH BG
RO TR HR

IC-7200 #04
(France)

< Intended Country of Use >
AT BE CY CZ DK EE
FI FR DE GR HU IE
IT LV LT LU MT NL
PL PT SK SI ES SE
GB IS LI NO CH BG
RO TR HR

IC-7200 #05
(Italy)

< Intended Country of Use >
AT BE CY CZ DK EE
FI FR DE GR HU IE
IT LV LT LU MT NL
PL PT SK SI ES SE
GB IS LI NO CH BG
RO TR HR

IC-7200 #06
(Spain)

< Intended Country of Use >
AT BE CY CZ DK EE
FI FR DE GR HU IE
IT LV LT LU MT NL
PL PT SK SI ES SE
GB IS LI NO CH BG
RO TR HR

IC-7200 #07
(Europe-1)

< Intended Country of Use >
AT BE CY CZ DK EE
FI FR DE GR HU IE
IT LV LT LU MT NL
PL PT SK SI ES SE
GB IS LI NO CH BG
RO TR HR