



INSTRUCTION MANUAL

HF/VHF ALL MODE TRANSCEIVER **IC-7400**



FOREWORD

We understand that you have a choice of many different radios in the market place. We want to take a couple of moments of your time to thank you for making the IC-7400 your radio of choice, and hope you agree with Icom's philosophy of "technology first". Many hours of research and development went into the design of your IC-7400.

FEATURES

- 32-bit Floating point DSP and 24-bit AD/DA converter
- DSP IF Filter creates 102 types of filter
- All mode capability covering 160–2 m
- 100 Watt continuous duty cycle
- All mode digital modulation and demodulation
- RTTY demodulator and decoder
- Twin Pass Band Tuning
- RF speech compression with selectable pass band
- Microphone Equalizer
- SSB/CW synchronous tuning

IMPORTANT

READ THIS INSTRUCTION MANUAL CAREFULLY before attempting to operate the transceiver.

SAVE THIS INSTRUCTION MANUAL. This manual contains important safety and operating instructions for the IC-7400.

EXPLICIT DEFINITIONS

WORD	DEFINITION
⚠ WARNING	Personal injury, fire hazard or electric shock may occur.
CAUTION	Equipment damage may occur.
NOTE	If disregarded, inconvenience only. No risk or personal injury, fire or electric shock.

PRECAUTIONS

⚠ WARNING HIGH VOLTAGE! NEVER attach an antenna or internal antenna connector during transmission. This may result in an electrical shock or burn.

⚠ NEVER apply AC to the [DC13.8V] jack on the transceiver rear panel. This could cause a fire or ruin the transceiver.

⚠ NEVER apply more than 16 V DC, such as a 24 V battery, to the [DC13.8V] jack on the transceiver rear panel. This could cause a fire or ruin the transceiver.

⚠ NEVER let metal, wire or other objects touch any internal part or connectors on the rear panel of the transceiver. This may result in an electric shock.

NEVER expose the transceiver to rain, snow or any liquids.

AVOID using or placing the transceiver in areas with temperatures below -10°C ($+14^{\circ}\text{F}$) or above $+60^{\circ}\text{C}$ ($+140^{\circ}\text{F}$). Be aware that temperatures on a vehicle's dashboard can exceed 80°C ($+176^{\circ}\text{F}$), resulting in permanent damage to the transceiver if left there for extended periods.

AVOID placing the transceiver in excessively dusty environments or in direct sunlight.

AVOID placing the transceiver against walls or putting anything on top of the transceiver. This will obstruct heat dissipation.

Place unit in a secure place to avoid inadvertent use by children.

During mobile operation, **DO NOT** operate the transceiver without running the vehicle's engine. When the transceiver's power is ON and your vehicle's engine is OFF, the vehicle's battery will soon become exhausted.

Make sure the transceiver power is OFF before starting the vehicle. This will avoid possible damage to the transceiver by ignition voltage spikes.

During maritime mobile operation, keep the transceiver and microphone as far away as possible from the magnetic navigation compass to prevent erroneous indications.

BE CAREFUL! The heatsink will become hot when operating the transceiver continuously for long periods.

BE CAREFUL! If a linear amplifier is connected, set the transceiver's RF output power to less than the linear amplifier's maximum input level, otherwise, the linear amplifier will be damaged.

Use Icom microphones only (supplied or optional). Other manufacturer's microphones have different pin assignments, and connection to the IC-7400 may damage the transceiver.

TABLE OF CONTENTS

FOREWORD	i	■ Operating CW	27	■ Preparation	68
IMPORTANT	i	■ Electronic keyer functions	29	■ Voice squelch control function	69
EXPLICIT DEFINITIONS	i	■ Operating RTTY (FSK)	35	■ Scan set mode	69
PRECAUTIONS	i	■ RTTY functions	36	■ Programmed scan/Fine programmed scan	70
TABLE OF CONTENTS	ii	■ Operating AM	40	■ Memory scan operation	71
		■ Operating FM	41	■ Select memory scan	71
		■ Repeater operation	44	■ Δ F scan operation and Fine Δ F scan	72
QUICK REFERENCE GUIDE	I–X			■ Tone scan/DTCS code scan operation	73
■ Installation	I	5 FUNCTIONS FOR RECEIVE	46–53		
■ Operation	III			
■ Your first contact	IV	■ Simple band scope	46	9 ANTENNA TUNER OPERATION	74–76
■ Ready to call CQ?	IX	■ Preamp/Attenuator	47	
1 PANEL DESCRIPTION	1–12	■ RIT function	47	■ Antenna connection and selection	74
■ Front panel	1	■ AGC function	48	■ Antenna tuner operation	75
■ Rear panel	7	■ IF filter selection	49	■ Optional external tuner operation	76
■ LCD display	9	■ IF (DSP) filter shape	50		
■ Multi function switches	11	■ Noise blanker	50	10 DATA COMMUNICATION ..	77–79
■ Microphone (HM-36)	12	■ Meter peak hold function	50	
2 INSTALLATION AND CONNECTIONS	13–17	■ Twin PBT operation	51	■ Connections	77
■ Unpacking	13	■ Noise reduction	52	■ Packet (AFSK) operation	78
■ Selecting a location	13	■ Notch function	52	■ Adjusting the TNC output level	79
■ Grounding	13	■ Dial lock function	52	■ Data transmission speed	79
■ Antenna connection	13	■ Voice squelch control function	53		
■ Required connections	14			11 SET MODE	80–88
■ Advanced connections	15	6 FUNCTIONS FOR TRANSMIT	54–60	
■ Power supply connections	16		■ General set mode	80
■ Linear amplifier connections (not usable in European countries)	17	■ VOX function	54	■ Tone control set mode	88
■ External antenna tuner connections	17	■ Break-in function	55		
		■ Δ TX function	56	12 OPTION INSTALLATION ..	89–90
		■ Monitor function	56	
		■ Speech compressor	57	■ Opening the transceiver's case	89
		■ Transmit filter width selection	57	■ UT-102 VOICE SYNTHESIZER UNIT	89
		■ Split frequency operation	58	■ CR-338 HIGH STABILITY CRYSTAL UNIT	90
		■ Quick split function	59	
		■ Measuring SWR	60	13 MAINTENANCE	91–93
				
		7 MEMORY OPERATION	61–67	■ Trouble shooting	91
			■ Fuse replacement	92
		■ Memory channels	61	■ Tuning dial brake adjustment	92
		■ Memory channel selection	61	■ Resetting the CPU	93
		■ Programming a memory	62	■ Frequency calibration (approximate)	93
		■ Memory clearing	62	
		■ Selecting the call channel	63	14 CONTROL COMMAND	94–98
		■ Programming the call channel	63	
		■ Frequency transferring	64	■ Remote jack (CI-V) information	94
		■ Programming scan edges	65		
		■ Assigning memory names	66	15 SPECIFICATIONS	99
		■ Memo pads	67	
				16 OPTIONS	100
		8 SCANS	68–73	
			17 ABOUT CE	101–102
		■ Scan types	68		

SUPPLIED ACCESSORIES

The transceiver comes with the following accessories.

	Qty.
① DC power cable*	1
② Hand microphone (HM-36)	1
③ Spare fuses (FGB 30 A)	2
④ Spare fuse (FGB 5 A)	1
⑤ CW keyer plug (AP-330)	1

*The illustration shows OPC-025D. However, OPC-639 is supplied with versions, which "CE" symbol on the serial number.

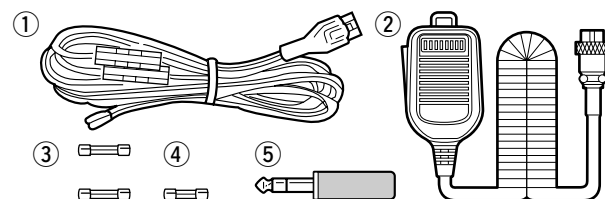

QUICK REFERENCE GUIDE

■ Installation

1. Install a ground system for DC noise suppression and RFI suppression
2. Install your DC power supply
3. Install lightning protection. This will help protect more than your gear.

4. Install and connect an antenna system for the appropriate bands of operation
5. Connect other peripheral equipment. This includes microphones, headsets, TNC, amplifiers and any other equipment necessary to make your shack complete.

1. Grounding your Shack

Although your radio will operate by connecting the DC power supply and antenna, it is necessary to have a good ground system in your shack. A ground connection is the electrical contact between the common point of an electrical or electronic system and the earth.

A good earth ground is necessary to prevent electrical shock, eliminate problems from RFI and DC noise. With more electronic devices being used today, it is also important to reduce RFI and EMI. Although you may not see interference in your shack, without a grounding system, your neighbors may experience interference. Even though many of these devices, where they must accept interference from their surrounding environment, it is best to eliminate as much of the possible interference from your shack.

If you do not have a grounding system for your shack, depending on the location of your shack, basement or ground floor, a good ground system can be as simple as a couple of ground rods driven 2 to 2.5 meter into the soil. When installing your IC-7400 to your grounding system, the shortest most direct connection is recommended.

NOTE: There are many publications covering proper grounding techniques. Check with your local dealer for more information and recommendations.

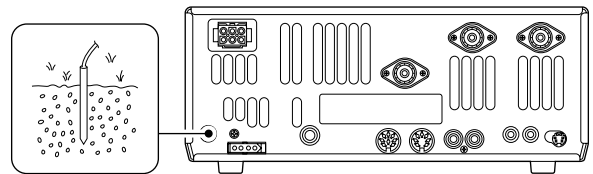

WARNING! NEVER ground station equipment or antennas to house gas lines. NEVER attach ground lines to plastic (pvc) pipe.

◆ Some Symptoms if inadequate grounding

a. Poor DC Ground

50/60 Hz hum on the audio either Rx or Tx without the antenna connected.

If you feel a tingling sensation when you touch a metal surface. Surfaces such as the cover of your radio or power supply.

b. Poor RF Ground

While transmitting and you feel a tingling sensation when you touch a metal surface. Surfaces such as the cover of your radio or power supply.

While transmitting, you experience interference to other electronic devices, such as the telephone, television or stereo audio systems.

2. Installing your DC Power Supply

The DC power supply is a device used to convert 110/220 V AC, also know as Household current, to a steady source of 13.8 V DC.

The perfect match to your IC-7400 is the PS-125. This compact switching power supply is the matching power supply for your IC-7400 with a current rating of 25 A continuous duty. This plug and play unit plugs into the DC jack located on the rear of the radio.

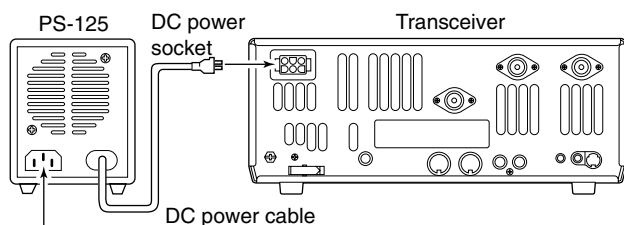

Connect to an AC outlet using the supplied AC cable.

•If you are not using the PS-125:

Connect the supplied DC power cable to the appropriate color coded terminals, then insert the DC connector into the DC jack located on the rear of the radio. (The diagram below describes the connection with OPC-639. OPC-025D has no filter box and GND cable.)

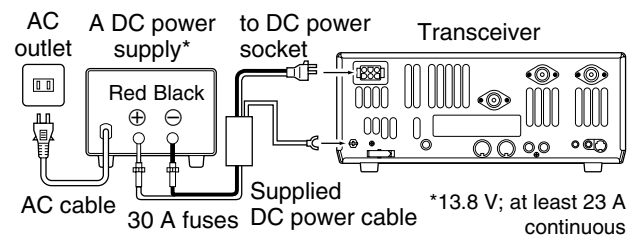

NOTE: Although the power supply current requirement is quite low during receiving, this not the case when you transmit. With many electrical devices in the shack, it is very important to verify the electrical circuit is not overloaded.

3. Installing lightning protection

Although you may not live in an area with high occurrence for lightning storms, it is always wise to take precautions for lightning or static discharges. Proper lightning protection not only offers protection to the ham gear, but the shack and most importantly the operator.

NOTE: There are many publications covering proper lightning protection, check with your local dealer for more information and recommendations.

4. Installing your antenna system

Whether your IC-7400 is your first radio or one of many, one of your key elements in a great shack is the antenna system. There are three connections on the back of your IC-7400, two for HF and 6 m and one for 2 m. If you are using one antenna for HF and 6 m, for simplicity, connect the antenna coax to ANT 1.

ANTENNA 1, 2

[Example]: ANT1 for 1.8–18 MHz bands
ANT2 for 21–50 MHz bands

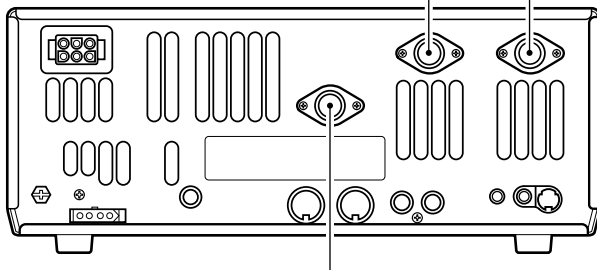

144 MHz ANTENNA

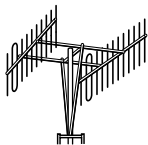

Connect a VHF (60–144 MHz) antenna; impedance: 50 Ω.

Your IC-7400 is equipped with an internal antenna tuner (ATU) for operation on 160–6 m. This ATU is designed to work with an unbalanced 50 Ω feedline. The purpose of the internal antenna tuner is to match the impedance of your antenna system to as close to a 50 Ω load as possible. This ATU will not operate with a long wire or ladder line (450 Ω or other balanced feedlines). An external ATU such as the AH-4 would be necessary for this kind of operation.

Antenna SWR

Each antenna is tuned for a specified frequency range and SWR may be increased out-of-range. When the SWR is higher than approx. 2.0:1, the transceiver's power drops to protect the final transistors. In this case, an antenna tuner is useful to match the transceiver and antenna. Low SWR allows full power for transmitting even when using the antenna tuner. The IC-7400 has an SWR meter to monitor the antenna SWR continuously.

PL-259 CONNECTOR INSTALLATION EXAMPLE

- ① Slide the coupling ring down. Strip the cable jacket and soft solder.
 - ② Strip the cable as shown at left. Soft solder the center conductor.
 - ③ Slide the connector body on and solder it.
 - ④ Screw the coupling ring onto the connector body.
- 30 mm ≈ 9/16 in 10 mm ≈ 3/8 in 1–2 mm ≈ 1/16 in

WARNING: Although a mag mount antenna works great on a vehicle, **DO NOT** use the IC-7400 with this type of antenna.

CAUTION: Although your IC-7400 has protection to drop down power with a high SWR, this does not completely protect the transceiver from transmission without an antenna. Make sure you have an antenna connected whenever you transmit with your radio.

NOTE: There are many publications covering proper antennas and their installation, check with your local dealer for more information and recommendations.

5. Connect other peripheral equipment

Everyone has his or her favorite ad-on gear; now is the time to connect this gear! We will cover the basic devices that can be connected to your IC-7400.

If you do not see the particular item you are wanting to connect, refer to the Advance Connections section starting on page 15.

■ Operation

1. Voice

Microphones: Connect the microphone to the eight-pin connector on the front of the radio.

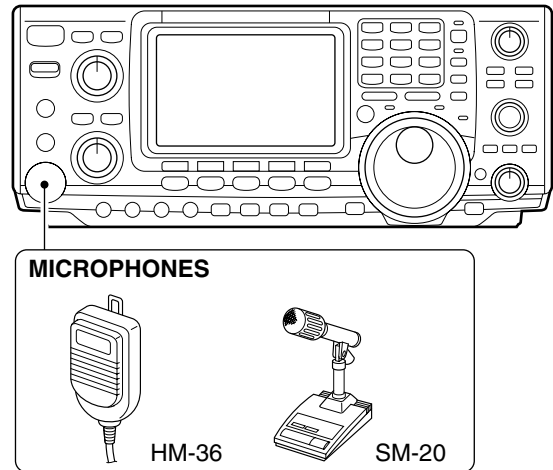

2. CW

CW Key: There are several types of keys or keyers that can be used with your IC-7400.

a. Iambic Key paddle: Use a 6.35(d) mm (1/4") stereo plug and connect to the [ELEC-KEY] jack located on the front of the radio.

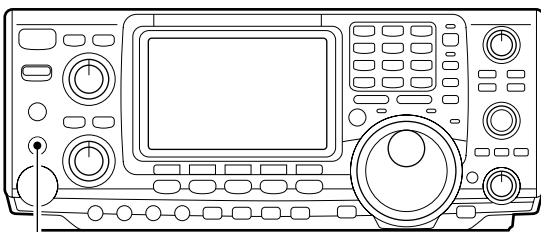

CW KEY

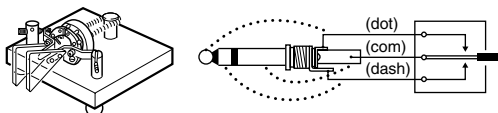

A straight key can be used when the internal electronic keyer is turned OFF in keyer set mode. (p. 34)

b. Straight Key: Use a 6.35(d) mm (1/4") mono plug and connect key to the back of the radio.

c. External Keyer: Use a 6.35(d) mm (1/4") mono plug and connect to the back of the radio.

d. Computer Keying: Use a 6.35(d) mm (1/4") mono plug and connect to the back of the radio.

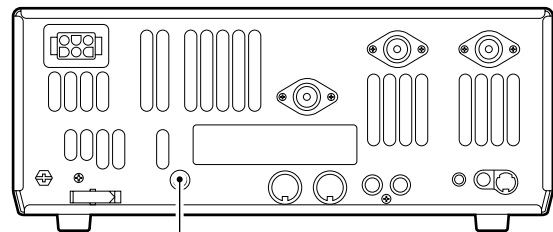

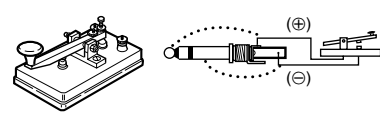

STRAIGHT KEY

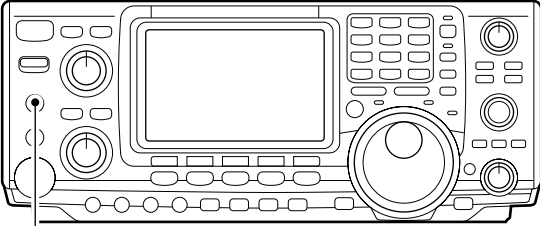

NOTE: You will need to select the type of keyer you are using in the Keyer Set mode. There are many advanced CW functions in this set mode, until you have a full understanding of these functions change only the items necessary.

3. Other convenient items

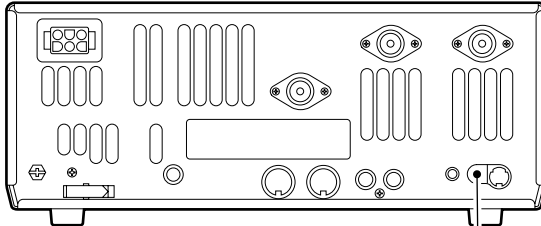
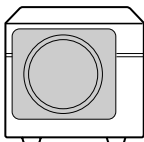
<p>Headphones: A 6.35(d) mm (1/4") mono jack for operation without using the internal or external speakers. Perfect for operation without disturbing others in the room.</p>  <p>HEADPHONES</p> 	<p>External Speaker: A 3.5(d) mm (1/8") mono jack for operation with an external speaker. (Input impedance: 8 Ω/Max. input power: 5 W)</p>  <p>EXTERNAL SPEAKER</p> <p>SP-21 (optional)</p> 
--	---

■ Your first contact

Now you should have your IC-7400 installed in your shack, and like a kid on his birthday, you are probably excited to get on the air. We would like to take you through a few basic operation steps to make your first "On The Air" an enjoyable experience.

◇ Getting started

1. Before powering up your radio, you may want to make sure the following controls are set in the following positions:

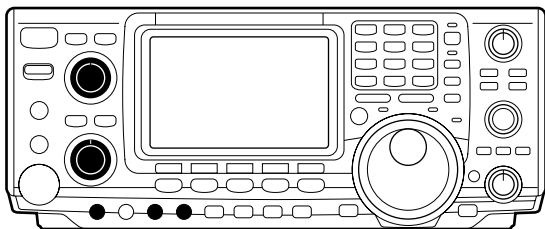

- [AF] : Commonly referred to as the volume: fully counter clockwise.
- [NR] : The noise reduction control: fully counter clockwise.
- [MIC GAIN] : The mic gain: fully counter clockwise.
- [RF/SQL] : The control for the RF Gain and Squelch circuits: 12 o'clock.
- [CW PITCH] : The control for the CW pitch: 12 o'clock.
- [KEY SPEED] : Internal CW Keyer Speed: fully counter clockwise.
- [NOTCH] : Control for the manual notch: 12 o'clock

2. Resetting the CPU: Although you have purchased a brand new radio, some settings may be changed from the factory defaults during the QC process. So your radio can start from Factory Defaults resetting the CPU is necessary.

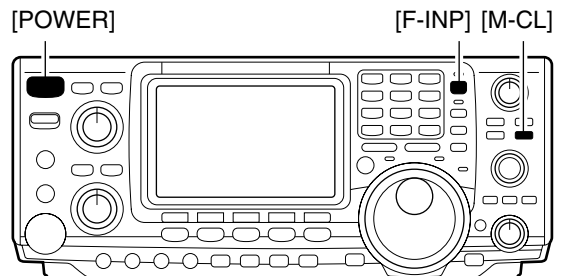

◆ Just listening

1. Select the desired band

On your IC-7400, an easy way of changing bands is by using the keypad located just above the tuning knob on the right hand side of the display. You will notice each switch has two sets of numbers; one set of numbers represents the band selection.

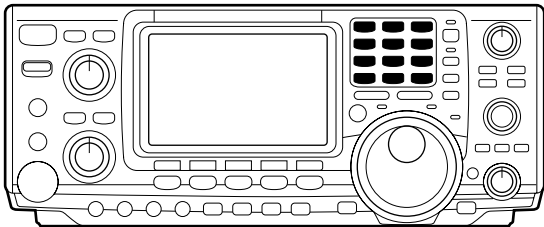

• Say you want to go to 20 meters or 14 MHz; you would push the [14 5]. This will immediately change the displayed operating frequency to the 20-meter band. By pushing [14 5] again, frequency pre-sets in the triple band stacking registers frequency can be displayed. For more details on this system refer to p. 19.

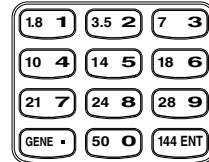

2. Tune to the desired frequency

Directly below the keypad is the tuning knob. This will allow you to dial in the frequency you want to operate. You will notice the tuning speed [TS] is 10 Hz resolution. Page 22 will instruct you on how to set the tuning speed [TS] for 1 Hz resolution.

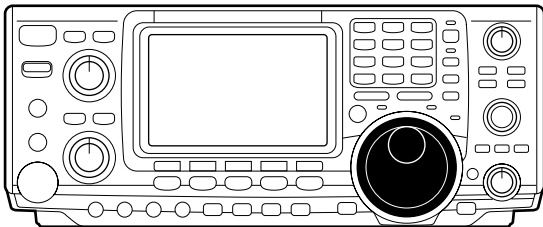

NOTE: Although you can directly enter the frequency with the keypad, using the Band Stacking Register and the tuning knob is the most popular method of hopping around the bands. For more information regarding the direct frequency entry method, refer to p. 22.

3. Verify proper antenna has been selected.

Your IC-7400 has three antenna connectors. Two for HF and 6 m and a one for 2 m. The selection for 2 m is automatic, where the HF and 6 m is user selectable for either one of the antenna jacks. For first time use, the antenna selector should show “1 ▽” on the display of your radio. Verify the antenna selected on the display is the antenna port your antenna is connected to.

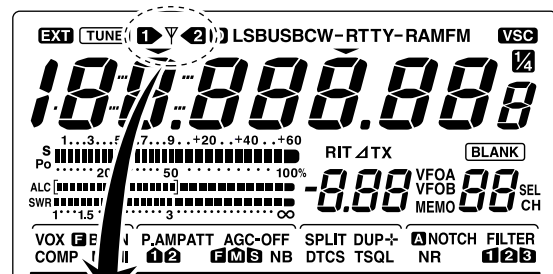

1 ▽ **2 ◁** Either “1” or “2” appears. *No indicator appears during 144 MHz operation.

4. Adjust audio output

Adjust this control to a comfortable audio level.

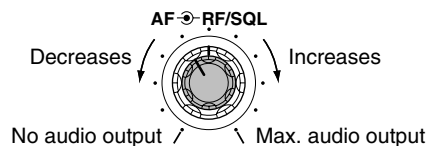
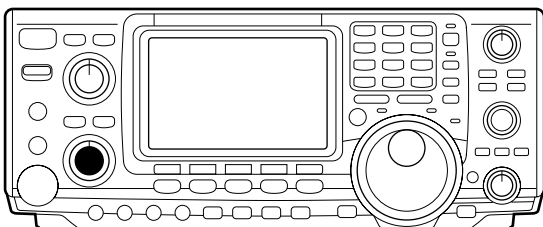

◆ **What are you hearing?**

Stop and focus on what you are hearing. Do you hear a lot of noise? Is the signal intelligible? Are you set up for the right mode? How about the filters?

1. Verify mode

Although your IC-7400 will automatically select USB or LSB in the HF bands, it will not select any of the other modes. You will need to select the proper mode whether CW, RTTY, AM or FM.

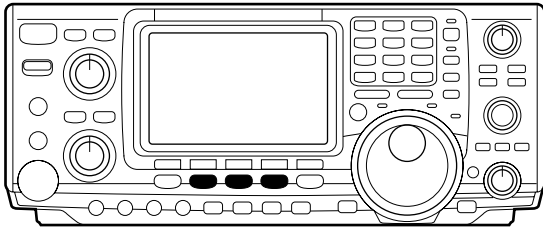

Hint!
The Triple Band Stacking Register will memorize the last three frequencies used in the band, as well as the Mode, Filter, Tuner and AGC settings. This makes band hopping much easier.

2. Reducing interference

Your IC-7400 has many features to reduce QRM and QRN from the desired signal.

a. Noise Reduction: The noise reduction system on your IC-7400 is part of the 32-bit DSP. This is used to reduce the hiss and QRM levels. To activate, push the [NR] switch located just to the right of the [PHONES] jack.

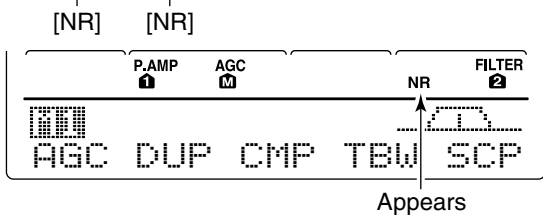
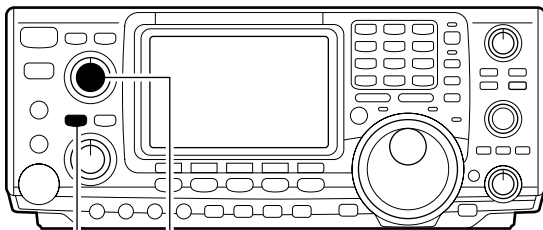

b. Adjusting the Noise Reduction: The noise reduction is completely variable on how much of the DSP Noise Reduction is used [NR] level control located just above the [NR] switch.

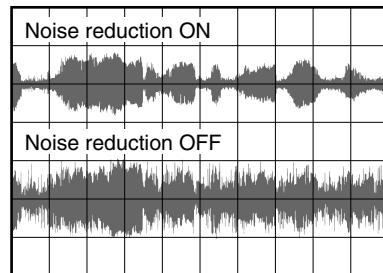
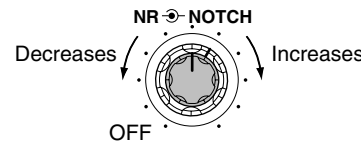

Hint!
How far you advance the NR control will determine how much the noise can be effectively reduced. Turning the control too far clockwise may cause some distortion to occur on the received signal. The NR control should only be turned as far clockwise as is necessary. Use this control, along with RF gain, NB (noise blanker, if needed), and IF filters as well, to minimize the effects of noise on the target signal.

c. Notch: There are two notch systems on your IC-746PRO.

- **Automatic:** The automatic notch will track up to three heterodynes. This is helpful for eliminating annoying transmitter “tune up” tones on any band, and to minimize continuous tone “heterodynes” encountered on the 40 meter phone bands at night, for example. Once selected an icon will appear “A NOTCH” on the display.

Hint!

The Automatic Notch will not operate in the SSB data, CW or RTTY modes.

- **Manual:** The Manual notch provides 70 dB of attenuation to pin point an interfering signal. The 12 o’clock position is on the operating frequency, turning the Notch knob clockwise moves the notch up the band and counter clockwise will move the notch down the band. Once selected an icon “NOTCH” will appear on the display.

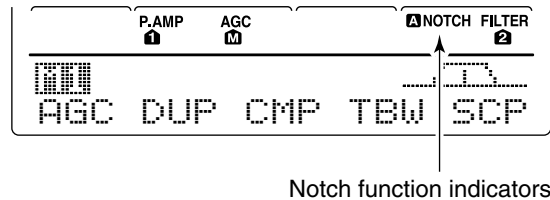
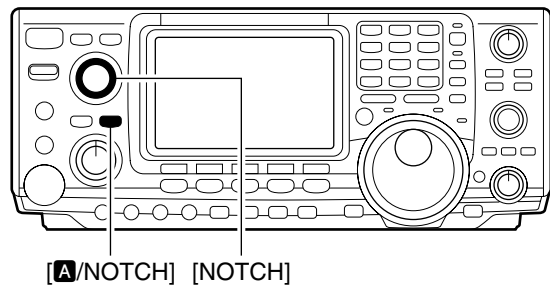
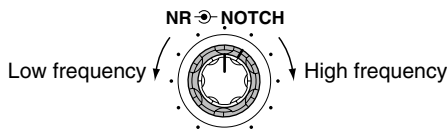

NOTE: Your IC-7400 is equipped with multiple AGC circuits. This allows the DSP to filter out interfering signals and QRM, while also taking this interference out of the AGC. Bottom line, this will either eliminate or greatly reduce the pumping of the AGC from the interfering signal.

d. Filters: Your IC-7400 has an incredible IF DSP based filter network with over 100 settings.

- **Dial in your filters:** By pushing [FILTER] for 1 sec., you enter the filter set mode. This is where you are able set the three filter presets. Across the bottom of the display you will see the “BW” icon. The switch directly below, along with the tuning dial, will be used to select the changes you will make.

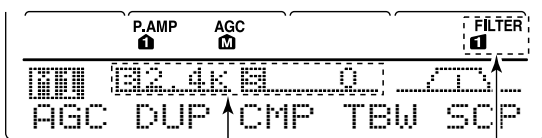
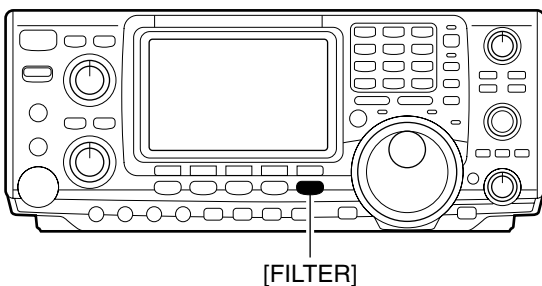

The selected filter width is indicated for approx. 1 sec. when [FILTER] is pushed.

• Filter set mode indication

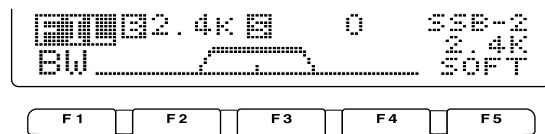

Shows the selected filter and passband width.

• Indication while setting

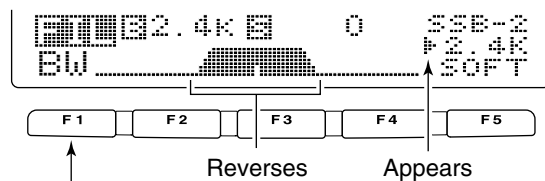

While pushing [F1 BW], rotate the tuning dial to set passband width.

d. Filters:— continued

•On the fly adjustment: Once the adjustments have been made in the filter set mode, you can make on the fly changes by using the Twin Pass Band Tuning, Twin PBT. You will be able to see the effects of the Twin PBT on the upper left hand side of the screen.

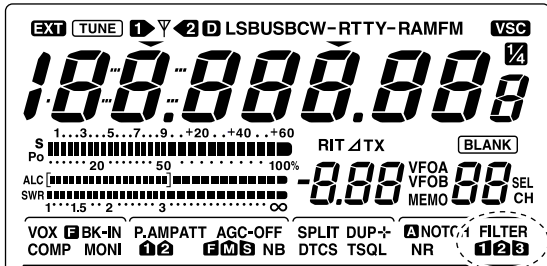

One of "1," "2" or "3" is displayed for selected filter number indications. **FILTER 1 2 3**

NOTE: The Twin PBT filters shift the two IF DSP filters (See Diagrams below and right). This feature allows both an IF shift as well as a narrowing of the Pass Band. Although you can narrow the pass band by shifting the two filters, this does not narrow both filters, thus the filter shape is not narrowed. You may hear some signal artifacts pass through this filter adjustment.

PBT operation example

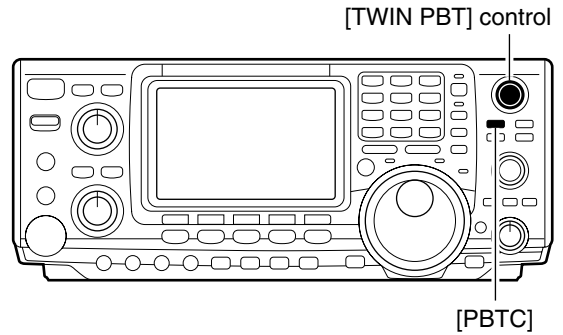

Passband width and shifting value are indicated while [TWIN PBT] is operated.

Appears when PBT is used.

• **Filter set mode indication**

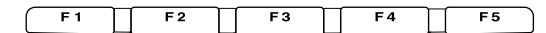
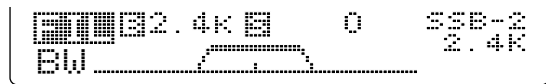

Shows the selected filter and passband width.

• **Indication while PBT setting**

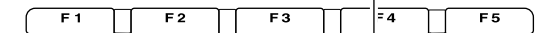

Appears when passband is shifted.

*By pushing [PBTC] for 1 sec., the shifted value returns to the default setting, and the "dot" disappears.

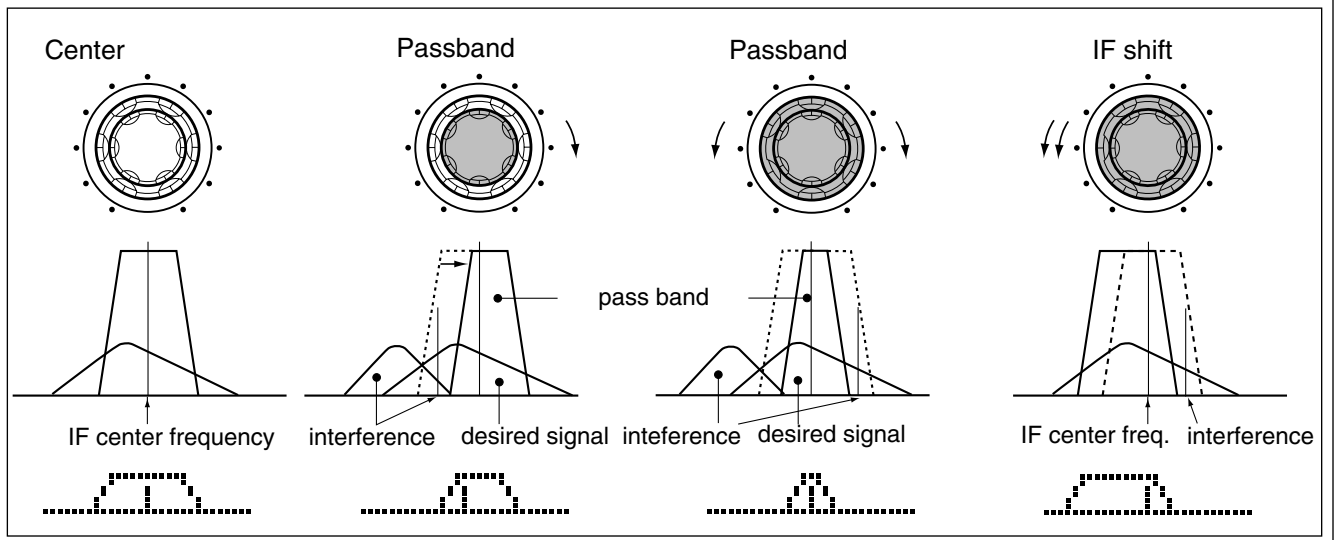

3. RX Tone Control:

Once you have mastered your filter settings, one last feature to enable the most intelligible audio is the actual audio tone you hear. You can adjust the equalization of your received audio ± 5 dB.

- ① Push [MENU] several times, or until **M2** is shown on the display.
- ② Push [F4 TCN] for the Tone Control set mode.
- ③ Push the appropriate mode switch to adjust SSB, AM or FM.
- ④ Push [F1 Δ] or [F2 ∇] to change to the desired component.

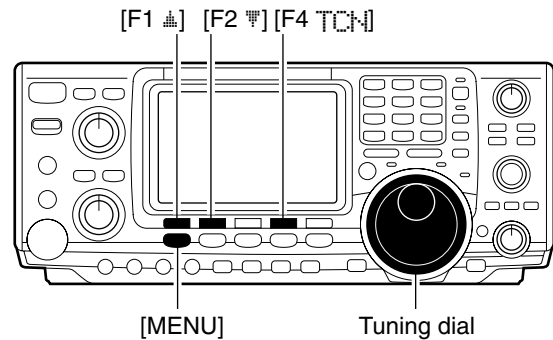

1. RX Bass

This item adjusts the bass level of the receive audio tone from -5 dB to $+5$ dB in 1 dB steps.



2. RX Treble

This item adjusts the treble level of the receive audio tone from -5 dB to $+5$ dB in 1 dB steps.



We hope these pointers have been helpful. Now you are ready for the “Ready to call CQ?”

■ Ready to call CQ?

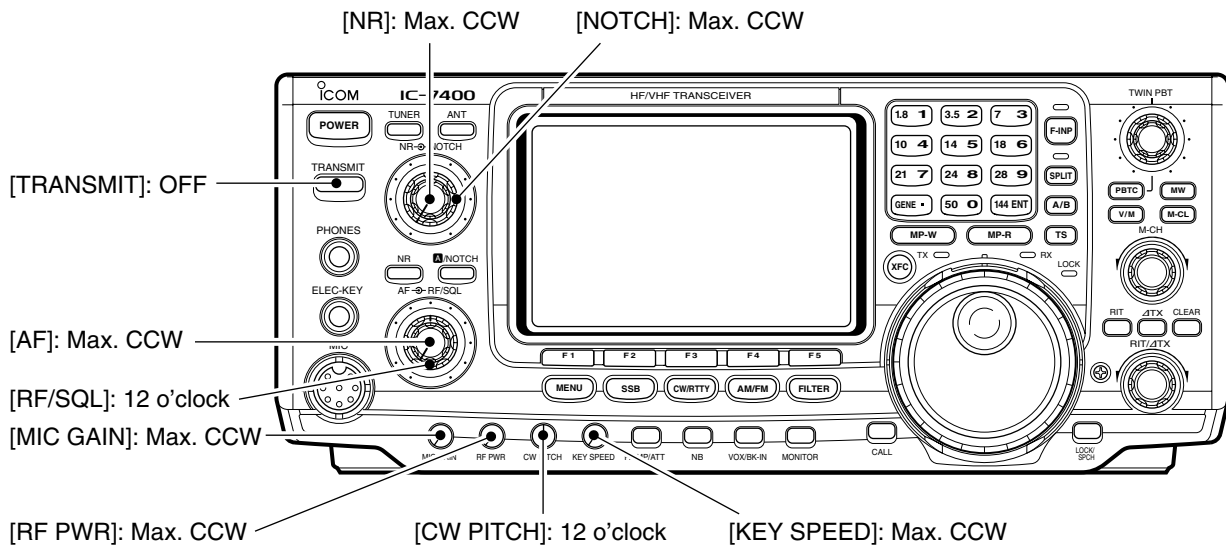

1. Setting up your transmit audio

The 32-bit DSP in your IC-7400 is capable of allowing you to select transmit audio for phone modes.

2. Mic Gain

The microphone gain is used for proper transmit audio level for full output power.

3. DSP TX Audio Pass Band

The capability of changing the pass band of your transmit audio, is at your finger tips. Regardless of the condition of the speech compressor, you can adjust it by selecting the [F4 TBW].

You will find this located in the M1 menu. By pushing [F4 TBW] for 1 sec. you can select the TX audio band pass.

There are three levels of audio passband width available (Wide, Mid, and Nar).

TX Audio Passband widths

Wide	: 2.8 kHz	; Great Full Audio
Mid	: 2.4 kHz	; Great for operators with deep full voices
Nar	: 2.2 kHz	; Great for breaking through pile ups

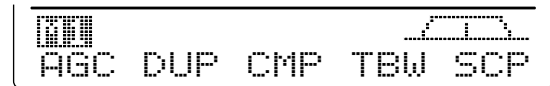

Push [F4] ↓



The selected transmit filter width is displayed for approx. 1 sec.

Push [F4] for 1 sec. to select the transmit filter width.

4. Microphone Equalizer

Although these bandwidths are fixed, the Microphone Tone Control will give you more audio control for your voice operation on SSB, AM, and FM modes. Your IC-7400 is equipped with a very powerful equalizer system with 121 possible combinations. This is achieved by using the separate bass and treble adjustments. The default for both the Base and Treble is at 0 dB.

Entering Microphone Tone Control set mode:

- ① Push [MENU] several times, or until M2 is shown on the display.
- ② Push [F4 TCH] for the Tone Control set mode.
- ③ Push the appropriate mode switch to adjust SSB, AM, or FM.
- ④ Push [F1 ▲] or [F2 ▼] to change to the desired component.

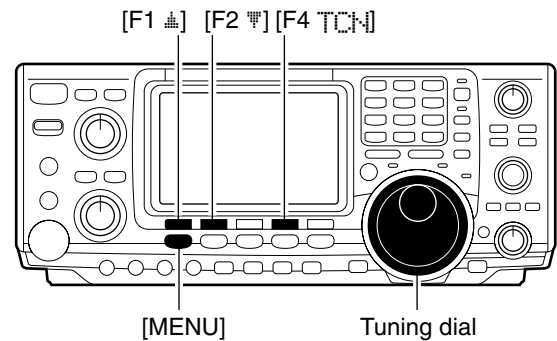

Hint!

Voice patterns and audio characteristics vary with each operator, therefore the [MIC GAIN], DSP TX Audio Pass Band and Microphone Tone Control settings will be different for each operator. Actual on air experimenting is necessary to get just the right sound. Listen to your transmit audio with headphones and the monitor function turned ON. It's also best to test and adjust your audio on the air, while someone who knows what your real voice sounds like listens, and provides and opinion on your audio quality.

1. TX Bass

This item adjusts the bass level of the transmit audio tone from -5 dB to +5 dB in 1 dB steps.



2. TX Treble

This item adjusts the treble level of the transmit audio tone from -5 dB to +5 dB in 1 dB steps.



Verify you have selected a clear frequency and call out your CQ!

■ Front panel

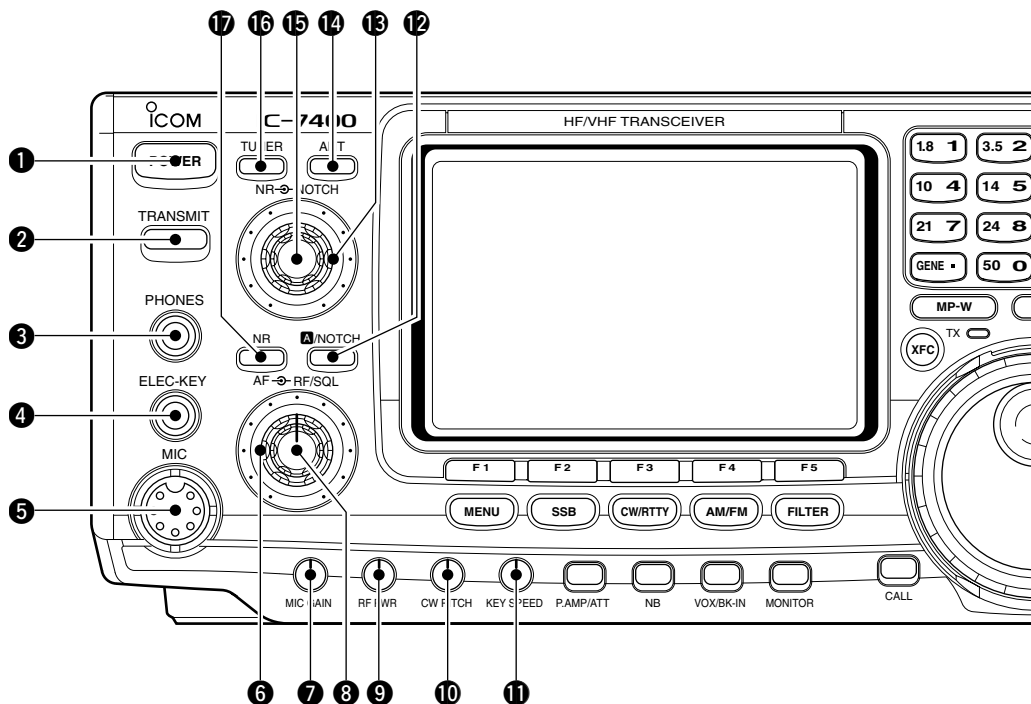

1 POWER SWITCH [POWER]

- ➔ Push momentarily to turn power ON.
 - Turn the optional DC power supply ON in advance.
- ➔ Push for 1 sec. to turn power OFF.

2 TRANSMIT SWITCH [TRANSMIT]

- Selects transmitting or receiving.
- The [TX] indicator lights red while transmitting and the [RX] indicator lights green when the squelch is open.

3 HEADPHONE JACK [PHONES]

- Accepts headphones.
- Output power: 5 mW with an 8 Ω load.
- When headphones are connected, the internal speaker or connected external speaker does not function.

4 ELECTRONIC KEYS JACK [ELEC-KEY] (p. 14)

- Accepts a paddle to activate the internal electronic keyer for CW operation.
- Selection between the internal electronic keyer, bug-key and straight key operation can be made in keyer set mode. (p. 34)
- A straight key jack is separately available on the rear panel. See [KEY] on p. 7.
- Keyer polarity (dot and dash) can be reversed in keyer set mode. (p. 34)
- 4-channel memory keyer is available for your convenience. (p. 30)

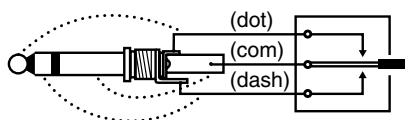

5 MICROPHONE CONNECTOR [MIC]

- Accepts the supplied or an optional microphone.
- See p. 101 for appropriate microphones.
- See p. 12 for microphone connector information.

6 RF GAIN CONTROL/SQUELCH CONTROL [RF/SQL] (outer control)

- Adjusts the RF gain and squelch threshold level. The squelch removes noise output from the speaker (closed condition) when no signal is received.
- The squelch is particularly effective for FM. It is also available for other modes.
- 12 to 1 o'clock position is recommended for any setting of the [RF/SQL] control.
- The control can be set as 'Auto' (RF gain control in SSB, CW and RTTY; squelch control in AM and FM) or squelch control (RF gain is fixed at maximum) in set mode as follows. (p. 81)

MODE	SET MODE SETTING		
	AUTO	SQL	RF GAIN + SQL
SSB, CW RTTY	RF GAIN	SQL	RF GAIN + SQL
AM, FM	SQL	SQL	RF GAIN + SQL

• When setting as RF gain/squelch control

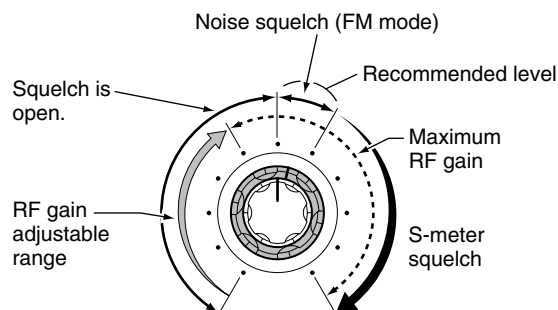

- **When functioning as RF gain control**
(Squelch is fixed open; SSB, CW, RTTY only)

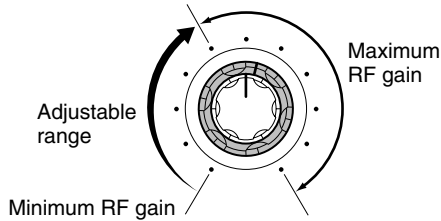

- **When functioning as squelch control**
(RF gain is fixed at maximum.)

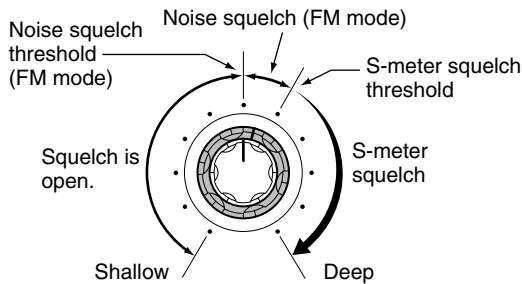

While rotating the RF gain control, noise may be heard. This comes from the DSP unit and does not indicate an equipment malfunction.

- 7 **MIC GAIN CONTROL [MIC GAIN]**
Adjusts microphone input gain.
• The transmit audio tone in SSB, AM and FM modes can be adjusted in tone control set mode. (p. 88)

How to set the microphone gain.
Set the [MIC] control so that the ALC meter sometimes swings during normal voice transmission in SSB mode. Make sure that voice peak readings do not exceed the ALC range brackets on the meter.

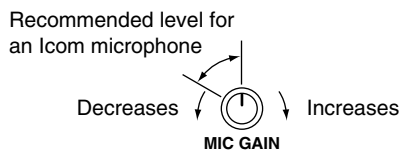

- 8 **AF CONTROL [AF]** (inner control)
Varies the audio output level from the speaker.

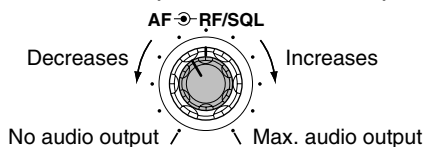

- 9 **RF POWER CONTROL [RF PWR]**
Continuously varies the RF output power from minimum (less than 5 W*) to maximum (100 W*).
* AM mode: less than 5 W to 40 W



- 10 **CW PITCH CONTROL [CW PITCH]** (p. 28)
Shifts the received CW audio pitch and monitored CW audio pitch without changing the operating frequency.
• The pitch can be changed from 300 to 900 Hz in approx. 25 Hz steps.



- 11 **ELECTRONIC CW KEYSER SPEED CONTROL [KEY SPEED]** (p. 28)
Adjusts the internal electronic CW keyer's speed.
• 6 wpm (min.) to 60 wpm (max.) can be set.



- 12 **AUTO NOTCH/MANUAL NOTCH SWITCH [A/NOTCH]** (p. 52)
Toggles the notch function between manual and automatic when pushed.
• "NOTCH" appears when manual; "A NOTCH" appears when automatic notch is selected.

- 13 **NOTCH CONTROL [NOTCH]** (outer control; p. 52)
Adjusts the notch filter frequency to remove an interfering signal.

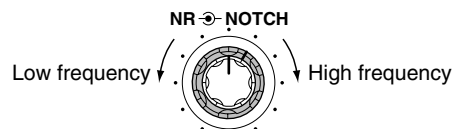

- 14 **ANTENNA SELECTOR SWITCH [ANT]** (p. 74)
Switches the antenna connector selection between ANT1 and ANT2 when pushed.

- 15 **NOISE REDUCTION LEVEL CONTROL [NR]** (inner control; p. 52)
Adjusts the noise reduction level when the noise reduction is in use. Set for maximum readability.

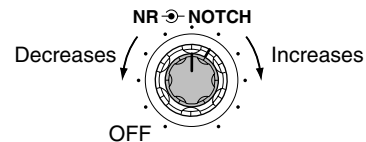

- 16 **ANTENNA TUNER SWITCH [TUNER]** (pgs. 75, 76)
• Turns the antenna tuner ON and OFF (bypass) when pushed momentarily.
• Starts to tune the antenna manually when pushed for 1 sec.
• When the tuner cannot tune the antenna, the tuning circuit is bypassed automatically after 20 sec.

- 17 **NOISE REDUCTION SWITCH [NR]** (p. 52)
Switches the noise reduction ON and OFF.
• "NR" appears while the noise reduction is activated.

■ Front panel (continued)

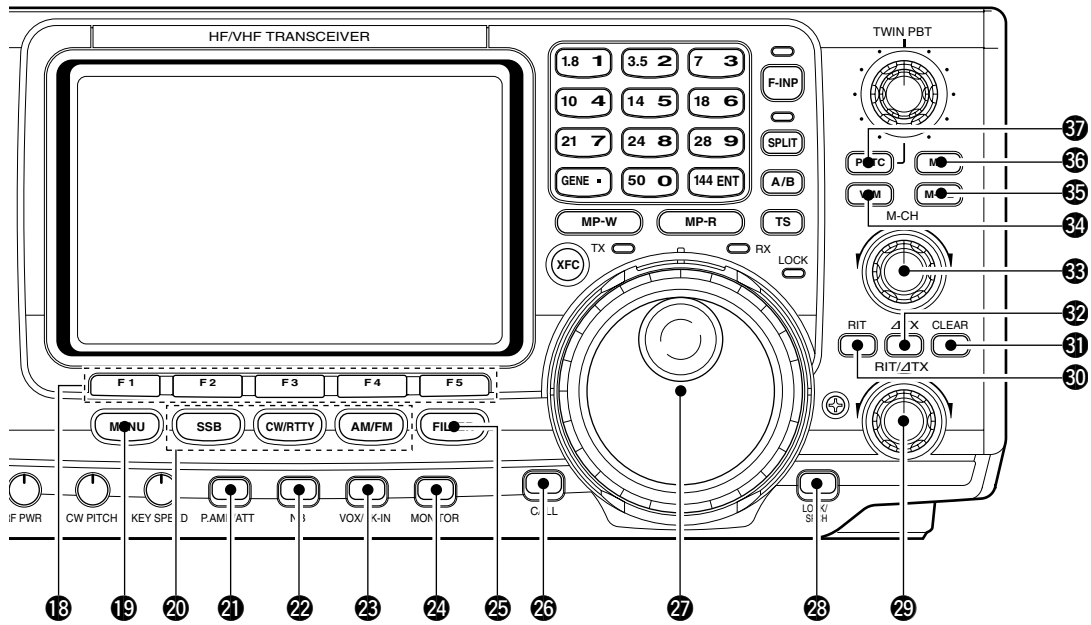

18 MULTI-FUNCTION SWITCHES [F1]–[F5]

- ➔ Push to select the function indicated in the LCD display above these switches. (p. 11)
 - Functions vary depending on the operating mode.
- ➔ Push to input a character for memory keyer programming or memory name. (pgs. 31, 66)

19 MENU SWITCH [MENU]

- ➔ Push to change the set of functions assigned to the multi-function switches.
- Toggles between menu 1 (M1) and menu 2 (M2).

20 MODE SWITCHES

- ➔ Selects the desired mode. (p. 23)
- Announces the selected mode when an optional UT-102 is installed. (p. 89)

- SSB**
 - ➔ Selects USB and LSB mode alternately.
 - ➔ Selects SSB data mode (USB-D, LSB-D) when pushed for 1 sec. in SSB mode.
- CW/RTTY**
 - ➔ Selects CW and RTTY mode alternately.
 - ➔ Switches CW and CW-R (CW reverse) mode when pushed for 1 sec. in CW mode.
 - ➔ Switches RTTY and RTTY-R (RTTY reverse) mode when pushed for 1 sec. in RTTY mode.
- AM/FM**
 - ➔ Selects AM and FM mode alternately.
 - ➔ Selects AM/FM data mode (AM-D, FM-D) when pushed for 1 sec. in AM/FM mode.

21 PREAMP/ATTENUATOR SWITCH [P.AMP/ATT]
(p. 47)

- ➔ Push momentarily to toggle between preamp-1 and preamp-2.
 - “P.AMP¹” activates for HF all bands.
 - “P.AMP²” activates high-gain preamp for 24 MHz band and above.
- ➔ Push for 1 sec. to toggle the attenuator function ON and OFF.

✓ **What is the preamp?**

The preamp amplifies received signals in the front end circuit to improve the S/N ratio and sensitivity. Select “P.AMP¹” or “P.AMP²” when receiving weak signals.

✓ **What is the attenuator?**

The attenuator prevents a desired signal from distorting when very strong signals are near the desired frequency, or when very strong electric fields, such as from a broadcasting station, are near your location.

22 NOISE BLANKER SWITCH [NB] (p. 50)

- ➔ Switches the noise blanker ON and OFF when pushed. The noise blanker reduces pulse-type noise such as that generated by automobile ignition systems. This function cannot be used for FM, or non-pulse-type noise.
 - “NB” appears while the noise blanker is activated.
- ➔ Enters the noise blanker level set mode when pushed for 1 sec.

23 VOX/BREAK-IN SWITCH [VOX/BK-IN]

- ➔ In SSB, AM and FM modes, push momentarily to turn the VOX function ON and OFF (p. 54); push for 1 sec. to enter VOX set mode (p. 54).
- ➔ In CW mode, push momentarily to turn the semi break-in, full break-in or break-in OFF (p. 55); push for 1 sec. to enter break-in set mode (p. 55).

✓ What is the VOX function?

The VOX function (voice operated transmission) starts transmission without pushing the transmit switch or PTT switch when you speak into the microphone; then, automatically returns to receive when you stop speaking.

✓ What is the break-in function?

Full break-in (QSK) activates the receiver between transmitted dots and dashes. This is useful when operating in nets, or during DX pileups and during contests, when "fast exchanges" are common.

24 MONITOR SWITCH [MONITOR] (p. 56)

- ➔ Monitors your transmitted signal.
- ➔ Enters monitor set mode when pushed for 1 sec.

25 FILTER SWITCH [FILTER] (p. 49)

- ➔ Selects one of 3 IF filter settings.
- ➔ Enters the filter set mode when pushed for 1 sec.

26 CALL SWITCH [CALL] (p. 63)

Selects the call channel when pushed momentarily.

27 TUNING DIAL (p. 21)

Changes the displayed frequency, selects set mode items, etc.

28 LOCK/SPEECH SWITCH [LOCK/SPCH]

- ➔ Push momentarily to toggle the dial lock function ON and OFF. (p. 52)
- ➔ Pushing for 1 sec. announces the selected readout frequency and S-meter indication when an optional UT-102 is installed. (p. 89)

29 RIT/ Δ TX CONTROL [RIT/ Δ TX] (pgs. 47, 56)

Shifts the receive and/or transmit frequency without changing the transmit and/or receive frequency while the RIT and/or Δ TX functions are ON.

- Rotate the control clockwise to increase the frequency, or rotate the control counterclockwise to decrease the frequency.
- The shift frequency range is ± 9.99 kHz in 10 Hz steps.

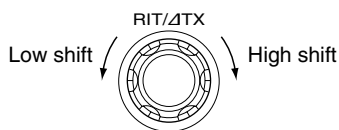
**30 RIT SWITCH [RIT] (p. 47)**

- ➔ Turns the RIT function ON and OFF when pushed.
 - Use the [RIT/ Δ TX] control to vary the RIT frequency.
- ➔ Adds the RIT shift frequency to the operating frequency when pushed for 1 sec.

✓ What is the RIT function?

The RIT (Receiver Incremental Tuning) shifts the receive frequency without shifting the transmit frequency.

This is useful for fine tuning stations calling you on an off-frequency or when you prefer to listen to slightly different-sounding voice characteristics, etc.

31 CLEAR SWITCH [CLEAR] (pgs. 47, 56)

- ➔ Clears the RIT/ Δ TX shift frequency when pushed for 1 sec.
 - Can be cleared instantly when [CLEAR] is pushed if the Quick RIT Clear is set to ON (p. 85).

32 Δ TX SWITCH [Δ TX] (p. 56)

- ➔ Turns the Δ TX function ON and OFF when pushed.
 - Use the [RIT/ Δ TX] control to vary the Δ TX frequency.
- ➔ Adds the Δ TX shift frequency to the operating frequency when pushed for 1 sec.

✓ What is the Δ TX function?

The Δ TX shifts the transmit frequency without shifting the receive frequency. This is useful for simple split frequency operation in CW, etc.

33 MEMORY CHANNEL SELECTOR [M-CH] (p. 61)

- ➔ Select a memory channel.
 - Rotate clockwise to increase the memory channel; rotate counterclockwise to decrease the memory channel.

34 VFO/MEMORY SWITCH [VFO/MEMO]

- ➔ Switches the selected readout operating mode between the VFO mode and memory mode when pushed. (pgs. 20, 61)
- ➔ Transfers the memory contents to VFO when pushed for 1 sec. (p. 64)

35 MEMORY CLEAR SWITCH [M-CL] (p. 62)

- ➔ Clears the selected readout memory channel contents when pushed for 1 sec. in memory mode.
 - The channel becomes a blank channel.
 - This switch does not function in VFO mode.

36 MEMORY WRITE SWITCH [MW] (p. 62)

- ➔ Stores the selected readout frequency and operating mode into the displayed memory channel when pushed for 1 sec.
 - This function is available both in VFO and memory modes.

37 PBT CLEAR SWITCH [PBTC] (p. 51)

- ➔ Clears the PBT settings when pushed for 1 sec.

■ Front panel (continued)

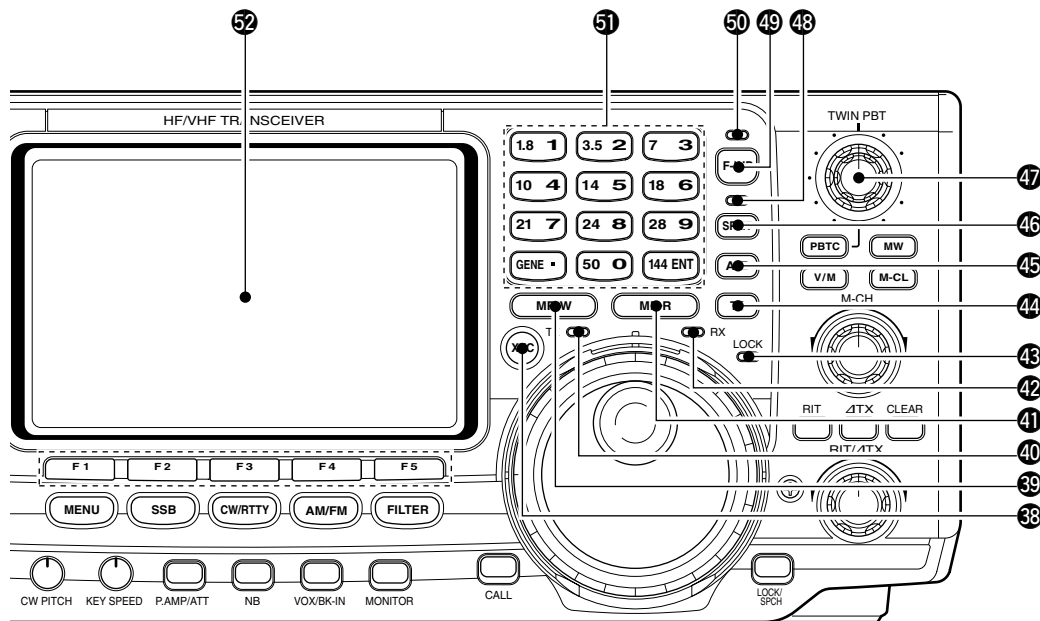

38 TRANSMIT FREQUENCY CHECK SWITCH [XFC] (pgs. 45, 47)
 Monitors the transmit frequency when pushed and held.
 • While pushing this switch, the transmit frequency can be changed with the tuning dial, keypad or memo pad.
 • When the split lock function is turned ON, pushing [XFC] cancels the dial lock function. (p. 59)

39 MEMO PAD-WRITE SWITCH [MP-W] (p. 67)
 Programs the selected readout frequency and operating mode into a memo pad.
 • The 5 most recent entries remain in memo pads.
 • The transmit frequency is programmed when pushed together with [XFC].
 • The memo pad capacity can be expanded from 5 to 10 in set mode for your convenience. (p. 84)

40 TRANSMIT INDICATOR [TX]
 Lights red while transmitting.

41 MEMO PAD-READ SWITCH [MP-R] (p. 67)
 Each push calls up a frequency and operating mode in a memo pad. The 5 (or 10) most recently programmed frequencies and operating modes can be recalled, starting from the most recent.
 • The memo pad capacity can be expanded from 5 to 10 in set mode for your convenience. (p. 84)

42 RECEIVE INDICATOR [RX]
 Lights green while receiving a signal and when the squelch is open.

43 LOCK INDICATOR [LOCK] (p. 52)
 Lights when the dial lock function is activated.

44 QUICK TUNING SWITCH [TS] (p. 21)
 ➔ Turns the quick tuning step ON and OFF.
 • While the quick tuning indicator is displayed, the frequency can be changed in programmed kHz steps.
 • 0.1, 1, 5, 9, 10, 12.5, 20 and 25 kHz quick tuning steps are available.

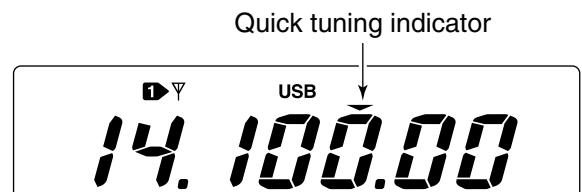

➔ While the quick tuning step is OFF, turns the 1 Hz step ON and OFF when pushed for 1 sec.
 • 1 Hz indication appears, and the frequency can be changed in 1 Hz steps.
 ➔ While the quick tuning step is ON, enters the quick tuning step set mode when pushed for 1 sec.

45 VFO SELECT SWITCH [A/B] (p. 20)
 ➔ Push to toggle between VFO A and VFO B.
 ➔ Push for 1 sec. to equalize the frequency and operating mode of the two VFO's.

46 SPLIT SWITCH [SPLIT]

- Turns the split function ON and OFF when pushed. (p. 58)
- Turns the quick split function ON, when pushed for 1 sec. (p. 59)
 - The offset frequency is shifted from the displayed frequency.
 - The quick split function can be turned OFF using set mode. (p. 82)
- Turns the split function ON and sets the transmit frequency after inputting an offset frequency with the keypad (± 4 MHz in 1 kHz steps; p. 58).

47 PASSBAND TUNING CONTROLS [TWIN PBT]

- Adjust the receiver's "passband width" of the DSP filter. (p. 51)
- Passband width and shift frequency are displayed in the multi-function switch indicator.
 - Push [PBTC] for 1 sec. to clear the settings when not in use.
 - Variable range is set to half of the IF filter passband width. 25 Hz steps and 50 Hz steps are available.
 - These controls function as an IF shift control while in AM mode and when the RTTY filter is turned ON. Only the inner control may function in this case.

✓ What is the PBT control?

General PBT function electronically narrows the IF passband width to reject interference. This transceiver uses the DSP circuit for the PBT function.

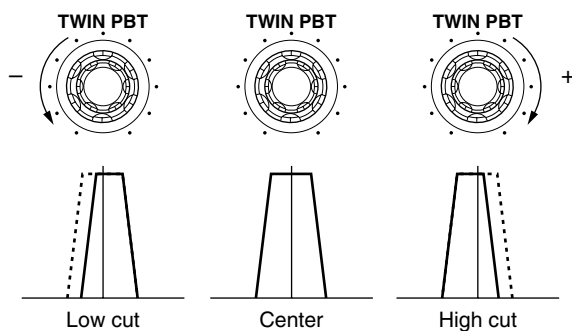
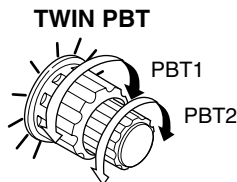

48 SPLIT INDICATOR (p. 58)

Lights during split operation.

49 FREQUENCY INPUT SWITCH [F-INP] (p. 22)

- Push to toggle keypad input between frequency and band.
- The frequency input indicator lights when frequency input is selected for the keypad.

50 FREQUENCY INPUT INDICATOR (p. 22)

Lights when frequency input from the keypad is enabled.

51 KEYPAD

- Pushing a key selects the operating band.
 - [GENE •] selects the general coverage band.
- Pushing the same key 2 or 3 times calls up other stacked frequencies and modes in the band. (p. 19)
 - Icom's triple band stacking register memorizes 3 frequencies in each band.
- After pushing [F-INP], enter a keyed frequency. Pushing [144 ENT] is necessary at the end. (p. 22)
 - e.g. to enter 14.195 MHz, push [F-INP] [1.8 1] [10 4] [GENE •] [1.8 1] [28 9] [14 5] [144 ENT].

52 LCD FUNCTION DISPLAY

(See pgs. 9, 10 for details.)

Shows the operating frequency, function switch menus, band scope screen, memory name screen, set mode settings, etc.

■ Rear panel

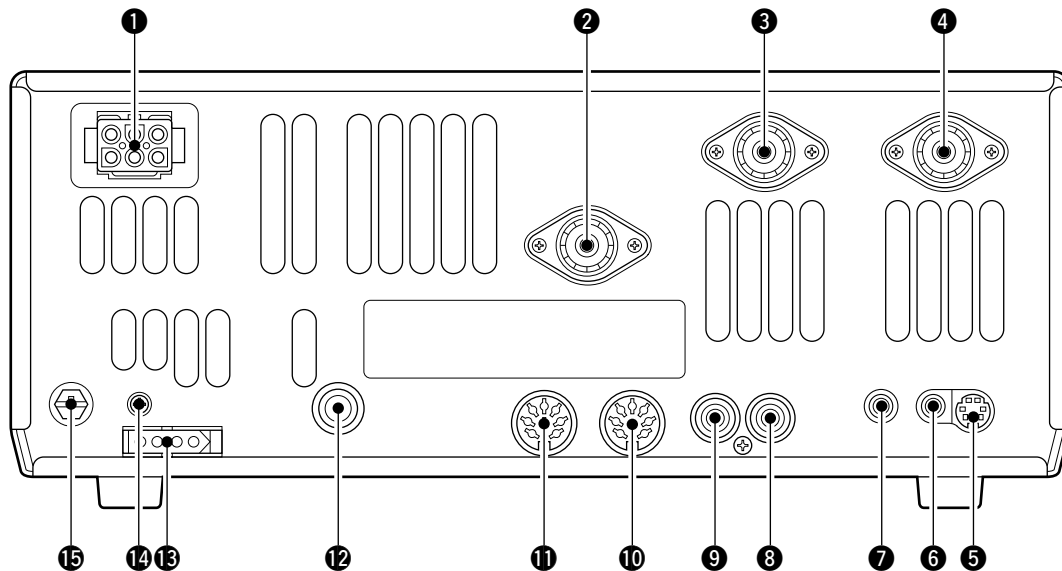

- 1 DC POWER SOCKET [DC 13.8V]** (pgs. 14, 16)
Accepts 13.8 V DC through the supplied DC power cable (OPC-025D).

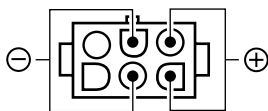

Rear panel view

- 2 ANTENNA CONNECTOR [ANT 144MHz]**
3 ANTENNA CONNECTOR 2 [ANT2]
4 ANTENNA CONNECTOR 1 [ANT1]
 (pgs. 14, 15, 17, 75)
 Accepts a 50 Ω antenna with a PL-259 connector.
 •[ANT 144MHz] for 144 MHz (2 m) band only; [ANT1] and [ANT2] for both HF and 50 MHz (6 m) bands antennas.
 // When using an optional AH-4 HF/50 MHz AUTOMATIC ANTENNA TUNER, connect it to the [ANT1] connector. The internal antenna tuner activates for [ANT2] and deactivates for [ANT1] when connecting the AH-4.

- 5 DATA SOCKET [DATA]** (pgs. 15, 78)
Connects a TNC (Terminal Node Controller), etc. for data communications.
•See p. 8 for connector information.
- 6 EXTERNAL SPEAKER JACK [EXT SP]** (pgs. 15, 101)
Accepts a 4–8 Ω speaker.
- 7 CI-V REMOTE CONTROL JACK [REMOTE]** (p. 95)
 ➔ Designed for use with a personal computer for remote control of the transceiver functions.
 ➔ Used for transceive operation with another Icom CI-V transceiver or receiver.

- 8 SEND CONTROL JACK [SEND]** (p. 17)
Goes to ground while transmitting to control external equipment such as a linear amplifier.
•Max. control level: 16 V DC/0.5 A
CAUTION: Be sure the linear amplifiers keying circuit control voltage is compatible to the IC-746PRO,

before connecting to [SEND].

- 9 ALC INPUT JACK [ALC]** (p. 17)
Connects to the ALC output jack of a non-Icom linear amplifier.
- 10 ACCESSORY SOCKET 2 [ACC(2)]**
11 ACCESSORY SOCKET 1 [ACC(1)]
 Enables connection of external equipment such as a linear amplifier, an automatic antenna selector/tuner, TNC for data communications, etc.
 •See p. 8 for socket information.
- 12 STRAIGHT KEY JACK [KEY]** (p. 14)
Accepts a straight key or external electronic keyer with 1/4 inch standard plug.
 •[ELEC-KEY] on the front panel can be used for a straight key or external electronic keyer. Deactivate the internal electronic keyer in keyer set mode. (p. 34)

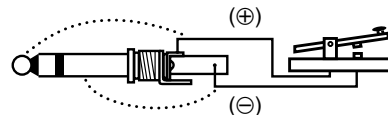

- 13 TUNER CONTROL SOCKET [TUNER]**
 (pgs. 15, 77)
 Accepts the control cable from an optional AH-4 HF/50 MHz AUTOMATIC ANTENNA TUNER.
 // If you use an external electronic keyer, make sure the voltage retained by the keyer is less than 0.4 V when the key is ON.
- 14 CALIBRATION POT [CAL]** (p. 94)
This is used for frequency calibration.
 •The transceiver has been adjusted and calibrated thoroughly at the factory. Under normal circumstances, the frequency does not need to be re-calibrated.

- 15 GROUND TERMINAL [GND]** (pgs. 13, 14)
Connect this terminal to a ground to prevent electrical shocks, TVI, BCI and other problems.

◇ DATA SOCKET

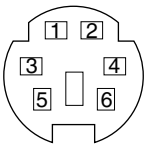
DATA	PIN No.	NAME	DESCRIPTION
 <p>Rear panel view</p>	1	DATA IN	Input terminal for data transmit. (1200 bps: AFSK/9600 bps: G3RUH, GMSK)
	2	GND	Common ground for DATA IN, DATA OUT and AF OUT.
	3	PTT P	PTT terminal for packet operation. Connect ground to transmit data.
	4	DATA OUT	Data out terminal for 9600 bps operation only.
	5	AF OUT	Data out terminal for 1200 bps operation only.
	6	P SQL	Squelch out terminal. Becomes high (+8 V) when the transceiver receives a signal which opens the squelch. •To avoid unnecessary TNC transmission, connect squelch to the TNC to inhibit transmission when receiving signals. •Keep audio output at a normal level, otherwise a “P SQL” signal will not be output.

◇ ACC SOCKETS

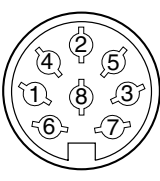
ACC (1)	PIN No.	NAME	DESCRIPTION	SPECIFICATIONS
 <p>Rear panel view</p>	1	RTTY	Controls RTTY keying	“High” level : More than 2.4 V “Low” level : Less than 0.6 V Output current : Less than 2 mA
	2	GND	Connects to ground.	Connected in parallel with ACC(2) pin 2.
	3	HSEND	Input/output pin. (HF/50 MHz only) Goes to ground when transmitting. When grounded, transmits.	Ground level : -0.5 V to 0.8 V Output current : Less than 20 mA Input current (Tx) : Less than 200 mA Connected in parallel with ACC(2) pin 3.
	4	MOD	Modulator input. Connects to a modulator.	Input impedance : 10 kΩ Input level : Approx. 100 mV rms
	5	AF	AF detector output. Fixed, regardless of [AF] position in default settings. (see notes below)	Output impedance : 4.7 kΩ Output level : 100–300 mV rms
	6	SQLS	Squelch output. Goes to ground when squelch opens.	SQL open : Less than 0.3 V/5 mA SQL closed : More than 6.0 V/100 μA
	7	13.8 V	13.8 V output when power is ON.	Output current : Max. 1 A Connected in parallel with ACC(2) pin 7.
	8	ALC	ALC voltage input.	Control voltage : -4 V to 0 V Input impedance : More than 10 kΩ Connected in parallel with ACC(2) pin 5.

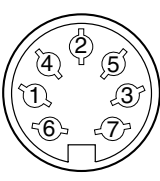
ACC (2)	PIN No.	NAME	DESCRIPTION	SPECIFICATIONS
 <p>Rear panel view</p>	1	8 V	Regulated 8 V output.	Output voltage : 8 V ±0.3 V Output current : Less than 10 mA
	2	GND	Same as ACC(1) pin 2.	
	3	HSEND	Same as ACC(1) pin 3.	
	4	BAND	Band voltage output. (Varies with amateur band)	Output voltage : 0 to 8.0 V
	5	ALC	Same as ACC (1) pin 8.	
	6	VSEND	Input/output pin (144 MHz only) Goes to ground when transmitting. When grounded, transmits.	Ground level : -0.5 V to +0.8 V Output current : Less than 20 mA Input current (Tx) : Less than 200 mA
	7	13.8 V	Same as ACC(1) pin 7.	

■ LCD display

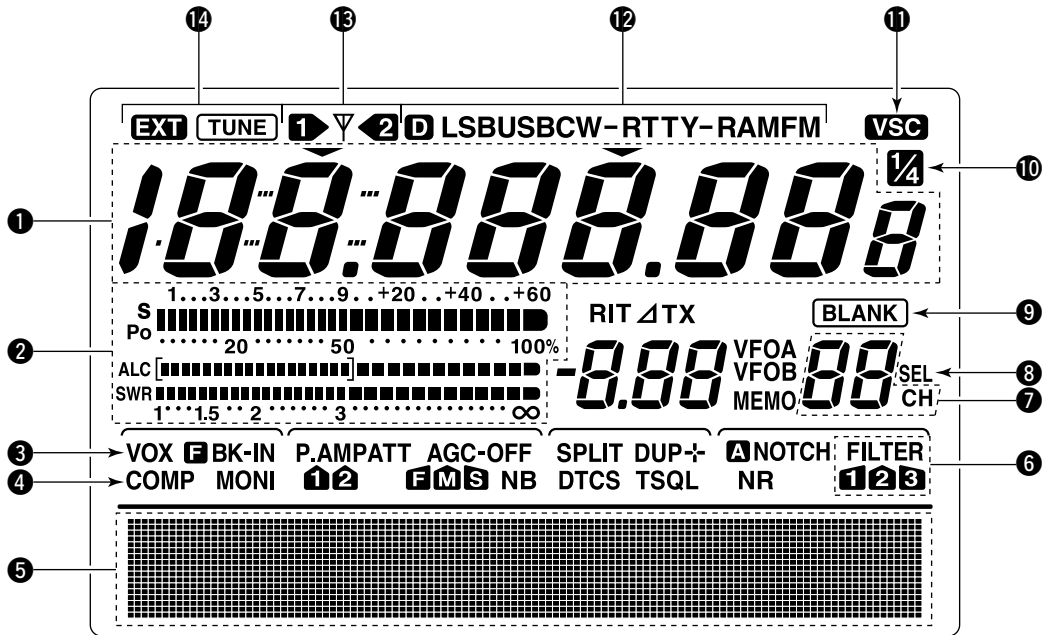

- 1 FREQUENCY READOUTS**
Shows the operating frequency.
- 2 MULTI-FUNCTION METER INDICATION**
 - ➔ Shows receiving signal strength, etc. during receive.
 - ➔ Shows transmit output power, ALC and SWR during transmit.
- 3 VOX INDICATOR** (p. 54)
Appears when the VOX function is activated.
- 4 MICROPHONE COMPRESSOR INDICATOR** (p. 57)
Appears when the microphone compressor is activated.
- 5 MULTI-FUNCTION SWITCH INDICATOR** (p. 11)
Indicates the functions assigned to the multi-function switches ([F1]–[F5]).
- 6 DSP FILTER INDICATOR** (p. 49)
Shows the selected IF filter.
- 7 MEMORY CHANNEL READOUTS** (p. 61)
Shows the selected memory channel.
- 8 SELECT MEMORY CHANNEL INDICATOR** (p. 71)
Appears when the selected memory channel is set as a select memory channel.
- 9 BLANK MEMORY INDICATOR** (p. 61)
Appears when the selected memory channel is blank.
- 10 1/4 TUNING DIAL SPEED INDICATOR** (p. 21)
Appears when the tuning dial speed is set so that one rotation is equal to 1/4 of the normal rotation.
- 11 VOICE SQUELCH CONTROL INDICATOR** (p. 53)
Appears during VSC (Voice Squelch Control) function is activated.
- 12 MODE INDICATORS** (p. 23)
Shows the selected operating mode.
 - “D” appears when SSB data, AM data or FM data mode is selected.
- 13 ANTENNA INDICATOR** (p. 74)
Indicates which antenna connector is used for HF/50 MHz.
- 14 ANTENNA TUNER INDICATORS** (pgs. 75, 76)
 - ➔ “TUNE” appears when the antenna tuner is ON; “TUNE” appears and flashes during tuning.
 - ➔ “EXT” appears when the optional AH-4 external antenna tuner is connected to [ANT1].

■ LCD display (continued)

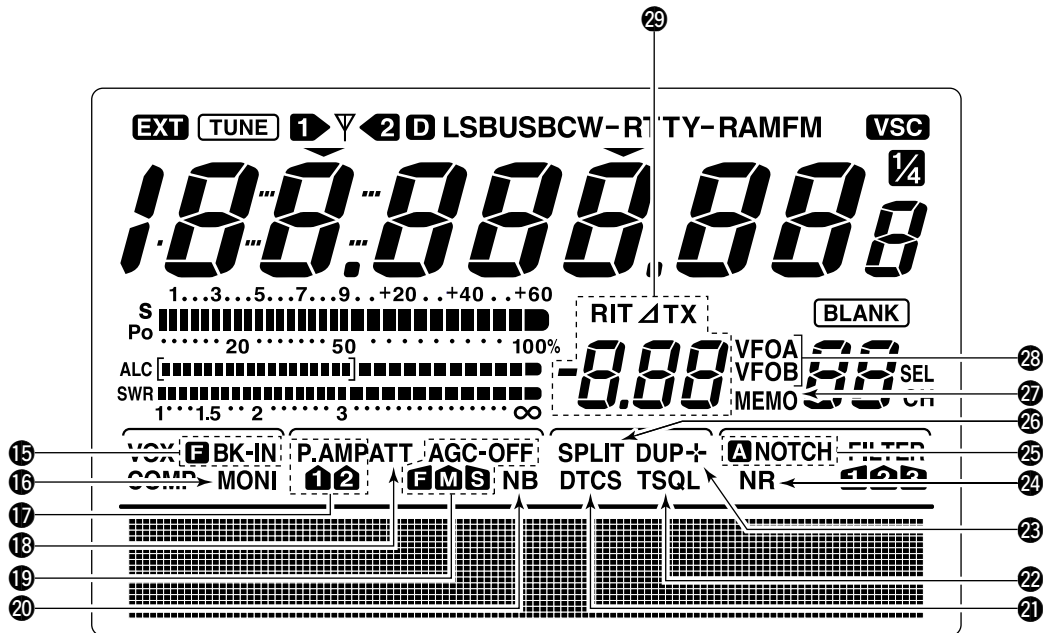

- 15 BREAK-IN INDICATORS** (p. 55)
 - ➔ “F BK-IN” appears when the full break-in function is activated.
 - ➔ “BK-IN” appears when the semi break-in function is activated.
- 16 MONITOR INDICATOR** (p. 56)
 - Appears when the monitor function is activated.
- 17 PREAMP INDICATORS** (p. 47)
 - Appears when the preamp is activated.
- 18 ATTENUATOR INDICATOR** (p. 47)
 - Appears when the attenuator is activated.
- 19 AGC INDICATORS** (p. 48)
 - Shows the selected AGC time constant.
 - “F” for AGC fast; “M” for AGC middle; “S” for AGC slow; “-OFF” for AGC OFF.
- 20 NOISE BLANKER INDICATOR** (p. 50)
 - Appears when the noise blanker is activated.
- 21 DTCS INDICATOR** (p. 43)
 - Appears during DTCS operation.
- 22 TONE SQUELCH INDICATORS**
 - ➔ “T” appears when the repeater tone is activated. (p. 44)
 - ➔ “TSQL” appears during tone squelch operation. (p. 42)
- 23 DUPLEX INDICATOR** (p. 44)
 - “DUP-” or “DUP+” appears during repeater operation.
- 24 NOISE REDUCTION INDICATOR** (p. 52)
 - Appears when the noise reduction is activated.
- 25 NOTCH INDICATORS** (p. 52)
 - ➔ “NOTCH” appears when the manual notch function is activated.
 - ➔ “A NOTCH” appears when the automatic notch function is activated.
- 26 SPLIT INDICATOR** (pgs. 58, 59)
 - Appears during split operation.
- 27 MEMORY INDICATOR** (p. 61)
 - Appears during memory mode.
- 28 VFO INDICATORS** (p. 20)
 - Indicates whether VFO A or VFO B is selected.
- 29 RIT/ΔTX INDICATORS** (pgs. 47, 56)
 - Appears during RIT or ΔTX operation and indicates the frequency offset.

Multi function switches

◇ M1 FUNCTIONS

During SSB operation

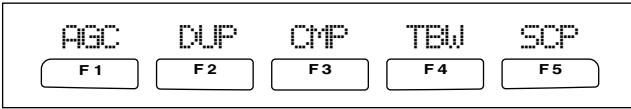

During SSB data operation

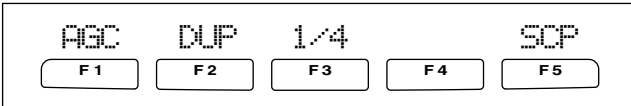

During CW operation

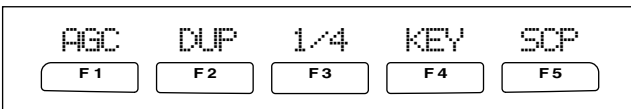

During RTTY operation

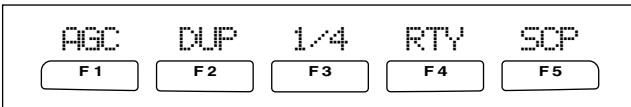

During AM operation

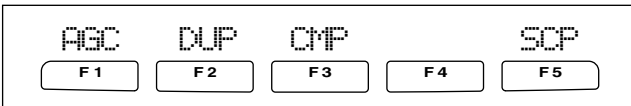

During FM operation

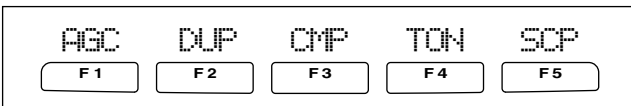

AGC (p. 48)

- AGC** (F1) ➔ Push momentarily to change the time constant of the AGC circuit.
 ➔ Push for 1 sec. to enter to the AGC set mode.

DUPLEX (p. 44)

- DUP** (F2) ➔ Push momentarily to select the duplex direction or turn the function OFF.
 •“DUP-” or “DUP+” indicator appears during duplex operation.
 ➔ Push for 1 sec. to turn the one-touch repeater function ON/OFF.

SPEECH COMPRESSOR (p. 57)

- COMP** (F3) ➔ Push momentarily to turn the speech compressor function ON/OFF.
 •“COMP” indicator appears when the speech compressor is ON.
 ➔ Push for 1 sec. to enter to the compressor set mode.

1/4 TUNING FUNCTION (p. 21)

- 1/4** (F3) Push to turn the 1/4 tuning function ON/OFF.
 •“” indicator appears when the 1/4 tuning function is ON.

TRANSMISSION BANDWIDTH (p. 57)

- TBW** (F4) Push to select the transmission bandwidth.
 •Bandwidth is selectable from narrow, middle and wide.

MEMORY KEYS MENU (p. 29)

- KEY** (F4) Push to select the memory keyer or keyer send menu, depending on the **KEYER 1st Menu** setting in the set mode (p. 86).

RTTY MENU (p. 36)

- RTY** (F4) Push to select the RTTY menu.

BAND SCOPE FUNCTION (p. 46)

- SCP** (F5) Push to select the band scope screen.

◇ M2 FUNCTIONS



SCAN MENU (p. 69)

- SON** (F1) Push to select the scan menu.

MEMORY NAME MENU (p. 66)

- MEM** (F2) Push to select the memory name screen.

SWR GRAPH FUNCTION (p. 60)

- SWR** (F3) Push to indicate the SWR graph screen.

TONE CONTROL SET MODE (p. 88)

- TON** (F4) Push to enter the audio tone set mode.

VSC FUNCTION (p. 53)

- VSC** (F5) Push to turn the VSC (Voice Squelch Control) function ON and OFF.

■ Microphone (HM-36)

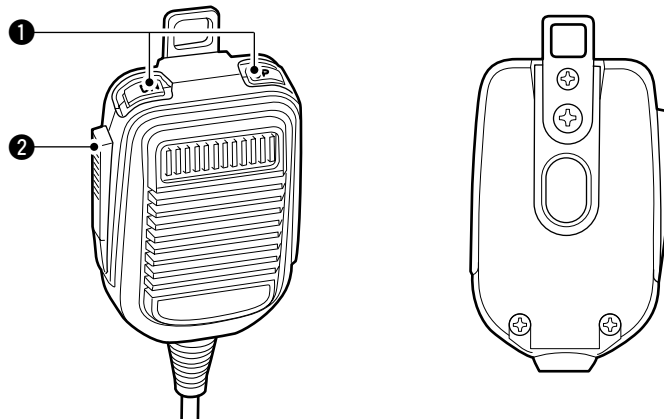

❶ UP/DOWN SWITCHES [UP]/[DN]

Change the selected readout frequency or memory channel.

- Continuous pushing changes the frequency or memory channel number continuously.
- While pushing [XFC], the transmit readout frequency can be controlled while in split frequency operation.
- The [UP]/[DN] switch can simulate a key paddle. Preset in the keyer set mode. (p. 34)

❷ PTT SWITCH

Push and hold to transmit; release to receive.

•MICROPHONE CONNECTOR

(Front panel view)

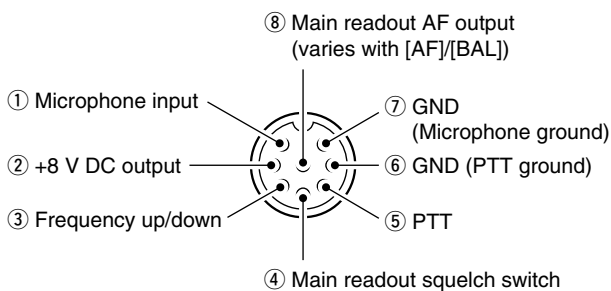

[MIC] Pin No.	FUNCTION	DESCRIPTION
❷	+8 V DC output	Max. 10 mA
❸	Frequency up	Ground
	Frequency down	Ground through 470 Ω
❹	Squelch open	“Low” level
	Squelch closed	“High” level

CAUTION: DO NOT short pin 2 to ground as this can damage the internal 8 V regulator.

NOTE: DC voltage is applied to pin 1 for microphone operation. Take care when using a non-Icom microphone.

•HM-36 SCHEMATIC DIAGRAM

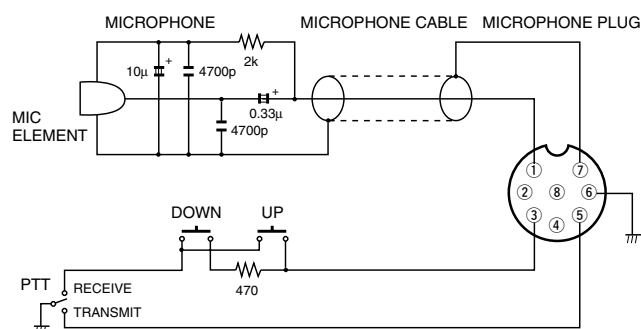

■ Unpacking

After unpacking, immediately report any damage to the delivering carrier or dealer. Keep the shipping cartons.

For a description and a diagram of accessory equipment included with the IC-7400, see 'Supplied accessories' on p. ii of this manual.

■ Selecting a location

Select a location for the transceiver that allows adequate air circulation, free from extreme heat, cold, or vibrations, and away from TV sets, TV antenna elements, radios and other electromagnetic sources.

The base of the transceiver has an adjustable stand for desktop use. Set the stand to one of two angles depending on your operating conditions.

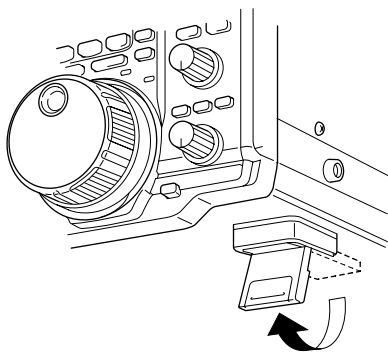

■ Grounding

To prevent electrical shock, television interference (TVI), broadcast interference (BCI) and other problems, ground the transceiver through the GROUND terminal on the rear panel.

For best results, connect a heavy gauge wire or strap to a long earth-sunk copper rod. Make the distance between the [GND] terminal and ground as short as possible.

WARNING: NEVER connect the [GND] terminal to a gas or electric pipe, since the connection could cause an explosion or electric shock.

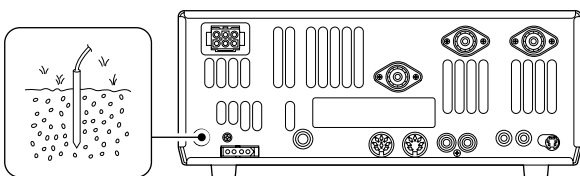

■ Antenna connection

For radio communications, the antenna is of critical importance, along with output power and sensitivity. Select antenna(s), such as a well-matched 50 Ω antenna, and feedline. 1.5:1 or better of Voltage Standing Wave Ratio (VSWR) is recommended for your desired band. Of course, the transmission line should be a coaxial cable.

When using 1 antenna, use the [ANT1] connector.

CAUTION: Protect your transceiver from lightning by using a lightning arrester.

PL-259 CONNECTOR INSTALLATION EXAMPLE

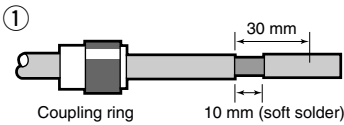
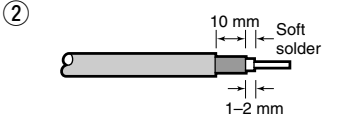
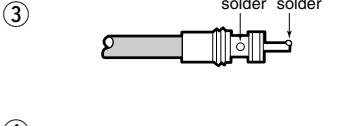
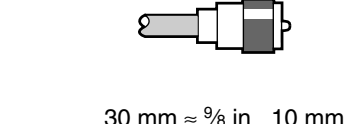
- ①  Slide the coupling ring down. Strip the cable jacket and soft solder.
 - ②  Strip the cable as shown at left. Soft solder the center conductor.
 - ③  Slide the connector body on and solder it.
 - ④  Screw the coupling ring onto the connector body.
- 30 mm ≈ 1 1/8 in 10 mm ≈ 3/8 in 1-2 mm ≈ 1/16 in

Antenna SWR

Each antenna is tuned for a specified frequency range and SWR may be increased out-of-range. When the SWR is higher than approx. 2.0:1, the transceiver's power drops to protect the final transistor. In this case, an antenna tuner is useful to match the transceiver and antenna. Low SWR allows full power for transmitting even when using the antenna tuner. The IC-7400 has an SWR meter to monitor the antenna SWR continuously.

Required connections

Front panel

CW KEY

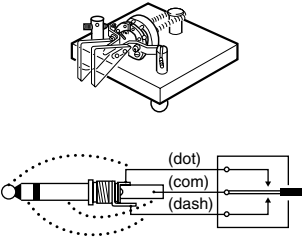

A straight key can be used when the internal electronic keyer is turned OFF in keyer set mode. (p. 34)

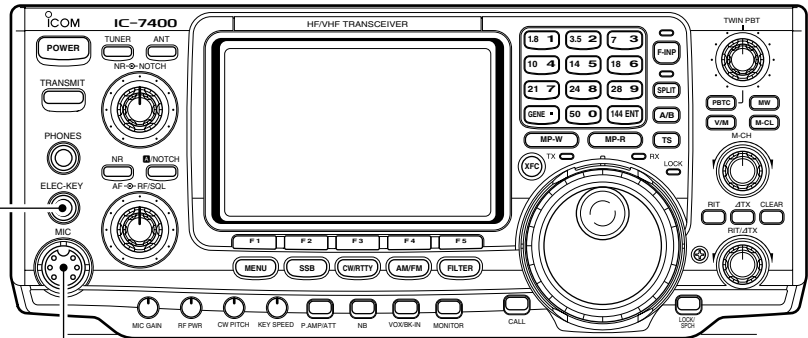

MICROPHONES (p. 100)

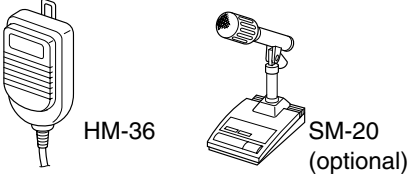

HM-36
SM-20 (optional)

Rear panel

144 MHz ANTENNA (pgs. 13, 74)

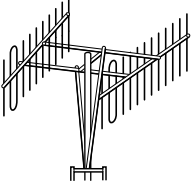

Connect a VHF (60–144 MHz) antenna; impedance: 50 Ω.

ANTENNA 1, 2 (pgs. 13, 74)
[Example]: ANT1 for 1.8–18 MHz bands
ANT2 for 21–50 MHz bands

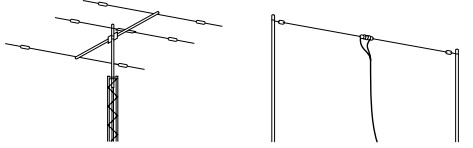

DC POWER SUPPLY

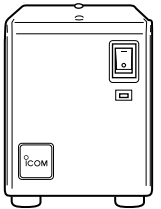

PS-125 (Optional)

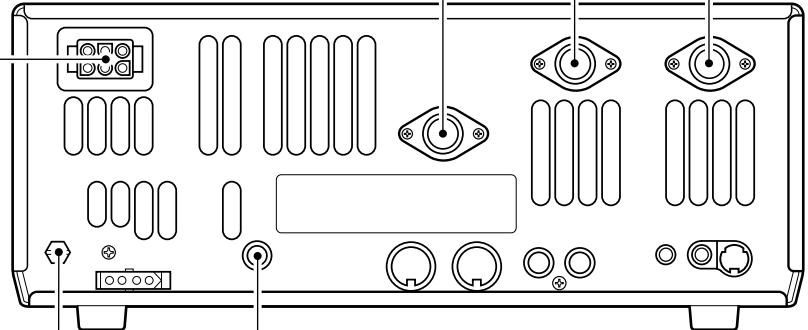

GROUND (p. 13)

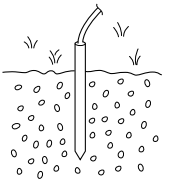

Use the heaviest gauge wire or strap available and make the connection as short as possible.

Grounding prevents electrical shocks, TVI and other problems.

STRAIGHT KEY

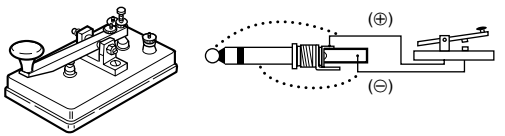

■ Advanced connections

• Front panel

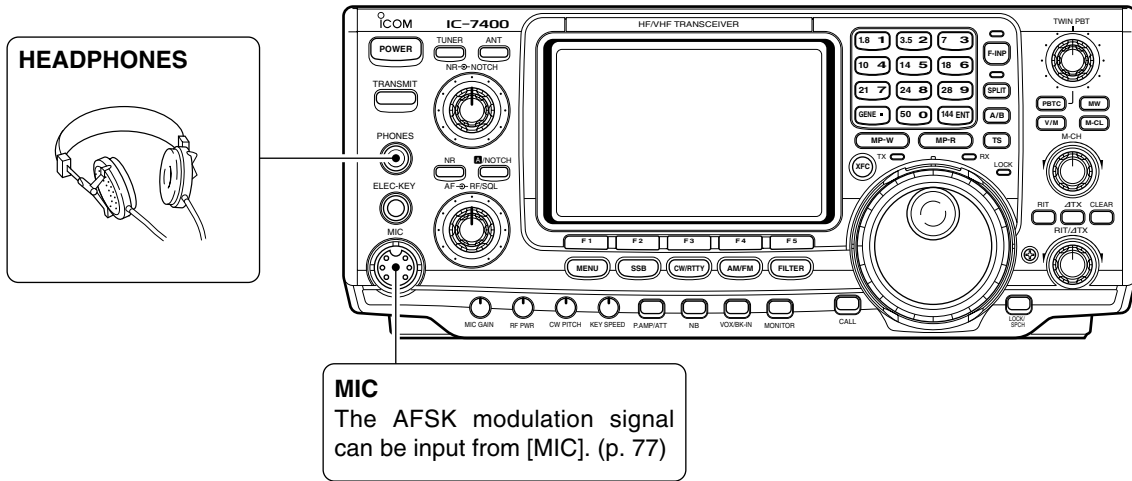

• Rear panel

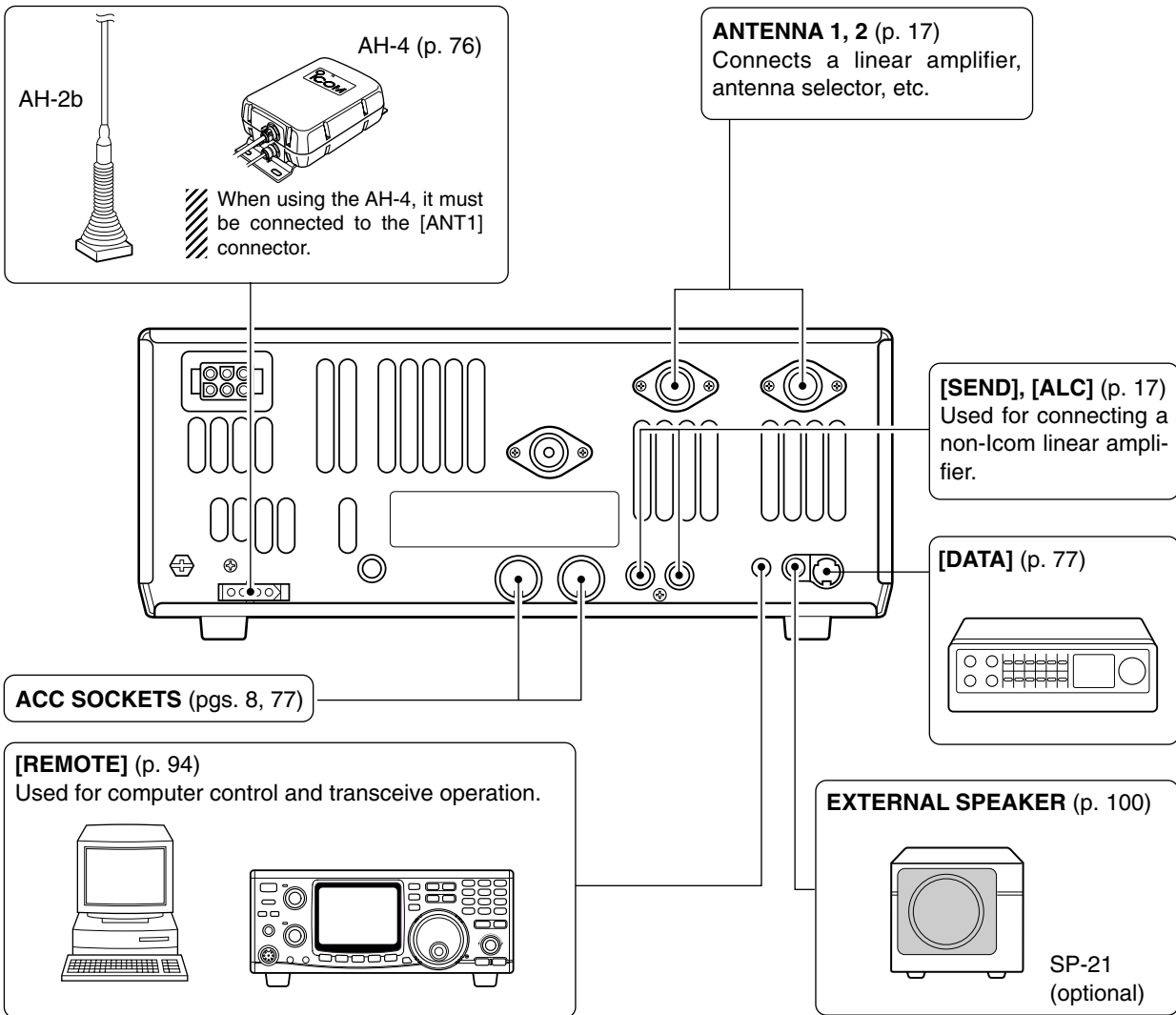

Power supply connections

Use an optional DC power supply with a 25 A capacity and above when operating the transceiver with AC power. Refer to the diagrams below.

CAUTION: Before connecting the DC power cable, check the following important items. Make sure:

- The [POWER] switch is OFF.
- Output voltage of the power source is 12–15 V when you use a non-Icom power supply.
- DC power cable polarity is correct.
 - Red : positive ⊕ terminal
 - Black : negative ⊖ terminal

CONNECTING PS-125 DC POWER SUPPLY

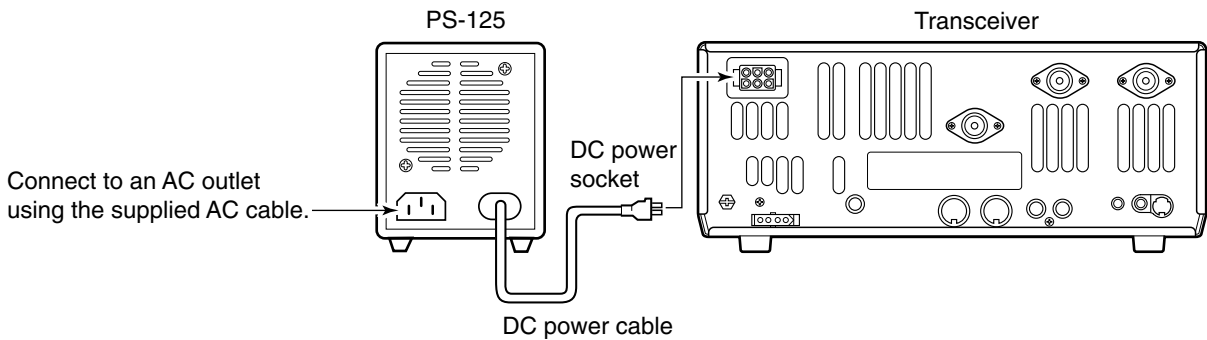

CONNECTING A DC POWER SUPPLY

• Connecting with OPC-025D

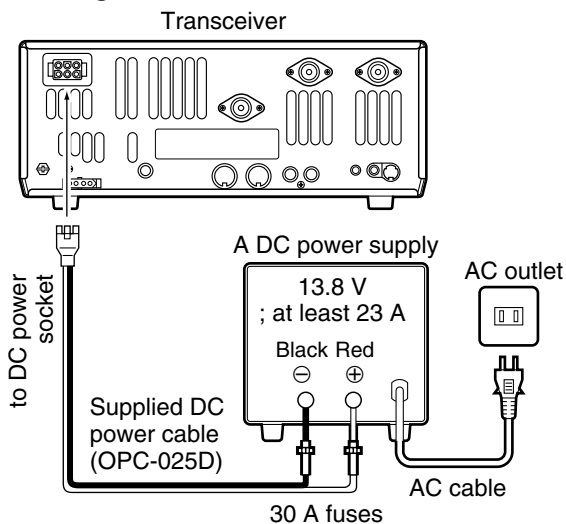

• Connecting with OPC-639

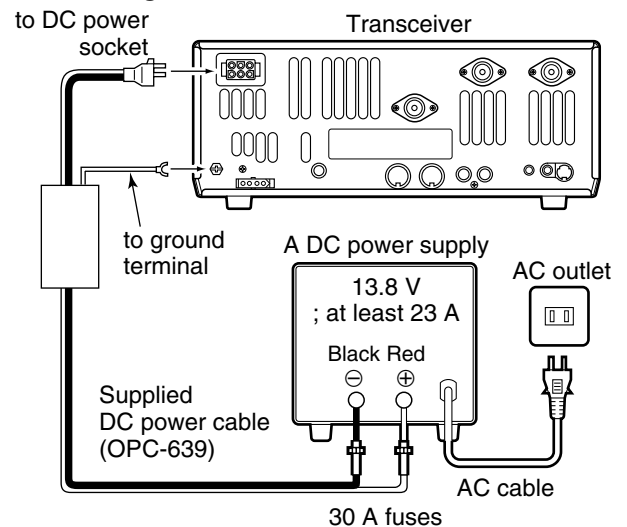

CONNECTING A VEHICLE BATTERY

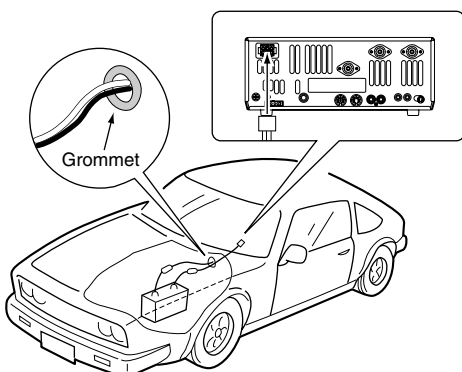

NEVER connect to a 24 V battery.

NOTE: Use terminals for the cable connections.

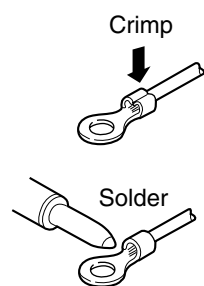
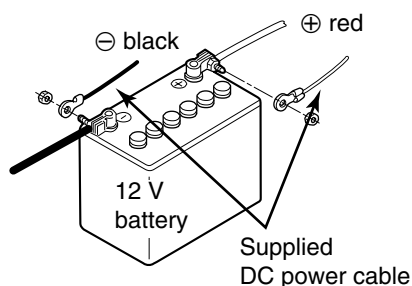

NEVER connect to a battery without supplied DC fuses, otherwise a fire hazard may occur.

Linear amplifier connections (not usable in European countries)

CONNECTING THE IC-PW1

Use the [ANT1] connector when connecting a linear amplifier.

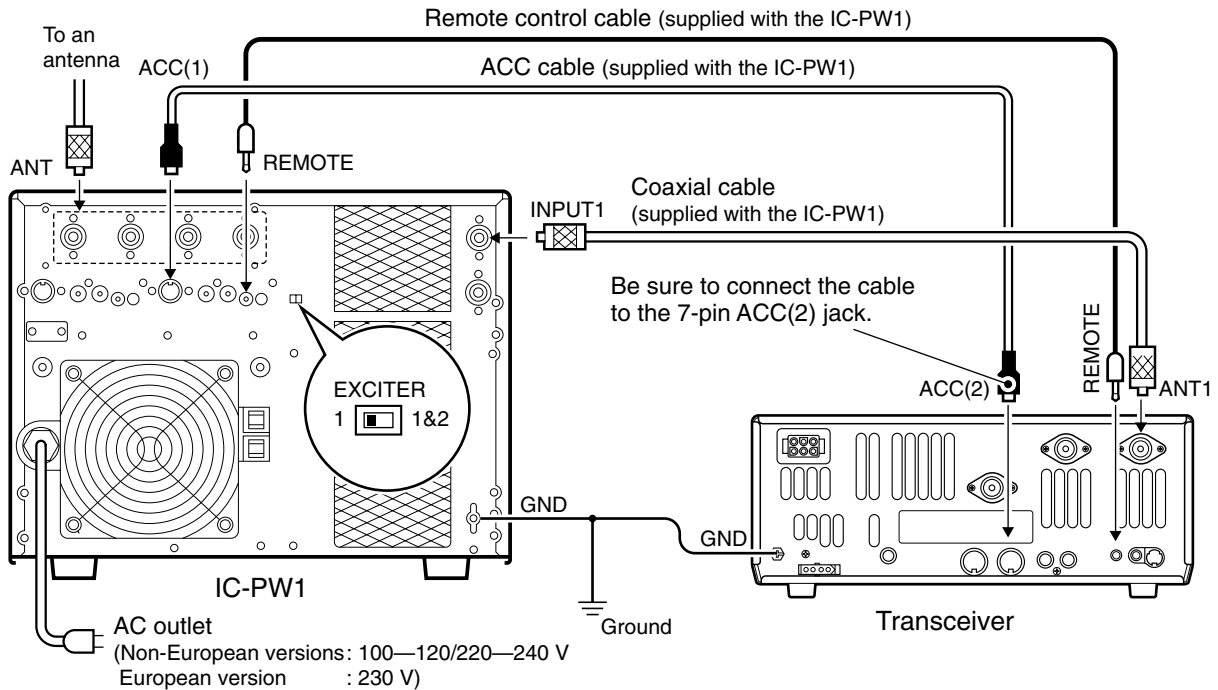

Turn OFF the transceiver's antenna tuner while tuning the IC-PW1's tuner.

CONNECTING A NON-ICOM LINEAR AMPLIFIER

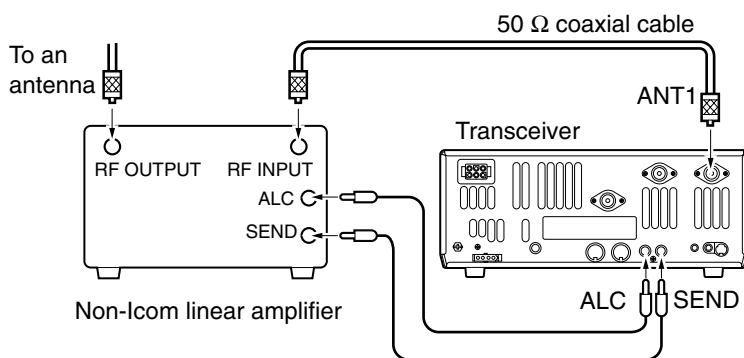

WARNING:

Set the transceiver output power and linear amplifier ALC output level referring to the linear amplifier instruction manual. Be sure the linear amplifier keying circuit control voltage is compatible with the IC-746PRO, before connecting to [SEND] jack.

The ALC input level must be in the range 0 V to -4 V, and the transceiver does not accept positive voltage. Non-matched ALC and RF power settings could cause a fire or ruin the linear amplifier.

The specifications for the SEND relay are 16 V/DC 0.5 A. If this level is exceeded, a large external relay must be used.

External antenna tuner connection

CONNECTING THE AH-4

The AH-4 must be connected to [ANT1].

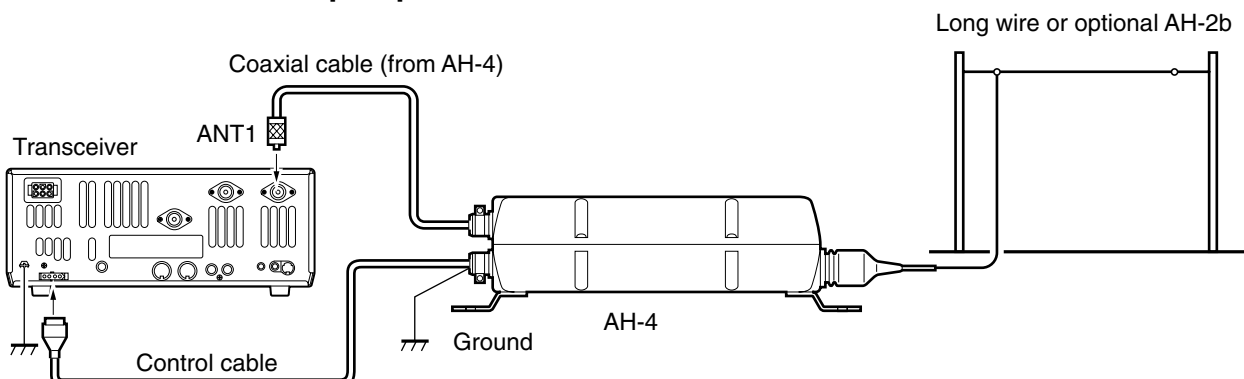

■ When first applying power (CPU resetting)

Before first applying power, make sure all connections required for your system are complete by referring to Chapter 2. Then, reset the transceiver using the following procedure.

/// **NOTE:** When first applying power or when operating in cold environments, the display may flicker or appear faint. This is normal and will disappear once the transceiver has warmed up.

- ① Make sure the transceiver power is OFF.
- ② While pushing [M-CL] and [F-INP], push [POWER] for 1 sec. to turn power ON.
 - The internal CPU is reset.
 - The transceiver displays its initial VFO frequency when resetting is complete.
- ③ Correct the set mode settings after resetting, if desired.

/// Resetting **CLEARs** all programmed contents in memory channels and returns programmed values in set mode to default values.

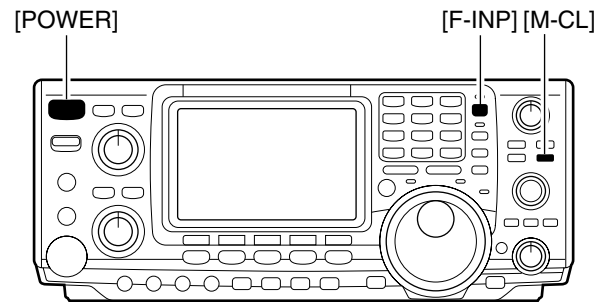

■ Initial settings

After resetting the transceiver, set controls and switches as shown in the figure below.

CW : Clockwise
CCW : Counterclockwise

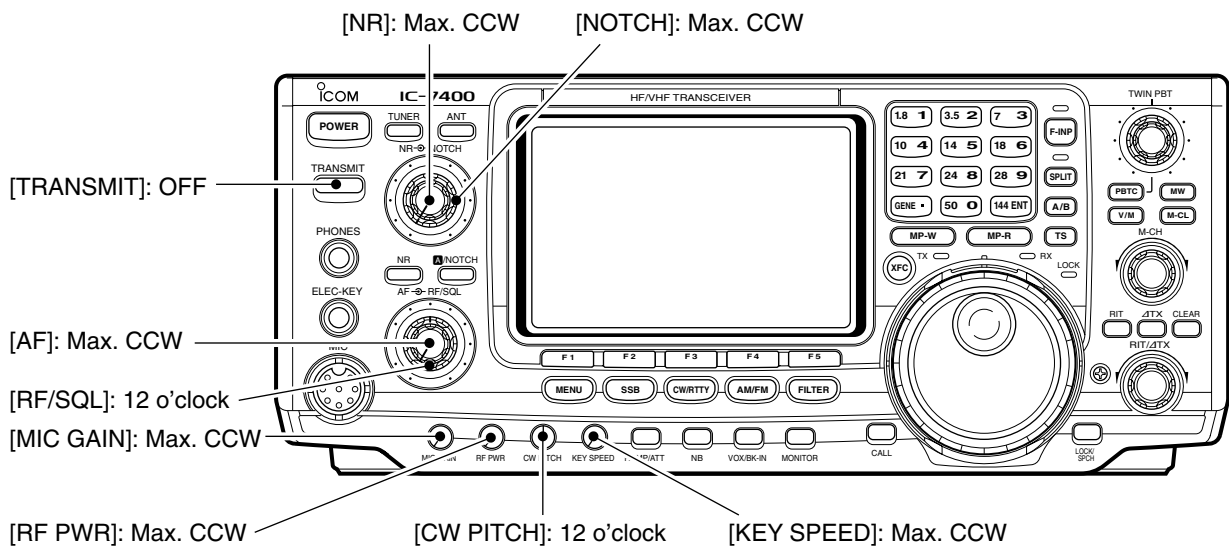

■ Selecting an operating band

The transceiver has a triple band stacking register. This means that the last 3 operating frequencies and modes used on a particular band are automatically memorized.

See the table below for a list of the bands available and the default settings for each register.

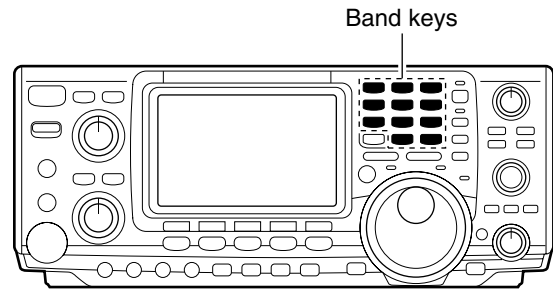

BAND	REGISTER 1	REGISTER 2	REGISTER 3
1.8 MHz	1.900000 MHz CW	1.910000 MHz CW	1.915000 MHz CW
3.5 MHz	3.550000 MHz LSB	3.560000 MHz LSB	3.580000 MHz LSB
7 MHz	7.050000 MHz LSB	7.060000 MHz LSB	7.020000 MHz CW
10 MHz	10.120000 MHz CW	10.130000 MHz CW	10.140000 MHz CW
14 MHz	14.100000 MHz USB	14.200000 MHz USB	14.050000 MHz CW
18 MHz	18.100000 MHz USB	18.130000 MHz USB	18.150000 MHz USB
21 MHz	21.200000 MHz USB	21.300000 MHz USB	21.050000 MHz CW
24 MHz	24.950000 MHz USB	24.980000 MHz USB	24.900000 MHz CW
28 MHz	28.500000 MHz USB	29.500000 MHz USB	28.100000 MHz CW
50 MHz	50.100000 MHz USB	50.200000 MHz USB	51.000000 MHz FM
144 MHz	145.000000 MHz FM	145.100000 MHz FM	145.200000 MHz FM
General	15.000000 MHz USB	15.100000 MHz USB	15.200000 MHz USB

◇ Using the band stacking registers

- ① Push [14 5], then select a frequency and an operating mode.
 - Frequency and operating mode are memorized in the first band stacking register.
- ② Push [14 5] again, then select another frequency and operating mode.
 - This frequency and operating mode are memorized in the second band stacking register.
- ③ Push [14 5] again, then select another frequency and operating mode.
 - This frequency and operating mode are memorized in the third band stacking register.
 - When a fourth frequency and operating mode are selected on a band, the first register set in step ①, is overwritten.

[Example]: 14 MHz band

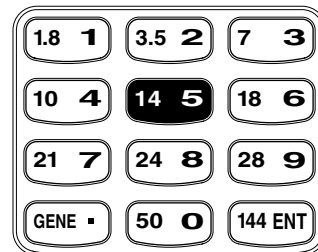

■ Selecting VFO/memory mode

VFO is an abbreviation of Variable Frequency Oscillator, and is commonly referred to as a main tuning function. The tuning dial is often called the “VFO knob.”

- ➔ Push [V/M] to switch between VFO and memory modes.
 - Pushing [V/M] for 1 sec. transfers the contents of the selected memory channel to VFO mode (p. 65).

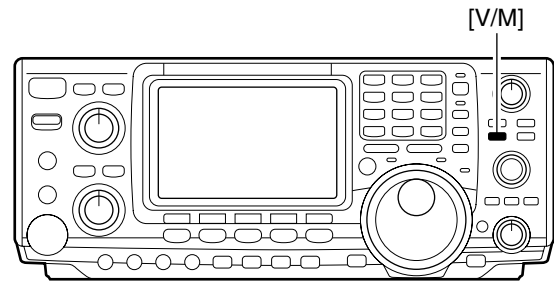

■ VFO operation

The transceiver has 2 VFOs and are called VFO A and VFO B. You can use the desired VFO to call up a frequency and operating mode for your operation.

◇ Selecting the VFO A/B

- ➔ Push [A/B] to switch between the VFO A and VFO B.
 - “VFO A” or “VFO B” appears.

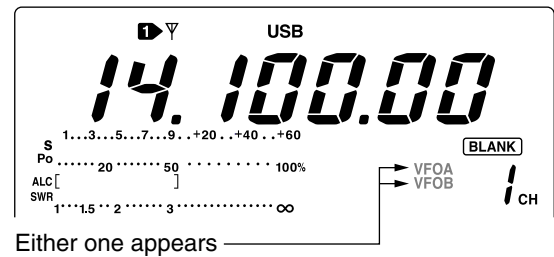
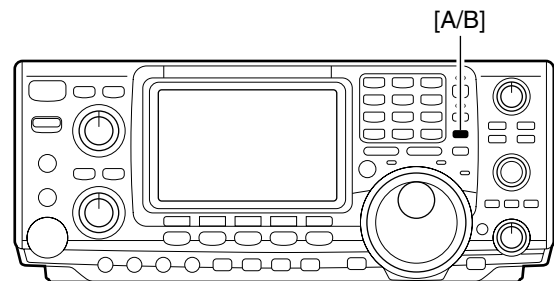

◇ VFO equalization

- ➔ Push [A/B] for 1 sec. to equalize the undisplayed VFO condition to the displayed VFO.
 - 3 beeps sound when the VFO equalization is completed.

CONVENIENT

Use two VFOs as a quick memory

When you find a new station, but you wish to continue searching, the Two VFO system can be used for quick memory storage.

- ① Push [A/B] for 1 sec. to store the displayed frequency into the undisplayed VFO.
- ② Continue searching for stations.
- ③ Push [A/B] to retrieve the stored frequency.
- ④ To continue searching for a station, push [A/B] again.

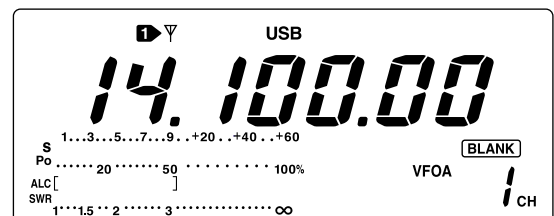

↓ Push [A/B] for 1 sec.

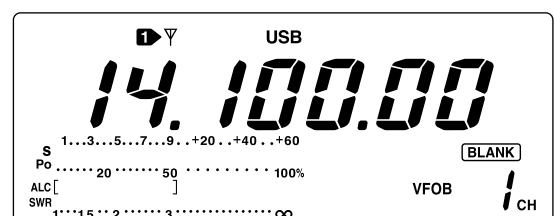

■ Frequency setting

The transceiver has several tuning methods for convenient frequency tuning.

◇ Tuning with the tuning dial

- ① Push the desired band key on the keypad 1–3 times.
 - 3 different frequencies can be selected on each band with the band key. (p. 19)
- ② Rotate the tuning dial to set the desired frequency.

▨ If the dial lock function is activated, the lock indicator lights, and the tuning dial does not function. In this case, push [LOCK/SPCH] to deactivate the lock function. (see p. 52 for details)

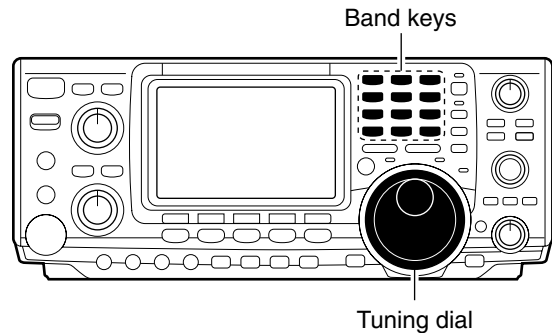

◇ Quick tuning step

The operating frequency can be changed in kHz steps (0.1, 1, 5, 9, 10, 12.5, 20 or 25 kHz selectable) for quick tuning.

- ① Push [SSB], [CW/RTTY] or [AM/FM] to select the desired operation mode.
- ② Push [TS] momentarily to activate the quick tuning function.
 - “▼” appears.
- ③ Push [TS] for 1 sec. to enter the tuning step set mode.
- ④ Rotate the tuning dial to select the desired tuning step.
- ⑤ Push [TS] to exit the tuning step set mode.

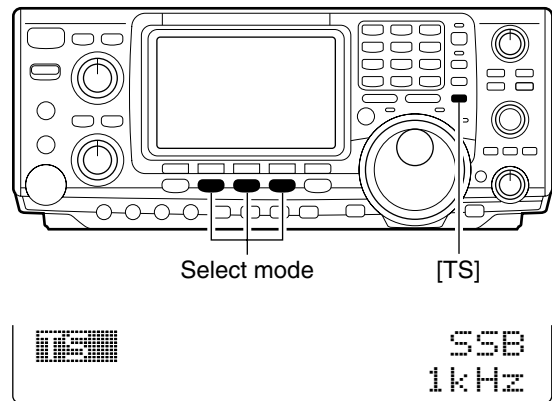

◇ 1/4 Tuning step function (SSB data, CW and RTTY only)

While operating in SSB data/CW/RTTY, the 1/4 function is available for critical tuning. Dial rotation is reduced to 1/4 of normal when the 1/4 function is in use.

➔ While M1 is selected with [MENU], push [F3 1/4] to toggle the 1/4 function ON and OFF.

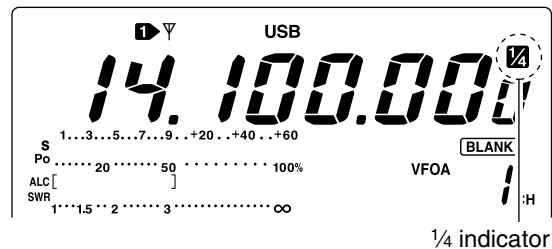

◇ Auto tuning step function

When rotating the tuning dial rapidly, the tuning step automatically changes several times as selected.

- ① Push [MENU] for 1 sec. to enter the set mode.
- ② Push [F1] or [F2] to select the DIAL Auto TS item.
- ③ Rotate the tuning dial to select the function ON (HIGH or LOW) and OFF.
 - HIGH : Approx. 5 times faster
 - LOW : Approx. 2 times faster
 - OFF : Auto tuning step is turned OFF.
- ④ Push [MENU] to exit the set mode.

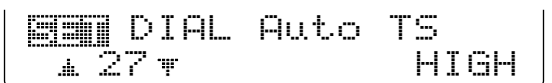

◆ **Selecting the 1 Hz step**

The minimum tuning step of 1 Hz can be used for fine tuning.

- ① Push [TS] momentarily to turn the quick tuning step OFF
 - “▼” disappears.
- ② Push [TS] for 1 sec. to toggle the 1 Hz tuning step ON and OFF.

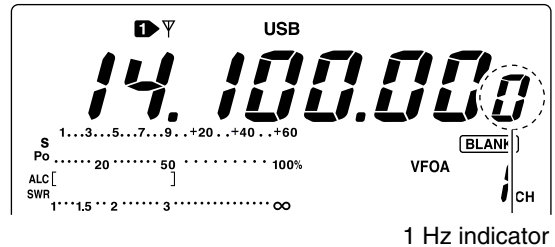
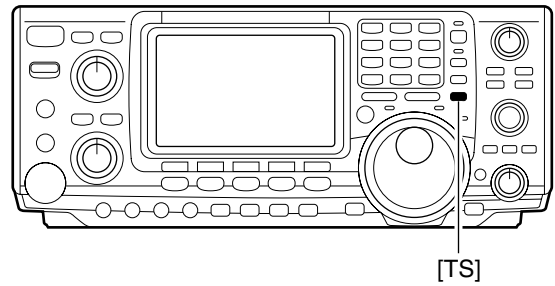

◆ **Band edge warning beep**

When selecting a frequency that lies outside of a band's specified frequency range, a warning beep sounds.

This function can be turned OFF in set mode, if desired. (p. 81)

◆ **Frequency setting with the keypad**

The transceiver has a keypad for direct frequency entry as described below.

- ① Push [F-INP].
 - F-INP indicator lights
- ② Input the desired frequency.
 - Input “.” (decimal point) between the MHz units and kHz units.
- ③ Push [144 ENT] to enter the input frequency.
 - To cancel the input, push [A/B] instead of [144 ENT].

Lights when keypad input is activated.

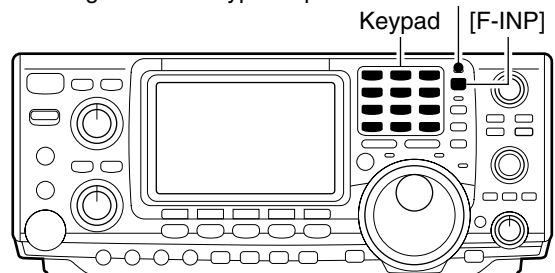

[EXAMPLE]

14.025 MHz

Push [F-INP] [1.8] [1] [10] [4] [GENE] [50] [0] [3.5] [2] [14] [5] [144 ENT]

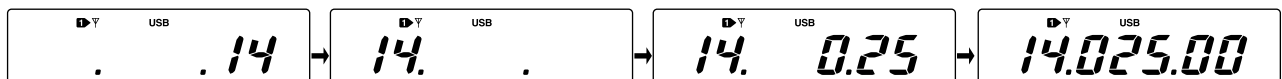

706 kHz

Push [F-INP] [50] [0] [GENE] [21] [7] [50] [0] [18] [6] [144 ENT]

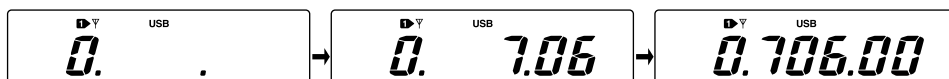

21.280 MHz → 21.245 MHz

Push [F-INP] [GENE] [3.5] [2] [10] [4] [14] [5] [144 ENT]



■ Operating mode selection

SSB (USB/LSB), SSB data (USB data/LSB data), CW, CW reverse (CW-R), RTTY, RTTY-R (RTTY reverse), AM, AM data, FM and FM data modes are available in the IC-7400. Select the desired operation mode as follows.

To select a mode of operation, push the desired mode switch momentarily. Push the switch again to toggle between USB and LSB, CW/CW-R and RTTY/RTTY-R, AM and FM, if necessary. Push the switch for 1 sec. to toggle between CW and CW-R, RTTY and RTTY-R, or to select data mode, if necessary.

See the diagram below right for the order of selection.

Microphone signals are muted when data mode is selected.

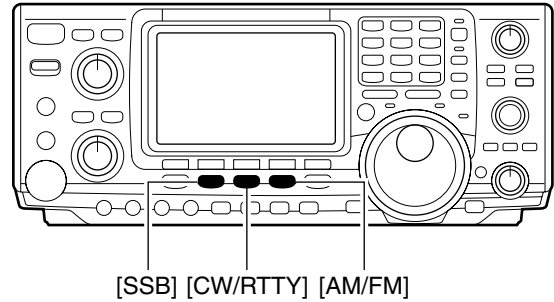

•Selecting SSB mode

- Push [SSB] to select USB or LSB.
 - USB is selected first when above 10 MHz; or LSB is selected first when below 10 MHz operation.
 - After USB or LSB is selected, push [SSB] to toggle between USB and LSB.
 - After USB or LSB is selected, push [SSB] for 1 sec. to select USB data or LSB data mode, respectively.

•Selecting CW/RTTY mode

- Push [CW/RTTY] to select CW or RTTY.
 - After CW/CW-R or RTTY/RTTY-R is selected, push [CW/RTTY] to toggle between CW and RTTY.
 - After CW or RTTY is selected, push [CW/RTTY] for 1 sec. to toggle between CW and CW reverse, or, RTTY and RTTY reverse mode, respectively.

•Selecting AM/FM mode

- Push [AM/FM] to select AM or FM.
 - After AM or FM is selected, push [AM/FM] to toggle between AM and FM mode.
 - After AM or FM is selected, push [AM/FM] for 1 sec. to select AM data or FM data mode, respectively.

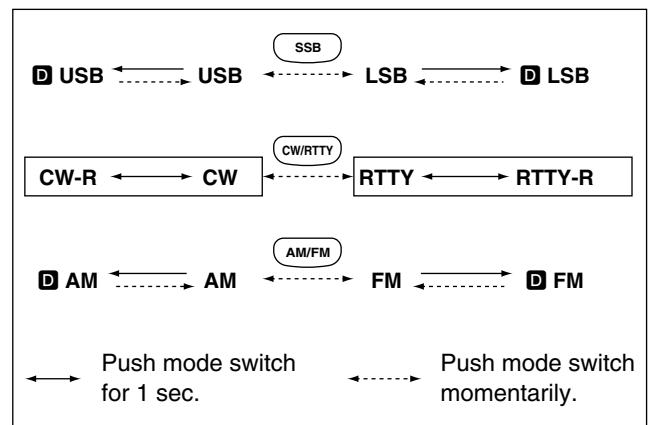

■ Volume setting

- Rotate [AF] control to output a suitable audio level.

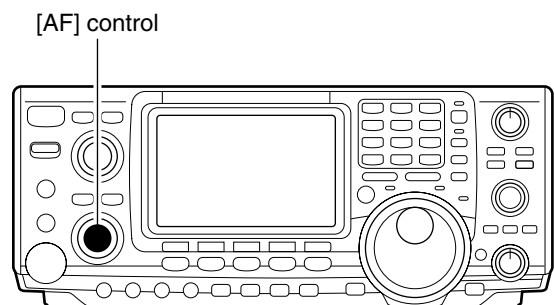
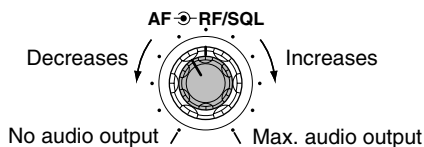

■ Squelch and receive (RF) sensitivity

Adjusts the RF gain and squelch threshold level. The squelch removes noise output from the speaker (closed position) when no signal is received.

- The squelch is particularly effective for FM. It is also available for other modes.
- The control can be set as the RF gain control only (squelch is fixed open) or squelch control (RF gain is fixed at maximum) in set mode (p. 81). See below right.
- The 11 to 12 o'clock position is recommended for any setting of the [RF/SQL] control.

SET MODE	OPERATION
RF+SQL (default)	Can be used in all modes. Functions as noise squelch or S-meter squelch in AM and FM; S-meter squelch only in other modes.
SQL	<ul style="list-style-type: none"> ➤ Operates as a squelch control. <ul style="list-style-type: none"> •RF gain is fixed at max. sensitivity.
AUTO	<ul style="list-style-type: none"> ➤ Operates as an RF gain control in SSB, CW and RTTY. <ul style="list-style-type: none"> •Squelch is fixed open. ➤ Operates as a squelch control in AM and FM. <ul style="list-style-type: none"> •RF gain is fixed at max. sensitivity.

Adjusting RF gain (Receive sensitivity)

Normally, [RF/SQL] is set to the 11 o'clock position. Rotate [RF/SQL] to the 11 o'clock position for maximum sensitivity.

- Rotating counterclockwise from the maximum position reduces sensitivity.
- The S-meter indicates receive sensitivity.

Adjusting squelch (Removing non-signal noise)

Rotate [RF/SQL] clockwise when receiving no signal, until the noise just disappears.

- [RX] indicator light goes out.
- Rotating [RF/SQL] past the threshold point invokes the S-meter squelch— this allows you to set a minimum signal level needed to open the squelch.

[RF/SQL] control

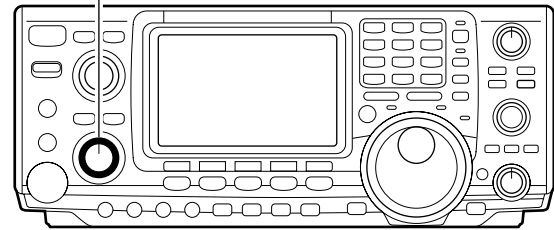

•When setting as RF gain/squelch control

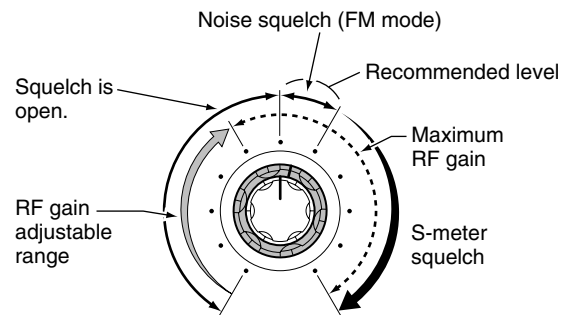

•When functioning as RF gain control (Squelch is fixed open; SSB, CW, RTTY only)

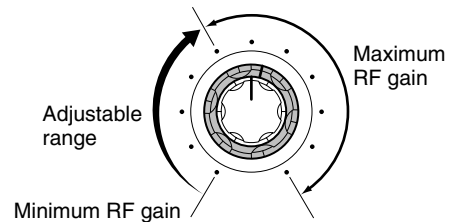

•When functioning as squelch control (RF gain is fixed at maximum)

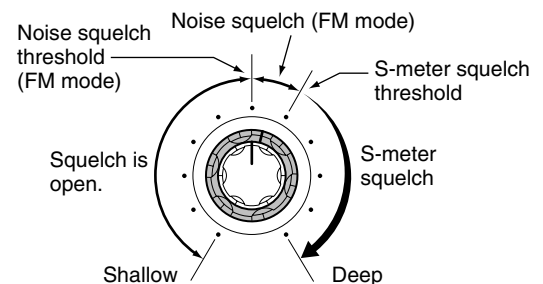

■ Basic transmit operation

Before transmitting, monitor your selected operating frequency to make sure transmitting won't cause interference to other stations on the same frequency. It's good Amateur practice to listen first, and then, even if nothing is heard, ask "is the frequency in use" once or twice, before you begin operating on that frequency.

◇ Transmitting

Before transmitting, monitor your selected operating frequency to make sure transmitting won't cause interference to other stations on the same frequency.

- ① Push [TRANSMIT] or [PTT] (microphone) to transmit.
 - The [TX] indicator lights red.
- ② Push [TRANSMIT] again or release [PTT] (microphone) to return to receive.

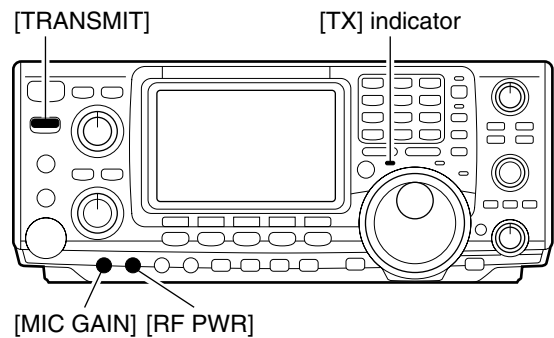

◇ Microphone gain adjustment

Before transmitting, monitor your selected operating frequency to make sure transmitting won't cause interference to other stations on the same frequency.

- ① Push [PTT] (microphone) to transmit.
 - Talk into the microphone at your normal voice level.
- ② While talking into the microphone, rotate [MIC GAIN] so that the ALC meter reading doesn't go outside the ALC zone (see right).
- ③ Release [PTT] (microphone) to return to receive.

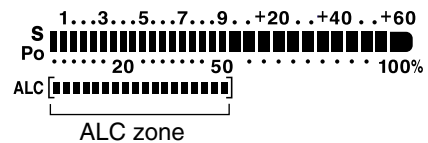

■ Operating SSB

- ① Push a band key to select the desired band.
- ② Push [SSB] to select LSB or USB.
 - Below 10 MHz LSB is automatically selected; above 10 MHz USB is automatically selected.
- ③ Rotate [AF] to set audio to a comfortable listening level.
- ④ Rotate the tuning dial to tune a desired signal.
 - S-meter indicates received signal strength.
- ⑤ Push [TRANSMIT] or [PTT] (microphone) to transmit.
 - The TX indicator lights red.
- ⑥ Speak into the microphone at your normal voice level.
 - Adjust [MIC GAIN] at this step, if necessary.
- ⑦ Push [TRANSMIT] or release [PTT] (microphone) to return to receive.

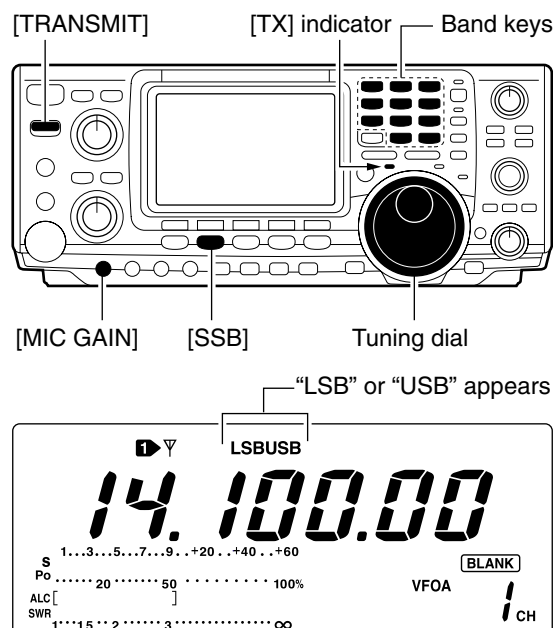

◇ Convenient functions for receive

• Preamp and attenuator (p. 47)

- ➔ Push [P.AMP/ATT] several times to set the preamp OFF, preamp 1 ON or preamp 2 ON.
 - "P.AMP1," "P.AMP2" or "P.AMP" appears when the preamp 1, preamp 2 or preamp is set to ON, respectively. (depending on operating frequency band)
- ➔ Push [P.AMP/ATT] for 1 sec. to set the attenuator ON.
 - Push [P.AMP/ATT] momentarily to turn the attenuator OFF.
 - "ATT" appears when the attenuator is set to ON.

• Noise blanker (p. 50)

- ➔ Push [NB] to turn the noise blanker ON and OFF.
 - "NB" appears when the noise blanker is set to ON.
 - Push [NB] for 1 sec. to enter noise blanker set mode.

• Noise reduction (p. 52)

- ➔ Push [NR] to turn the noise reduction ON and OFF.
 - Rotate [NR] control to adjust the noise reduction level.
 - "NR" appears when the noise reduction is set to ON.

• Auto notch filter (p. 52)

- ➔ Push [A/NOTCH] to turn the auto or manual notch function ON and OFF.
 - Rotate [NOTCH] control to set the attenuating frequency for manual notch operation.

• Twin PBT (passband tuning) (p. 51)

- ➔ Rotate [TWIN PBT] controls (inner/outer).
 - Push [PBTC] to clear the settings.

• AGC (auto gain control) (p. 48)

- ➔ While M1 is selected with [MENU], push [F1 AGC] several times to select AGC **A**, AGC **M**, AGC **S** or AGC OFF.

• VSC (voice squelch control) (p. 53)

- ➔ While M2 is selected with [MENU], push [F5 VSC] to turn the VSC function ON and OFF.
 - The VSC indicator appears when the voice squelch function is set to ON.

◇ Convenient functions for transmit

• Speech compressor (p. 57)

- ➔ While M1 is selected with [MENU], push [F3 COMP] to turn the speech compressor ON and OFF.
 - "COMP" appears when the speech compressor is set to ON.

• VOX (voice operated transmit) (p. 54)

- ➔ Push [VOX/BK-IN] to turn the VOX function ON and OFF.
 - "VOX" appears when the VOX function is set to ON.

• Transmit quality monitor (p. 56)

- ➔ Push [MONITOR] to turn the monitor function ON and OFF.
 - "MONI" appears when the monitor function is set to ON.

• Audio tone control (p. 88)

- ➔ While M2 is selected with [MENU], push [F4 TCH], select an item with [F1 ▲] and [F2 ▼] then rotate the tuning dial to adjust the audio tone.

■ Operating CW

- ① Push a band key to select the desired band.
- ② Push [CW/RTTY] to select CW.
 - After CW mode is selected, push [CW/RTTY] for 1 sec. to toggle between CW and CW-R modes.
- ③ Rotate [AF] to set audio to a comfortable listening level.
- ④ Rotate the tuning dial to simultaneously tune a desired signal and its side tone.
 - S-meter indicates received signal strength.
- ⑤ Push [TRANSMIT] to transmit.
 - The TX indicator lights red.
- ⑥ Use the electric keyer or paddle to key your CW signals.
 - The Po meter indicates transmitted CW signal strength.
- ⑦ Adjust CW speed with [KEY SPEED].
- ⑧ Push [TRANSMIT] to return to receive.

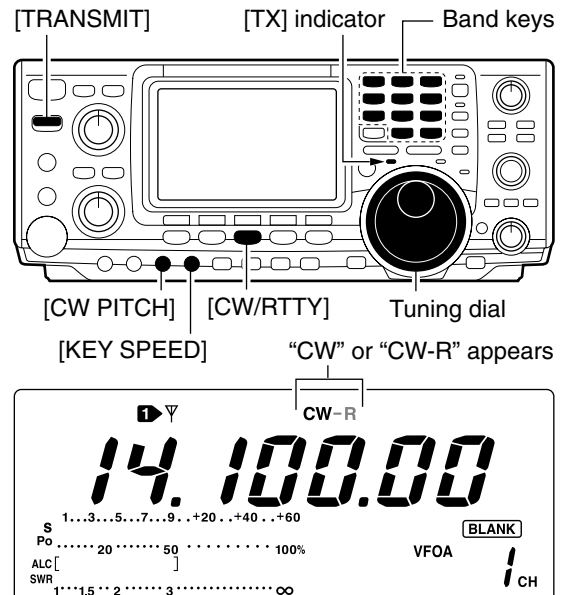

◆ Convenient functions for receive

•Preamp and attenuator (p. 47)

- ➔ Push [P.AMP/ATT] several times to set the preamp OFF, preamp 1 ON or preamp 2 ON.
 - “P.AMP1,” “P.AMP2” or “P.AMP” appears when the preamp 1, preamp 2 or preamp is set to ON, respectively. (depending on operating frequency band)
- ➔ Push [P.AMP/ATT] for 1 sec. to set the attenuator ON.
 - Push [P.AMP/ATT] momentarily to turn the attenuator OFF.
 - “ATT” appears when the attenuator is set to ON.

•Noise blanker (p. 50)

- ➔ Push [NB] to turn the noise blanker ON and OFF.
 - “NB” appears when the noise blanker is set to ON.
 - Push [NB] for 1 sec. to enter noise blanker set mode.

•Noise reduction (p. 52)

- ➔ Push [NR] to turn the noise reduction ON and OFF.
 - Rotate [NR] control to adjust the noise reduction level.
 - “NR” appears when the noise reduction is set to ON.

•Auto notch filter (p. 52)

- ➔ Push [A/NOTCH] to turn the auto or manual notch function ON and OFF.
 - Rotate [NOTCH] control to set the attenuating frequency for manual notch operation.

•Twin PBT (passband tuning) (p. 51)

- ➔ Rotate [TWIN PBT] controls (inner/outer).
 - Push [PBTC] to clear the settings.

•AGC (auto gain control) (p. 48)

- ➔ While **M1** is selected with [MENU], push [F1 AGC] several times to select AGC **F**, AGC **M**, AGC **S** or AGC OFF.

•1/4 function (p. 21)

- ➔ While **M1** is selected with [MENU], push [F3 1/4] to turn the 1/4 function ON and OFF.

◆ Convenient functions for transmit

•Break-in function (p. 55)

- ➔ Push [VOX/BK-IN] several times to set the break-in OFF, semi break-in or full break-in.
 - “BK-IN” or “**B** BK-IN” appears when the semi break-in or full break-in is set to ON, respectively.

◆ About CW reverse mode

CW reverse mode receives CW signals with a reverse side CW carrier point like that of LSB and USB modes.

Use when interfering signals are near a desired signal and you want to change the interference tone.

- ① Push [CW/RTTY] several times to select CW mode.
- ② Push [CW/RTTY] for 1 sec. to select CW or CW-R mode.
 - Check the interfering tone.

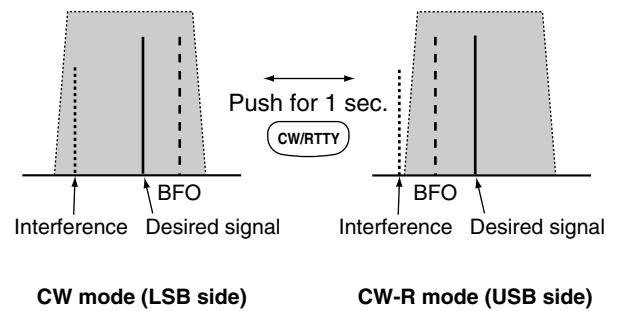

◆ About CW pitch control

The received CW audio pitch and monitored CW audio can be adjusted to suit your preference (300 to 900 Hz in 25 Hz steps) without changing the operating frequency.

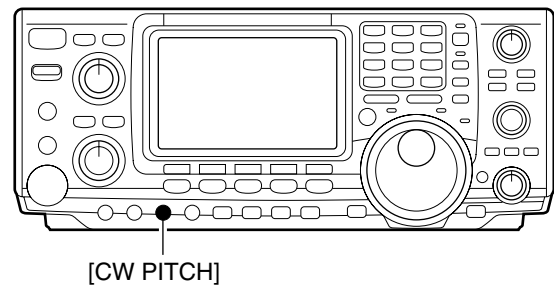

◆ About keying speed

The transceiver's internal electronic keyer speed can be adjusted from 6 to 60 wpm.

- ➔ Rotate [KEY SPEED] clockwise to increase keying speed; counterclockwise to decrease keying speed.

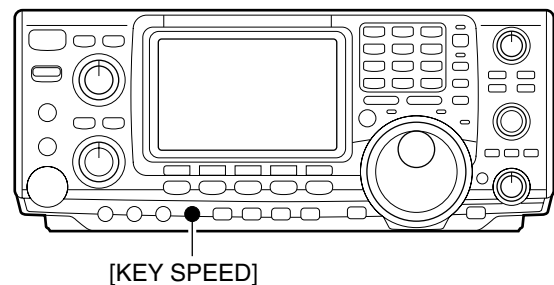

◆ CW side tone function

When the transceiver is in the receive condition (and the break-in function is OFF— p. 55) you can listen to the tone of your CW signal without actually transmitting. This allows you to match your transmit signal exactly to another station's. This also convenient for CW practice. CW side tone level can be adjusted in keyer set mode (p. 33).

Electronic keyer functions

The transceiver has a number of convenient functions for the electronic keyer that can be accessed from the memory keyer menu.

- ① Push [CW/RTTY] to select CW mode.
- ② Push [MENU] to select M1.
- ③ Push [F4 KEY] to select the memory keyer menu.
 - The selectable menu can be changed with the keyer send menu in the set mode. (p. 86)
- ④ Push one of the multi-function keys ([F1] to [F5]) to select an item in the memory keyer menu. See the diagram below.
 - Push [MENU] to return to the previous indication.

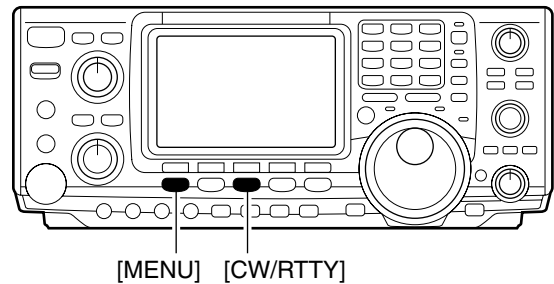

◇ IN CW MODE

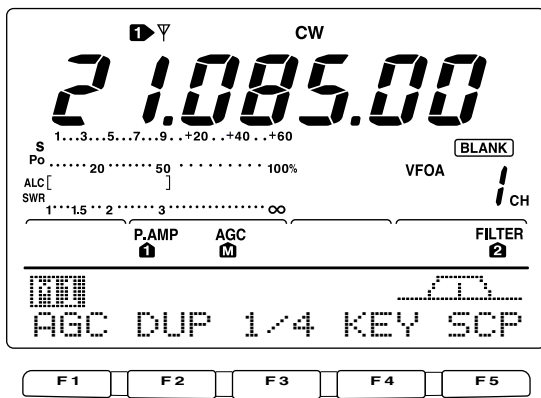

• Memory keyer menu



Push [F4]

Push [MENU]

• Keyer send menu (p. 30)

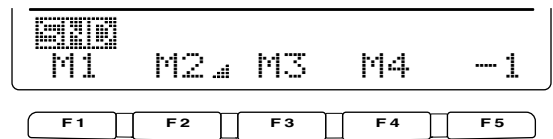

Push [F2]

• Edit menu (p. 31)

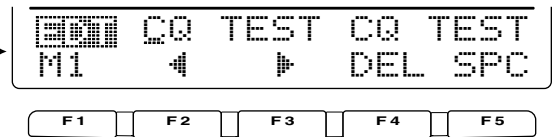

Push [F3]

• Contest number set mode (p. 32)



Push [F4]

• Keyer set mode (p. 33)

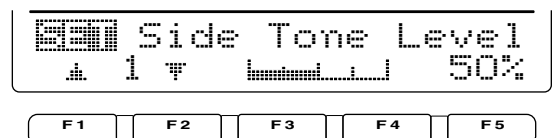

Push [F5]

◆ Memory keyer send menu

Pre-set characters can be sent using the keyer send menu. Contents of the memory keyer are set using the edit menu.

• Transmitting

- ① While M1 is selected in CW mode, push [F4 KEY] to select the memory keyer menu.
- ② Push [F2 SEND] to select the keyer send menu.
- ③ Push [TRANSMIT] to set the transceiver to transmit, or set the break-in function ON (p. 55).
- ④ Push one of the function keys ([F1] to [F4]) to send the contents of the memory keyer.
 - Pushing a function key for 1 sec. repeatedly sends the contents; push any function key to cancel the transmission.
 - The contest number counter, above [F5], is incremented each time the contents are sent.
 - Push [F5] to reduce the contact number count by 1 when resending contents to unanswered calls.

For your information

When an external keypad is connected to the pin 3 and pin 7 of the [MIC] connector, the programmed contents, M1—M4, can be transmitted without selecting the keyer send menu.
See p. 86 for details.

- ⑤ Push [MENU] 2 times to return to M1.

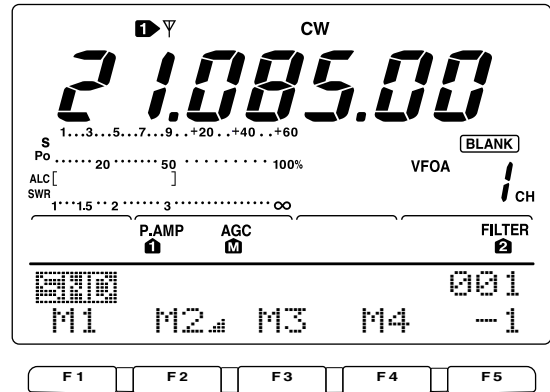

M1 send indication

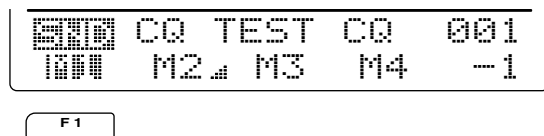

M2 send indication

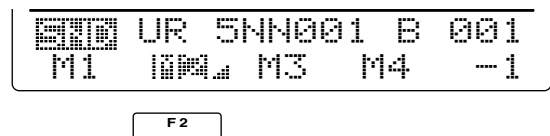

Repeat send indication

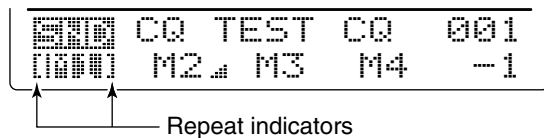

M2 send indication

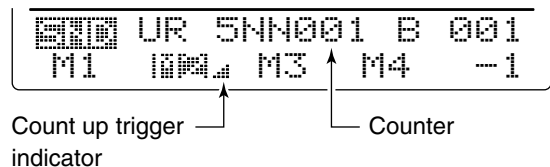

M3 send indication

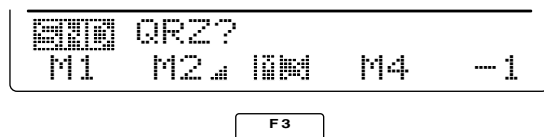

M4 send indication

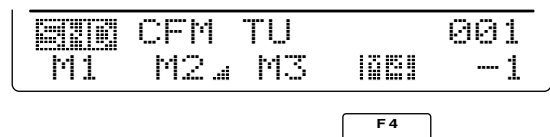

◆ Editing a memory keyer

The contents of the memory keyer memories can be set using the memory keyer edit menu. The memory keyer can memorize and re-transmit 4 CW key codes for often-used CW sentences, contact numbers, etc. Total capacity of the memory keyer is 50 characters per memory channel.

• Programming contents

- ① Push [MENU] to select M1, then push [F4 KEY] to select the memory keyer menu.
- ② Push [F3 EDIT] to select edit menu.
 - Memory keyer contents of the Channel 1 (M1) is indicated.
 - Push [F5] to manually increment the contest number.
- ③ Push [F1] to select the desired memory keyer channel to be edited.
- ④ Input the desired character by rotating the tuning dial or by pushing the keypad for number input.
 - Selectable characters (with the tuning dial);

```

ABCDEF GHIJKL MNOPQRST
UVWXYZ / ? . , * ^
    
```

NOTE:

“^” is used to transmit a following word with no space such as AR. Put “^” before a text string such as ^AR, and the string “AR” is sent with no space.

“*” is used to insert the CW contact number. The contact number automatically increments by 1. This function is only available for one memory keyer channel at a time. Memory keyer channel M2 used “*” by default.

- ⑤ Push [F2 ←] or [F3 →] to move the cursor backwards or forwards, respectively.
- ⑥ Repeat steps ④ and ⑤ to input the desired characters.
- ⑦ Push [MENU] 2 times to return to M1.

Pre-programmed contents

CH	Contents
M1	CQ TEST CQ TEST DE JA1 JA1 TEST
M2	UR 5NN* BK
M3	CFM TU
M4	QRZ?

• Edit menu

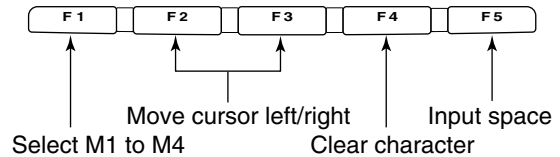
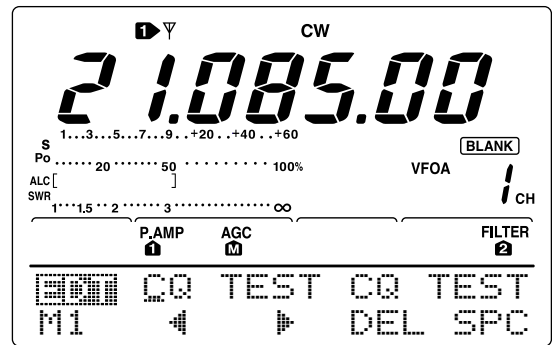

¥ M2 default indication



When inputting an asterisk, the counter is incremented by 1.

¥ M3 default indication



¥ M4 default indication

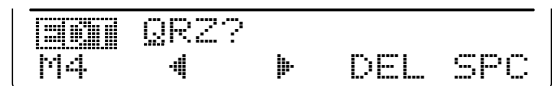

Example display— when inputting QSL TU DE JA3YUA TEST into M3.



◆ Contest number set mode

This menu is used to set the contest (serial) number and count up trigger, etc.

•Setting contents

- ① Push [MENU] to select M1, then push [F4 KEY] to select the memory keyer menu.
- ② Push [F4 001] to enter the contest number set mode.
- ③ Push [F1 ▲] or [F2 ▼] to select the desired set item.
- ④ Set the desired condition using the tuning dial.
 - Push [F3] for 1 sec. to select a default condition or value.
- ⑤ Push [MENU] 2 times to return to M1.

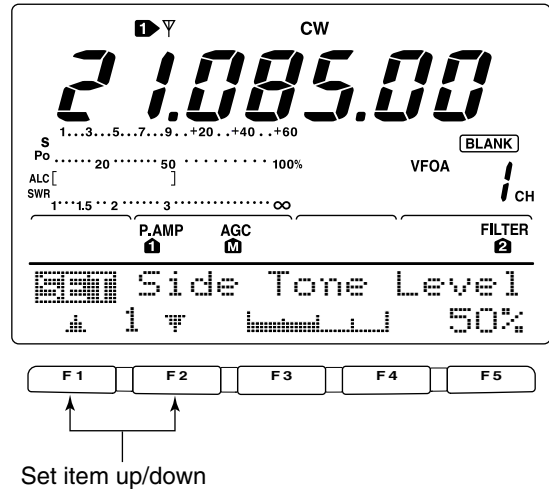

1. Number Style

This item sets the numbering system used for contact (serial) numbers— normal or morse cut numbers.

- Normal : Does not use morse cut number (default)
- 190 → AND : Sets 1 as A, 9 as N and 0 as O.
- 190 → ANT : Sets 1 as A, 9 as N and 0 as T.
- 90 → NO : Sets 9 as N and 0 as O.
- 90 → NT : Sets 9 as N and 0 as T.

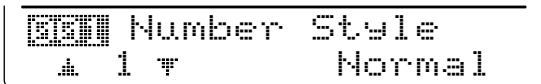

2. Count Up Trig

This selects which of the four memory slots will have the contest serial number exchange. The count up trigger allows the serial number to be automatically incremented after each complete serial number exchange is sent.

- M1, M2, M3 and M4 can be set. (default: M2)

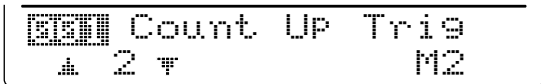

3. Present Number

This item shows the current number for the count up trigger channel set above.

- Rotate the tuning dial to change the number, or push [F3 CLR] for 1 sec. to reset the current number to 001.



◆ **Keyer set mode**

This set mode is used to set the CW side tone, memory keyer repeat time, dash weight, paddle specifications, keyer type, etc.

• **Setting contents**

- ① Push [MENU] to select M1, then push [F4 KEY] to select the memory keyer menu.
- ② Push [F5 SET] to select keyer set mode.
- ③ Push [F1 ▲] or [F2 ▼] to select the desired set item.
- ④ Set the desired condition using the tuning dial.
 - Push [F3] for 1 sec. to select a default condition or value.
- ⑤ Push [MENU] 2 times to return to M1.

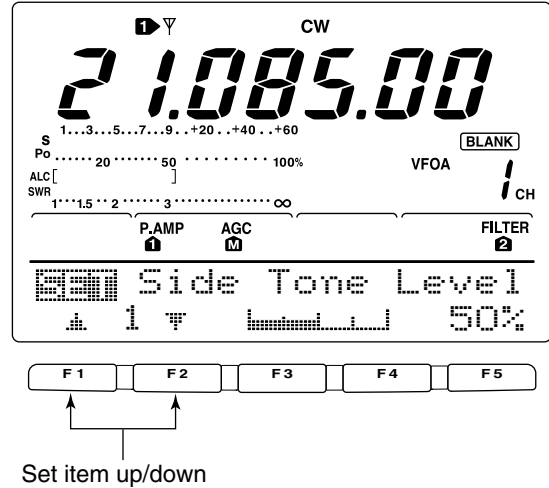

1. Side Tone Level

This item sets the CW side tone output level.
 • 0 to 100% in 1% steps can be selected.



2. Side Tone L-lmt

This item sets the CW side tone level limit. When the [AF] control is rotated above a specified level, the CW side tone does not increase.

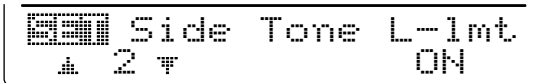

- ON CW side tone level is limited. (default)
- OFF CW side tone level is not limited.

3. Repeat Time

When sending CW using the repeat timer, this item sets the time between transmission.
 • 1 to 60 sec. in 1 sec. steps can be selected.

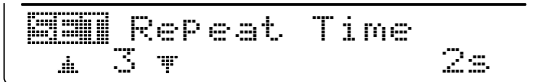

4. Dot/Dash Ratio

This item sets the dot/dash ratio.
 • 1:1:2.8 to 1:1:4.5 (in 0.12 steps) can be selected.

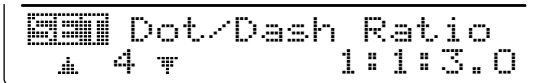

Keying weight example: Morse code "K"

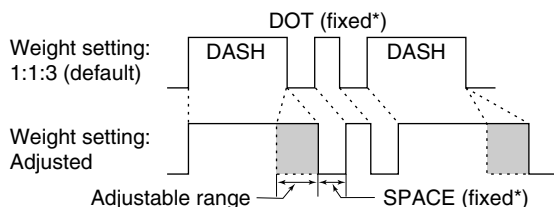

*SPACE and DOT length can be adjusted with [KEY SPEED] only.

5. Rise Time

This item sets the envelop time period which the output power becomes the set transmit power.

- 2, 4, 6 or 8 msec. can be selected.

 Rise Time
 ▲ 5 ▼ 4ms

• About rise time

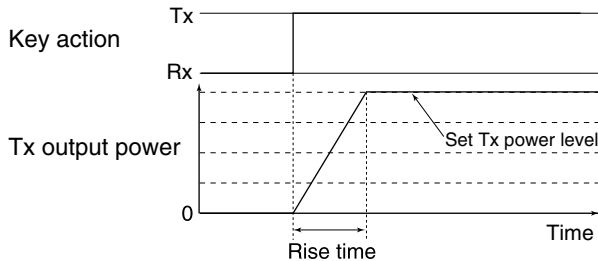

6. Paddle Polarity

This item sets the paddle polarity.

- Normal and reverse polarity can be selected.

 Paddle Polarity
 ▲ 6 ▼ NORMAL

7. Keyer Type

This item selects the keyer type for [ELEC-KEY] connector on the front panel.

- ELEC-KEY, BUG KEY and Straight key can be selected.

 Keyer Type
 ▲ 7 ▼ ELEC-KEY

8. MIC U/D Keyer

This item allows you to set the microphone [UP]/[DN] keys to be used as a paddle.

- ON** [UP]/[DN] switches can be used for CW.
OFF [UP]/[DN] switches cannot be used for CW.

 MIC U/D Keyer
 ▲ 8 ▼ OFF

NOTE: When "ON" is selected, the frequency and memory channel cannot be changed using the [UP]/[DN] switches.

■ Operating RTTY (FSK)

Before operating RTTY, be sure to consult the manual that comes with your TNC.

- ① Push a band key to select the desired band.
- ② Push [CW/RTTY] several times to select RTTY.
 - After RTTY mode is selected, push [CW/RTTY] for 1 sec. to toggle RTTY and RTTY-R modes.
- ③ Rotate [AF] to set audio to a comfortable listening level.
- ④ Rotate the tuning dial to tune a desired signal.
 - S-meter indicates received signal strength.
 - If the received signal cannot be demodulated, try selecting RTTY-R mode.
- ⑤ Push [TRANSMIT] to set the transceiver to the transmit condition or transmit a SEND signal from your TNC.
 - The TX indicator lights red.
 - The Po meter indicates transmitted RTTY signal strength.
- ⑥ Operate the connected PC or TNC (TU) to transmit RTTY (FSK) signals.
 - Adjust [MIC GAIN] at this step, if necessary.
- ⑦ Push [TRANSMIT] to return to receive.

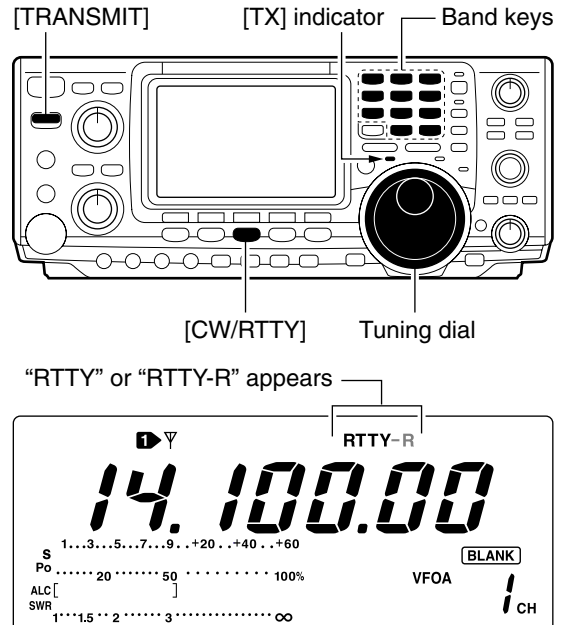

◆ Convenient functions for receive

•Preamp and attenuator (p. 47)

- Push [P.AMP/ATT] several times to set the preamp OFF, preamp 1 ON or preamp 2 ON.
 - “P.AMP $\mathbf{1}$,” “P.AMP $\mathbf{2}$ ” or “P.AMP” appears when the preamp 1, preamp 2 or preamp is set to ON, respectively. (depending on operating frequency band)
- Push [P.AMP/ATT] for 1 sec. to set the attenuator ON.
 - Push [P.AMP/ATT] momentarily to turn the attenuator OFF.
 - “ATT” appears when the attenuator is set to ON.

•Noise blanker (p. 50)

- Push [NB] to turn the noise blanker ON and OFF.
 - “NB” appears when the noise blanker is set to ON.
 - Push [NB] for 1 sec. to enter noise blanker set mode.

•Noise reduction (p. 52)

- Push [NR] to turn the noise reduction ON and OFF.
 - Rotate [NR] control to adjust the noise reduction level.
 - “NR” appears when the noise reduction is set to ON.

•Twin PBT (passband tuning) (p. 51)

- Rotate [TWIN PBT] controls (inner/outer).
 - Push [PBT C] to clear the settings.

•AGC (auto gain control) (p. 48)

- While $\mathbf{M1}$ is selected with [MENU], push [F1 AGC] several times to select AGC \mathbf{F} , AGC \mathbf{M} , AGC \mathbf{S} or AGC OFF.

• $\frac{1}{4}$ function (p. 21)

- While $\mathbf{M1}$ is selected with [MENU], push [F3 $\frac{1}{4}$] to turn the $\frac{1}{4}$ function ON and OFF.

◆ Convenient functions for transmit

•Transmit quality monitor (p. 56)

- Push [MONITOR] to turn the monitor function ON and OFF.
 - “MONI” appears when the monitor function is set to ON.

■ RTTY functions

The transceiver has a number of convenient functions for the RTTY operation that can be accessed from the RTTY menu.

- ① Push [CW/RTTY] to select RTTY mode.
- ② Push [MENU] to select M1.
- ③ Push [F4 RTTY] to select the RTTY menu.
- ④ Push one of the multi-function keys ([F2], [F4] or [F5]) to select an item in the RTTY menu. See the diagram below.
 - Push [MENU] to return to the previous indication.

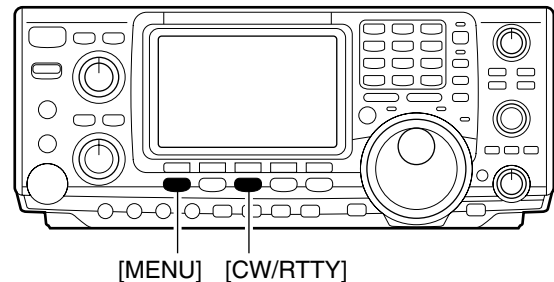

◇ IN RTTY MODE

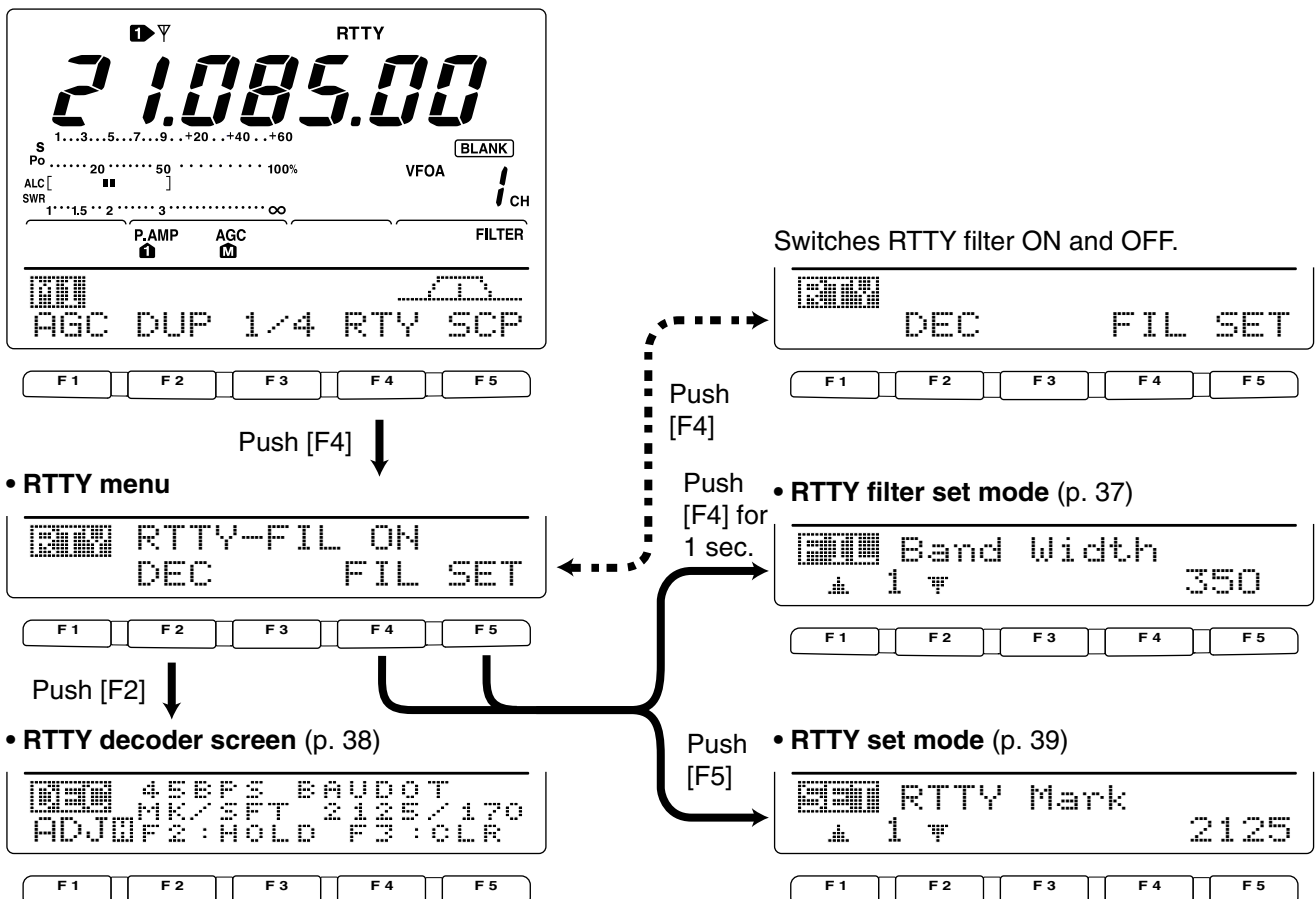

◇ About RTTY reverse mode

Received characters are occasionally garbled when the receive signal is reversed between MARK and Space. This reversal can be caused by incorrect TNC connections, setting, commands, etc. To receive reversed RTTY signals correctly, select RTTY-R mode.

- ➔ While RTTY mode is selected, push [CW/RTTY] for 1 sec. to select the RTTY reverse mode.
 - "RTTY-R" appears when the RTTY reverse mode is selected.
 - Push [CW/RTTY] for 1 sec. again to select the normal RTTY mode.

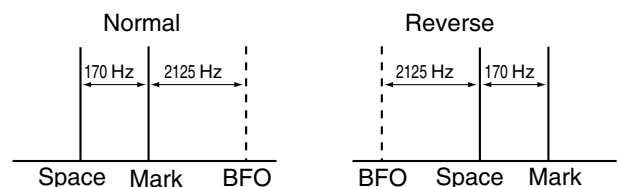

◆RTTY filter/Twin peak filter

The transceiver has 5 RTTY filters in addition to normal IF filters. The passband width can be selected from 1 kHz, 500 Hz, 350 Hz, 300 Hz and 250 Hz. When the RTTY filter is turned ON, the RTTY tuning meter can be used.

Moreover, the twin peak filter changes the receive frequency response by boosting 2 particular frequencies (2125 and 2295 Hz) for better copying of desired RTTY signals.

•RTTY filter and twin peak filter setting

- ① Push [CW/RTTY] to select RTTY mode.
 - After RTTY mode is selected, push [CW/RTTY] for 1 sec. to select RTTY-R mode.
- ② Push [MENU] several times to select M1.
- ③ Push [F4 RTTY] to select RTTY menu.
- ④ Push [F4 FIL] to turn the RTTY filter ON and OFF.
 - When the RTTY filter is turned ON, the normal IF filter number indication (1, 2 or 3) disappears.
- ⑤ Push [F4 FIL] for 1 sec. to enter RTTY filter set mode (see below).
- ⑥ Push [F1] to select bandwidth item.
- ⑦ Rotate the tuning dial to select the RTTY filter width from 1 kHz, 500 Hz, 350 Hz, 300 Hz and 250 Hz.
 - Push [F3] for 1 sec. to select a default value.
- ⑧ Push [F2] to select twin peak filter item.
 - The received audio volume may become greater when the twin peak filter is turned ON.
- ⑨ Rotate the tuning dial to turn the twin peak filter function ON and OFF.
- ⑩ Push [MENU] 2 times to return to M1.

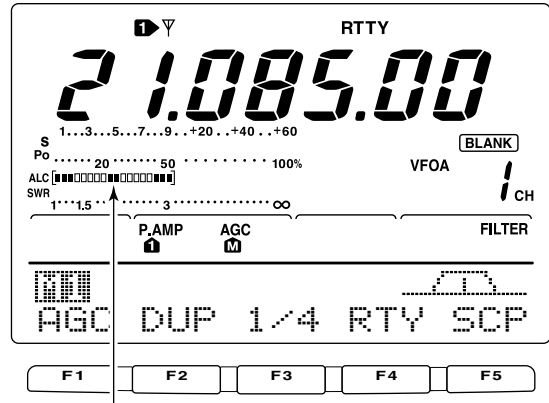

RTTY filter indicator
ALC [■■■■■■■■■■■■■■■■■■■■]
←————→
Rotate the tuning dial to the point where both sides of the dots appear equally. Push [F4]

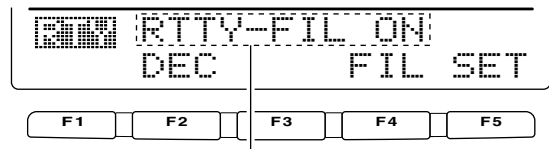

Disappears when the RTTY filter is turned OFF.

•RTTY filter set mode

1. Band Width
This item sets the RTTY filter width.
•250, 300, 350, 500 Hz and 1 kHz can be selected.

2. Twin Peak FIL
This item turns the twin peak filter ON and OFF.

◆ RTTY decoder

The transceiver has an RTTY decoder for Baudot (mark freq.: 2125 Hz, shift freq.: 170 Hz, 45 bps).

An external terminal unit (TU) or terminal node connector (TNC) is not necessary for receiving a Baudot signal.

- ① Push [CW/RTTY] to select RTTY mode.
 - After RTTY mode is selected, push [CW/RTTY] for 1 sec. to select RTTY-R mode.
- ② Push [MENU] several times to select M1.
- ③ Push [F4 RTTY] to select RTTY menu.
- ④ Push [F4 FIL] to turn the RTTY filter ON.
 - The RTTY decoder does not function when the RTTY filter is turned OFF.
- ⑤ Push [F2 DEC] to turn the RTTY decoder ON.
 - RTTY decoder screen appears.
- ⑥ Push [F2] to freeze the current screen.
 - "H" appears while the function is in use.
- ⑦ Push [F3] for 1 sec. to clear the displayed characters.
- ⑧ Push [MENU] to exit the RTTY decoder screen.

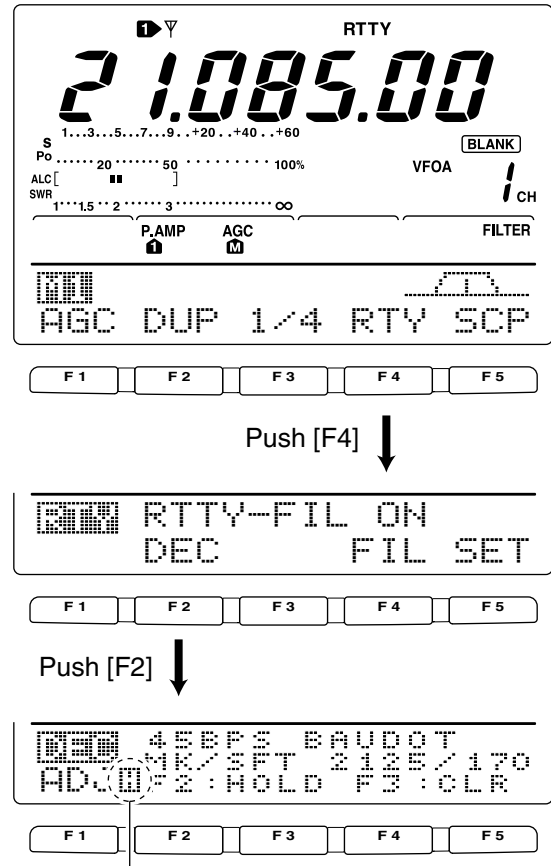

Appears while the RTTY decoder screen is frozen with [F2] operation.

Push [F3] to erase the displayed characters.

• Setting the decoder threshold level

Adjust the RTTY decoder threshold level if some characters are displayed when no signal is received.

- ① Call up the RTTY decoder screen as described above.
- ② Push [F1 ADJ] to select the threshold level setting condition.
- ③ Rotate the tuning dial to adjust the RTTY decoder threshold level.
 - Push [F3] for 1 sec. to select the default condition.
- ④ Push [MENU] to exit the RTTY decoder screen.

▨ The number of line of text can be selected from 2 or 3 in the display. The UnShift On Space (USOS) function and new line code can be set in the RTTY set mode. (p. 39)

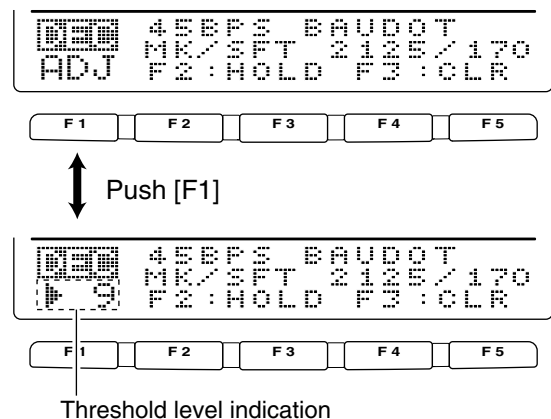

Threshold level indication

◆ RTTY set mode

This set mode is used to set the mark and shift frequencies, keying type, decode USOS function, etc.

• Setting contents

- ① Push [MENU] to select M1, then push [F4 RTV] to select the RTTY menu.
- ② Push [F5 SET] to select RTTY set mode.
- ③ Push [F1▲] or [F2▼] to select the desired set item.
- ④ Set the desired condition using the tuning dial.
 - Push [F3] for 1 sec. to select a default condition or value.
- ⑤ Push [MENU] 2 times to return to M1.

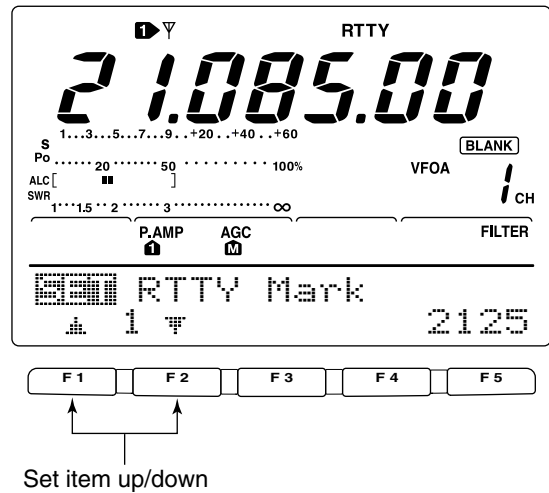

1. RTTY Mark

Sets the mark frequency for RTTY operation.
 • 1275, 1615 and 2125 Hz are selectable.

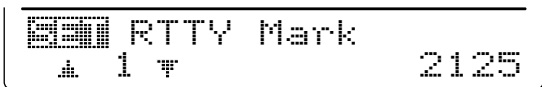

2. RTTY Shift

Sets the shift frequency for RTTY operation.
 • 170, 200 and 425 Hz are selectable.

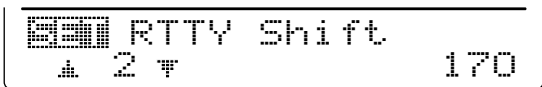

3. RTTY Keying

Selects the keying polarity from normal and reverse.

- NORMAL Key open/close = Mark/Space
- REVERSE Key open/close = Space/Mark

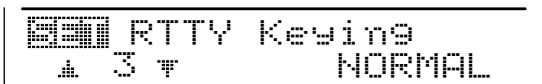

4. Decode USOS

Turn the USOS (UnShift On Space) function ON/OFF

- ON Decode as letter code
- OFF Decode as character code

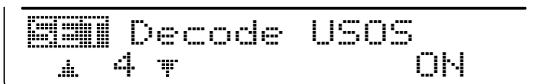

5. Decode New Line

Selects the new line code of the internal RTTY decoder.
 CR: Carriage Return; LF: Line Feed

- CR, LF, CR+LF CR, LF and CR+LF
- CR+LF CR+LF only

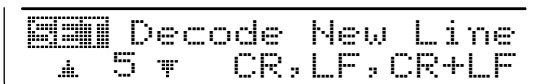

6. Decode Screen

Selects the number of the decoder indication from 2 or 3 lines.

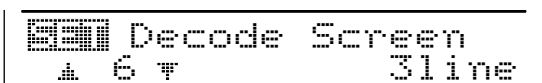

■ Operating AM

- ① Push a band key to select the desired band.
- ② Push [AM/FM] to select AM.
- ③ Rotate [AF] to set audio to a comfortable listening level.
- ④ Rotate the tuning dial to tune a desired signal.
 - S-meter indicates received signal strength.
 - The default tuning step for AM mode is 1 kHz; this can be changed using the tuning step program mode. (p. 21)
- ⑤ Push [TRANSMIT] or [PTT] (microphone) to transmit.
 - The TX indicator lights red.
- ⑥ Speak into the microphone at your normal voice level.
 - Adjust [MIC GAIN] at this step, if necessary.
- ⑦ Push [TRANSMIT] or release [PTT] (microphone) to return to receive.

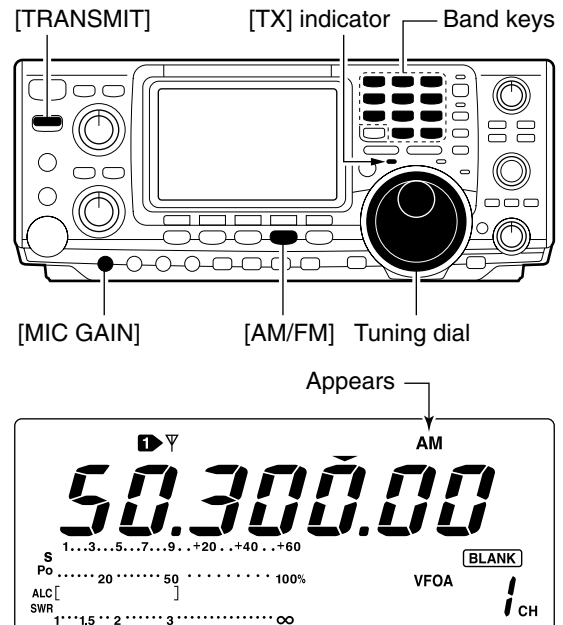

◇ Convenient functions for receive

•Preamp and attenuator (p. 47)

- ➔ Push [P.AMP/ATT] several times to set the preamp OFF, preamp 1 ON or preamp 2 ON.
 - “P.AMP1,” “P.AMP2” or “P.AMP” appears when the preamp 1, preamp 2 or preamp is set to ON, respectively. (depending on operating frequency band)
- ➔ Push [P.AMP/ATT] for 1 sec. to set the attenuator ON.
 - Push [P.AMP/ATT] momentarily to turn the attenuator OFF.
 - “ATT” appears when the attenuator is set to ON.

•Noise blanker (p. 50)

- ➔ Push [NB] to turn the noise blanker ON and OFF.
 - “NB” appears when the noise blanker is set to ON.
 - Push [NB] for 1 sec. to enter noise blanker set mode.

•Noise reduction (p. 52)

- ➔ Push [NR] to turn the noise reduction ON and OFF.
 - Rotate [NR] control to adjust the noise reduction level.
 - “NR” appears when the noise reduction is set to ON.

•Auto notch filter (p. 52)

- ➔ Push [A/NOTCH] to turn the auto or manual notch filter ON and OFF.
 - Rotate [NOTCH] control to set the attenuating frequency for manual notch operation.

•IF shift (p. 51)

- ➔ Rotate [TWIN PBT] controls (inner only).
 - Push [PBTC] to clear the settings.

•AGC (auto gain control) (p. 48)

- ➔ While M1 is selected with [MENU], push [F1 AGC] several times to select AGC **F**, AGC **M**, AGC **S** or AGC OFF.

•VSC (voice squelch control) (p. 53)

- ➔ While M2 is selected with [MENU], push [F5 VSC] to turn the VSC function ON and OFF.
 - The VSC indicator appears when the voice squelch function is set to ON.

◇ Convenient functions for transmit

•Speech compressor (p. 57)

- ➔ While M1 is selected with [MENU], push [F3 COMP] to turn the speech compressor ON and OFF.
 - “COMP” appears when the speech compressor is set to ON.

•VOX (voice operated transmit) (p. 54)

- ➔ Push [VOX/BK-IN] to turn the VOX function ON and OFF.
 - “VOX” appears when the VOX function is set to ON.

•Transmit quality monitor (p. 56)

- ➔ Push [MONITOR] to turn the monitor function ON and OFF.
 - “MONI” appears when the monitor function is set to ON.

•Audio tone control (p. 88)

- ➔ While M2 is selected with [MENU], push [F4 TON], select an item with [F1 \uparrow] and [F2 \downarrow] then rotate the tuning dial to adjust the audio tone.

■ Operating FM

- ① Push a band key to select the desired band.
- ② Push [AM/FM] to select FM.
- ③ Rotate [AF] to set audio to a comfortable listening level.
- ④ Rotate the tuning dial to tune a desired signal.
 - S-meter indicates received signal strength.
- ⑤ Push [TRANSMIT] or [PTT] (microphone) to transmit.
 - The TX indicator lights red.
- ⑥ Speak into the microphone at your normal voice level.
 - Adjust [MIC GAIN] at this step, if necessary.
- ⑦ Push [TRANSMIT] or release [PTT] (microphone) to return to receive.

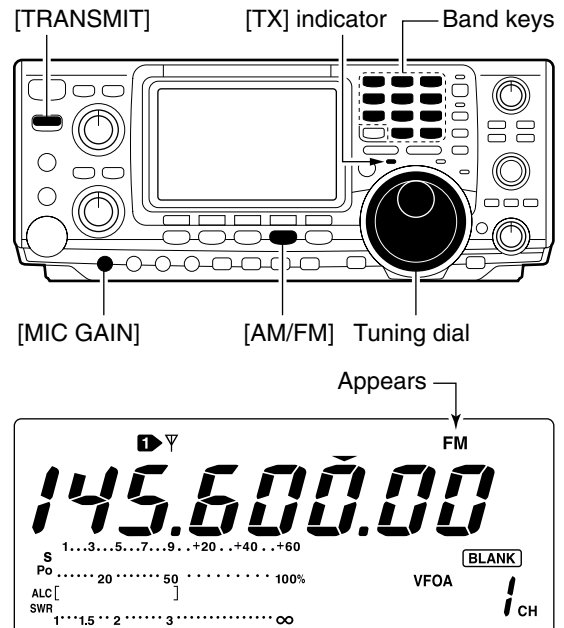

◇ Convenient functions for receive

• Preamp and attenuator (p. 47)

- ➔ Push [P.AMP/ATT] several times to set the pre-amp OFF, preamp 1 ON or preamp 2 ON.
 - "P.AMP \blacksquare ," "P.AMP \blacksquare " or "P.AMP" appears when the preamp 1, preamp 2 or preamp is set to ON, respectively. (depending on operating frequency band)
- ➔ Push [P.AMP/ATT] for 1 sec. to set the attenuator ON.
 - Push [P.AMP/ATT] momentarily to turn the attenuator OFF.
 - "ATT" appears when the attenuator is set to ON.

• Noise blanker (p. 50)

- ➔ Push [NB] to turn the noise blanker ON and OFF.
 - "NB" appears when the noise blanker is set to ON.
 - Push [NB] for 1 sec. to enter noise blanker set mode.

• Noise reduction (p. 52)

- ➔ Push [NR] to turn the noise reduction ON and OFF.
 - Rotate [NR] control to adjust the noise reduction level.
 - "NR" appears when the noise reduction is set to ON.

• Auto notch filter (p. 52)

- ➔ Push [A/NOTCH] to turn the auto or manual notch filter ON and OFF.
 - Rotate [NOTCH] control to set the attenuating frequency for manual notch operation.

• VSC (voice squelch control) (p. 53)

- ➔ While \blacksquare is selected with [MENU], push [F5 VSC] to turn the VSC function ON and OFF.
 - The VSC indicator appears when the voice squelch function is set to ON.

◇ Convenient functions for transmit

• Speech compressor (p. 57)

- ➔ While \blacksquare is selected with [MENU], push [F3 COMP] to turn the speech compressor ON and OFF.
 - "COMP" appears when the speech compressor is set to ON.

• VOX (voice operated transmit) (p. 54)

- ➔ Push [VOX/BK-IN] to turn the VOX function ON and OFF.
 - "VOX" appears when the VOX function is set to ON.

• Transmit quality monitor (p. 56)

- ➔ Push [MONITOR] to turn the monitor function ON and OFF.
 - "MONI" appears when the monitor function is set to ON.

• Audio tone control (p. 88)

- ➔ While \blacksquare is selected with [MENU], push [F4 TON], select an item with [F1 \blacktriangle] and [F2 \blacktriangledown] then rotate the tuning dial to adjust the audio tone.

◆ Tone squelch operation

Tone squelch operation is a method of communications using selective calling. Only received signals having a matching tone will open the squelch. Before communicating using tone squelch, all members of your party must agree on the tone squelch frequency to use.

- ① Push [AM/FM] to select FM mode.
- ② Push [MENU] several times to select M1.
- ③ Push [F4 TON] several times to turn the tone squelch function ON.
 - “TSQL” appears
- ④ Push [F4 TONE] for 1 sec. to enter tone frequency set mode.
- ⑤ Push [F1 TON] several times until TSQL Tone appears, if necessary.
 - Push [F3] for 1 sec. to select the default frequency.
- ⑥ Rotate the tuning dial to select the desired tone squelch frequency.
- ⑦ Push [MENU] to return to M1.
- ⑧ Communicate in the usual manner.

• Available tone squelch frequencies (Unit: Hz)

67.0	85.4	107.2	136.5	165.5	186.2	210.7	254.1
69.3	88.5	110.9	141.3	167.9	189.9	218.1	
71.9	91.5	114.8	146.2	171.3	192.8	225.7	
74.4	94.8	118.8	151.4	173.8	196.6	229.1	
77.0	97.4	123.0	156.7	177.3	199.5	233.6	
79.7	100.0	127.3	159.8	179.9	203.5	241.8	
82.5	103.5	131.8	162.2	183.5	206.5	250.3	

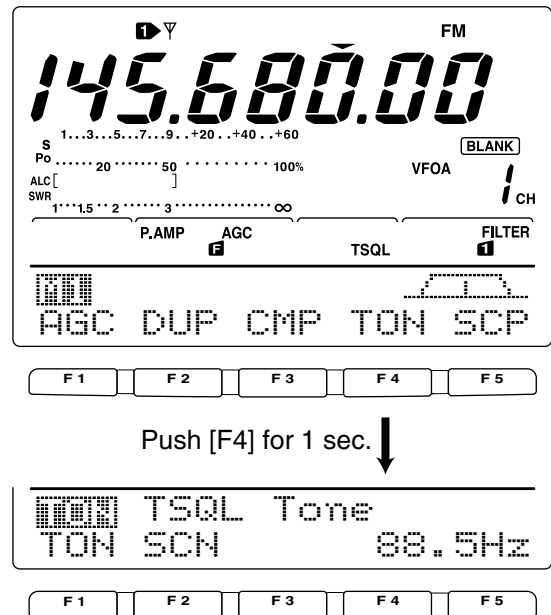

◆DTCS operation

DTCS function is an another method of communications using selective calling. Only received signals having a matching 3-digit code will open the squelch.

- ① Push [AM/FM] to select FM mode.
- ② Push [MENU] several times to select M1.
- ③ Push [F4 TON] several times to turn the DTCS function ON.
 - “DTCS” appears
- ④ Push [F4 TON] for 1 sec. to enter tone frequency set mode.
- ⑤ Push [F1 TON] several times until DTCS Code appears, if necessary.
- ⑥ Rotate the tuning dial to select the desired DTCS code number and push [F5] to select the desired code polarity.
 - NR : Normal polarity is used for both transmit and receive.
 - RR : Normal polarity is used for transmit, reversed polarity is used for receive.
 - FR : Reversed polarity is used for transmit, normal polarity is used for receive.
 - RR : Reversed polarity is used for both transmit and receive.
- Push [F3] for 1 sec. to select the default code and polarity.
- ⑦ Push [MENU] to return to M1.
- ⑧ Communicate in the usual manner.

•Available tone codes

023	072	152	244	311	412	466	631
025	073	155	245	315	413	503	632
026	074	156	246	325	423	506	654
031	114	162	251	331	431	516	662
032	115	165	252	332	432	523	664
036	116	172	255	343	445	526	703
043	122	174	261	346	446	532	712
047	125	205	263	351	452	546	723
051	131	212	265	356	454	565	731
053	132	223	266	364	455	606	732
054	134	225	271	365	462	612	734
065	143	226	274	371	464	624	743
071	145	243	306	411	465	627	754

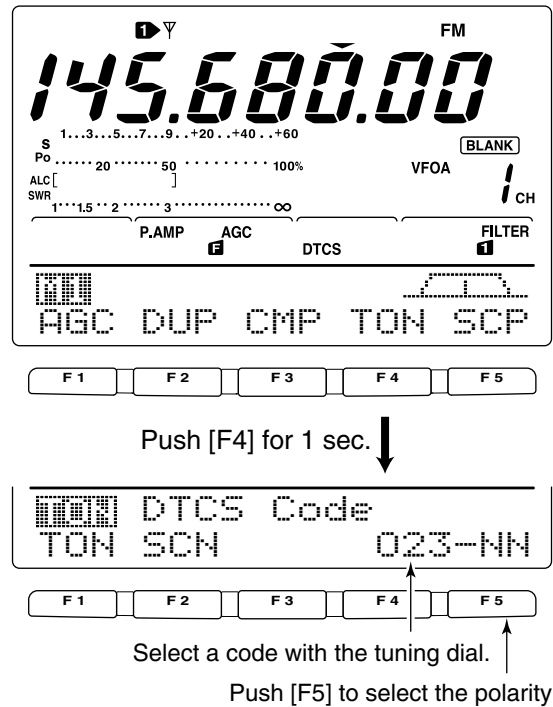

■ Repeater operation

A repeater amplifies received signals and retransmits them at a different frequency. When using a repeater, the transmit frequency is shifted from the receive frequency by an offset frequency. A repeater can be accessed using split frequency operation with the shift frequency set to the repeater's offset frequency.

- ① Push a band key to select the desired band.
- ② Push [A/B] to select VFO A.
- ③ Push [AM/FM] to select FM.
 - Pushing [AM/FM] toggles between AM and FM.
- ④ Rotate the tuning dial to set the repeater transmit frequency.
- ⑤ While **M1** is selected, push [F2 **DUP**] several times to set the offset direction.
 - "DUP-" or "DUP+" appears
 - 0.100 MHz for HF, 0.500 MHz for 50 MHz and 0.600 MHz for 144 MHz band is set by default in set mode. (p. 83)
- ⑥ Push [F4 **TON**] to turn the repeater tone ON.
 - "T" appears.
 - Set the tone frequency in tone frequency set mode in advance, if desired. (p. 45) 88.5 Hz is set by default. To transmit a 1750 Hz European repeater tone, push [F4 **TON**] while transmitting.
- ⑦ Communicate in the normal way.

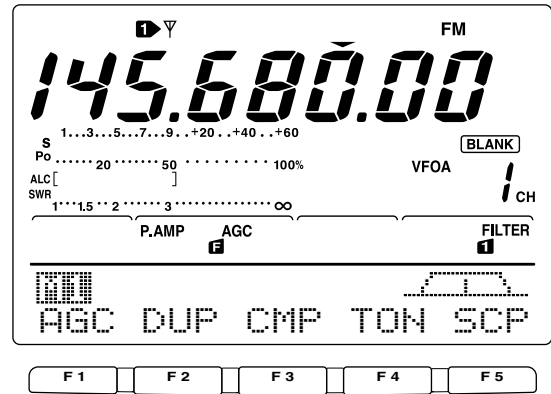

↓ Push [F2], [F4] ↓

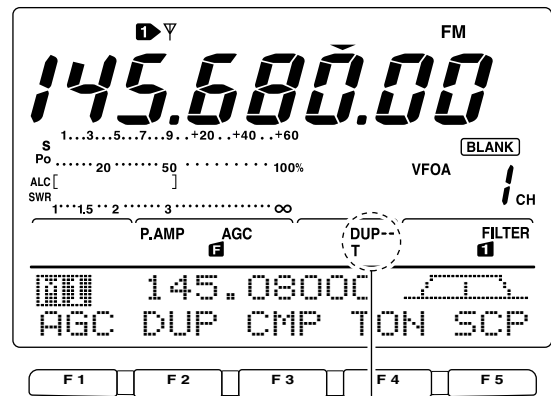

Appears

◆ One-touch repeater function

This function allows you to set repeater operation with push of one switch.

- ➔ To set the transceiver for repeater operation using the one-touch repeater function, follow the steps ① to ④ as above, then push [F2 **DUP**] for 1 sec.

/// Set the offset shift direction and frequency in advance (p. 82) as well as the tone frequency (see p. 45).

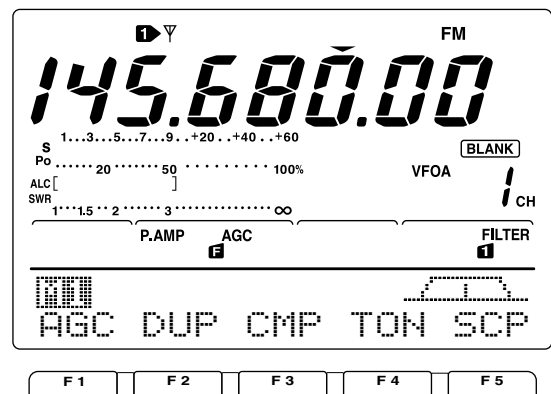

↓ Push [F2] for 1 sec.

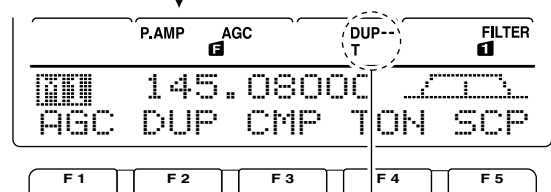

Appears

◆ **Transmit frequency monitor check**

You may be able to receive the other party's transmit signal directly without having to go through a repeater. This function allows you to check this.

- ➔ While receiving, push and hold [XFC] to see if you can receive the other party's transmit signal directly.
 - While holding [XFC], the offset direction and frequency are displayed on the multi-function switch indicator.

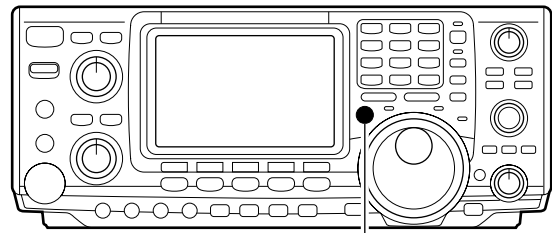

[XFC]



◆ **Repeater tone frequencies**

The transceiver's repeater tone frequency is set to 88.5 Hz by default. This can be changed if desired.

- ① While M1 is selected, push [F4 TON] to turn the tone encoder ON.
 - "T" appears.
- ② Push [F4 TON] for 1 sec. to select the tone frequency set mode.
- ③ Push [F1 TON] several times to select Rptr Tone, if necessary.
- ④ Rotate the tuning dial to select the desired frequency. (see the table at right)
- ⑤ Push [MENU] to return to M1.

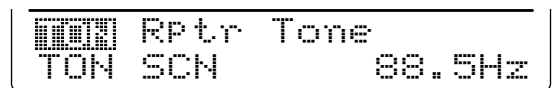

• **Available tone frequencies**

(Unit: Hz)

67.0	85.4	107.2	136.5	165.5	186.2	210.7	254.1
69.3	88.5	110.9	141.3	167.9	189.9	218.1	
71.9	91.5	114.8	146.2	171.3	192.8	225.7	
74.4	94.8	118.8	151.4	173.8	196.6	229.1	
77.0	97.4	123.0	156.7	177.3	199.5	233.6	
79.7	100.0	127.3	159.8	179.9	203.5	241.8	
82.5	103.5	131.8	162.2	183.5	206.5	250.3	

◆ **Storing a non standard repeater**

- ① Turn the auto repeater function OFF in the set mode. (p. 83)
- ② Push [AM/FM] to select FM mode.
- ③ Push [V/M], then [A/B] to select VFO A.
- ④ Rotate the tuning dial to set the repeater output frequency.
 - Set the tuning step if desired.
- ⑤ Push [A/B] to select VFO B.
- ⑥ Rotate the tuning dial to set the repeater input frequency.
- ⑦ Push [A/B] to select VFO A.
- ⑧ Push [SPLIT] to turn the split function ON.
- ⑨ Push [F4 TON] to turn the previously set tone encoder ON.
- ⑩ Rotate [M-CH] to select the desired memory channel.
 - "BLANK" appears when a blank channel is selected.
- ⑪ Push [MW] for 1 sec. to store the contents in the selected memory channel.

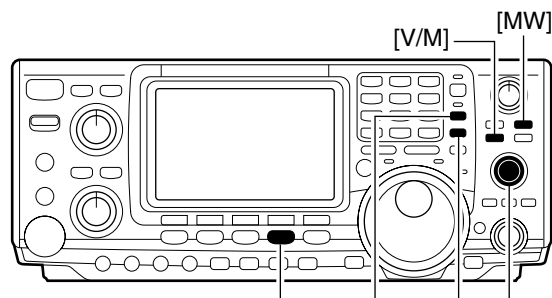





[AM/FM] [SPLIT] [A/B] [M-CH]

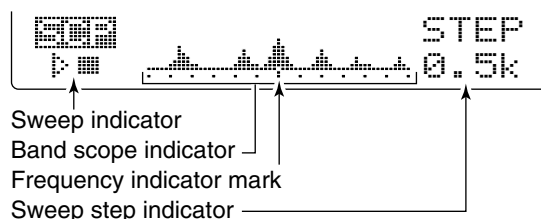

Simple band scope

The band scope function allows you to visually check signal conditions around a specified frequency. The IC-7400's band scope function can be used in any operating mode and frequency band.



INDICATOR	DESCRIPTION
Sweep	While the band scope is “sweeping,” “  ” appears; while stopped “  ” appears. Received audio is not emitted from the speaker while the band scope is “sweeping.”
Band scope indicator	Indicates the relative strength of signals and their location in relation to the center (displayed) frequency. Signal strength is relative to the S-meter level, S1 to S9, with each vertical dot in the band scope indicator equal to one segment of the S-meter. Signal activity is measured ± 30 steps from the center frequency with each step equal to the selected sweep step.
Frequency indicator mark	After a sweep, indicates the relative position of the selected frequency. When the selected frequency is outside of the sweep range, “  ” or “  ” indicator flashes. After changing the frequency, push [F3] for 1 sec. to automatically return to the center frequency.
Sweep step	Indicates the selected sweep step. 0.5, 1, 2, 5, 10, 20 and 25 kHz are selectable. Each dot of the band scope indication is approx. equal to the selected sweep step.

The band scope measures receive signal conditions over a specified range on either side of a selected frequency in either VFO or memory modes.

- ① Rotate the tuning dial to tune a frequency.
- ② While **M1** is selected, push [F5 **SOP**] to select the band scope menu.
 - Starts sweeping automatically with the previously selected sweeping step.
 - During sweep, received signals cannot be heard.
- ③ Push [F5 **STEP**] several times to select the desired sweep step.
- ④ Push [F1] to start sweeping, then stop automatically after sweeping.
 - Push [F1] for 1 sec. to start continuous sweeping. In this case, it is necessary to push [F1] to stop sweeping.
 - During sweep operation “” appears and received signals cannot be heard.
 - If there is a lot of signal noise, turn the preamp OFF and the attenuator ON to reduce the signal input level and improve the readability of the band scope.
- ⑤ When rotating the tuning dial and you finding a signal you wish to communicate on, then just communicate in the normal way.
 - If you want to return to the previous frequency (before rotating the tuning dial), push [F3] for 1 sec.
 - If the selected frequency is set outside of the swept range, “” or “” flashes.
- ⑥ While receiving, if you want to update the band conditions, repeat steps ③ and ④ as above.

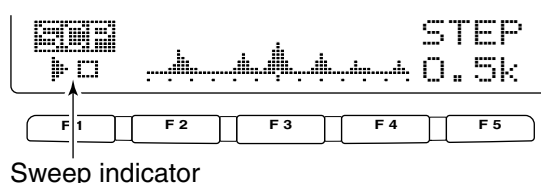
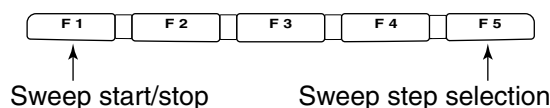
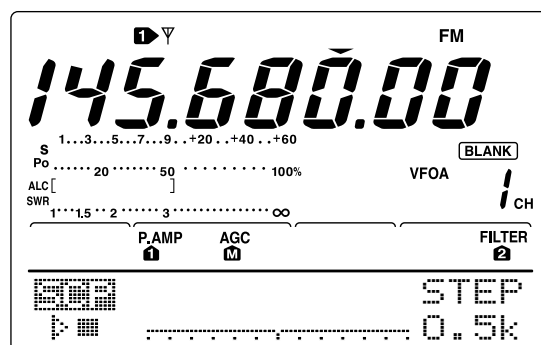

■ Preamp/Attenuator

The preamp amplifies received signals in the front end circuit to improve the S/N ratio and sensitivity. Set this to preamp 1 or preamp 2 when receiving weak signals. The attenuator prevents a desired signal from distortion when very strong signals are near the desired frequency or when very strong electric fields, such as from broadcasting stations, are near your location. These can both set independently for each band.

- ➔ Push [P.AMP/ATT] several times to set the preamp OFF, preamp 1 ON or preamp 2 ON.
 - When the preamp is ON, either “P.AMP 1” or “P.AMP 2” appears in the function display.
 - When operating on the 144 MHz band, the preamp can only be set to ON or OFF only— there is no preamp 1 and preamp 2.

P.AMP 1	Regular preamp, the most effective for 1.8 to 21 MHz bands without IMD corruption.
P.AMP 2	High-gain preamp, the most effective for 24 to 50 MHz bands.
P.AMP	Preamp activates for the VHF band (144 to 146 MHz range; 108 to 174 for the USA version).

- ➔ Push [P.AMP/ATT] for 1 sec. to set the attenuator ON.
 - “ATT” appears in the display when the function is set ON.
 - Push [P.AMP/ATT] momentarily to set the attenuator OFF.

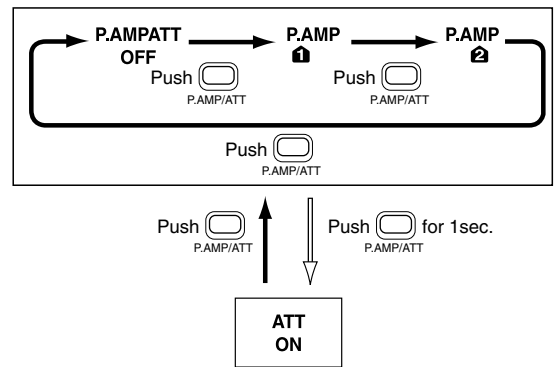
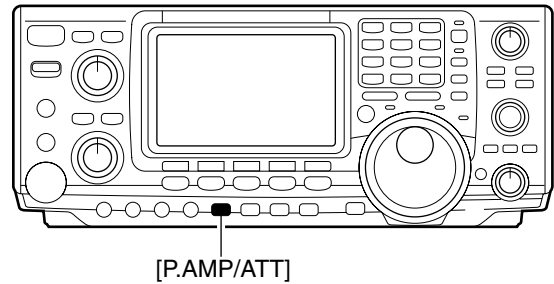

Regarding the use of the “P.AMP 2”

The “P.AMP 2” is a high gain receive amplifier. When the “P.AMP 2” is used during times of strong electric fields, distortion sometimes results. In such cases, use the transceiver with the “P.AMP 1” or “P.AMP OFF” setting.

The “P.AMP 2” is most effective when:

- Used on bands above 24 MHz and when electric fields are weak.
- Receive sensitivity is insufficient during low gain, or while using a narrow band antenna (such as small loop, a Beverage antenna or a short Yagi antenna, etc.) is used.

■ RIT function

The RIT (Receive Increment Tuning) function compensates for off-frequencies of the communicating station. The function shifts the receive frequency up to ±9.99 kHz in 10 Hz steps without moving the transmit frequency.

•See 30 on p. 4 for function description.

- ① Push [RIT] to turn the RIT function ON and OFF.
 - “RIT” and the shifting frequency appear when the function is ON.
- ② Rotate the [RIT/ΔTX] control.
 - Push [CLEAR] for 1 sec. to reset the RIT frequency.
 - Push [CLEAR] momentarily to reset the RIT frequency when the quick RIT clear function is ON. (p. 86)
 - Push [RIT] for 1 sec. to add the shift frequency to the operating frequency.

◆ RIT monitor function

When the RIT function is ON, pushing and holding [XFC] allows you to monitor the operating frequency directly (RIT is temporarily cancelled).

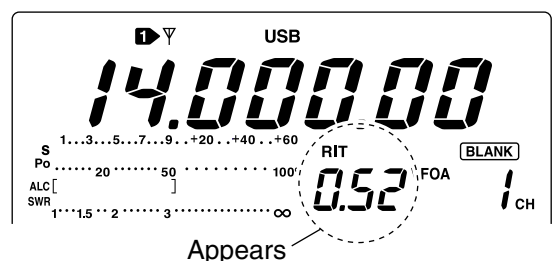
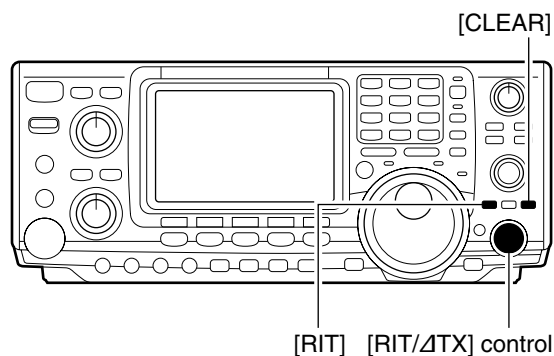

■ AGC function

The AGC (auto gain control) controls receiver gain to produce a constant audio output level even when the received signal strength is varied by fading, etc.

The transceiver has 3 AGC characteristics (time constant; fast, mid, slow) for non-FM modes.

▨ The FM mode AGC time constant is fixed as 'FAST' (0.1 sec.) and AGC time constant cannot be selected.

◇ AGC speed selection

- ① Select a non-FM mode.
- ② While M1 is selected, push [F1 AGC] several times to select AGC F, AGC M, AGC S or AGC OFF.

▨ "AGC OFF" appears when AGC time constant OFF is set with one of FAST, MID or SLOW setting in AGC set mode.

◇ Setting the AGC time constant

- ① Select the desired mode other than FM mode.
- ② While M1 is selected, push [F1 AGC] for 1 sec. to enter AGC set mode.
- ③ Push one of [F2 FAST], [F3 MID] or [F4 SLOW] to select the desired AGC speed to be set.
 - An underline appears below the time constant indication.
- ④ Rotate the tuning dial to set the desired time constant.
 - AGC time constant can be set between 0.1 to 8.0 sec. (depends on mode) or turned OFF.
 - Push [F2 FAST], [F3 MID] or [F4 SLOW] for 1 sec. to select a default value each for fast, mid. and slow, respectively.
- ⑤ Select another mode other than FM. Repeat steps ③ and ④ if desired.
- ⑥ Push [MENU] to exit the AGC set mode.

• Selectable AGC time constant (unit: sec.)

Mode	Default	Selectable AGC time constant
SSB	0.3 (FAST)	OFF, 0.1, 0.2, 0.3, 0.5, 0.8, 1.2, 1.6 2.0, 2.5, 3.0, 4.0, 5.0, 6.0
	2.0 (MID)	
	6.0 (SLOW)	
CW	0.1 (FAST)	OFF, 0.1, 0.2, 0.3, 0.5, 0.8, 1.2, 1.6 2.0, 2.5, 3.0, 4.0, 5.0, 6.0
	0.5 (MID)	
	1.2 (SLOW)	
RTTY	0.1 (FAST)	OFF, 0.1, 0.2, 0.3, 0.5, 0.8, 1.2, 1.6 2.0, 2.5, 3.0, 4.0, 5.0, 6.0
	0.5 (MID)	
	1.2 (SLOW)	
AM	3.0 (FAST)	OFF, 0.3, 0.5, 0.8, 1.2, 1.6, 2.0, 2.5 3.0, 4.0, 5.0, 6.0, 7.0, 8.0
	5.0 (MID)	
	7.0 (SLOW)	
FM	0.1 (FAST)	Fixed

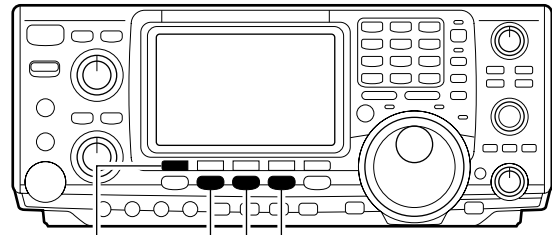

[F1 AGC] Mode switches

- AGC **M** : Medium AGC speed
- AGC **S** : Slow AGC speed
- AGC **F** : Fast AGC speed
- AGC-OFF : AGC is not activated

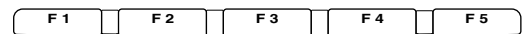
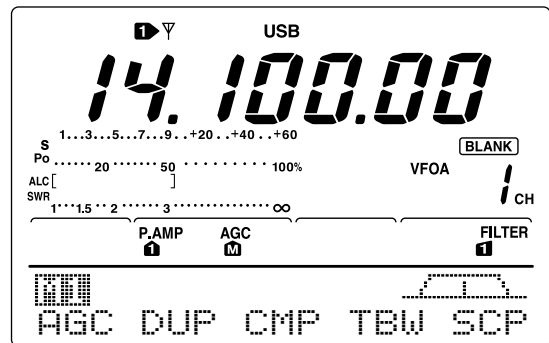

Appears under the selected AGC Selected mode speed's time constant indication.

• When AGC fast is selected

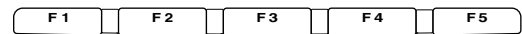
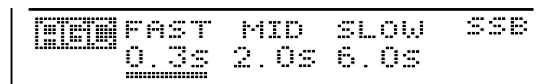

Push [F2] for 1 sec. to select the default value in this case.

IF filter selection

The transceiver has 3 passband width IF filters for each mode.

For SSB and CW modes, the passband width can be set within 50 to 3600 Hz in 50 or 100 Hz steps. A total of 41 passband widths are available.

For RTTY mode, the passband width can be set within 50 to 2700 Hz in 50 or 100 Hz steps. A total of 32 passband widths are available.

For AM and FM modes, the passband width is fixed and 3 passband widths are available independently.

▨ The filter selection is automatically memorized in each mode.

▨ The PBT shift frequencies are automatically memorized in each filter.

IF filter selection

- ① Select the desired mode.
- ② For RTTY mode, turn OFF the RTTY filter.
- ③ Push [FILTER] several times to select the IF filter **1**, **2** or **3**.
 - The selected passband width and filter number is displayed in the LCD.

▨ By pushing [PBTC], the set filter passband width, “**B**,” and shifting value “**S**” is indicated.

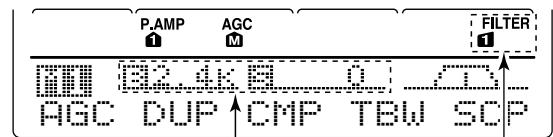
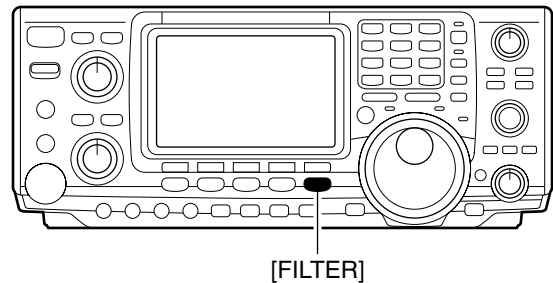

The selected filter width is indicated for approx. 1 sec. when [FILTER] is pushed. Filter selection

Filter passband width setting (SSB, CW and RTTY mode only)

- ① Select SSB, CW or RTTY mode.
 - Passband widths for AM and FM modes are fixed and cannot be set.
- ② For RTTY mode, turn OFF the RTTY filter.
- ③ Push [FILTER] for 1 sec. to enter filter set mode.
- ④ Push [FILTER] several times to select the desired IF filter number.
- ⑤ While pushing [F1 BW], rotate the tuning dial to set the desired passband width.
 - In SSB and CW modes, the passband width can be set within the following range.

50 to 500 Hz	50 Hz steps
600 to 3600 Hz	100 Hz steps
 - In RTTY mode, the passband width can be set within the following range.

50 to 500 Hz	50 Hz steps
600 to 2700 Hz	100 Hz steps
 - Push [F-3] for 1 sec. to select the default value.
- ⑥ Repeat steps ④ to ⑤ if desired.
- ⑦ Push [MENU] to exit the filter set mode.

▨ The PBT shift frequencies are cleared when the passband width is changed.

▨ This filter set mode screen graphically displays the PBT shift frequencies and CW pitch operations.

Filter set mode indication

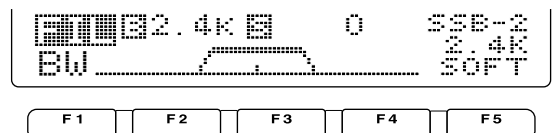

Shows the selected filter and passband width.

Indication while setting

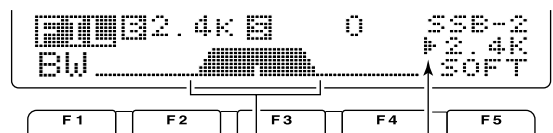

Reverses Appears
While pushing [F1 BW], rotate the tuning dial to set passband width.

IF (DSP) filter shape

The type of IF (DSP) filter shape for SSB and CW can be selected independently from soft and sharp.

- ① Push [SSB] or [CW/RTTY] to select SSB, CW or RTTY mode.
- ② Select the filter set mode.
 - Push [FILTER] for 1 sec.
 - Operating mode can be selected in this step.
- ③ Push [FILTER] several times to select the desired IF filter.
- ④ Push the [F5] to select the filter shape from "SOFT" and "SHARP."
- ⑤ Push [MENU] to exit the set mode.

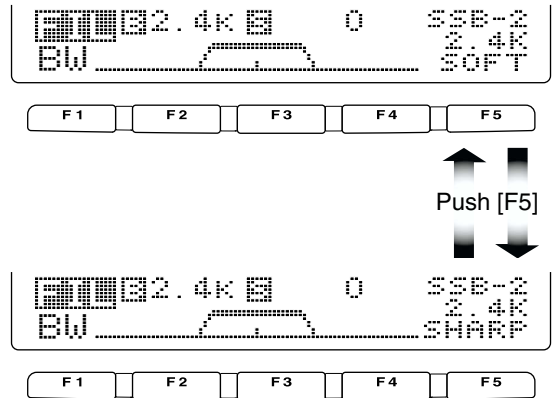

Noise blanker

The noise blanker eliminates pulse-type noise such as from car ignitions. The noise blanker is not available for FM mode.

- ① Push [NB] to turn the noise blanker ON.
 - [NB] indicator appears.
- ② Push [NB] for 1 sec. to enter the NB level set mode.
- ③ Rotate the tuning dial to adjust the noise blanker level.
 - Noise blanker level is indicated with bar meter and digit in '%.'
- ④ Push [NB] to exit the noise blanker set mode.
- ⑤ Push [NB] to turn the noise blanker OFF.
 - [NB] indicator disappears.

When using the noise blanker, received signals may be distorted if the noise blanker level setting has been too high.

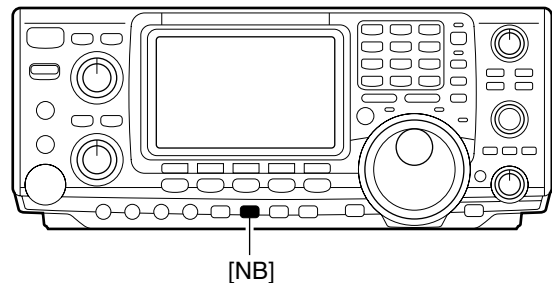

"NB" appears while noise blanker is activated.

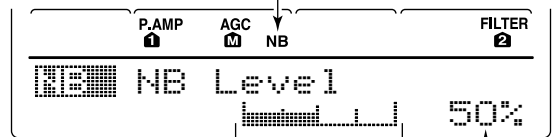

Shows noise blanker level

Meter peak hold function

The S-meter has a peak level holding function. The peak level of the received signal strength is indicated for 0.5 sec. (approx.). This function can be deactivated in set mode if desired. (p. 81)

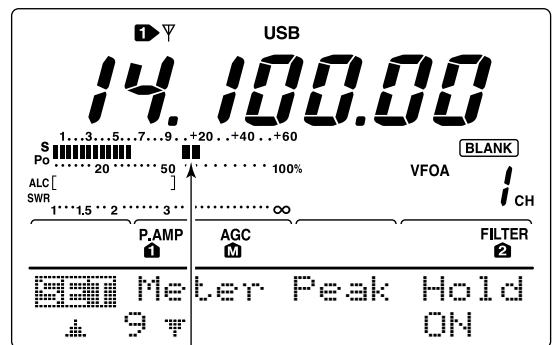

Shows peak level for approx. 0.5 sec.

■ Twin PBT operation

General PBT (Passband Tuning) function electronically narrows the IF passband width by shifting the IF frequency to slightly outside of the IF filter passband to reject interference. This transceiver uses the DSP circuit for the PBT function. Moving both [TWIN PBT] controls to the same position shifts the IF.

- The LCD shows the passband width and shift frequency graphically.
- Push [FILTER] for 1 sec. to enter the filter set mode. Current passband width and shift frequency is displayed in the filter set mode screen.
- To set the [TWIN PBT] controls to the center positions, push [PBTC] for 1 sec.

The variable range depends on the passband width and mode. The edge of the variable range is half of the passband width, and PBT is adjustable in 25 or 50 Hz steps. These controls function as an IF shift control while in AM mode and when the RTTY filter is turned ON. Only the inner control may function in this case. IF shift is adjustable in 20/40 Hz steps in RTTY (RTTY filter is turned ON) or 150/300/500 Hz steps in AM.

- [TWIN PBT] should normally be set to the center positions (PBT setting is cleared) when there is no interference.
- NOTE:** In the “center” PBT position on CW, it is normal for the graphic display’s center line to be slightly to the left side of PBT envelope, if a CW filter selection of 800 Hz or above is selected.
- When PBT is used, the audio tone may be changed.
- Not available for FM mode.
- For AM and RTTY (with RTTY filter ON) modes, [TWIN PBT] inner control only can be activated, and functions as an IF shift function.
- While rotating [TWIN PBT], noise may occur. This comes from the DSP unit and does not indicate an equipment malfunction.
- By pushing [PBTC] momentarily indicates the passband width, “B,” and shifting value, “S,” of the filter being used.

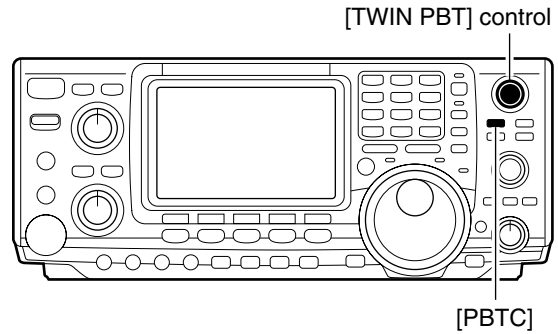

Passband width and shifting value are indicated while [TWIN PBT] is operated.
Appears when PBT is used.

• Filter set mode indication

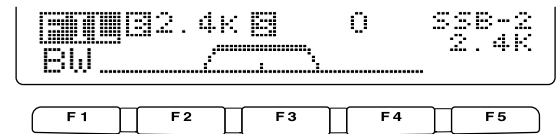

Shows the selected filter and passband width.

• Indication while PBT setting

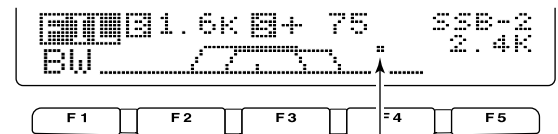

Appears when passband is shifted.
*By pushing [PBTC] for 1 sec., the shifted value returns to the default setting, and the “dot” disappears.

PBT OPERATION EXAMPLE

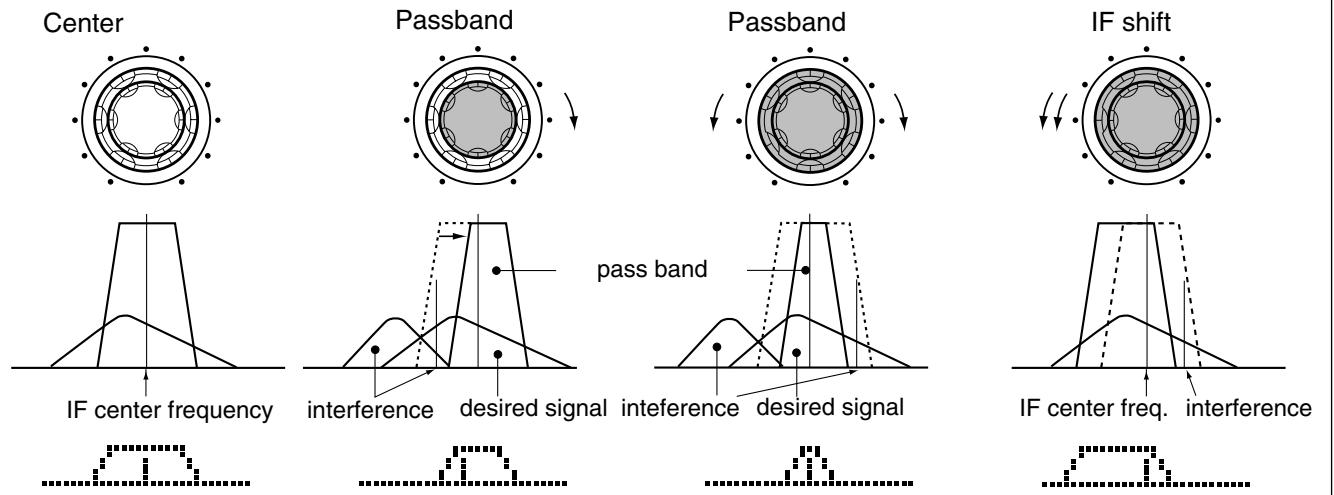

■ Noise reduction

The noise reduction function reduces noise components and picks out desired signals which are buried in noise. The received signals are converted to digital signals and then the desired signals are separated from the noise.

- ① Push the [NR] switch to turn the noise reduction ON.
 - “NR” appears.
- ② Rotate the [NR] control to adjust the noise reduction level.
- ③ Push the [NR] switch to turn the noise reduction OFF.
 - “NR” disappears.

▨ Deep rotation of the [NR] control results in audio signal masking or distortion. Set the [NR] control for maximum readability.

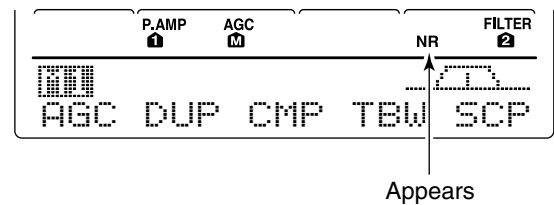
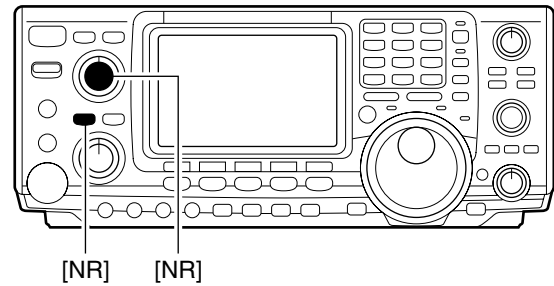

■ Notch function

This transceiver has auto and manual notch functions. The auto notch function automatically attenuates more than 3 beat tones, tuning signals, etc., even if they are moving. The manual notch can be set to attenuate a frequency via the [NOTCH] control.

- ➔ Push [A/NOTCH] to toggle the notch function between auto, manual and OFF in SSB and AM modes.
- ➔ Push [A/NOTCH] to turn the manual notch function ON and OFF in CW mode.
- ➔ Push [A/NOTCH] to turn the auto notch function ON and OFF in FM mode.
 - Set to attenuate a frequency for manual notch via the [NOTCH] control.
 - “A NOTCH” appears when auto notch is in use.
 - “NOTCH” appears when manual notch is in use.

▨ While operating the manual notch, noise may be heard. This comes from the DSP unit and does not indicate an equipment malfunction.

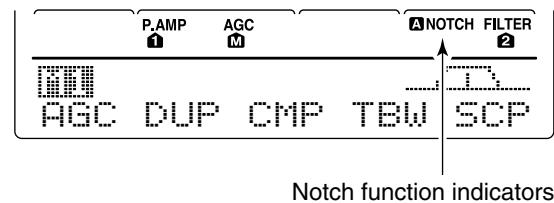
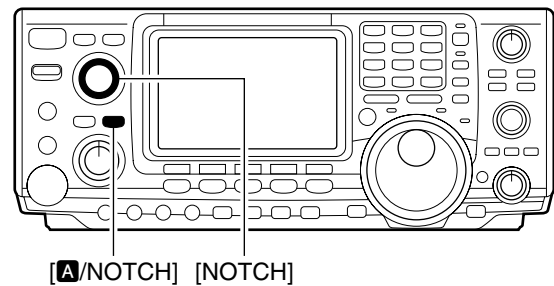

■ Dial lock function

The dial lock function prevents accidental changes caused by the tuning dial.

- ➔ Push [LOCK/SPCH] to turn the dial lock function ON and OFF.
 - “LOCK” indicator lights while the dial lock function is activated.

Lights while the dial lock function is activated.

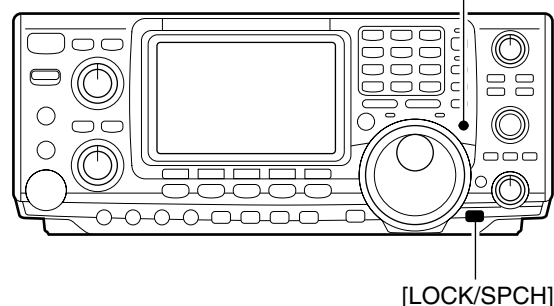

■ Voice squelch control function

This function is useful when you don't want unmodulated signals. When the voice squelch control function is activated, the receiver checks received signals for voice components.

If a receiver signal includes voice components, and the tone of the voice components changes within 1 sec., squelch opens. If the received signal includes no voice components or the tone of the voice components does not change within 1 sec., squelch closes.

- While M2 is selected with [MENU], push [F5 VSC] to switch the VSC (Voice Squelch Control) function ON and OFF.
 - “VSC” appears when the function is activated.

- ▨•The VSC function activates for phone modes (SSB, AM and FM).
- ▨•The VSC function can also be used for scanning operation in AM or FM mode (p. 69).

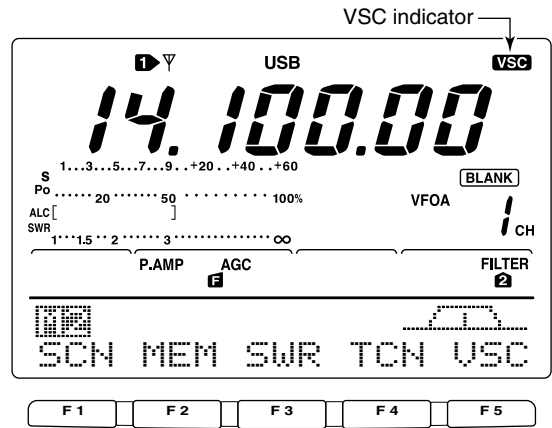

Push [F5] to turn the VSC function ON and OFF.

■ VOX function

The VOX (Voice-Operated Transmission) function switches between transmit and receive with your voice. This function provides an opportunity to input log entries into your computer, etc., while operating.

•Using the VOX function

- ① Select a phone mode (SSB, AM, FM).
- ② Push [VOX/BK-IN] to turn the VOX function ON or OFF.

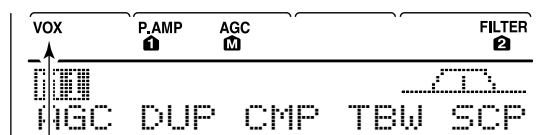
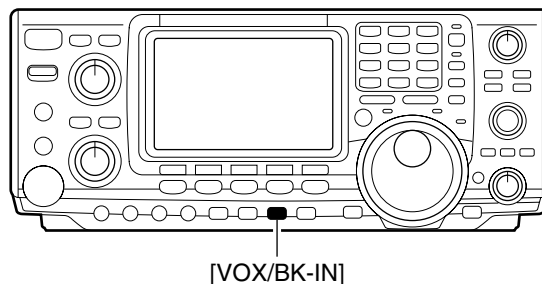

Appears

◇ Adjusting the VOX function

- ① Select a phone mode (SSB, AM, FM).
- ② Push [VOX/BK-IN] to turn VOX function ON.
- ③ Push [VOX/BK-IN] for 1 sec. to enter VOX set mode.
- ④ Select the VOX Gain item using [F1 ▲] or [F2 ▼].
- ⑤ While speaking into the microphone, rotate the tuning dial to the point where the transceiver is continuously transmitting.
 - Push [F3] for 1 sec. to select the default value.
- ⑥ Push [F2 ▼] to select Anti-VOX item.
- ⑦ While receiving, rotate the tuning dial to the point where the transceiver does not switch to transmit with the speaker output.
 - Push [F3] for 1 sec. to select the default value.
- ⑧ Push [F2 ▼] to select VOX Delay item.
 - Select the VOX delay item using the tuning dial.
 - Push [F3] to select the default value.
- ⑩ Push [MENU] to return to previous indication.

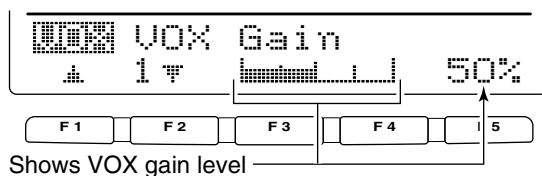

Shows VOX gain level

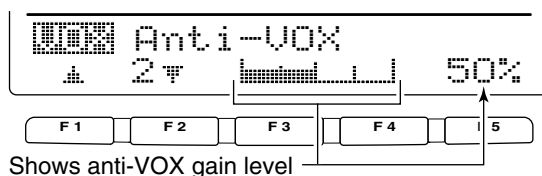

Shows anti-VOX gain level

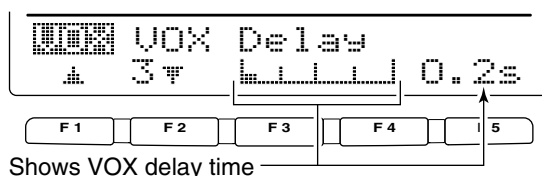

Shows VOX delay time

■ Break-in function

The break-in function is used in CW mode to automatically toggle the transceiver between transmit and receive when keying. The IC-7400 is capable for full break-in or semi break-in.

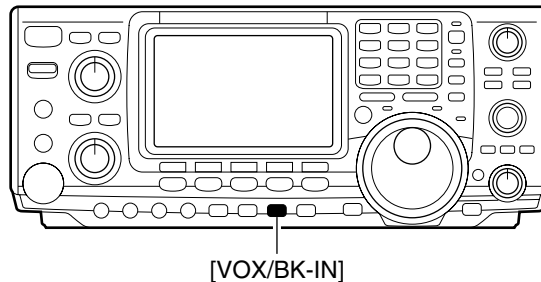

◆ Semi break-in operation

During semi break-in operation, the transceiver selects transmit when keying, then automatically returns to receive after a pre-set time from when you stop keying.

- ① Push [CW/RTTY] to select CW or CW-R mode.
- ② Push [VOX/BK-IN] several times to turn the semi break-in function ON.
 - “BK-IN” appears.
- ③ Set the break-in delay time (the delay from transmit to receive).
 - ➔ Push [VOX/BK-IN] for 1 sec. to select break-in delay program mode.
 - ➔ Rotate the tuning dial to select the desired delay.
 - Push [F3] for 1 sec. to select to the default value.
- ④ Push [MENU] to return to the previous menu.

When using a paddle, rotate [KEY SPEED] to adjust the keying speed.

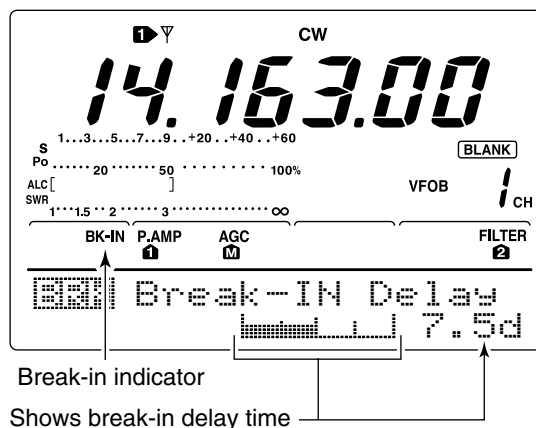

◆ Full break-in operation

During full break-in operation, the transceiver automatically selects transmit while keying and returns to receive immediately after keying is finished.

- ① Push [CW/RTTY] to select CW or CW-R mode.
- ② Push [VOX/BK-IN] several times to turn the full break-in function ON.
 - “**F**BK-IN” appears.

When using a paddle, rotate [KEY SPEED] to adjust the keying speed.

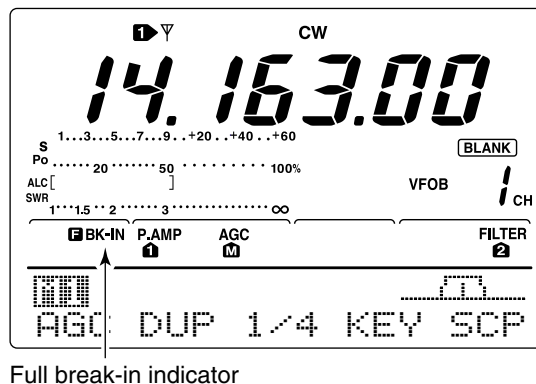

■ ΔTX function

The ΔTX function shifts the transmit frequency up to ±9.99 kHz in 10 Hz steps without moving the receive frequency.

• See ② on p. 4 for function description.

- ① Push the [ΔTX] switch to turn the ΔTX function ON and OFF.
 - “ΔTX” and shift frequency appear when the function is ON.
- ② Rotate the [RIT/ΔTX] control.
 - To reset the ΔTX frequency, push [CLEAR] for 1 sec.
 - Push [CLEAR] momentarily to reset the ΔTX frequency when the quick RIT clear function is ON. (p. 85)
 - To add or subtract the ΔTX frequency to the displayed frequency, push [ΔTX] for 1 sec.

When RIT and ΔTX are ON at the same time, the [RIT/ΔTX] control shifts both the transmit and receive frequencies from the displayed frequency at the same time.

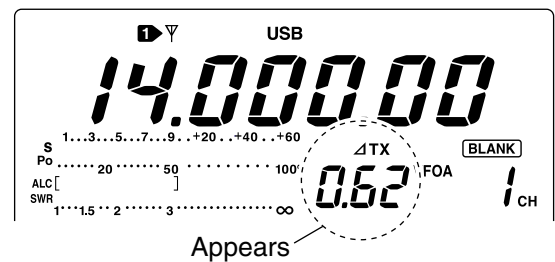
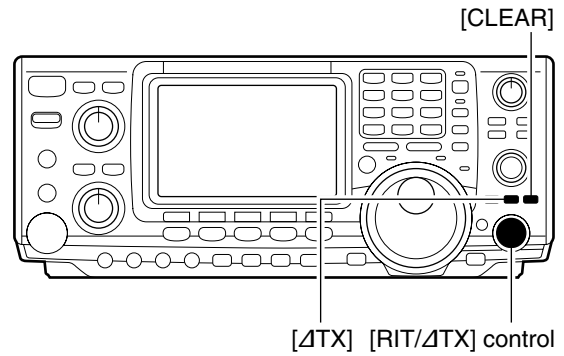

◇ ΔTX monitor function

When the ΔTX function is ON, pushing and holding [XFC] allows you to monitor the operating frequency directly (ΔTX is temporarily cancelled).

■ Monitor function

The monitor function allows you to monitor your transmit IF signals in any mode through the speaker. Use this to check voice characteristics while adjusting SSB transmit tones. (p. 88) The CW sidetone functions regardless of the [MONITOR] switch setting.

- ① Push [MONITOR] to switch the monitor function ON and OFF.
 - “MONI” appears when the monitor function is ON.
- ② Set the monitor level.
 - ➔ Push [MONITOR] for 1 sec. to select monitor program mode.
 - ➔ Rotate the tuning dial for the clearest audio output while pushing [PTT] and speaking into the microphone.
 - Push [F3] for 1 sec. to select the default value.
- ③ Push [MENU] to return to the previous menu.

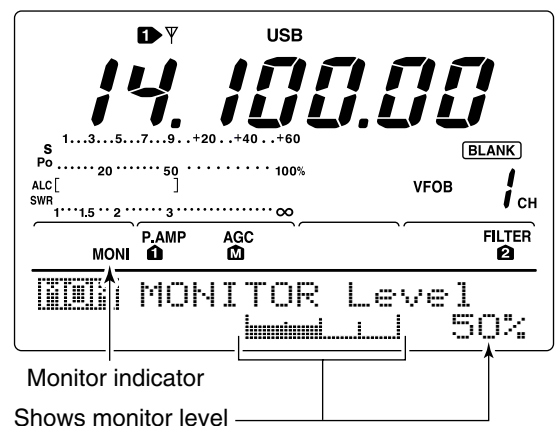
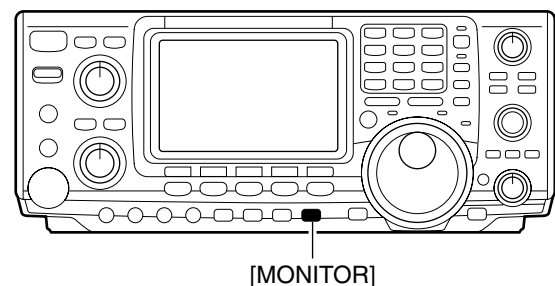

Speech compressor

The speech compressor increases average RF output power, improving signal strength and readability in SSB, AM or FM.

When adjusting the compression level, it is necessary to turn the COMP meter ON in the set mode, in advance (p. 81).

In SSB mode

- ① Select USB or LSB mode and adjust [MIC GAIN] to a suitable level.
- ② While M1 is selected, push [F3 COMP] to turn the speech compressor ON.
 - “COMP” appears.
- ③ Push [F3 COMP] for 1 sec. to select compression level set mode.
- ④ While speaking into the microphone, rotate the tuning dial, so that the COMP meter reads within the COMP zone with your normal voice level.
 - Push [F3] for 1 sec. to select the default value.
 - ▨ When the COMP meter peaks above the COMP zone, your transmitted voice may be distorted.
- ⑤ Push [MENU] to return to M1.

In AM/FM mode

- ① While M1 is selected, push [F3 COMP] to turn the speech compressor ON.
 - “COMP” appears.
- ② Push [F3 COMP] for 1 sec. and set the compression level as “1” in advance.
- ③ While speaking into the microphone, rotate [MIC GAIN], so that the COMP meter does not exceed the center dot whether you speak softly or loudly.
- ④ While speaking into the microphone, rotate the tuning dial, so that the COMP meter reads within the COMP zone with your normal voice level.
 - Push [F3] for 1 sec. to select the default value.
 - ▨ When the COMP meter peaks above the COMP zone, your transmitted voice may be distorted.
- ⑤ Push [MENU] to return to M1.

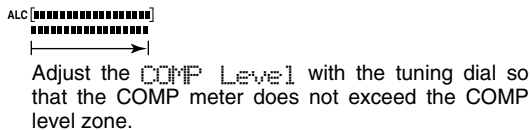
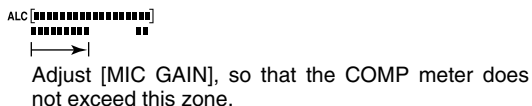
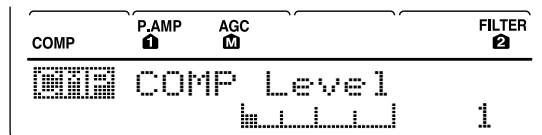
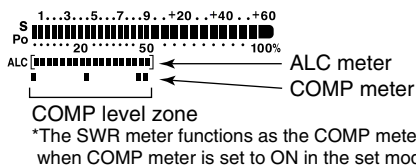
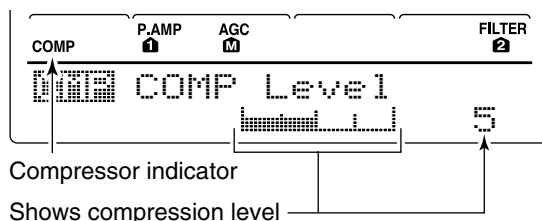

Transmit filter width selection (SSB mode only)

The transmit filter width for SSB mode can be selected from wide, middle and narrow.

- ① Select USB or LSB mode.
- ② Push [MENU] to select M1, if necessary.
- ③ Push [F4 TBW] for 1 sec. to select the transmission passband width.
 - One of “TX BU=WIDE,” “TX BU=MID” or “TX BU=NAR” is displayed for approx. 1 sec.
 - Transmit filter width:

NAR	2.2 kHz
MID	2.4 kHz
WIDE	2.8 kHz

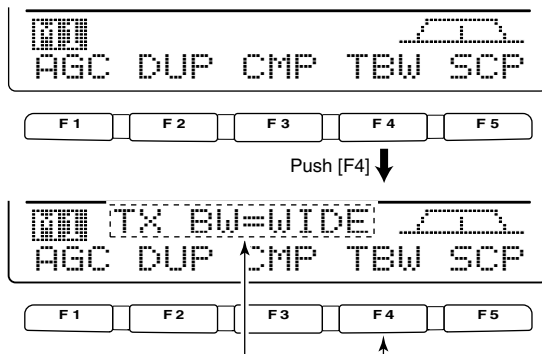

The selected transmit filter width is displayed for approx. 1 sec.
 Push [F4] for 1 sec. to select the transmit filter width.

Split frequency operation

Split frequency operation allows you to transmit and receive in the same mode on two different frequencies. The split frequency operation is basically performed using 2 frequencies in VFO A and VFO B.

The following is an example of setting 21.290 MHz for receiving and 21.310 MHz for transmitting.

- ① Set 21.290 MHz (USB) in VFO A.
- ② Push [SPLIT] to turn the split function ON, then push [A/B] for 1 sec.
 - The equalized transmit (VFO B) frequency and “SPLIT” appear on the LCD, and the [SPLIT] indicator lights.
- ③ While pushing [XFC] rotate the tuning dial to set the transmit frequency to 21.310 MHz.
 - The transmit frequency can be monitored while pushing [XFC].
- ④ Now you can receive on 21.290 MHz and transmit on 21.310 MHz.

To change the transmit and receive frequencies, push [A/B] to exchange the VFO A and VFO B.

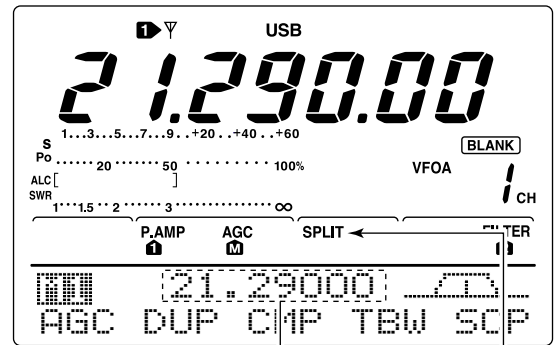
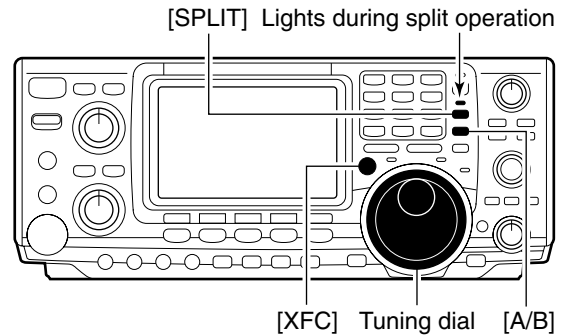

• While pushing [XFC]

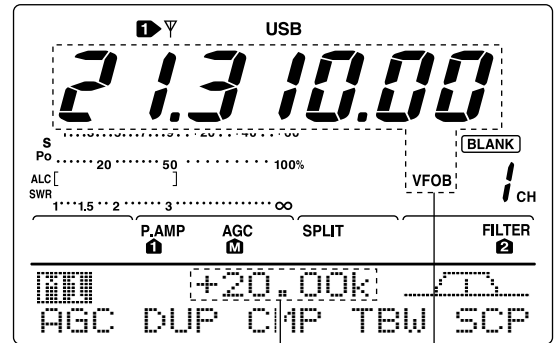

• After setting up

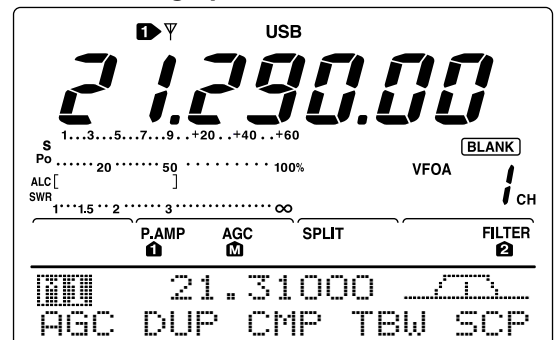

CONVENIENT

• Direct shift frequency input

The shift frequency can be entered directly.

- ① Push [F-INP].
- ② Enter the desired shift frequency with the digit keys.
 - 1 kHz to 1 MHz can be set.
 - When you require a minus shift direction, push [GENE •] in advance.
- ③ Push [SPLIT].
 - The shift frequency is input in the sub readout and the split function is turned ON.

[Example]

To transmit on 1 kHz higher frequency:

- Push [F-INP], [1.8 1] then [SPLIT].

To transmit on 3 kHz lower frequency:

- Push [F-INP], [GENE •], [7 3] then [SPLIT].

• Split lock function

Accidentally releasing the [XFC] switch while rotating the tuning dial changes the receive frequency. To prevent this, use both the split lock and dial lock functions to change the transmit frequency only. The split lock function cancels the dial lock function while pushing [XFC] during split frequency operation.

The dial lock's effectiveness during split frequency operation can be selected in the set mode for both receive and transmit frequencies; or only the receive frequency. (p. 82)

■ Quick split function

When you push the [SPLIT] switch for 1 sec., split frequency operation is turned ON, the undisplayed VFO is automatically changed according to the plus/minus shift frequency programmed in set mode (p. 83) or equalized when 0 kHz (default value) is programmed as the split shift frequency. Quick split operation is turned ON by default but can be turned OFF in set mode (p. 82).

- ① Suppose you are operating at 21.290 MHz (USB) in VFO A.
- ② Push [SPLIT] for 1 sec.
 - Split frequency operation is turned ON.
 - The VFO and VFO B are equalized.
- ③ While pushing [XFC], rotate the tuning dial to set the frequency offset between transmit and receive.
 - When [XFC] is released, the receive frequency is indicated.

◆ Split offset frequency setting

By setting an often-used split frequency offset in advance, you can use the quick split function to select split operation at the push of one switch.

Set the split offset frequency in advance in set mode (p. 82, item 12). The example at right shows the split offset is set to +0.020 MHz.

- ➔ Push [SPLIT] for 1 sec. to activate the quick split function.
- The transmit frequency is offset from the receive frequency according to the offset in set mode.

◆ Split lock function

The split lock function is convenient for changing only the transmit frequency. When the split lock function is not used, accidentally releasing [XFC] while rotating the tuning dial, changes the receive frequency. The split lock function is ON by default, but can be turned OFF in set mode.

- ① While split frequency operation is ON, push [LOCK/SPCH] to activate the split lock function.
- ② While pushing [XFC], rotate the tuning dial to change the transmit frequency.
 - If you accidentally release [XFC] while rotating the tuning dial, the receive frequency does NOT change.

• Setting the frequency while pushing [XFC]

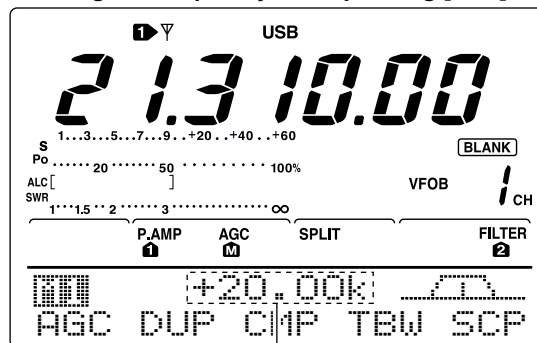

Shows shift frequency and direction

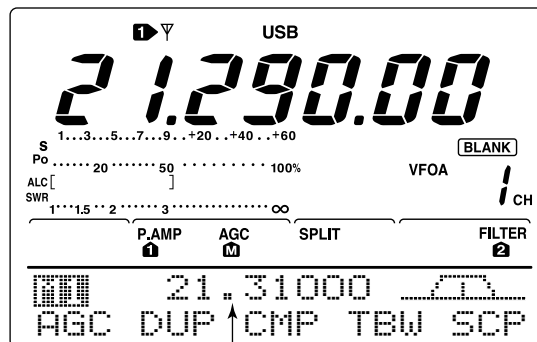

Shows transmit frequency for split operation

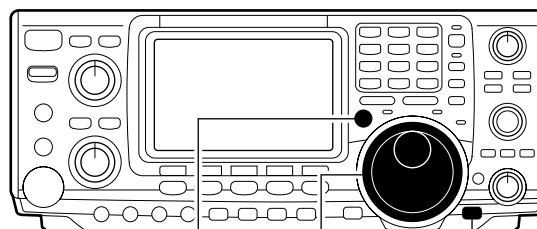
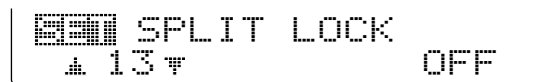

[XFC] Tuning dial [LOCK/SPCH]

■ Measuring SWR

The IC-7400 has a built-in circuit for measuring antenna SWR— no external equipment or special adjustments are necessary.

The IC-7400 can measure SWR in 2 ways— spot measurement and plot measurement are available.

◆ Spot measurement

- ① Push [TUNER] to turn the antenna tuner OFF.
- ② Turn the COMP meter OFF.
 - ➔ Push [MENU] for 1 sec. to enter set mode.
 - ➔ Push [F1 ▲] or [F2 ▼] several times to select the COMP Meter item.
 - ➔ Rotate the tuning dial to set the COMP meter OFF.
 - ➔ Push [MENU] to exit set mode.
- ③ Push [CW/RTTY] several times to select RTTY mode.
- ④ Push [TRANSMIT] or [PTT] on the microphone.
- ⑤ Rotate [RF PWR] clockwise past the 12 o'clock position for more than 30 W output power (30%).
- ⑥ Read the SWR on the SWR meter.
- ⑦ Push [TRANSMIT] or release [PTT] to receive.

▨ The built-in antenna tuner matches the transmitter to the antenna when the SWR is lower than 3:1.

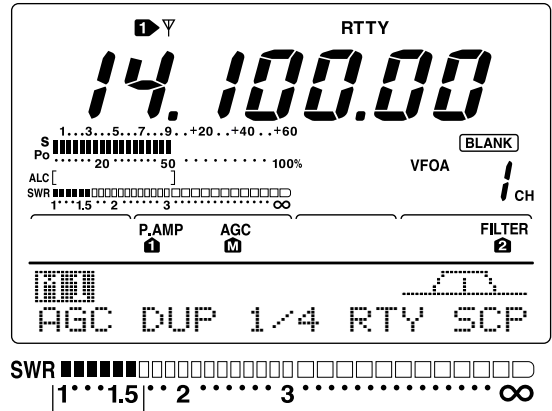

The best match is in this range.

◆ Plot measurement

Plot measurement allows you to measure the SWR over an entire band.

- ① While M_2 is selected with [MENU], push [F3 SWR].
 - SWR graph screen appears.
- ② Rotate [RF PWR] clockwise past the 12 o'clock position for more than 30 W output power (30%).
- ③ Set the center frequency for the SWR to be measured.
- ④ Push [F5] for 1 sec. several times to select the desired measuring step from 10, 50, 100 and 500 kHz.
- ⑤ Push [F3] several times to select the desired number of measuring steps from 3, 5, 7, 9, 11 and 13 steps.
- ⑥ Push [F1] to start the measuring.
- ⑦ Push [TRANSMIT] or push and hold [PTT] on the microphone to measure the SWR.
 - Frequency marker, “▲,” appears below SWR graph.
 - RTTY mode is automatically selected.
- ⑧ When pushing [TRANSMIT] again or releasing [PTT], the frequency marker and frequency indication move to the next frequency to be measured.
- ⑨ Repeat steps ⑦ and ⑧ to measure SWR over the entire frequency range.
- ⑩ When the measured SWR is less than 1.5:1, the antenna is well matched with the transceiver in the measured frequency range.

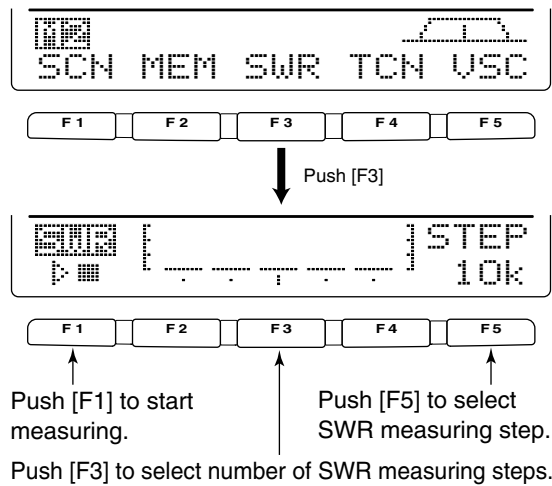

• Measuring (after pushing [F1])

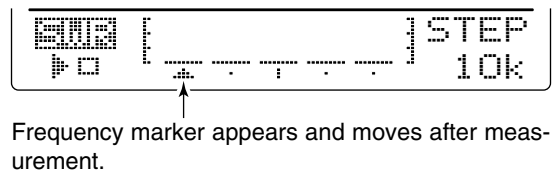

*When measurement point/s is/are set outside of the operable frequency band, the frequency marker flashes.

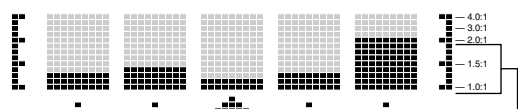

Typical display SWR varying between 1 and 2, full scale up to SWR 4.0:1.

Memory channels

The transceiver has 101 memory channels (plus 1 call channel). The memory mode is very useful for quickly changing to often-used frequencies.

All 101 memory channels are tuneable which means the programmed frequency can be tuned temporarily with the tuning dial, etc. in memory mode.

MEMORY CHANNEL	MEMORY CHANNEL NUMBER	CAPABILITY	TRANSFER TO VFO	OVER-WRITING	CLEAR
Regular memory channels	1–99	One frequency and one mode in each memory channel.	Yes	Yes	Yes
Scan edge memory channels	P1, P2	One frequency and one mode in each memory channel as scan edges for programmed scan.	Yes	Yes	No
Call channel	C	Same as regular.	No	Yes	No

Memory channel selection

◇ In VFO mode

- Push [V/M] to select VFO mode, if necessary, then rotate [M-CH] to select a memory channel number.
 - All memory channels including blank channels can be selected.
 - “BLANK” appears when no information has been programmed into a memory channel.
- Push [V/M] to select memory mode.
 - “MEMO” and contents of the memory channel appear.

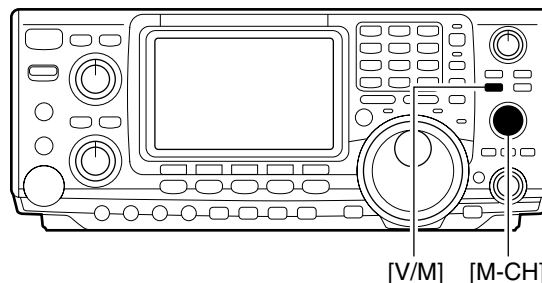

◇ In memory mode

- Push [V/M] to select memory mode.
- Rotate [M-CH] to select a memory channel.
 - All memory channels including blank channels can be selected.
 - Memory channels can also be selected using the microphone [UP]/[DN] keys.

• During VFO mode

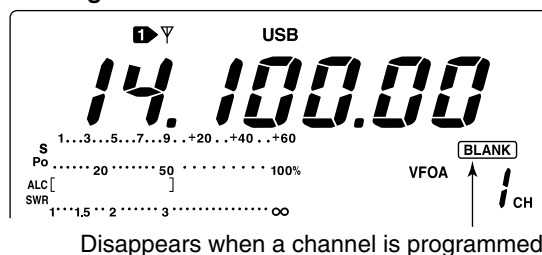

• During memory mode

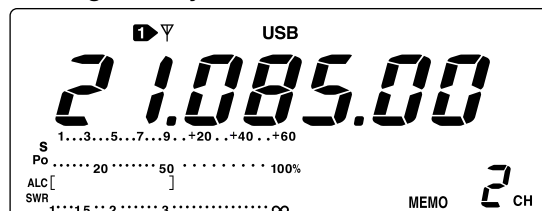

■ Programming a memory

Memory channel programming can be performed either in VFO mode or in memory mode.

◆ Programming in VFO mode

- ① Set the desired frequency and operating mode in VFO mode.
- ② Rotate [M-CH] to select the desired memory channel.
 - “BLANK” appears if the selected memory channel is a blank channel (and does not have contents).
- ③ Push [MW] for 1 sec. to program the displayed frequency and operating mode into the memory channel.
 - 3 beeps are emitted when memory programming is successful.

◆ Programming in VFO mode

- ① Select the desired memory channel with [M-CH] in memory mode.
 - Memory channel contents appear in the display.
 - “BLANK” appears and no frequency readout is displayed if the selected memory channel is a blank channel (and does not have contents).
- ② Set the desired frequency and operating mode in memory mode.
 - To program a blank channel, use direct frequency entry with the keypad or memo pads, etc.
- ③ Push [MW] for 1 sec. to program the displayed frequency and operating mode into the memory channel.
 - 3 beeps are emitted when memory programming is successful.

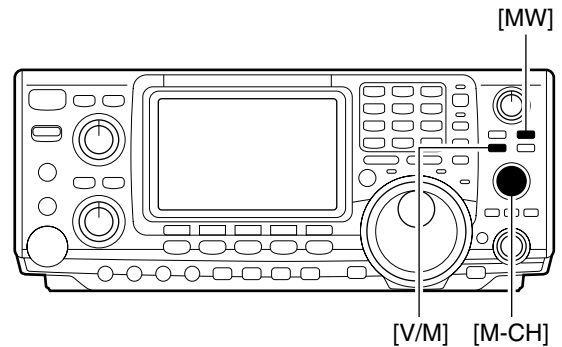

- [EXAMPLE]: Programming 7.088 MHz/LSB into memory channel 12.

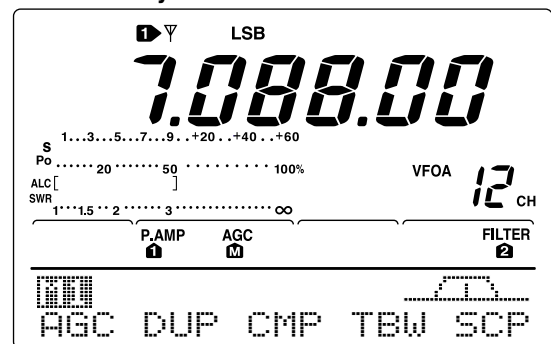

- [EXAMPLE]: Programming 21.280 MHz/USB into memory channel 18.

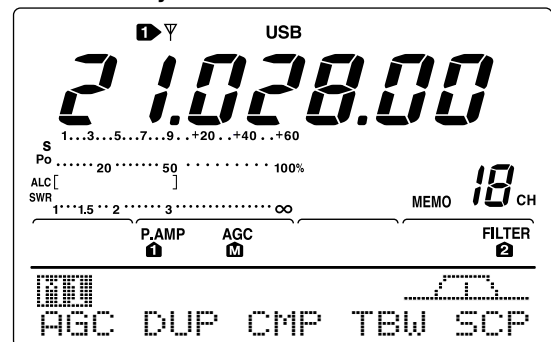

■ Memory clearing

Any unnecessary memory channels can be cleared. The cleared memory channels become blank channels.

- ① Select memory mode with [V/M].
- ② Select the desired memory channel with [M-CH].
- ③ Push [M-CL] for 1 sec. to clear the contents.
 - The programmed frequency and operating mode disappear.
 - 3 beeps are emitted when memory clearing is successful.
- ④ To clear other memory channels, repeat steps ② and ③.

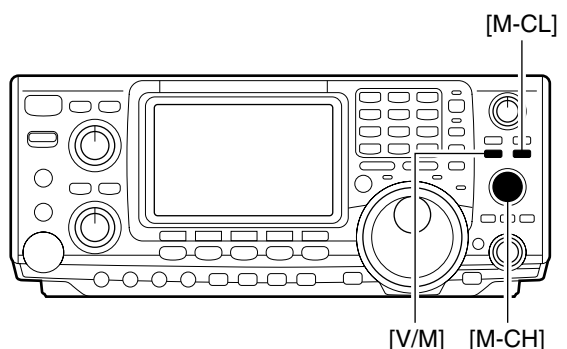

■ Selecting the call channel

By default 145.00000 MHz/FM is programmed into the call channel. However, this can be changed to suit your operating preference. (see below)

- ① Push [CALL] to select the call channel.
 - “C” appears.
- ② Push [CALL] again to return to the previous mode.

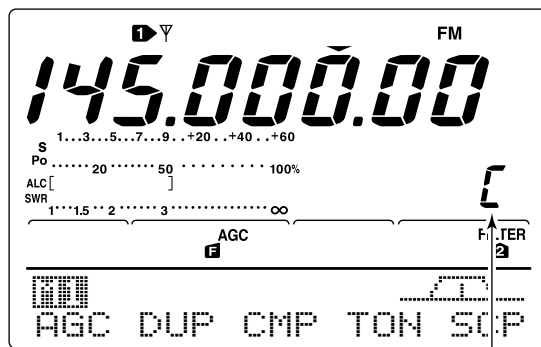
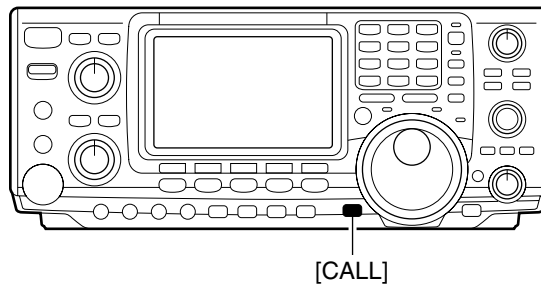

“C” appears

■ Programming the call channel

The call channel is programmed in the same way regular memory channels are. It's convenient to program a most-often-used frequency into the call channel for quick recall. As with memory channels, the call channel can also hold split frequencies.

- ① Rotate [M-CH] to select the call channel.
 - “C” appears.
- ② Select the desired frequency and operating mode to program into the call channel.
- ③ Push [MW] for 1 sec. to program the displayed frequency and operating mode into the call channel.
 - 3 beeps are emitted when memory programming is successful.

IMPORTANT!: When the call channel is selected with the [CALL] switch, the frequency CANNOT be changed using the tuning dial, band keys or keypad input. However, when the call channel is selected using [M-CH] in memory mode, the frequency CAN be changed.

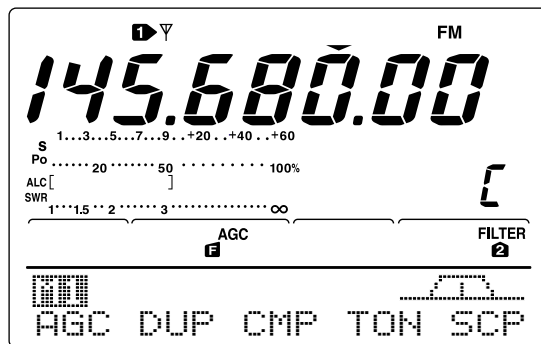
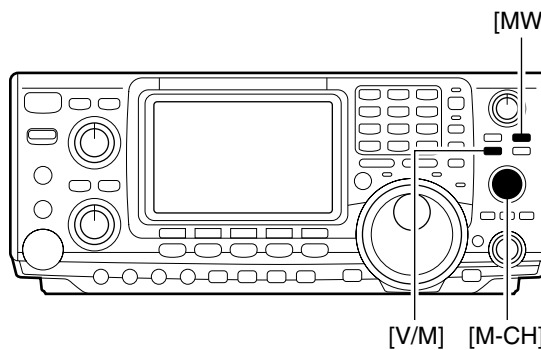

■ Frequency transferring

The contents of a memory channel (frequency, operating mode, etc.) can be transferred to the VFO.

Frequency transferring can be performed in either VFO mode or memory mode.

◆ Transferring in VFO mode

This is useful for transferring programmed contents to VFO.

- ① Select VFO mode with [V/M].
- ② Select the memory channel to be transferred with [M-CH].
 - “BLANK” appears if the selected memory channel is a blank channel. In this case transferring is impossible.
- ③ Push [V/M] for 1 sec. to transfer the frequency and operating mode.
 - 3 beeps are emitted.

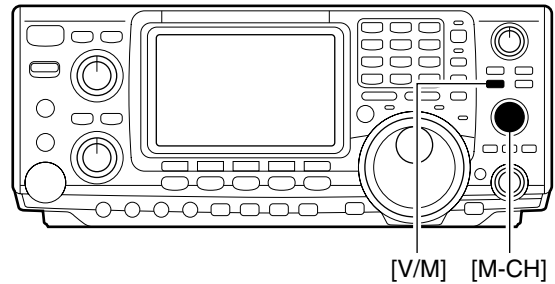

TRANSFERRING EXAMPLE IN VFO MODE

Operating frequency : 21.320 MHz/USB (VFO)
Contents of M-ch 16 : 14.018 MHz/CW

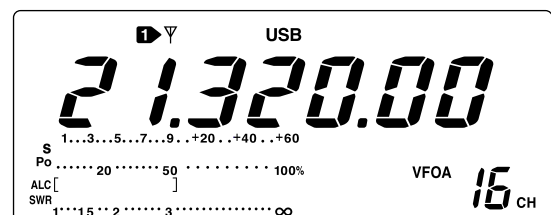

Push [V/M] for 1 sec. ↓

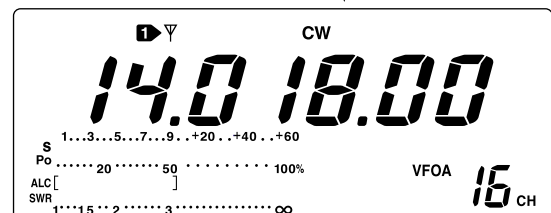

◆ Transferring in memory mode

This is useful for transferring frequency and operating mode while operating in memory mode.

When you have changed the frequency or operating mode in the selected memory channel:

- Displayed** frequency and mode are transferred.
- Programmed** frequency and mode in the memory channel are not transferred, and they remain in the memory channel.

- ① Select the memory channel to be transferred with [M-CH] in memory mode.
 - And, set the frequency or operating mode if required.
- ② Push [V/M] for 1 sec. to transfer the frequency and operating mode.
 - 3 beeps are emitted when the transferring is successful.
 - Displayed frequency and operating mode are transferred to the VFO.
- ③ To return to VFO mode, push [V/M] momentarily.

TRANSFERRING EXAMPLE IN MEMORY MODE

Operating frequency : 14.020 MHz/CW (M-ch 16)
Contents of M-ch 16 : 14.018 MHz/CW

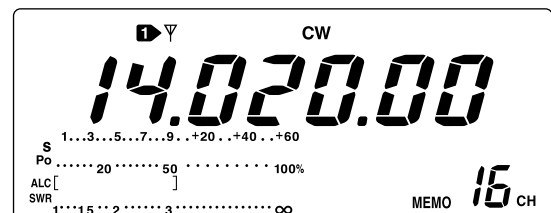

Set the frequency ↓

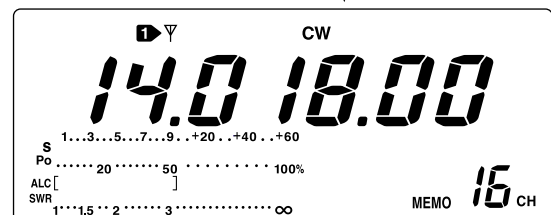

Push [V/M] for 1 sec. then push [V/M] ↓

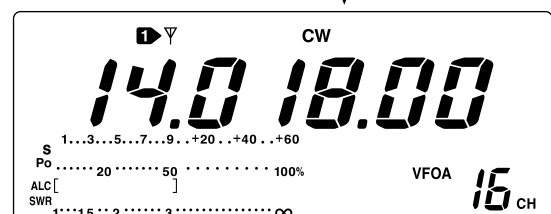

■ Programming scan edges

Memory channels P1 and P2 are the program scan edges. They are used to program an upper and lower frequency for programmed scan (p. 70). By default, P1 is programmed with 0.50000 MHz and P2 is programmed with 29.99999 MHz. If P1 and P2 are programmed with the same frequencies, programmed scan will not proceed.

[EXAMPLE]: Programming 14.00000 MHz into P1 and 14.35000 MHz into P2.

- ① Push [V/M] to select VFO mode, if necessary.
- ② Rotate [M-CH] to select scan edge P1.
- ③ Rotate the tuning dial to set 14.00000 MHz as the lower frequency.
- ④ Push [MW] for 1 sec. to program 14.00000 MHz into scan edge P1.
 - 3 beeps are emitted.
- ⑤ Rotate [M-CH] to select scan edge P2.
- ⑥ Rotate the tuning dial to set 14.35000 MHz as the upper frequency.
- ⑦ Push [MW] for 1 sec. to program 14.35000 MHz into scan edge P2.
 - 3 beeps are emitted.
 - When programmed scan is activated (p. 70) scanning will search the frequencies between 14.00000 MHz and 14.35000 MHz for signals.

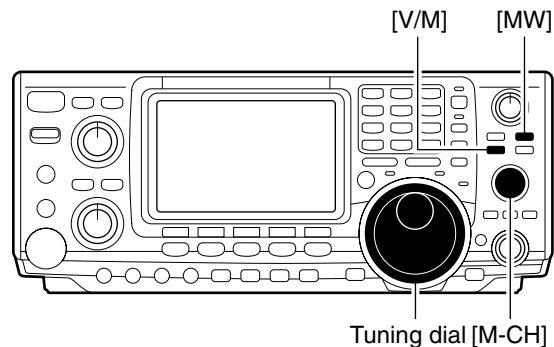

• After steps ② to ④

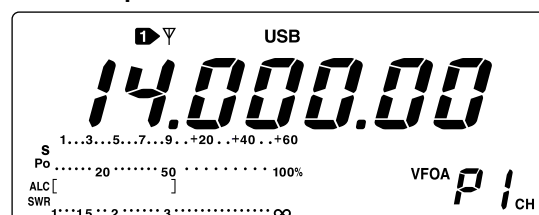

• After steps ⑤ to ⑦

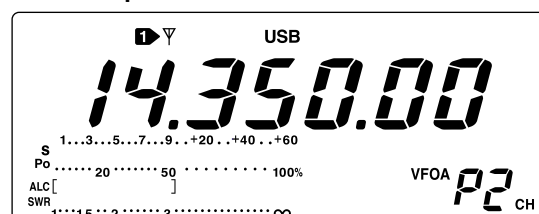

■ Assigning memory names

All memory channels (including scan edges) can be tagged with alphanumeric names of up to 9 characters each.

[EXAMPLE]: Programming “DX spot” into memory channel 99.

- ① Push [V/M] to select memory mode, if necessary.
- ② Rotate [M-CH] to select memory channel 99.
- ③ Push [MENU] several times to select M2.
- ④ Push [F2 MEM] to select the memory name screen.
- ⑤ Push [F1 EDT] to edit memory channel name.
 - A cursor appears and blinks.
 - Memory channel names of blank channels cannot be edited.
- ⑥ Push [F1] several times to select the type of characters for input.
 - “ABC” inputs capital letters A to Z.
 - “abc” inputs small letters a to z.
 - “etc” is used to input other characters— ! # \$ % & ¥ ? “ ’ ^ + - * / . , ; = < > () [] { } | _ - are available.
 - Use the keypad to directly input numerals, “0” to “9,” including a decimal point.
- ⑦ Rotate the tuning dial to select the first character for input.
- ⑧ Push [F2 ←] or [F3 →] to move the cursor forwards or backwards, respectively.
 - Push [F5 SPC] to input a space and [F4 DEL] to delete the selected character.
- ⑨ Repeat steps ② to ⑧ to program another memory channel’s name, if desired.
- ⑩ Push [MENU] to set the memory channel name and return to the memory name menu.
 - Push [MENU] 1 more times to return to M2.

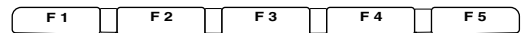
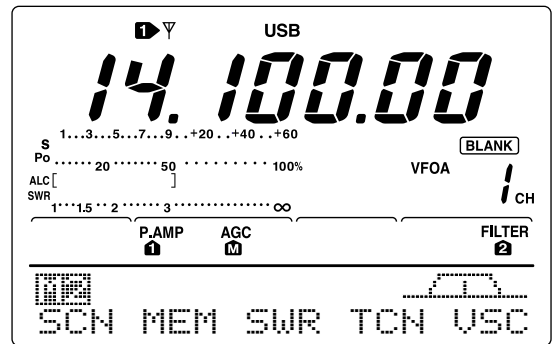
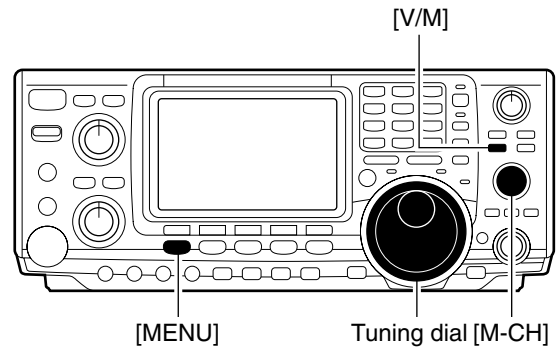

↓ Push [F2 MEM]

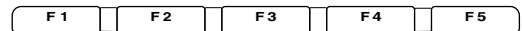
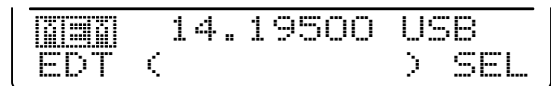

↓ Push [F2 MEM]

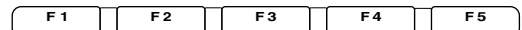

• During assigning a memory name

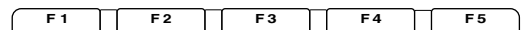

- ↑ Input space
- ↑ Delete a character
- ↑ Move cursor forwards
- ↑ Move cursor backwards
- ↑ Selects character type

• After assigning a memory name

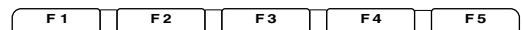

■ Memo pads

The transceiver has a memo pad function to store frequency and operating mode for easy write and recall. The memo pads are separate from memory channels. The default number of memo pads is 5, however, this can be increased to 10 in set mode if desired. (p. 84)

◇ Writing frequencies and operating modes into memo pads

- Push [MP-W] to store the displayed frequency and operating mode into a memo pad.
 - Each push of [MP-W] stores a frequency and mode into the next available memo pad; when you write a 6th (or 11th) frequency and operating mode, the oldest written frequency and operating mode are automatically erased to make room for the new settings.

NOTE: Each memo pad must have its own unique combination of frequency and operating mode; memo pads having identical settings cannot be written.

• Displayed frequency and mode

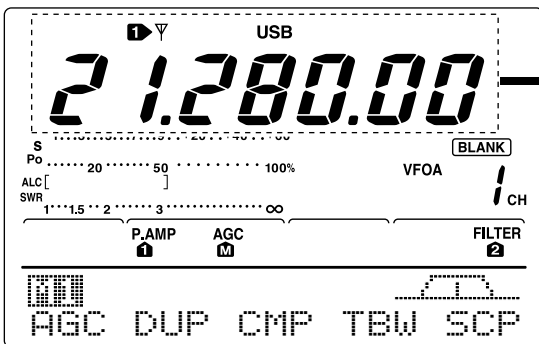

In this example, pushing [MP-W] enters 21.28000 MHz USB into the top memo pad and erases the oldest memo pad (21.34724 MHz LSB).

• Stored in next available memo pad

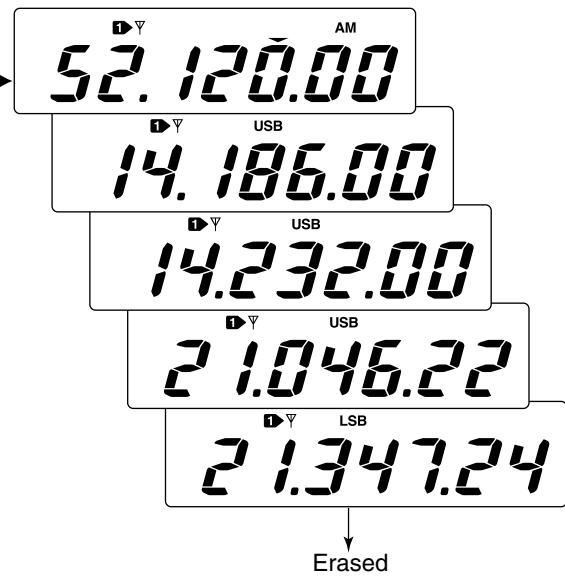

◇ Recalling a memo pad

- Push [MP-R] to recall a memo pad.
 - Each push of [MP-R] recalls a memo pad, starting from the most recently written.

• VFO or memory mode

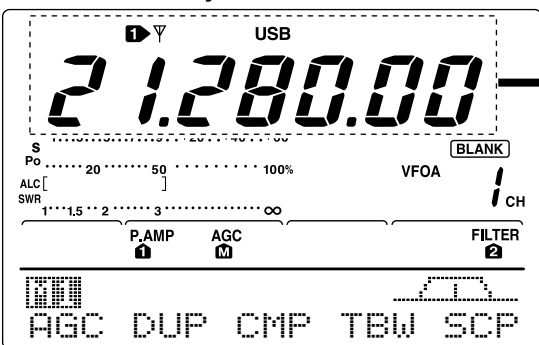

• Memo pads

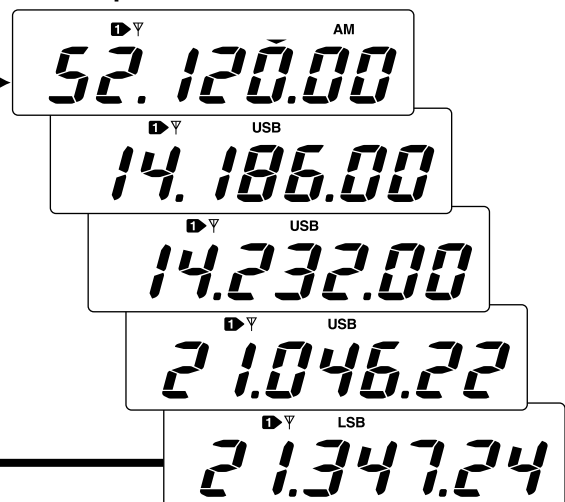

Scan types

PROGRAMMED SCAN

Repeatedly scans between two scan edge frequencies (scan edge memory channels P1 and P2).

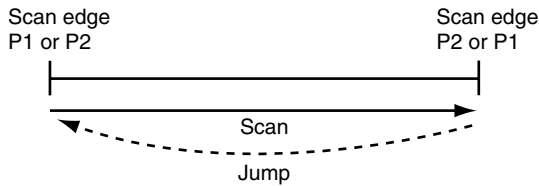

This scan operates in VFO mode.

ΔF SCAN

Repeatedly scans within ΔF span area.

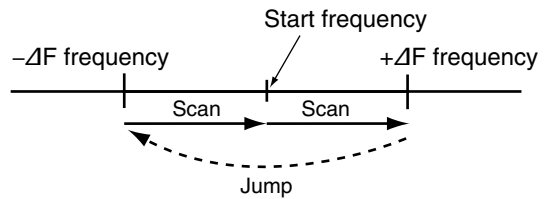

This scan operates in both VFO and memory modes.

MEMORY SCAN

Repeatedly scans all programmed memory channels.

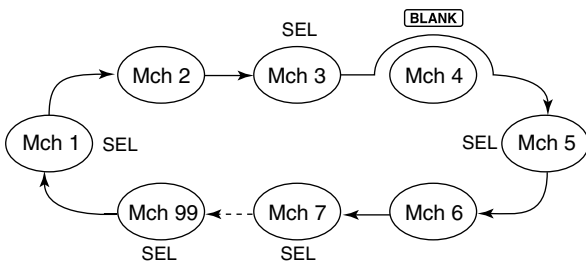

This scan operates in memory mode.

SELECT MEMORY SCAN

Repeatedly scans all selected memory channels.

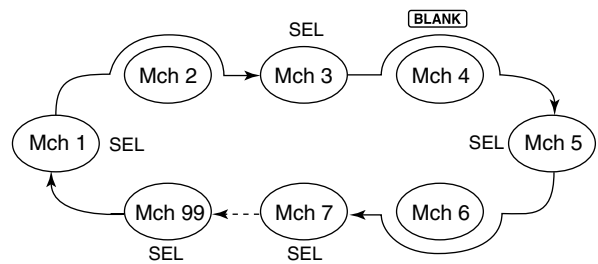

This scan operates in memory mode.

Preparation

•Channels

For programmed scan:

Program scan edge frequencies into scan edge memory channels P1 and P2.

For ΔF scan:

Set the ΔF span (ΔF scan range) in the scan screen.

For memory scan:

Program 2 or more memory channels except scan edge memory channels.

For select memory scan:

Designate 2 or more memory channels as select memory channels. To designate the channel as a select memory channel, choose a memory channel, then push [F3 SEL] in the scan screen, or push [F5 SEL] in the memory name screen.

•Scan resume ON/OFF

You can select the scan to resume or cancel when detecting a signal, in set mode. Scan resume ON/OFF must be set before operating a scan. See p. 70 for ON/OFF setting and scan resume condition details.

•Scan speed

Scan speed can be selected from 2 levels, high or low, in set mode. See p. 69 for details.

•Squelch condition

SCAN STARTS WITH	PROGRAMMED SCAN	MEMORY SCAN
SQUELCH OPEN	The scan continues until it is stopped manually, and does not pause even if it detects signals.	Scan pauses on each channel when the scan resume is ON; not applicable when OFF.
SQUELCH CLOSED	Scan stops when detecting a signal. If you set scan resume ON in scan set mode, the scan pauses for 10 sec. when detecting a signal, then resumes. When a signal disappears while scan is paused, scan resumes 2 sec. later.	

■ Voice squelch control function

This function is useful when you don't want unmodulated signals pausing or cancelling a scan. When the voice squelch control function is activated, the receiver checks received signals for voice components.

If a receiver signal includes voice components, and the tone of the voice components changes within 1 sec., scan pauses (or stops). If the received signal includes no voice components or the tone of the voice components does not change within 1 sec., scan resumes.

- ▶ While M2 is selected with [MENU], push [F5 VSC] to switch the VSC (Voice Squelch Control) function ON and OFF.
 - “VSC” appears when the function is activated.

- ▨•The VSC function activates for any scan.
- ▨•The VSC function resumes the scan on unmodulated signals, regardless of whether the scan resume condition is set to ON or OFF.

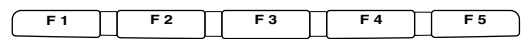
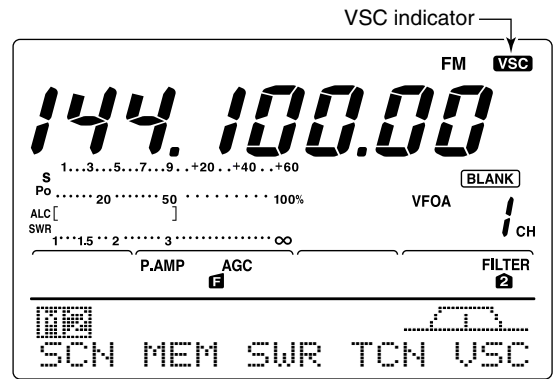

Push [F5] to turn the VSC function ON and OFF.

■ Scan set mode

When the squelch is open, scan continues until it is stopped manually—it does not pause on detected signals. When squelch is closed, scan stops when detecting a signal, then resumes according to the scan resume condition. Scan speed and the scan resume condition can be set using the scan set mode.

- ① Push[MENU] to select M2.
- ② Push [F1 SCN] to select scan menu.
- ③ Push [F5 SET] to select scan set mode.
- ④ Push [F1 ▲] or [F2 ▼] to select SCAN Speed item.
- ⑤ Rotate the tuning dial to select scan speed from high and low.
 - “HIGH” : scan is faster
 - “LOW” : scan is slower
- ⑥ Push [F2 ▼] to select SCAN Resume item.
- ⑦ Rotate the tuning dial to select scan resume function from ON and OFF.
 - “ON” : when detecting a signal, scan pauses for 10 sec., then resumes. When a signal disappears, scan resumes 2 sec. later.
 - “OFF” : when detecting a signal, cancels scanning.
- ⑧ Push [MENU] to return to scan menu.

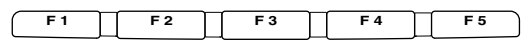
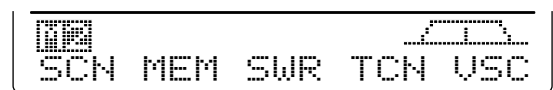

Push [F1]

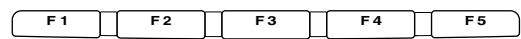

Push [F5]

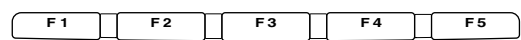
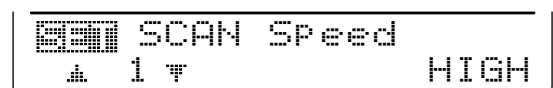

Push [F1] or [F2]

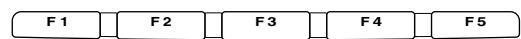
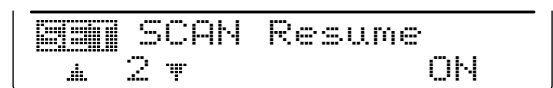

■ Programmed scan/Fine programmed scan (VFO mode)

Programmed scan searches for signals between scan edge memory channels P1 and P2. The default frequencies for these memories are 0.500000 MHz and 29.99999 MHz, respectively. See p. 65 for scan edges programming.

- ① Push [V/M] to select VFO mode, if necessary.
- ② Select the desired operating mode.
 - The operating mode can also be changed while scanning.
- ③ Push [TS] to select a tuning step.
 - The tuning step can also be changed while scanning.
- ④ Push [MENU] to select M2.
- ⑤ Push [F1 SCH] to select the scan menu.
 - See p. 68 for scan condition.
 - If the [RF/SQL] control function is set as "AUTO," the squelch is always open in SSB, CW and RTTY modes.
- ⑥ Push [F1 PRO] to start the programmed scan.
 - The MHz and kHz decimal points blink while scanning.
- ⑦ When the scan detects a signal, the scan stops, pauses or ignores it depending on the resume, VSC setting and the squelch condition.
- ⑧ To cancel the scan, push [F1 PRO].
 - Rotating the tuning dial during scan also cancels scan operation.

▨ If the same frequencies are programmed into the scan edge memory channel P1 and P2, programmed scan does not start.

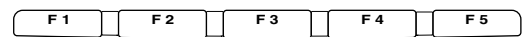
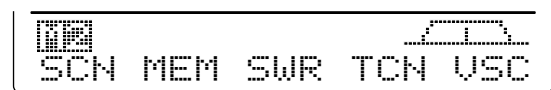
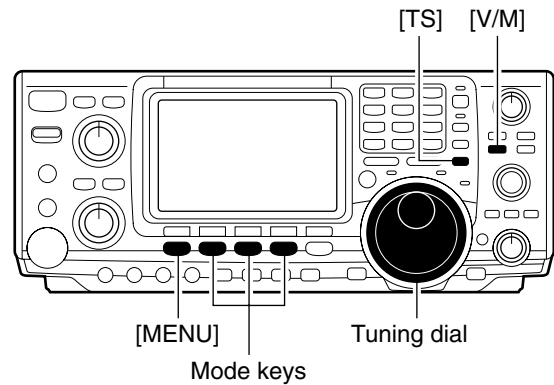

↓ Push [F1]

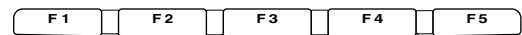

↓ Push [F1]

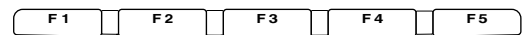
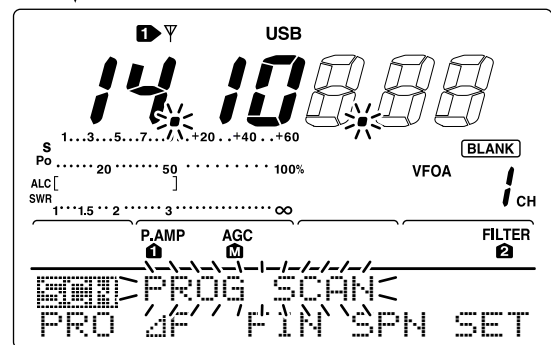

↑ Push [F1] to start/cancel the scanning.

◆ About the Fine programmed scan

During programmed scan, when a signal is received, scan continues, but the tuning step is temporarily set to 10 Hz.

- ① Follow steps ① to ⑥ above to start programmed scan.
- ② During programmed scan, push [F3 FIN] to switch between programmed scan and fine programmed scan operation.
- ③ Push [F1 PRO] to cancel the scan.
 - Rotating the tuning dial during scan also cancels scan operation.

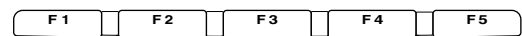
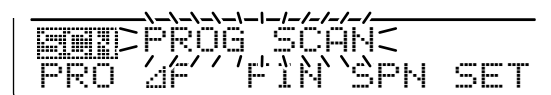

↑ Push [F3] to switch between programmed scan and fine programmed scan.

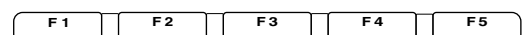

Memory scan operation (Memory mode)

Memory scan searches through memory channel 1 to 99 for signals. Blank (unprogrammed) memory channels are skipped.

- ① Push [V/M] to select memory mode, if necessary.
- ② Push [MENU] to select M2.
- ③ Push [F1 **SON**] to select the scan menu.
 - See p. 69 for scan condition.
 - If the [RF/SQ] control function is set as "AUTO," the squelch is always open in SSB, CW and RTTY modes.
- ④ Push [F1 **MEM**] to start the memory scan.
 - The MHz and kHz decimal points blink while scanning.
 - At least 2 memory channels must be programmed for memory scan to proceed.
- ⑤ To cancel the scan, push [F1 **MEM**].
 - Rotating the tuning dial during scan also cancels scan operation.

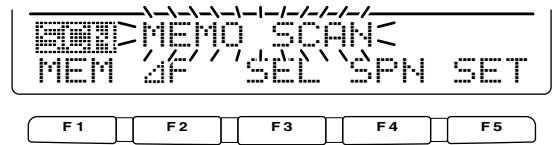
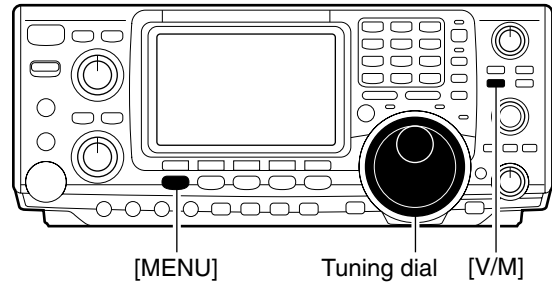

Push [F1] to start/cancel the scanning.

Select memory scan

Select memory scan searches through memory channels set as "select," for signals. See below for setting and deleting select memory channels.

- ① Follow the steps ① to ④ above to start memory scan.
- ② During memory scan, push [F3 **SEL**] to switch between memory scan and select memory scan.
 - At least 2 memory channels must be set as the select channel.
- ③ Push [F1 **MEM**] to cancel the scan.
 - Rotating the tuning dial during scan also cancels scan operation.

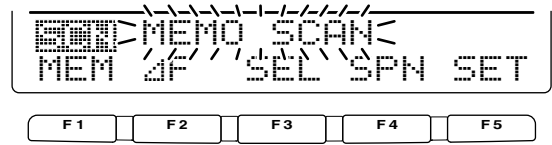

Push [F3] to switch between memory scan and select memory scan.

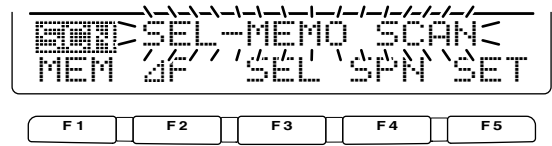

Setting/Cancelling select memory channels

All memory channels, except scan edges (P1 and P2), can be set as a select memory channels.

- ➔ While the scan menu is selected, push [F3 **SEL**] to set/cancel the displayed memory channel as a select channel; or while memory name screen is indicated, push [F5 **SEL**] to set/cancel the displayed memory channel as a select memory channel.
 - "SEL" appears when the channel is set as a select memory channel.
 - "SEL" disappears when cancelled.
 - Push [F3 **SEL**]/[F5 **SEL**] for 1 sec to cancel all select memory settings.

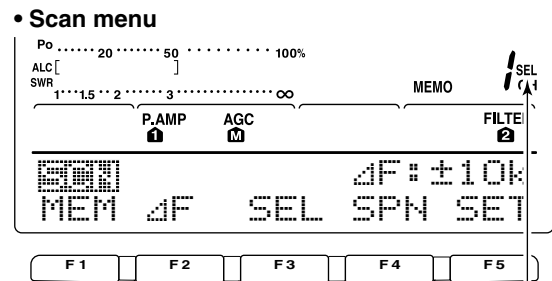

Push [F3] to set/cancel as a select channel.

Select memory indicator

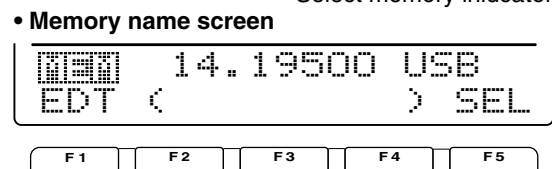

Push [F3] to set/cancel as a select channel.

■ ΔF scan operation and Fine ΔF scan

ΔF scan searches for signals within the specified range with the displayed VFO or memory channel frequency as for center frequency. The frequency range is specified by the span.

- ① Push [V/M] to select VFO mode or memory mode, as desired.
- ② Set center frequency of the ΔF scan.
- ③ Push [MENU] to select M2.
- ④ Push [F1 SCN] to select the scan menu.
 - See p. 68 for scan condition.
 - If the [RF/SQL] control function is set as "AUTO," the squelch is always open in SSB, CW and RTTY modes.
- ⑤ Set the ΔF span by pushing [F4 SPN].
 - ± 5 kHz, ± 10 kHz, ± 20 kHz, ± 50 kHz, ± 100 kHz, ± 500 kHz and ± 1 MHz are selectable.
- ⑥ Push [F2 ΔF] to start the ΔF scan.
 - Decimal points blink while scanning.
- ⑦ When the scan detects a signal, the scan stops, pauses or ignores it depending on the VSC, resume setting and the squelch condition.
- ⑧ Push [F2 ΔF] to cancel the ΔF scan.
 - Rotating the tuning dial during scan also cancels scan operation.

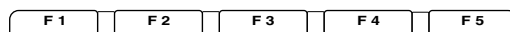
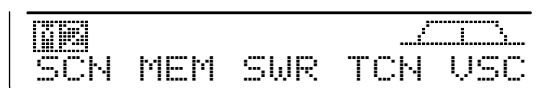
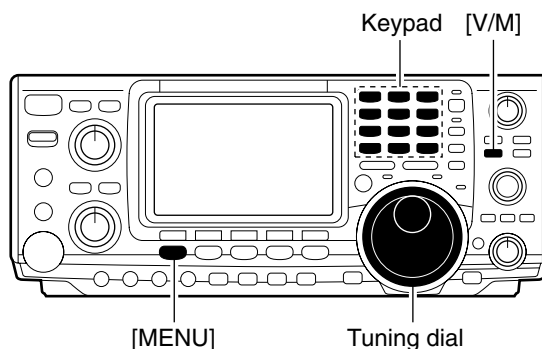

↓ Push [F1]

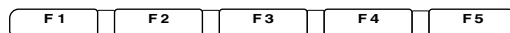

↓ Push [F2]

↑ Push [F4] to select the span.

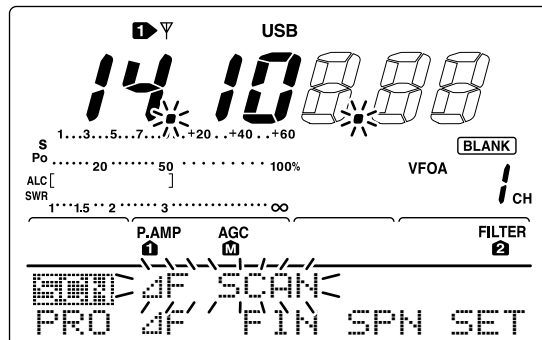

↑ Push [F2] to start/cancel the scanning.

◆ About the Fine ΔF scan

During ΔF scan, when a signal is received, scan continues, but the tuning step is temporarily set to 10 Hz.

- ① Follow steps ① to ⑥ above to start programmed scan.
- ② During ΔF scan, push [F3 FIN] to switch between ΔF scan and fine ΔF scan operation.
- ③ Push [F2 ΔF] to cancel the scan.
 - Rotating the tuning dial during scan also cancels scan operation.

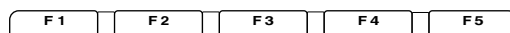

↑ Push [F3] to switch between programmed scan and fine programmed scan.

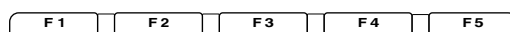
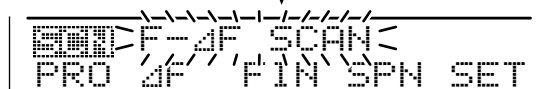

■ Tone scan/DTCS code scan operation

By monitoring a signal that is being operated with a repeater, tone squelch or DTCS, you can determine the tone frequency necessary to open a repeater or the squelch.

- ① Push [AM/FM] to select FM mode.
- ② Push [MENU] several times to select M1.
- ③ Push [F4 TONE] for 1 sec. to enter tone set mode.
- ④ Push [F1 TON] to select the tone type to be scanned.
 - "Rptr Tone" for repeater tone, "TSQ L Tone" for tone squelch and "DTCS Code" for DTCS code can be selected.
 - When selecting DTCS code to be scanned, push [F5] several times to select the DTCS code polarity.
 - "NN": Normal polarity for both transmit and receive.
 - "NR": Normal polarity for transmit and reverse polarity for receive.
 - "RN": Reverse polarity for transmit and normal polarity for receive.
 - "RR": Reverse polarity for both transmit and receive.
- ⑤ Push [F2 SCN] to start the tone scan function.
 - "Rptr Tone SCAN" "TSQ L Tone SCAN" or "DTCS Code SCAN" blinks when repeater tone scan, tone squelch scan or DTCS code scan is operated, respectively.
- ⑥ When a matched tone or code is found, the scan pauses and the tone frequency or code is set for the selected tone as in step ④.
 - ▨ When the tone scan or DTCS code scan is operated in memory or call channel mode, the detected tone frequency or code can be used temporarily.
 - ▨ To keep the detected tone frequency or code setting for memory contents, you must over-write the memory or call channel.
- ⑦ Push [F2 SCN] to cancel the tone scan function.
 - Rotating the tuning dial during scan also cancels scan operation.

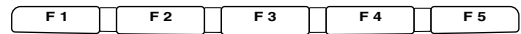
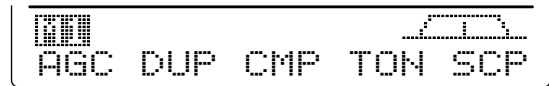

Push [F4] for 1 sec. ↓

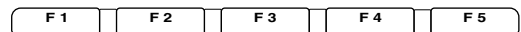
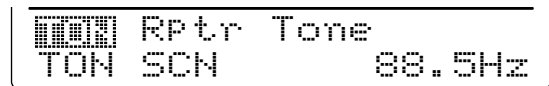

↑ Push [F1] several times to select tone type.

• Repeater tone scan

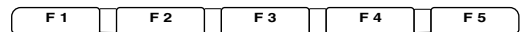
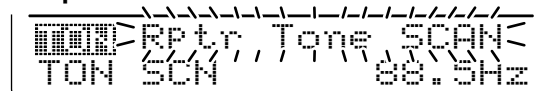

↑ Push [F2] to start/cancel the scan.

• Tone squelch tone scan

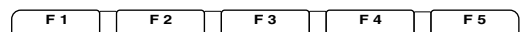
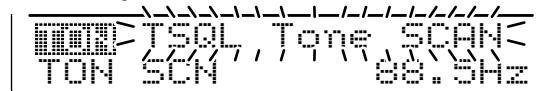

↑ Push [F2] to start/cancel the scan.

• DTCS code scan

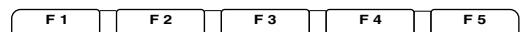
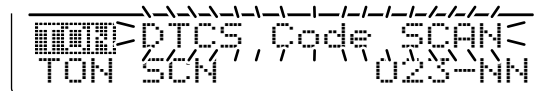

↑ Push [F2] to start/cancel the scan.

↑ Push [F1] several times to select polarity.

■ Antenna connection and selection

The IC-7400 has 2 antenna connectors for the HF/50 MHz bands, [ANT1] and [ANT2], and 1 antenna connector for the 144 MHz band; a total of 3 antenna connectors.

For each operating band the IC-7400 covers, there is a band memory which can memorize a selected antenna. When you change the operating frequency beyond a band, the previously used antenna is automatically selected (see below) for the new band. This function is convenient when you use 2 antennas for HF and 50 MHz bands operation.

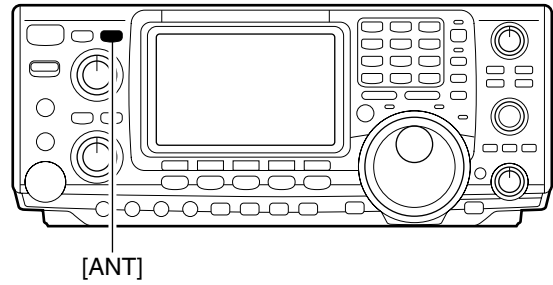

• Antenna select function: “Auto”

Once an antenna has been selected for use with a band by pushing [ANT], the antenna is automatically selected whenever that band is accessed.

[EXAMPLE]: a 3.5/7 MHz antenna is connected to [ANT1], a 21/28/50 MHz antenna is connected to [ANT2]. When the antenna selector function is set to “Auto,” an antenna is automatically selected when changing bands.

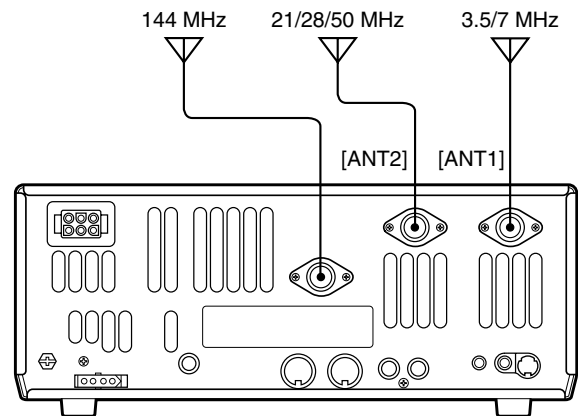

• Antenna select function: “Manual”

When “Manual” is selected, you can use the [ANT1] and [ANT2], however, band memory does not function. In this case you must select an antenna manually. However, the 144 MHz antenna will still be selected automatically.

[EXAMPLE]: an optional antenna tuner and HF antenna are connected to [ANT1] and a 50 MHz antenna is connected to [ANT2].

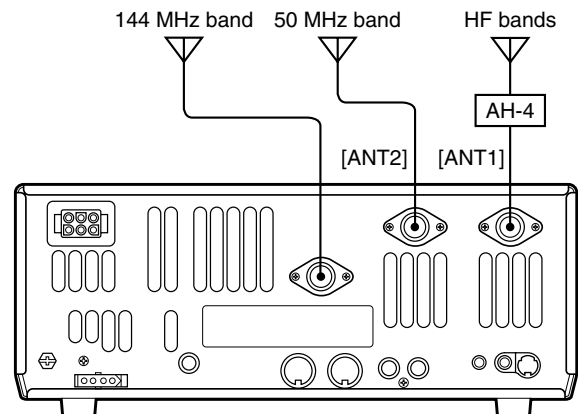

• Antenna select function: “OFF”

In this case, only [ANT1] and the 144 MHz antenna connector can be used. [ANT] switch does not function.

■ Antenna tuner operation

The internal automatic antenna tuner matches the transceiver to the connected antenna automatically. Once the tuner matches an antenna, the variable capacitor angles are memorized as a preset point for each frequency range (100 kHz steps). Therefore, when you change the frequency range, the variable capacitors are automatically preset to the memorized point.

CAUTION: NEVER transmit with the tuner ON when no antenna is connected. This will damage the transceiver. Be careful of the antenna selection.

◇ TUNER OPERATION

- ➔ Push [TUNER] to turn the internal antenna tuner ON. The antenna is tuned automatically when the antenna SWR is higher than 1.5:1.
 - When the tuner is ON, the “TUNE” indicator appears.

• MANUAL TUNING

During SSB operation at low voice levels, the internal tuner may not be tuned correctly. In such cases, manual tuning is helpful.

- ➔ Push [TUNER] for 1 sec., to start manual tuning.
 - A side tone is emitted and “TUNE” indicator blinks while tuning.
 - If the tuner cannot reduce the SWR to less than 1.5:1 after 20 sec. of tuning, the [TUNER] switch indicator goes out.

• AUTOMATIC TUNER START (HF bands only)

If you want to deactivate the tuner under conditions of VSWR 1.5:1 or less, use the auto tuner start function and turn the tuner OFF. This function activates the tuner automatically when the SWR exceeds 1.5:1.

This function is turned ON in set mode. (p. 83).

• PTT TUNER START

The tuner is always tuned when the PTT is pushed after the frequency is changed (more than 1% from last-tuned frequency). This function removes the “push and hold [TUNER]” operation and activates for the first transmission on a new frequency.

This function is turned ON in set mode. (p. 83).

• Antenna tuner of the IC-PW1

When using an external antenna tuner such as the IC-PW1's tuner, tune with the external antenna tuner, while the internal tuner is turned OFF. After tuning is completed, turn the internal tuner ON. Otherwise, both tuners tune simultaneously and correct tuning may not be obtained.

See the instruction manual included with each antenna tuner for their respective operations.

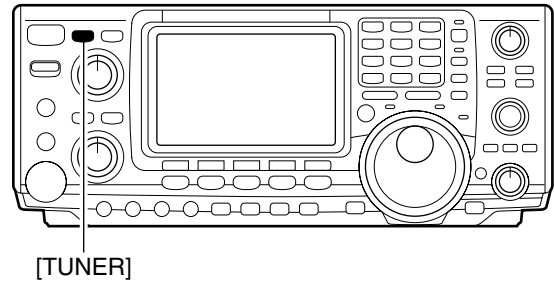

NOTES:

- The internal antenna tuner can only tune the HF and 50 MHz bands—the 144 MHz band cannot be tuned.
- NEVER transmit without an antenna properly connected to antenna port in use.
- When 2 antennas are connected, select the antenna to be used with [ANT].
- If the SWR is higher than about 1.5:1 when tuning above 100 kHz on an antenna's preset point, push [TUNER] for 1 sec. to start manual tuning.
- The internal tuner may not be able to tune in AM mode. In such cases, push [TUNER] for 1 sec. to manually tune.

◇ If the tuner cannot tune the antenna

Check the following and try again:

- the [ANT] connector selection.
- the antenna connection and feedline.
- the unaltered antenna SWR. (Less than 3:1 for HF bands; Less than 2.5:1 for 50 MHz band)
- the transmit power. (8 W for HF bands; 15 W for 50 MHz band)
- the power source voltage/capacity.

If the tuner cannot reduce the SWR to less than 1.5:1 after checking the above, perform the following:

- repeat manual tuning several times.
- tune with a 50 Ω dummy load and re-tune the antenna.
- turn power OFF and ON.
- adjust the antenna cable length. (This is effective for higher frequencies in some cases.)
- Some antennas, especially for low bands, have a narrow bandwidth. These antennas may not be tuned at the edge of their bandwidth, therefore, tune such an antenna as follows:

[Example]: Suppose you have an antenna which has an SWR of 1.5:1 at 3.55 MHz and an SWR of 3:1 at 3.8 MHz.

- ① Push [TUNER] to turn the antenna tuner ON.
- ② Select CW mode.
- ③ Turn OFF the break-in function. (p. 55)
- ④ Push [TRANSMIT] to set to the transmit condition.
- ⑤ Set 3.55 MHz and key down.
- ⑥ Set 3.80 MHz and key down.
- ⑦ Push [TRANSMIT] to return to the receive condition.

Optional external tuner operation

◆ AH-4 HF/50 MHz AUTOMATIC ANTENNA TUNER

The AH-4 matches the IC-7400 to a long wire antenna more than 7 m/23 ft long (3.5 MHz and above).

- See the AH-4 instruction manual for AH-4 installation and antenna connection details.

NEVER operate the AH-4 without an antenna wire. The tuner and transceiver will be damaged.

NEVER operate the AH-4 when it is not grounded.

Transmitting before tuning may damage the transceiver. Note that the AH-4 cannot tune when using a $\frac{1}{2} \lambda$ long wire or multiple of the operating frequency.

When connecting the AH-4, the antenna connector assignments are [ANT2] for the internal tuner and [ANT1] for the AH-4. The antenna indicator in the LCD displays “EXT” when the AH-4 is connected and selected.

◆ AH-4 operation

Tuning is required for each frequency. **Be sure** to re-tune the antenna before transmitting when you change the frequency— even slightly.

- ① Set the desired frequency in an HF or 50 MHz band.
 - The AH-4 may not operate on frequencies outside of ham bands.
- ② Push [TUNER] for 1 sec.
 - “TUNER” blinks while tuning.
- ③ “TUNE” appears constantly when tuning is complete.
 - When the connected wire cannot be tuned, the “TUNE” indicator goes out, and the AH-4 is bypassed. At that point the antenna wire connection routes to the transceiver directly, and not via AH-4 antenna tuner.
- ④ To bypass the AH-4 manually, push [TUNER].

AH-4 setting example:

For mobile operation

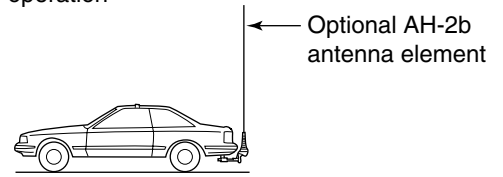

For outdoor operation

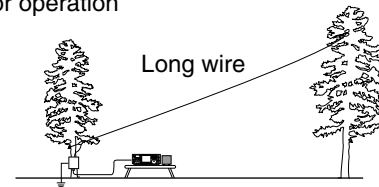

⚠ WARNING: HIGH VOLTAGE!
NEVER touch the antenna element while tuning or transmitting.

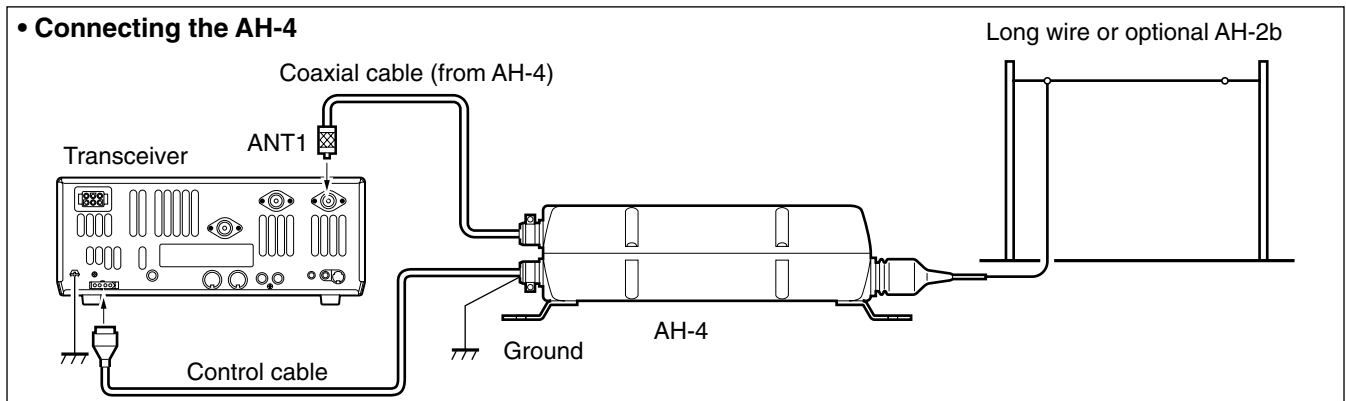
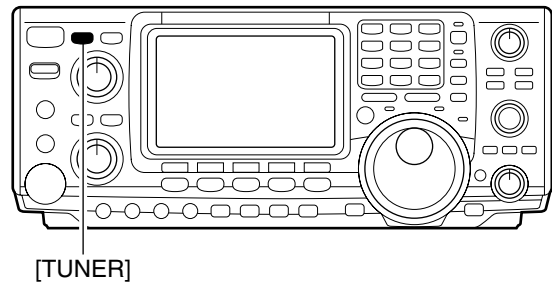

■ Connections

■ When connecting to [DATA]

• When using a PC application

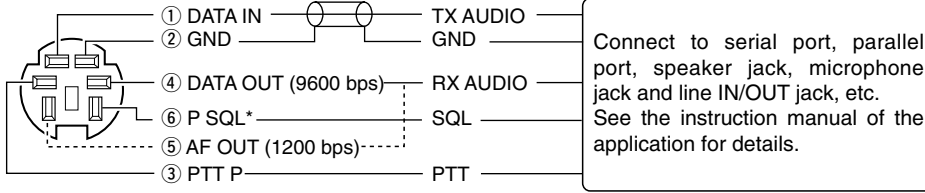

• When using a TNC

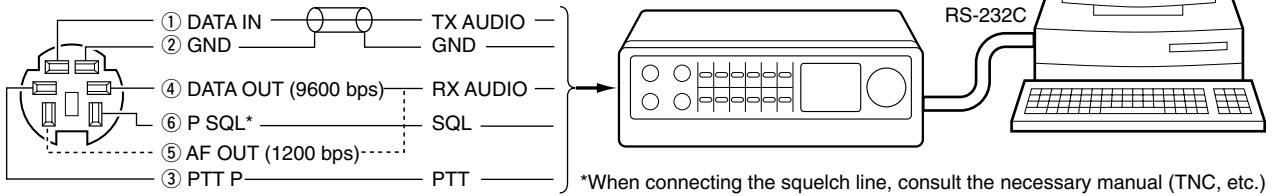

■ When connecting to [ACC(1)]

• When using a PC application

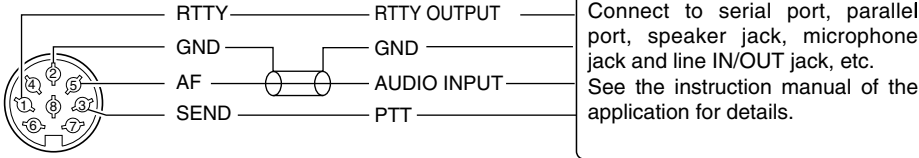

• When using a TNC

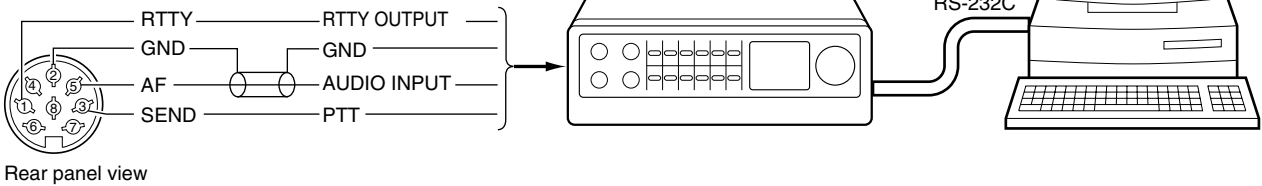

■ When connecting to [MIC]

• When using a PC application

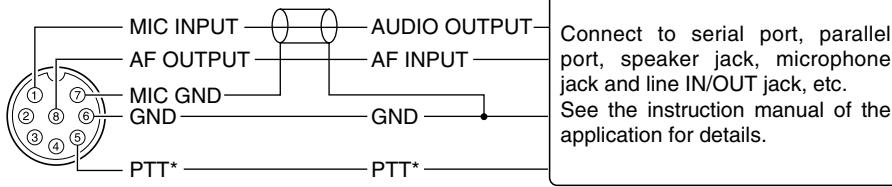

• When using a TNC

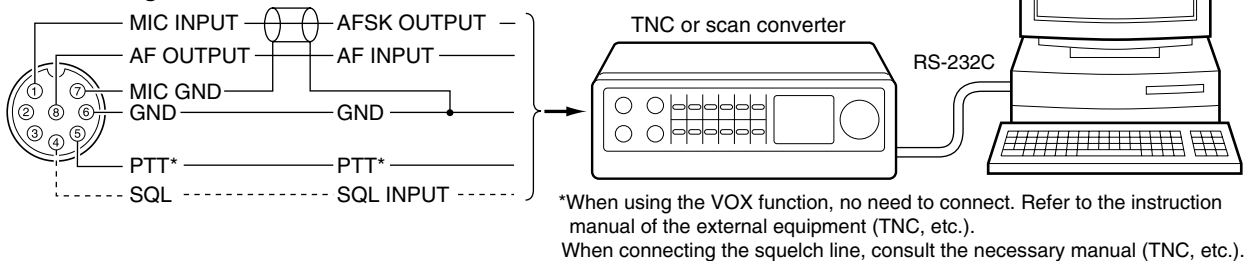

■ Packet (AFSK) operation

Before operating packet (AFSK) be sure to consult the operating manual that came with your TNC.

- ① Connect a TNC and PC. (p. 77)
- ② Push a band key to select an operating band.
- ③ Push [SSB] or [AM/FM] to select the desired operating mode.
 - After LSB or USB is selected, push [SSB] for 1 sec. to select LSB data or USB data mode, or after AM or FM is selected, push [AM/FM] for 1 sec. to select AM data or FM data mode.
 - Generally, LSB is used on HF bands and FM is used for packet operation on the VHF band.
- ④ Rotate the tuning dial to tune the desired signal.
- ⑤ Transmit your AFSK signals using your computer's keyboard.
 - Rotate [RF PWR] to set the output power.
 - Relative strength of the transmitted signal is indicated in the Po meter while operating the TNC.
 - When operating in SSB (data) mode, adjust output power so that the ALC reading in the ALC meter stays in the ALC zone.

NOTE: When connecting a TNC to the ACC socket on the rear panel, select SSB (LSB/USB) data mode or disconnect the microphone and rotate [MIC GAIN] fully counterclockwise.

When SSB data mode is selected, the audio input from the [MIC] connector is automatically cut, and the audio input from the [ACC(1)] is used.

Also, when the SSB data mode is selected, the fixed setting listed below are selected automatically;

- Speech compressor : OFF
- Transmit bandwidth : MID
- Tx tone (Bass) : 0
- Tx tone (Treble) : 0

◇ Frequency indication during AFSK operation

When operating AFSK in SSB mode, the indicated frequency is the signals carrier point.

- **Example**— LSB/LSB data mode
 Mark freq.: 2125 Hz
 Shift freq.: 200 Hz

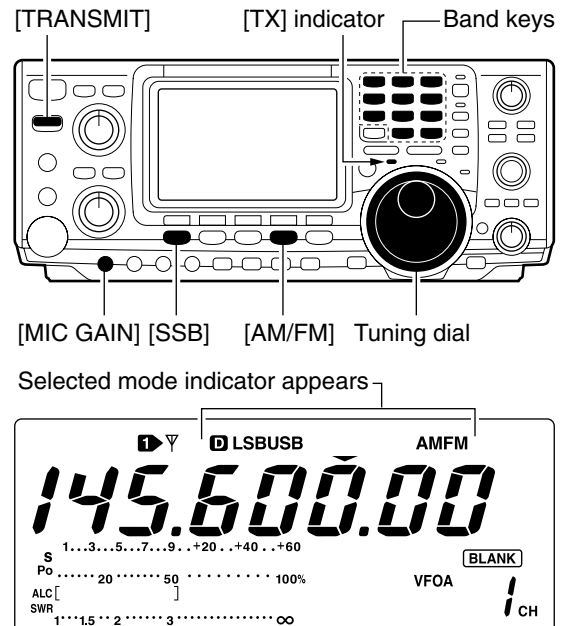
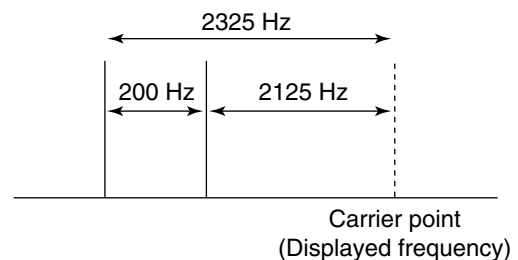

■ Adjusting the TNC output level

When setting data transmission speed to 9600 bps, the data signal coming from the TNC is applied exclusively to the internal limiter circuitry to automatically maintain band width.

NEVER apply data levels from the TNC of over 0.6 V p-p, otherwise the transceiver will not be able to maintain the band width and may possibly interfere with other stations.

◆ Using with a level meter or synchroscope

When using a level meter or synchroscope, adjust the TX audio output level (DATA IN level) from the TNC as follows.

- 0.4 V p-p (0.2 Vrms) : recommended level
- 0.2–0.5 V p-p (0.1–0.25 Vrms) : acceptable level

◆ Not using a measuring device

- ① Connect the transceiver to a TNC. (p. 77)
- ② Enter a test mode (“CAL,” etc.) on the TNC, then transmit some test data.
- ③ *When the transceiver fails to transmit the test data or transmits sporadically (TX indicator doesn't light or flashes):*
 - Decrease the TNC output level until the transmit indicator lights continuously.
 - When transmission is not successful even though the TX indicator lights continuously:*
 - Increase the TNC output level.

■ Data transmission speed

For data communication (in FM mode), the transceiver can be set to a maximum data speeds of 9600 bps (or less; 1200, 2400 or 4800 bps).

- ① Push [MENU] for 1 sec. to enter set mode.
- ② Push [F1 ▲] or [F2 ▼] to select the 9600bps Mode item.
- ③ Rotate the tuning dial to turn the 9600 bps mode ON and OFF.
 - ON : 9600 bps of data speed
 - OFF : 1200, 2400 or 4800 bps of data speed (default)
- ④ Push [MENU] to return to previous indication.

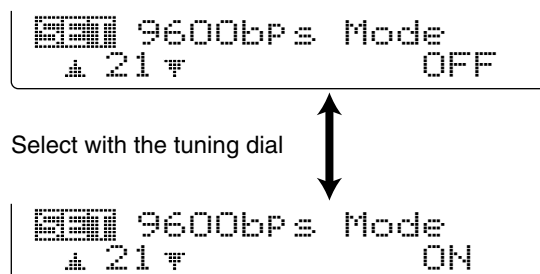

■ General set mode

◇ Entering set mode

Set mode is used for programming infrequently changed values or conditions of functions.

• Set mode operation

- ① Push [MENU] several times to select the function menu indication, if necessary.
- ② Push [MENU] for 1 sec. to enter the set mode.
- ③ Push [F1 ▲] or [F2 ▼] to select the desired item.
- ④ Set the desired condition using the tuning dial.
 - Push [F3] for 1 sec. to select a default condition or value.
- ⑤ Push [MENU] to exit the set mode.

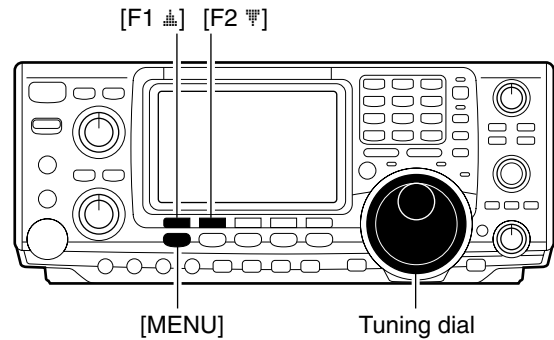

◇ Set mode items

1. LCD Contrast

This item adjusts the contrast of the LCD from 0% to 100% in 1% steps.
(default: 50%)



2. LCD Backlight

This item adjusts the brightness of the LCD from 0% to 100% in 1% steps.
(default: 50%)



3. Beep Level

This item adjusts the volume level for confirmation beep tones from 0% to 100% in 1% steps. When the beep tones, item 6. Beep (p. 81), are turned OFF, this setting has no effect.
(default: 50%)



4. Beep Level-Int

This item allows you to set a maximum volume level for confirmation beep tones. Confirmation beep tones are linked to the [AF] control until a specified volume level is reached—further rotation of the [AF] control will not increase the volume of the beep tones.

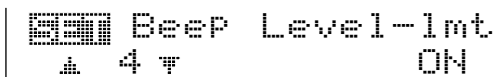

- ON Confirmation beep ON (default)
- OFF Confirmation beep OFF

5. CAL. Marker

This item is used for a simple frequency check of the transceiver.



- ON Calibration marker ON
- OFF Calibration marker OFF (default)

▨ Turn the calibration marker OFF after checking the frequency of the transceiver.

See p. 93 for calibration procedure.

■ General set mode (continued)

6. Beep

A beep sounds each time a switch is pushed to confirm it. This function can be turned OFF for silent operation.

ON Confirmation beep ON (default)
OFF Confirmation beep OFF

The volume level can be set in 3. Beep Level.
(p. 80)



Beep
▲ 6 ▼ ON

7. Band Edge Beep

A beep sounds when an operating frequency enters or exits an amateur band. This functions independent of the confirmation beep setting (above).

ON Band edge beep ON (default)
OFF Band edge beep OFF

The volume level can be set in 3. Beep Level.
(p. 80)

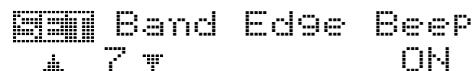

Band Edge Beep
▲ 7 ▼ ON

8. RF/SQL Control

The [RF/SQL] control can be set as the RF/squelch control (default), the squelch control only (RF gain is fixed at maximum) or 'Auto' (RF gain control in SSB, CW and RTTY; squelch control in AM and FM).

RF+SQL [RF/SQL] control as RF/squelch control (default)
SQL [RF/SQL] control as squelch control
AUTO [RF/SQL] control as RF gain control in SSB, CW and RTTY; squelch control in AM and FM



RF/SQL Control
▲ 8 ▼ RF+SQL

9. Meter Peak Hold

This item turns the meter peak hold function ON and OFF. When set to ON (default), peak meter readings are displayed for about 0.5 sec.

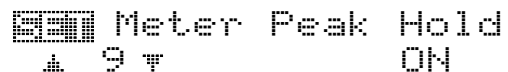

Meter Peak Hold
▲ 9 ▼ ON

10. COMP Meter

This item turns the COMP meter indication ON and OFF during transmit. When set to ON, the COMP meter is displayed instead of the SWR meter. (default: OFF)



COMP Meter
▲ 10 ▼ OFF

■ General set mode (continued)

11. Quick SPLIT

When this item is set to ON, pushing [SPLIT] for 1 sec. sets the transmit frequency using the displayed frequency and the split offset, set in **SPLIT Offset** item below, and activates the split function automatically.

ON Quick split ON (default)
OFF Quick split OFF



Quick SPLIT
▲ 11 ▼ ON

12. SPLIT Offset

This item sets the offset (difference between transmit and receive frequencies) for the quick split function.

The offset frequency can be set from -9.999 MHz to +9.999 MHz in 1 kHz steps.



SPLIT Offset
▲ 12 ▼ 0.000MHz

13. SPLIT LOCK

When this item is ON, the tuning dial can be used to adjust the transmit frequency while pushing [XFC] even while the dial lock function is activated.

ON Split lock function ON
OFF Split lock function OFF (default)



SPLIT LOCK
▲ 13 ▼ OFF

14. DUP Offset HF

This item sets the offset (difference between transmit and receive frequencies) for duplex operation. However, this setting is used to input the repeater offset for an HF band only.

The offset frequency can be set from 0.000 MHz to 9.999 MHz in 1 kHz steps.

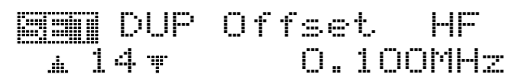

DUP Offset HF
▲ 14 ▼ 0.100MHz

15. DUP Offset 50M

This item sets the offset (difference between transmit and receive frequencies) for duplex operation. However, this setting is used to input the repeater offset for a 50 MHz band only.

The offset frequency can be set from 0.000 MHz to 9.999 MHz in 1 kHz steps.

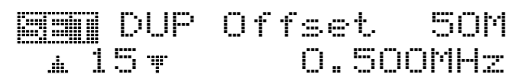

DUP Offset 50M
▲ 15 ▼ 0.500MHz

16. DUP Offset 144M

This item sets the offset (difference between transmit and receive frequencies) for duplex operation. However, this setting is used to input the repeater offset for a 144 MHz band only.

The offset frequency can be set from 0.000 MHz to 9.999 MHz in 1 kHz steps.

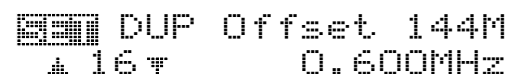

DUP Offset 144M
▲ 16 ▼ 0.600MHz

■ General set mode (continued)

17. One Touch Rptr

This item turns the one touch repeater function ON (DUP- or DUP+) and OFF.

When [F2 DUP] is pushed for 1 sec. in M1, the selected offset direction and the programmed duplex offset frequency (depending on the operating frequency band) is set with the displayed frequency.



The LCD display shows a signal strength indicator on the left, followed by the text "One Touch Rptr" and "DUP-". Below this, the number "17" is displayed with a small upward-pointing triangle to its left.

19. Auto Tune

The internal antenna tuner has an automatic start capability which starts tuning if the SWR is higher than 1.5–3:1 in the HF bands.

When "OFF" is selected, the tuner remains OFF even when the SWR is poor (1.5–3:1). When "ON" is selected, automatic tune starts even when the tuner is turned OFF.



The LCD display shows a signal strength indicator on the left, followed by the text "Auto Tune" and "OFF". Below this, the number "19" is displayed with a small upward-pointing triangle to its left.

20. PTT Tune

Tuning of the internal or external antenna tuner can be started automatically at the moment the PTT is pushed after the operating frequency is changed (more than 1% from the last-tuned frequency).



The LCD display shows a signal strength indicator on the left, followed by the text "PTT Tune" and "OFF". Below this, the number "20" is displayed with a small upward-pointing triangle to its left.

21. 9600bps Mode

This item turn the 9600 bps data transmission capability ON and OFF.

- ON : For 9600 bps data transmission.
- OFF : For the regular audio (or slower data) transmission only.



The LCD display shows a signal strength indicator on the left, followed by the text "9600bps Mode" and "OFF". Below this, the number "21" is displayed with a small upward-pointing triangle to its left.

22. [ANT] Switch

You can set the antenna connector selection to automatic, manual or non-selection (when using 1 antenna only for the HF/50 MHz bands).

- Auto : The antenna switch is activated and the band memory memorizes the selected antenna. (default)
- Manual: The antenna switch is activated and selects an antenna manually.
- OFF : The antenna switch is not activated and does not function. The [ANT1] connector is always selected in this case.



The LCD display shows a signal strength indicator on the left, followed by the text "[ANT] Switch" and "Auto". Below this, the number "22" is displayed with a small upward-pointing triangle to its left.

■ General set mode (continued)

23. SPEECH Language

When the optional UT-102 VOICE SYNTHESIZER UNIT is installed, you can select between English and Japanese as the language.

English : Announces in English (default)
Japanese : Announces in Japanese

See p. 89 for unit installation.



The LCD display shows a speaker icon on the left, followed by the text "SPEECH Language" on the top line and "English" on the bottom line. Below the speaker icon, there are up and down arrow symbols flanking the number "23".

24. SPEECH Speed

When the optional UT-102 VOICE SYNTHESIZER UNIT is installed, you can select between faster or slower synthesizer output.

HIGH : Announces faster (default)
LOW : Announces slower

See p. 89 for unit installation.



The LCD display shows a speaker icon on the left, followed by the text "SPEECH Speed" on the top line and "HIGH" on the bottom line. Below the speaker icon, there are up and down arrow symbols flanking the number "24".

25. SPEECH S-Level

When the optional UT-102 VOICE SYNTHESIZER UNIT is installed, you can have frequency, mode and signal level announcement. Signal level announcement can be deactivated if desired.

ON : Announces operating frequency, mode and receiving signal level. (default)
OFF : Announces operating frequency and mode only.

See p. 90 for unit installation.



The LCD display shows a speaker icon on the left, followed by the text "SPEECH S-Level" on the top line and "ON" on the bottom line. Below the speaker icon, there are up and down arrow symbols flanking the number "25".

26. Memory Pad Ch

This item sets the number of memo pad channels available. 5 or 10 memo pads can be set.

5 : 5 memo pads (default)
10 : 10 memo pads

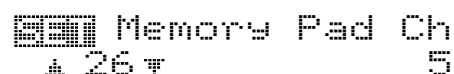

The LCD display shows a speaker icon on the left, followed by the text "Memory Pad Ch" on the top line and "5" on the bottom line. Below the speaker icon, there are up and down arrow symbols flanking the number "26".

■ General set mode (continued)

27. DIAL Auto TS

This item sets the auto tuning step function. When rotating the tuning dial rapidly, the tuning step automatically changes several times as selected.

There are 2 type of auto tuning steps: HIGH (Fastest) and LOW (Faster).

- HIGH : Auto tuning step is turned ON.
Approx. 5 times fastest tuning step during rapid rotation (default)
- LOW : Auto tuning step is turned ON.
Approx. 2 times faster tuning step during rapid rotation
- OFF : Auto tuning step is turned OFF.

DIAL Auto TS
▲ 27 ▼ HIGH

28. MIC U/D Speed

This item sets the rate at which frequencies are scanned when the microphone [UP]/[DN] switches are pushed and held. High or low can be selected.

- HIGH : High speed (default, 50 tuning steps/sec.)
- LOW : Low speed (25 tuning steps/sec.)

MIC U/D Speed
▲ 28 ▼ HIGH

29. Quick RIT Clear

This item selects the RIT/ Δ TX frequency clearing instruction with [PBTC].

- ON : Clears the RIT/ Δ TX frequency when [PBTC] is pushed momentarily.
- OFF : Clears the RIT/ Δ TX frequency when [PBTC] is pushed for 1 sec. (default)

Quick RIT Clear
▲ 29 ▼ OFF

30. BW PoPuP (PBT)

This item turns the PBT shifting value indication ON and OFF during [TWIN PBT] control operation. When set to ON, the shifting value is displayed above the multi-function switches.
(default: ON)

BW PoPuP (PBT)
▲ 30 ▼ ON

31. BW PoPuP (FIL)

This item turns the IF filter width indication ON and OFF when selecting with [FILTER]. When set to ON, the filter width is displayed above the multi function switches.
(default: ON)

BW PoPuP (FIL)
▲ 31 ▼ ON

■ General set mode (continued)

32. SSB/CW Synchronous Tuning

This item selects the displayed frequency shift function from ON and OFF.

When this function is activated, the receiving signal can be kept in receive even when the operating mode is changed between SSB and CW.

- ON : The displayed frequency shifts when the operating mode is changed between SSB and CW.
- OFF : The displayed frequency does not shift. (default)

/// The frequency shifting value may differ according to the CW pitch setting.

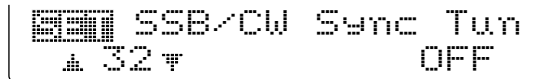

33. CW Normal Side

Selects the carrier point of CW mode from LSB and USB.

- LSB : The carrier point is set to LSB side. (default)
- USB : The carrier point is set to USB side.

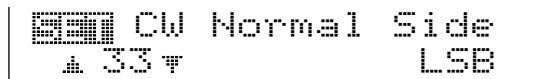

34. KEYER 1st. Menu

This item selects the appearing menu when [F4 KEY] is pushed in M1 at first, from KEYER-Root and KEYER-SEND.

- KEYER-Root : Selects memory keyer menu first (default)
- KEYER-SEND : Selects keyer SEND menu first

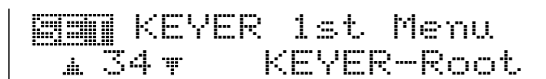

35. External Keypad

This item sets the external keypad capability.

- OFF : External keypad does not function. (default)
- KEYER SEND: Pushing one of external keypad switches, transmits the desired keyer memory contents during CW mode operation.

For your information

The diagram as at right shows the equivalent circuit of an external keypad and connects to pin 3 and pin 7 of the [MIC] connector (p. 12)

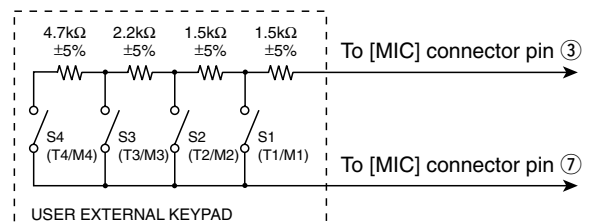
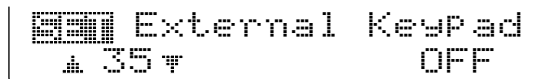

■ General set mode (continued)

36. CI-V Baud Rate

This item sets the data transfer rate. 300, 1200, 4800, 9600, 19200 bps and "Auto" are available.

Auto : Auto baud rate (default)
 300 : 300 bps
 1200 : 1200 bps
 4800 : 4800 bps
 9600 : 9600 bps
 19200 : 19200 bps

When "Auto" is selected, the baud rate is automatically set according to the connected controller or remote controller.

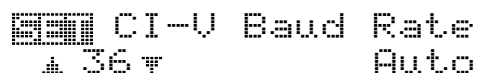

ICOM CI-V Baud Rate
 ▲ 36 ▼ Auto

37. CI-V Address

To distinguish equipment, each CI-V transceiver has its own Icom standard address in hexadecimal code. The IC-7400's address is 66h.

When 2 or more IC-7400's are connected to an optional CT-17 CI-V LEVEL CONVERTER, rotate the tuning dial to select a different address for each IC-7400 in the range 01h to 7Fh.

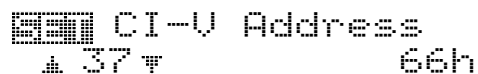

ICOM CI-V Address
 ▲ 37 ▼ 66h

38. CI-V Transceive

Transceive operation is possible with the IC-7400 connected to other Icom HF transceivers or receivers.

ON : Transceive ON (default)
 OFF : Transceive OFF

When "ON" is selected, changing the frequency, operating mode, etc. on the IC-7400 automatically changes those of connected transceivers (or receivers) and vice versa.

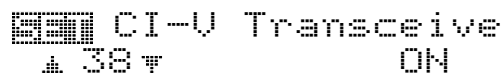

ICOM CI-V Transceive
 ▲ 38 ▼ ON

39. CI-V 731 Mode

When connecting the IC-7400 to the IC-735 for transceive operation, you must change the operating frequency data length to 4 bytes.

• This item must be set to "ON" only when operating the transceiver with the IC-735.

ON : 4 bytes of frequency data
 OFF : 5 bytes of frequency data (default)

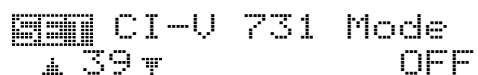

ICOM CI-V 731 Mode
 ▲ 39 ▼ OFF

■ Tone control set mode

◇ Entering tone control set mode

Tone levels (bass and treble) for each transmit and receive audio can be set for each phone mode independently.

• Set mode operation

- ① Push [MENU] several times to select M2.
- ② Push [F4 TCN] to select the tone control set mode.
- ③ Push [F1 ▲] or [F2 ▼] to select the desired item.
- ④ Push [SSB] or [AM/FM] to select the desired operating mode.
- ⑤ Set the desired condition using the tuning dial.
 - Push [F3] for 1 sec. to select a default value.
- ⑥ Push [MENU] to exit the set mode.

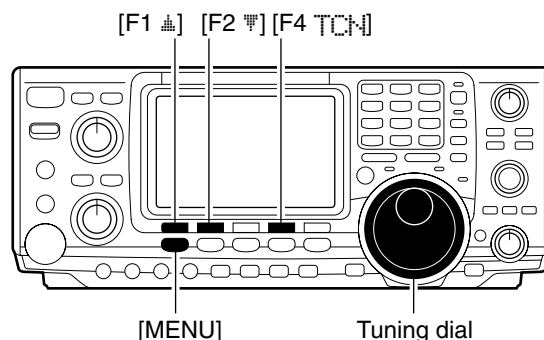

◇ Tone control set mode items

<p>1. TX Bass This item adjusts the bass level of the transmit audio tone from -5 dB to +5 dB in 1 dB steps.</p>	<p>The LCD display shows 'TX Bass' with a value of '1' and a bar graph indicator. The mode 'SSB' is shown on the right.</p>
<p>2. TX Treble This item adjusts the treble level of the transmit audio tone from -5 dB to +5 dB in 1 dB steps.</p>	<p>The LCD display shows 'TX Treble' with a value of '2' and a bar graph indicator. The mode 'SSB' is shown on the right.</p>
<p>3. RX Bass This item adjusts the bass level of the receive audio tone from -5 dB to +5 dB in 1 dB steps.</p>	<p>The LCD display shows 'RX Bass' with a value of '3' and a bar graph indicator. The mode 'SSB' is shown on the right.</p>
<p>4. RX Treble This item adjusts the treble level of the receive audio tone from -5 dB to +5 dB in 1 dB steps.</p>	<p>The LCD display shows 'RX Treble' with a value of '4' and a bar graph indicator. The mode 'SSB' is shown on the right.</p>

12 OPTION INSTALLATION

■ Opening the transceiver's case

Follow the case and cover opening procedures shown here when you want to install an optional unit or adjust the internal units, etc.

CAUTION: DISCONNECT the DC power cable from the transceiver before performing any work on the transceiver. Otherwise, there is danger of electric shock and/or equipment damage.

① Remove the 2 screws from the left side of the transceiver to remove the carrying handle as shown at right.

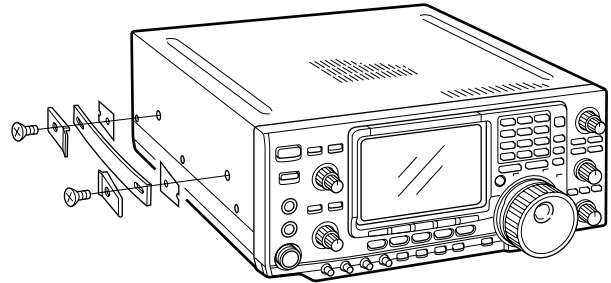

② Remove the 6 screws from the top of the transceiver and the 6 screws from the sides, then lift up the top cover.

③ Turn the transceiver upside down.

④ Remove 6 screws from the bottom of the transceiver, then lift up the bottom cover.

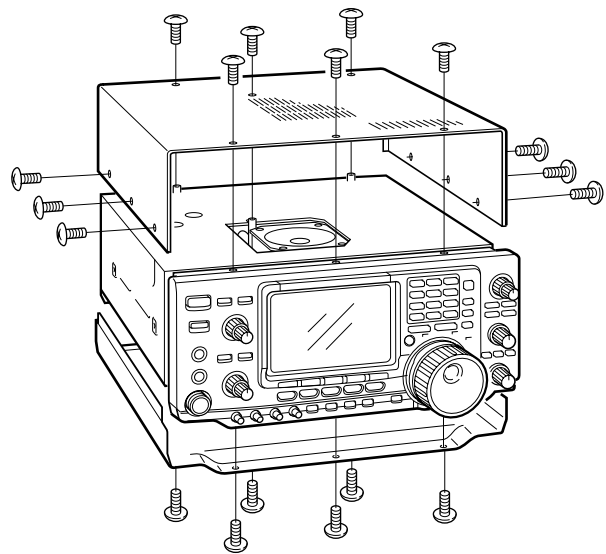

■ UT-102 VOICE SYNTHESIZER UNIT

The UT-102 announces the accessed readout's frequency, mode, etc. (S-meter level can also be announced— p. 84) in a clear, electronically-generated voice, in English (or Japanese).

➡ Push [LOCK/SPCH] for 1 sec. to announce the frequency, etc.

① Remove the top and bottom covers as shown above.

② Remove the protective paper attached to the bottom of the UT-102 to expose the adhesive strip.

③ Plug UT-102 into J1920 on the MAIN unit as shown in the diagram at right.

④ Adjust the trimmer, SPCH LVL: R1925 on the MAIN unit, to set the speech level if desired. Refer to the illustration at right.

⑤ Return the top and bottom covers to their original positions.

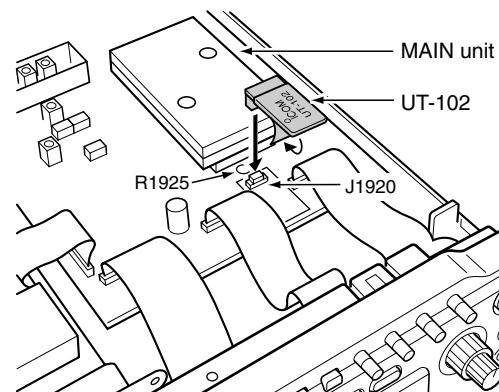

■ CR-338 HIGH STABILITY CRYSTAL UNIT

By installing the CR-338, the total frequency stability of the transceiver will be improved.

- ① Remove the bottom cover as shown on the previous page.
- ② Remove the 4 screws from the shield cover of the RF unit, and disconnect P2 (CHASSIS) from J761 (MAIN), then lift up the shield cover.

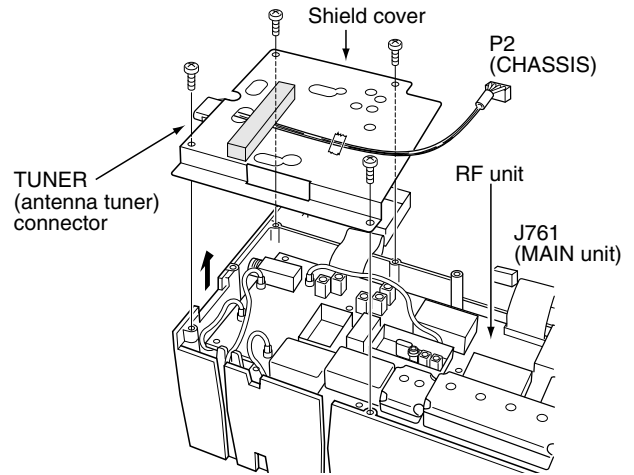

- ③ Remove the 8 screws from the RF unit, disconnect J1, J121 and J151, then remove the RF unit.
- ④ Remove the supplied internal crystal and replace with the CR-338.
- ⑤ Return the RF unit, J1, J121 and J151 to their original positions.

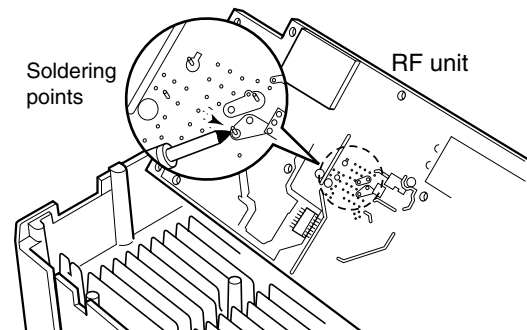
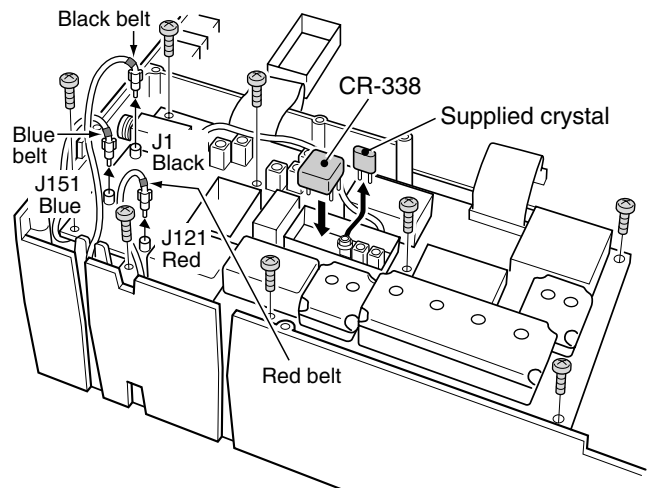

- ⑥ Connect a frequency counter to the J262, 2LO IN, then adjust the reference frequency to be 64.00000 MHz with the L1901 on the RF unit.
- ⑦ Return the J262, shield cover, P2 and bottom covers to their original positions.

Connect a frequency counter, then adjust the frequency to be 64.00000 MHz.

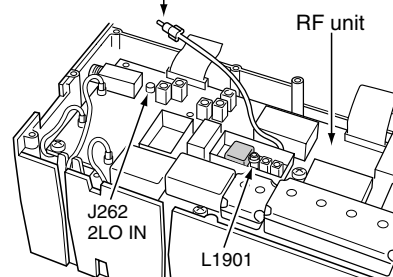

13 MAINTENANCE

■ Troubleshooting

The following chart is designed to help you correct problems which are not equipment malfunctions.

If you are unable to locate the cause of a problem or solve it through the use of this chart, contact your nearest Icom Dealer or Service Center.

	PROBLEM	POSSIBLE CAUSE	SOLUTION	REF.
POWER	Power does not come on when the [POWER] switch is pushed.	<ul style="list-style-type: none"> • Power cable is improperly connected. • Fuse is blown. 	<ul style="list-style-type: none"> • Re-connect the DC power cable correctly. • Check for the cause, then replace the fuse with the spare one. (Fuses are installed in the DC power cable and the internal PA unit.) 	p. 16 p. 92
	No sounds come out from the speaker.	<ul style="list-style-type: none"> • Volume level is too low. • The squelch is closed. • The transceiver is in transmitting condition. 	<ul style="list-style-type: none"> • Rotate [AF] clockwise to obtain a suitable listening level. • Turn [RF/SQL] to 10 o'clock position to open the squelch. • Push [TRANSMIT] to receive or check the SEND line of an external unit, if desired. 	p. 23 p. 24 p. 25
RECEIVE	Sensitivity is too low, and only strong signals are audible.	<ul style="list-style-type: none"> • The antenna is not connected properly. • The antenna for another band is selected. • The antenna is not properly tuned. • The attenuator is activated. 	<ul style="list-style-type: none"> • Re-connect to the antenna connector. • Select an antenna suitable for the operating frequency. • Push [TUNER] for 1 sec. to manually tune the antenna. • Push [P.AMP/ATT] for 1 sec. to select "ATT OFF." 	— p. 74 pgs. 75, 76 p. 47
	Received audio is unclear or distorted.	<ul style="list-style-type: none"> • Wrong operating mode is selected. • PBT function is activated. • Noise blanker is turned ON when receiving a strong signal. • Preamp is activated. • The noise reduction is activated and the [NR] control is too far clockwise. 	<ul style="list-style-type: none"> • Select a suitable operating mode. • Push [PBTC] for 1 sec. to reset the function • Push [NB] to turn the noise blanker OFF. • Push [P.AMP/ATT] once or twice to turn the function OFF. • Set the [NR] control for maximum readability. 	p. 23 p. 51 p. 50 p. 47 p. 52
	The [ANT] switch does not function	<ul style="list-style-type: none"> • The antenna switch has not been activated. 	<ul style="list-style-type: none"> • Set the antenna switch in set mode to "Auto" or "Manual." 	p. 84
	Transmitting is impossible.	<ul style="list-style-type: none"> • The operating frequency is not set to a ham band. 	<ul style="list-style-type: none"> • Set the frequency to a ham band. 	p. 19
TRANSMIT	Output power is too low.	<ul style="list-style-type: none"> • [RF PWR] is set too far counterclockwise • [MIC GAIN] is set too far counterclockwise • The antenna for another band is selected. • The antenna is not properly tuned. 	<ul style="list-style-type: none"> • Rotate [RF PWR] clockwise. • Set [MIC GAIN] to a suitable position. • Select an antenna suitable for the operating frequency. • Push [TUNER] for 1 sec. to manually tune the antenna. 	p. 25 p. 25 p. 74 pgs. 75, 76
	No contact possible with another station.	<ul style="list-style-type: none"> • RIT or ΔTX function is activated. • Split frequency and/or duplex function are activated. 	<ul style="list-style-type: none"> • Push [RIT] or [ΔTX] to turn the function OFF. • Push [SPLIT] and/or [F2 DUF] (in M1) to turn the function OFF. 	pgs. 47, 56 pgs. 44, 58
	Transmit signal is unclear or distorted.	<ul style="list-style-type: none"> • [MIC GAIN] is set too far clockwise 	<ul style="list-style-type: none"> • Set [MIC GAIN] to a suitable position. 	p. 25
	Repeater cannot be accessed.	<ul style="list-style-type: none"> • Split frequency or duplex function is not activated. • Programmed subaudible tone frequency is wrong. 	<ul style="list-style-type: none"> • Push [SPLIT] and/or [F2 DUF] (in M1) to turn the function ON • Reset the frequency using set mode. 	pgs. 44, 58 p. 45
	Programmed scan does not stop.	<ul style="list-style-type: none"> • Squelch is open. • [RF/SQL] is assigned to RF gain control and squelch is open. 	<ul style="list-style-type: none"> • Set [RF/SQL] to the threshold point. • Reset [RF/SQL] control assignment and set it to the threshold point. 	p. 24 pgs. 24, 81
SCAN	Programmed scan does not start.	<ul style="list-style-type: none"> • The same frequencies have been programmed in scan edge memory channels P1 and P2. 	<ul style="list-style-type: none"> • Program different frequencies in scan edge memory channel P1 and P2. 	p. 65
	Memory scan does not start	<ul style="list-style-type: none"> • 2 or more memory channels have not been programmed. 	<ul style="list-style-type: none"> • Program more than 2 memory channels. 	p. 62
	Select memory scan does not start	<ul style="list-style-type: none"> • 2 or more memory channels have not been designated as select channels. 	<ul style="list-style-type: none"> • Designate more than 2 memory channels as select channels for the scan. 	p. 71

	PROBLEM	POSSIBLE CAUSE	SOLUTION	REF.
DISPLAY	The displayed frequency does not change properly.	<ul style="list-style-type: none"> • The dial lock function is activated. • A set mode screen is selected. • The internal CPU has malfunctioned. 	<ul style="list-style-type: none"> • Push [LOCK/SPCH] to turn the function OFF. • Push [MENU] several times to exit the set mode. • Reset the CPU. 	<p>p. 52</p> <p>—</p> <p>p. 93</p>

■ Fuse replacement

If a fuse blows or the transceiver stops functioning, try to find the source of the problem, and replace the damaged fuse with a new, rated fuse.

The IC-7400 has 2 types of fuses installed for transceiver protection.

- DC power cable fuses FGB 30 A
- Circuitry fuse FGB 5 A

◇ DC power cable fuse replacement

Refer the figure illustrated at right for the DC power cable fuse replacement.

CAUTION: DISCONNECT the DC power cable from the transceiver when changing a fuse.

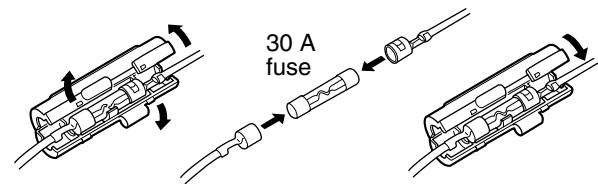

◇ Circuitry fuse replacement

The 13.8 V DC from the DC power cable is applied to all units in the IC-7400, except for the power amplifier, through the circuitry fuse. This fuse is installed in the PA unit.

- ① Remove the top cover as shown on p. 89.
- ② Remove the 11 screws from the PA shielding plate, then remove the plate.
- ③ Replace the circuitry fuse as shown in the diagram at right.
- ④ Replace the PA shielding plate and top cover.

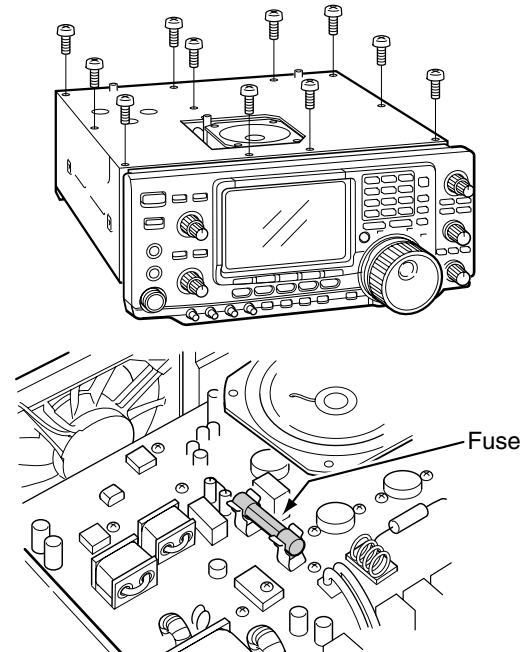

■ Tuning dial brake adjustment

The tension of the tuning dial may be adjusted to suit your preference.

The brake adjustment screw is located on the right side of the tuning dial. See the figure at right.

Turn the brake adjustment screw clockwise or counter-clockwise to obtain a comfortable tension level while turning the dial continuously and evenly in one direction.

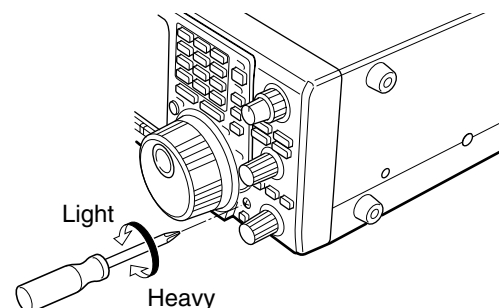

■ Resetting the CPU

When first applying power or when the function does not seem to be operating normally, reset the CPU as follows:

- ① Make sure the transceiver power is OFF.
- ② While pushing [M-CL] and [F-INP], push [POWER] for 1 sec. to turn power ON.
 - The internal CPU is reset.
 - The transceiver displays its initial VFO frequency when resetting is complete.
- ③ Correct the set mode settings after resetting, if desired.

NOTE: Resetting **CLEARs** all programmed contents in memory channels and returns programmed values in set mode to default values.

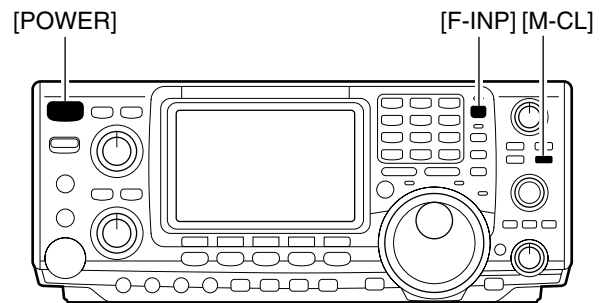

■ Frequency calibration (approximate)

A very accurate frequency counter is required to calibrate the frequency of the transceiver. However, a rough check may be performed by receiving radio station WWV, or other standard frequency signals.

CAUTION: Your transceiver has been thoroughly adjusted and checked at the factory before being shipped. You should not calibrate frequencies, except for special reasons.

- ① Push [SSB] to select USB mode.
- ② Push [PBTC] for 1 sec. to clear the PBT settings and make sure that the RIT/ Δ TX function is not activated.
- ③ Set the frequency to the standard frequency station minus 1 kHz.
 - When receiving WWV (10.000.00 MHz) as a standard frequency, set the operating frequency for 9.999.00 MHz.
 - Other standard frequencies can also be used.
- ④ Push [MENU] several times to select M1 or M2, if necessary.
- ⑤ Push [MENU] for 1 sec. to select the set mode screen.
- ⑥ Push [F1 \blacktriangle] or [F2 \blacktriangledown] several times to select the CAL. Marker item.
- ⑦ Rotate the tuning dial clockwise to turn the calibration marker ON.
 - Side tone may be heard.
- ⑧ Adjust [CAL] pot on the rear side of the transceiver for a zero beat with the received standard signal.
 - Zero beat means that two signals are exactly the same frequency, resulting in a single tone being emitted.
- ⑨ Rotate the tuning dial counterclockwise to turn the calibration marker OFF.
- ⑩ Push [MENU] to exit set mode.

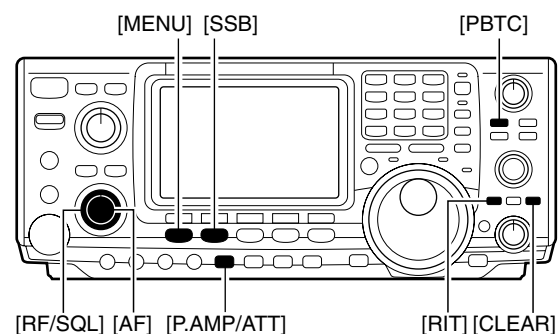

• Calibration marker item

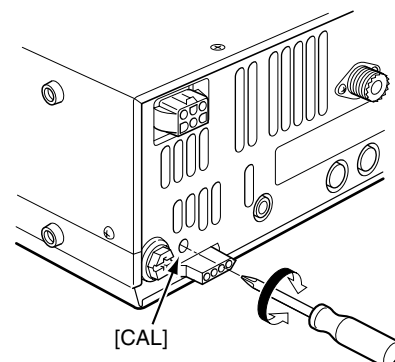
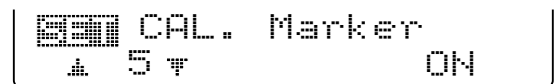

Remote jack (CI-V) information

•CI-V connection example

The transceiver can be connected through an optional CT-17 CI-V LEVEL CONVERTER to a personal computer equipped with an RS-232C port. The Icom Communications Interface-V (CI-V) controls the following functions of the transceiver.

Up to 4 Icom CI-V transceivers or transceivers can be connected to a personal computer equipped with an RS-232C port. See p. 87 for setting the CI-V condition using set mode.

•Data format

The CI-V system can be operated using the following data formats. Data formats differ according to command numbers. A data area or sub command is added for some commands.

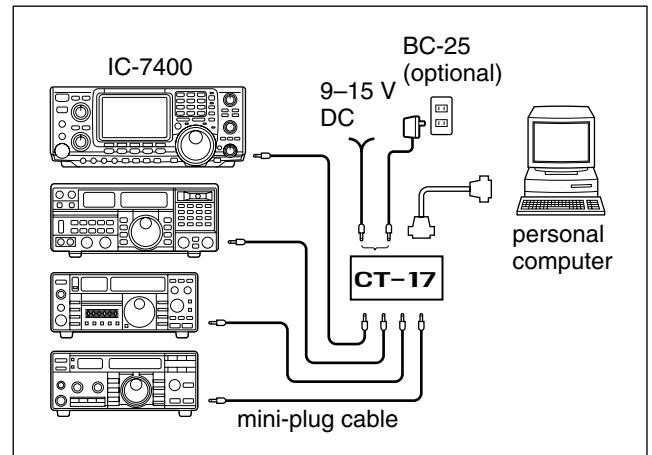

Controller to IC-7400

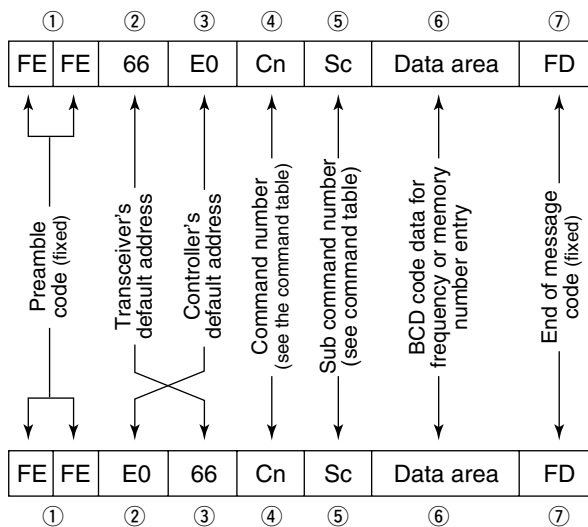

IC-7400 to controller

OK message to controller

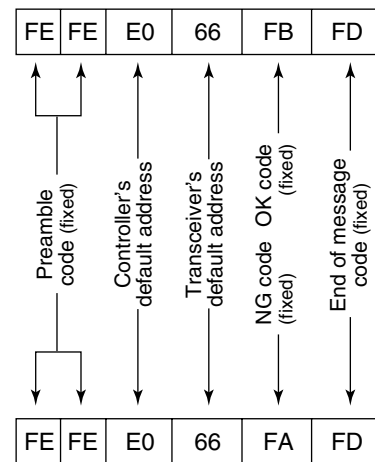

NG message to controller

•Command table

Command	Sub command	Description
00	—	Send frequency data
01	Same as command 06	Send mode data
02	—	Read band edge frequencies
03	—	Read operating frequency
04	—	Read operating mode
05	—	Set operating frequency
06	00	Select LSB
	01	Select USB
	02	Select AM
	03	Select CW
	04	Select RTTY
	05	Select FM
	07	Select CW-R
	08	Select RTTY-R
07	—	Select VFO mode
	00	Select VFO A
	01	Select VFO B
	A0	Equalize VFO A and VFO B

Command	Sub command	Description
07	B0	Exchange VFO A and VFO B
08	—	Select memory mode
	0001–0101*	Select memory channel *P1=0100, P2=0101
	0102	Select the call channel
09	—	Memory write
0A	—	Memory to VFO
0B	—	Memory clear
0C	—	Read offset frequency
0D	—	Set offset frequency
0E	00	Scan stop
	01	Programmed/memory scan start
	02	Programmed scan start
	03	ΔF scan start
	12	Fine programmed scan start
	13	Fine ΔF scan start
	22	Memory scan start
23	Select memory scan start	

•Command table (continued)

Command	Sub command	Description
0E	A1–A7	Set ΔF scan span (A1=±5 kHz, A2=±10 kHz, A3=±20 kHz, A4=±50 kHz, A5=±100 kHz, A6=±500 kHz, A7=±1 MHz)
	B0	Set as non-select channel
	B1	Set as select channel
	D0	Set scan resume OFF
	D3	Set scan resume ON
0F	00	Turn the split function OFF
	01	Turn the split function ON
	10	Select simplex operation
	11	Select –DUP operation
	12	Select +DUP operation
10	00	Select 10 Hz (1 Hz) tuning step
	01	Select 100 Hz tuning step
	02	Select 1 kHz tuning step
	03	Select 5 kHz tuning step
	04	Select 9 kHz tuning step
	05	Select 10 kHz tuning step
	06	Select 12.5 kHz tuning step
	07	Select 20 kHz tuning step
	08	Select 25 kHz tuning step
11	—	Select/read attenuator (0=OFF, 1=ON)
12	—	Select/read antenna selection (0=ANT1, 1=ANT2)
13	00	Announce with voice synthesizer (00=all data; 01=frequency and S-meter level; 02=receive mode)
	01	
	02	
14	01 + Level data	[AF] level setting (0=max. CCW to 255=max. CW)
	02 + Level data	[RF] level setting (0=max. CCW to 255=11 o'clock)
	03 + Level data	[SQL] level setting (0=11 o'clock to 255=max. CW)
	06 + Level data	[NR] level setting (0=min. to 255=max.)
	07 + Level data	Inside [TWIN PBT] setting or IF shift setting (0=max. CCW, 128=center, 255=max. CW)
	08 + Level data	Outside [TWIN PBT] setting (0=max. CCW, 128=center, 255=max. CW)
	09 + Level data	[CW PITCH] setting (0=300 Hz, 128=600 Hz, 255=900 Hz)
	0A + Level data	[RF PWR] setting (0=min. to 255=max.)
	0B + Level data	[MIC GAIN] setting (0=min. to 255=max.)
	0C + Level data	[KEY SPEED] setting (0=slow to 255=fast)
	0D + Level data	[NOTCH] setting (0=low freq. to 255=high freq.)
0E + Level data	COMP Level Delay setting (0=0 to 10=10)	
0F + Level data	Break-IN DELAY setting (20=2.0d to 130=13.0d)	
15	01	Read squelch condition
	02	Read S-meter level
	11	Read RF power meter
	12	Read SWR meter
	13	Read ALC meter
16	02	Preamp (0=OFF; 1=preamp 1; 2=preamp 2)

Command	Sub command	Description
16	12	AGC selection (0=OFF; 1=Slow; 2=Mid; 3=Fast)
	22	Noise blanker (0=OFF; 1=ON)
	40	Noise reduction (0=OFF; 1=ON)
	41	Auto notch (0=OFF; 1=ON)
	42	Repeater tone (0=OFF; 1=ON)
	43	Tone squelch (0=OFF; 1=ON)
	44	Speech compressor (0=OFF; 1=ON)
	45	Monitor (0=OFF; 1=ON)
	46	VOX function (0=OFF; 1=ON)
	47	Break-in (0=OFF; 1=semi break-in; 2=full break-in)
	48	Manual notch (0=OFF; 1=ON)
	49	RTTY filter (0=OFF; 1=ON)
	4B	DTCS (0=OFF; 1=ON)
4C	VSC (0=OFF; 1=ON)	
19	00	Read the transceiver ID
1A	00	Send/read memory contents (see p. 97 for details)
	01	Send/read band stacking register contents (see p. 97 for details)
	02	Send/read memory keyer contents (see p. 97 for details)
	03	Send/read the selected filter width (0=50 Hz to 40/31=3600/2700 Hz)
	04	Send/read the selected AGC time constant (0=OFF, 1=0.1/0.3 sec. to 13=6.0/8.0 sec.)
	0501	Send/read LCD contrast (0=0% to 255=100%)
	0502	Send/read LCD backlight (0=0% to 255=100%)
	0503	Send/read beep gain (0=min. to 255=max.)
	0504	Send/read beep gain limit (0=OFF, 1=ON)
	0505	Send/read calibration marker (0=OFF, 1=ON)
	0506	Send/read confirmation beep (0=OFF, 1=ON)
	0507	Send/read band edge beep (0=OFF, 1=ON)
	0508	Send/read RF/SQL control set (0=Auto, 1=SQL, 2=RF+SQL)
	0509	Send/read meter peak hold set (0=OFF, 1=ON)
	0510	Send/read COMP meter set (0=OFF, 1=ON)
	0511	Send/read quick split set (0=OFF, 1=ON)
0512	Send/read split offset –9.999 to +9.999 MHz (see p. 98 for details)	
0513	Send/read split lock set (0=OFF, 1=ON)	
0514	Send/read duplex offset 0.000 to 9.999 MHz for HF (see p. 98 for details)	
0515	Send/read duplex offset 0.000 to 9.999 MHz for 50 MHz band (see p. 98 for details)	
0516	Send/read duplex offset 0.000 to 9.999 MHz for 144 MHz band (see p. 98 for details)	

•Command table (continued)

Command	Sub command	Description	Command	Sub command	Description
1A	0517	Send/read one touch repeater set (0=DUP-, 1=DUP+)	1A	0548	Send/read FM TX Tone (Treble) level (0=-5 to 10=+5)
	0518	Send/read auto repeater set (0=OFF, 1=ON-1, 2=ON-2)		0549	Send/read FM RX Tone (Bass) level (0=-5 to 10=+5)
	0519	Send/read tuner auto start set (0=OFF, 1=ON)		0550	Send/read FM RX Tone (Treble) level (0=-5 to 10=+5)
	0520	Send/read PTT tune set (0=OFF, 1=ON)		0551	Send/read contact number style (0=Normal, 1=190→ANO, 2=190→ANT, 3=90→NO, 4=90→NT)
	0521	Send/read 9600 bps mode set (0=OFF, 1=ON)		0552	Send/read count up trigger channel (1=M1, 2=M2, 3=M3, 4=M4)
	0522	Send/read antenna selection (0=OFF, 1=Manual, 2=Auto)		0553	Send/read present number (1-9999)
	0523	Send/read speech language (0=English, 1=Japanese)		0554	Send/read CW side tone gain (0=min. to 255=max.)
	0524	Send/read speech speed (0=Slow, 1=Fast)		0555	Send/read CW side tone gain limit (0=OFF, 1=ON)
	0525	Send/read S-level speech (0=OFF, 1=ON)		0556	Send/read CW keyer repeat time (1=1 sec. to 60=60 sec.)
	0526	Send/read memo pad numbers (0=5 ch, 1=10 ch)		0557	Send/read CW keyer dot/dash ratio (28=1:1:2.8 to 45=1:1:4.5)
	0527	Send/read main dial auto TS (0=OFF, 1=Low, 2=High)		0558	Send/read rise time (0=2 msec., 1=4 msec., 2=6 msec., 3=8 msec.)
	0528	Send/read mic. up/down speed (0=Low, 1=High)		0559	Send/read paddle polarity (0=Normal, 1=Reverse)
	0529	Send/read quick RIT/ΔTX clear function (0=OFF, 1=ON)		0560	Send/read keyer type (0=Straight, 1=Bug-key, 2=ELEC-Key)
	0530	Send/read PBT shifting value popup set (0=OFF, 1=ON)		0561	Send/read mic. up/down keyer set (0=OFF, 1=ON)
	0531	Send/read IF filter width popup set (0=OFF, 1=ON)		0562	Send/read RTTY filter bandwidth (0=250 Hz, 1=300 Hz, 2=350 Hz, 3=500 Hz, 4=1 kHz)
	0532	Send/read SSB/CW synchronous tuning function (0=OFF, 1=ON)		0563	Send/read twin peak filter (0=OFF, 1=ON)
	0533	Send/read CW normal side set (0=LSB, 1=USB)		0564	Send/read RTTY mark frequency (0=1275 Hz, 1=1615 Hz, 2=2125 Hz)
	0534	Send/read keyer 1st menu set (0=Keyer-root, 1=Keyer-send)		0565	Send/read RTTY shift width (0=170 Hz, 1=200 Hz, 2=425 Hz)
	0535	Send/read external keypad set (0=OFF, 1=Keyer send)		0566	Send/read RTTY keying polarity (0=Normal, 1=Reverse)
	0536	Send/read CI-V transceive set (0=OFF, 1=ON)		0567	Send/read RTTY decode USOS (0=OFF, 1=ON)
	0537	Send/read CI-V 731 mode set (0=OFF, 1=ON)		0568	Send/read RTTY decode new line code (0=CR,LF,CR+LF, 1=CR+LF)
	0538	Send/read speech compressor level set (0=0 to 10=10)		0569	Send/read number of RTTY decoder line (0=2 lines, 1=3 lines)
	0539	Send/read SSB TX Tone (Bass) level (0=-5 to 10=+5)		0570	Send/read scan speed (0=Low, 1=High)
	0540	Send/read SSB TX Tone (Treble) level (0=-5 to 10=+5)		0571	Send/read scan resume (0=OFF, 1=ON)
	0541	Send/read SSB RX Tone (Bass) level (0=-5 to 10=+5)		0572	Send/read NB level (0=0% to 255=100%)
	0542	Send/read SSB RX Tone (Treble) level (0=-5 to 10=+5)		0573	Send/read VOX gain (0=0% to 255=100%)
	0543	Send/read AM TX Tone (Bass) level (0=-5 to 10=+5)		0574	Send/read anti VOX gain (0=0% to 255=100%)
	0544	Send/read AM TX Tone (Treble) level (0=-5 to 10=+5)		0575	Send/read VOX delay (0=0.0 sec. to 20=2.0 sec.)
	0545	Send/read AM RX Tone (Bass) level (0=-5 to 10=+5)		0576	Send/read Break-IN delay set (20=2.0d to 130=13.0d)
	0546	Send/read AM RX Tone (Treble) level (0=-5 to 10=+5)			
0547	Send/read FM TX Tone (Bass) level (0=-5 to 10=+5)				

• **Command table (continued)**

Command	Sub command	Description
1A	0577	Send/read MONITOR level (0=0% to 255=100%)
	06	Send/read DATA mode (0=OFF, 1=ON)
	07	Send/read SSB transmit bandwidth (0=WIDE, 1=MID, 2=NAR)
	08	Send/read DSP filter shape (0= sharp, 1= soft)
1B	00	Set/read repeater tone frequency (see p. 98 for details)
	01	Set/read TSQL tone frequency (see p. 98 for details)
	02	Set/read DTCS code and polarity (see p. 98 for details)
1C	00	Set/read the transceiver's condition (0=Rx; 1=Tx)
	01	Set/read antenna tuner condition (0=OFF, 1=ON, 2=Start tuning or while tuning)

◆ **To send/read memory contents**

When sending or reading memory contents, additional code as follows must be added to appoint the memory channel.

➤ Additional code: 0000–0102 (0100=P1, 0101=P2, 0102=Call)

◆ **Band stacking register**

To send or read the desired band stacking register's contents, combined code of the frequency band and register codes as follows are used.

For example, when sending/reading the oldest contents in the 21 MHz band, the code "0703" is used.

• **Frequency band code**

Code	Frequency band	Frequency range (unit: MHz)
01	1.8	1.800000– 1.999999
02	3.5	3.400000– 4.099999
03	7	6.900000– 7.499999
04	10	9.900000–10.499999
05	14	13.900000–14.499999
06	18	17.900000–18.499999
07	21	20.900000–21.499999
08	24	24.400000–25.099999
09	28	28.000000–29.999999
10	50	50.000000–54.000000
11	144	144.000000–148.000000
12	GENE	Other than above

• **Register code**

Code	Registered number
01	1 (latest)
02	2
03	3 (oldest)

◆ **Codes for memory keyer contents**

To send or read the desired memory keyer contents, the channel and character codes as follows are used.

• **Channel code**

Code	Channel number
01	M1
02	M2
03	M3
04	M4

• **Character's code**

Character	ASCII code	Description
0–9	30–39	Numerals
A–Z	41–5A	Alphabetical characters
space	20	Word space
/	2F	Symbol
?	3F	Symbol
,	2C	Symbol
.	2E	Symbol
^	5E	e.g., to send \overline{BT} , enter ^4254
*	2A	Inserts contact number (can be used for 1 channel only)

◆ **Codes for memory name contents**

To send or read the desired memory name settings, the character codes, instructed codes for memory keyer contents as above, and follows are additionally used.

• **Character's code— Alphabetical characters**

Character	ASCII code	Character	ASCII code
a–z	61–7A	—	—

• **Character's code— Symbols**

Character	ASCII code	Character	ASCII code
!	21	#	23
\$	24	%	25
&	26	¥	5C
?	3F	"	22
'	27	`	60
+	2B	–	2D
:	3A	;	3B
=	3D	<	3C
>	3E	(28
)	29	[5B
]	5D	{	7B
}	7D		7C
–	5F	–	7E

◆ Split/Duplex frequency setting

The following data sequence is used when sending/reading the split or duplex frequency setting.

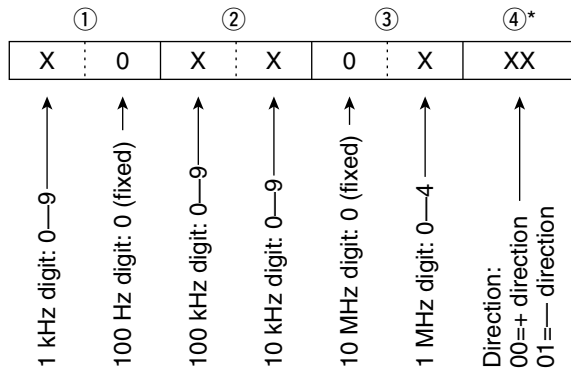

*No need to enter for duplex frequency setting.

◆ Repeater tone/tone squelch frequency setting

The following data sequence is used when sending/reading the DTCS code and polarity setting.

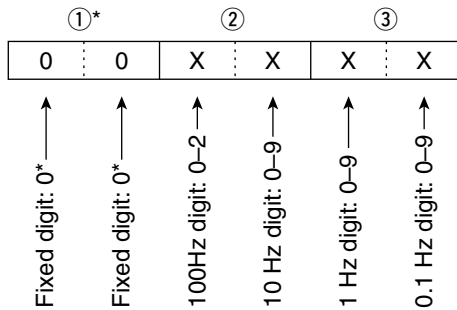

*Not necessary when setting a frequency.

◆ DTCS code and polarity setting

The following data sequence is used when sending/reading the DTCS code and polarity setting.

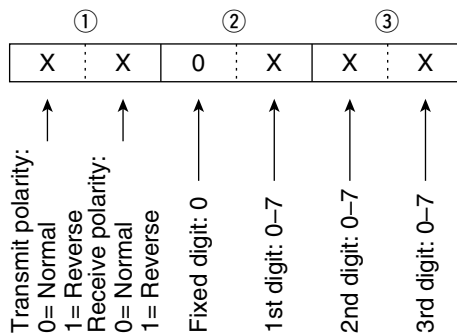

15 SPECIFICATIONS

•General

•Frequency coverage	:	(Unit: MHz)
Receive	:	0.030– 60.000000*1*2
	:	144.000– 146.000000
Transmit	:	1.800– 1.999999*2
	:	3.500– 3.999999*2
	:	7.000– 7.300000*2
	:	10.100– 10.150000*2
	:	14.000– 14.350000*2
	:	18.068– 18.168000*2
	:	21.000– 21.450000*2
	:	24.890– 24.990000*2
	:	28.000– 29.700000*2
	:	50.000– 54.000000*2
	:	144.000– 146.000000

*1Some frequency ranges are not guaranteed.

*2Depending on version.

- Mode : USB, LSB, CW, RTTY, AM, FM
- No. of memory ch. : 102 (99 regular, 2 scan edges and 1 call)
- Antenna connector : SO-239×3 (2 for HF/50 MHz and 1 for 144 MHz; 50 Ω)
- Operating temp. range : -10°C to +60°C ; +14°F to +140°F
- Frequency stability : Less than ±7 ppm from 1 min. to 60 min. after power ON. After that, rate of stability is less than ±1 ppm/hr. at 25°C (+77°F). Temperature fluctuations 0°C to +50°C (+20°F to +122°F) less than ±5 ppm.
- Frequency resolution : 1 Hz
- Power supply : 13.8 V DC ±15% (negative ground)
- Power consumption :

Transmit	Max. power	23.0 A
Receive	Standby	2.2 A
	Max. audio	3.0 A
- Dimensions : 287(W)×120(H)×316.5(D) mm (projections not incl.)
13⁵/₁₆(W)×4²³/₃₂(H)×12¹⁵/₃₂(D) in
- Weight (approx.) : 9.0 kg; 19 lb 13 oz
- ACC 1 connector : 8-pin DIN connector
- ACC 2 connector : 7-pin DIN connector
- DATA connector : Mini DIN 6-pin
- CI-V connector : 2-conductor 3.5 (d) mm (1/8")

•Transmitter

- Output power (continuously adjustable):

SSB/CW/RTTY/FM	Less than 5 to 100 W
AM	Less than 5 to 40 W
- Modulation system :

SSB	PSN modulation
AM	Low power modulation
FM	Phase modulation
- Spurious emission : 50 dB (HF bands)
60 dB (50/144 MHz)
- Carrier suppression : 40 dB
- Unwanted sideband suppression : 55dB
- ΔTX variable range : ±9.99 kHz
- Mic. connector : 8-pin connector (600 Ω)
- ELEC-KEY connector : 3-conductor 6.35(d) mm (1/4")
- KEY connector : 3-conductor 6.35(d) mm (1/4")
- SEND connector : Phono (RCA)
- ALC connector : Phono (RCA)

•Receiver

- Receive system : Triple conversion superheterodyne system
- Intermediate frequencies:

1st	64.455 MHz
2nd	455 kHz
3rd	36 kHz
- Sensitivity (typical) :

SSB, CW, RTTY (10 dB S/N)	0.16 μV*1 (1.80–29.99 MHz)
	0.13 μV*2 (50 MHz)
	0.11 μV*3 (144 MHz)
AM (10 dB S/N)	13 μV (0.5–1.799 MHz)
	2 μV*1 (1.80–29.99 MHz)
	1 μV (50*2/144*3 MHz)
FM (12 dB SINAD)	0.5 μV*1 (28.0–29.99 MHz)
	0.25 μV*2 (50 MHz)
	0.18 μV*3 (144 MHz)

*1Pre-amp 1 is ON, *2Pre-amp 2 is ON, *3Pre-amp is ON

- Squelch sensitivity (Pre-amp: OFF):

SSB, CW, RTTY	Less than 5.6 μV
FM	Less than 1.0 μV
- Selectivity :

SSB (BW: 2.4 kHz)	More than 2.4 kHz/–6 dB
	Less than 3.6 kHz/–60 dB
CW (BW: 500 Hz)	More than 500 Hz/–6 dB
	Less than 700 Hz/–60 dB
RTTY (BW: 350 Hz)	More than 360 Hz/–6 dB
	Less than 650 Hz/–60 dB
AM (BW: 6 kHz)	More than 6.0 kHz/–6 dB
	Less than 15.0 kHz/–60 dB
FM (BW: 15 kHz)	More than 12.0 kHz/–6 dB
	Less than 20.0 kHz/–60 dB
- Spurious and image rejection ratio:

HF/50 MHz	More than 70 dB (except IF through on 50 MHz band)
144 MHz	More than 60 dB
- AF output power : More than 2.0 W at 10% distortion with an 8 Ω load
- RIT variable range : ±9.99 kHz
- PHONES connector : 3-conductor 6.35 (d) mm (1/4")
- Ext. SP connector : 2-conductor 3.5 (d) mm (1/8")/8Ω

•Antenna tuner

- Matching impedance range:

HF bands	16.7 to 150 Ω unbalanced (Less than VSWR 3:1)
50 MHz band	20 to 125 Ω unbalanced (Less than VSWR 2.5:1)
- Minimum operating input power : 8 W (HF bands)
15 W (50 MHz band)
- Tuning accuracy : VSWR 1.5:1 or less
- Insertion loss : Less than 1.0 dB (after tuning)

All stated specifications are typical and subject to change without notice or obligation.

IC-PW1 HF/50 MHz ALL BAND 1 kW LINEAR AMPLIFIER



Full-duty 1 kW linear amplifier including an automatic antenna tuner. Has automatic tuning and band selection capability. Full break-in (QSK) operation is possible. The amplifier/power supply unit and the remote control unit are separated.

PS-125 DC POWER SUPPLY



Light weight switching regulator system power supply.

- Output voltage: 13.8 V DC
- Max. current drain: 25 A

AH-4 HF/50 MHz AUTOMATIC ANTENNA TUNER



Specially designed to tune a long wire antenna for portable or mobile HF operation. The PTT tuner start function provides simple operation.

- Input power rating: 120 W

AH-2b ANTENNA ELEMENT



A 2.5 m long antenna element for mobile operation with the AH-4.

- Frequency coverage: 7–54 MHz bands with the AH-4

SM-20 DESKTOP MICROPHONE



Unidirectional, electret microphone for base station operation. Includes [UP]/[DOWN] switches and a low cut function.

SP-21 EXTERNAL SPEAKER



Designed for base station operation.

- Input impedance: 8 Ω
- Max. input power: 5 W

CT-17 CI-V LEVEL CONVERTER



For remote transceiver control using a personal computer. You can change frequencies, operating mode, memory channels, etc.

UT-102 VOICE SYNTHESIZER UNIT

Announces the receive frequency, mode and S-meter level in a clear, electronically-generated voice, in English (or Japanese).

SP-20 EXTERNAL SPEAKER

4 audio filters; headphone jack; can connect to 2 transceivers.

- Input impedance: 8 Ω
- Max. input power: 5 W

CR-338 HIGH STABILITY CRYSTAL UNIT

Contains a temperature-compensating oven heater and crystal unit for improved frequency stability.

- Frequency stability: ±0.5 ppm

HM-36 HAND MICROPHONE

Hand microphone equipped with [UP]/[DOWN] switches.

•About DC power supply

The use of IC-7400 (#03, #04, #05, #08, #09) in combination with the DC power supply complies with European Harmonised Standard regulations under the conditions listed below.

Conditions

- In combination with PS-125

•About IC-PW1 LINEAR AMPLIFIER

The IC-PW1 LINEAR AMPLIFIER does not comply with European Harmonised Standard regulations. Please do not use this equipment within European countries.

INSTALLATION NOTES

For amateur base station installations it is recommended that the forwards clearance in front of the antenna array is calculated relative to the EIRP (Effective Isotropic Radiated Power). The clearance height below the antenna array can be determined in most cases from the RF power at the antenna input terminals.

As different exposure limits have been recommended for different frequencies, a relative table shows a guideline for installation considerations.

Below 30 MHz, the recommended limits are specified in terms of V/m or A/m fields as they are likely to fall within the near-field region. Similarly, the antennae may be physically short in terms of electrical length and that the installation will require some antenna matching device which can create local, high intensity magnetic fields. Analysis of such MF installations is best considered in association with published guidance notes such as the FCC OET Bulletin 65 Edition 97-01 and its annexes relative to amateur transmitter installations. The EC recommended limits are almost identical to the FCC specified 'uncontrolled' limits and tables exist that show pre-calculated safe distances for different antenna types for different frequency bands. Further information can be found at <http://www.arrl.org/>.

•Typical amateur radio installation

Exposure distance assumes that the predominant radiation pattern is forwards and that radiation vertically downwards is at unity gain (sidelobe suppression is equal to main lobe gain). This is true of almost every gain antenna today. Exposed persons are assumed to be beneath the antenna array and have a typical height to 1.8 m.

The figures assume the worst case emission of constant carrier.

For the bands 10 MHz and higher the following power density limits have been recommended:

10–144 MHz 2 W/sq m

EIRP clearance heights by frequency band

1 Watts	2.1 m
10 Watts	2.8 m
25 Watts	3.4 m
100 Watts	5 m
1000 Watts	12 m

Forward clearance, EIRP by frequency band

100 Watts	2 m
1000 Watts	6.5 m
10,000 Watts	20 m
100,000 Watts	65 m

In all cases any possible risk depends on the transmitter being activated for long periods. (actual recommendation limits are specified as an average during 6 minutes) Normally the transmitter is not active for long periods of time. Some radio licenses will require that a timer circuit automatically cuts the transmitter after 1–2 minutes etc.

Similarly some types of transmitter, SSB, CW, AM etc. have a lower 'average' output power and the assessed risk is even lower.



Versions of the IC-7400 which display the "CE" symbol on the serial number seal, comply with the essential requirements of the European Radio and Telecommunication Terminal Directive 1999/5/EC.



This warning symbol indicates that this equipment operates in non-harmonised frequency bands and/or may be subject to licensing conditions in the country of use. Be sure to check that you have the correct version of this radio or the correct programming of this radio, to comply with national licensing requirement.



**DECLARATION
OF CONFORMITY**

We Icom Inc. Japan
1-1-32, Kamiminami, Hirano-ku
Osaka 547-0003, Japan

Declare on our sole responsibility that this equipment complies with the essential requirements of the Radio and Telecommunications Terminal Equipment Directive, 1999/5/EC, and that any applicable Essential Test Suite measurements have been performed.

Kind of equipment: HF/VHF ALL MODE TRANSCEIVER

Type-designation: IC-7400

Version (where applicable):
This compliance is based on conformity according to Annex III of the directive 1999/5/EC using the following harmonised standards:

- i) Article 3.1a EN 60950 + A11
- ii) Article 3.1b EN 301489-1 and EN 301489-15 (or ETS 300 684)
- iii) Article 3.2 EN 301 783-2
- iv) _____
- v) _____



Düsseldorf 25th Jan. 2002
Place and date of issue

Icom (Europe) GmbH
Himmelgeister strasse 100
D-40225 Düsseldorf
Authorized representative name

T. Maebayashi
General Manager

 Signature
Icom Inc.

•Version and frequency coverage

Europe (#03)	
Receive	Transmit
0.500– 29.999 MHz	1.800– 1.850 MHz
50.000– 54.000 MHz	3.500– 3.800 MHz
144.000–146.000 MHz	7.000– 7.100 MHz
	10.100– 10.150 MHz
	14.000– 14.350 MHz
	18.068– 18.168 MHz
	21.000– 21.450 MHz
	24.890– 24.990 MHz
	28.000– 29.700 MHz
	50.000– 52.000 MHz
	144.000–146.000 MHz

Italy (#08)	
Receive	Transmit
1.830– 1.850 MHz	1.830– 1.850 MHz
3.500– 3.800 MHz	3.500– 3.800 MHz
7.000– 7.100 MHz	7.000– 7.100 MHz
10.100– 10.150 MHz	10.100– 10.150 MHz
14.000– 14.350 MHz	14.000– 14.350 MHz
18.068– 18.168 MHz	18.068– 18.168 MHz
21.000– 21.450 MHz	21.000– 21.450 MHz
24.890– 24.990 MHz	24.890– 24.990 MHz
28.000– 29.700 MHz	28.000– 29.700 MHz
50.000– 51.000 MHz	50.000– 51.000 MHz
144.000–146.000 MHz	144.000–146.000 MHz

France (#04)	
Receive	Transmit
1.810– 1.850 MHz	1.810– 1.850 MHz
3.500– 3.800 MHz	3.500– 3.800 MHz
7.000– 7.100 MHz	7.000– 7.100 MHz
10.100– 10.150 MHz	10.100– 10.150 MHz
14.000– 14.350 MHz	14.000– 14.350 MHz
18.068– 18.168 MHz	18.068– 18.168 MHz
21.000– 21.450 MHz	21.000– 21.450 MHz
24.890– 24.990 MHz	24.890– 24.990 MHz
28.000– 29.700 MHz	28.000– 29.700 MHz
50.200– 51.200 MHz	50.200– 51.200 MHz
144.000–146.000 MHz	144.000–146.000 MHz

Spain (#09)	
Receive	Transmit
1.830– 1.850 MHz	1.830– 1.850 MHz
3.500– 3.800 MHz	3.500– 3.800 MHz
7.000– 7.100 MHz	7.000– 7.100 MHz
10.100– 10.150 MHz	10.100– 10.150 MHz
14.000– 14.350 MHz	14.000– 14.350 MHz
18.068– 18.168 MHz	18.068– 18.168 MHz
21.000– 21.450 MHz	21.000– 21.450 MHz
24.890– 24.990 MHz	24.890– 24.990 MHz
28.000– 29.700 MHz	28.000– 29.700 MHz
50.000– 50.200 MHz	50.000– 50.200 MHz
144.000–146.000 MHz	144.000–146.000 MHz

Denmark (#05)	
Receive	Transmit
0.500– 29.999 MHz	1.800– 1.999 MHz
50.000– 54.000 MHz	3.500– 3.999 MHz
144.000–146.000 MHz	7.000– 7.300 MHz
	10.100– 10.150 MHz
	14.000– 14.350 MHz
	18.068– 18.168 MHz
	21.000– 21.450 MHz
	24.890– 24.990 MHz
	28.000– 29.700 MHz
	50.000– 52.000 MHz
	144.000–146.000 MHz

Count on us!

IC-7400
#03 (Europe)

<Intended Country of Use>			
<input checked="" type="checkbox"/> GER	<input checked="" type="checkbox"/> NED	<input type="checkbox"/> ITA	<input checked="" type="checkbox"/> AUT
<input type="checkbox"/> BEL	<input type="checkbox"/> GRE	<input checked="" type="checkbox"/> GBR	<input checked="" type="checkbox"/> LUX
<input checked="" type="checkbox"/> SWE	<input checked="" type="checkbox"/> IRL	<input type="checkbox"/> ESP	<input type="checkbox"/> DEN
<input type="checkbox"/> FRA	<input type="checkbox"/> POR	<input checked="" type="checkbox"/> FIN	<input type="checkbox"/> SUI

IC-7400
#04 (France)

<Intended Country of Use>			
<input type="checkbox"/> GER	<input type="checkbox"/> NED	<input type="checkbox"/> ITA	<input type="checkbox"/> AUT
<input type="checkbox"/> BEL	<input type="checkbox"/> GRE	<input type="checkbox"/> GBR	<input type="checkbox"/> LUX
<input type="checkbox"/> SWE	<input type="checkbox"/> IRL	<input type="checkbox"/> ESP	<input type="checkbox"/> DEN
<input checked="" type="checkbox"/> FRA	<input type="checkbox"/> POR	<input type="checkbox"/> FIN	<input type="checkbox"/> SUI

IC-7400
#05 (Denmark)

<Intended Country of Use>			
<input type="checkbox"/> GER	<input type="checkbox"/> NED	<input type="checkbox"/> ITA	<input type="checkbox"/> AUT
<input type="checkbox"/> BEL	<input type="checkbox"/> GRE	<input type="checkbox"/> GBR	<input type="checkbox"/> LUX
<input type="checkbox"/> SWE	<input type="checkbox"/> IRL	<input type="checkbox"/> ESP	<input checked="" type="checkbox"/> DEN
<input type="checkbox"/> FRA	<input type="checkbox"/> POR	<input type="checkbox"/> FIN	<input type="checkbox"/> SUI

IC-7400
#08 (Italy)

<Intended Country of Use>			
<input type="checkbox"/> GER	<input type="checkbox"/> NED	<input checked="" type="checkbox"/> ITA	<input type="checkbox"/> AUT
<input type="checkbox"/> BEL	<input type="checkbox"/> GRE	<input type="checkbox"/> GBR	<input type="checkbox"/> LUX
<input type="checkbox"/> SWE	<input type="checkbox"/> IRL	<input type="checkbox"/> ESP	<input type="checkbox"/> DEN
<input type="checkbox"/> FRA	<input type="checkbox"/> POR	<input type="checkbox"/> FIN	<input type="checkbox"/> SUI

IC-7400
#09 (Spain)

<Intended Country of Use>			
<input type="checkbox"/> GER	<input type="checkbox"/> NED	<input type="checkbox"/> ITA	<input type="checkbox"/> AUT
<input type="checkbox"/> BEL	<input type="checkbox"/> GRE	<input type="checkbox"/> GBR	<input type="checkbox"/> LUX
<input type="checkbox"/> SWE	<input type="checkbox"/> IRL	<input checked="" type="checkbox"/> ESP	<input type="checkbox"/> DEN
<input type="checkbox"/> FRA	<input checked="" type="checkbox"/> POR	<input type="checkbox"/> FIN	<input type="checkbox"/> SUI