

IC-745

HF ALL BAND TRANSCEIVER
GENERAL COVERAGE RECEIVER

INSTRUCTION MANUAL



TABLE OF CONTENTS

SECTION 1	SPECIFICATIONS	1
SECTION 2	FEATURES	2
SECTION 3	INSTALLATION	3
SECTION 4	OPERATING CONTROLS.....	6
4- 1	FRONT PANEL.....	6
4- 2	TOP COVER	9
4- 3	REAR PANEL CONNECTIONS.....	10
SECTION 5	OPERATING INSTRUCTIONS.....	11
5- 1	HOW TO TUNE	11
5- 2	MEMORY CHANNEL OPERATION	15
5- 3	TUNING BY UP/DOWN BUTTONS ON THE MICROPHONE.....	16
5- 4	SCANNING OPERATION.....	17
5- 5	SSB OPERATION	18
5- 6	CW OPERATION.....	21
5- 7	RTTY OPERATION	21
5- 8	AM OPERATION.....	22
5- 9	FM OPERATION (OPTION)	22
5- 10	GENERAL COVERAGE RECEIVER.....	23
5- 11	OTHER OPERATIONS	23
SECTION 6	OPTION INSTALLATION.....	25
SECTION 7	INSIDE VIEWS	31
SECTION 8	TROUBLESHOOTING.....	33
SECTION 9	BLOCK DIAGRAM	34
SECTION 10	SCHEMATIC DIAGRAM.....	SEPARATE

SECTION 1 SPECIFICATIONS

GENERAL

Frequency Coverage:

Ham Band	1.8 MHz ~ 2.0MHz
	3.45MHz ~ 4.1MHz
	6.95MHz ~ 7.5MHz
	9.95MHz ~ 10.5MHz
	13.95MHz ~ 14.5MHz
	17.95MHz ~ 18.5MHz
	20.95MHz ~ 21.5MHz
	24.45MHz ~ 25.1MHz
	27.95MHz ~ 30.0MHz

General Cover (Receive Only)

0.1MHz ~ 30.0MHz

Thirty 1MHz Segments (or Continuous)

RIT/XIT Coverage ±1.0KHz

Frequency Control:

CPU based 10Hz step Digital PLL synthesizer.

Independent Transmit-Receive Frequency Available

Frequency Readout:

6 digit 100Hz readout.

Frequency Stability:

Less than ±500Hz after switch on 1 min to 60 mins, and less than ±100Hz after 1 hour. Less than ±1KHz in the range of -10°C ~ +60°C.

Power Supply Requirements:

DC 13.8V ±15% Negative ground Current drain 20A max. (at 200W input)

AC power supply is available for AC operation.

Antenna Impedance:

50 ohms Unbalanced

Weight:

8.0Kg (11Kg; when optional power supply is installed)

Dimensions:

111(123) mm(H) x 280(304) mm(W) x 355(383) mm(D)

*() ; including projections

TRANSMITTER

RF Power:

SSB (A₃J) 200 Watts PEP input

CW (A₁), RTTY (F₁) 200 Watts input

FM (F₃)* 200 Watts input

Continuously Adjustable Output power 10 Watts ~ Max.

Emission Mode:

A₃J SSB (Upper sideband and Lower sideband)

A₁ CW

F₁ RTTY (Frequency Shift Keying)

F₃ FM

Harmonic Output:

More than 40dB below peak power output

Spurious Output:

More than 60dB below peak power output

Carrier Suppression:

More than 40dB below peak power output

Unwanted Sideband:

More than 55dB down at 1000Hz AF input

Microphone:

Impedance 600 ohms

Input Level 12 millivolts typical

Dynamic or Electret Condenser Microphone

(Optional IC-HM12 or IC-SM6 can be used.)

RECEIVER

Receiving System:

SSB, CW, RTTY, AM

Triple Conversion Superheterodyne with continuous Bandwidth Control.

FM* Triple Conversion Superheterodyne

Receiving Mode:

A₁, A₃J (USB, LSB) F₁ (Output FSK audio signal), A₃ (Receive only) F₃*

IF Frequencies:

1st 70.4515MHz

2nd 9.0115MHz

3rd 455KHz

Sensitivity:

SSB, CW, RTTY

0.1 ~ 1.6MHz Less than 3.2μV for 10dB S/N

1.6 ~ 30MHz Less than 0.15μV for 10dB S/N

AM 0.1 ~ 1.6MHz Less than 20μV for 10dB S/N

1.6 ~ 30MHz Less than 1μV for 10dB S/N

FM* 1.6 ~ 30MHz Less than 0.3μV for 12dB SINAD

Squelch Sensitivity:

1.6 ~ 30MHz Less than 0.5μV

Selectivity:

SSB, CW, RTTY

2.2KHz (Adjustable to 0.8KHz Min)

at -6dB

4.2KHz at -60dB

AM 2.4KHz at -6dB, 4.8KHz at -60dB

(When Filter switch ON)

4.0KHz at -6dB, 15KHz at -60dB

FM* 15KHz at -6dB, 30KHz at -50dB

Notch Filter Attenuation:

More than 30dB

Spurious Response Rejection Ratio:

More than 60dB

Audio Output:

More than 2.8 Watts

Audio Output Impedance:

8 Ohms

* When optional FM unit is installed.

Specifications are approximate and are subject to change without notice or obligation.

SECTION 2 FEATURES

ALL BAND, ALL MODE, ALL SOLID-STATE

The IC-745 covers all the Amateur HF frequencies from 1.8MHz to 29.700MHz, including the new three bands of 10MHz, 18MHz and 24MHz. It offers not only SSB, but also CW, AM (Receive only), FM (Option) and RTTY. All of the circuits in the IC-745, including the driver and final power stages are completely solid-state, and provide about 100 watts output.

GENERAL COVERAGE RECEIVER CAPABILITY

The IC-745 has capabilities for an all amateur band transceiver as well as a general coverage receiver between 100KHz and 30MHz with continuous tuning. The Up-conversion system using a high side IF and Microcomputer Control System make these capabilities possible.

In addition to these, the low-pass filters and the band-pass filters are selected by an electric signal from the CPU and it makes a no tune-up system.

DUAL VFO

Dual VFO's controlled by a large tuning knob provide easy access to split frequencies used in DX operation. Normal tuning rate is in 10Hz increments and increasing the speed of rotation of the main tuning knob shifts the tuning to 50Hz increments automatically. Pushing the tuning speed button gives 1KHz tuning.

16 MEMORIES

Sixteen tunable memories are provided to store mode, HAM/GENERAL COVERAGE mode, and frequency, and the RAM is backed up by an internal lithium memory backup battery to maintain the memories for up to seven years. Scanning of frequencies, memories and bands are possible from the unit, or from the IC-HM12 scanning microphone. Data may be transferred between VFO's, or from VFO to memories.

OUTSTANDING RECEIVER PERFORMANCE

Utilizing an ICOM developed Double Balanced Mixer, the IC-745 has a 100dB dynamic range. The 70.4515MHz first IF virtually eliminates spurious responses, and a high gain 9.0115MHz second IF, with ICOM's PBT provides the ultimate in selectivity. A deep IF notch filter, adjustable AGC and noise blanker (can be adjusted to eliminate the woodpecker), audio tone control, plus RIT provide clear reception even in the presence of strong QRM or high noise levels. A low noise receiver preamp provides exceptional reception sensitivity as required.

TRANSMITTER

The transmitter features high reliability transistors in a low IMD ($-38\text{dB} \sim 100\text{W}$), full 100% duty cycle (internal cooling fan standard), 12 volt DC design. Quiet relay selection of transmitter LPF's, transmit audio tone control, monitor circuit (to monitor your own CW or SSB signal), XIT, and a high performance speech processor enhance the IC-745 transmitter's operation. For the CW operator, optional keyer and semi break-in are provided for smooth and fast keying.

OTHER FEATURES

All of the above features plus full function metering, SSB and FM squelch, convenient large controls, a large selection of filters, and a high visibility fluorescent display make the IC-745 your best choice for a superior grade HF base transceiver.

SECTION 3 INSTALLATION

BE SURE TO READ THE FOLLOWING INSTRUCTIONS CAREFULLY BEFORE OPERATION

3-1 UNPACKING

Carefully remove your transceiver from the packing carton and examine it for signs of shipping damage. Should any be apparent, notify the delivering carrier or dealer immediately, stating the full extent of the damage. It is recommended you keep the shipping cartons. In the event storage, moving, or reshipment becomes necessary they will be handy. Accessory cables, plugs, etc., are packed with the transceiver. Make sure you have not overlooked anything.

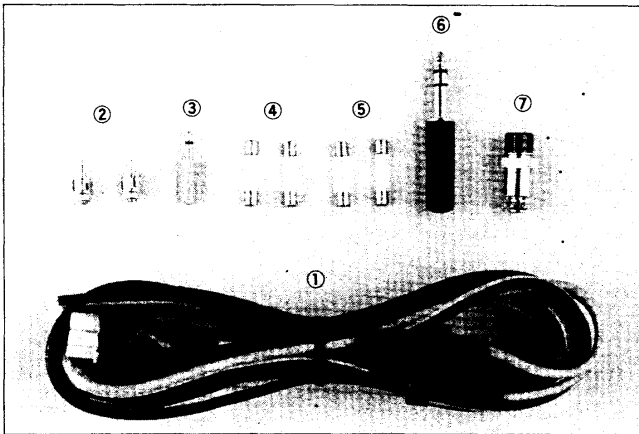

- | | |
|------------------------------------|---|
| 1. DC Power Cord | 1 |
| 2. Pin Plugs | 2 |
| 3. External Speaker Plug | 1 |
| 4. Spare Fuses (20 Amp) | 2 |
| 5. Spare Fuses (3 Amp) | 2 |
| 6. Key Plug | 1 |
| 7. 8 pin Microphone Plug | 1 |

3-2 RECOMMENDATIONS FOR INSTALLATION

1. Avoid placing the IC-745 in direct sunlight, high temperature, dusty or humid places.
2. The temperature of the set will usually become relatively warm during transmission. Any equipment should be at least 1 inch (3cm) away from the unit so as to provide good ventilation. Be sure that nothing is on and just behind the rear PA heatsink to ensure good ventilation. Also avoid places near outlets of heaters, air conditioners etc.
3. Place the unit so that the controls and switches can easily be handled and the frequency indication and meter can easily be read.
4. For mobile installation, an optional mounting bracket is available. Select the best location that can stand the weight of the unit and that does not interfere with your driving in any way.
5. Use the Ground Lug!

3-3 POWER SUPPLY

For AC operation, use the special power supply IC-PS15, IC-PS30, or optional built-in power supply IC-PS35. If you

would like to use your car battery or any other DC power supply, be sure that its output voltage is 12-15 Volts and the current capacity is at least 20 Amps. The maximum power consumption of the set during transmission runs from 16-20 Amps, so keep that in mind if the unit is installed in your automobile, and turn it on after you have started the engine. Attention should also be paid to the condition of the battery and electrical system.

The connection of the DC power cord supplied with the IC-745 is done in the following way: First make sure that the power switch of the unit is in the OFF position and the T/R switch is in the receive position. Connect the cord to the DC power supply with the RED lead to the positive terminal and the BLACK lead to the negative terminal. (Reverse connection will cause the protection circuit to operate and blow the fuse.) Connect the DC plug to the socket on the rear panel of the IC-745. Refer to the drawing below.

For AC operation (with IC-PS15)

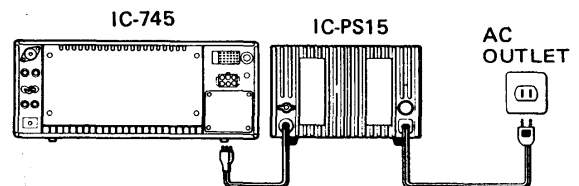

For AC operation (when optional IC-PS35 is installed).

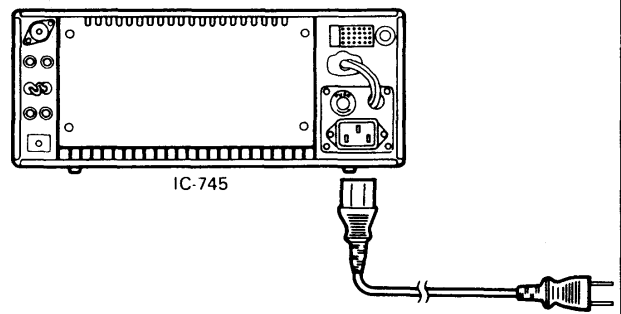

For DC operation

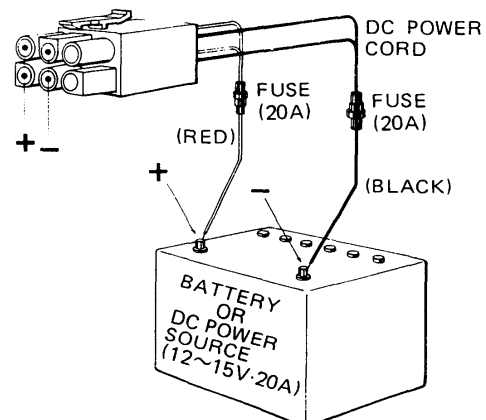

3 - 4 ANTENNA

Antennas play a very important role in radio communication. If the antenna is inferior, your transceiver cannot give you the best performance. With a good antenna and feeder cable having 50 ohms impedance, you should easily get the desired matching and performance. Carefully install a high performance antenna that suits the frequency band(s) you wish to operate on and place it as high as possible. Be especially careful of the condition of the connectors as loose connections will deteriorate the performance. Be sure to connect the ground terminal of a whip antenna, if used, to the body of your car.

As the output is quite high, avoid connecting the antenna connector to open lines and do not transmit under mismatched conditions. Otherwise the final stage could be overloaded and cause a malfunction of the unit.

Since the IC-745 has a General Coverage receiver it is recommended that a long-wire general coverage antenna and an antenna coupler be used. The antenna's impedance should be 50 ohms. To attempt to use the Ham band antenna for general coverage reception could result in mismatching, and attendant poor reception.

When receiving lower than 1600KHz, connect the antenna to the "LOW BAND ANT" terminal.

3 - 5 GROUND

In order to prevent electrical shocks, TVI, BCI and other problems, be sure to connect a heavy wire ground, as short as possible, from a good earth point to the ground terminal on the rear panel.

3 - 6 MICROPHONE

The optional electret condenser type hand microphone IC-HM12 or stand microphone IC-SM6 can be used. Merely plug it into the proper receptacle on the front panel. Should you wish to use a different microphone, make certain it has proper output level. Particular care should be exercised in wiring also, as the internal electrical switching system is dependent upon it. Refer the schematics for the proper hookup.

Microphone plug exploded View

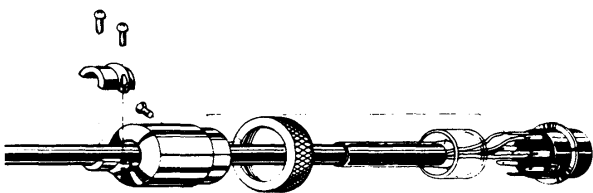

Schematic diagram of IC-HM12

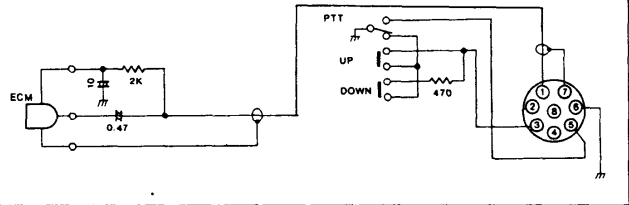

Schematic diagram of IC-SM6

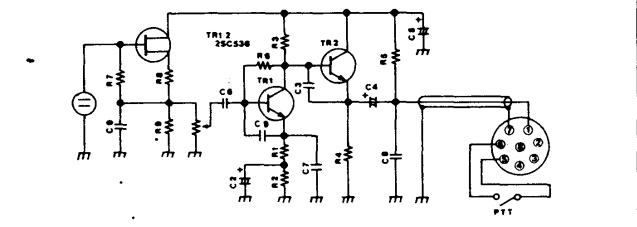

3 - 7 CW KEY

When operating CW, connect a key to the Key Jack with a 1/4 inch 3-P plug. The connection of the plug is shown below.

Wiring for a hand key or external electronic keyer.

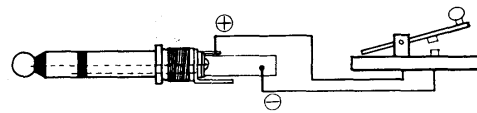

Wiring for an iambic paddle (when optional keyer unit is installed.)

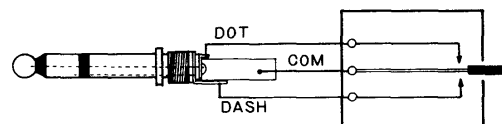

If the terminals have polarity, be sure to make the correct connection. Note that the keyed voltage when switching with semiconductors or relays with resistors in the circuit, should be adjusted to be below 0.4 Volts!

3 - 8 RTTY

When operating RTTY, connect the ACC socket pins 8 (ground) and 9 to your tele-typewriter through a high speed relay or a level converter to TTL level, and the tones for your terminal unit will be available from pin 4. The AF output level is about 300mVp-p for S-9 signal. For details, refer to 5 - 7 RTTY OPERATION on page 21.

3 - 9 EXTERNAL SPEAKER

The IC-745 contains an internal speaker, and is also designed so that it can drive an external speaker from the external (EXT) speaker jack on the rear panel. Be sure the impedance of the external speaker is 8 ohms, and remember that with the external speaker connected, the internal speaker is disabled.

3 - 10 HEADPHONES

Any good headphone set, including stereo type, that have 4-16 ohms impedance can be used. With the plug inserted halfway into the PHONES jack, both the headphone and speaker will operate. This is convenient when others wish to listen in on the station, or you wish to record contacts using a tape recorder connected to the headphone jack. With a stereo headphone set inserted this way, however, the headphone will lose the sound on one side. With the plug inserted completely, only the headphone works.

3 - 11 COOLING FAN

The rear of the PA unit is designed to provide for adequate cooling, but with 200 Watts input the final stage produces quite a bit of heat, and its temperature may rise during prolonged transmissions. The fan is connected to a temperature monitoring circuit which monitors the temperature of the final stage. The fan operates as follows:

1. The fan does not operate both in the receive and transmit modes.
2. When the temperature rises to a point (50°C) detected by the monitor circuit the fan will operate during both transmit and receive to provide additional cooling.
3. If the temperature rises to a danger limit (90°C) the fan will run much more rapidly. At this time the output power is reduced to 50 Watts. Investigate the cause of overheating i.e. antenna mismatch, etc. and correct the cause of the overheating before starting to transmit again.

3 - 12 ACCESSORY (ACC) SOCKET

Various functions are available through the accessory socket such as modulation output, receiver output, T/R change-over, and so forth. The table below shows those terminals.

ACC SOCKET CONNECTIONS

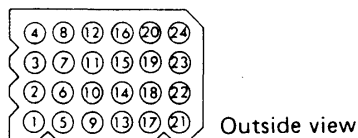

PIN No.	FUNCTION
4.	Output from the receive detector stage. Fixed output regardless of AF output or AF gain.
5.	Output from Transmitter MIC amplifier stage. (Input for MIC gain control stage.)
6.	8 Volt DC is available when transmitting. (relay can not be directly actuated. Max. 5mA).
7.	Input for external ALC voltage.
8.	Ground
9.	Input for RTTY keying (MARK: HIGH level, SPACE: LOW level).
10.	NC (No Connection)
11.	Input for TRANSVERTER control. When 8 Volt DC is applied, the set can operate with a transverter.
12.	Output reference voltage for band switching.
13.	Output for external band switching.
14.~24.	NC

3 - 13 CAUTIONS

As the unit has already been closely adjusted with highly sophisticated measuring instruments, never tamper with the turnable resistors, coils, trimmers, etc.

C-MOS is used in the Logic unit as well as the PLL. C-MOS ICs are very susceptible to excessive static charges and over current and care must be used when handling them. Therefore, avoid touching the Logic unit and the nearby circuitry unless absolutely necessary. When it is necessary to check the circuitry, observe the following points.

Ground all measuring instruments, the soldering iron, and other tools. Do not connect or disconnect the C-MOS IC from its socket, or solder it when the power is on. Do not apply voltage of less than -0.5 or more than +5 Volts to the input terminals of the IC. DO NOT MEASURE WITH AN OHMMETER.

PIN No.	FUNCTION
1.	Output from the discriminator circuit. (When optional FM unit is installed).
2.	13.8 Volt DC in conjunction with the power switch operation.
3.	Connected to Push-to-talk, T/R change-over switch. When grounded, the set operates in the transmit mode.

SECTION 4 OPERATING CONTROLS

4-1 FRONT PANEL

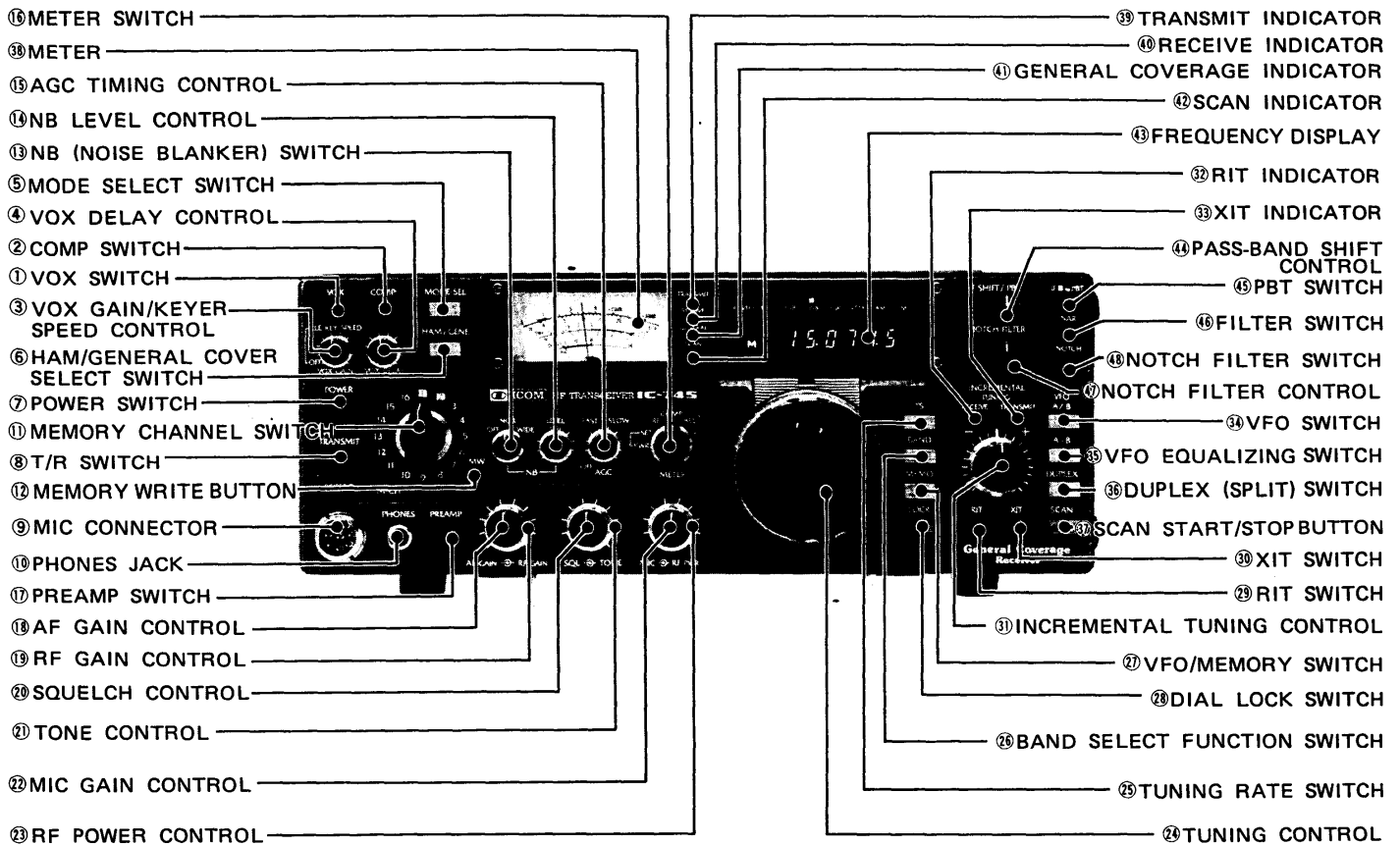

1. VOX SWITCH

This switches the VOX circuit ON and OFF. When it is in the ON (in) position, in SSB or FM, T/R switching is accomplished by means of a voice signal. In CW operation, semi-break-in switching by means of keying is possible.

2. COMP (SPEECH PROCESSOR) SWITCH

Switches the speech processor circuit ON and OFF. This circuit enables greater talk power and better results in DX operation.

3. VOX GAIN/KEYER SPEED CONTROL

This control adjusts input signal level via the microphone to the VOX circuit. For VOX operation in SSB and FM, adjust the control so that the VOX circuit will operate with normal speech.

When the optional electronic keyer unit is installed and the set is in CW mode, this control adjusts keying speed of the keyer.

4. VOX DELAY (VOX time constant) CONTROL

This controls the transmit to receive switching time. Adjust it so transmit to receive switching will not occur during short pauses in normal speech.

5. MODE SELECT SWITCH

Selects any one of six operating modes. Each push of the switch changes the mode in order of LSB, USB, CW, RTTY, AM (receive only) and FM (option). The selected mode is shown on the FREQUENCY DISPLAY.

6. HAM BAND/GENERAL COVER SELECT SWITCH

Each push selects the function of the set alternately. In the HAM BAND mode, the transceiver functions in any of nine HAM bands between 1.8MHz and 28MHz. In the GENERAL COVERAGE mode the set functions as a general coverage receiver between 0.1MHz and 30MHz. (The set will not transmit in this mode.)

7. POWER SWITCH

The POWER SWITCH is a push-lock type switch which controls the input DC power to the IC-745. When the external AC power supply (IC-PS15 or IC-PS30) or optional built-in AC power supply (IC-PS35) is used, the switch also acts as the AC power supply switch. When the switch is pushed in and locked, power is supplied to the set. When the switch is pushed again and released, power is cut to all circuits (except the PA unit when using an external DC power supply).

8. T/R (TRANSMIT/RECEIVE) SWITCH

This switch is for manually switching from transmit to receive and vice versa. Set the switch to RECEIVE (down) and the IC-745 is in the receive mode. Set the switch to TRANSMIT (up) and it switches to transmit. When switching with the PTT switch on the microphone or with the VOX switch set to ON, the T/R switch must be in the RECEIVE position.

9. MIC CONNECTOR

Connect a suitable microphone to this jack. The optional hand microphone IC-HM12 or stand microphone IC-SM6 can be used. If you wish to use a different microphone, refer to the drawings on page 4.

10. PHONES JACK

Accepts a standard 1/4 inch headphone plug for headphones of 4 ~ 16 ohms. Stereo phones can be used without modification.

11. MEMORY CHANNEL SWITCH

Selects any one of sixteen memory channels in the MEMORY CHANNEL operation.

12. MEMORY WRITE BUTTON

By pushing this button, a displayed frequency, mode and HAM/GENE operation are stored into a memory channel which is selected by the MEMORY CHANNEL switch.

13. NB (NOISE BLANKER) SWITCH

When pulse type noise such as automobile ignition noise is present, set this switch to the NOR or WIDE position. The noise will be reduced to provide comfortable reception.

The blanking time can be selected NORMAL and WIDE by this switch. It will be effective against any type noises.

14. NB LEVEL CONTROL

Controls the threshold level of the noise blanker. Adjust the control so that incoming noises will be disappeared.

15. AGC TIMING CONTROL

For changing the time-constant of the AGC (Automatic Gain Control) circuit. By turning the control clockwise, the AGC voltage is released more slowly. Adjust the control to provide comfortable reception.

When the control is in the OFF position, the AGC function is turned OFF and the S-meter does not swing even if a signal has being received. (The AGC does not actuate on the FM mode.)

16. METER SWITCH

In the transmit mode, the meter has five functions.

- 1c Indicates the collector current of the final transistors.
2. ALC Indicates the ALC level. The meter begins to function when the RF output power reaches a certain level.

3. COMP Indicates the compression level when the speech processor is in use.
4. RF Indicates an approximate RF output power.
5. SET/SWR SWR can be measured by setting this switch to the SET position and calibrating the meter needle to the "SET" position with the RF POWER control, then setting this switch to the SWR position.

17. PREAMP SWITCH

Switches the preamplifier for the receiver.

18. AF GAIN CONTROL

Controls the audio output level in the receive mode. Clockwise rotation increases the level.

19. RF GAIN CONTROL

Controls the gain of the RF section in the receive mode. Clockwise rotation gives the maximum gain. As the control is rotated counterclockwise, the needle of the METER rises, and only signals stronger than the level indicated by the needle will be heard.

20. SQUELCH CONTROL

Sets the squelch threshold level. To turn OFF the squelch function, rotate this control completely counterclockwise. To set the threshold level higher, rotate the control clockwise.

21. TONE CONTROL

Controls the receiver audio tone. Adjust the control to provide comfortable reception.

22. MIC GAIN CONTROL

Adjusts the level of modulation according to the input of the microphone. Clockwise rotation increases the microphones gain. As the input will vary with different microphones and different voices, the knob should be turned until the Meter needle, in the ALC mode, begins to move slightly within the ALC zone. In the SSB mode when the speech processor is in use, the MIC GAIN CONTROL sets a clipping limit, while the RF POWER CONTROL sets the RF drive level to the maximum power level, where ALC starts at the saturation point of the amplifiers.

23. RF POWER CONTROL

Controls the RF output power 10 Watts to maximum (SSB: 100 Watts PEP, CW, RTTY FM (option): 100 Watts). Clockwise rotation increases the output power. (AM is receive only.)

24. TUNING CONTROL

Rotating this control clockwise increases the frequency or the memory channel number, while rotating it counterclockwise decreases it. The frequency changes by 10Hz in any mode. In 10Hz step tuning rate, by turning the tuning control faster, the 50Hz step tuning rate is automatically selected. This makes it very convenient to make a QSY over a wide frequency range.

This control is also used to select the operating band while the BAND SELECT FUNCTION switch is depressed.

25. TUNING RATE SWITCH

By pushing in this switch, the operating frequency is changed to correspond to 1KHz increments in any mode.

At the same time, the 100Hz digit on the display is cleared to show "0". When this switch is pushed again and released, the frequency is changed normally. This switch allows you to quickly QSY over a great frequency range.

26. BAND SELECT FUNCTION SWITCH

By pushing in this switch, the operating band is changed by turning the TUNING CONTROL.

In the HAM BAND mode, each initialized frequency of the band is selected. In the GENERAL COVERAGE mode, the operating frequency is changed in 1MHz steps but the lower digits do not change.

27. VFO/MEMORY SWITCH

Switches the VFO operation and MEMORY CHANNEL operation.

28. DIAL LOCK SWITCH

After the IC-745 is set to a certain frequency for rag chewing, mobile operation, etc., by pushing this switch, the VFO is electronically locked at the display frequency, thus inactivating the operation of the tuning control. To change frequency or band, the dial lock must first be disengaged by pushing and releasing this switch again.

29. RIT SWITCH

Switches the RIT (Receiver Incremental Tuning) circuit ON and OFF.

30. XIT SWITCH

Switches the XIT (Transmitter Incremental Tuning) circuit ON and OFF.

31. INCREMENTAL TUNING CONTROL

Shifts the receive frequency about 1KHz to either side of the transmit frequency when the RIT is ON, and shifts the transmit frequency to either side of the receive frequency when the XIT is ON. Rotating the control to the (+) side raises the receive or transmit frequency, and rotating to the (-) side lowers the receive or transmit frequency. The frequency shifted by turning the control is not indicated on the frequency display.

When both the RIT and XIT switches are ON, the receive and transmit frequencies are the same, and this frequency can be shifted either side from the displayed frequency by the control.

32. RIT INDICATOR

Illuminates when RIT is turned ON.

33. XIT INDICATOR

Illuminates when XIT is turned ON.

34. VFO SWITCH

Selects either VFO, "A" or "B", for tuning. Each push of this button selects VFO A and B alternately.

It also selects the relationship of the two VFO's with the DUPLEX (SPLIT) switch. The switch performs the following operations.

A. (NORMAL) Selects the VFO "A" for both transmit and receive.

A. (SPLIT) Selects VFO "A" for receive and VFO "B" for transmit.

B. (NORMAL) Selects VFO "B" in both transmit and receive.

B. (SPLIT) Selects VFO "B" for receive and VFO "A" for transmit.

35. VFO EQUALIZING SWITCH

Instantly sets the frequency, mode and HAM/GENE operation of a VFO to the same as those of the other VFO.

36. DUPLEX (SPLIT) SWITCH

Selects the relationship of the two VFO's. In the OFF position, one VFO is for both receive and transmit. By pushing in this switch, one VFO is for receive and the other VFO is for transmit.

37. SCAN START/STOP BUTTON

Starts and stops any of the scan functions. When depressing it again to restart the scan, it will start from the stopped frequency in the programmed scan, or from the highest memory channel in the memory scan.

38. METER

When in the receive mode the meter acts as an S-meter regardless of the position of the meter select switch. Signal strength is indicated on a scale of S1-S9, and S9 to S9+60dB.

In the transmit mode the meter has five functions which are selected by the Meter Switch (16).

39. TRANSMIT INDICATOR

Illuminates when the transceiver is in the transmit mode.

40. RECEIVE INDICATOR

Illuminates when the squelch is opened in the receive mode.

41. GENERAL COVERAGE INDICATOR

Illuminates when the set is in the general coverage receiver operation.

42. SCAN INDICATOR

Illuminates when the set is in the scan mode.

43. FREQUENCY DISPLAY

The frequency of the IC-745 is displayed on a luminescent display tube. Since the 1MHz and 1KHz decimal points are displayed, the frequency can easily be read. The frequency indicated is the carrier frequency of each mode in USB, LSB, CW, AM and FM, and the mark frequency in RTTY.

Remember, if you turn the RIT or XIT SWITCH ON to change the frequency and rotate the INCREMENTAL TUNING CONTROL knob, the frequency displayed will not change.

The FREQUENCY DISPLAY shows not only the operating frequency but also MODE and selected VFO or in MEMORY CHANNEL mode.

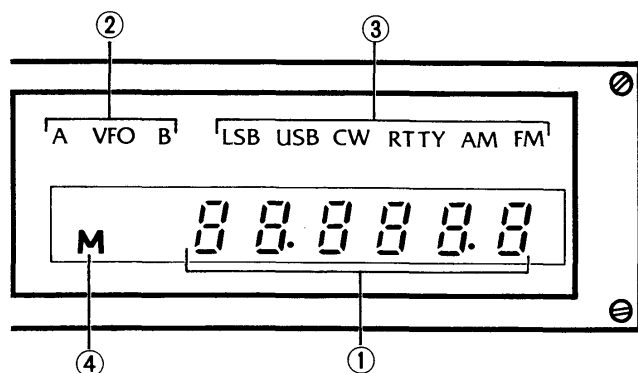

- ① Shows operating frequency in 6 digits between 10MHz and 100Hz.
- ② Shows selected VFO; VFO A or VFO B.
- ③ Shows operating mode; one of LSB, USB, CW, RTTY, AM, and FM.
- ④ Shows whether the set is in the MEMORY CHANNEL MODE or not. When the set is in the MEMORY CHANNEL MODE, the letter "M" is displayed here.

44. PASS-BAND SHIFT (TUNING) CONTROL

Allows continuous shifting of the pass-band from upper or lower side in SSB, CW and RTTY. This will reduce interference by a nearby signal. When the PBT switch is pushed ON, this control allows continuous tuning of the pass-band selectivity by moving the filter up to 800Hz from the upper or lower side in SSB, CW and RTTY. This not only improves selectivity, but also can improve the audio tone. Normal position is in the center position and is 2.4KHz wide in SSB.

45. PBT SWITCH

Switches the IF SHIFT function and PASS-BAND TUNING function.

46. FILTER SWITCH

Selects the combination of the second IF (9MHz) filter and the third IF (455KHz) filter to improve the selectivity.

47. NOTCH FILTER CONTROL

Shifts the notch filter frequency. Adjust the control so that the interference is reduced.

48. NOTCH FILTER SWITCH

Switches the notch filter function ON and OFF.

4 - 2 TOP COVER



49. MONITOR SWITCH

In the SSB transmit mode, the transmitting IF signals can be monitored by turning this switch ON. At this time, use headphones or reduce receiver audio volume to prevent howling.

50. MARKER SWITCH

When an optional marker oscillator unit is installed, this switch turns the marker oscillator ON or OFF.

The marker frequency is available on every 25KHz or 100KHz step.

51. MARKER CALIBRATION CONTROL

Calibrates the marker frequency with a standard frequency such as WWV.

52. FREQUENCY SET CONTROL

This control is for fine adjustment of the reference frequency of the PLL unit, which is local oscillator frequency. Do not turn it unless you want to change the frequency.

53. ANTI-VOX CONTROL

In VOX (SSB) operation, the VOX circuit may be operated by sound from the speaker causing a switch to transmit. This trouble can be prevented by adjusting the input level of the ANTI-VOX circuit with this control along with the VOX gain control so that the VOX circuit only operates by the operator's voice, not by sound from the speaker.

4-3 REAR PANEL CONNECTIONS

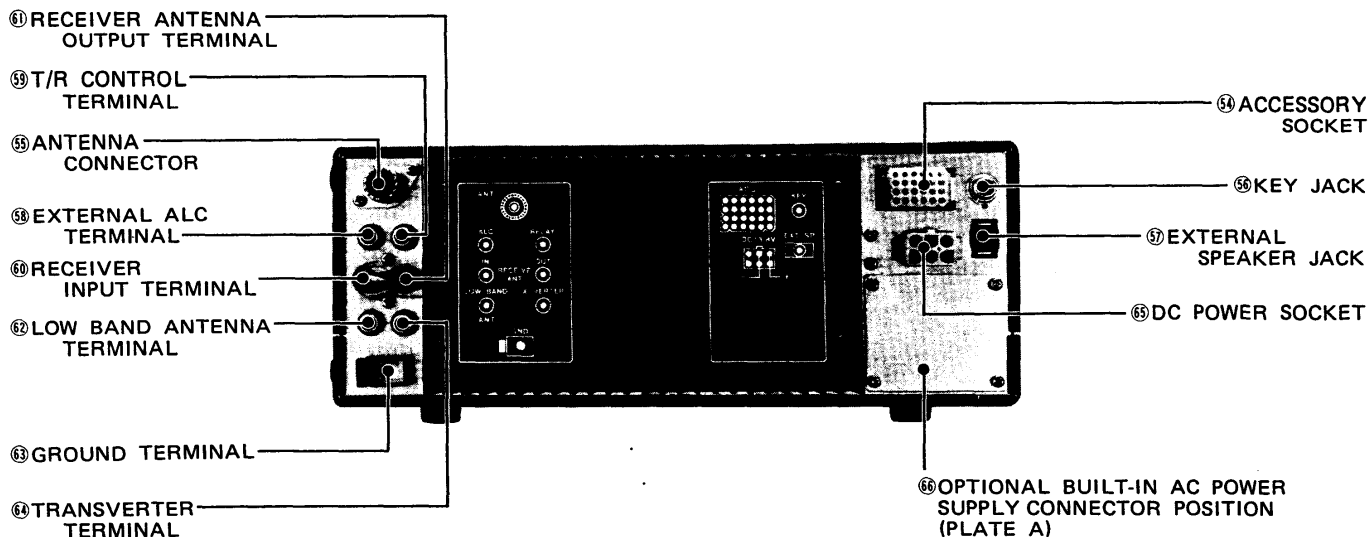

54. ACCESSORY (ACC) SOCKET

Various functions are available through the accessory socket such as modulation output, receiver output, T/R change-over, and so forth.

Refer to the ACCESSORY SOCKET CONNECTIONS on page 5.

55. ANTENNA (ANT) CONNECTOR

This is used to connect an antenna to the set. Its impedance is 50 ohms and connect with a PL-259 connector.

56. KEY JACK

For CW operation, connect a key here using a standard 1/4 inch 3-P plug. For electronic keying the terminal voltage must be less than 0.4V DC.

When an optional electronic keyer unit is installed, an iambic keyer paddle can be used with a 1/4 inch 3-P plug.

57. EXTERNAL SPEAKER JACK

When an external speaker is used, connect it to this jack. Use a speaker with an impedance of 8 ohms. When the external speaker is connected, the built-in speaker does not function.

58. EXTERNAL ALC TERMINAL

This terminal can be used for input terminal of external ALC signal from a linear amplifier or transverter. The ALC voltage should be in 0V ~ -4V.

59. T/R CONTROL TERMINAL

Controls Transmit/Receive for an external linear amplifier or transverter. This terminal can be used to switch 24V 1A DC. Don't exceed this limit.

60. RECEIVER INPUT TERMINAL

This is an input terminal which is connected directly to the receiver.

61. RECEIVER ANTENNA OUTPUT TERMINAL

This is a terminal to which received signals from the antenna connector are conducted after the signal passes through the transmit/receive antenna switching circuit. Usually the receiver IN and OUT terminals are jumpered. The receiver antenna output terminal is usually used when another receiver is used or a preamplifier is connected to the IC-745.

62. LOW BAND ANTENNA TERMINAL

For connection of a low band antenna to receive 1600KHz and below. When operating frequency goes to 1600KHz and below, the antenna terminal will be changed from the ANTENNA connector to this terminal automatically.

63. TRANSVERTER TERMINAL

VHF and UHF operation using a suitable transverter with the IC-745 is possible. This terminal is for Transverter connection. The output is about 30mV.

64. GROUND TERMINAL

To prevent electrical shock, TVI, BCI and other problems, be sure to ground the equipment through the GROUND TERMINAL. For best results use as heavy a gauge wire or strap as possible and make the connection as short as possible, even in mobile installations.

65. DC POWER SOCKET

For connection of the IC-PS15's DC power cord, or other suitable power supply.

66. OPTIONAL BUILT-IN AC POWER SUPPLY SOCKET POSITION

This is provided to install AC power socket plate of the optional built-in AC power supply, IC-PS35.

SECTION 5 OPERATING INSTRUCTIONS

5 - 1 HOW TO TUNE

The following instructions are for tuning in any mode. Please read carefully and understand fully before turning ON your unit. Proper tuning is necessary for optimum operation.

5 - 1 - 1 PRESET

When the power switch is turned ON, the frequency display shows frequency, HAM/GENE (HAM BAND mode or GENERAL COVERAGE mode) mode and mode stored in the VFO A and letters "A VFO", and the set operates with the VFO A and displayed mode, even if the previous operating mode was different. In addition, the RIT/XIT, DUPLEX mode and SCAN are turned OFF.

FOR EXAMPLE:

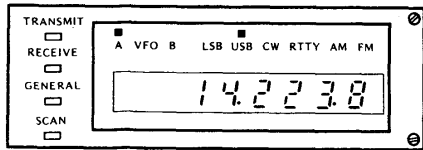

5 - 1 - 2 HAM BAND/GENERAL COVERAGE SELECTION

Each push of the HAM/GENERAL COVER SELECT switch changes the set in the HAM BAND MODE and GENERAL COVERAGE MODE alternately.

In the HAM BAND MODE, the frequencies available are those of the nine amateur bands between 1.8MHz and 28MHz including new three bands for both transmit and receive.

In the GENERAL COVERAGE MODE, the set operates as a receiver in the range of 0.1MHz to 30MHz continuously.

When you change the mode from the HAM BAND to GENERAL COVERAGE, the set maintains the frequency that was in the HAM BAND mode.

When you change the mode from the GENERAL COVERAGE to HAM BAND, if previous frequency was that of a HAM BAND, the set maintains that frequency.

FOR EXAMPLE:

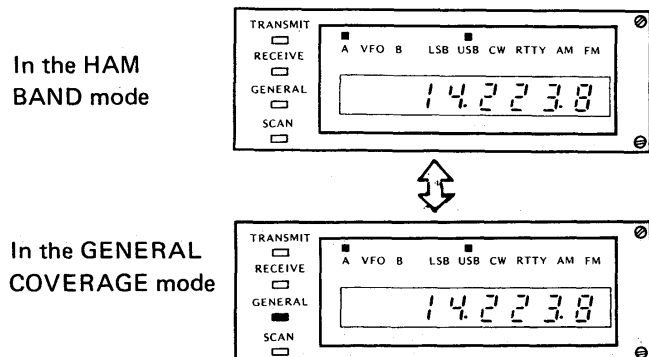

If the previous frequency was not of any HAM BAND, the frequency is initialized to "1.900.0MHz" or shifted frequency according to the operating mode.

In the GENERAL COVERAGE mode

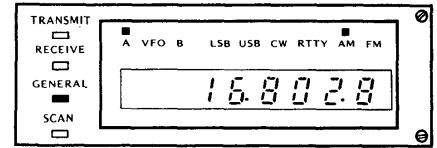

Pushing the HAM/GENERAL COVER SELECT switch



In the HAM BAND mode

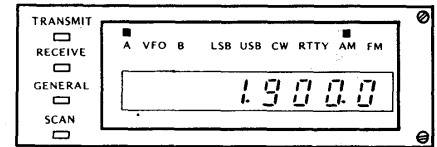

5 - 1 - 3 BAND SWITCHING

To change the operating band, push the BAND SELECT FUNCTION switch in and rotate the TUNING CONTROL.

In the HAM BAND mode, by turning the TUNING CONTROL clockwise the operating band changes to the next upper band, and counterclockwise changes to the next lower band, and the operating frequency is initialized as follows.

Band	Displayed Frequency (MHz)		
	CW•RTTY•AM•FM	LSB	USB
1.8MHz	1.900.0	* 1.901.5	1.898.5
3.5 "	3.550.0	* 3.551.5	3.548.5
7 "	7.050.0	* 7.051.5	7.048.5
10 "	10.050.0	10.051.5	*10.048.5
14 "	14.050.0	14.051.5	*14.048.5
18 "	18.050.0	18.051.5	*18.048.5
21 "	21.050.0	21.051.5	*21.048.5
24.5 "	24.550.0	24.551.5	*24.548.5
28 "	28.050.0	28.051.5	*28.048.5

* Initialized frequency and mode for each band.

In the GENERAL COVERAGE mode, by turning the TUNING CONTROL clockwise the operating frequency changes to a frequency that is added 1MHz to the previous one. (100KHz and lower digits of the frequency will remain as it had in the previous one.) By turning the TUNING CONTROL counterclockwise, the operating frequency changes to a frequency that is subtracted 1MHz from the previous one.

When the band reaches to the highest one in either mode, it will automatically return to the lowest one, or vice versa, as per the following charts.

In the HAM BAND mode

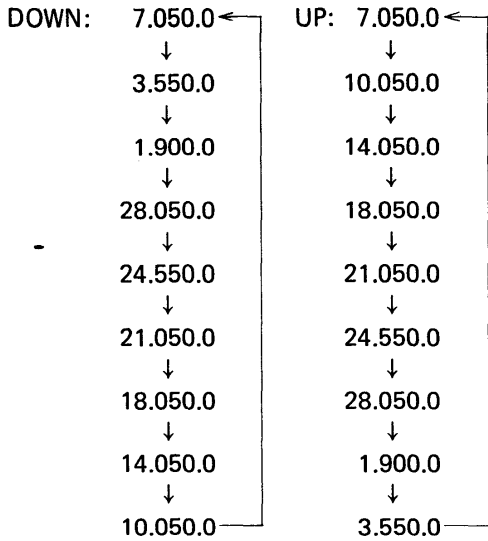

In the GENERAL COVERAGE mode

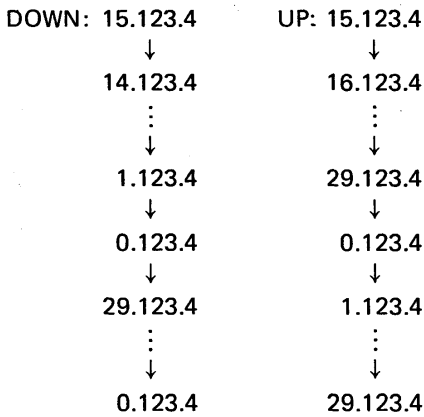

However, in the GENERAL COVERAGE mode, when the operating frequency reaches the highest or lowest edge, of that MHz range by turning the TUNING CONTROL continuously (at this time the BAND SELECT FUNCTION switch is not pushed in), the operating frequency will go to the next MHz range.

5-1-4 FREQUENCY DISPLAY ON EACH MODE

When the 7MHz band and LSB are selected, the display will be as follow:

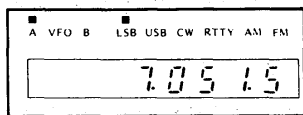

When changing to other modes, the display will be as follows:

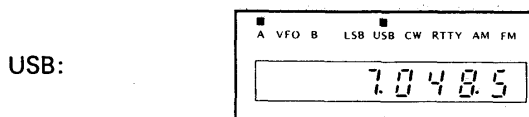

CW:

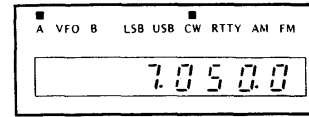

RTTY:

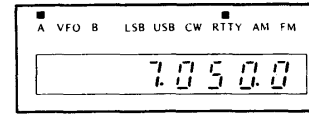

AM
(Receive only):

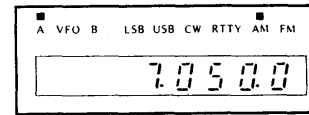

FM
(Option):

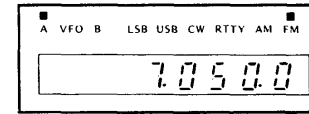

The displayed frequency shows the carrier frequency. To avoid the trouble of recalibrating the dial when you change the operating mode, the displayed frequency is set to shift to the carrier frequency of each mode automatically. For the differences of frequency shifts of the various modes, refer to the following figure.

When changing to other bands, 100KHz and lower digits of the frequency display will remain as it had in the previous display in the GENERAL COVERAGE mode.

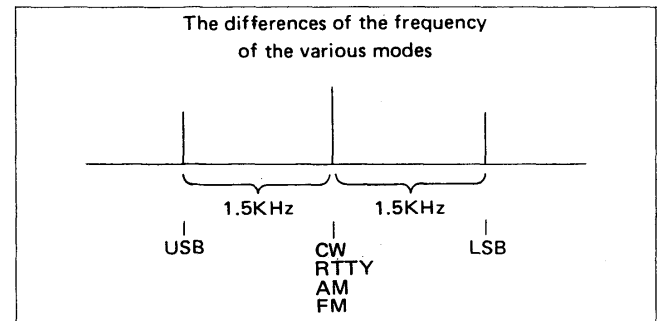

In the HAM BAND SSB mode, the sideband will be automatically selected to the one usually used on the band, i.e., upper sideband (USB) for the 10MHz band and above, and lower sideband (LSB) for the 7MHz band and below. If reverse sideband is desired, push the MODE SELECT SWITCH so that the desired mode is selected.

5-1-3 TUNING CONTROL

Rotating the TUNING CONTROL clockwise increases the frequency, while turning counterclockwise decreases the frequency in 10Hz steps. By turning the tuning control faster, the 50Hz steps tuning rate is automatically selected.

When the TUNING RATE switch is pushed in, the 1KHz steps tuning rate is selected in any mode. At this time, the 100Hz digit of the frequency display is cleared to "0".

The frequency range of each band in the HAM band mode is shown in the following chart.

Band	Frequency Range
1.8	1.800.0 ~ 1.999.9
3.5	3.440.0 ~ 4.099.9
7.0	6.950.0 ~ 7.499.9
10.0	9.950.0 ~ 10.499.9
14.0	13.950.0 ~ 14.499.9
18.0	17.950.0 ~ 18.499.9
21.0	20.950.0 ~ 21.499.9
24.0	24.450.0 ~ 25.099.9
28.0	27.950.0 ~ 29.999.9

In the HAM BAND mode, by turning the TUNING CONTROL clockwise, the operating frequency reaches to the high edge of the band (for example; 14.499.9MHz), and further turning of the control brings the frequency to the low edge of the band (13.950.0MHz) then continues up the frequency from there. Likewise, by continuing to turn the TUNING CONTROL counterclockwise beyond the low edge of the band, the frequency jumps up to the high edge and goes down from that frequency.

In the GENERAL COVERAGE mode, by turning the TUNING CONTROL clockwise, the operating frequency reaches the highest one of that MHz range (for example; 14.999.9 MHz), and further turning of the control brings the frequency to the next upper MHz range (15.000.0MHz) and continues up the frequency from there. By turning the control counterclockwise, the operating frequency changes in like manner to the next lower MHz range.

Brake Adjustment

If the control is too loose or too stiff for comfortable use, you can adjust the torque by tightening or loosening the brake adjustment screw accessible from underneath the set.

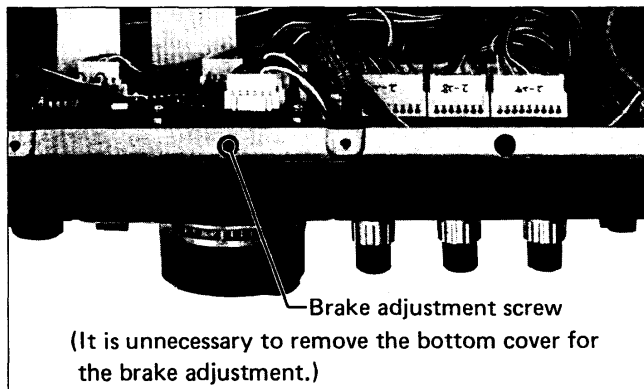

The following instructions should be used to adjust the tension of the Tuning control.

1. The Tuning control tension will become tighter by turning the brake adjustment screw clockwise, and will become looser by turning the screw counterclockwise.

2. While performing this adjustment, the Tuning control must be turned continuously as the screw is adjusted in order to set the tension for a comfortable touch.

NOTE: When the "VFO A" or "VFO B" LED is illuminated on the frequency display, we call this condition as "VFO MODE", when the letter "M" is displayed on the frequency display, we call this "MEMORY CHANNEL MODE".

These can be changed by pushing the VFO/MEMORY switch alternately.

5 - 1 - 6 DIAL LOCK SWITCH

After the IC-745 is set at a certain frequency for rag chewing, mobile operation, etc., by pushing the Dial Lock switch the VFO is locked at the displayed frequency, thus inactivating the operation of the tuning control. To change the frequency, the Dial Lock must first be disengaged by pushing and releasing the Dial Lock switch again.

5 - 1 - 7 VFO SWITCH

The IC-745 contains two VFO's for both receiving and transmitting. The VFO's are labeled "VFO A" and "VFO B", and are selectable by pushing the VFO switch alternately in the VFO MODE. The dual VFO system gives the IC-745 many very convenient features. Please read this section very carefully and perform the operation several times until you are comfortable with the system. Try the example for practice!

1. "VFO A" is for both receiving and transmitting, and selected by pushing the VFO switch. The receive and transmit frequency will be controlled by the "VFO A", displayed on the frequency display, and stored in the "A" memory.
2. "VFO B" is for both receiving and transmitting, and selected by pushing the VFO switch. The receive and transmit frequency will be controlled by the "VFO B", displayed on the frequency display, and stored in the "B" memory.

Switching from one VFO to the other VFO does not clear the first VFO. the frequency, operating mode and HAM/GENE mode are retained in the VFO's memory.

FOR EXAMPLE:

If 14.257MHz and USB are set with the "VFO A", then the VFO switch is pushed to select the "VFO B", the frequency display will show VFO B's frequency and mode, but 14.257MHz and USB are still stored in the VFO A's memory.

Pushing the VFO switch again to return the VFO A, "14.257.0" and "USB" will displayed on the frequency display.

Accordingly, if the VFO switch is pushed again to the VFO B, the frequency and mode that were set with the VFO B will appear.

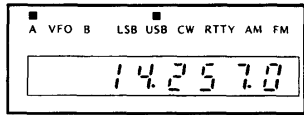

Pushing the VFO switch to select the VFO B.

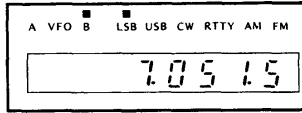

Pushing the VFO switch again to return the VFO A.

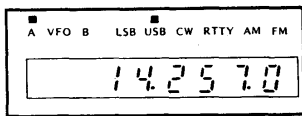

This allows you to set a certain frequency with one VFO, work up and down the band with the other VFO, and periodically check the set frequency simply by switching between VFO "A" and "B".

It also allows you to search for a clear frequency with one VFO, while keeping your operating frequency on the other VFO. When you have found a clear frequency, switch back to your operating frequency, inform the station you are in contact with of the new frequency, and switch back. It's that simple!

5-1-8 DUPLEX (SPLIT) SWITCH

The DUPLEX (SPLIT) switch changes the relationship of the two VFO's. Each push turns the function ON and OFF alternately.

When the function is OFF, one VFO is for both receive and transmit. When the function is ON, and one VFO is for receive and the other VFO is for transmit. So that this will allow you to operate on split receive/transmit frequencies.

FOR EXAMPLE:

Set VFO A to 7.057MHz and VFO B to 7.255MHz. Push the VFO switch to return VFO A then the DUPLEX (SPLIT) switch to ON. 7.057MHz will be shown on the display during receive (VFO A) and 7.255MHz during transmit (VFO B). You are now receiving on 7.057MHz and transmitting on 7.255MHz. Pushing the VFO switch to reverse the above.

Receiving (VFO A)

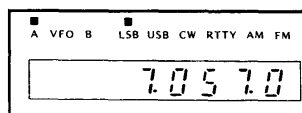

Transmitting (VFO B)

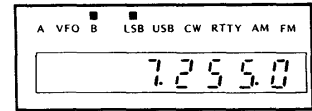

Each VFO stores operating mode too. If different mode is stored in each VFO, a crossmode QSO can be possible as well.

Receiving (VFO A, FM)

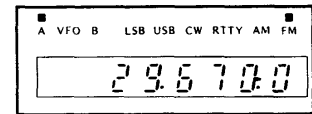

Transmitting (VFO B, USB)

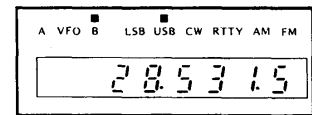

5-1-9 TRANSFERRING VFO FREQUENCY

The VFO EQUALIZING switch allows either VFO's to be brought to the exact frequency of the other VFO without turning the tuning control, and the operating mode.

FOR EXAMPLE:

When VFO A is 14.257MHz and USB, and VFO B is 29.670MHz and FM, pushing the VFO switch to select VFO A, then the VFO EQUALIZING switch, VFO B's frequency and operating mode become the same as VFO A's (14.257MHz and USB). Now the VFO A's frequency is memorized in the VFO B, and you can operate anywhere with VFO A or B. When you want to return to the previous frequency (14.257MHz), switch back to the other VFO. To reverse this (A the same as B), select VFO B first, then the VFO EQUALIZING switch.

VFO A (displayed)

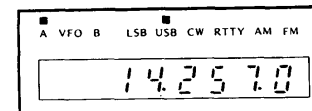

VFO B (hidden)

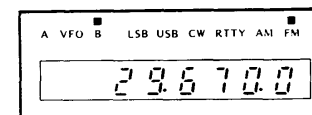

Pushing the VFO EQUALIZING switch



VFO A
(displayed)

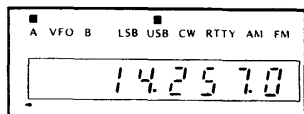

VFO B
(hidden)

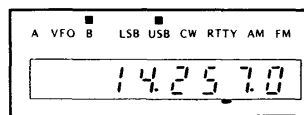

5 - 1 - 10 RIT (RECEIVE INCREMENTAL TUNING)

By using the RIT circuit, you can shift the receive frequency $\pm 1.0\text{KHz}$ either side of the transmit frequency without moving the transmit frequency itself. Therefore, when you get a call slightly off frequency, or when the other station's frequency has been drifted, you can tune in the frequency without disturbing the transmitting frequency. By pushing the RIT switch the RIT circuit is turned ON and the RIT Indicator is lit.

The receive frequency can be shifted with the INCREMENTAL TUNING Control knob.

When the Control knob is in the "0" position, the transmitting and receiving frequencies are the same.

Rotating the control to the (+) side raises the receiving frequency, and rotating to the (-) side lowers the frequency. To turn OFF the RIT function, again push and release the RIT switch and the RIT Indicator will go OFF. When the RIT circuit is OFF, the transmit and receive frequencies are the same regardless of the setting of the control knob.

NOTE: The RIT circuit is operational when the frequency is locked with the dial lock switch. The frequency shifted by turning the INCREMENTAL TUNING control is not indicated on the frequency display. When the transmitting and receiving frequencies differ by more than 1.0KHz, use "A" and "B" VFOs.

5 - 1 - 11 XIT (XMITTER INCREMENTAL TUNING)

You can shift the transmit frequency $\pm 1.0\text{KHz}$ on either side of the receive frequency without moving the receive frequency the same function as the RIT by using the XIT circuit.

By pushing the XIT switch, the XIT circuit is turned ON and the XIT Indicator is lit.

The transmit frequency can be shifted with the INCREMENTAL TUNING Control.

NOTE: When both the RIT and XIT switches are pushed, the receive frequency and transmit frequency become the same frequency, and it can be shifted to either side from the displayed frequency by the INCREMENTAL TUNING control.

5 - 2 MEMORY CHANNEL OPERATION

5 - 2 - 1 MEMORY CHANNEL SELECTION

When the power switch is turned ON, the set initially operates with the VFO A. By pushing the VFO/MEMORY switch, the set is switched into the MEMORY CHANNEL MODE and a frequency, mode and HAM/GENE mode which have been stored in a memory channel are displayed on the frequency display. In addition, the letter "M" is also displayed to indicate the set is in the MEMORY CHANNEL MODE. The desired memory channel can be selected by the MEMORY CHANNEL switch.

FOR EXAMPLE:

When "14.271MHz" and USB are memorized in VFO A, and "29.625MHz" and "FM" are in MEMORY CHANNEL 1, by pushing the power switch ON, the frequency display shows "14.271.0", "USB" and "VFO A".

By setting the MEMORY CHANNEL switch at "1", then pushing the VFO/MEMORY switch, the display will show "29.625.0" and "FM", and the letter "M" on the frequency display.

When the power is turned ON.

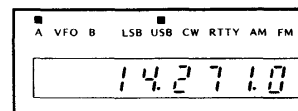

Pushing the VFO/MEMORY switch (Channel 1 has been selected.)

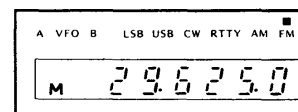
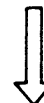

By turning the MEMORY CHANNEL switch, memory channels can be selected, and the respective frequency, mode and HAM/GENE mode are displayed on the display.

When you select a memory channel that has never been stored any frequency, the frequency display does not show any frequency. However, the set works with the frequency and mode of the memory channel (or VFO), which was previously displayed.

FOR EXAMPLE:

When "7.012MHz" and "CW" are memorized in memory channel 2, and no frequency is in channel 3, by setting the MEMORY CHANNEL switch at "2", the frequency display will show "7.012.0" and "CW".

By turning the MEMORY CHANNEL SWITCH clockwise furthermore, the memory channel number will change to "3", but the channel has never memorized any frequency, thus the display shows "CW" only. However, the set works with the frequency and mode of channel 2, i.e., "7.012MHz" and "CW".

In the MEMORY CHANNEL MODE, by turning the TUNING CONTROL, the OPERATING FREQUENCY displayed on the frequency display can be changed. This is very convenient for tuning a slightly off frequency or to change the operating frequency, or to rewrite the memorized frequency in the selected memory channel.

FOR EXAMPLE:

Now you are operating on 14.271MHz and USB with memory channel 7. If you want to change this frequency, turn the TUNING CONTROL clockwise to increase the frequency and counterclockwise to decrease one, the same as a VFO.

To tune to "14.295MHz", turn the TUNING CONTROL clockwise to obtain the desired frequency "14.295.0" on the display.

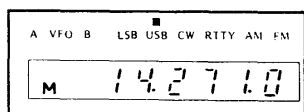

Turning
the TUNING CONTROL

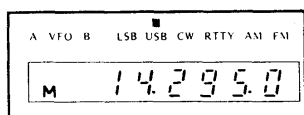

If you wish to rewrite the memorized frequency in the selected channel (at this time, "7") to this frequency ("14.295.0"), push the MEMORY WRITE button, and the operating frequency "14.295MHz" and mode "USB" are memorized into the memory channel 7.

To change the operating memory channel, turn the MEMORY CHANNEL switch.

5-2-3 MEMORY-WRITE (PROGRAMMING THE MEMORY CHANNELS)

Any operating frequency, mode and HAM/GENE mode can be memorized into a memory channel.

1. Set the operating frequency, mode and HAM/GENE mode to desired ones by a VFO. For example, set them for "15.725MHz", "AM" and "GENE" by using VFO B.

2. Select a memory channel to be memorized by turning the MEMORY CHANNEL switch. For example, select it at memory channel 10.

3. To check the contents in the memory channel, push the VFO/MEMORY switch, and the contents are displayed on the frequency display. If you don't like to rewrite these contents, select another memory channel which has contents erasable or no memorized frequency. (When no frequency has been memorized, no figure is displayed at the frequency position.) After checking, push the VFO/MEMORY switch again to return to the VFO.

4. One push of the MEMORY WRITE button erases the previous memorized contents (if any) and memorizes the displayed frequency, mode and HAM/GENE mode into the selected memory channel (at this time channel 10).

5. Memorize other desired frequencies into memory channels in the same manner. Memory channel 1 and 2 are used also for the PROGRAMMED SCAN. For PROGRAMMED SCAN operation, refer to "SCANNING OPERATION" on page 17.

5-3 TUNING BY UP/DOWN BUTTONS ON THE MICROPHONE

5-3-1 FREQUENCY CONTROL

With each push of the UP or DN (down) button on the optional microphone, IC-HM12, the operating frequency is changed one increment up or down respectively. In the same way, by depressing the button continuously, the operating frequency is changed up or down the same as turning the TUNING CONTROL. The tuning rate is according to the setting of the TUNING RATE switch.

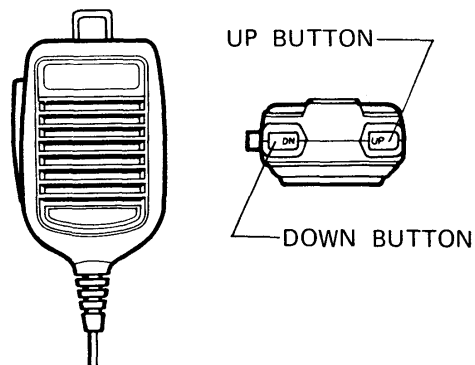

This function is effective both in the VFO mode and in the MEMORY CHANNEL mode.

5-3-2 BAND SELECTING

In the VFO mode, when the BAND SELECT FUNCTION switch is pushed in, by depressing the UP or DN (down) button on the microphone continuously, the operating band is changed up or down respectively every one second.

5 - 4 SCANNING OPERATION

The IC-745 provides various scanning operations. Please read the following instructions carefully to fully enjoy the IC-745's many capabilities.

5 - 4 - 1 MEMORY SCAN

This is used to scan all programmed memory channels continuously.

1. Program your desired frequencies into memory channels.
2. Select a memory channel programmed with a frequency. (The scan cannot start from a blank channel.)
3. Depress the SCAN START/STOP button, and the frequency starts scanning the programmed frequencies in the memory channels from the highest channel to lowest. At this time, the scan skips blank channels, if any.
4. If the SQUELCH is engaged, the scan stops when the squelch is opened and receives a signal. This restarts after passing a specified time.

To stop scanning without opening the squelch, depress the SCAN START/STOP button. Depress it again to restart the scanning.

5 - 4 - 2 PROGRAMMED SCAN

This is to scan between two desired frequencies, which are memorized in the memory channels "1" and "2".

CAUTION The programmed scan does not start when the contents of memory channels 1 and 2, and frequency display differ from which are described below.

1. The same operation mode (HAM BAND or GENERAL COVERAGE mode) should be stored into memory channels 1 and 2. To start the scan, the set should be in the same operation mode as the memory channels.
 2. Stored frequencies in memory channels 1 and 2 should be in the same band, if the HAM BAND mode is stored in both memory channels 1 and 2. To start the scan, the set should be in the HAM BAND mode and in the same band as the memory channels.
1. Memorize the frequencies of the high and low edges of the desired scanning range into the memory channels 1 and 2. Regardless of which channel the higher frequency is memorized in, the scan starts from the high edge of the range.
For example, 14.200MHz is in the memory channel 1 and 14.300MHz in the channel 2.
 2. Place the unit in the VFO MODE and select operation mode the same as the channels 1 and 2, and a VFO you

desire. Pushing the SCAN START/STOP button starts the scan from the high edge (14.300MHz) to the low edge (14.200MHz). The scanning frequency increments depend on the TUNING RATE switch setting.

3. When the scanning frequency reaches the low edge (14.200MHz), it automatically returns to the high edge (14.300MHz) and continues scanning down to provide endless scanning operation.

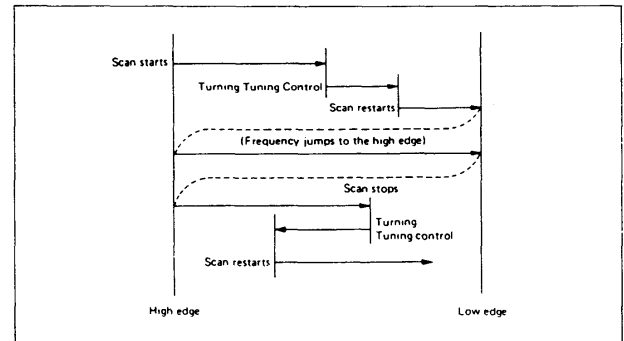

4. While the SQUELCH is engaged, the squelch opens when a signal is received and will stop the scanning automatically on the frequency, and the signal can be monitored. After approximately 10 seconds, the scan restarts from the frequency the scan stopped at, continuing to the low edge. If the RECEIVE indicator is lit because the SQUELCH is not engaged, the scan does not stop at any signals.
5. Depressing the SCAN START/STOP button while the scan is operating or during the 10 seconds of monitoring, clears the scanning operation and the VFO goes back to normal operation.
6. By turning the set into the transmit mode, or rotating the TUNING CONTROL, or pushing the VFO switch, VFO/MEMORY switch, or the MODE SELECT switch the scan stops and clears.
7. When the operating frequency is higher than the high edge (14.300MHz) and the SCAN START/STOP button is pushed, the scan starts from the operating frequency and scan down to the low edge, but it will return to the memorized high edge frequency (14.300MHz) and continue the scanning to the low edge. If the operating frequency is below the low edge frequency (14.200MHz), the scan frequency jumps to the high edge frequency (14.300MHz) and starts from the high edge.

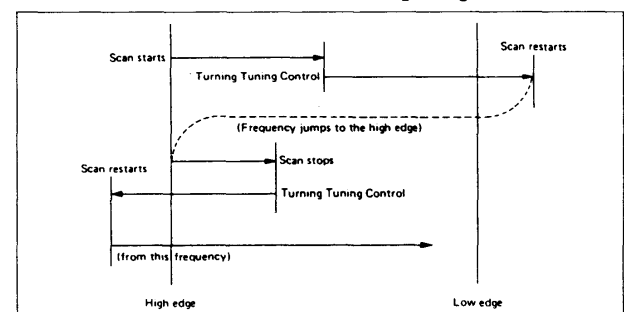

NOTE: The auto-stop functions with SSB or CW signals, but the scan does not always stop at the exact carrier frequency. When the scan stops on a signal, tune into the signal for better reception by pushing a MODE switch for the proper mode (if different) and by rotating the TUNING CONTROL.

5-4-3 RESUMING SCAN

All scan modes are provided with the resume scan function. When the scan has been stopped by the auto-stop function, the scan will restart after passing a specified time (about 10 seconds).

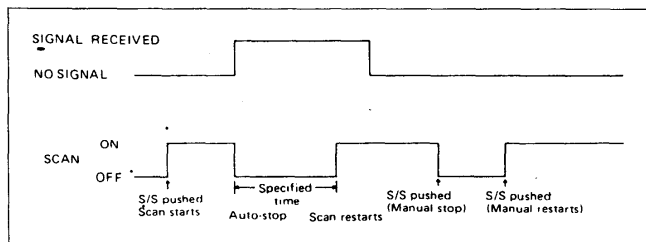

This function can be turned OFF by the switch (S1) in the MATRIX unit shown in the photo below. When this function is turned OFF, the scan function is cleared when a signal is received, and the operating frequency is locked on the frequency.

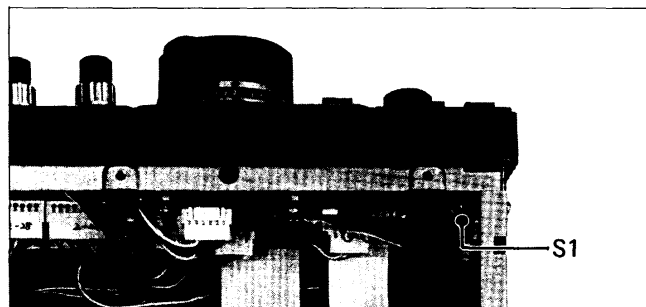

5-4-4 SCAN SPEED

The scanning speed of any scan mode can be adjusted by the SCAN SPEED CONTROL (R14) located in the LOGIC unit as shown in the photo. Rotating the control clockwise makes the scanning speed faster.

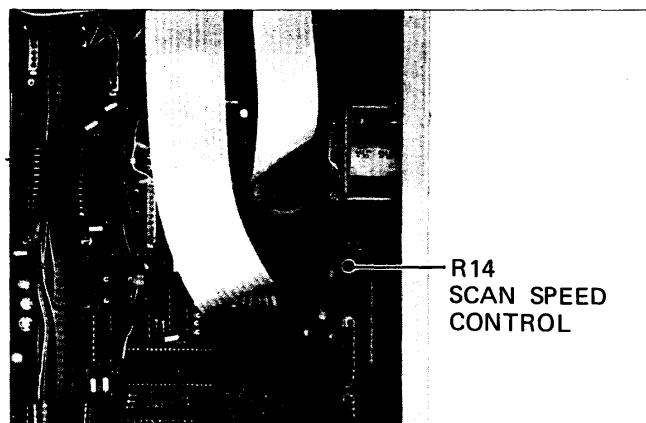

5-5 SSB OPERATION

5-5-1 RECEIVING

After connecting an antenna, microphone, etc., set knobs and switches as follows.

POWER SWITCH	OFF (OUT)
T/R SWITCH	RECEIVE (DOWN)
VOX SWITCH	OFF (OUT)
NOISE BLANKER (NB) SWITCH	OFF
NB LEVEL CONTROL	Completely Counterclockwise
AGC CONTROL	Center (12 o'clock) position
PREAMP SWITCH	OFF (OUT)
TUNING RATE SWITCH	OFF (OUT)
AF GAIN CONTROL	Completely Counterclockwise
RF GAIN CONTROL	Completely Clockwise
SQUELCH CONTROL	Completely Counterclockwise
TONE CONTROL	Center (12 o'clock) position
P.B. SHIFT CONTROL	Center position
BAND SELECT FUNCTION SWITCH	OFF (OUT)
RIT SWITCH	OFF
XIT SWITCH	OFF
DUPLEX (SPLIT) SWITCH	OFF (OUT)
DIAL LOCK SWITCH	OFF (OUT)
VFO/MEMORY SWITCH	OFF (OUT)
PBT SWITCH	IF SHIFT (OUT)
FILTER SWITCH	OFF (OUT)
NOTCH FILTER SWITCH	OFF (OUT)

The other controls are unrelated to receiving and need not be set at this time.

Now push the POWER switch in. The meter lamp will be illuminated, after a few seconds, a frequency, mode and HAM/GENE mode memorized in the VFO A will be shown on the frequency display.

In SSB operation there is both a USB (upper side band) and an LSB (lower side band). In the HAM bands, LSB is usually used on the 1.8, 3.5 and 7MHz bands, while USB is usually used on the 10MHz band and above. The IC-745 selects the normally used sideband according to the band in which you are operating.

If you wish to operate with the opposite sideband, push the MODE SELECT switch so that the opposite sideband can be selected.

When you wish to operate on another band than the displayed one (if the desired band is not a HAM band, push the HAM/GENERAL switch so that the GENERAL COVERAGE INDICATOR is illuminated.), push the BAND SELECT FUNCTION switch in, then turn the TUNING CONTROL so that the desired band is displayed.

Slowly turn the AF GAIN control clockwise to a comfortable level. Rotate the tuning knob until a signal is received. The meter needle will move according to the signal strength, so tune for the highest possible meter reading and the clearest audio. If you cannot get a clear signal, you may be receiving in the opposite sideband. If so, change the mode to the proper sideband.

Adjust the RF GAIN control and TONE control for comfortable reception.

If squelch operation is required to cut out noise when no signal is received, turn the SQUELCH control clockwise until the noise from the speaker stops and leave it just below this threshold.

For tuning, memory channel operation and scanning operation, please refer to 5 - 1 HOW TO TUNE on page 11, 5 - 2 MEMORY CHANNEL OPERATION on page 15 and 5 - 4 SCANNING OPERATION on page 17.

5 - 5 - 2 NB (NOISE BLANKER)

Set the NB (noise blanker) switch in the NOR position when there is pulse type noise, such as ignition noise from automobile motors, and turn the NB LEVEL control clockwise so that noise will be suppressed and even weak signals will be received comfortably.

When the NB switch is set in the WIDE position, the noise blanker will effectively work for "woodpecker's noise", however, if the receiving signal is too strong, the noise blanker may work with the receiving signal itself, and some distortion may cause in the receiving audio or keying form. At this time, set the N.B. Switch in the NOR position, or turn the NB switch OFF.

5 - 5 - 3 AGC (AUTOMATIC GAIN CONTROL)

The IC-745 has a fast attack/slow release AGC system which holds the peak voltage of rectified IF signals from the IF amp circuit for a certain period. Therefore, during the pauses in normal speech of the received signal, uncomfortable noise will not be heard. The meter indicates the peak value for a certain period, facilitating reading of the meter "S" function.

For normal SSB reception, turn the AGC control clockwise to the SLOW position. Turn the AGC control counter-clockwise to the FAST position, when tuning or receiving signals with short interval fading. When in the FAST position, the time constant is shortened.

When this control is set at the OFF position, the AGC circuit is turned OFF, and the S-meter does not work even if a signal is received. However the RF GAIN control is still active and the needle of the meter moves depending on the control position.

5 - 5 - 4 PREAMP SWITCH

Turn the PREAMP Switch ON (in) when receiving weak

signals. In the ON position, an RF preamplifier is inserted into the receiving antenna circuit, increasing sensitivity and giving easy reception.

5 - 5 - 5 PASS-BAND SHIFT CONTROL

Pass-Band Shift Control is a system in the receive mode to shift the pass-band of the IF upper or lower side continuously. This is very effective in reducing interference from nearby signals.

To use the Pass-Band (IF) Shift system, set the PBT switch in the IF (out) position and slide the control toward right or left side. The center position is the normal pass-band condition.

For example, while receiving in the LSB mode, if you get interference from a lower frequency (interfering signals are high pitched tones), shift the pass-band by sliding the P.B. SHIFT control to the left side. When the interfering signals are low-pitched tones, they are from a high frequency, and you should shift the pass-band by sliding the P.B. SHIFT control to the right side.

When receiving in the USB mode, the pass-band is shifted in the opposite manner. Interference from a higher frequency will be high-pitched tones, and the P.B. SHIFT control should be slid to the right side. Interference from a lower frequency will be low-pitched tones and the P.B. SHIFT control is slid to the left side.

This control can also be used for audio tone adjustment, so it may be set for the most comfortable reception.

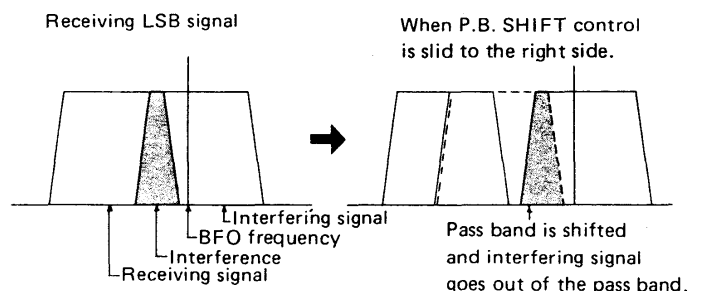
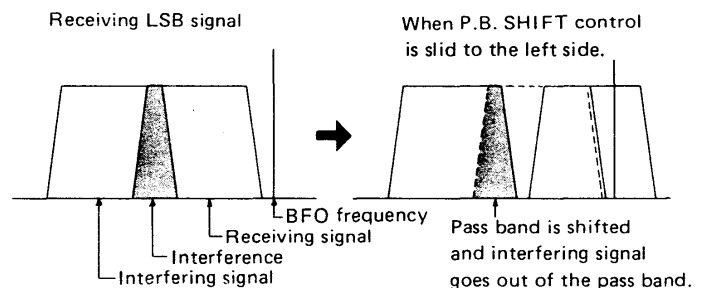

When the PBT switch is set in the PBT (in) position, the Pass-Band Shift system will be changed to the Pass-Band Tuning system.

The Pass-Band Tuning (PBT) is a system in the receive mode

to narrow the bandwidth (selectivity) of the frequencies that will pass through the crystal filter electronically from either the upper or lower side continuously by up to 800Hz. This is very effective in reducing interference from nearby signals.

To use the PBT system, slide the control the same as the Pass-Band Shift system.

The center position is the widest position and is equivalent to the normal SSB band width.

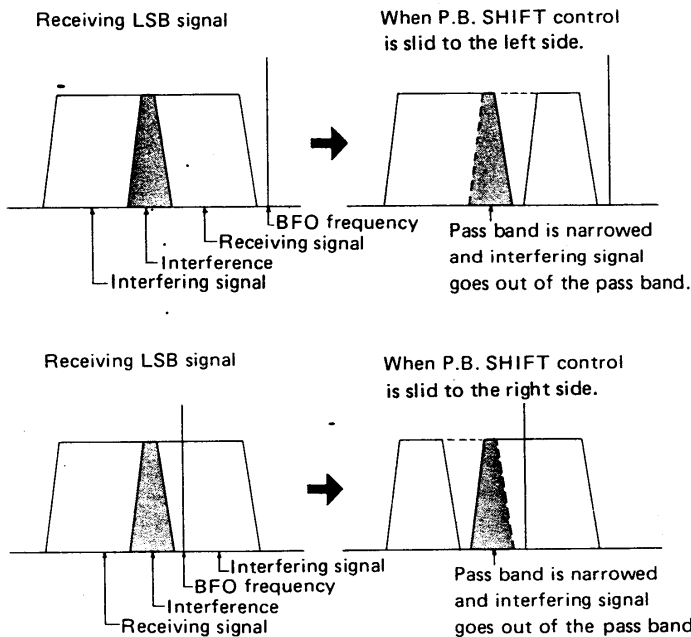

5 - 5 - 6 FILTER SWITCH

This switch selects the combination of the internal filters. When an optional filter is installed, this function will be more effective. Select and install the optional filter(s) to suit your favorite mode(s).

5 - 5 - 7 NOTCH FILTER

This circuit notches a frequency in the IF pass-band, so this is effective to reduce interference such as a beat-tone signal.

To use this function, push the NOTCH FILTER switch ON and slide the NOTCH FILTER control so that the interference is reduced.

5 - 5 - 8 TRANSMITTING

Before transmitting, listen in the receive mode to make sure your transmission will not interfere with other communications. If possible, use a dummy load for adjustment instead of an antenna. Set knobs and switches as follows.

MIC GAIN CENTER (12 o'clock) position
 RF POWER CONTROL Fully Counterclockwise
 METER SWITCH ALC

Other knobs and switches are left in the same positions as for receiving. When the T/R switch is moved to transmit,

or when the PTT (push to talk) switch on the microphone is depressed, the TRANSMIT Indicator is illuminated. By speaking into the microphone, the meter needle will move according to the strength of your voice and SSB signals will be transmitted. Set the MIC GAIN control so that the meter needle stays well within the ALC zone at voice peaks. If you wish to increase the output power, turn the RF POWER Control clockwise and adjust to obtain the desired RF output power of between 10 watts and 100 watts (approximately).

Change to the receive mode by moving the T/R switch to receive, or release the microphone PTT switch.

5 - 5 - 9 HOW TO USE THE SPEECH PROCESSOR

The IC-745 has a low distortion RF stage speech processor which enables greater talk power and better results in DX operation. Follow the steps below for use of the Speech Processor:

MIC GAIN CONTROL CENTER (12 o'clock) position

RF POWER CONTROL Fully Counterclockwise

COMP SWITCH ON

METER SWITCH RF

Switch to transmit and turn the RF POWER CONTROL clockwise while speaking into the microphone until you obtain the desired RF "PEAK" output power of between 10 watts and 100 watts (approximately).

Turn the METER SWITCH at the COMP position, then adjust the MIC GAIN CONTROL to a point where the meter needle swings between 10dB and 20dB on the COMP scale.

The Speech Processor should be turned OFF or MIC GAIN CONTROL carefully set for minimum compression for all communication other than DX operation for a very natural voice quality.

5 - 5 - 10 HOW TO USE THE VOX CIRCUIT

The IC-745 has a built-in VOX (voice operated relay) which allows automatic T/R switching by voice signals into the microphone. For VOX use, set the knobs and switch as follows:

VOX GAIN CONTROL
 Fully Counterclockwise

VOX DELAY CONTROL
 Fully Clockwise

ANTI VOX CONTROL (on the top)
 Fully Counterclockwise

Push the VOX switch on the front panel to the ON (in) position. Leaving the T/R switch in the RECEIVE position and without pushing the PTT switch, turn the VOX GAIN

control clockwise while speaking into the microphone. At a certain point, the T/R switching circuit will be activated by your voice. This is the proper position for the VOX GAIN control. Set the VOX GAIN control at a level which provides for T/R switching at your normal voice level. Transmit-release time (the time delay before the set automatically returns to receive when you stop talking) is controlled by the VOX DELAY control. Turning the control counterclockwise makes the time shorter. Set it at a position which is comfortable and which allows for short pauses in normal speech.

Adjust the ANTI VOX control so that the VOX circuit is not activated by sounds from the speaker by turning the control clockwise while receiving a signal.

5-5-11 MONITOR

The transmitting IF signals can be monitored in the SSB mode. So you can check the quality of the transmitting signals and conditions of the speech processor and so on.

To use this function, turn the MONITOR switch on the top cover ON and adjust the AF GAIN control to a comfortable audio level. At this time, use headphones to prevent howling which will be caused by picking up sounds from the speaker.

5-6 CW OPERATION

5-6-1 RECEIVING

For CW reception, set the operating mode for CW by pushing the MODE SELECT switch.

Other switches and knobs are set the same as for SSB reception.

In addition to the crystal band-pass filter, Narrow filters are optional for this unit. When the FILTER Switch is set at the ON (in) position, this filter is activated and the total selectivity of CW reception is improved. With these filters, internal noise is reduced for comfortable CW reception and an improved signal to noise ratio (S/N).

Also, use the Noise Blanker, AGC switch and/or PREAMP Switch depending on the receiving conditions, the same as SSB reception.

5-6-2 TRANSMITTING

Insert the keyer plug into the KEY Jack on the rear panel of the unit, and set knobs and switches as follows:

RF POWER CONTROL	Fully counterclockwise
METER SWITCH	RF
VOX GAIN/KEYER SPEED CONTROL	OFF

Other knobs and switches are set the same as for CW reception.

By setting the T/R switch to TRANSMIT, the TRANSMIT indicator is lit and shows that you are ready for CW transmission. When you key the keyer, the meter needle moves and your CW signal is transmitted. To increase the transmitting power, turn the RF POWER Control clockwise to adjust while watching the meter needle on the Po scale for the desired output power.

When the optional keyer unit is installed, connect an iambic paddle with the supplied 3-P key plug to the KEY jack on the rear panel.

Then adjust keying speed by turning the VOX GAIN/KEYER SPEED CONTROL clockwise for your favorite keying speed.

The other procedures are the same when using a hand keyer or an external electronic keyer.

5-6-3 CW SIDE-TONE (MONITOR)

When keying the side-tone oscillator is activated and an 800Hz tone will be heard. The loudness of the tone is controlled by the CW MONI Control located under the top cover. Rotating the control clockwise will increase the loudness. This tone is also audible in the receive mode and can be used for code practice, adjustment of the keyer, etc.

5-6-4 SEMI BREAK-IN OPERATION

The IC-745 has Semi Break-In CW capability when using the VOX function. When keying, the unit is automatically set in the transmit mode. After keying, it is returned to the receive mode, also automatically, after a given transmit-release delay time constant. Leave the T/R switch in the RECEIVE position, and set the VOX switch in the ON (IN) position.

The transmit release delay time constant is set by adjusting the VOX DELAY Control. Turning the VOX DELAY Control clockwise will make the transmit release time longer. Set it for your own keying speed.

5-7 RTTY OPERATION

For RTTY operation, a teletypewriter (or an equivalent) and a demodulator (terminal unit) which is operational with audio input are required. Any demodulator with 2125/2295Hz filters (narrow, 170Hz shift) can be used with the IC-745.

When a highspeed relay is used.

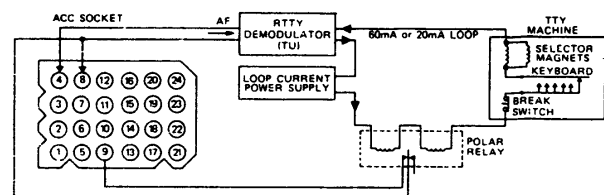

When a level converter is used.

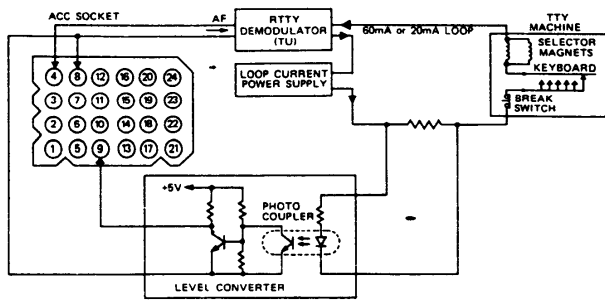

5-7-1 RECEIVING

Audio signals for the demodulator can be supplied from Pin 4 of the ACC socket on the rear panel, or from the PHONES jack on the front panel. The level of the audio signals from Pin 4 of the ACC socket does not vary by turning the AF GAIN Control, and the level is about 300mVp-p maximum.

Set the operating mode for RTTY, by pushing the MODE SELECT switch. The other controls are the same as those for SSB reception. When tuning a RTTY signal, set the TUNING RATE switch OFF (out) position, and tune to get audio signals of 2125Hz for MARK and 2295Hz for SPACE. (Use the tuning indicator of the terminal unit for easy tuning.) Also adjust the P.B. Tune control for clear reception.

When an optional CW narrow filter is installed, by setting the FILTER switch ON, the narrow filter is activated and the total selectivity of the RTTY reception is improved (250Hz or 500Hz/-6dB) the same as the CW mode.

If you wish to receive RTTY signals which have wider shift such as 425Hz and 850Hz shifts, prepare a demodulator suits for the shift and turn OFF the FILTER switch.

5-7-2 TRANSMITTING

For keying of the Frequency Shift Keying (FSK) circuit insert a high speed relay's coil into the loop current circuit of the teletypewriter, and connect the relay contacts to Pins, 8 and 9 of the ACC Socket on the rear panel. The relay contacts make during the Space and break during the Mark, as shown in the drawing. Fine adjustment of the MARK and SPACE frequencies can be done by adjusting the coil cores in the MAIN unit.

When a level converter for TTL level signals is used, connect the output of the converter to Pins 8 (ground) and 9 of the ACC Socket, apply High level (5V) signals for the Mark, and Low (0V) for the Space.

When using an AFSK generator that has 2125Hz for Mark and 2295Hz for Space, connect the output signals for the AFSK to the Mic connector on the front panel and set the Mode to LSB. (See Other Operations chapter.) Doing this, you can use the VOX operation available in this mode, and receive/transmit changeover is very easy.

When an AFSK generator is used

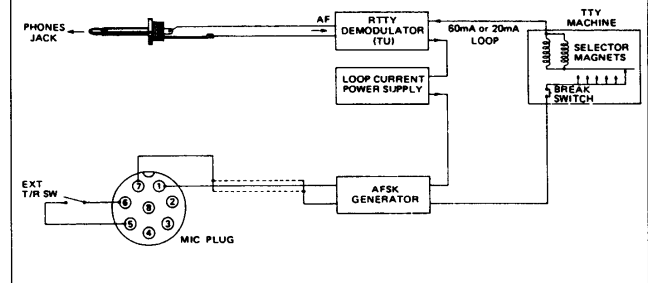

If you wish to transmit continuously 10 minutes or more, reduce the output power to less than 70% of the full power, by rotating the RF POWER control on the front panel.

5-8 AM OPERATION (RECEIVE ONLY)

Set the operating mode for AM by pushing the MODE SELECT switch. The other controls are the same as those for SSB reception, except the PASS BAND TUNING. The Pass Band Tuning control does not work in this mode.

By pushing the FILTER switch, a better selectivity (the same as for SSB) will be provided.

When tuning an AM signal, tune for maximum signal strength as indicated on the meter.

NOTE: In this mode, the set does not transmit on any band.

5-9 FM OPERATION (OPTION)

5-9-1 RECEIVING

Set the operating mode for FM, by pushing the MODE SELECT switch. The other controls are the same as those for SSB reception, however, the Pass Band Shift (Tune) control, Notch Filter, Noise Blanker and AGC circuits do not work in this mode.

When tuning an FM signal, tune for maximum signal strength as indicated on the meter and the clearest audio.

5-9-2 TRANSMITTING

Transmitting FM signals is essentially the same as SSB transmission.

Set knobs and switches the same as for SSB operation. However the speech processor can not be used on this mode.

When transmitting the FM signals, the meter (in RF position) will indicate the carrier power, but the meter needle does not move according to your voice such as SSB transmitting.

NOTE: Most countries may not allow to use the FM mode on HF HAM band except 28MHz.

5 - 10 GENERAL COVERAGE RECEIVER

In this mode, the set does not transmit on any frequency, even if the frequency is on the HAM band.

Set knobs and switches as follows.

POWER SWITCH	OFF (OUT)
T/R SWITCH	RECEIVE (DOWN)
VOX SWITCH	OFF (OUT)
NOISE BLANKER (NB) SWITCH	OFF
NB LEVEL CONTROL	Completely Counterclockwise
AGC CONTROL	Center (12 o'clock) position
PREAMP SWITCH	OFF (OUT) -
TUNING RATE SWITCH	OFF (OUT)
AF GAIN CONTROL	Completely Counterclockwise
RF GAIN CONTROL	Completely Clockwise
SQUELCH CONTROL	Completely Counterclockwise
TONE CONTROL	Center (12 o'clock) position
P.B. SHIFT CONTROL	Center position
BAND SELECT FUNCTION SWITCH	OFF (OUT)
RIT SWITCH	OFF
XIT SWITCH	OFF
DUPLEX (SPLIT) SWITCH	OFF (OUT)
DIAL LOCK SWITCH	OFF (OUT)
VFO/MEMORY SWITCH	OFF (OUT)
PBT SWITCH	IF SHIFT (OUT)
FILTER SWITCH	OFF (OUT)
NOTCH FILTER SWITCH	OFF (OUT)

The other controls are unrelated and need not be set for this operation.

Now push the POWER switch in. The meter lamp will be illuminated and after a few seconds a frequency, mode and HAM/GENERAL mode memorized in the VFO A will be shown on the frequency display.

If the operation mode is in the HAM band mode (The GENERAL COVERAGE indicator is not illuminated.), push the HAM/GENERAL COVER SELECT switch, and the indicator will be illuminated and the set will work in the GENERAL COVERAGE mode.

In SSB operation there are both a USB (upper side band) and an LSB (lower side band).

The desired mode can be selected by pushing the MODE SELECT switch.

The selected mode does not change on the entire band. For example, LSB has been selected on 8MHz band then the operating band is changed to 10MHz band or above, the operating mode, "LSB", will be kept.

When you wish to operate on a band (MHz range) other than the initialized band (MHz range), push the BAND

SELECT FUNCTION switch, then turn the TUNING CONTROL to select the band (MHz range) you wish to operate. Slowly turn the AF GAIN control clockwise to a comfortable level. After releasing the BAND SELECT FUNCTION switch, rotate the TUNING CONTROL until a signal is received.

The meter needle will move according to the signal strength, so tune for the highest possible meter reading and the clearest audio.

Refer to 5 - 5 - 2 ~ 7 on pages 19 and 20 for other functions, 5 - 6 - 1 on page 21 for CW reception, 5 - 7 - 1 for RTTY reception, 5 - 8 for AM reception and 5 - 9 - 1 for FM reception on page 22.

5 - 11 OTHER OPERATIONS

5 - 11 - 1 VSWR READING

The IC-745 has a built-in VSWR meter for checking antenna matching in order to avoid problems caused by VSWR. Set the METER SELECT switch to the SET position. Set the operating mode to RTTY, and turn the TRANSMIT/RECEIVE switch to TRANSMIT.

Adjust the RF POWER control so that the meter needle points to "SET" on the meter scale. Set the METER SELECT switch to the SWR position. With the switch in the SWR position, SWR reading can be seen on the meter. Although this unit is built to handle VSWR of up to 2:1, it is recommended that the antenna(s) be adjusted for the lowest possible VSWR. After taking the reading, return the switch to the other position. **ALSO BE SURE THAT THE ANTENNA IMPEDANCE IS 50 OHMS OR THERE MAY NOT BE ANY OUTPUT. OTHERWISE THERE WILL BE DAMAGE TO THE TRANSCEIVER.**

The final transistors used in the IC-745 are of good design and are protected to a reasonable extent by circuits incorporated in the set. These devices can be expected to have an indefinite lifetime since there are no cathodes to burn out. Under some conditions, however, they can be abused beyond tolerance and may have to be replaced.

When in doubt about antenna systems, use the lowest power setting possible to achieve meaningful readings. Use a good tuner or transmatch when necessary. Always use caution and exercise judgement when testing RF power generators.

5 - 11 - 2 WWV RECEPTION

To receive WWV (or other standard frequency station), set the operating band to 10MHz in the HAM band or GENERAL COVER mode, and the MODE to any mode. Tune to 10.000.0MHz on the frequency display.

Since the IC-745 has a General Coverage receiver built-in, any frequency's WWV can be received. Merely set to the

GENERAL COVERAGE mode and tune to the desired frequency.

The WWV signal can be used for alignment of a frequency counter, marker oscillator, or the frequency display.

5 - 11 - 3 SIMPLE FREQUENCY ALIGNMENT

A very accurate frequency counter is necessary to align the frequency of the IC-745. However, the frequency can be aligned simply by receiving the WWV signal.

1. Set the frequency display to 10.000.0MHz and be sure that you are receiving the WWV signal.
2. Set the operating mode to CW. An 800Hz beat can be heard.
3. Short the KEY Jack on the rear panel so that the CW side-tone also becomes audible.
4. Adjust the CALIBRATOR Control, located on the top cover, so that the two tones are of the same pitch (in zero beat). If the tones are difficult to adjust because of a difference in their strengths, adjust the CW side-tone level with the CW MONI control, located on the MAIN unit (under the top cover), until the strengths are the same.

When the optional marker unit, IC-EX241 is installed, operating frequency can be calibrated each 25KHz or 100KHz on the all bands.

WHEN ALIGNING THE FREQUENCY, DO NOT PUT THE UNIT IN THE TRANSMIT MODE.

Be sure the T/R switch is in the RECEIVE position, the VOX switch is OFF, and that you do not touch the PTT switch on the microphone.

5 - 11 - 4 RECEIVE ANTENNA TERMINALS

The RECEIVE ANT IN jack is connected to the input terminal of the receiving section, and the RECEIVE ANT OUT jack is connected to the antenna connector through the internal T/R antenna switching circuit.

These two jacks are normally jumpered with a cable, but can be used for:

1. A receiving preamplifier.
2. A separate receiver.
3. Separate receiver and transmitter antennas.

If you wish to use a receiver preamplifier, connect it between the receiver input and antenna output terminals.

If a separate receiver is used, connect it to the receiver antenna output terminal. For a separate receive antenna connect it to the receiver input terminal.

5 - 11 - 5 TRANSVERTER CONNECTION

When a transverter control signal (+8V) is applied to Pin 11 of the ACCESSORY socket, the TRANSVERTER terminal

can be used for a VHF/UHF transverter INPUT/OUTPUT terminal.

The transverter's input/output frequency and signal level should be as follows:

- Transverter INPUT/OUTPUT Frequency
28 ~ 30MHz
- Input/Output Level
Transmit (Output) : Max. 150mV across a 50 ohm load
Receive (Input) : 1 μ V for S/N 10dB

5 - 11 - 6 LINEAR AMPLIFIER CONNECTION

The jacks on the rear panel marked "ALC" and "SEND" are a relay built-in for keying a linear amplifier, and the input for ALC from the linear amplifier. For linear amplifier hookup the SEND jack is for an internal relay and the ALC jack is for ALC input.

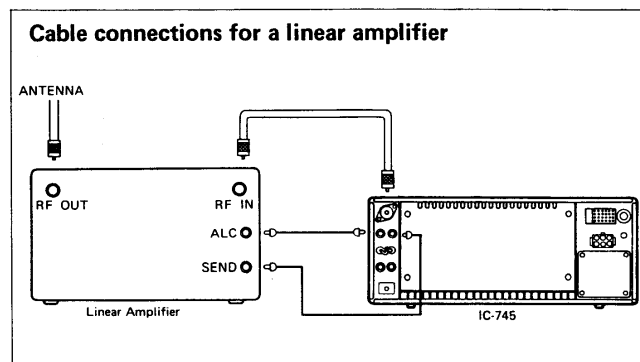

The optional linear amplifier IC-2KL and automatic antenna tuner IC-AT100/AT500 can be connected to the IC-745 with their accessory cables as same as other ICOM HF transceivers. Refer to their instruction manuals for detail.

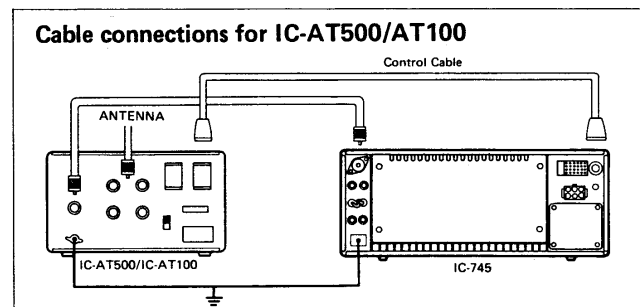

The IC-745 puts out the band control voltage to change operating band automatically for external equipment such as linear amplifier and antenna tuner. The voltage is put out from Pin 13 of the accessory socket. (Refer to page 5.)

Band Control Voltage Chart

BAND (MHz)	Band Control Voltage
1.8	7.0 ~ 8.0V
3.5	6.0 ~ 6.5V
7	5.0 ~ 5.5V
14	4.0 ~ 4.5V
18 - 21	3.0 ~ 2.5V
24 - 28	2.0 ~ 2.5V
10	0 ~ 1.2V

SECTION 6 OPTIONS INSTALLATION

The following tools are needed for the installation of the options:

Philips Screwdriver	Diagonal cutters
Screwdriver	Soldering Iron (40W)
Solder	Soldering tool
De-soldering braid	

Before performing any work on the set, make sure that the power cord is detached from the transceiver.

Remove the top and bottom covers by unscrewing the six screws each on the top and bottom, and the three screws on each side, while taking care not to damage the internal speaker, and unplug its connector.

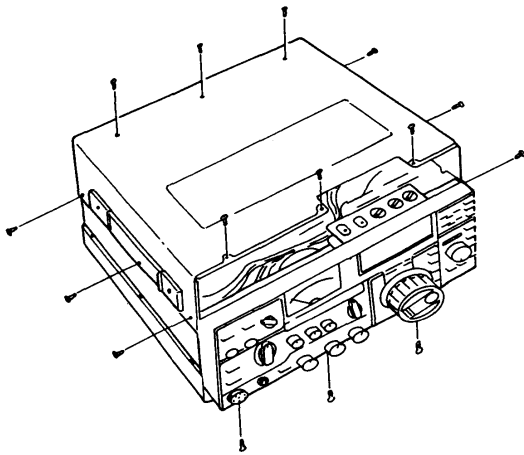

6 - 1 INSTALLATION OF OPTIONAL FILTER

6 - 1 - 1 OPTIONAL FILTERS PREPARED

We have prepared various optional filters as follows.

	CENTER FREQUENCY	CHARACTERISTICS	USABLE MODE
FL-45	9.0115MHz	500Hz/-6dB, 1.6KHz/-60dB	CW·RTTY
FL-54	9.0115MHz	270Hz/-6dB, 1.1KHz/-60dB	CW·RTTY
FL-44A	455.0KHz	2.4KHz/-6dB, 4.2KHz/-60dB	SSB
FL-52A	455.0KHz	500Hz/-6dB, 1.0KHz/-60dB	CW·RTTY
FL-53A	455.0KHz	250Hz/-6dB, 480Hz/-60dB	CW·RTTY

The IC-745 has three positions for installing optional filters. The "C" position is for 9MHz filter, one of FL-45 and FL-54, the "E" position for a 455KHz filter, FL-44A (replacing the original ceramic filter with this), and the "F" position for a 455KHz filter, one of FL-52A and FL-53A.

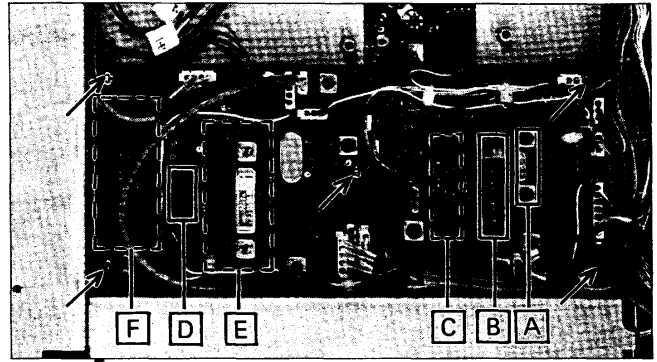
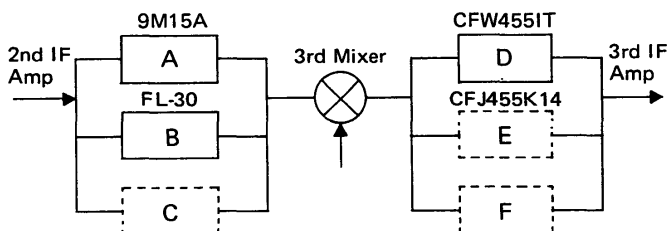

After optional filters are installed, the PBT switch, FILTER switch and PASS-BAND SHIFT control function as follows:

1. When the set is in SSB mode.

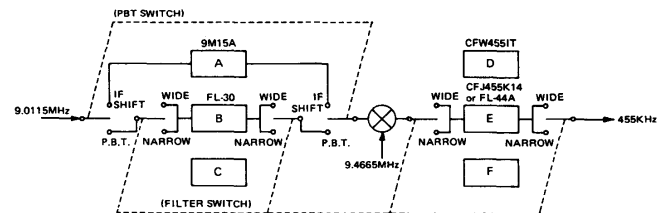

PBT SWITCH	FILTER SWITCH	BAND WIDTH	PBT CONTROL
OFF (IF SHIFT)	OFF (WIDE)	2.2KHz/2.4KHz	IF SHIFT
OFF (IF SHIFT)	ON (NARROW)	2.2KHz/2.4KHz	IF SHIFT
ON (PBT)	OFF (WIDE)	2.3KHz ~ 0.8KHz	EFFECTIVE
ON (PBT)	ON (NARROW)	2.3KHz ~ 0.8KHz	EFFECTIVE

2. When a CW narrow filter is installed.

(This can be used in RTTY mode.)

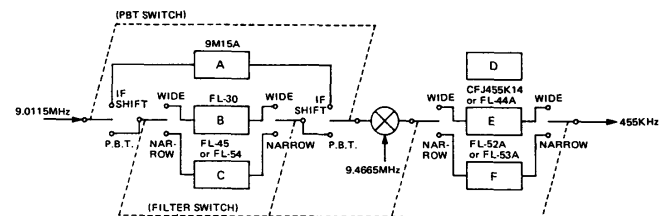

PBT SWITCH	FILTER SWITCH	BAND WIDTH	PBT CONTROL
OFF (IF SHIFT)	OFF (WIDE)	2.2KHz/2.4KHz	IF SHIFT
OFF (IF SHIFT)	ON (NARROW)	*250Hz/500Hz	*IF SHIFT
ON (PBT)	OFF (WIDE)	2.3KHz ~ 0.8MHz	EFFECTIVE
ON (PBT)	ON (NARROW)	**	**

* When FL-52A or FL-53A is installed. If only FL-45 or FL-54 is installed, the set does not work.

** When both 9MHz and 455KHz filters are installed, the PBT is effective and the bandwidth will be varied from 500Hz (or 250Hz) to almost 0. If both filters are not installed, the set does not work.

3. When the set is in AM mode.

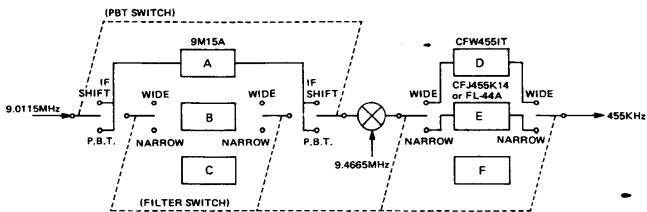

PBT SWITCH	FILTER SWITCH	BAND WIDTH	PBT CONTROL
OFF (IF SHIFT)	OFF (WIDE)	6.0KHz	IF SHIFT
OFF (IF SHIFT)	ON (NARROW)	2.2KHz/2.4KHz	IF SHIFT
ON (PBT)	OFF (WIDE)	6.0KHz	IF SHIFT
ON (PBT)	ON (NARROW)	2.2KHz/2.4KHz	IF SHIFT

6 - 1 - 2 INSTALLATION OF FL-44A (Replacing the original ceramic filter by FL-44A)

1. Unscrew the five screws retaining the IF unit board shown in the photo. Then turn the board over to the front side so that the foil side of the board can be seen.
2. Remove the solder from the ceramic filter sub-board on the IF unit board shown in the photo below, using a de-soldering braid, then remove the sub-board.
3. Insert the FL-44A to the position where the ceramic filter was installed (shown in the photo below) and retain it by using the two supplied nuts, then solder its terminal pins.
4. Replace the IF unit board, and top and bottom covers.
5. No adjustment is required for operation.

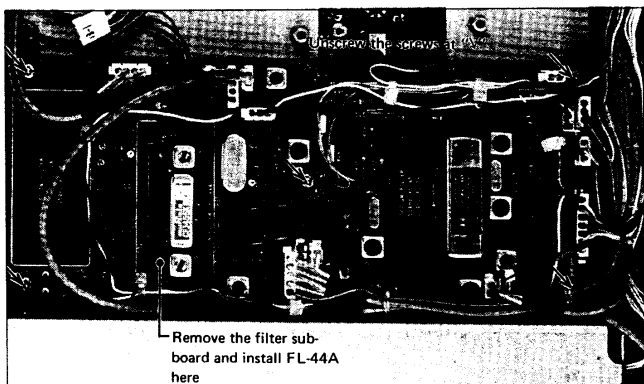

6 - 1 - 3 INSTALLATION OF FL-52A/FL-53A

1. Unscrew the five screws retaining the IF unit board shown in the photo above. Then turn the board over to the front side so that the foil side of the board can be seen.
2. Insert the FL-52A or FL-53A to the position where is shown as "OPTION FILTER" for FL-52A and FL-53A, and retain it by using the two supplied nuts then solder its terminal pins.

3. In the CW or RTTY mode, the FL-52A or FL-53A is selected when the FILTER switch on the front panel is pushed in, and the filter gives 500Hz/-6dB or 250Hz/-6dB pass-band for both the CW and RTTY modes.

4. When the PBT function is desired, install FL-45 or FL-54. If FL-45 or FL-54 is not installed, the set does not work when the PBT switch and FILTER switch are pushed in.

6 - 1 - 4 INSTALLATION OF FL-45/FL-54

1. Unscrew the five screws retaining the IF unit board shown in the photo. Then turn the board over to the front side so that the foil side of the board can be seen.
2. The location for the filter is shown in the photo. The holes for mounting the legs and the leads of the filter are predrilled. Be sure to orient the filter so that the label on the top of the unit is facing the same direction as the other filter already mounted in the set. Insert the filter flush with the board, bend the leads and legs flush with the opposite side of the board and solder them in. Trim the leads even with the solder points. This completes the installation. Replace the IF Unit, and the screws.

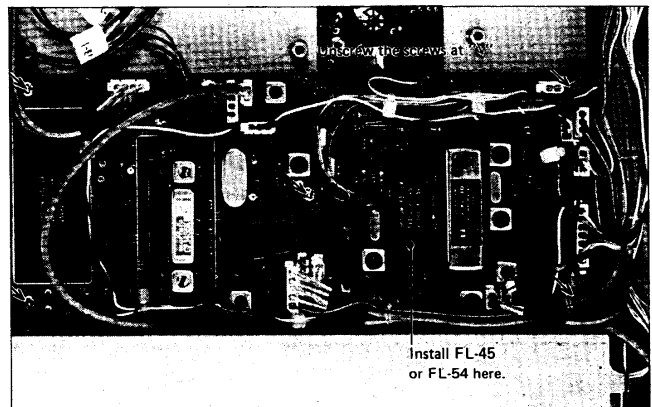

3. The installed filter gives PBT function only when FL-52A or FL-53A is installed. If FL-52A or FL-53A is installed alone, the set does not work when the PBT switch and FILTER switch are pushed in.

6 - 2 MARKER UNIT IC-EX241

This unit generates marker signals to calibrate IC-745's operation frequency. The marker generator puts out accurate 100KHz or 25KHz signals on the entire band, and gives easy and accurate frequency calibration.

6 - 2 - 1 ASSEMBLY PROCEDURE

1. Install this unit in the position as shown in the illustration, using the attached screws.
2. Plug P9 (3 pins) of the set to J1 of this unit.

3. Plug P1 (2 pins) of this unit to J12 of the RF unit.
4. Replace the speaker cord connector, and top and bottom covers.

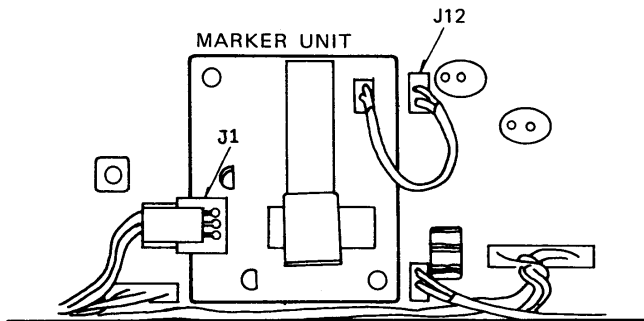

6-2-2 CALIBRATION OF THE MARKER

1. Set the MODE in the CW and BAND on the 10MHz band.
2. The FREQUENCY DISPLAY will show "10.050.0". Turn the TUNING CONTROL knob to tune to WWV (or other standard frequency station) on 10.000.0MHz, and a 800Hz beat tone will be heard. Set the TUNING RATE switch in OFF position for fine tuning.
3. Set the MARKER Switch on the top cover in the "100K" or "25K" and adjust the MARKER CALIBRATION CONTROL on the top cover, so that the two tones are of the same pitch (in zero beat).

6-2-3 CALIBRATION OF THE TRANSCEIVER

1. Set the MODE in the CW. Tune to the lower band edge of the band you want to calibrate, as an example, "21.000.0".
2. Ground the KEY jack on the rear panel so that the CW side-tone becomes audible. (Don't transmit.)
3. Set the MARKER switch in the "100K" or "25K", and adjust the FREQUENCY SET CONTROL of the set so that the two tones are of the same pitch (in zero beat).
4. The frequency calibration is sufficient on a frequency on the same band.

2. Unplug P3 (2 pins with a coaxial cable) which is plugged into J12 of the IF unit, and then plug it into J4 of this unit.
3. Plug P33 (3 pins with a shielded wire and red wire) from the IF unit, into J1 of this unit.
4. Plug P34 (7 pins with a shielded wire, red, orange, yellow, green, and purple wires) from the front panel, into J2 of this unit.
5. Plug P37 (3 pins with brown, blue and yellow wires) from the front panel, into J3 of this unit.
6. Plug P1 (2 pins with a coaxial cable) of this unit, into J12 of the IF unit.
7. Plug P2 (3 pins with a coaxial cable and green wire) of this unit into J8 of the IF unit.
8. Plug P3 (2 pins with a shielded wire) of this unit, into J5 of the MAIN unit.
9. Replace the speaker cord connector, and top and bottom covers.
10. No adjustment is required, and the unit provides a complete FM operation.

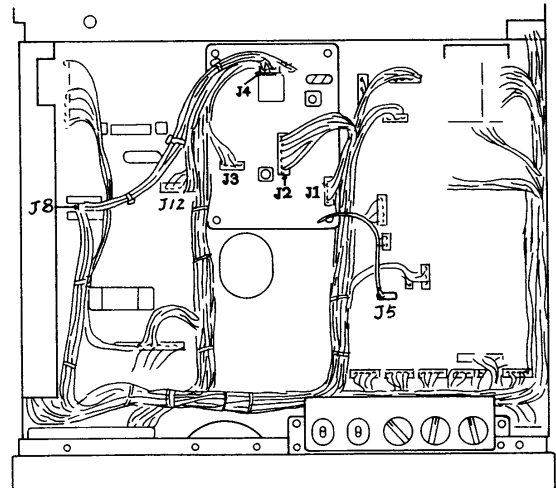

6-3 FM UNIT IC-EX242

This unit has a 9.0115MHz FM generator, 3rd IF amplifier, and FM detector circuits that will upgrade the IC-745 to a complete all-mode transceiver. The unit provides a clear, powerful FM signal, and interference-free steady reception for 29MHz FM and/or a VHF/UHF transverter.

6-3-1 ASSEMBLY PROCEDURE

1. Install this unit into the position shown in the illustration, using the attached screws.

6-3-2 OPERATION

Refer to page 22 for the FM operations. When you would like to use a discriminator-meter, connect a zero-centered meter ($\pm 50\mu\text{A}$ - $100\mu\text{A}$) across Pin 1 and Pin 8 (ground) of the ACCESSORY socket on the rear panel of the set.

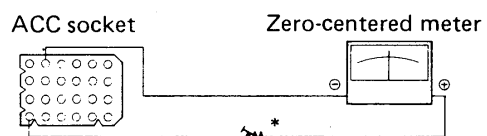

- * Insert a trimmer resistor if the meter swings too much.

6 - 4 ELECTRONIC KEYER UNIT IC-EX243

This unit provides automatic keying function with an iambic paddle. This unit is built with a single CMOS IC. Features designed into this IC include contact debouncing, RF immunity, self-completing character generation, dot memory and weight control.

The keying speed can be changed between 5 - 45 wpm by the VOX GAIN/KEYER SPEED CONTROL on the front panel of the set.

6 - 4 - 1 ASSEMBLY PROCEDURE

1. Install this unit into the position shown in the illustration using the attached screws.
2. Plug P30 which is presently inserted to J24 of the MAIN unit, into J1 of this unit.
3. Plug P53 which is presently inserted to J23 of the MAIN unit, into J2 of this unit.

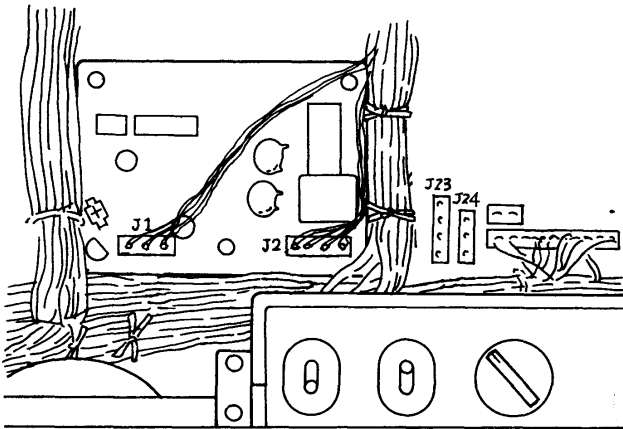

4. Connect an iambic paddle with a 3-p 1/4 inch key plug as shown in the following illustration.

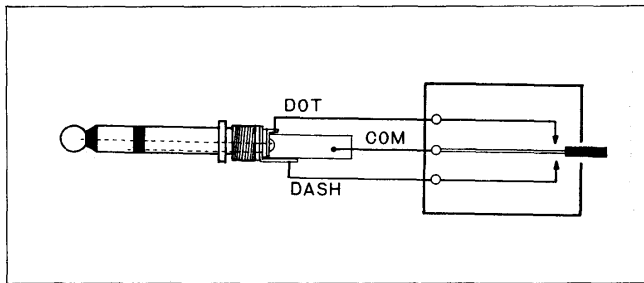

5. Plug the key plug to the KEY JACK on the rear panel.
6. Check the operation of the keyer. If you would like to increase the weight (to alter the dot-space ratio), turn the weight control on this unit clockwise for your favorite position.
7. Replace the speaker cord connector, and top and bottom covers.

6 - 4 - 2 OPERATION

Turn the VOX GAIN/KEYER SPEED CONTROL click on,

and adjust keying speed by turning the control further clockwise for the most comfortable speed for you.

When you don't wish to use the keyer, turn the VOX GAIN/KEYER SPEED CONTROL completely counter-clockwise and click off. Then connect a hand key to the KEY JACK on the rear panel.

6 - 5 BUILT-IN POWER SUPPLY UNIT IC-PS35

6 - 5 - 1 SPECIFICATIONS

Number of Semiconductors

Transistor	5
IC	2
Diode	4

Input Voltage

110/220V AC (50/60Hz)

Allowable Voltage Fluctuation

±10% of input voltage
(suitable line voltage)

Input Capacity

550VA (at 20A load)

Output Voltage

13.8V DC Negative ground

Max. Load Current

20A (10 mins ON/10 mins OFF)

Dimensions

194(W) x 50(H) x 186(D) mm

Weight

Approx. 2.3kg

Kit Included

Main Unit	1
Insulation Spacer	1
Power Socket Unit	1
AC Power Cord	1
Spare Fuses	2
Installation Screws	6
Insulation Washers	6

6 - 5 - 2 PREPARATION

Before performing any work on the set, make sure that the power cord is unplugged from the transceiver.

Remove the top and bottom covers by unscrewing the six screws each on the top and bottom, and the three screws on each side, while taking care not to damage the internal speaker, and unplug its connector.

6 - 5 - 3 ASSEMBLY PROCEDURE

- 1 Turn the transceiver upside down. Remove the "PLATE (A)" attached to the rear panel by unscrewing four screws. These screws will be used later.
- 2 Attach the main unit (power supply) to the bottom cover with supplied screws and insulation washers. At this time, insert the insulation spacer between the main unit and the bottom cover.

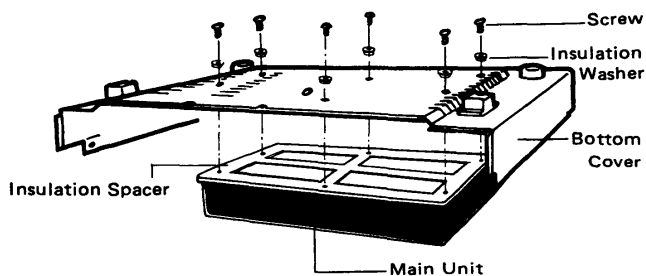

- 3 Pass the DC power cable attached to P1 through the hole of the AC power socket plate as shown in the illustration, then insert the bushing into the hole. Attach the AC power socket plate to the position which was attached the PLATE (A) before, by using the screws described in 1, so that the AC power socket is toward the bottom of the set.

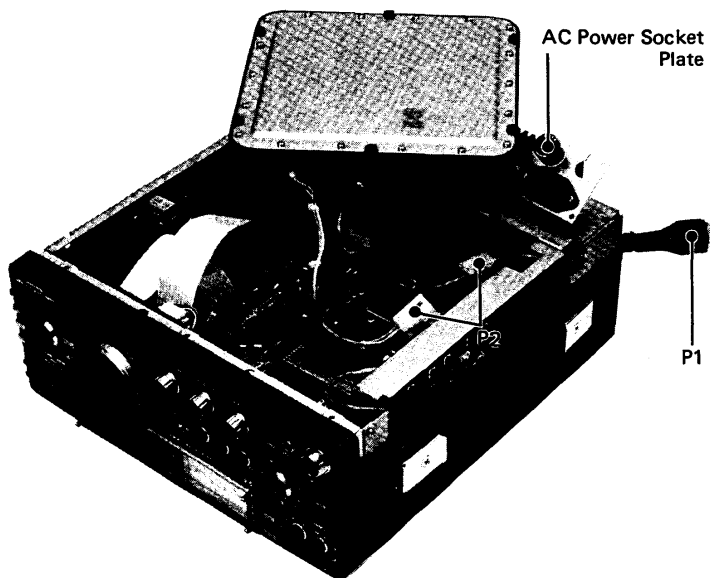
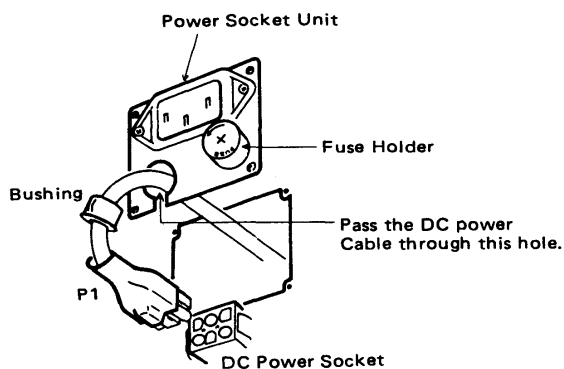

- 4 Pass the connector, P2', from the power socket unit to the inner chassis through the hole of the rear chassis. Then connect it with the connector, P2, from the main unit of the power supply.

- 5 Connect the internal speaker connector and replace the bottom and top covers of the set. Plug P1 of the power supply unit to the DC Power Socket of the set.

6-5-4 OPERATION

1. Connect the DC output plug, P1, of this unit into the transceiver DC power Socket securely. At this time, make sure that:
 - A. The power switch on the transceiver is OFF.
 - B. The T/R switch is in the RECEIVE position.
 - C. The PTT switch on the microphone is not depressed.
 - D. The VOX switch is in the OFF position.
2. Connect the supplied AC power cord into the AC power socket (newly installed) on the rear panel of the transceiver. Then connect the AC power plug into an AC power outlet.

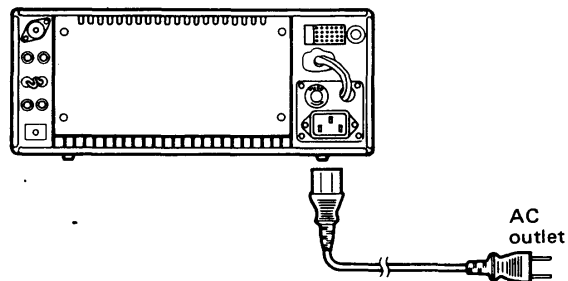

3. By turning the transceiver power switch ON, this unit will be turned ON and supply a DC 13.8V to the transceiver.

6-5-5 CAUTION

1. Ground the GROUND TERMINAL of the set with as short a wire as possible to prevent electrical shock, TVI, BCI and other problems.
2. This unit stops the output voltage with a protection circuit, when output voltage is shorted or consumed load current exceeds 25A. When the output voltage is stopped, turn the power switch of the transceiver OFF and remove the cause of the problem.
3. If the fuse blows, replace it with a 10A (at 117V) or 5A (at 240V) fuse after checking the cause of the problem. Use a Philips (+) screwdriver to open the holder. The outside ring of the holder cannot be rotated.

Downloaded by
RadioAmateur.EU

6-6 OTHER OPTIONS

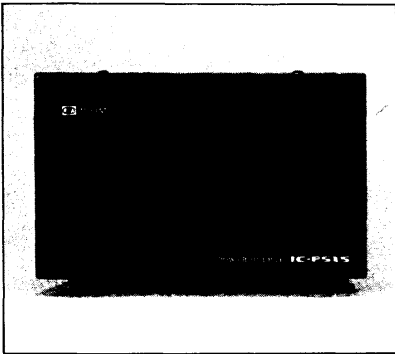

IC-PS15
AC POWER SUPPLY

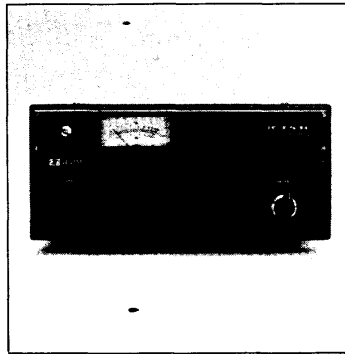

IC-PS30
AC SYSTEM POWER SUPPLY
13.8V 25A

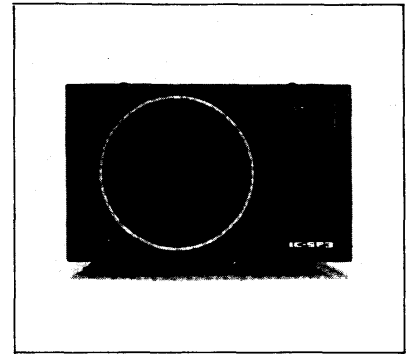

IC-SP3
EXTERNAL SPEAKER

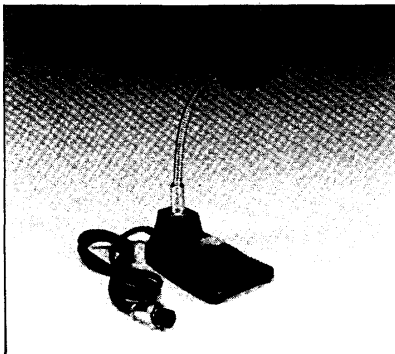

IC-SM6
ELECTRET CONDENSER TYPE
DESK MICROPHONE

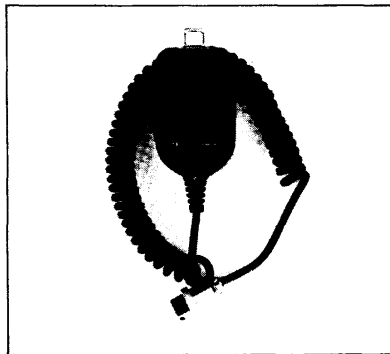

IC-HM12
SCANNING MICROPHONE



IC-HP1
HEADPHONES

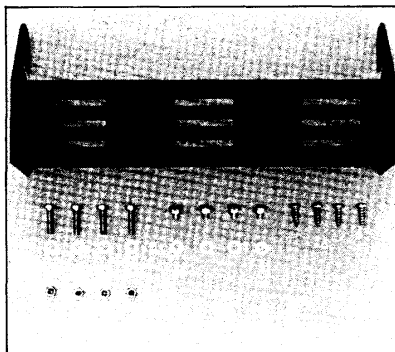

IC-MB12
MOBILE MOUNTING
BRACKET

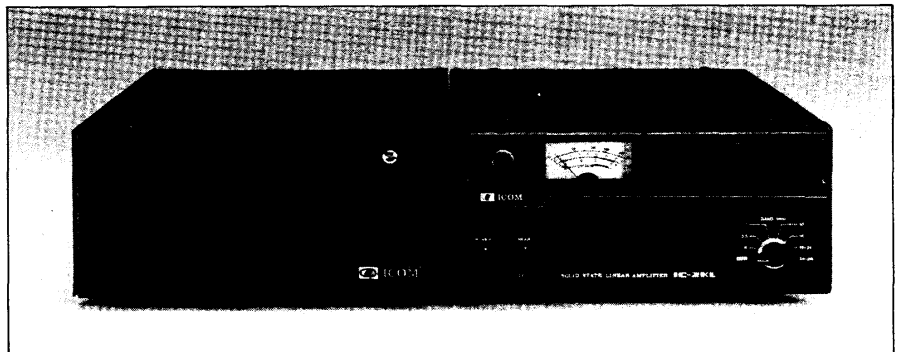

IC-2KLPS
ATTENDANT POWER SUPPLY
FOR IC-2KL

IC-2KL
500W SOLID-STATE
LINEAR AMPLIFIER

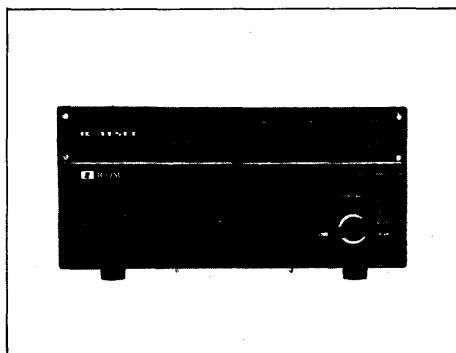

IC-AT100
(100W)

IC-AT500
(500W)

AUTOMATIC
ANTENNA TUNER

SECTION 7 INSIDE VIEWS

7-1 TOP VIEW

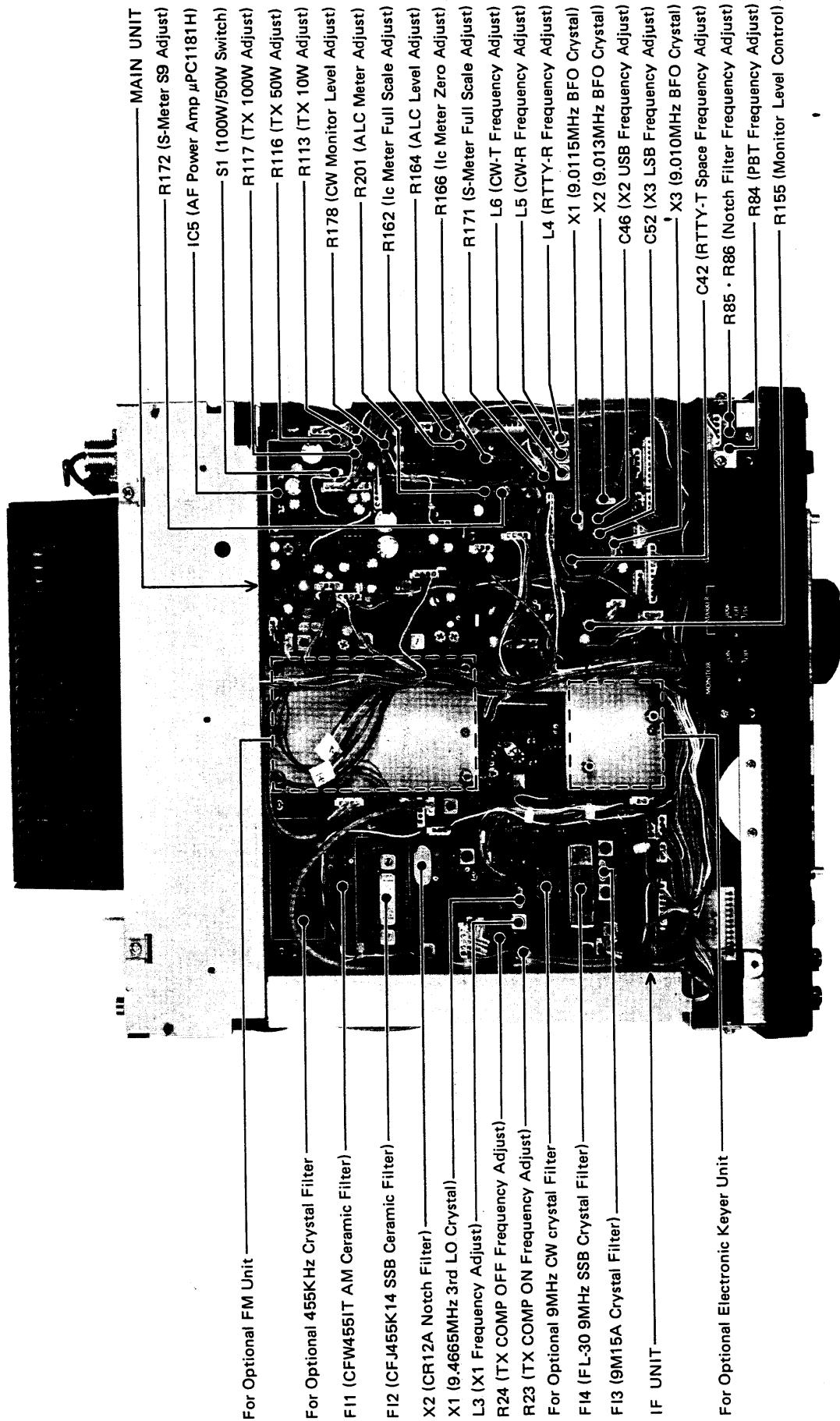

7-2 BOTTOM VIEW

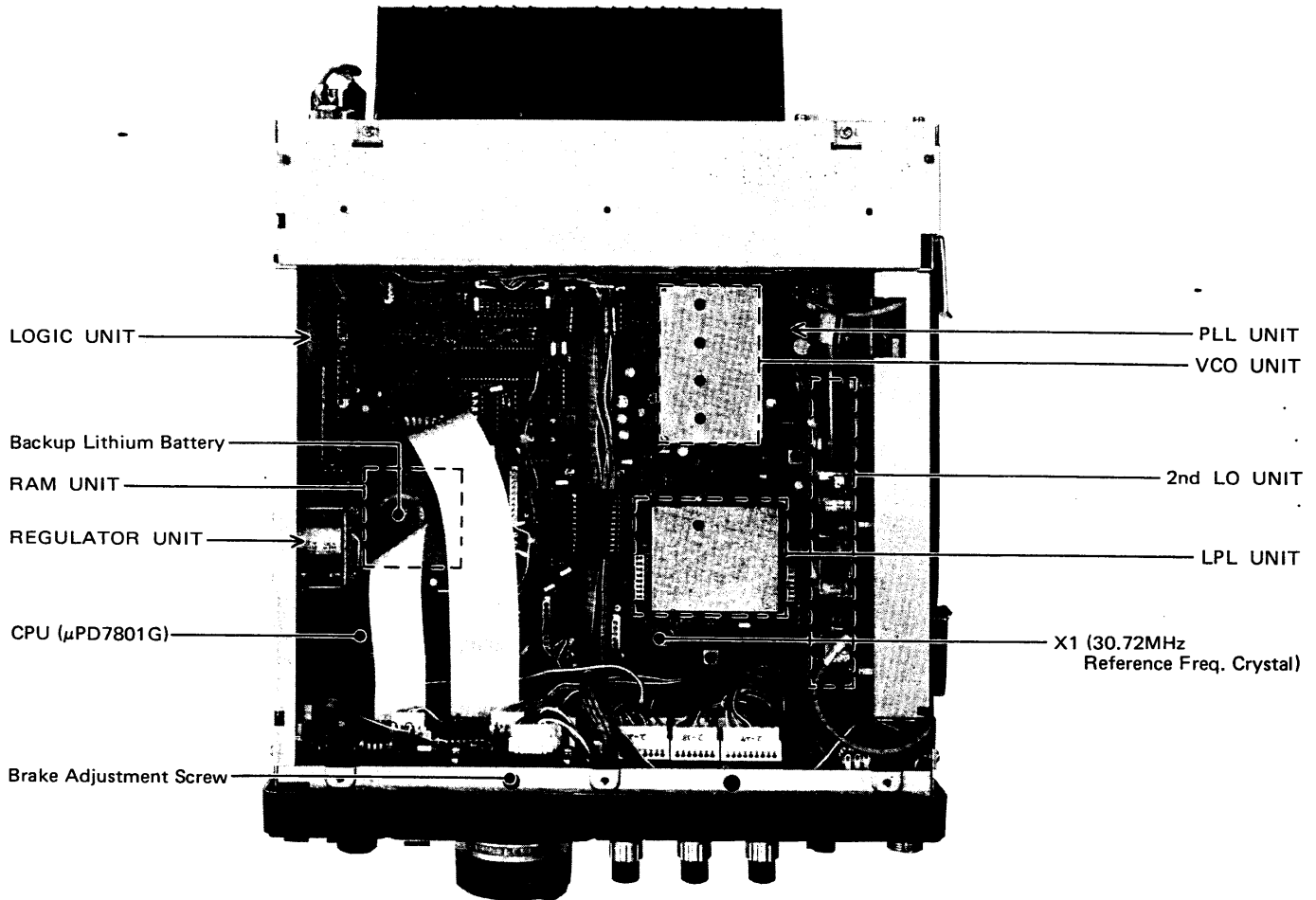

7-3 RF UNIT

Downloaded by
RadioAmateur.EU

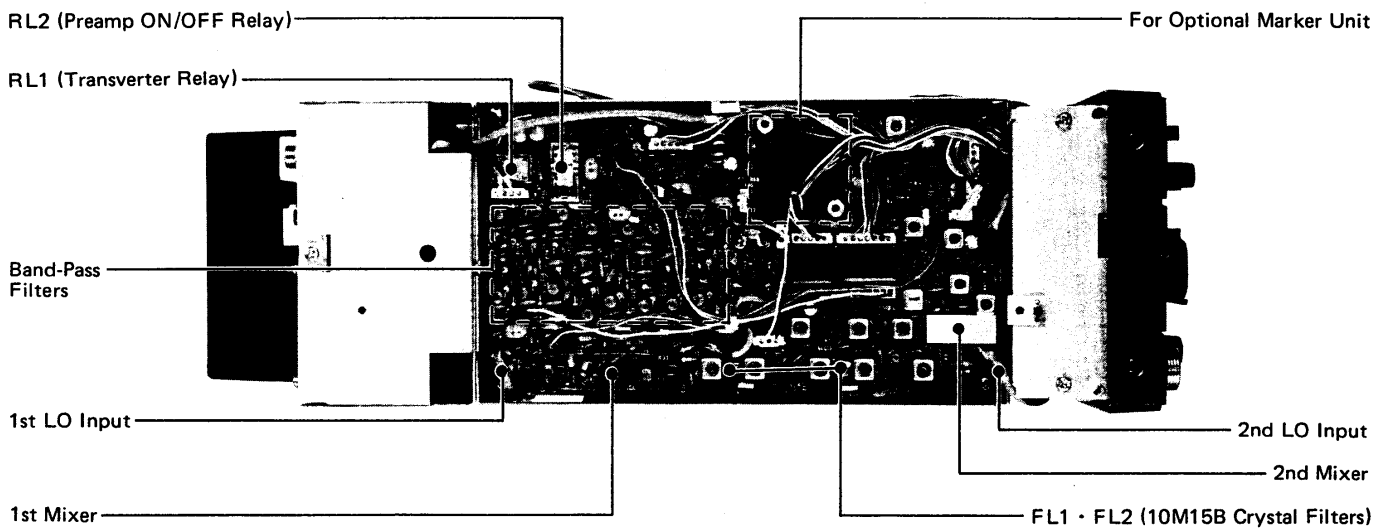

SECTION 8 TROUBLESHOOTING

Your IC-745 has been carefully adjusted at the factory prior to shipping. The chart below has been provided to help you correct problems which are not equipment malfunctions. If you are unable to locate the trouble, or correct the fault, please contact your dealer or the nearest ICOM Service Center.

Problem	Possible Cause	Solution
1. Power does not come on when the switch is pushed.	Power cable is improperly connected. Power cord is connected with the polarity reversed. Blown fuse.	Carefully reconnect power cable. Disconnect the power cord, replace the blown fuse, then reconnect the power cord observing proper polarity. Check for the cause, then replace the fuse with a spare one. If using an IC-PS15 or IC-PS30, also check its fuse.
2. No sound comes from the speaker.	AF GAIN control knob is completely counterclockwise. The unit is in the transmit mode, either by the T/R switch or the PTT switch on the microphone. The external speaker cable is connected to the unit but not to the external speaker jack on the external speaker. The internal speaker cable is not connected. A headphone is connected to the PHONES jack. The FILTER switch and PBT switch are pushed in when the set is in CW mode and optional CW filter is not installed.	Turn the knob clockwise to a suitable level. Put the unit in the receive mode. Connect the cable to the speaker jack on the external speaker. Connect the speaker connection. Unplug the headphone. Set the FILTER switch in out position, or install optional CW filters.
3. Sensitivity is low and only strong signals are audible.	RF GAIN control knob is turned counterclockwise. The antenna feed line is cut or shorted.	Turn the RF Gain control knob fully clockwise. Check the feed line and correct any improper condition.
4. During receive, the "S" meter is higher than the "0" position even when there is no signal.	RF GAIN control knob is turned counterclockwise.	Turn the knob fully clockwise.
5. Only incomprehensible voices are heard during SSB reception.	Receiving the wrong sideband.	Set the sideband opposite the one you are using, either USB or LSB.
6. The tone of the received signal is very high or low pitched.	Maladjustment of the P.B. Shift control.	Set the P.B. Shift control knob to the clear tone position.
7. No output power or low output power.	MIC GAIN setting is too low. When SSB is desired, but the MODE is in the CW. PTT switch is not functioning due to improper connection of the mic connector. The antenna feed line is cut or shorted.	Turn the MIC GAIN control clockwise to the center (12 o'clock) position, or more. Set the MODE to the SSB (USB or LSB). Check the connection of the MIC connector and correct any problems. Check the antenna feed line and correct any improper connection.
8. The receive mode functions properly and your signals are transmitted, but you are unable to make contact with another station.	The SPLIT switch is pushed in. The receive frequency is offset from the transmit frequency by the Incremental Tuning control.	Set the SPLIT switch to the out position. Turn OFF the RIT and/or XIT, or set the control knob to the center (12 o'clock) position.
9. The heatsink on the rear panel becomes hot.	The heatsink on the rear panel is for the final transistors and may become as hot as 40°C (104°F) above room temperature.	Make sure the area around the unit has as much ventilation as possible.
10. The frequency does not change by rotating the Tuning knob.	DIAL LOCK is engaged.	Disengage the DIAL LOCK by pressing and releasing the DIAL LOCK switch.
11. An unusual amount of distortion and/or noise in the transmit signal.	The MIC GAIN is too high when the Speech Processor is ON.	While watching the meter in the ALC mode, turn the MIC GAIN control counterclockwise so that the meter is within marked zone at the voice peak.
12. Unable to key when using an electronic keyer or hand key.	The Switching circuit of the external electronic keyer does not close completely. Polarity of the connection wires from the keyer is reversed. The MODE is not in the CW. The VOX GAIN/KEYER SPEED control is not in the OFF position.	Replace the keyer with one having a voltage of less than 0.4V between the two keying lines at the key down condition, or modify your keyer so that the voltage is less than 0.4 Volts. Connect the keyer wires observing proper polarity. Place the MODE in the CW. Place the control in the OFF position.

SECTION 9 BLOCK DIAGRAM

Downloaded by
RadioAmateur.EU

RF · MAIN · IF UNITS

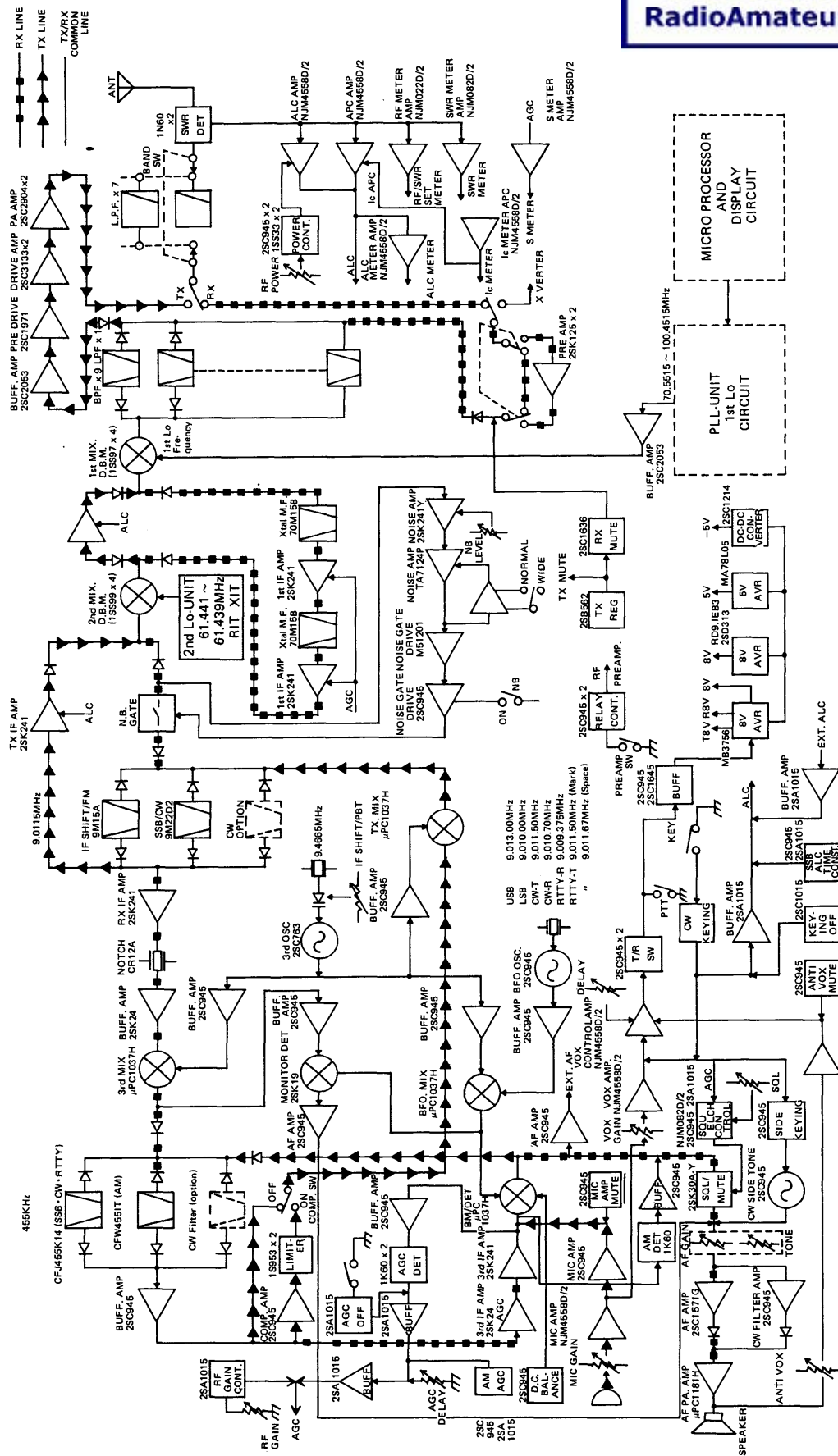

PLL · LOGIC UNITS

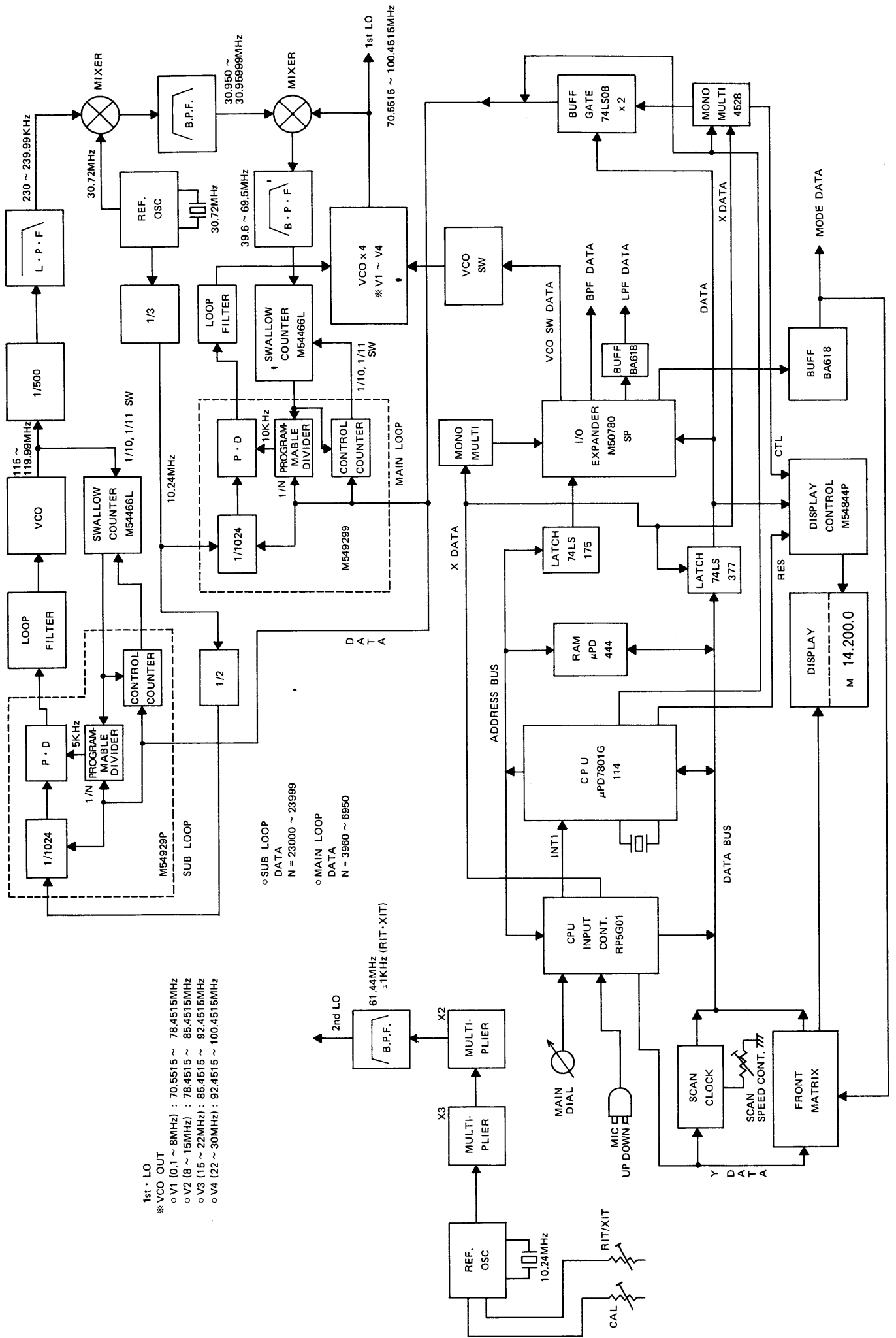



ICOM INCORPORATED
1-6-19, KAMIKURATSUKURI HIRANO-KU,
OSAKA JAPAN

Downloaded by
RadioAmateur.EU

A-0507
Printed in Japan