



INSTRUCTION MANUAL

HF/50 MHz TRANSCEIVER **IC-7600**



FOREWORD

Thank you for making the IC-7600 your radio of choice. We hope you agree with Icom's philosophy of "technology first." Many hours of research and development went into the design of your IC-7600.

FEATURES

- *Ultimate receiver performance: third-order intercept (IP3) of +30 dBm (HF bands only)*
- *Built-in Baudot RTTY and PSK modulator/demodulator and direct PC keyboard connection capability for RTTY and PSK operations without a PC*
- *High resolution spectrum scope— center frequency and fixed frequency modes, plus mini-scope displays*
- *USB connectors on front and rear panels*
- *Large LCD with LED backlight*

IMPORTANT

READ THIS INSTRUCTION MANUAL CAREFULLY before attempting to operate the transceiver.

SAVE THIS INSTRUCTION MANUAL. This manual contains important safety and operating instructions for the IC-7600.

EXPLICIT DEFINITIONS

WORD	DEFINITION
⚠ DANGER	Personal death, serious injury or an explosion may occur.
⚠ WARNING	Personal injury, fire hazard or electric shock may occur.
CAUTION	Equipment damage may occur.
NOTE	If disregarded, inconvenience only. No risk of personal injury, fire or electric shock.

Spurious signals may be received near the following frequencies. These are made in the internal circuit and does not indicate a transceiver malfunction.
10.4923MHz, 24.576MHz

Icom, Icom Inc. and the Icom logo are registered trademarks of Icom Incorporated (Japan) in the United States, the United Kingdom, Germany, France, Spain, Russia and/or other countries. Microsoft, Windows and Windows Vista are either registered trademarks or trademarks of Microsoft Corporation in the United States and/or other countries. All other products or brands are registered trademarks or trademarks of their respective holders.

SUPPLIED ACCESSORIES

The transceiver comes with the following accessories.

	Qty.
① Hand microphone	1
② DC power cable	1
③ Spare fuse (ATC 5 A)	1
④ Spare fuse (ATC 30 A)	2
⑤ 6.35 (d) mm plug.....	1

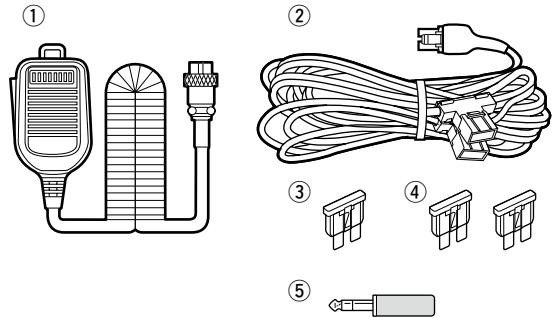

FCC INFORMATION

• FOR CLASS B UNINTENTIONAL RADIATORS:

This equipment has been tested and found to comply with the limits for a Class B digital device, pursuant to part 15 of the FCC Rules. These limits are designed to provide reasonable protection against harmful interference in a residential installation. This equipment generates, uses and can radiate radio frequency energy and, if not installed and used in accordance with the instructions, may cause harmful interference to radio communications. However, there is no guarantee that interference will not occur in a particular installation. If this equipment does cause harmful interference to radio or television reception, which can be determined by turning the equipment off and on, the user is encouraged to try to correct the interference by one or more of the following measures:

- Reorient or relocate the receiving antenna.
- Increase the separation between the equipment and receiver.
- Connect the equipment into an outlet on a circuit different from that to which the receiver is connected.
- Consult the dealer or an experienced radio/TV technician for help.

PRECAUTIONS

⚠ WARNING HIGH RF VOLTAGE! NEVER attach an antenna or internal antenna connector during transmission. This may result in an electrical shock or burn.

⚠ WARNING! NEVER operate the transceiver with a headset or other audio accessories at high volume levels. Hearing experts advise against continuous high volume operation. If you experience a ringing in your ears, reduce the volume or discontinue use.

⚠ WARNING! Immediately turn the transceiver power OFF and remove the power cable if it emits an abnormal odor, sound or smoke. Contact your Icom dealer or distributor for advice.

CAUTION! NEVER put the transceiver in any unstable place (such as on a slanted surface or vibrated place). This may cause injury and/or damage to the transceiver.

CAUTION! NEVER change the internal settings of the transceiver. This may reduce transceiver performance and/or damage to the transceiver.

In particular, incorrect settings for transmitter circuits, such as output power, idling current, etc., might damage the expensive final devices.

The transceiver warranty does not cover any problems caused by unauthorized internal adjustment.

CAUTION! NEVER apply AC power to the [DC13.8V] socket on the transceiver rear panel. This could cause a fire or damage the transceiver.

CAUTION! NEVER apply more than 16 V DC, such as a 24 V battery, to the [DC13.8V] socket on the transceiver rear panel. This could cause a fire or damage the transceiver.

CAUTION! NEVER let metal, wire or other objects protrude into the transceiver or into connectors on the rear panel. This may result in an electric shock.

CAUTION! NEVER block any cooling vents on the top, rear or bottom of the transceiver.

CAUTION! NEVER expose the transceiver to rain, snow or any liquids.

CAUTION! NEVER install the transceiver in a place without adequate ventilation. Heat dissipation may be reduced, and the transceiver may be damaged.

CAUTION! NEVER operate or touch the transceiver with wet hands. This may result in an electric shock or damage to the transceiver.

DO NOT use chemical agents such as benzine or alcohol when cleaning the IC-7600, as they can damage the transceiver's surfaces.

DO NOT push the PTT switch when you don't actually desire to transmit.

DO NOT use or place the transceiver in areas with temperatures below $\pm 0^{\circ}\text{C}$ ($+32^{\circ}\text{F}$) or above $+50^{\circ}\text{C}$ ($+122^{\circ}\text{F}$).

DO NOT place the transceiver in excessively dusty environments or in direct sunlight.

DO NOT place the transceiver against walls or putting anything on top of the transceiver. This may overheat the transceiver.

Always place unit in a secure place to avoid inadvertent use by children.

BE CAREFUL! If you use a linear amplifier, set the transceiver's RF output power to less than the linear amplifier's maximum input level, otherwise, the linear amplifier will be damaged.

BE CAREFUL! The rear panel will become hot when operating the transceiver continuously for long periods of time.

Use Icom microphones only (supplied or optional). Other manufacturers' microphones have different pin assignments, and connection to the IC-7600 may damage the transceiver or microphone.

The LCD display may have cosmetic imperfections that appear as small dark or light spots. This is not a malfunction or defect, but a normal characteristic of LCD displays.

During maritime mobile operation, keep the transceiver and microphone as far away as possible from the magnetic navigation compass to prevent erroneous indications.

Turn the transceiver power OFF and/or disconnect the DC power cable when you will not use the transceiver for long period of time.

For U.S.A. only

CAUTION: Changes or modifications to this device, not expressly approved by Icom Inc., could void your authority to operate this device under FCC regulations.

TABLE OF CONTENTS

FOREWORD	i
IMPORTANT	i
EXPLICIT DEFINITIONS	i
SUPPLIED ACCESSORIES	i
FCC INFORMATION	i
PRECAUTIONS	ii
TABLE OF CONTENTS	iii
1 PANEL DESCRIPTION	1–15
■ Front panel	1
■ Rear panel.....	11
■ LCD display	13
■ Screen menu arrangement	15
2 INSTALLATION AND CONNECTIONS	16–24
■ Unpacking	16
■ Selecting a location	16
■ Grounding	16
■ Antenna connection	16
■ Required connections	17
◇ Front panel.....	17
◇ Rear panel	17
■ Advanced connections	18
◇ Front panel.....	18
◇ Rear panel— 1.....	18
◇ Rear panel— 2.....	19
■ USB connection	19
■ Power supply connections.....	20
■ External antenna tuner connection	20
■ Linear amplifier connections	21
◇ Connecting the IC-PW1/EURO.....	21
◇ Connecting a non-Icom linear amplifier	21
■ Transverter jack information	22
■ FSK and AFSK (SSTV) connections.....	22
◇ FSK operation—	
when connecting to [ACC 1]	22
◇ AFSK operation	22
◇ When connecting to the [USB] connector... ..	22
■ Microphone connector information.....	23
■ Microphones.....	23
◇ HM-36	23
◇ SM-50 (Option)	23
■ Accessory connector information	24
3 BASIC OPERATION	25–37
■ Before first applying power.....	25
■ Applying power (CPU resetting).....	25
■ Selecting VFO/memory mode	26
■ Main/Sub band selection.....	26
◇ Main/Sub band switching.....	26
◇ Main/Sub band equalization	26
■ Selecting an operating band	27
◇ Using the band stacking registers.....	27
■ Frequency setting.....	28
◇ Tuning with the main dial.....	28
◇ Direct frequency entry with the keypad.....	28
◇ About 5 MHz band operation	
(USA version only).....	29
◇ Quick tuning step	29
◇ Selecting “kHz” step.....	29
◇ Selecting 1 Hz step.....	30
◇ Auto tuning step function	30
◇ 1/4 tuning step function.....	30
◇ Band edge warning beep.....	31
■ Operating mode selection	32
■ Squelch and receive (RF) sensitivity	33
■ Volume setting.....	34
■ Meter indication selection.....	34
◇ Multi-function digital meter	34
◇ Meter type selection.....	35
■ Voice synthesizer operation.....	35
■ Basic transmit operation.....	36
◇ Transmitting.....	36
◇ Microphone gain adjustment.....	36
◇ Drive gain adjustment	37
4 RECEIVE AND TRANSMIT	38–89
■ Functions for CW operation.....	38
◇ About CW reverse mode.....	38
◇ About CW pitch control	38
◇ CW sidetone function.....	38
◇ APF (Audio Peak Filter) operation	39
■ Electronic keyer functions	40
◇ Memory keyer screen	41
◇ Editing a memory keyer	42
◇ Contest number set mode	43
◇ Keyer set mode.....	44

■ RTTY (FSK) operation.....	46	■ Dualwatch operation.....	79
◇ About RTTY reverse mode	47	■ Noise blanker	81
◇ Twin peak filter	47	◇ NB set mode	81
◇ Functions for the RTTY decoder indication ..	48	■ Noise reduction	82
◇ Setting the decoder threshold level.....	48	■ Dial lock function	82
◇ RTTY memory transmission	49	■ Notch function	83
◇ Automatic transmission/reception setting ...	49	■ Auto tune function	83
◇ Editing RTTY memory	50	■ VOX function.....	84
◇ RTTY decode set mode	51	◇ Using the VOX function.....	84
◇ Data saving.....	53	◇ Adjusting the VOX function	84
■ PSK operation	54	■ Break-in function	85
◇ About BPSK and QPSK modes	55	◇ Semi break-in operation.....	85
◇ Functions for the PSK decoder indication...	56	◇ Full break-in operation	85
◇ Setting the decoder threshold level.....	56	■ Speech compressor	86
◇ PSK memory transmission	57	■ Transmit filter width setting	86
◇ Automatic transmission/reception setting ...	57	■ Δ TX function	87
◇ Editing PSK memory	58	◇ Δ TX monitor function	87
◇ PSK decode set mode	59	■ Monitor function.....	87
◇ Data saving.....	61	■ Split frequency operation	88
■ Repeater operation	62	■ Quick split function	89
◇ Repeater access tone frequency setting ...	62	◇ Split lock function.....	89
■ Tone squelch operation	63		
■ Data mode (AFSK) operation.....	64	5 VOICE RECORDER FUNCTIONS	90–98
■ Spectrum scope screen	65	■ About digital voice recorder.....	90
◇ Center mode	65	■ Recording a received audio	91
◇ Fixed mode	66	◇ Basic recording	91
◇ Mini scope screen indication.....	67	◇ One-touch recording	91
◇ Scope set mode	67	■ Playing the recorded audio.....	92
■ Preamplifier	72	◇ Basic playing.....	92
■ Attenuator.....	72	◇ One-touch playing.....	92
■ RIT function.....	73	■ Protect the recorded contents	93
◇ RIT monitor function	73	■ Erasing the recorded contents	93
■ AGC function	74	■ Recording a message for transmit	94
◇ Selecting the preset value	74	◇ Recording	94
◇ Setting the AGC time constant preset value ..	74	◇ Confirming a message for transmit.....	94
■ Twin PBT operation	75	■ Programming a memory name.....	95
■ IF filter selection	76	■ Sending a recorded message	96
◇ IF filter selection.....	76	◇ Transmit level setting.....	96
◇ Filter passband width setting		■ Voice set mode	97
(except FM mode).....	76	■ Saving a voice message	
◇ Roofing filter selection	77	into the USB-Memory.....	98
◇ DSP filter shape.....	77	◇ Saving the received audio memory	98
◇ Filter shape set mode	78	◇ Saving the TX memory	98

1

2

3

4

5

6

7

8

9

10

11

12

13

14

15

TABLE OF CONTENTS

6 MEMORY OPERATION..... 99–104	9 CLOCK AND TIMERS 115–117
■ Memory channels..... 99	■ Clock set mode 115
■ Memory channel selection 99	■ Daily timer setting..... 116
◇ Using the [▲]/[▼] keys 99	■ Setting sleep timer 117
◇ Using the keypad 99	■ Timer operation 117
■ Memory list screen..... 100	10 SET MODE 118–143
◇ Selecting a memory channel	■ Set mode description 118
using the memory list screen..... 100	◇ Set mode operation 118
◇ Confirming programmed memory channels.. 100	◇ Screen arrangement 119
■ Memory channel programming 101	■ Level set mode 120
◇ Programming in VFO mode 101	■ ACC set mode 124
◇ Programming in memory mode 101	■ Display set mode..... 126
■ Frequency transfers 102	■ Others set mode..... 128
◇ Transferring in VFO mode 102	■ USB-Memory set menu..... 136
◇ Transferring in memory mode..... 102	◇ USB-Memory set screen arrangement 136
■ Memory names 103	■ File loading..... 137
◇ Editing (programming) memory names 103	◇ Load option set mode 138
■ Memory clearing..... 103	■ File saving 139
■ Memo pads 104	◇ Save option set mode 140
◇ Writing frequencies and operating modes	■ Changing a file name 141
into memo pads 104	■ Deleting a file 142
◇ Calling up a frequency from a memo pad .. 104	■ Unmounting USB-Memory 142
7 SCANS 105–111	■ Formatting the USB-Memory 143
■ Scan types 105	11 MAINTENANCE 144–150
■ Preparation..... 105	■ Troubleshooting 144
■ Scan set mode 106	◇ Transceiver power 144
■ Programmed scan operation..... 107	◇ Transmit and receive 144
■ ΔF scan operation..... 107	◇ Scanning..... 145
■ Fine programmed scan/Fine ΔF scan..... 108	◇ Display 145
■ Memory scan operation..... 109	◇ Format USB-Memory..... 145
■ Select memory scan operation..... 109	■ Main dial brake adjustment 145
■ Setting select memory channels 110	■ SWR reading..... 146
◇ Setting in scan screen 110	■ Screen type and font selections 146
◇ Setting in memory list screen 110	■ Frequency calibration (approximate)..... 147
◇ Erasing the select scan setting..... 110	■ Opening the transceiver's case 148
■ Tone scan 111	■ Clock backup battery replacement..... 148
8 ANTENNA TUNER OPERATION 112–114	■ Fuse replacement 149
■ Automatic antenna selection 112	◇ DC power cable fuse replacement..... 149
■ Antenna tuner operation..... 113	◇ Circuitry fuse replacement..... 149
◇ Tuner operation 113	■ Resetting the CPU 149
◇ Manual tuning 113	■ About protection indications..... 150
■ Optional external tuner operation..... 114	■ Screen saver function..... 150

12 CONTROL COMMAND 151–159

- Remote jack (CI-V) information 151
 - ◇ CI-V connection example..... 151
 - ◇ Data format..... 151
 - ◇ Command table 152
 - ◇ Data content description 157

13 SPECIFICATIONS AND OPTIONS 160–161

- General 160
- Transmitter..... 160
- Receiver 160
- Antenna tuner..... 160
- Options..... 161

14 UPDATING THE FIRMWARE 162–165

- General 162
- Caution..... 162
- Preparation..... 163
 - ◇ Firmware and firm utility..... 163
 - ◇ File downloading 163
- Firmware update 164

15 CE 166–167



Front panel

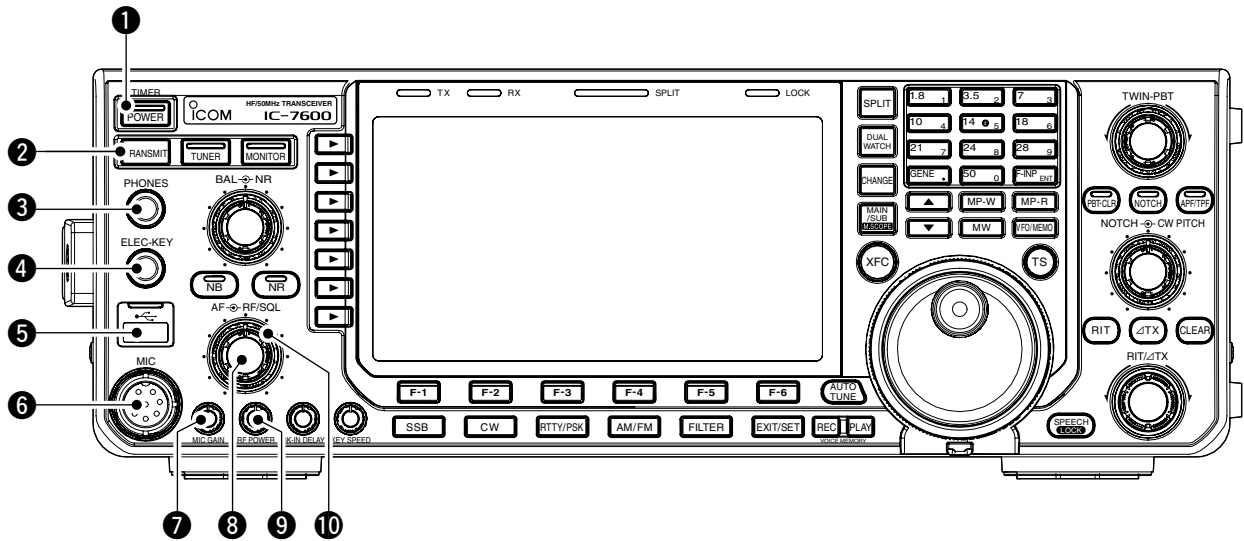

1 POWER SWITCH [POWER•TIMER] (p. 30)

While transceiver's power is OFF:

- ➔ Push to turn the transceiver power ON.
 - Turn the optional DC power supply ON in advance.
 - The indicator on this switch lights green when powered ON.

While transceiver's power is ON:

- ➔ Push momentarily to toggle the timer function ON and OFF. (p. 117)
 - The timer indicator appears when the timer function is ON. (If the transceiver's power is OFF, the indicator on this switch lights red.)
- ➔ Push and hold for 1 sec. to turn the transceiver power OFF.

2 TRANSMIT SWITCH [TRANSMIT]

Selects transmit or receive.

- The [TX] indicator lights red while transmitting and the [RX] indicator lights green when the squelch is open.

3 HEADPHONE JACK [PHONES]

Accepts standard stereo headphones (impedance: 8 to 16 Ω).

- Output power: 5 mW with an 8 Ω load.
- When headphones are connected, the internal speaker or connected external speaker does not function.

4 ELECTRONIC KEYSER JACK [ELEC-KEY]

Accepts a paddle to activate the internal electronic keyer for CW operation. (p. 17)

- You can select internal electronic keyer, bug-key or straight key operation in keyer set mode screen. (p. 44)
- A straight key jack is located on the rear panel. See [KEY] on p. 12.
- Keyer polarity (dot and dash) can be reversed in keyer set mode screen. (p. 45)
- A 4-channel memory keyer is available for your convenience. (p. 41)

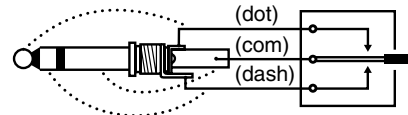

5 USB (Universal Serial Bus) CONNECTOR (A type) [USB] (A) (p. 19)

➔ Insert USB-Memory* for both reading/storing a wide variety of the transceiver's information and data.

- The indicator above the connector lights or blinks when the transceiver reads or writes to the memory data.
- Unmount operation should be performed before removing the USB-Memory* (p.142).

➔ Connects a PC keyboard for RTTY and PSK operations, etc.

- Only USB keyboards* are supported.

*: USB-Memory and USB keyboard are not supplied by Icom.

6 MICROPHONE CONNECTOR [MIC]

Accepts the supplied or optional microphone.
 • See p. 161 for appropriate microphones.
 • See p. 23 for microphone connector information.

7 MIC GAIN CONTROL [MIC GAIN] (p. 36)

Adjusts microphone input gain.
 • The transmit audio tone in SSB, AM and FM modes can be adjusted independently in level set mode. (p. 121)

✓ How to set the microphone gain.

Set the [MIC GAIN] control so that the ALC meter occasionally moves up-scale during normal voice transmission in SSB, AM or FM mode.

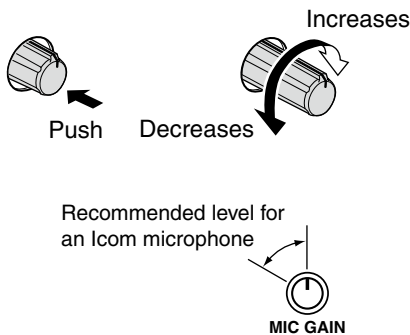

8 AF CONTROL [AF] (inner control; p. 34)

Varies the audio output level of the speaker or headphones.

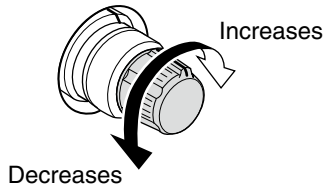

9 RF POWER CONTROL [RF POWER] (p. 36)

Continuously varies the RF output power from minimum (2 W*) to maximum (100 W*).

*AM mode: 1 W to 30 W

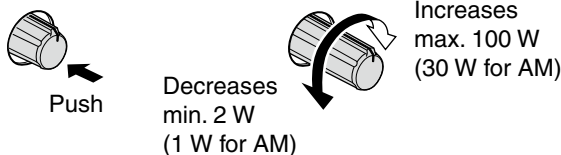

10 RF GAIN CONTROL/SQUELCH CONTROL

[RF/SQL] (outer control; p. 33)

Adjusts the RF gain and squelch threshold level. The squelch removes noise output from the speaker (closed condition) when no signal is received.

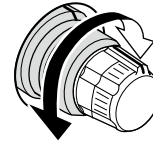

- The squelch is particularly effective for FM. It is also available for other modes.
- 12 to 1 o'clock position is recommended for any setting of the [RF/SQL] control.
- The control can be set as 'Auto' (RF gain control in SSB, CW, RTTY and PSK; squelch control in AM and FM) or squelch control (RF gain is fixed at maximum) in set mode as follows. (p. 128)

MODE	SET MODE SETTING		
	AUTO	SQL	RF GAIN + SQL
SSB, CW RTTY/PSK	RF GAIN	SQL	RF GAIN + SQL
AM, FM	SQL	SQL	RF GAIN + SQL

• When setting as RF gain/squelch control

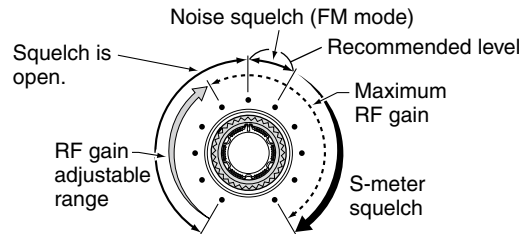

• When functioning as RF gain control

(Squelch is fixed open; SSB, CW, RTTY and PSK only)

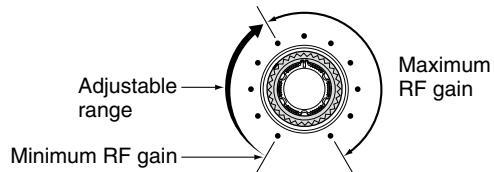

• When functioning as squelch control

(RF gain is fixed at maximum.)

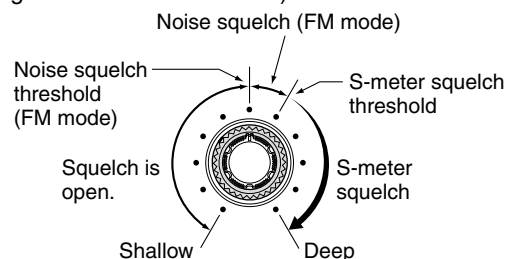

While rotating the RF gain control, noise may be heard. This comes from the DSP unit and does not indicate an equipment malfunction.

■ Front panel (continued)

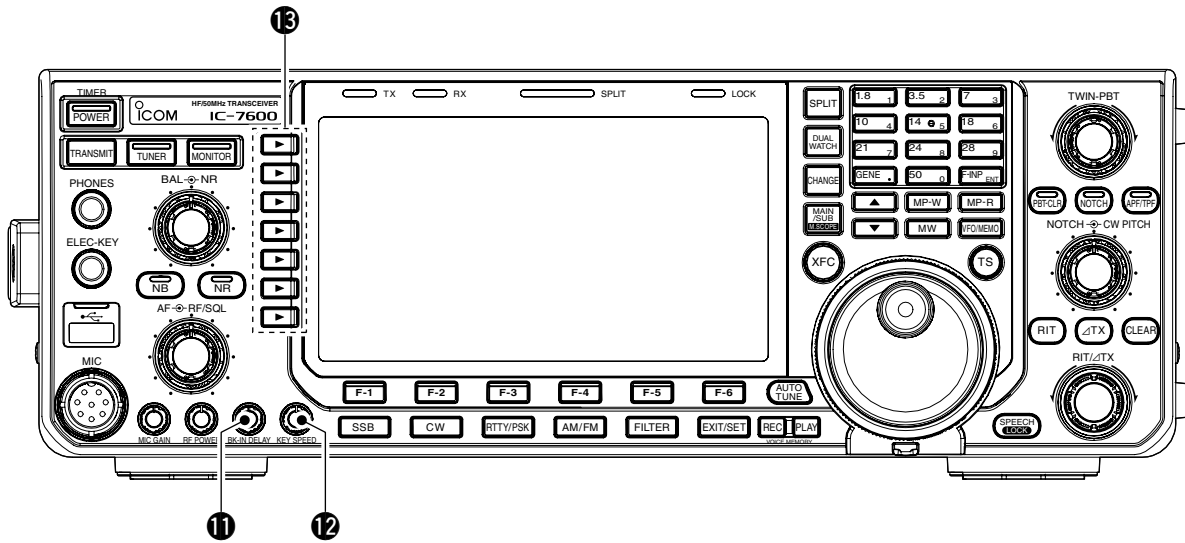

11 BREAK-IN DELAY CONTROL [BK-IN DELAY] (p. 85)

Adjusts the transmit-to-receive switching delay time for CW semi-break-in operations.

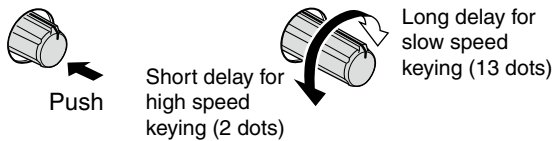

12 ELECTRONIC CW KEYSPEED CONTROL [KEY SPEED] (p. 85)

Adjusts keying speed for the internal electronic CW keyer from 6 wpm (min.) to 48 wpm (max.).

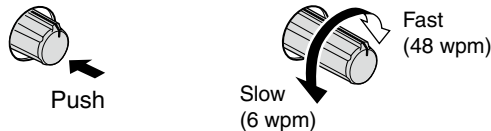

13 MULTI-FUNCTION SWITCHES

Push to select the functions indicated in the LCD display to the right of these switches.
• Functions vary depending on the operating condition.

MF1 (MULTI-FUNCTION 1 SWITCH) ANT SWITCH (ANT)

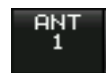

- ➔ Selects the antenna connector between ANT1 and ANT2 when pushed. (p. 112)
- ➔ Turns the [RX ANT] (receive antenna) ON and OFF when pushed and held for 1 sec.
 - When the receive antenna is activated, the antenna connected to the [ANT1] or [ANT2] is used for transmitting only.
- ⚡ When a transverter is in use, this [ANT] does not function and 'TRV' appears.

MF2 (MULTI-FUNCTION 2 SWITCH) METER SWITCH (METER) (p. 34)



- ➔ Selects RF power (Po), SWR, ALC, COMP, Vd or Id metering during transmit.
- ➔ Switches the multi-function digital meter ON and OFF when pushed and held for 1 sec.

MF3 (MULTI-FUNCTION 3 SWITCH)

P.AMP SWITCH (P.AMP) (p. 72)

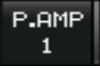
-  ➔ Selects one of 2 receive RF preamps or bypasses them.
- “P. AMP1” activates 10 dB preamp.
 - “P. AMP2” activates 16 dB high-gain preamp.
 - “P. AMP OFF” can also be selected.
- ➔ Turns the preamp function OFF when pushed and held for 1 sec.

✓ *What is the preamp?*

The preamp amplifies signals in the front end to improve S/N ratio and sensitivity. Select “P. AMP1” or “P. AMP2” when receiving weak signals.

MF4 (MULTI-FUNCTION 4 SWITCH)

ATT SWITCH (ATT) (p. 72)

-  ➔ Selects 6 dB, 12 dB or 18 dB attenuator when pushed.
- “ATT OFF” can also be selected.
- ➔ Turns the attenuator function OFF when pushed and held for 1 sec.

✓ *What is the attenuator?*

The attenuator prevents a desired signal from being distorted when very strong signals are near the desired frequency, or when very strong electromagnetic fields, such as from a broadcasting station, are near your location.

MF5 (MULTI-FUNCTION 5 SWITCH)

AGC SWITCH (AGC) (p. 74)

-  ➔ Activates and selects fast, middle or slow AGC time constant when pushed.
- In FM mode, only “FAST” is available.
- ➔ Enters the AGC set mode when pushed and held for 1 sec.

⚡ AGC time constant can be set between 0.1 to 8.0 sec. (depends on mode), or turned OFF. When AGC is “OFF,” the S-meter does not function.

✓ *What is the AGC?*

The AGC controls receiver gain to produce a constant audio output level, even when the received signal strength varies dramatically. Select “FAST” for tuning and then select “MID” or “SLOW” depending on the receiving condition.

MF6 (MULTI-FUNCTION 6 SWITCH)

VOX SWITCH (VOX) (p. 84)

-  ➔ Push to turn the VOX function ON and OFF during SSB, AM and FM mode operation.
- ➔ Push and hold for 1 sec. to enter VOX set mode.

✓ *What is the VOX function?*

The VOX function (voice operated transmission) activates transmission without pushing the transmit switch or PTT switch when you speak into the microphone; then automatically returns to receive when you stop speaking.

BK-IN SWITCH (BK-IN) (p. 85)

-  ➔ Selects semi break-in, full break-in operation, or turns the break-in operation OFF when pushed in CW mode.

✓ *What is the break-in function?*

The break-in function switches transmit and receive with CW keying. Full break-in function (QSK) can monitor the receive signal during keying.

MF7 (MULTI-FUNCTION 7 SWITCH)

COMP SWITCH (COMP) (p. 86)

-  ➔ Turns the speech compressor ON and OFF in SSB mode.
- ➔ Switches the narrow, middle or wide compression when pushed and held for 1 sec.

✓ *What is the speech compressor?*

The speech compressor compresses the transmitter audio input to increase the average audio output level, to increase talk power. This function is effective for long-distance communication or when propagation conditions are poor.

1/4 SWITCH (1/4) (p. 30)

-  ➔ Turns the 1/4 speed tuning function ON and OFF in SSB data, CW, RTTY and PSK modes.
- 1/4 function sets dial rotation to 1/4 of normal speed for fine tuning.

TONE SWITCH (TONE) (pgs. 62, 63)

-  ➔ Switches between the tone encoder, tone squelch function and no-tone operation when pushed in FM mode.
- ➔ Enters the tone set mode when pushed and held for 1 sec. in FM mode.

■ Front panel (continued)

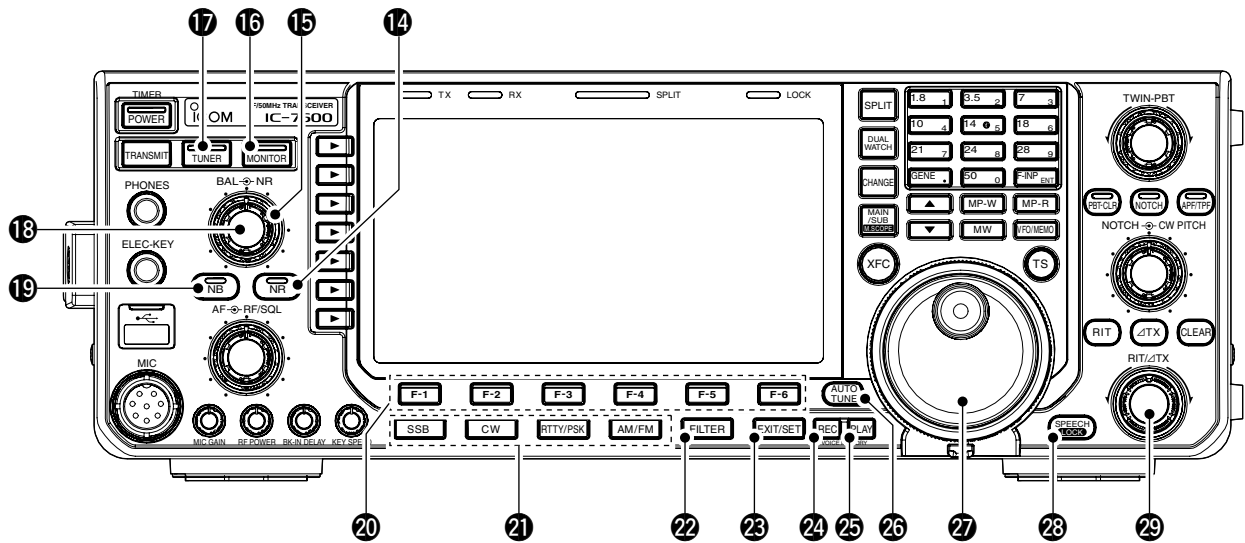

14 NOISE REDUCTION SWITCH [NR] (p. 82)
Push to switch DSP noise reduction ON and OFF.
• The indicator on this switch lights green when the function is activated.

15 NOISE REDUCTION LEVEL CONTROL [NR]
(outer control; p. 82)
Adjusts the DSP noise reduction level when the noise reduction function is in use. Set for maximum readability.
• To use this control, push [NR] (14) in advance.

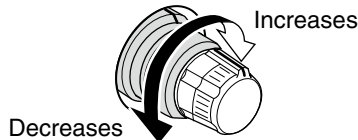

16 MONITOR SWITCH [MONITOR] (p. 87)
Monitors your transmitted IF signal.
• The CW sidetone functions regardless of the [MONITOR] switch setting in CW mode.
• The indicator on this switch lights green while the function is activated.

17 ANTENNA TUNER SWITCH [TUNER] (p. 113)
➔ Turns the internal antenna tuner ON and OFF (bypass) when pushed momentarily.
• The indicator on this switch lights green when the tuner is turned ON, goes off when tuner is turned OFF (bypassed).
➔ Tunes the antenna tuner manually when pushed and held for 1 sec.
• The indicator on this switch blinks red during manual tuning.
• When the tuner cannot tune the antenna, the tuning circuit is bypassed automatically after 20 sec.

18 BALANCE CONTROL [BAL] (inner control; p. 79)
Adjusts the audio output balance between main and sub readout frequencies while in dualwatch.

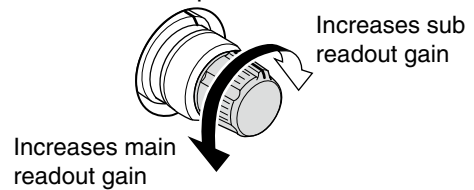

19 NOISE BLANKER SWITCH [NB] (p. 81)
➔ Switches the noise blanker ON and OFF when pushed. The noise blanker reduces pulse-type noise such as that generated by automobile ignition systems. This function cannot be used in FM mode, and is not effective for non-pulse-type noise.
• The indicator on this switch lights green while the function is activated.
➔ Enters the noise blanker level set mode when pushed and held for 1 sec.

20 LCD FUNCTION SWITCHES [F-1] to [F-6]
Push to select the function indicated in the LCD display above these switches.
• Functions vary depending on the operating condition.

21 MODE SWITCHES

Selects the desired mode. (p. 32)

- Announces the selected mode via the speech synthesizer. (p. 35)

[SSB]

- ➔ Selects USB and LSB modes alternately when pushed.
- ➔ Selects SSB data mode (USB-D, LSB-D) when pushed and held for 1 sec. in SSB mode.
 - In SSB data mode, push to return to SSB mode.
- ➔ Switches D1, D2 and D3 when pushed and held for 1 sec. in SSB data mode.

[CW]

Selects CW and CW-R (CW reverse) modes alternately when pushed.

[RTTY/PSK]

- ➔ Selects RTTY and PSK modes alternately when pushed.
- ➔ Switches RTTY and RTTY-R (RTTY reverse) mode when pushed and held for 1 sec. in RTTY mode.
- ➔ Switches PSK and PSK-R (PSK reverse) mode when pushed and held for 1 sec. in PSK mode.

[AM/FM]

- ➔ Selects AM and FM modes alternately.
- ➔ Selects AM or FM data mode (AM-D/FM-D) when pushed and held for 1 sec. in AM or FM mode, respectively.
 - In AM or FM data mode, push to return to AM or FM mode, respectively.
- ➔ Switches D1, D2 and D3 when pushed and held for 1 sec. in AM or FM data mode.

22 FILTER SWITCH [FILTER] (p. 76)

- ➔ Push to select one of 3 IF filter settings.
- ➔ Push and hold for 1 sec. to display the filter set screen.

23 EXIT/SET SWITCH [EXIT/SET]

- ➔ Push to exit, or return to the previous screen indication during spectrum scope, memory, scan or set mode screen display.
- ➔ Push and hold for 1 sec. to display the set mode menu screen.

24 VOICE MEMORY RECORD SWITCH [REC]

(p. 91)

- ➔ Push to record the previous received signal for the preset time period.
 - The preset time period can be set in voice set mode. (p. 97)
- ➔ Push and hold for 1 sec. to record the received signal until the recording is cancelled.
 - Push this switch momentarily to stop recording.
 - The memory records the latest 30 sec. of audio.

25 VOICE MEMORY PLAYBACK SWITCH [PLAY]

(p. 92)

- ➔ Push to playback the previously recorded audio for the preset time period.
- ➔ Push and hold for 1 sec. to playback all of the previously recorded audio.

26 AUTOMATIC TUNING SWITCH [AUTO TUNE]

(p. 83)

Turns the automatic tuning function ON and OFF in CW and AM modes.

IMPORTANT!

When receiving a weak signal, or receiving a signal with interference, the automatic tuning function may tune the receiver to an undesired signal.

27 MAIN DIAL

Changes the displayed frequency, selects set mode setting, etc.

28 SPEECH/LOCK SWITCH [SPEECH/LOCK]

- ➔ Push to announce the S-meter indication, the displayed frequency and the operating mode. (p. 35)
 - The parameters to be announced can be selected in the others set mode. (p. 131)
- ➔ Push and hold for 1 sec. to turn the dial lock function ON and OFF. (p. 82)
 - The dial lock function electronically locks the main dial.
 - The lock indicator lights while the dial lock function is activated.

NOTE: The [SPEECH/LOCK] switch operation to activate the voice synthesizer or the dial lock functions can be replaced in others set mode. (p. 131)

29 RIT/ Δ TX CONTROL [RIT/ Δ TX] (pgs. 73, 87)

Shifts the receive and/or transmit frequency without changing the transmit and/or receive frequency shown on the main VFO while the RIT and/or Δ TX functions are/is ON.

- Rotate the control clockwise to increase the frequency, or rotate the control counterclockwise to decrease the frequency. The RIT or Δ TX functions must be ON.
- The shift frequency range is ± 9.999 kHz in 1 Hz steps (or ± 9.99 kHz in 10 Hz steps).

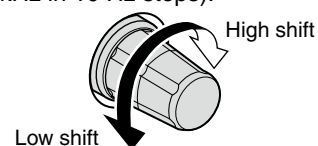

■ Front panel (continued)

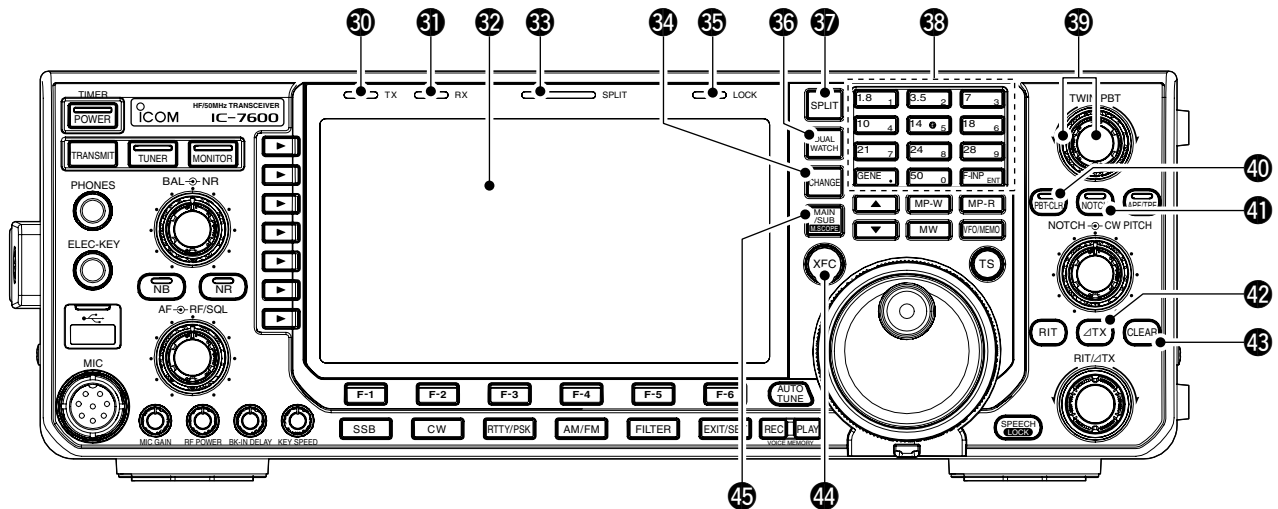
**30 TRANSMIT INDICATOR [TX]**

Lights red while transmitting.

31 RECEIVE INDICATOR [RX]

Lights green while receiving a signal and when the squelch is open.

32 LCD FUNCTION DISPLAY (p. 13)

Shows the operating frequency, function switch menus, spectrum scope screen, memory list screen, set mode settings, etc.

33 SPLIT OPERATION INDICATOR [SPLIT] (p. 88)

Lights during split frequency operation.

34 MAIN/SUB CHANGE SWITCH [CHANGE]

- ➔ Switches the frequency and selected memory channel between main and sub readouts when pushed.
 - Switches between transmit frequency and receive frequency when the split frequency function is ON. (p. 88)
- ➔ Equalizes the sub readout frequency to the main readout frequency when pushed and held for 1 sec.

35 LOCK INDICATOR [LOCK] (p. 82)

Lights when the dial lock function is activated.

36 DUALWATCH SWITCH [DUALWATCH] (p. 79)

- ➔ Push to turn the dualwatch function ON and OFF.
 - “**DUAL-W**” appears when the dualwatch function is in use.
- ➔ Push and hold for 1 sec. to turn the dualwatch function ON and equalizes the sub readout frequency to the main readout. (Quick dualwatch function)
 - The quick dualwatch function can be turned OFF in others set mode. (p. 128)

37 SPLIT SWITCH [SPLIT] (p. 88)

- ➔ Push to turn the split function ON and OFF.
 - “**SPLIT**” appears when the split function is in use.
- ➔ Push and hold for 1 sec. to activate the quick split function.
 - The split function ON and equalize the sub readout frequency to the main readout and sets the sub readout for frequency input in non-FM modes. (p. 89)
 - The offset frequency is shifted from the selected VFO frequency in FM mode. (p. 129)
 - The tone encoder function is turned ON in FM mode.
 - The quick split function can be turned OFF in others set mode. (p. 129)

38 KEYPAD

- ➔ Pushing a key selects the operating band. (p. 27)
 - [GEN •] selects the general coverage band.
- ➔ Pushing the same key 2 or 3 times calls up other stacked frequencies in the band. (p. 27)
 - Icom's triple band stacking register memorizes 3 frequencies in each band.
- ➔ After pushing [F-INP ENT], push a key on the keypad to enter a numeric frequency. After entering, push [F-INP ENT] to select the desired frequency directly (p. 28)
 - e.g. to enter 14.195 MHz; Push [F-INP ENT] [1] [4] [1] [9] [5] [F-INP ENT].
- ➔ After pushing [F-INP ENT], push a key on the keypad to enter a memory channel. After entering, push [▲]/[▼] to select the desired memory channel directly. (p. 99)

39 PASSBAND TUNING CONTROLS [TWIN-PBT]
(p. 75)

Adjusts the receiver's IF filter passband width via the DSP.

- Passband width and shift frequency are displayed in the multi-function display.
- Push and hold [PBT-CLR] for 1 sec. to clear the PBT settings.
- Adjustment range is set to half of the IF filter passband width. 25 Hz steps and 100 Hz steps are available.

✓ **What is the PBT control?**

The PBT function electronically modifies the IF passband width to reject interference. This transceiver uses the DSP circuit for the PBT function.

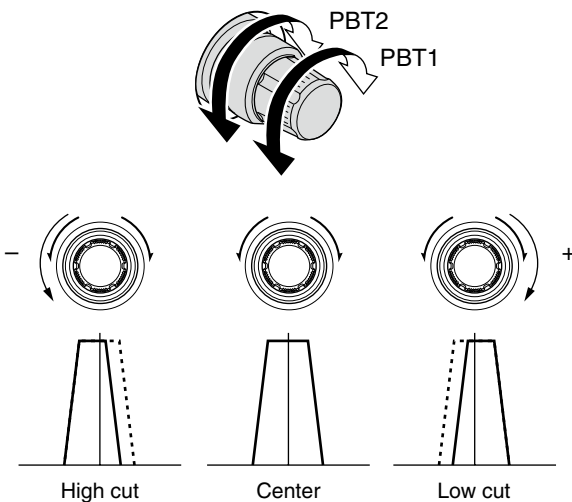

40 PBT CLEAR SWITCH [PBT-CLR] (p. 75)

- Push and hold for 1 sec. to clear the PBT settings.
- The indicator on this switch lights green when PBT is in use.

41 NOTCH SWITCH [NOTCH] (p. 83)

- ➔ Switches the notch function between auto, manual and OFF in SSB and AM modes.
 - Either auto or manual notch function can be deactivated in others set mode. (p. 132)
- ➔ Turns the manual notch function ON and OFF when pushed in CW, RTTY and PSK mode.
- ➔ Turns the auto notch function ON and OFF when pushed in FM mode.
 - “**MN**” appears when manual notch is in use.
 - “**AN**” appears when auto notch is in use.
 - No indicator appears when the notch function is not in use.
- ➔ Push and hold for 1 sec. to switch the manual notch characteristics from wide, middle and narrow when manual notch function is activated.
 - The indicator on this switch lights green when the function is activated.

✓ **What is the notch function?**

The notch function is a narrow filter that eliminates unwanted CW or AM carrier tones while preserving the desired voice signal. The DSP circuit automatically adjusts the notch frequency to effectively eliminate unwanted tones.

42 ΔTX SWITCH [ΔTX] (p. 87)

- ➔ Push to turn the ΔTX function ON and OFF.
 - Use [RIT/ΔTX] control to vary the ΔTX frequency.
- ➔ Push and hold for 1 sec. to add the ΔTX shift frequency to the operating frequency.

✓ **What is the ΔTX function?**

ΔTX shifts the transmit frequency without shifting the receive frequency. This is useful for simple split frequency operation in CW, etc.

43 CLEAR SWITCH [CLEAR] (pgs. 73, 87)

Push or push and hold for 1 sec.* to clear the RIT/ΔTX shift frequency.

* Depending on the quick RIT/ΔTX clear function setting (p. 132).

44 TRANSMIT FREQUENCY CHECK SWITCH [XFC]

- ➔ Monitors the transmit frequency (including ΔTX frequency offset) when pushed and held during split frequency operation. (p. 88)
 - While pushing and holding this switch, the transmit frequency can be changed with the main dial, keypad, memo pad or [▲]/[▼] switches.
 - When the split lock function is turned ON, pushing [XFC] cancels the dial lock function. (pgs. 88, 129)
- ➔ Monitors the operating frequency directly when pushed and held when the RIT function is turned ON. (RIT is temporarily cancelled.) (p. 73)

45 MAIN/SUB•M.SCOPE SWITCH [MAIN/SUB M.SCOPE]

- ➔ Push to select access to the main or sub readout. (p. 26)
 - The selected readout frequency is displayed clearly. The sub readout functions only during split operation or dualwatch.
- ➔ Push and hold for 1 sec. to turn the mini spectrum scope screen indication ON and OFF. (p. 67)
 - The mini spectrum scope screen can be indicated with another screen, such as memory, set mode screen, simultaneously.

■ Front panel (continued)

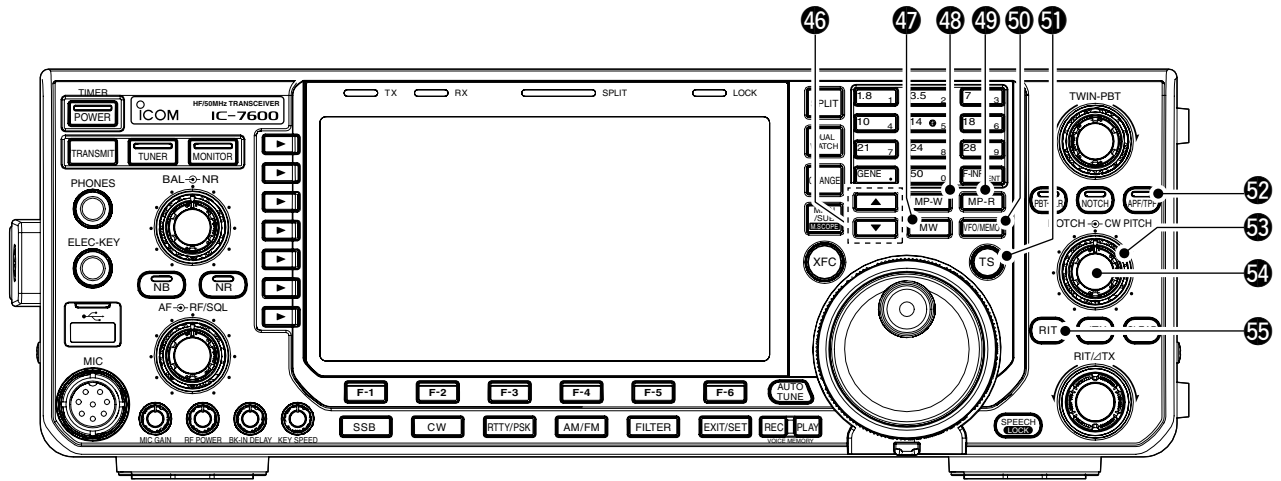

46 MEMORY UP/DOWN SWITCHES [▲]/[▼] (p. 99)

- ➔ Push to select the desired memory channel.
 - Memory channels can be selected both in VFO and memory modes.
- ➔ Push to select the desired memory channel directly after pushing [F-INP ENT] and a memory channel number.

47 MEMORY WRITE SWITCH [MW] (p. 101)

- Stores the selected readout frequency and operating mode into the displayed memory channel when pushed and held for 1 sec.
- This function is available both in VFO and memory modes.

48 MEMO PAD-WRITE SWITCH [MP-W] (p. 104)

- Programs the displayed readout frequency and operating mode into a memo pad.
- The 5 most recent entries remain in memo pads.
 - The memo pad capacity can be expanded from 5 to 10 in others set mode. (p. 132)

49 MEMO PAD-READ SWITCH [MP-R] (p. 104)

- Each push calls up a frequency and operating mode in a memo pad. The 5 (or 10) most recently programmed frequencies and operating modes can be recalled, starting from the most recent.
- The memo pad capacity can be expanded from 5 to 10 in others set mode. (p. 132)

50 VFO/MEMORY SWITCH [VFO/MEMO]

- ➔ Switches the selected readout operating mode between the VFO and memory when pushed. (pgs. 26, 99)
- ➔ Transfers the memory contents to VFO when pushed and held for 1 sec. (p. 102)

51 QUICK TUNING SWITCH [TS]

- ➔ Turns the quick tuning step ON and OFF. (p. 29)
 - While the quick tuning indicator, “▼,” is displayed above the frequency indication, the frequency can be changed in programmed kHz steps.
 - 0.1, 1, 5, 9, 10, 12.5, 20 and 25 kHz steps are available for each operating mode independently.
- ➔ When the quick tuning step is ON, push and hold for 1 sec. to enter quick tuning step set mode. (p. 29)
- ➔ When the quick tuning step is OFF, push and hold for 1 sec. to turn the 1 Hz tuning step ON and OFF. (p. 30)

52 AUDIO PEAK FILTER/TWIN PEAK FILTER SWITCH [APF/TPF]

During CW mode operation (p. 39)

- ➔ Push to turn the audio peak filter ON and OFF.
 - “APF” appears when audio peak filter is in use.
- ➔ When the audio peak filter is ON, push and hold for 1 sec. to select the APF passband width from WIDE, MID and NAR or from 320, 160 and 80 Hz depending on APF type setting (SOFT or SHARP).

During RTTY mode operation (p. 47)

- ➔ Push to turn the twin peak filter ON and OFF.
 - “TPF” appears when twin peak filter is in use.
 - The indicator on this switch lights green when the function is activated.

53 CW PITCH CONTROL [CW PITCH]

(outer control; p. 38)

Shifts the received CW audio pitch and the CW sidetone pitch without changing the operating frequency.

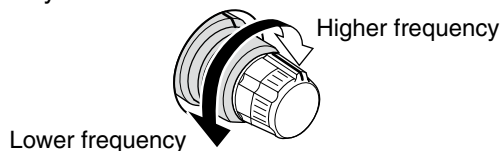

54 MANUAL NOTCH FILTER CONTROL [NOTCH]

(inner control; p. 83)

Varies the notch frequency of the manual notch filter to reject an interfering signal while the manual notch function is ON.

• Notch filter center frequency:

LSB/RTTY/PSK-R : -1040 Hz to +4060 Hz

USB/RTTY-R/PSK : -1060 Hz to +4040 Hz

CW : CW pitch freq. -2540 Hz to

CW pitch freq. +2540 Hz

AM : -5100 Hz to +5100 Hz

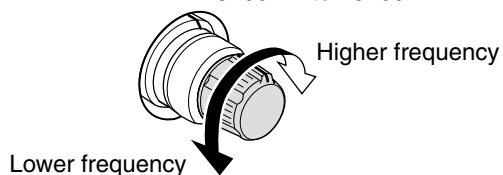

55 RIT SWITCH [RIT] (p. 73)

➔ Push to turn the RIT function ON and OFF.

• Use [RIT/ΔTX] control to vary the RIT frequency.

➔ Push and hold for 1 sec. to add the RIT shift frequency to the operating frequency.

✓ What is the RIT function?

The RIT (Receiver Incremental Tuning) shifts the receive frequency without shifting the transmit frequency.

This is useful for fine tuning stations calling you off-frequency or when you prefer to listen to slightly different-sounding voice characteristics, etc.

■ Rear panel

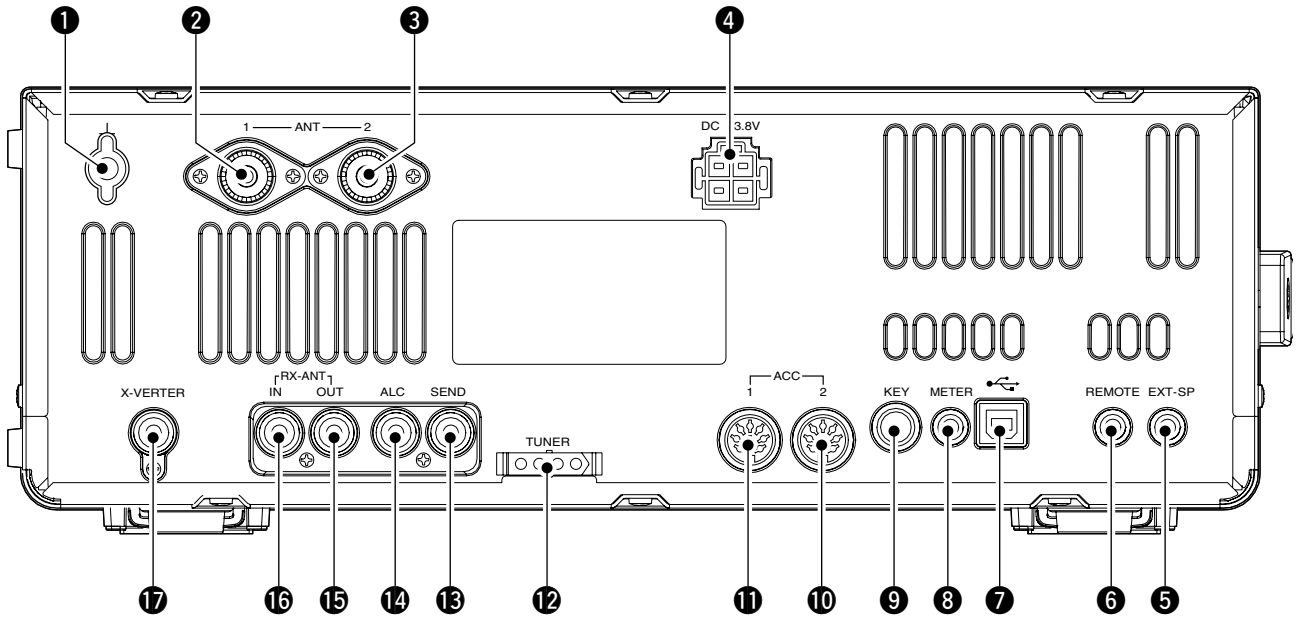

1 GROUND TERMINAL [GND] (p. 16)

Connect this terminal to a ground to prevent electrical shocks, TVI, BCI and other problems.

2 ANTENNA CONNECTOR 1 [ANT1]

3 ANTENNA CONNECTOR 2 [ANT2] (pgs. 17, 112)

Accept a 50 Ω antenna with a PL-259 plug connector.

When using an optional AH-4 HF/50 MHz AUTOMATIC ANTENNA TUNER, connect it to the [ANT1] connector. The internal antenna tuner activates for [ANT2] and deactivates for [ANT1] when connecting the AH-4.

4 DC POWER SOCKET [DC 13.8V] (p. 20)

Accepts 13.8 V DC through the supplied DC power cable.

Rear panel view

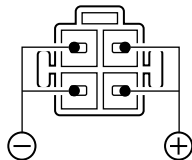

5 EXTERNAL SPEAKER JACK [EXT-SP] (p. 18)

Connects an external speaker (4–8 Ω), if desired.

6 CI-V REMOTE CONTROL JACK [REMOTE]

(pgs. 151, 18)

- ➔ Connects a PC via the optional CT-17 CI-V LEVEL CONVERTER for external control of the transceiver.
- ➔ Used for transceive operation with another Icom CI-V transceiver or receiver.

7 USB (Universal Serial Bus) CONNECTOR (B type) [USB] (B)

Connect a USB cable to be used for the modulation input (p. 124), the transceiver operation with PC, the received audio and the decoded character import to the PC.

CAUTION:

For Windows® XP/2000:

NEVER install the USB driver into the PC before connecting the transceiver and PC using a USB cable.

For Windows Vista™:

NEVER connect a PC using a USB cable until the USB driver installation has been completed.

About the USB driver:

Icom HP (<http://www.icom.co.jp/world/support/index.html>) gives the USB driver and the installation guide download service.

The following items are required:

PC

- Microsoft® Windows® XP/2000 or Microsoft® Windows Vista™ installed
- With USB port

Other items

- USB cable (third party)
- PC software

About the modulation input:

Select "USB" in the ACC set mode item 'DATA OFF MOD,' 'DATA1 MOD,' 'DATA2 MOD' or 'DATA3 MOD.' And the modulation input level from USB jack can be set in the ACC set mode item 'USB MOD Level.' (p. 124)

8 METER JACK [METER] (p. 19)

Outputs a signal showing received signal strength, transmit output power, VSWR, ALC, speech compression, VD or ID level for external meter indication.

9 STRAIGHT KEY JACK [KEY] (p. 17)

Accepts a straight key or external electronic keyer output using a 1/4 inch standard plug.

- [ELEC-KEY] on the front panel can be used for a straight key or external electronic keyer. Deactivate the internal electronic keyer in keyer set mode. (p. 45)

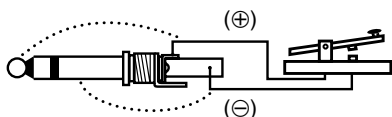

10 ACCESSORY SOCKET 2 [ACC 2]

11 ACCESSORY SOCKET 1 [ACC 1]

Enable connection of external equipment such as a linear amplifier, an automatic antenna selector/tuner, a TNC for data communications, etc.

- See p. 24 for socket information.

12 TUNER CONTROL SOCKET [TUNER] (p. 18)

Accepts the control cable from an optional AH-4 HF/50 MHz AUTOMATIC ANTENNA TUNER.

13 SEND CONTROL JACK [SEND] (p. 18)

Connects to ground when transmitting to control an external unit, such as a non-Icom linear amplifier.

NOTE: T/R control voltage and current must be less than 16 V DC/0.5 A (or 250 V AC, 200 mA with MOSFET switching).

14 ALC INPUT JACK [ALC] (p. 18)

Connects to the ALC output jack of a non-Icom linear amplifier.

15 RECEIVE ANTENNA OUT [RX ANT- OUT]

16 RECEIVE ANTENNA IN [RX ANT- IN]

Located between the transmit/receive switching circuit and receiver's RF stage.

Connects an external unit, such as preamplifier or RF filter, using RCA connectors, if desired.

In this case, the antenna connector must be selected as "ANT 1/R" or "ANT 2/R." (p. 112)

- When no external unit is connected, "ANT 1" or "ANT 2" must be selected.

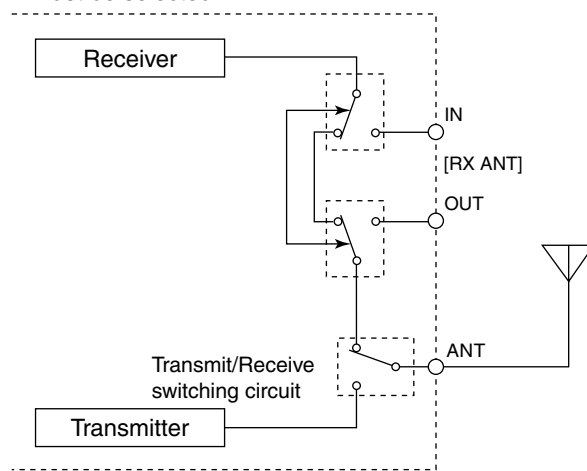

17 TRANSVERTER CONNECTOR [X-VERTER]

(p. 18)

External transverter input/output connector. Activated by voltage applied to [ACC 2] pin 6, or when the transverter function is in use. (p. 24)

■ LCD display

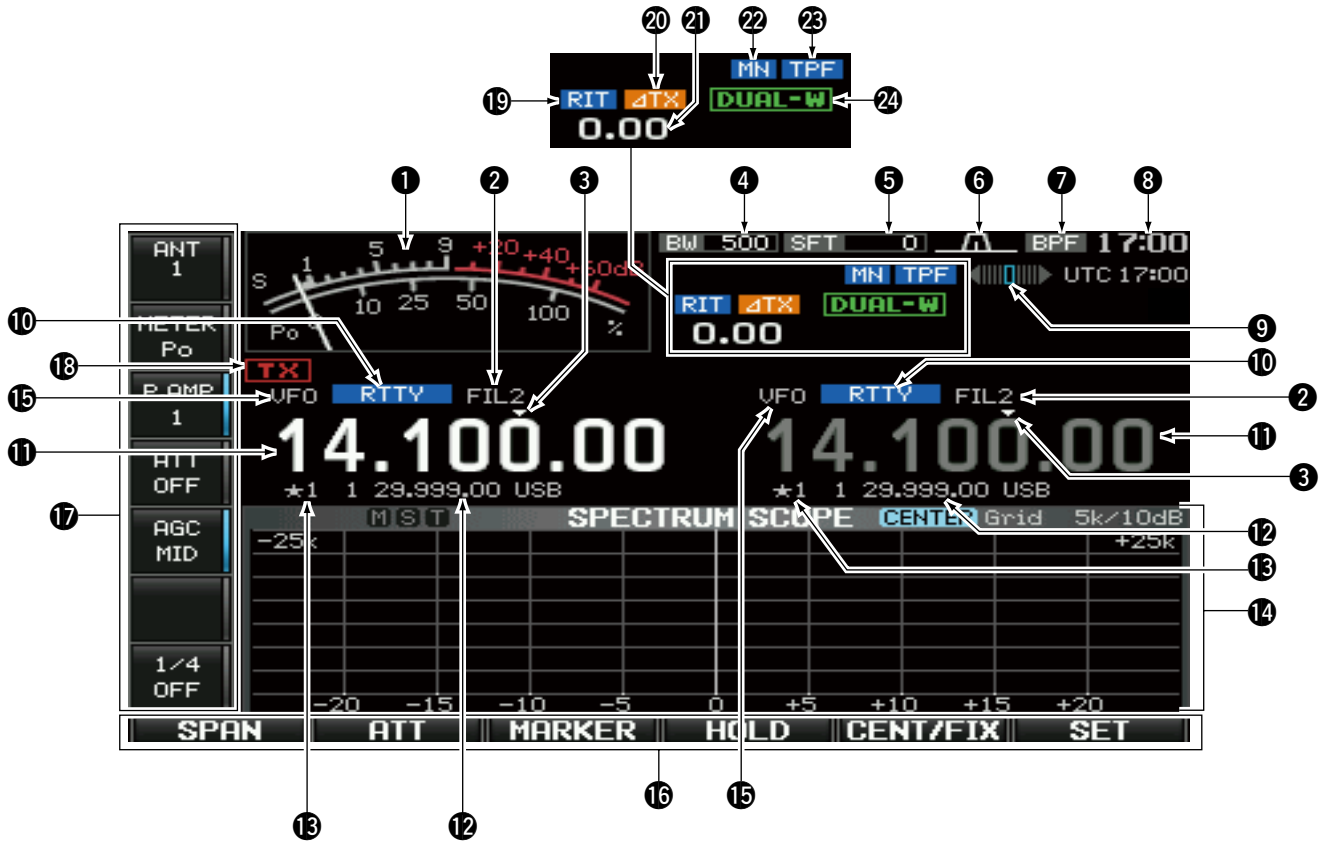

1 S/R F METER (pgs. 35, 126)

Shows the signal strength while receiving. Shows the relative output power, SWR, ALC, VD, ID or compression levels while transmitting.

- A total of 3 meter types are available.
- Standard meter

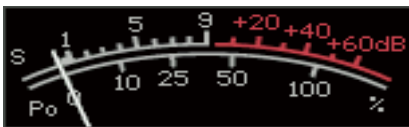

- Edgewise meter

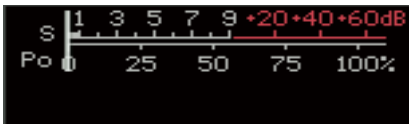

- Bar meter

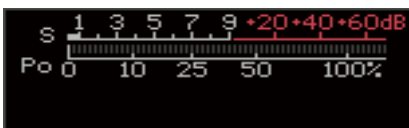

2 IF FILTER INDICATOR (p. 76)

Shows the selected IF filter number.

3 QUICK TUNING INDICATOR (p. 29)

Appears when the quick tuning step function is in use.

4 BANDWIDTH INDICATOR (p. 75)

Shows the passband width of the IF filter.

5 SHIFT FREQUENCY INDICATOR (p. 75)

Shows the shift frequency of the IF filter.

6 PASSBAND WIDTH INDICATOR (p. 75)

Graphically displays the passband width for twin PBT operation and center frequency for IF shift operation.

7 BANDPASS FILTER INDICATOR

Appears when the narrow filter (500 Hz or less) is selected during SSB, CW, RTTY or PSK operation.

8 CLOCK READOUT

Shows the current time.

Local and UTC time can be indicated at the same time.

- Offset time period for UTC time can be set in time set mode. (p. 115)

9 RTTY TUNING INDICATOR

Shows the tuning condition in RTTY mode.

10 MODE INDICATOR

Shows the selected mode.

11 FREQUENCY READOUTS

Shows the operating frequency.

- Gray characters are used for not-selected readout.

12 MEMORY CHANNEL READOUTS

➔ Shows the selected memory channel contents in VFO mode.

➔ Shows the VFO contents in memory mode.

13 SELECT MEMORY CHANNEL INDICATOR (p. 109)

Indicates the displayed memory channel is set as a select memory channel.

14 MULTI-FUNCTION SCREEN

Shows the screens for the multi-function digital meter, spectrum scope, voice recorder, memory list, scan, memory keyer, RTTY decoder, PSK decoder, IF filter selection or set modes, etc.

15 VFO/MEMORY CHANNEL INDICATOR (p. 26)

Indicates the VFO mode or selected memory channel number.

16 LCD FUNCTION SWITCH GUIDE

Indicates the function of the LCD function switches ([F-1] to [F-6]).

17 MULTI-FUNCTION SWITCH GUIDE

Indicates the function of the multi-function switches.

18 TX INDICATOR

➔ “**TX**” appears while transmitting. (p. 36)

➔ Indicates the frequency readout for transmit.

- “**TX**” appears during an operating frequency is not in an amateur band. When the band edge warning beep is set to “OFF” (p. 31), “**TX**” does not appear.
- Appears on the sub band readout when the split function is turned ON.

19 RIT INDICATOR

“**RIT**” appears when RIT function is in use.

20 ΔTX INDICATOR

“**ΔTX**” appears when ΔTX function is in use.

21 RIT/ΔTX SHIFT FREQUENCY INDICATOR

Shows the shift frequency for the RIT or ΔTX function.

22 NOTCH INDICATOR (p. 83)

➔ “**MN**” appears when the manual notch function is in use. This function is available in SSB, CW, RTTY, PSK and AM modes.

➔ “**AN**” appears when the auto notch function is in use. This function is available in SSB, AM and FM modes.

23 APF/TPF INDICATOR

➔ “**APF**” appears when the audio peak filter function is in use. This function is available in CW mode. (p. 39)

➔ “**TPF**” appears when the twin peak filter function is in use. This function is available in RTTY mode. (p. 47)

24 DUAL WATCH INDICATOR

“**DUAL-W**” appears when the dualwatch function is in use.

Screen menu arrangement

The following screens can be selected from the start-up screen. Choose the desired screen using the following chart.

Pushing [EXIT/SET] several times returns to the start-up screen. See p. 119 for set mode arrangement.



• Spectrum scope screen (p. 65)

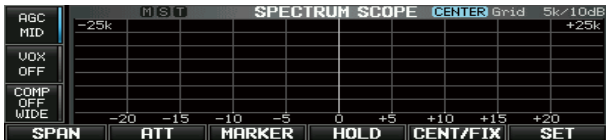

• Voice recorder screen* (p. 90)



• Memory keyer screen (CW mode; p. 40)



• RTTY decoder screen (RTTY mode; p. 46)



• PSK decoder screen (PSK mode; p. 54)



• Memory list screen (p. 100)



• Scan screen (VFO mode; p. 107)

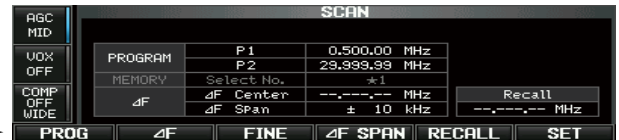

• Scan screen (Memory mode; p. 109)

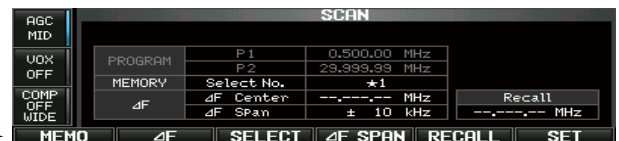

• Set mode menu screen (p. 118)

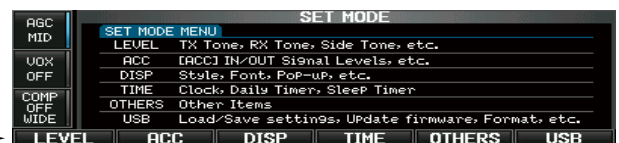

*Previously selected screen, TX or RX memory, is displayed. Push [T/R] (F-6) to switch the screen.

■ Unpacking

After unpacking, immediately report any damage to the delivering carrier or dealer. Keep the shipping cartons.

For a description and a diagram of accessory equipment included with the IC-7600, see 'Supplied accessories' on p. i of this manual.

■ Selecting a location

Select a location for the transceiver that allows adequate air circulation, free from extreme heat, cold, or vibrations, and away from TV sets, TV antenna elements, radios and other electromagnetic sources.

The base of the transceiver has adjustable feet for desktop use. Set the feet to one of two angles depending on your operating preference.

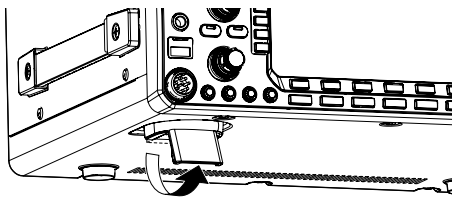

■ Grounding

To prevent electrical shock, television interference (TVI), broadcast interference (BCI) and other problems, ground the transceiver through the GROUND terminal on the rear panel.

For best results, connect a heavy gauge wire or strap to a long ground rod. Make the distance between the [GND] terminal and ground as short as possible.

WARNING: NEVER connect the [GND] terminal to a gas or electric pipe, since the connection could cause an explosion or electric shock.

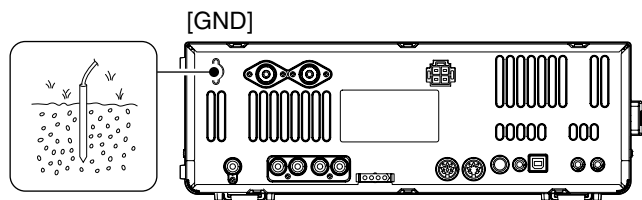

■ Antenna connection

For radio communications, the antenna is of critical importance, along with output power and receiver sensitivity. Select antenna(s), such as a well-matched 50 Ω antenna, and feedline. We recommend 1.5:1 or better of Voltage Standing Wave Ratio (VSWR) on your operating bands. The transmission line should be a coaxial cable.

When using a single antenna, use the [ANT1] connector.

CAUTION: Protect your transceiver from lightning by using a lightning arrester.

PL-259 CONNECTOR INSTALLATION EXAMPLE

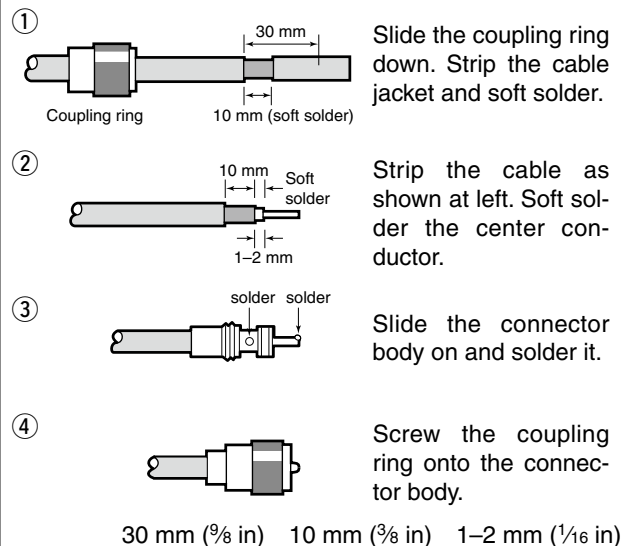

Antenna SWR

Each antenna is tuned for a specified frequency range and SWR may be increased out-of-range. When the SWR is higher than approx. 2.0:1, the transceiver's power drops to protect the final transistors. In this case, an antenna tuner is useful to match the transceiver and antenna. Low SWR allows full power for transmitting. The IC-7600 has an SWR meter to monitor the antenna SWR continuously.

Required connections

Front panel

CW KEY

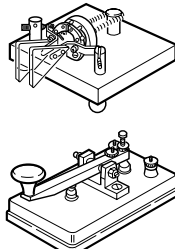

A straight key can be used when the internal electronic keyer is turned OFF in keyer set mode. (p. 45)

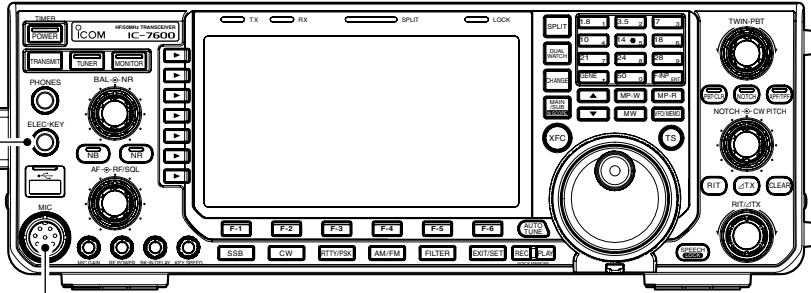

MICROPHONES (p. 23)

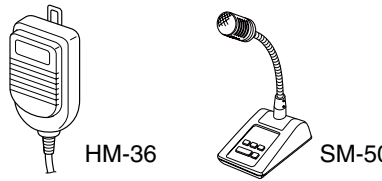

HM-36 SM-50

Rear panel

ANTENNA 1, 2 (p. 16)
 [Example]: ANT1 for 1.8–18 MHz bands
 ANT 2 for 21–28 MHz bands

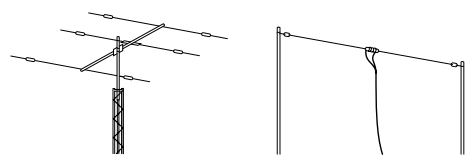

DC POWER SUPPLY (p. 20)

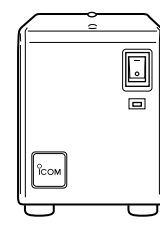

PS-126

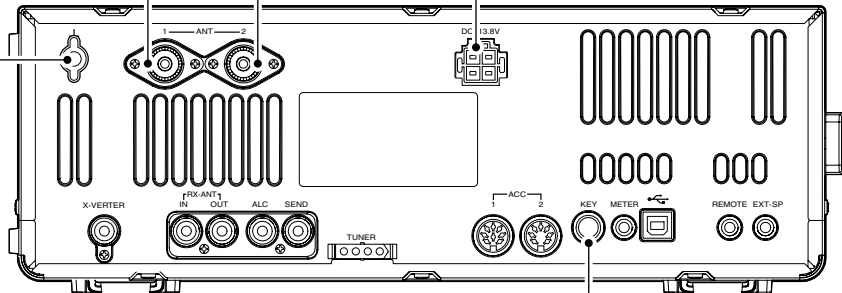

GROUND (p. 16)

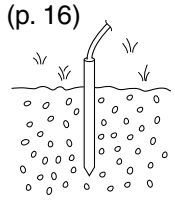

Use the heaviest gauge wire or strap available and make the connection as short as possible.

Grounding prevents electrical shocks, TVI and other problems.

STRAIGHT KEY

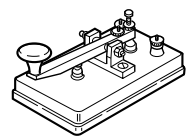

Advanced connections

Front panel

USB-MEMORY

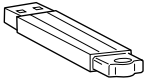

HEADPHONES

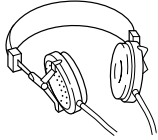

KEYBOARD

Connects a USB type PC keyboard directly for RTTY/PSK operation, as well as other text edit operations.



MIC

The AFSK modulation signal can also be input to [MIC].

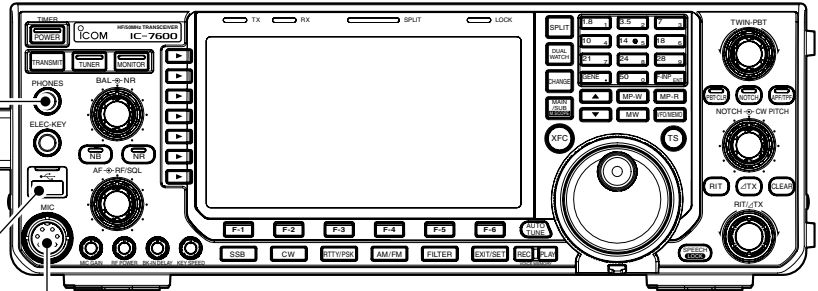

EXTERNAL KEYPAD

Connects an external keypad for direct voice memory, keyer memory, RTTY TX memory and PSK TX memory controls.

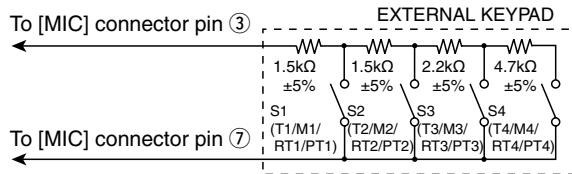

Rear panel— 1

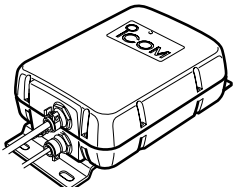

AH-4 (p. 20)

with

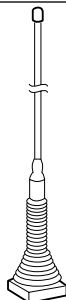

AH-2b
or long wire

[REMOTE] (p. 151)

Used for computer control and transceive operation.

The optional CT-17 is required when connecting a PC to [REMOTE].

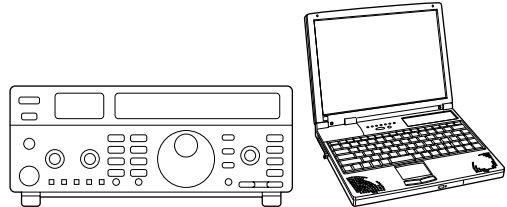

ANTENNA 1, 2 (p. 112)

Connects a linear amplifier, antenna selector, etc.

[X-VERTER]

Connects a transverter for V/UHF band use.

RX ANT IN/OUT

Connects an external preamp or lowpass filter.

The antenna connector must be selected as "ANT 1/R" or "ANT 2/R." (p. 3)

ACC SOCKETS 1, 2

(pgs. 22, 24)

[ALC], [SEND] (p. 21)
Used for connecting a non-Icom linear amplifier.

EXTERNAL SPEAKER

(p. 161)

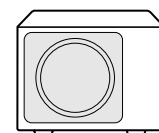

SP-23
(option)

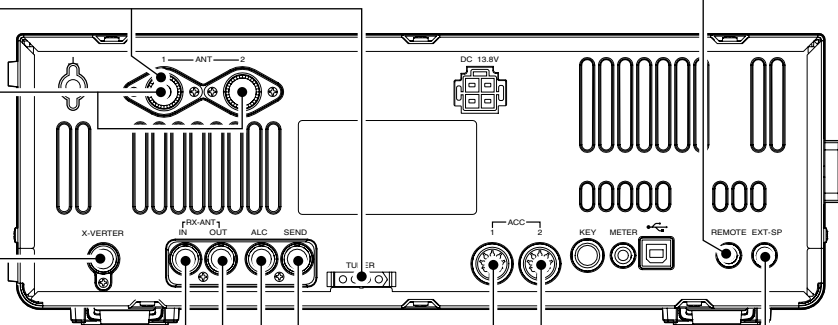

◇ Rear panel— 2

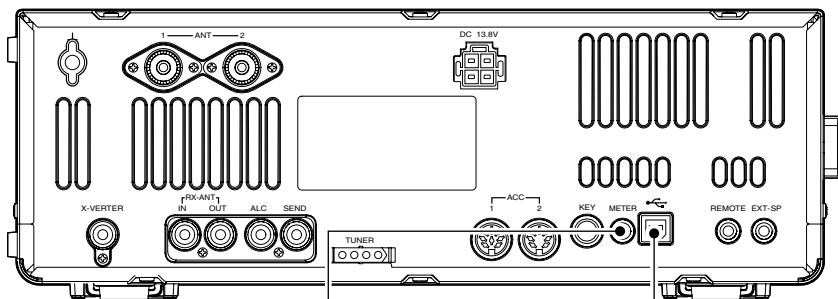

[METER]

Connects an external meter, etc.

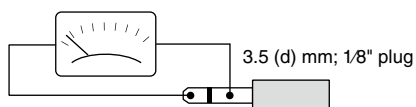

Output impedance : 4.7 kΩ
Output voltage (open circuit) : 2.5 V (default)
Output voltage can be adjusted 0 to 5 V
in ACC set mode. (p. 125)

[USB] (B)

When the transceiver is connected to a PC, a USB cable (third party) should be connected to the USB connector (B type) on the rear panel. (p. 11)

■ USB connection

Connect the USB-Memory* to the USB connector (A type) on the front panel.

- Unmount operation is recommended before removing the USB-Memory* (p.142).

Be sure to connect the USB-Memory correctly. **NEVER** connect or remove the USB-Memory when the read/write indicator lights or blinks.

A USB keyboard* or a USB hub* can also be connected to the USB connector.

* USB-Memory, USB keyboard and USB hub are not supplied by Icom.

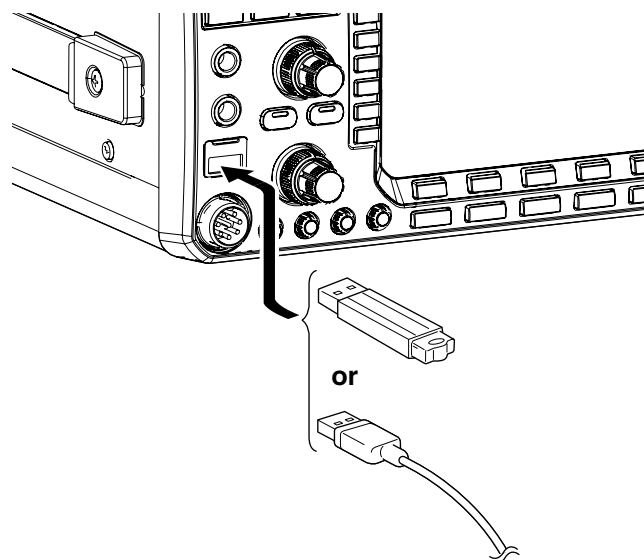

■ Power supply connections

Use a DC power supply with a 23 A capacity when operating the transceiver with AC power. Refer to the diagrams below.

CAUTION: Before connecting the DC power cable, check the following important items. Make sure:

- The **[POWER]** switch is OFF.
- Output voltage of the power source is 12–15 V when you use a non-Icom power supply.
- DC power cable polarity is correct.
Red : Positive ⊕ terminal
Black : Negative ⊖ terminal

CONNECTING PS-126 DC POWER SUPPLY

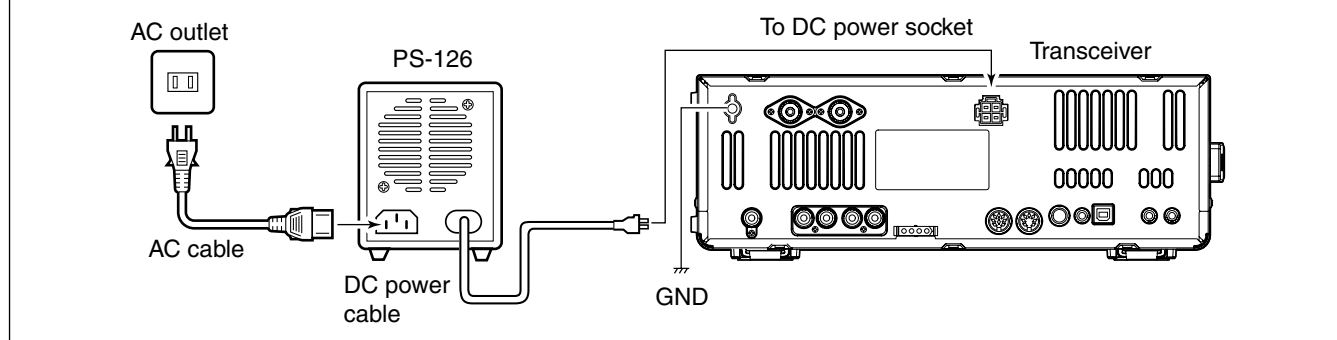

CONNECTING A DC POWER SUPPLY

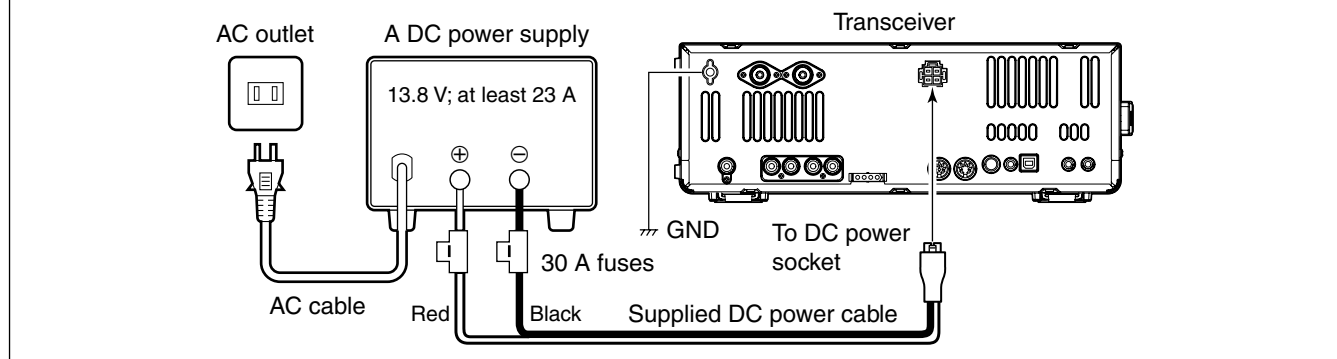

■ External antenna tuner connection

CONNECTING THE AH-4

⚡ The AH-4 must be connected to **[ANT1]**.

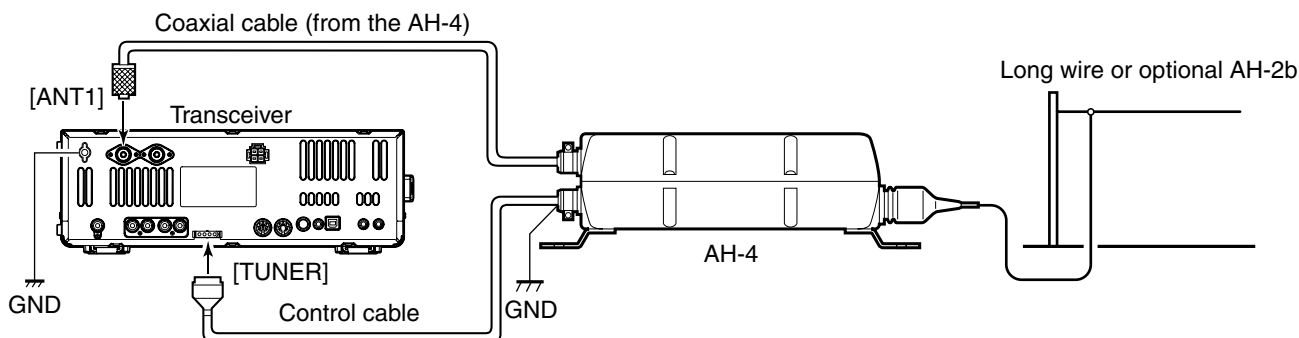

Linear amplifier connections

Connecting the IC-PW1/EURO

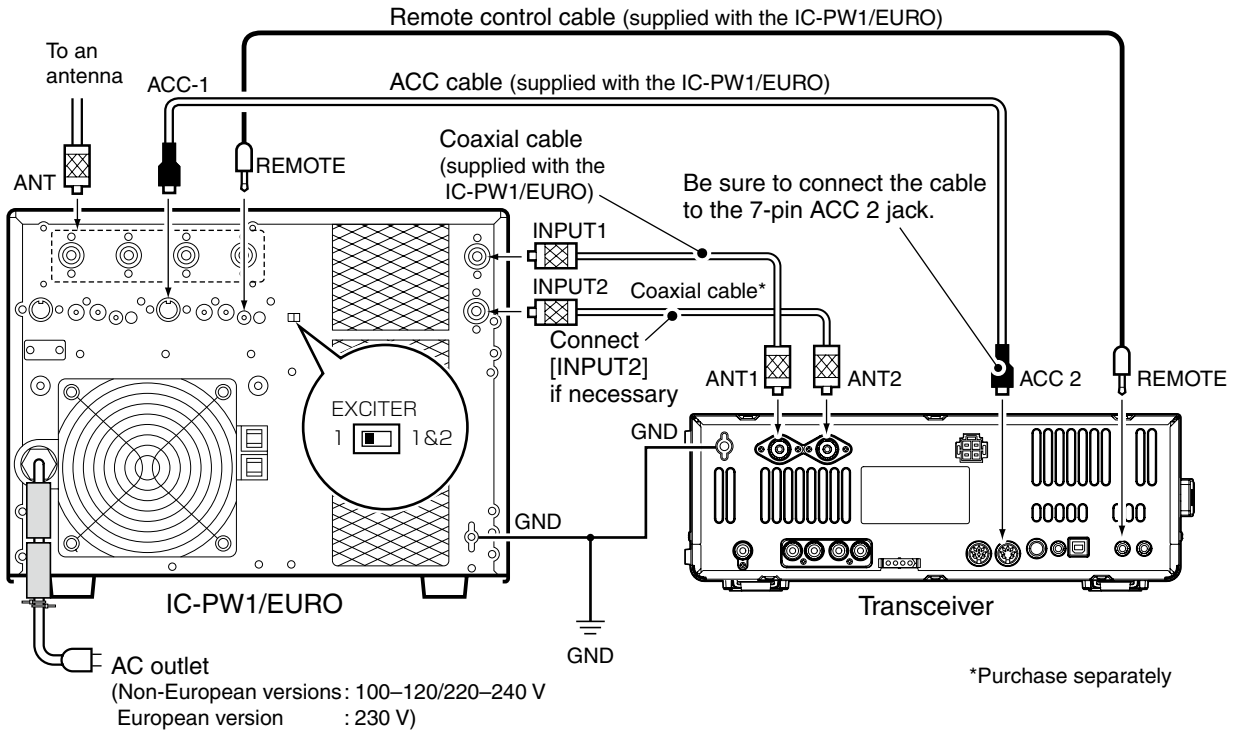

Connecting a non-Icom linear amplifier

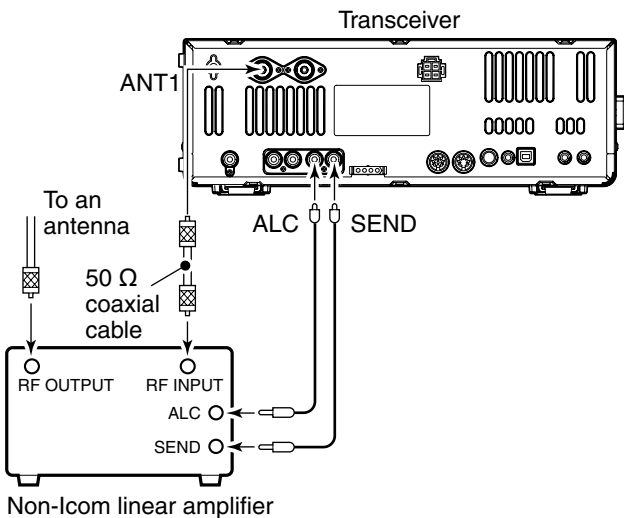

⚠ WARNING:

Set the transceiver output power and linear amplifier ALC output level after referring to the linear amplifier instruction manual.

The ALC input level must be in the range 0 V to –4 V. The transceiver does not accept positive voltage. Non-matched ALC and RF power settings could overheat or damage the linear amplifier.

The maximum signal level of [SEND] jack is 16 V/0.5 A DC with initial setting, and 250 V/200 mA with “MOSFET” setting (see p. 125 for details). Use an external relay unit if your non-Icom linear amplifier requires control voltage and/or current greater than specified.

■ Transverter jack information

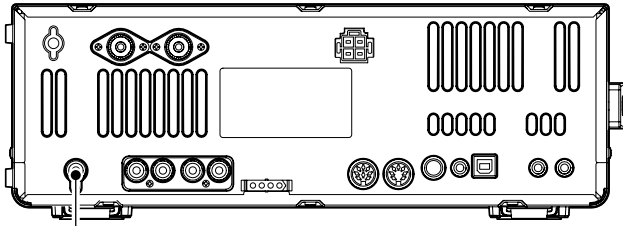

Transverter connector

When 2 to 13.8 V is applied to pin 6 of [ACC 2], the [X-VERTER] connector is activated for transverter operation and the antenna connectors do not receive or transmit any signals.

While receiving, the [X-VERTER] connector can be activated as an input terminal from an external transverter.

While transmitting, the [X-VERTER] connector outputs signals of the displayed frequency at -20 dBm (22 mV) as signals for the external transverter.

■ FSK and AFSK (SSTV) connections

To connect a TNC or scan converter, etc., refer to the diagram below.

◇ FSK operation— when connecting to [ACC 1]

• When using a PC application

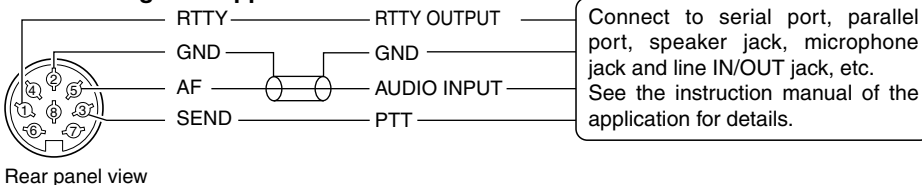

Rear panel view

• When using a TNC

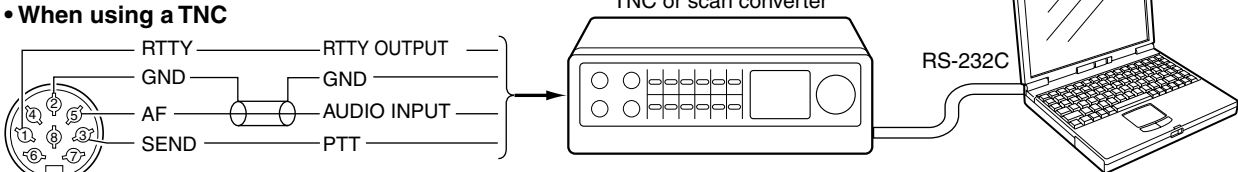

Rear panel view

◇ AFSK operation

• When connecting to [ACC 1]

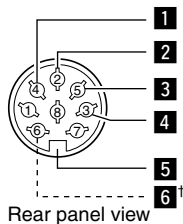

Rear panel view

• When using a PC application

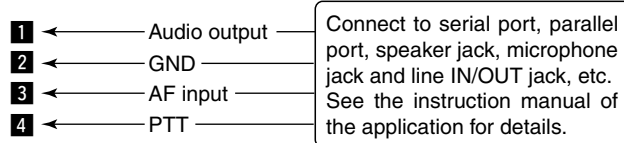

PC

• When connecting to [MIC]

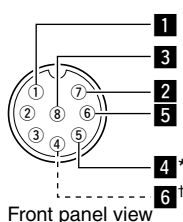

Front panel view

• When using a TNC

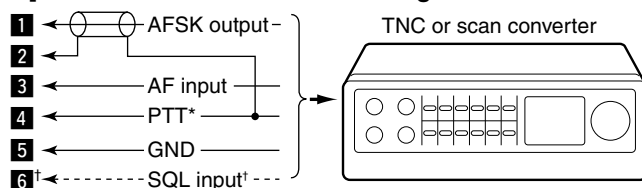

RS-232C

*When using the VOX function, no need to connect. Refer to the instruction manual of the external equipment (TNC, etc.).

†When connecting the squelch line, consult the necessary manual (TNC, etc.).

◇ When connecting to the [USB] connector

Connect a USB cable (third party's) between the transceiver's USB connector [USB] (B) on the rear panel and the PC. (p. 19)

• Icom HP (<http://www.icom.co.jp/world/support/index.html>) gives the USB driver and the installation guide download service.

Microphone connector information

(Front panel view)

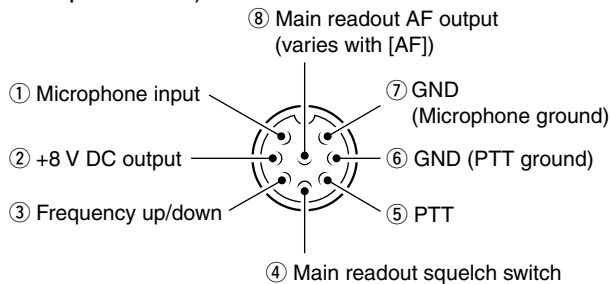

[MIC] Pin No.	FUNCTION	DESCRIPTION
②	+8 V DC output	Max. 10 mA
③	Frequency up	Ground
	Frequency down	Ground through 470 Ω
④	Squelch open	"Low" level
	Squelch closed	"High" level

CAUTION: DO NOT short pin 2 to ground as this can damage the internal 8 V regulator. DC voltage is applied to pin 1 for microphone operation. Use caution when using a non-Icom microphone.

Microphones

◇ HM-36

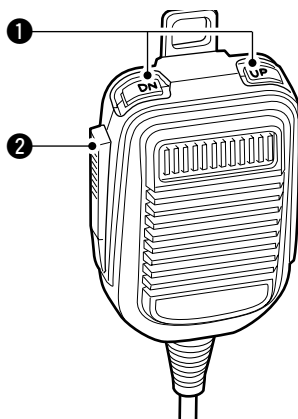

① UP/DOWN SWITCHES [UP]/[DN]

Change the selected readout frequency or memory channel.

- Pressing a switch continuously changes the frequency or memory channel number continuously.
- While pushing [XFC], the transmit readout frequency can be controlled while in split frequency operation.
- The [UP]/[DN] switch can simulate a key paddle. Preset in the keyer set mode. (p. 45)

② PTT SWITCH

Push and hold to transmit; release to receive.

③ PTT LOCK SWITCH (available for SM-50 only)

Push to toggle between transmit and receive.

④ LOW CUT SWITCH (available for SM-50 only)

Push to cut out the low frequency components of input voice signals.

◇ SM-50 (Option)

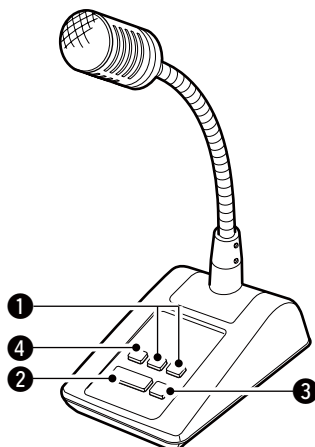

Downloaded by
RadioAmateur.EU

■ Accessory connector information

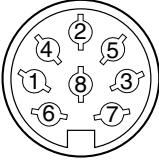
ACC 1	PIN No.	NAME	DESCRIPTION	SPECIFICATIONS
	1	RTTY	Controls RTTY keying	"High" level : More than 2.4 V "Low" level : Less than 0.6 V Output current : Less than 2 mA
	2	GND	Connects to ground.	Connected in parallel with ACC 2 pin 2.
	3	SEND	Input/output pin. Goes to ground when transmitting. When grounded, transmits.	Ground level : -0.5 V to 0.8 V Output current : Less than 20 mA Input current (Tx) : Less than 200 mA Connected in parallel with ACC 2 pin 3.
	4	MOD	Modulator input. Connects to a modulator	Input impedance : 10 kΩ Input level : Approx. 100 mV rms
	5	AF	AF detector output. Fixed, regardless of [AF] position in default settings. (see notes below)	Output impedance : 4.7 kΩ Output level : 100–300 mV rms
	6	SQLS	Squelch output. Goes to ground when squelch opens.	SQL open : Less than 0.3 V/5 mA SQL closed : More than 6.0 V/100 μA
	7	13.8 V	13.8 V output when power is ON.	Output current : Max. 1 A Connected in parallel with ACC 2 pin 7.
	8	ALC	ALC voltage input.	Control voltage : -4 V to 0 V Input impedance : More than 10 kΩ Connected in parallel with ACC 2 pin 5.

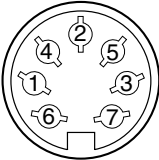
ACC 2	PIN No.	NAME	DESCRIPTION	SPECIFICATIONS
	1	8 V	Regulated 8 V output.	Output voltage : 8.0 V ±0.3 V Output current : Less than 10 mA
	2	GND	Same as ACC 1 pin 2.	
	3	SEND	Same as ACC 1 pin 3.	
	4	BAND	Band voltage output. (Varies with amateur band)	Output voltage : 0 to 8.0 V
	5	ALC	Same as ACC 1 pin 8.	
	6	TRV	Activates [X-VERTER] input/output when "HIGH" voltage is applied.	Input impedance : More than 10 kΩ Input voltage : 2 to 13.8 V
	7	13.8 V	Same as ACC 1 pin 7.	

NOTE: If the CW sidetone level limit or beep level limit is in use, the CW sidetone or beep tone decreases from the fixed level when the [AF] control is rotated above a specified level. (p. 123)

■ Before first applying power

Before first applying power, make sure all connections required for your system are complete by referring to Chapter 2.

After all connections have been done, set controls and switches as shown in the figure below.

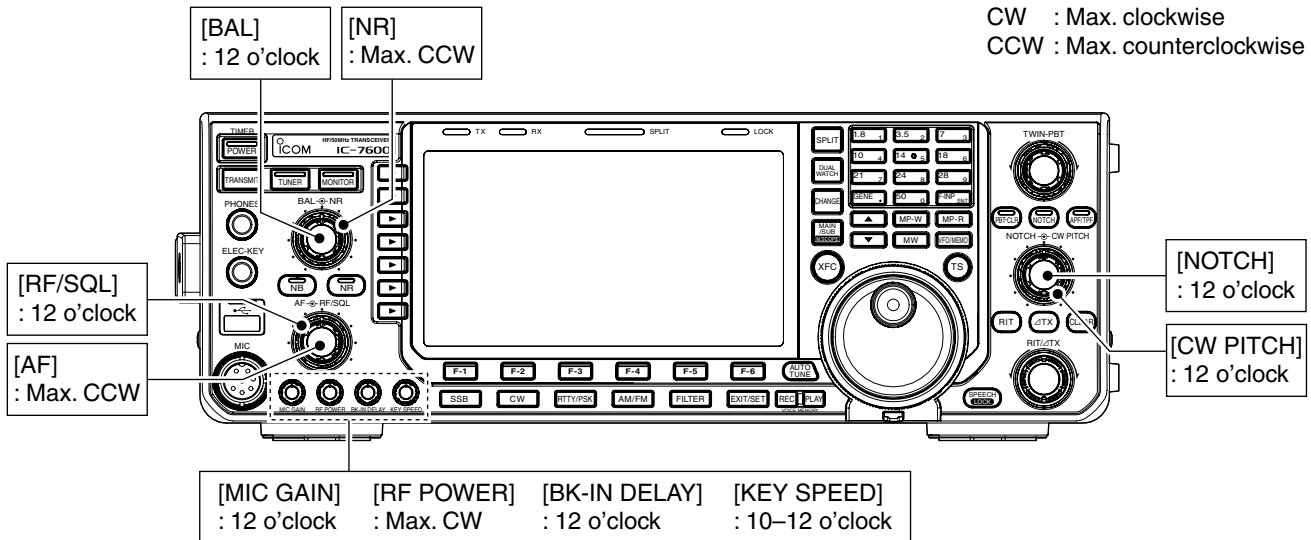

■ Applying power (CPU resetting)

First applying power:

Reset the transceiver using the following procedure.

Resetting **CLEARs** all programmed contents in memory channels and returns programmed values in set mode to default values.

- ① Make sure the transceiver power is OFF.
- ② While pushing and holding [F-INP ENT] and [MW], push [POWER] to turn power ON.
 - The CPU is reset.
 - The CPU start-up takes approx. 5 sec.
 - The transceiver displays its initial VFO frequencies when resetting is complete.
- ③ Change the set mode settings after resetting, if desired.

Normal applying power:

Push [POWER] to turn power ON, then check the display. When any of indicators appear, turn them OFF if necessary. (See the appropriate page for details.)

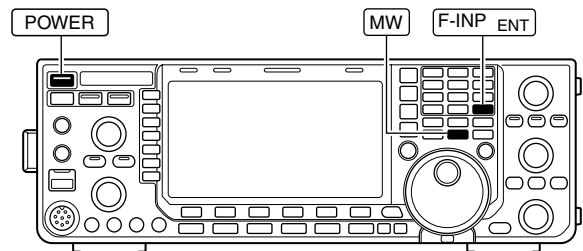

■ Selecting VFO/memory mode

- ➔ Push **[VFO/MEMO]** to switch between VFO and memory modes.
 - “VFO” appears when in VFO mode, or the selected memory channel number appears when in memory mode.
 - Pushing and holding **[VFO/MEMO]** for 1 sec. transfers the contents of the selected memory channel to VFO mode. (p. 102)

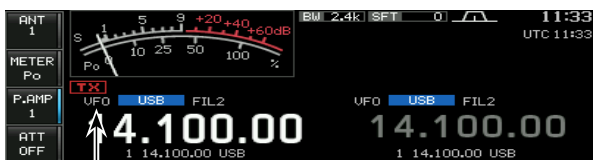

“VFO” indicator

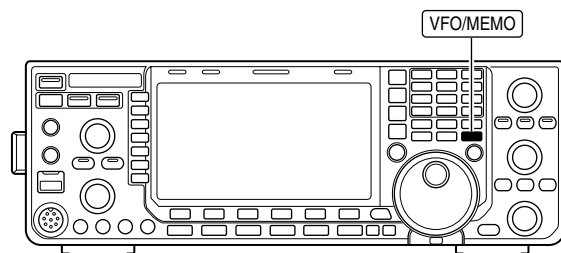

Memory channel number

3

■ Main/Sub band selection

The IC-7600 has the main and sub band. The main band is displayed on the left hand side, and the sub band is displayed on the right hand side of the LCD. Some functions can only be applied to the selected band and transmission occurs on the main band (except during split frequency operation).

- ➔ Push **[MAIN/SUB M.SCOPE]** to select access to the main or sub band readout.
 - The selected readout frequency is displayed clearly. The sub readout functions only during split operation or dualwatch.

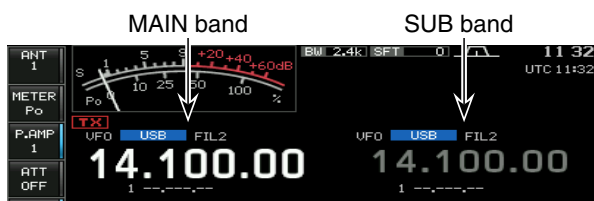

Access to MAIN band



Access to SUB band

◇ Main/Sub band switching

- ➔ Push **[CHANGE]** to switch the frequency and selected memory channel between main and sub readouts.
 - Switches between transmit frequency and receive frequency when the split frequency function is ON. (p. 88)

◇ Main/Sub band equalization

- ➔ Push and hold **[CHANGE]** for 1 sec. to equalizes the sub band readout to the main band readout.

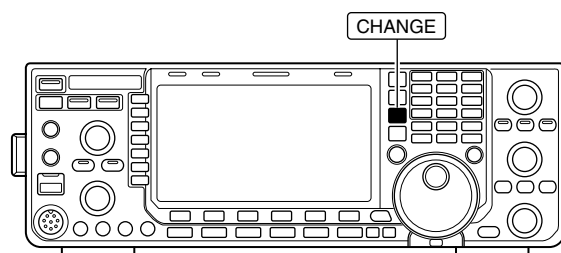

■ Selecting an operating band

The triple band stacking register provides 3 memories for each band key, storing frequency and mode information.

This function is convenient when you operate 3 operating modes on one band. For example, one register is used for a CW frequency, another for a SSB frequency and the other one for a RTTY frequency.

If a band key is pushed once, the frequency and operating mode last used are called up. When the key is pushed again, another stored frequency and operating mode are called up.

See the table below for a list of the bands available and the default settings for each band.

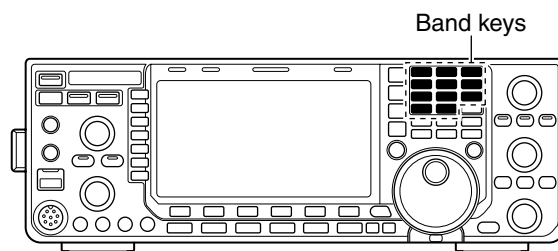

BAND	REGISTER 1	REGISTER 2	REGISTER 3
1.8 MHz	1.900000 MHz CW	1.910000 MHz CW	1.915000 MHz CW
3.5 MHz	3.550000 MHz LSB	3.560000 MHz LSB	3.580000 MHz LSB
7 MHz	7.050000 MHz LSB	7.060000 MHz LSB	7.020000 MHz CW
10 MHz	10.120000 MHz CW	10.130000 MHz CW	10.140000 MHz CW
14 MHz	14.100000 MHz USB	14.200000 MHz USB	14.050000 MHz CW
18 MHz	18.100000 MHz USB	18.130000 MHz USB	18.150000 MHz USB
21 MHz	21.200000 MHz USB	21.300000 MHz USB	21.050000 MHz CW
24 MHz	24.950000 MHz USB	24.980000 MHz USB	24.900000 MHz CW
28 MHz	28.500000 MHz USB	29.500000 MHz USB	28.100000 MHz CW
50 MHz	50.100000 MHz USB	50.200000 MHz USB	51.000000 MHz FM
General	15.000000 MHz USB	15.100000 MHz USB	15.200000 MHz USB

◇ Using the band stacking registers

[Example]: 14 MHz band

- ① Push **[14 5]**, then select a frequency and an operating mode.
 - The previously selected frequency and an operating mode are memorized in first band stacking register of that band.
- ② Push **[14 5]** again, then select another frequency and operating mode.
 - The frequency and operating mode that is selected in step ① are memorized in 14 MHz first band stacking register.
- ③ Push **[14 5]** again, then select another frequency and operating mode.
 - The frequency and operating mode that is selected in step ② are memorized in 14 MHz second band stacking register.
- ④ Push **[14 5]** again, then select another frequency and operating mode.
 - The frequency and operating mode that is selected in step ③ are memorized in 14 MHz third band stacking register.
 - When **[14 5]** is pushed again, the first band stacking register set in step ②, is over written.

1.8 1	3.5 2	7 3
10 4	14 5	18 6
21 7	24 8	28 9
GENE .	50 0	F-INP ENT

■ Frequency setting

The transceiver has several tuning methods for convenient frequency tuning.

◇ Tuning with the main dial

- ① Push the desired band key on the keypad 1–3 times.
 - 3 different frequencies can be selected on each band with the band key. (See previous page “Using the band stacking registers.”)
- ② Rotate the main dial to set the desired frequency.

▨ If the dial lock function is activated, the lock indicator lights, and the main dial does not function. In this case, push and hold **[SPEECH/LOCK]** for 1 sec. to deactivate the lock function. (p. 82)
 When “LOCK/SPEECH” is selected in “[SPEECH/LOCK] Switch” item in others set mode, pushing **[SPEECH/LOCK]** deactivates the lock function. (see p. 131 for details)

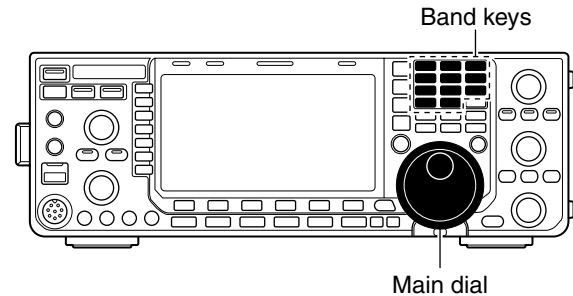

◇ Direct frequency entry with the keypad

The transceiver has a keypad for direct frequency entry as described below.

- ① Push **[F-INP ENT]**.
 - “**F-INP**” indicator appears.
- ② Input the desired frequency.
 - Push **[GENE •]** to input “. (decimal point)” between the MHz units and kHz units.
- ③ Push **[F-INP ENT]** to set the input frequency.
 - To cancel the input, push **[EXIT/SET]**.

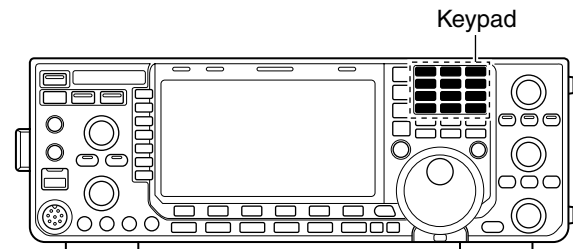

[EXAMPLE]

14.025 MHz

[F-INP ENT] **[1.8 1]** **[10 4]** **[GENE •]** **[50 0]** **[3.5 2]** **[14 5]** **[F-INP ENT]**

18.0725 MHz

[F-INP ENT] **[1.8 1]** **[24 8]** **[GENE •]** **[50 0]** **[21 7]** **[3.5 2]** **[14 5]** **[F-INP ENT]**

706 kHz

[F-INP ENT] **[50 0]** **[GENE •]** **[21 7]** **[50 0]** **[18 6]** **[F-INP ENT]**

5.100 MHz

[F-INP ENT] **[14 5]** **[GENE •]** **[1.8 1]** **[F-INP ENT]**

7.000 MHz

[F-INP ENT] **[21 7]** **[F-INP ENT]**

21.280 MHz ↔ 21.245 MHz

[F-INP ENT] **[GENE •]** **[3.5 2]** **[10 4]** **[14 5]** **[F-INP ENT]**

◇ **About 5 MHz band operation (USA version only)**

Operation on the 5 MHz band is allowed on 5 discrete frequencies and must adhere to the following:

- USB mode
- Maximum of 50 watts ERP (Effective Radiated Power)
- 2.8 kHz bandwidth

It's your responsibility to set all controls so that transmission in this band meets the stringent conditions under which amateur operations may use these frequencies.

▨ **NOTE:** We recommend that you store these frequencies, mode and filter settings into memory channels for easy recall.

▨ *The FCC specifies center frequencies on the 5 MHz band. However, the IC-7600 displays carrier frequency. Therefore, tune the transceiver to 1.5 kHz below the specified FCC channel center frequency.

IC-7600 Displayed Frequency*	FCC Channel Center Frequency*
5.33050 MHz	5.33200 MHz
5.34650 MHz	5.34800 MHz
5.36650 MHz	5.36800 MHz
5.37150 MHz	5.37300 MHz
5.40350 MHz	5.40500 MHz

To assist you in operating the 5 MHz band within the rules specified by the FCC, transmission is illegal on any 5 MHz band frequency other than the five frequencies indicated in the table above.

◇ **Quick tuning step**

The operating frequency can be changed in larger steps (0.1, 1, 5, 9, 10, 12.5, 20 or 25 kHz selectable) for quick tuning.

- 1 Push **[TS]** to turn the quick tuning function ON.
 - “▼” appears when the quick tuning function is ON.
- 2 Rotate the main dial to change the frequency in programmed kHz steps.
- 3 Push **[TS]** again to turn the quick tuning function OFF.
 - “▼” disappears.
- 4 Rotate the main dial for normal tuning if desired.

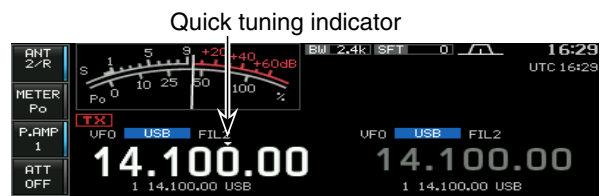
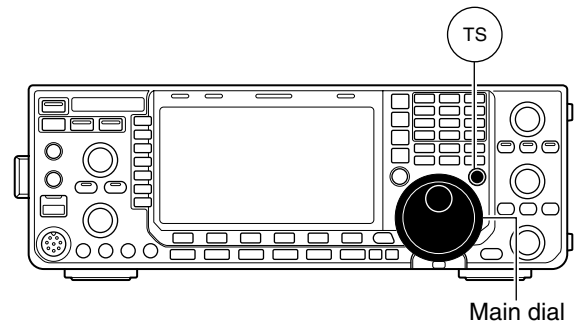

◇ **Selecting “kHz” step**

- 1 Push **[TS]** to turn the quick tuning function ON.
 - “▼” appears when the quick tuning function is ON.
- 2 Push and hold **[TS]** for 1 sec. to enter quick tuning step set mode.
 - Selected tuning steps for all modes appear.
- 3 Select the desired operating mode.
- 4 Rotate the main dial to select the desired tuning step.
 - Push and hold **[DEF] (F-4)** for 1 sec. to return to the default setting, if desired.
- 5 Repeat steps 3 and 4 to select quick tuning steps for other modes, if desired.
- 6 Push **[EXIT/SET]** to exit the setting display.

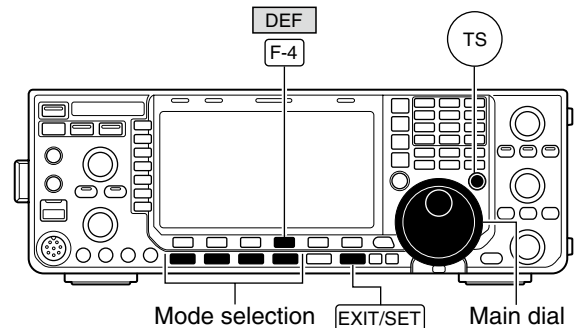

▨ **NOTE:** When entering quick tuning step set mode, the quick tuning function must be activated first.

◇ Selecting 1 Hz step

A minimum tuning step of 1 Hz can be used for fine tuning.

- ① Push **[TS]** to turn the quick tuning function OFF.
- ② Push and hold **[TS]** for 1 sec. to turn the 1 Hz tuning step ON and OFF.

NOTE:

- RIT and/or Δ TX also functions in 1 Hz tuning step when used.
- The frequency is changed in 50 Hz step when the **[UP]/[DN]** switches of the microphone are used for the frequency setting (when the programmable tuning step is not selected.)

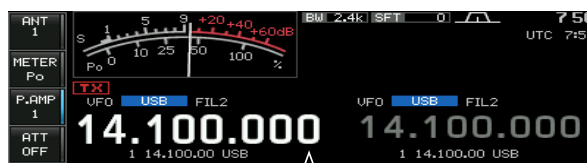
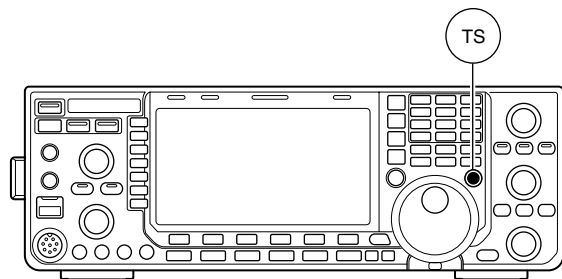

1 Hz step indicator

◇ Auto tuning step function

When rotating the main dial rapidly, the tuning speed accelerates automatically as selected.

- ① Push **[EXIT/SET]** several times to close a multi-function screen, if necessary.
- ② Push **[SET] (F-6)** to select set mode menu screen.
 - Pushing and holding **[EXIT/SET]** for 1 sec. also selects set mode menu screen.
- ③ Push **[OTHERS] (F-5)** to enter others set mode.
- ④ Push **[▲] (F-1)** or **[▼] (F-2)** to select "MAIN DIAL Auto TS."
- ⑤ Rotate the main dial to select the desired condition from HIGH, LOW and OFF.
 - HIGH : Approx. 5 times faster when the tuning step is set to 1 kHz or smaller steps; approx. 2 times faster when the tuning step is set to 5 kHz or larger steps.
 - LOW : Approx. 2 times faster
 - OFF : Auto tuning step is turned OFF.
- ⑥ Push **[EXIT/SET]** to exit the set mode.

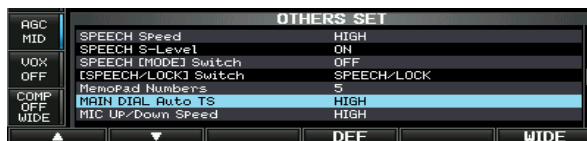
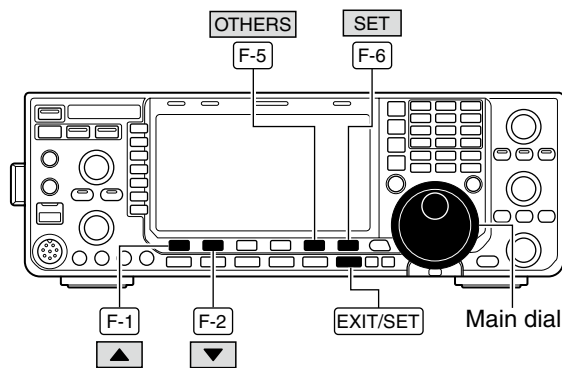

HIGH (default)

◇ 1/4 tuning step function

When operating in SSB data, CW, RTTY or PSK, the 1/4 tuning function is available. Dial rotation is reduced to 1/4 of normal speed when the 1/4 tuning function is ON for finer tuning control.

- ➔ Push **[1/4] (MF7)** to toggle the 1/4 tuning function ON and OFF.
 - "**1/4**" appears when the 1/4 tuning function is ON.

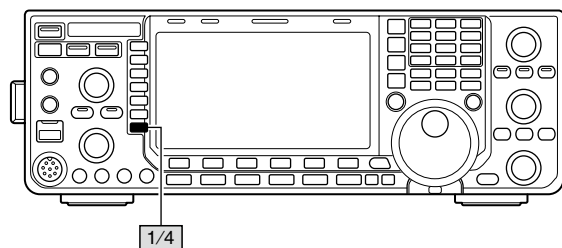

1/4 tuning step OFF

1/4 tuning step ON

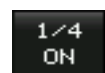
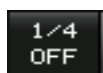

◆ **Band edge warning beep**

When you tune inside or outside of an amateur band’s frequency range, a warning beep sounds. (“TX” may be indicated on outside of an amateur band’s frequency.) (p. 14)

This function can be turned OFF in set mode, if desired.

- ① Push [EXIT/SET] several times to close a multi-function screen, if necessary.
- ② Push [SET] (F-6) to select set mode menu screen.
 - Pushing and holding [EXIT/SET] for 1 sec. also selects set mode menu screen.
- ③ Push [OTHERS] (F-5) to enter others set mode.
- ④ Push [▲] (F-1) or [▼] (F-2) to select “Beep (Band Edge).”
- ⑤ Rotate the main dial to select the band edge warning beep function.
- ⑥ Push [EXIT/SET] to exit the set mode.

▨ The beep output level can be set in level set mode. (p. 123)

When the band edge warning beep is set to “ON”:

The band edge warning beep sounds (enter: Pi, exit: Bu) according to the set mode setting as follows.

- **ON (Default)**
Band edge beep sounds when an operating frequency enters or exits the default amateur band. (default)
- **ON (User)**
A beep sounds when an operating frequency enters or exits an amateur band that is set in band edge screen.
- **ON (User) & TX Limit**
Same as the setting of “ON (User).” However, the transmission can be made in the set frequency range only.

To programming the band edge:

When “ON (User)” or “ON (User) & TX Limit” is selected, [BAND] appears in the display above the function switch (F-5), and up to 30 band edge frequencies can be set in band edge screen.

- ① Perform the steps ① to ⑤ as above, then select “ON (User)” or “ON (User) & TX Limit.”
- ② Push [BAND] (F-5) to enter the band edge screen.
- ③ Push [▲] (F-1) or [▼] (F-2) to select the desired band edge.
 - Push [◀ ▶] (F-3) to select the set content for band edge, lower or upper.
 - Push [INS] (MF6) to insert a new blank band edge line.
 - Push and hold [DEL] (MF7) for 1 sec. to delete the selected band edge line.
 - Push and hold [DEF] (F-4) for 1 sec. to display the band edge initialize screen. Then, push and hold [OK] (F-5) to initialize all band edge frequency settings.
- ④ Input the desired frequency with the keypad.
 - Push [GENE •] to input “. (decimal point)” between the MHz units and kHz units.
 - Program the frequency in ascending order.
 - The frequency that is duplicated or out of an amateur band cannot be programmed.
- ⑤ Push [EXIT/SET] to exit the set mode.

When the transverter function is in use, the band edge warning beep sounds with the default setting.

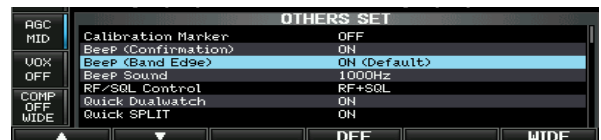
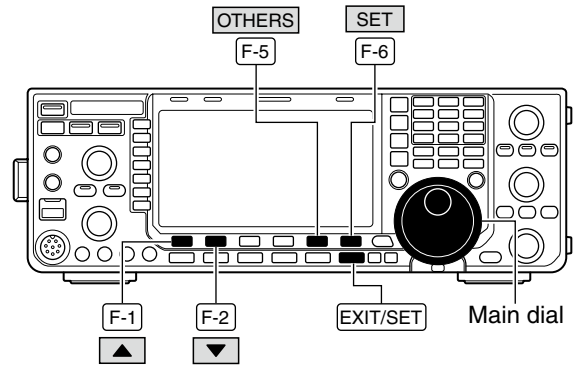

ON (Default) (default)



ON (User)

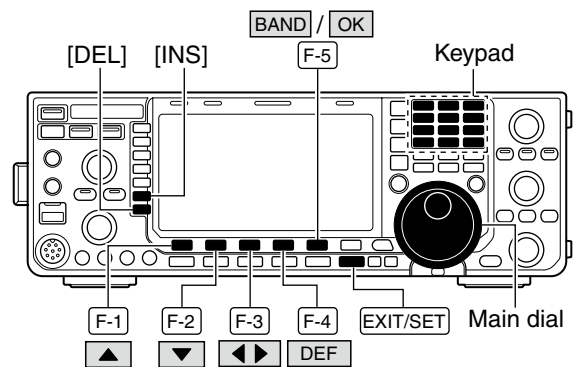

• **Band edge screen**



▨ **NOTE:** All frequency ranges are set in default. So you should delete or change it to add the desired band edge frequency.

■ Operating mode selection

SSB (USB/LSB), SSB data (USB data/LSB data), CW, CW reverse (CW-R), RTTY, RTTY reverse (RTTY-R), PSK, PSK reverse (PSK-R), AM, AM data, FM and FM data modes are available in the IC-7600. Push the desired mode switch to select a mode of operation.

See the diagram as at right for the order of selection.

Microphone signals are muted when data mode is selected depending on the set mode settings (p. 124).

• Selecting SSB mode

- ➔ Push **[SSB]** to select USB or LSB.
 - USB is selected first when above 10 MHz; or LSB is selected first when below 10 MHz operation.
 - After USB or LSB is selected, push **[SSB]** to toggle between USB and LSB.
 - After USB or LSB is selected, push and hold **[SSB]** for 1 sec. to select USB or LSB data mode, respectively.
 - After USB or LSB data mode is selected, push and hold **[SSB]** for 1 sec. to select data 1, 2 and 3, in sequence.
 - In USB or LSB data mode, push **[SSB]** to return to USB or LSB mode, respectively.

• Selecting CW mode

- ➔ Push **[CW]** to select CW.
 - After CW is selected, push **[CW]** to toggle between CW and CW reverse mode.

• Selecting RTTY/PSK mode

- ➔ Push **[RTTY/PSK]** to select RTTY or PSK.
 - After RTTY or PSK is selected, push **[RTTY/PSK]** to toggle between RTTY and PSK.
 - After RTTY or PSK is selected, push and hold **[RTTY/PSK]** for 1 sec. to toggle between RTTY and RTTY reverse, or, PSK and PSK reverse mode, respectively.

• Selecting AM/FM mode

- ➔ Push **[AM/FM]** to select AM or FM.
 - After AM or FM is selected, push **[AM/FM]** to toggle between AM and FM.
 - After AM or FM is selected, push and hold **[AM/FM]** for 1 sec. to select AM or FM data mode, respectively.
 - After AM or FM data mode is selected, push and hold **[AM/FM]** for 1 sec. to select data 1, 2 and 3, in sequence.
 - In AM or FM data mode, push **[AM/FM]** to return to AM or FM mode, respectively.

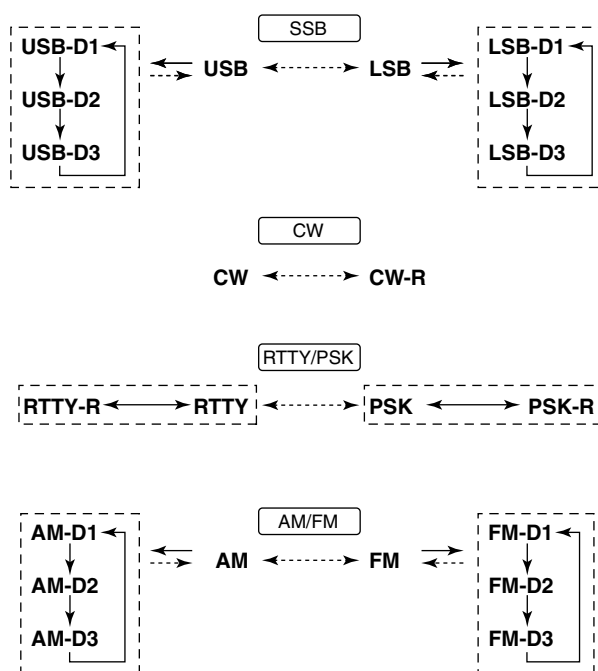
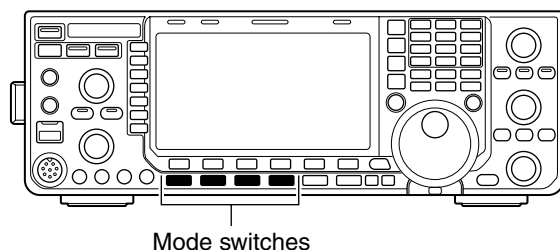

⤵ : Push mode switch momentary.
 ⤵⤵ : Push and hold mode switch for 1 sec.

■ Squelch and receive (RF) sensitivity

Adjusts the RF gain and squelch threshold level. The squelch removes noise output from the speaker (closed position) when no signal is received.

- The squelch is particularly effective for AM and FM. It is also available for other modes.
- 12 to 1 o'clock position is recommended for any setting of the **[RF/SQL]** control.
- The control can be set as 'Auto' (RF gain control in SSB, CW, RTTY and PSK; squelch control in AM and FM) or squelch control (RF gain is fixed at maximum) in others set mode as follows. (p. 128)

SET MODE	OPERATION
RF+SQL (default)	Can be used in all modes. Functions as noise squelch or S-meter squelch in FM modes; S-meter squelch only in other modes.
SQL	Operates as a squelch control. <ul style="list-style-type: none"> • RF gain is fixed at maximum sensitivity.
AUTO	Operates as an RF gain control in SSB, CW, RTTY and PSK modes. <ul style="list-style-type: none"> • Squelch is fixed open. Operates as a squelch control in AM and FM modes. <ul style="list-style-type: none"> • RF gain is fixed at maximum sensitivity.

○ Adjusting RF gain (Receive sensitivity)

Normally, **[RF/SQL]** is set to the 11 o'clock position. Rotate **[RF/SQL]** to the 11 o'clock position for maximum sensitivity.

- Rotating counterclockwise from the maximum position reduces sensitivity.
- The S-meter indicates receive sensitivity.

○ Adjusting squelch (Removing non-signal noise)

Rotate **[RF/SQL]** clockwise when receiving no signal, until the noise just disappears.

- **[RX]** indicator light goes out.
- Rotating **[RF/SQL]** past the threshold point invokes the S-meter squelch— this allows you to set a minimum signal level needed to open the squelch.

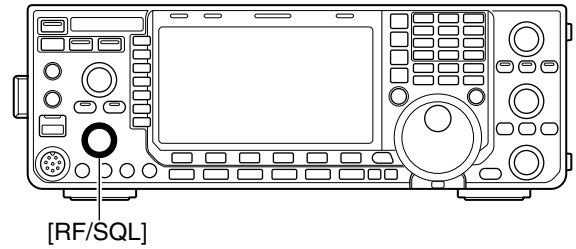

[RF/SQL]

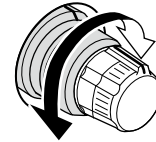

• When setting as RF gain/squelch control

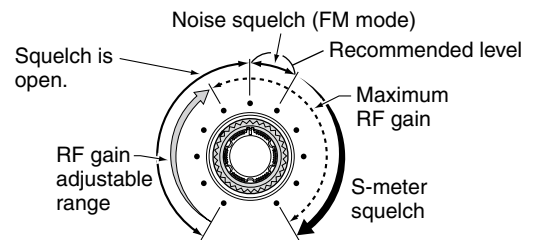

• When functioning as RF gain control (Squelch is fixed open; SSB, CW, RTTY, PSK only)

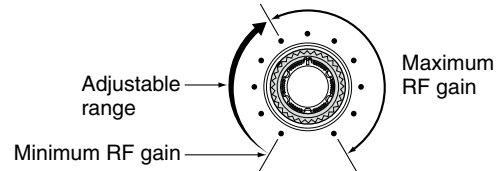

• When functioning as squelch control (RF gain is fixed at maximum.)

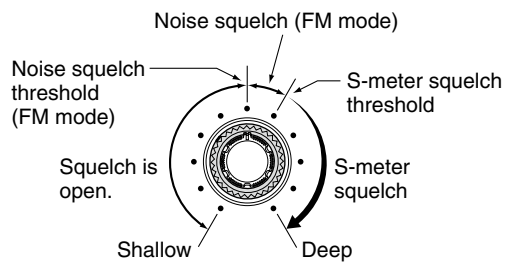

While rotating the RF gain control, noise may be heard. This comes from the DSP unit and does not indicate an equipment malfunction.

Volume setting

- ➔ Rotate **[AF]** control clockwise to increase, counter-clockwise to decrease the audio output level.

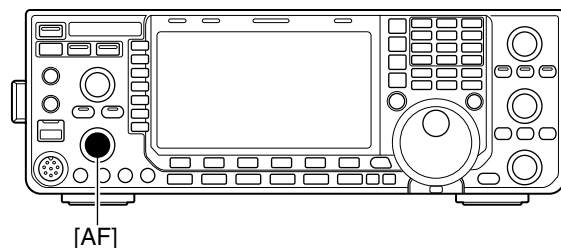
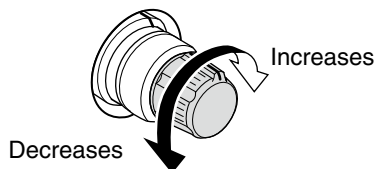

Meter indication selection

The transceiver has 6 transmit meter functions for your convenience.

- ➔ Push **[METER] (MF2)** several times to select the desired meter.

METER Po Indicates the RF output power in % (percent).

METER SWR Indicates the SWR on the transmission line.

METER ALC Indicates the ALC level. When the meter movement shows the input signal level exceeds the allowable level, the ALC limits the RF power. In such cases, reduce the **[MIC GAIN]** control.

METER COMP Indicates the compression level when the speech compressor is in use.

METER Id Indicates the drain current of the final amplifier MOSFETs.

METER Vd Indicates the drain terminal voltage of the final amplifier MOSFETs.

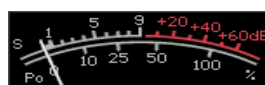
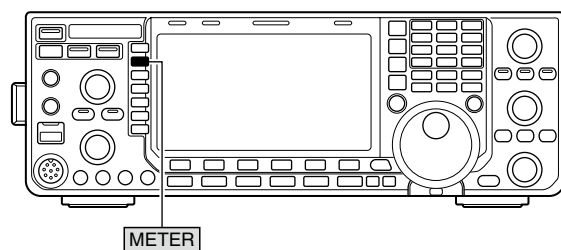

Power level readout

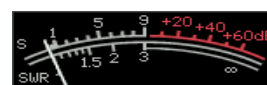

SWR readout

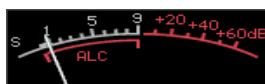

ALC level readout

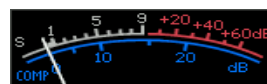

Compression level readout

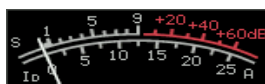

Id readout

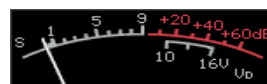

Vd readout

Multi-function digital meter

The IC-7600 can display the multi-function digital meter on the LCD display. This meter displays all transmit parameters simultaneously.

- ➊ Push and hold **[METER] (MF2)** for 1 sec. to turn the multi-function digital meter ON.
- ➋ Push **[P-HOLD] (F-1)** to toggle the peak level hold function ON.
 - **"P-HOLD"** appears on the window title when the peak level hold function is ON.
- ➌ Push and hold **[METER] (MF2)** for 1 sec., or push **[EXIT/SET]** to turn the multi-function digital meter OFF.

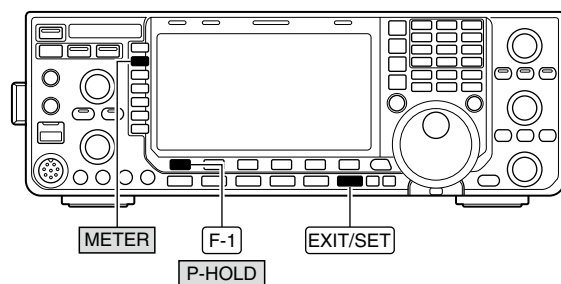

"P-HOLD" indicator

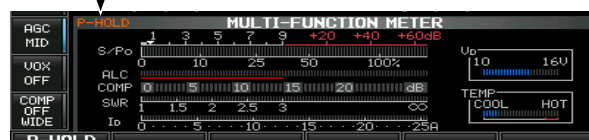

◆ Meter type selection

A total of 3 meter types are available in the IC-7600—Standard, Edgewise and Bar meters. Follow the instructions below for the meter type selection.

- ① Push **[EXIT/SET]** several times to return to normal screen, if necessary.
- ② Push **[SET] (F-6)**, then push **[DISP] (F-3)** to select display set mode.
- ③ Push **[▲] (F-1)** or **[▼] (F-2)** to select “Meter type (Normal Screen)” item.
- ④ Rotate the main dial to select the desired meter type from “Standard,” “Edgewise” and “Bar.”
- ⑤ Push **[EXIT/SET]** to exit display set mode.

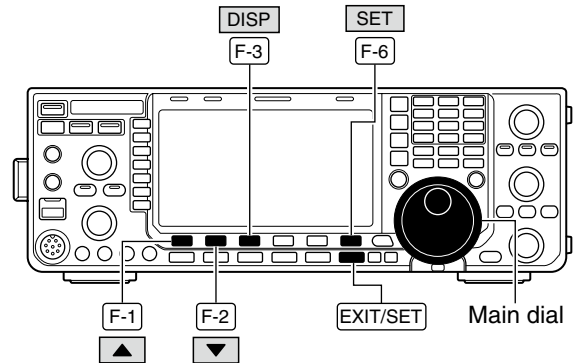

• Standard meter

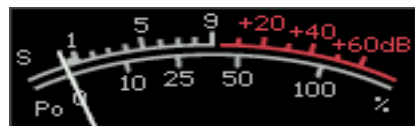

• Edgewise meter

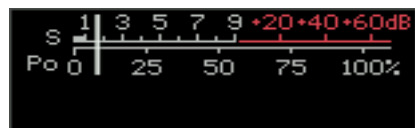

• Bar meter



■ Voice synthesizer operation

The IC-7600 has a built-in voice synthesizer to announce the operating frequency, mode* and S-meter* in clear, electronically-generated voice, in English (or Japanese).

Select the desired parameters to be announced, such as audio level, speed, language, contents, in the others set mode in advance. (p. 131)

- Push **[SPEECH/LOCK]** to announce the currently selected frequency, mode* and S-meter level*.
- Push a mode switch to announce the appropriate mode*.

* The S-meter level and operating mode announcements can be deactivated, respectively. (p.131)

NOTE: When “LOCK/SPEECH” is selected in [[SPEECH/LOCK] Switch] item in others set mode, pushing and holding **[SPEECH/LOCK]** activates the voice synthesizer. (p. 131)

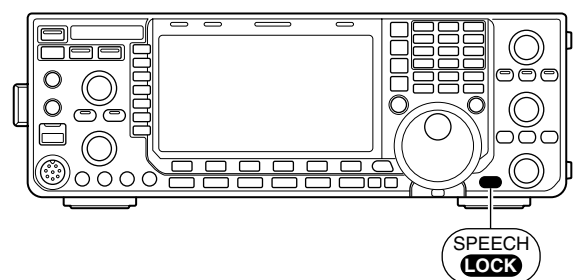

Basic transmit operation

Before transmitting, monitor your selected operating frequency to make sure transmitting won't cause interference to other stations on the same frequency. It's good amateur practice to listen first, and then, even if nothing is heard, ask "Is the frequency in use?" once or twice, before you begin operating on that frequency.

Transmitting

Before transmitting, monitor your selected operating frequency to make sure transmitting won't cause interference to other stations on the same frequency.

- ① Push **[TRANSMIT]** or **[PTT]** (microphone) to transmit.
 - The **[TX]** indicator lights red.
 - "**TX**" appears while transmitting.
- ② Push **[TRANSMIT]** again or release **[PTT]** (microphone) to return to receive.

Adjusting the transmit output power

- Rotate **[RF POWER]**.
 - Adjustable range : 2 W to 100 W
(AM mode: 1 W to 30 W)
- 

Push

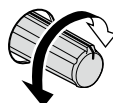

Increases
max. 100 W
(30 W for AM)

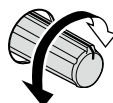

Decreases
min. 2 W
(1 W for AM)

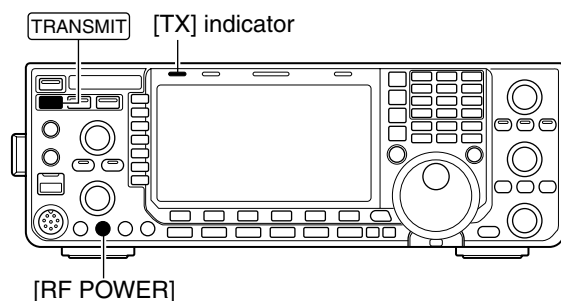

Microphone gain adjustment

Before transmitting, monitor your selected operating frequency to make sure transmitting won't cause interference to other stations on the same frequency.

- ① Push **[SSB]** to select SSB mode.
- ② Push **[METER]** (**MF2**) to select the ALC meter.
- ③ Push **[PTT]** (microphone) to transmit.
 - Talk into the microphone at your normal voice level.
- ④ While talking into the microphone, rotate **[MIC GAIN]** so that the ALC meter reading doesn't go outside the ALC zone. (see at right)

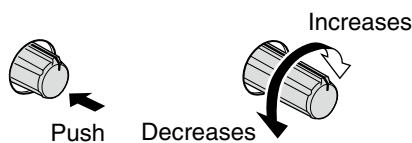

- ⑤ Release **[PTT]** (microphone) to return to receive.

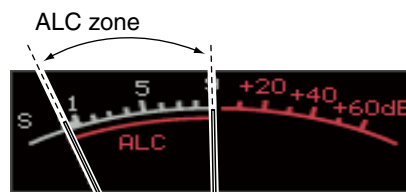
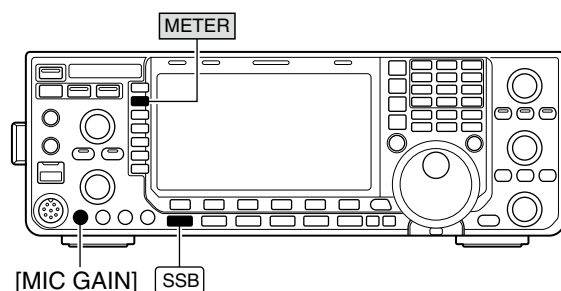

In addition, the transceiver can display the multi-function digital meter in the LCD, which displays all transmit meters simultaneously.

◇ Drive gain adjustment

The drive gain is active for all modes other than SSB mode with speech compressor OFF.

Before transmitting, monitor your selected operating frequency to make sure transmitting won't cause interference to other stations on the same frequency.

- ① Push **[EXIT/SET]** several times to return to normal screen, if necessary.
- ② Push **[SET] (F-6)**, then push **[LEVEL] (F-1)** to select level set mode.
- ③ Push **[▲] (F-1)** or **[▼] (F-2)** to select "Drive Gain" item.
- ④ Push **[METER] (MF2)** to select the ALC meter.
- ⑤ Push **[PTT]** (microphone; SSB with **[COMP]** ON, AM or FM), key down (CW) or push **[TRANSMIT]** (RTTY or PSK) to transmit.
- ⑥ While talking into the microphone, keying down or transmitting, rotate the main dial so that the ALC meter reading is within 30% to 50% of the ALC scale. (p. 36)
 - Talk into the microphone at your normal voice level.
- ⑦ Release **[PTT]**, stop keying or push **[TRANSMIT]** again to return to receive.
- ⑧ Push **[EXIT/SET]** to exit display set mode.

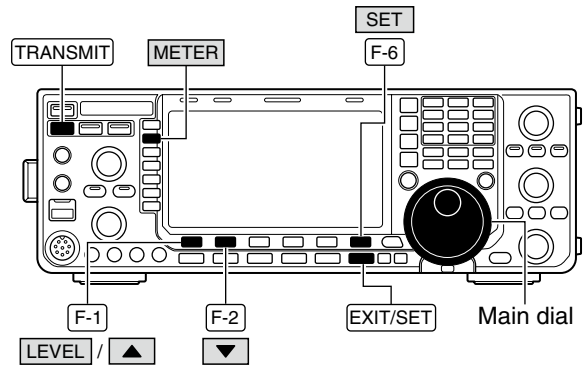

Drive gain range

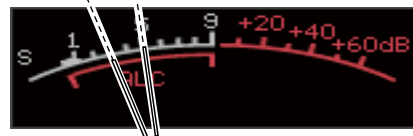

■ Functions for CW operation

◇ About CW reverse mode

CW-R (CW Reverse) mode uses the opposite side band to receive CW signals.

Use when interfering signals are near a desired signal and you want to use CW-R to reduce the interference.

- ➔ During CW mode, push **[CW]** to select CW and CW-R mode.

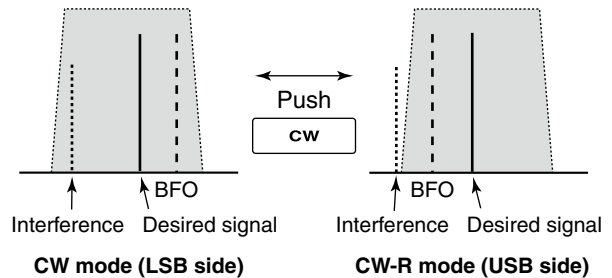

◇ About CW pitch control

The received CW audio pitch and CW sidetone can be adjusted to suit your preference (from 300 to 900 Hz; in 5 Hz steps). This does not change the operating frequency.

- ➔ Rotate **[CW PITCH]** to suit your preference.
 - Adjustable within 300 to 900 Hz.

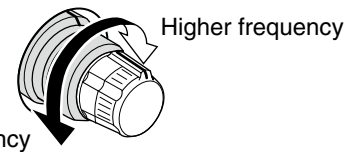
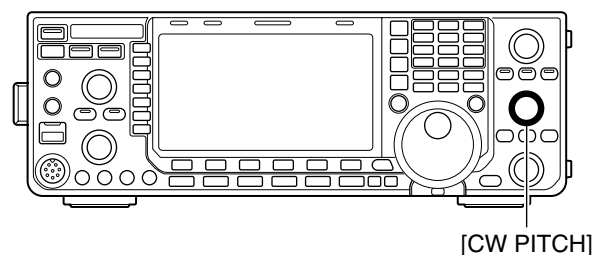

The filter set screen graphically displays the CW pitch operations. (See at right.)

- ➔ Push and hold **[FILTER]** for 1 sec. to access the filter set screen.
 - The CW pitch frequency is graphically changed in 5 Hz steps when the selected IF filter passband width is below 500Hz ("**BPF**" appears), or in 25 Hz steps when the selected IF filter passband width is above 600Hz ("**BPF**" disappears).
 - Push **[EXIT/SET]** or push and hold **[FILTER]** for 1 sec. to return to the previous screen.

• Filter set screen



CW pitch frequency (e.g. 700 Hz)

◇ CW sidetone function

When the transceiver is in receive (and the break-in function is OFF— p. 85) you can listen to the CW sidetone without actually transmitting.

This allows you to match your transmit frequency exactly to another station's by matching the audio tone. You can also use the CW sidetone (be sure to turn OFF break-in!) to practice CW sending. CW sidetone level can be adjusted in level set mode (p. 122).

- ① Push **[SET]** (F-6), then push **[LEVEL]** (F-1) to select level set mode.
- ② Push **[▲]** (F-1) or **[▼]** (F-2) to select "Side Tone Level" item.
- ③ Rotate the main dial to adjust the sidetone level.
 - Sidetone level is adjustable within 0 to 100 % in 1% steps.
- ④ Push **[EXIT/SET]** to exit display set mode.

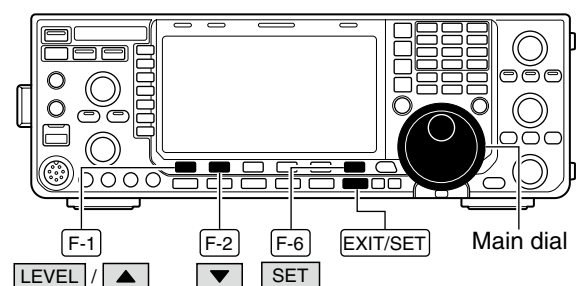

Matching the frequency of a transmitted and received signal is called "Zero beat."

3
4

◇ APF (Audio Peak Filter) operation

The APF changes the audio frequency response by boosting a particular frequency to enhance a desired CW signal.

- ① During CW mode, push **[APF/TPF]** to turn the audio peak filter ON and OFF.
 - “**APF**” appears in the display and the indicator on this switch lights green when the audio peak filter is ON.
- ② Push and hold **[APF/TPF]** for 1 sec. several times to select the desired audio filter width.
 - WIDE, MID and NAR filters, or 320, 160 and 80 Hz filters are available depending on [APF type] item setting in other set mode. (p. 133)

The APF (Audio Peak Filter) type is also selectable from “SOFT” and “SHARP” in [APF type] item in others set mode (p. 133).

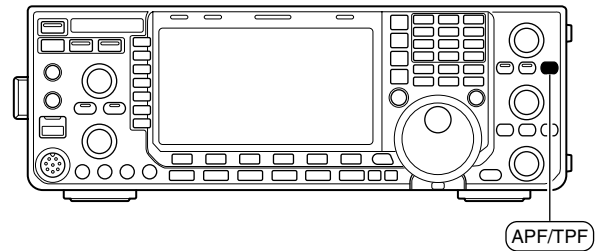

■ Electronic keyer functions

The IC-7600 has a number of convenient functions for the built-in electronic keyer that can be accessed from the memory keyer menu.

- ① During CW mode, push [EXIT/SET] several times to return to normal screen, if necessary.
- ② Push [KEYER] (F-3) to select memory keyer screen.
- ③ Push [EXIT/SET] to select memory keyer menu screen.
- ④ Push [SEND] (F-1), [EDIT] (F-2), [001] (F-3) or [CW KEY] (F-4) to select the desired menu. See the diagram below.
 - Push [EXIT/SET] to return to the previous display.

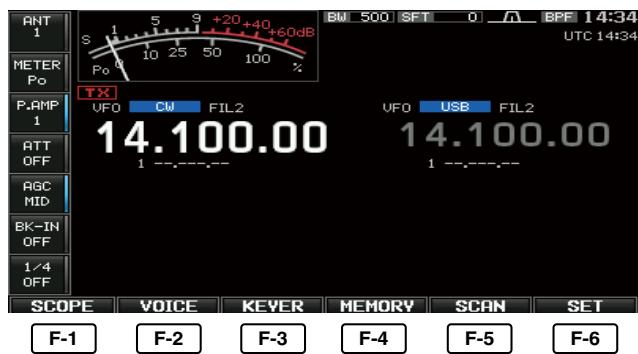
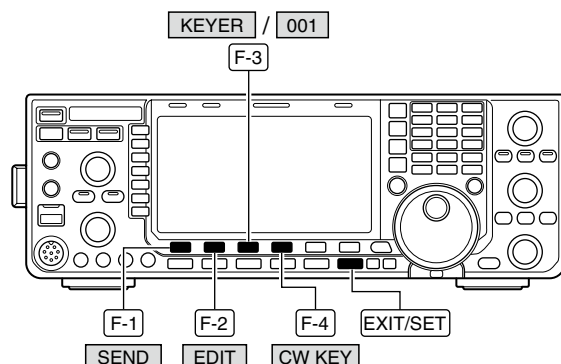

• Memory keyer screen (p. 41)



• Memory keyer edit screen (p. 42)



• Memory keyer menu screen

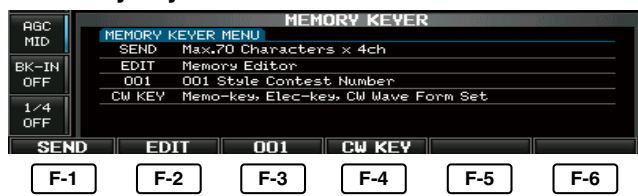

• Contest number set mode (p. 43)

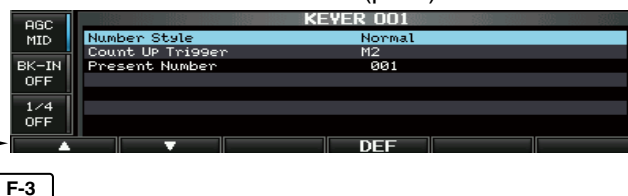

• Keyer set mode screen (p. 44)

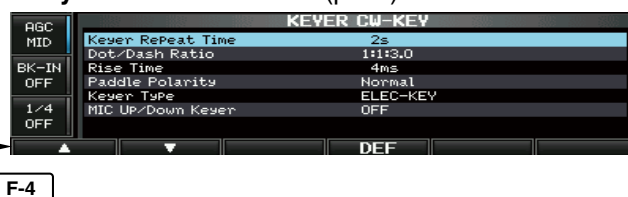

◇ Memory keyer screen

Pre-set characters can be sent using the keyer send menu. Contents of the memory keyer are set using the edit menu.

• Transmitting

- ① During CW mode operation, push **[KEYER] (F-3)** to select memory keyer screen.
- ② Push **[TRANSMIT]** to set the transceiver to transmit, or set the break-in function ON (p. 85).
- ③ Push one of the function keys (**[M1] (F-1)** to **[M4] (F-4)**) to send the contents of the memory keyer.
 - Push and hold a function key that is pushed in step ① for 1 sec., or push **[REPEAT] (F-6)** while sending the contents of the memory keyer to send repeatedly; push any function key except for to cancel the transmission.
 - “**+**” appears while transmitting repeatedly.
 - The contest serial number counter counts each time the contents are sent.
 - Push **[-1] (F-5)** to reduce the contest serial number count by 1 before sending the contents of the memory keyer to a station a second time.
 - “M1”–“M4” are highlighted while transmitting.
 - Set the repeat interval of the memory keyer to 1–60 sec. (1 sec. steps). See p. 44 for keyer set mode.
- ④ Push **[EXIT/SET]** twice to return to normal screen.

/// For your information

When an external keypad is connected to [MIC] connector on the front panel, or one of [F1]–[F4] key of the keyboard that is connected to the [USB] (A) connector on the front panel is pushed, the programmed contents, M1–M4, can be transmitted without selecting the memory keyer screen.

See pgs. 18, 133, 134 for details.

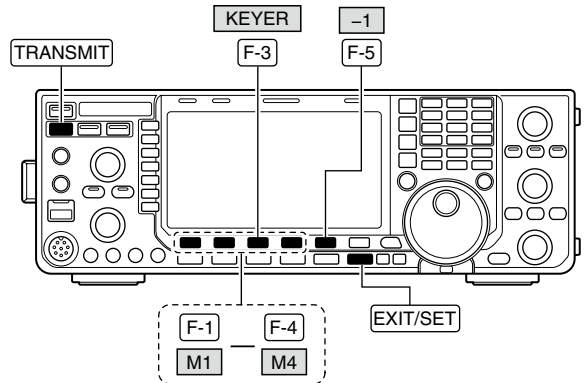

• Memory keyer screen

Count up trigger



During transmitting:

Appears while transmitting repeatedly.



Appears while transmitting.

◇ Editing a memory keyer

The contents of the memory keyer memories can be set using the memory keyer edit menu. The memory keyer can memorize and re-transmit 4 CW key codes for often-used CW sentences, contest serial numbers, etc. Total capacity of the memory keyer is 70 characters per memory channel.

• Programming contents

- ① During CW mode operation, push **[KEYER] (F-3)** to select memory keyer screen.
- ② Push **[EXIT/SET]** to select memory keyer menu, then push **[EDIT] (F-2)** to select keyer edit screen.
 - Memory keyer contents of Channel 1 (M1) is selected.
- ③ Push **[M1..M4] (F-6)** several times to select the desired memory keyer channel to be edited.
- ④ Push **[ABC] (MF6)** or **[123]/[Symbol] (MF7)** to select the character group, then rotate the main dial to select the character, or push the keypad for number input.
 - **[Symbol]** appears when **[123] (MF7)** is pushed when “123” character group is selected.
 - Selectable characters (using the main dial);

Key selection	Characters
ABC	A to Z (capital letters)
123	0 to 9 (numbers)
Symbol	/ ? ^ . , @ *

NOTE:

“^” is used to transmit a string of characters with no inter-character space. Put “^” before a text string such as ^AR, and the string “AR” is sent with no space.

“*” is used to insert the CW contest serial number. The serial number automatically increments by 1. This function is available only for one memory keyer channel at a time. Memory keyer channel M2 used “*” by default.

- ⑤ Push **[◀] (F-1)** or **[▶] (F-2)** to move the cursor backwards or forwards, respectively.
 - Pushing **[DEL] (F-3)** deletes a character and **[SPACE] (F-4)** inserts a space.
- ⑥ Repeat steps ④ and ⑤ to input the desired characters.
- ⑦ Push **[EXIT/SET]** twice to return to normal screen.

✓ For your convenience

When a PC keyboard is connected to [USB] (A) connector on the front panel, the memory keyer contents can also be edited from the keyboard.

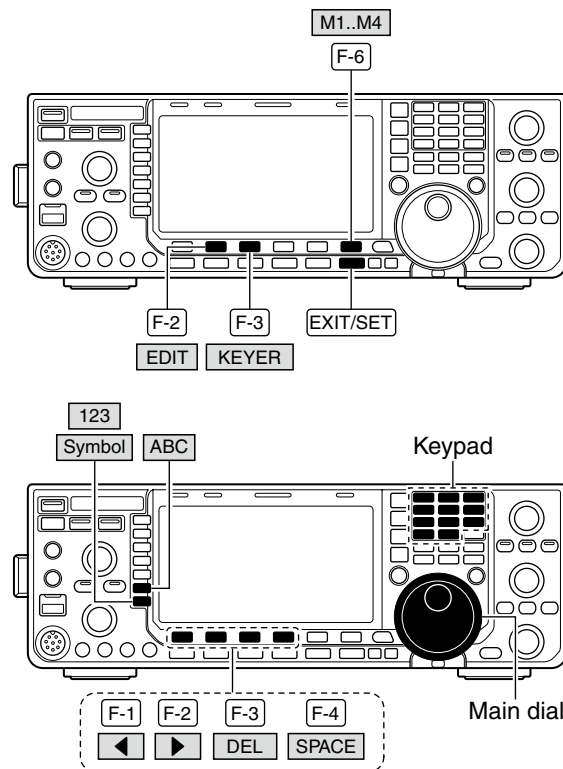

• Memory keyer edit screen



• Example— entered “QSL TU DE JA3YUA TEST” into memory keyer channel 3



• Pre-programmed contents

CH	Contents
M1	CQ TEST CQ TEST DE ICOM ICOM TEST
M2	UR 5NN* BK
M3	CFM TU
M4	QRZ?

◇ **Contest number set mode**

This menu is used to set the contest (serial) number and count-up trigger, etc.

• **Setting contents**

- ① During CW mode operation, push **[KEYER] (F-3)** to select memory keyer screen.
- ② Push **[EXIT/SET]** to select memory keyer menu, then push **[001] (F-3)** to select contest serial number set mode.
- ③ Push **[▲] (F-1)** or **[▼] (F-2)** to select the desired set item.
- ④ Set the desired condition using the main dial.
 - Push and hold **[DEF] (F-4)** for 1 sec. to select the default condition or value.
- ⑤ Push **[EXIT/SET]** twice to normal screen.

• **Contest number set mode screen**

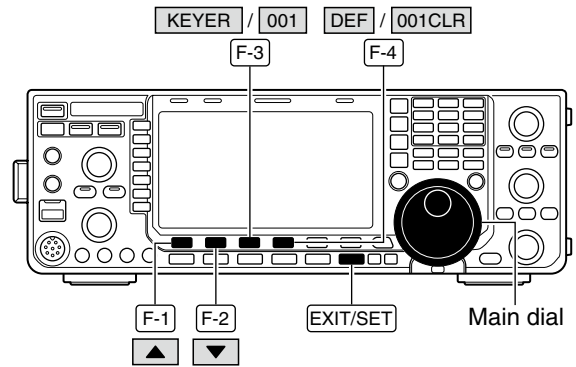

Number Style	Normal
<p>This item sets the numbering system used for contest (serial) numbers— normal or short morse numbers.</p> <p>Short morse numbers are also referred to as “cut” numbers.</p>	<ul style="list-style-type: none"> • Normal : Does not use short morse numbers (default) • 190→ANO : Sets 1 as A, 9 as N and 0 as O. • 190→ANT : Sets 1 as A, 9 as N and 0 as T. • 90→ NO : Sets 9 as N and 0 as O. • 90→ NT : Sets 9 as N and 0 as T.
Count Up Trigger	M2
<p>The count-up trigger allows the contest serial number to automatically increment after each complete serial number exchange is sent.</p>	<ul style="list-style-type: none"> • M1, M2, M3 and M4 can be set. (default: M2)
Present Number	001
<p>This item shows the current number for the count-up trigger channel set above.</p>	<ul style="list-style-type: none"> • Rotate the main dial to change the number, or push and hold [001CLR] (F-4) for 1 sec. to reset the current number to 001.

◇ Keyer set mode

This set mode is used to set the memory keyer repeat time, dash weight, paddle specifications, keyer type, etc.

• Setting contents

- ① During CW mode operation, push [KEYER] (F-3) to select memory keyer screen.
- ② Push [EXIT/SET] to select memory keyer menu, then push [CW KEY] (F-4) to select keyer set mode.
- ③ Push [▲] (F-1) or [▼] (F-2) to select the desired set item.
- ④ Set the desired condition using the main dial.
 - Push and hold [DEF] (F-4) for 1 sec. to select the default condition or value.
- ⑤ Push [EXIT/SET] twice to normal screen.

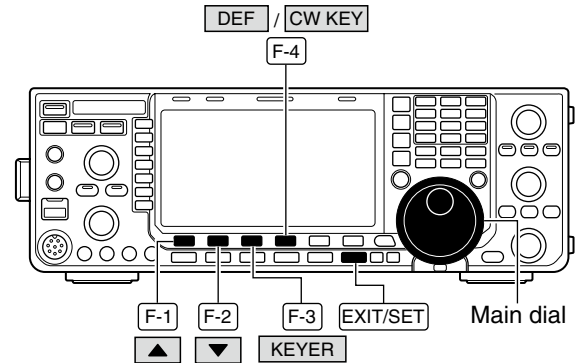

• Keyer set mode screen

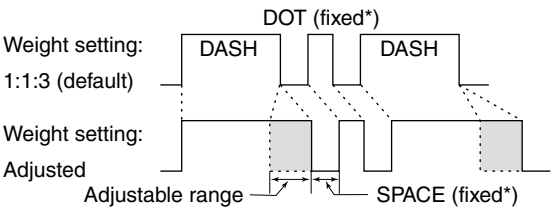

Keyer Repeat Time	2s
When sending CW using the repeat timer, this item sets the time between transmission.	<ul style="list-style-type: none"> • 1 to 60 sec. in 1 sec. steps can be selected. (default: 2 sec.)

Dot/Dash Ratio	1:1:3.0
This item sets the dot/dash ratio.	<ul style="list-style-type: none"> • 1:1:2.8 to 1:1:4.5 (in 0.1 steps) can be selected. (default: 1:1:3.0)
<p>Keying weight example: Morse code "K"</p> 	

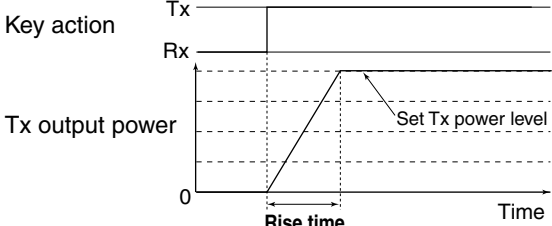
Rise Time	4ms
This item sets the rise time of the transmitted CW envelope.	<ul style="list-style-type: none"> • 2, 4, 6, 8 or 10 msec. can be selected. (default: 4 msec.)
<p>• About rise time</p> 	<ul style="list-style-type: none"> ▨ Key clicks on nearby frequencies can be generated if the rise time of a CW waveform is too short.

➤ Continues to the next page.

◇ Keyer set mode (continued)

Paddle Polarity	Normal
This item sets the paddle dot-dash polarity.	<ul style="list-style-type: none"> • Normal and reverse polarity can be selected.

Keyer Type	ELEC-KEY
This item selects the keyer type for [ELEC-KEY] connector on the front panel.	<ul style="list-style-type: none"> • Straight key, BUG-KEY and ELEC-KEY can be selected. (default: ELEC-KEY)

MIC Up/Down Keyer	OFF
<p>(Microphone's [UP]/[DN] switches keyer)</p> <p>This item allows you to set the microphone [UP]/[DN] switches to be used as a paddle. (The microphone [UP]/[DN] switches do not work as a 'squeeze key'.)</p>	<ul style="list-style-type: none"> • ON : [UP]/[DN] switches can be used for CW. • OFF : [UP]/[DN] switches cannot be used for CW. <p>/// NOTE: When "ON" is selected, the frequency and memory channel cannot be changed using the [UP]/[DN] switches.</p>

RTTY (FSK) operation

A DSP-based high-quality Baudot RTTY encoder/decoder is built-in to the IC-7600. When connecting a PC keyboard (pgs. 18, 19), RTTY operation can be performed without an external RTTY terminal, TNC or PC.

If you would rather use your RTTY terminal or TNC, consult the manual that comes with the RTTY terminal or TNC.

- ① Push a band key to select the desired band.
- ② Push **[RTTY/PSK]** to select RTTY.
 - After RTTY mode is selected, push and hold **[RTTY/PSK]** for 1 sec. to toggle between RTTY and RTTY-R modes.
 - “RTTY” or “RTTY-R” appears.
 - RTTY tuning indicator appears.
- ③ Push **[DECODE] (F-3)** to display the decode screen.
 - The IC-7600 has a built-in Baudot decoder.
- ④ To tune the desired signal, aim for a symmetrical waveform and ensure the peak points align with the mark (2125 Hz) and shift (170 Hz) frequency lines in the FFT scope.
 - The S-meter indicates received signal strength when signal is received.
- ⑤ Press **[F12]** on the connected PC’s keyboard to transmit.
 - [TX] indicator lights red.
- ⑥ Type from the keyboard to enter the contents that you want to transmit.
 - The typewritten contents are indicated in the TX buffer screen and transmitted immediately.
 - The text color will be changed when transmitted.
 - Press one of **[F1]–[F8]** on the keyboard to transmit the TX memory contents.
- ⑦ Press **[F12]** on the keyboard to return to receive.

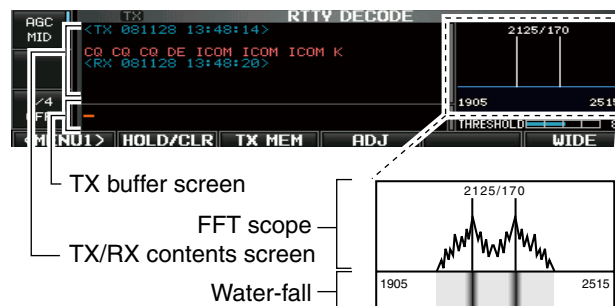
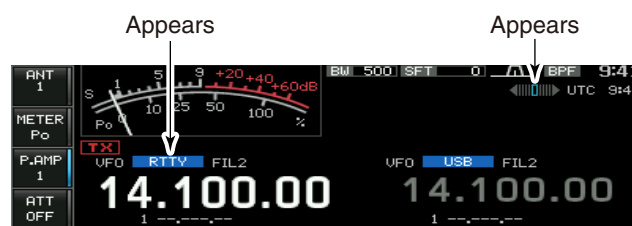
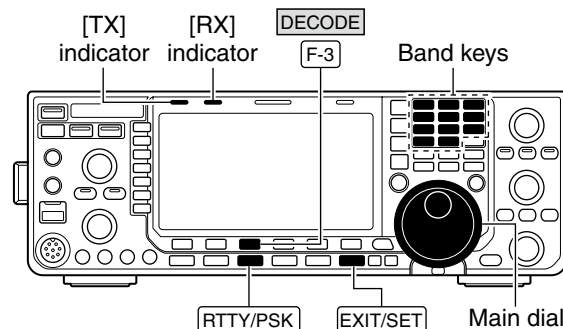

✓ For your convenience

The transmission contents can be typed before being transmitted.

- ① Perform the steps ① to ④ above.
- ② Type from the connected keyboard to enter the message that you want to transmit.
 - The typewritten contents are indicated in the TX buffer screen.
- ③ Press **[F12]** of the connected keyboard to transmit the typewritten contents.
 - The color of displayed text, in the TX buffer screen, will be changed when transmitted.
 - To cancel the transmission, press **[F12]** twice.
- ④ Press **[F12]** of the keyboard to return to receive.

◇ About RTTY reverse mode

Received characters are occasionally garbled when the received signal is reversed between Mark and Space tones. This reversal can be caused by incorrect TNC connections, setting, commands, etc.

To receive a reversed RTTY signals correctly, select RTTY-R (RTTY Reverse) mode.

- During RTTY mode, push and hold **[RTTY/PSK]** for 1 sec. to select RTTY-R mode.
 - Check the received signal.

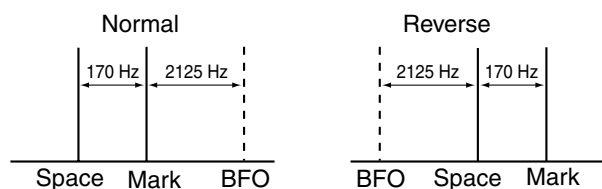

◇ Twin peak filter

The twin peak filter changes the audio frequency response by boosting the mark and space frequencies (2125 and 2295 Hz) for better reception of RTTY signals.

- During RTTY mode, push **[APF/TPF]** to turn the twin peak filter ON and OFF.
 - “**TPF**” appears in the LCD and the indicator on this switch lights green while the filter is in use.

NOTE: When the twin peak filter is in use, the received audio output may increase. This is a normal, not a malfunction.

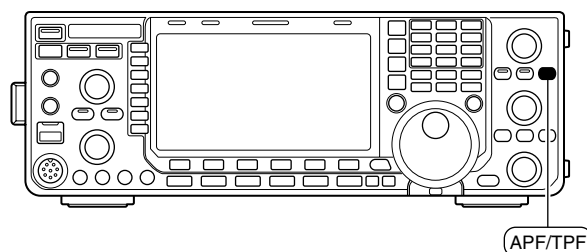

◆ Functions for the RTTY decoder indication

- ① Push a band key to select the desired band.
- ② Push **[RTTY/PSK]** to select RTTY.
 - After RTTY mode is selected, push and hold **[RTTY/PSK]** for 1 sec. to toggle between RTTY and RTTY-R modes.
 - “RTTY” or “RTTY-R” appears.
- ③ Push **[DECODE]** (F-3) to display the decode screen.
 - When tuned into an RTTY signal, decoded characters are displayed in the RX contents screen.
- ④ Push **[HOLD/CLR]** (F-2) to freeze the current screen.
 - “HOLD” appears while the function is in use.
 - Push **[HOLD/CLR]** (F-2) again to cancel the function.
- ⑤ Push and hold **[HOLD/CLR]** (F-2) for 1 sec. to clear the displayed characters.
 - “HOLD” indicator disappears at the same time when the hold function is in use.
- ⑥ Push **[WIDE]** (F-6) to toggle the RTTY decode screen size from normal and wide.
 - S/Rf meter type during wide screen indication can be selected in display set mode. (p. 129)
- ⑦ Push **[EXIT/SET]** to close the RTTY decode screen.

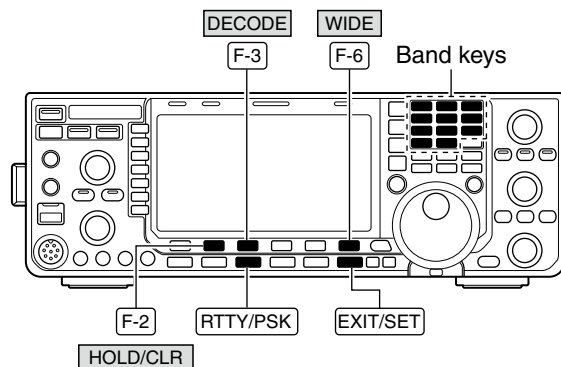

• RTTY Decode screen (Normal)

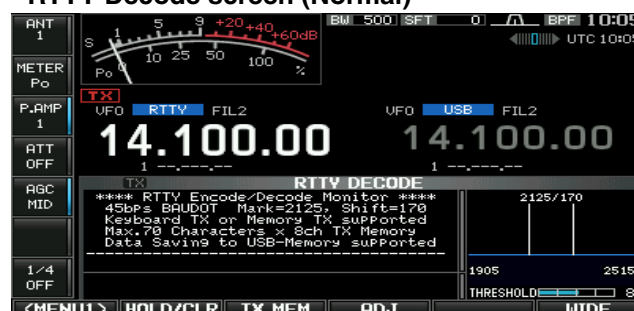

• RTTY Decode screen (Wide)



◆ Setting the decoder threshold level

Adjust the RTTY decoder threshold level if some characters are displayed when no signal is received.

- ① Select the RTTY decode screen as described above.
- ② Push **[ADJ]** (F-4) to select the threshold level setting condition.
- ③ Rotate the main dial to adjust the RTTY decoder threshold level.
 - Push and hold **[DEF]** (F-5) for 1 sec. to select the default setting.
- ④ Push **[ADJ]** (F-4) to exit from the threshold level setting condition.

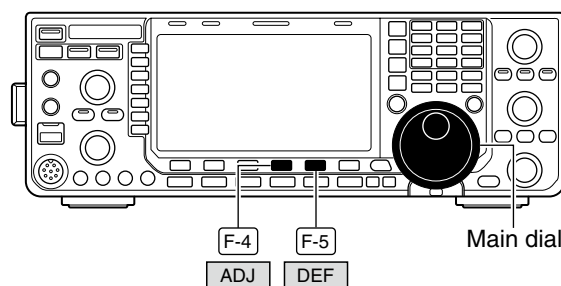

Threshold level indication bar

▨ The UnShift On Space (USOS) function and new line code can be set in the RTTY set mode. (p. 51)

◆ RTTY memory transmission

Pre-set characters can be sent using the RTTY memory. Contents of the memory are set using the edit menu.

- ① During RTTY mode operation, push [DECODE] (F-3) to select RTTY decode screen.
- ② Push [TX MEM] (F-3) to select RTTY memory screen.
- ③ Push [1-4/5-8] (F-6) to select memory bank then push one of the function keys ([RT1] (F-1) to [RT4] (F-4) or [RT5] (F-1) to [RT8] (F-4)).
 - When no keyboard is connected, the selected memory contents will be transmitted immediately.
 - When a keyboard is connected, the memory contents will be transmitted immediately when [F1] to [F8] on the connected keyboard is pressed, or transmitted after [F12] is pressed, depending on auto transmission/reception setting (see below).
 - The transmission date, time, reception date and/or time may be displayed in RX contents screen, depending on setting.

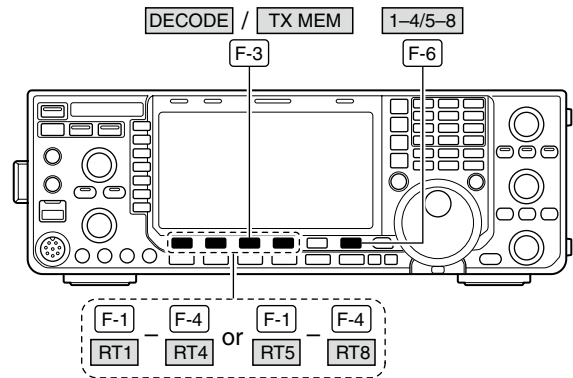

• RTTY memory screen

RTTY MEMORY			
AGC MID	RT1	-DE ICOM ICOM K-	AUTO TX/RX
	RT2	-DE ICOM ICOM ICOM K-	AUTO TX/RX
	RT3	-QSL UR 599-599 BK-	AUTO TX/RX
1/4 OFF	RT4	-QSL DE ICOM ICOM UR 599-599 BK-	AUTO TX/RX
	RT1	RT2	RT3
	RT4	EDIT	1-4/5-8

For your information

When an external keypad is connected to [MIC] connector on the front panel, the programmed contents, RT1—RT4, can be transmitted. (pgs. 18, 133)

◆ Automatic transmission/reception setting

- ① During RTTY mode operation, push [DECODE] (F-3) to select RTTY decode screen.
- ② Push [TX MEM] (F-3) to select RTTY memory screen, then push [EDIT] (F-5) to select RTTY memory edit screen.
 - RTTY memory contents of the Channel 1 (RT1) is selected.
- ③ Push [RT1..RT8] (F-6) several times to select the desired RTTY memory.
- ④ Push [AUTO TX] (F-5) several times to select the desired condition as follow.
 - AUTO TX/RX : Automatically transmits the selected memory and returns to receive after the transmission.
 - AUTO TX : Automatically transmits the selected memory. To return to receive, press [F12] on the keyboard.
 - AUTO RX : Press [F12] on the keyboard to transmit the selected memory. Automatically returns to receive after the transmission.
 - No indication : Press [F12] on the keyboard to transmit the selected memory and press [F12] again to return to receive.
- ⑤ Push [EXIT/SET] to exit RTTY memory edit condition.

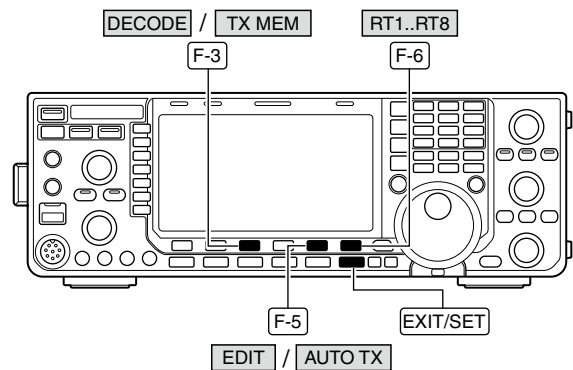

Auto TX/RX settings

RTTY MEMORY EDIT			
ABC	RT1	-DE ICOM ICOM K-	AUTO TX/RX
ABC	RT2	-DE ICOM ICOM ICOM K-	AUTO TX/RX
123	RT3	-QSL UR 599-599 BK-	AUTO TX/RX
	RT4	-QSL DE ICOM ICOM UR 599-599 BK-	AUTO TX/RX
		DEL	SPACE
		AUTO TX	RT1..RT8

NOTE: The transceiver always functions in the "AUTO TX/RX" setting when no keyboard is connected.

◇ Editing RTTY memory

The contents of the RTTY memories can be set using the memory edit menu. The memory can store and re-transmit 8 RTTY message for often-used RTTY information. Total capacity of the memory is 70 characters per memory channel.

• Programming contents

- ① During RTTY mode operation, push **[DECODE]** (F-3) to select RTTY decode screen.
- ② Push **[TX MEM]** (F-3) to select RTTY memory screen, then push **[EDIT]** (F-5) to select RTTY memory edit screen.
 - RTTY memory contents of the Channel 1 (RT1) is selected.
- ③ Push **[RT1..RT8]** (F-6) several times to select the desired RTTY memory channel to be edited.
- ④ Push **[ABC]** (MF6) or **[123]/[Symbol]** (MF7) to select the character group, then rotate the main dial to select the character, or push the keypad for number input.
 - **[Symbol]** (MF7) appears when **[123]** (MF7) is pushed when "123" character group is selected.
 - Selectable characters (using the main dial);

Key selection	Characters
ABC	A to Z (capital letters)
123	0 to 9 (numbers)
Symbol	! \$ & ? ' ' - / . , ; () ↵

- ⑤ Push **[◀]** (F-1) or **[▶]** (F-2) to move the cursor backwards or forwards, respectively.
 - Pushing **[DEL]** (F-3) deletes a character and **[SPACE]** (F-4) inserts a space.
- ⑥ Repeat steps ④ and ⑤ to input the desired characters.
- ⑦ Push **[EXIT/SET]** to set the contents and exit RTTY memory edit screen.

✓ For your convenience

When a PC keyboard is connected to [USB] connector on the front panel, the RTTY memory contents can also be edited from the keyboard.

**Downloaded by
RadioAmateur.EU**

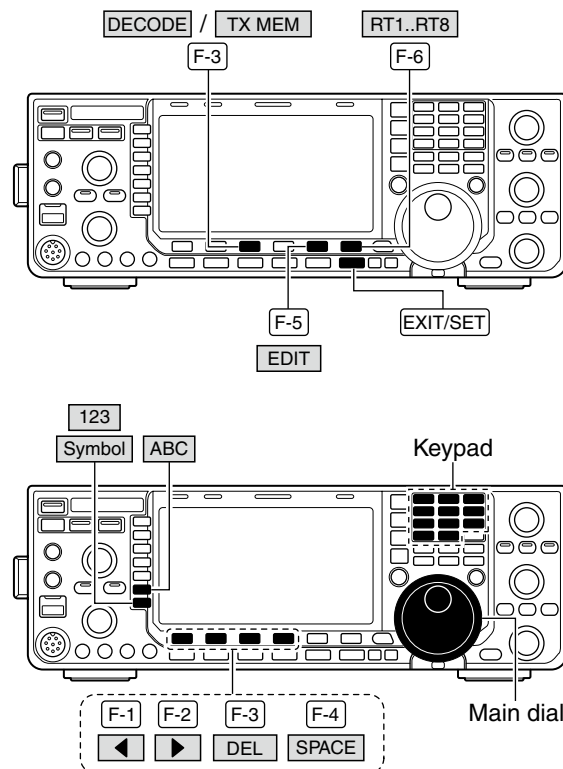

• RTTY memory edit screen

CH	Contents
RT1	└DE ICOM ICOM K┘
RT2	└DE ICOM ICOM ICOM K┘
RT3	└QSL UR 599-599 BK┘
RT4	└QSL DE ICOM ICOM UR 599-599 BK┘
RT5	└73 GL SK┘
RT6	└CQ CQ CQ DE ICOM ICOM ICOM K┘
RT7	└MY TRANSCEIVER IS IC-7600 & ANTENNA IS A 3-ELEMENT TRIBAND YAGI┘
RT8	└MY RTTY EQUIPMENT IS INTERNAL FSK UNIT & DEMODULATOR OF THE IC-7600┘

• Pre-programmed contents

CH	Contents
RT1	└DE ICOM ICOM K┘
RT2	└DE ICOM ICOM ICOM K┘
RT3	└QSL UR 599-599 BK┘
RT4	└QSL DE ICOM ICOM UR 599-599 BK┘
RT5	└73 GL SK┘
RT6	└CQ CQ CQ DE ICOM ICOM ICOM K┘
RT7	└MY TRANSCEIVER IS IC-7600 & ANTENNA IS A 3-ELEMENT TRIBAND YAGI┘
RT8	└MY RTTY EQUIPMENT IS INTERNAL FSK UNIT & DEMODULATOR OF THE IC-7600┘

◇ RTTY decode set mode

This set mode is used to set the decode USOS function, time stamp setting, etc.

• Setting contents

- ① During RTTY mode operation, push [DECODE] (F-3) to select RTTY decode screen.
- ② Push [<MENU1>] (F-1) to select the second RTTY decode menu, then push [SET] (F-5) to select RTTY decode set mode.
 - Push [WIDE] (F-6) to toggle the screen size from normal and wide.
- ③ Push [▲] (F-1) or [▼] (F-2) to select the desired set item.
- ④ Set the desired condition using the main dial.
 - Push and hold [DEF] (F-4) for 1 sec. to select a default condition or value.
 - Push [◀ ▶] (F-3) to select the set contents for some items.
- ⑤ Push [EXIT/SET] to exit from set mode.

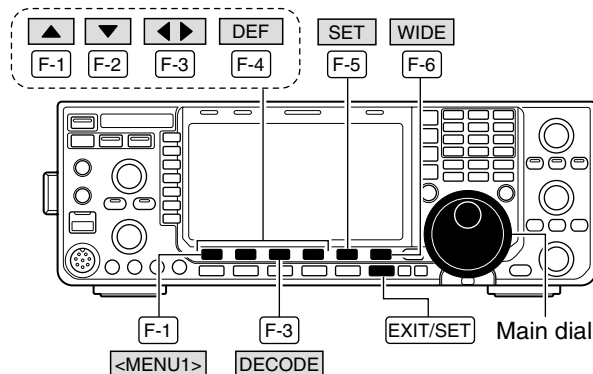

• RTTY decode set mode screen



RTTY FFT Scope Averaging	OFF
Select the FFT scope waveform averaging function from 2 to 4 and OFF. (default: OFF)	Recommendation! If you use the FFT scope waveform for tuning, use of the default or smaller averaging setting is recommended.
RTTY FFT Scope Waveform Color	
Set the color for the FFT scope waveform. <ul style="list-style-type: none"> • The color is set in RGB format. • The set color is indicated in the box beside the RGB scale. 	<ul style="list-style-type: none"> • Push [◀ ▶] (F-3) to select R (Red), G (Green) and B (Blue), and then rotate the main dial to set the ratio from 0 to 255.
RTTY Decode USOS	ON
Turn the capability of letter code decoding after receiving a "space" (USOS; UnShift On Space function) ON and OFF.	<ul style="list-style-type: none"> • ON : Decode as letter code. • OFF : Decode as character code.
RTTY Decode New Line Code	CR,LF,CR+LF
Selects the new line code of the internal RTTY decoder. CR: Carriage Return, LF: Line Feed	<ul style="list-style-type: none"> • CR,LF,CR+LF : Makes new line with any codes. • CR+LF : Makes new line with CR+LF code only.
RTTY Diddle	BLANK
Selects the diddle condition.	<ul style="list-style-type: none"> • OFF : Turns the diddle function OFF. • BLANK : Transmits blank code during no code transmission. • LTRS : Transmits letter code during no code transmission.

RTTY TX USOS	ON
Explicitly inserts the FIGS character even though it is not required by the receiving station.	<ul style="list-style-type: none"> • ON : Inserts FIGS. • OFF : Does not insert FIGS.

RTTY Auto CR+LF by TX	ON
Selects the automatic new line code (CR+LF) transmission capability.	<ul style="list-style-type: none"> • ON : Transmits CR+LF code once. • OFF : Transmits no CR+LF code.

RTTY Time Stamp	ON
Turn the time stamp (date, transmission or reception time) indication ON and OFF.	<ul style="list-style-type: none"> • ON : Displays the time stamp. • OFF : No time stamp indication.

RTTY Time Stamp (Time)	Local
Selects the clock indication for time stamp usage.	<ul style="list-style-type: none"> • Local : Selects the time that set in "Time (Now)." • UTC* : Selects the time that set in "CLOCK2." <p>*The name of choice may differ according to "CLOCK2 Name" setting (p. 115). "UTC" is the default name of CLOCK2.</p>
NOTE: The time won't be displayed when "OFF" is selected in "RTTY Time Stamp" as above.	

RTTY Time Stamp (Frequency)	OFF
Selects the operating frequency indication for time stamp usage.	<ul style="list-style-type: none"> • ON : Displays the operating frequency. • OFF : No operating frequency display.
NOTE: The frequency won't be displayed when "OFF" is selected in "RTTY Time Stamp" as above.	

RTTY Font Color (Receive)	
Set the text color for received characters.	<ul style="list-style-type: none"> • Push [◀ ▶] (F-3) to select R (Red), G (Green) and B (Blue), and then rotate the main dial to set the ratio from 0 to 255.
<ul style="list-style-type: none"> • The color is set in RGB format. • The set color is indicated in the box beside the RGB scale. 	

RTTY Font Color (Transmit)	
Set the text color for transmitted characters.	<ul style="list-style-type: none"> • Push [◀ ▶] (F-3) to select R (Red), G (Green) and B (Blue), and then rotate the main dial to set the ratio from 0 to 255.
<ul style="list-style-type: none"> • The color is set in RGB format. • The set color is indicated in the box beside the RGB scale. 	

RTTY Font Color (Time Stamp)	
Set the text color for time stamp indication.	<ul style="list-style-type: none"> • Push [◀ ▶] (F-3) to select R (Red), G (Green) and B (Blue), and then rotate the main dial to set the ratio from 0 to 255.
<ul style="list-style-type: none"> • The color is set in RGB format. • The set color is indicated in the box beside the RGB scale. 	

RTTY Font Color (TX Buffer)	
Set the text color in the TX buffer screen.	<ul style="list-style-type: none"> • Push [◀ ▶] (F-3) to select R (Red), G (Green) and B (Blue), and then rotate the main dial to set the ratio from 0 to 255.
<ul style="list-style-type: none"> • The color is set in RGB format. • The set color is indicated in the box beside the RGB scale. 	

◆ Data saving

The contents of the RTTY memory/received signal can be saved into the USB-Memory.

- ① During RTTY decode screen indication, push [**<MENU1>**] (F-1) to select the RTTY decode second menu.
- ② Push [**SAVE**] (F-4) to select decode file save screen.
- ③ Change the following conditions if desired.

• File name:

- ① Push [**EDIT**] (F-4) to select file name edit condition.
 - Push [**DIR/FILE**] (F-1) several times to select the file name, if necessary.
- ② Push [**ABC**] (MF6) or [**123**]/[**Symbol**] (MF7) to select the character group, then rotate the main dial to select the character.
 - [**ABC**] (MF6): A to Z (capital letters); [**123**] (MF7): 0 to 9 (numerals); [**Symbol**] (MF7): ! # \$ % & ' ` ^ - () { } _ - @ can be selected.
 - Push [**◀**] (F-1) to move the cursor left, push [**▶**] (F-2) to move the cursor right, [**DEL**] (F-3) delete a character and push [**SPACE**] (F-4) to insert a space.
- ③ Push [**EXIT/SET**] to set the file name.

• File format

- ① Push and hold [**SAVE/OPT**] (F-5) for 1 sec. to enter save option screen.
- ② Rotate the main dial to select the saving format from Text to HTML.
 - “Text” is the default setting.
 - Push and hold [**DEF**] (F-4) for 1 sec. to select the default setting.
- ③ Push [**EXIT/SET**] to return to the previous indication.

• Saving location

- ① Push [**DIR/FILE**] (F-1) to select tree view screen.
- ② Select the desired directory or folder in the USB-Memory.
 - Push [**◀▶**] (F-4) to select the upper directory.
 - Push [**▲**] (F-2) or [**▼**] (F-3) to select folder in the same directory.
 - Push and hold [**◀▶**] (F-4) for 1 sec. to select a folder in the directory.
 - Push [**REN**] (MF5) to rename the folder.
 - Push and hold [**DEL**] (MF6) for 1 sec. to delete the folder.
 - Push and hold [**MAKE**] (MF7) for 1 sec. to making a new folder. (Edit the name with the same manner as the “• File name” above.)
- ③ Push [**DIR/FILE**] (F-1) twice to select the file name.
- ④ Push [**SAVE/OPT**] (F-5).
 - After saving is completed, returns to RTTY decode second menu automatically.

✓ For your convenience!

Two data formats, Text and HTML, are available for PC data storage.

The USB-Memory is not supplied by Icom.

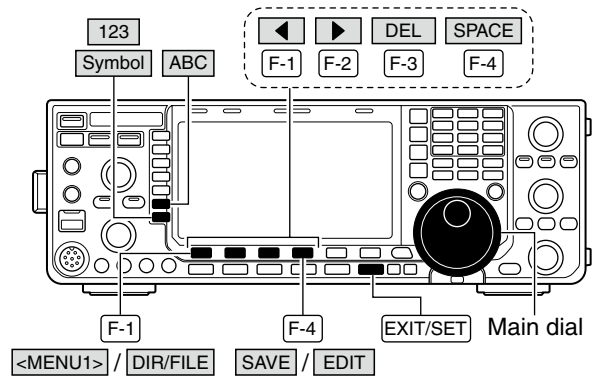

• Decode file save screen— file name edit

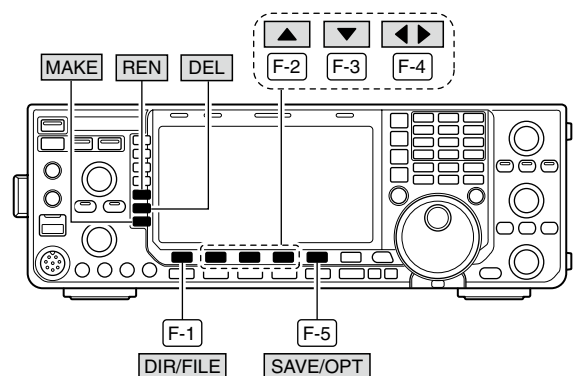
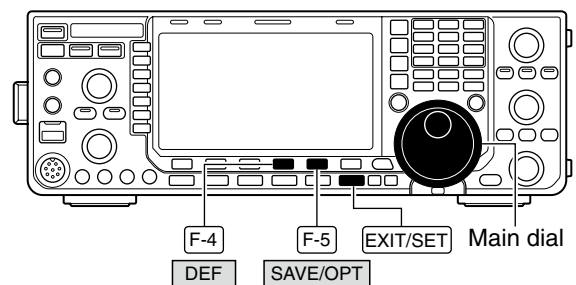

• Save option screen



When a PC keyboard is connected to [USB] connector on the front panel, the file name can also be edited from the keyboard. In this case, a USB hub is required.

■ PSK operation

A high-quality DSP-based PSK encoder/decoder is built-in to the IC-7600. When connecting a PC keyboard (pgs. 18, 19), PSK operation can be performed without PSK software installed on your PC.

If desired, you can also use your PSK software; consult the manual that comes with the software.

- ① Push a band key to select the desired band.
- ② Push **[RTTY/PSK]** to select PSK.
 - After PSK mode is selected, push and hold **[RTTY/PSK]** for 1 sec. to toggle between PSK and PSK-R modes.
 - “PSK” or “PSK-R” appears.
- ③ Push **[DECODE] (F-3)** to display the decode screen.
 - The IC-7600 has a built-in PSK decoder.
- ④ Tune to the desired signal with the main dial.
 - The signal is properly tuned when the radiated lines in the vector tuning indicator narrow, as show in the example below.
 - The radiated lines in the vector tuning indicator may be displayed sporadically.
 - When a PSK signal is received, the water-fall display is activated.
 - The water-fall display shows the signals within the pass-band. Received PSK signals appear as vertical lines.
- ⑤ Press **[F12]** of the connected keyboard to transmit.
 - [TX] indicator lights red.
- ⑥ Type from the connected keyboard to enter the message that you want to transmit.
 - The typewritten contents are indicated in the TX buffer screen and transmitted immediately.
 - The text color will be changed when transmitted.
 - Press one of **[F1]–[F8]** to transmit the TX memory contents.
- ⑦ Press **[F12]** of the keyboard to return to receive.

✓ For your convenience

The transmission contents can be typed before being transmitted.

- ① Perform the steps ① to ④ above.
- ② Type from the connected keyboard to enter the message that you want to transmit.
 - The message is shown in the TX buffer screen.
- ③ Press **[F12]** of the connected keyboard to transmit the message.
 - The color of displayed text, in the TX buffer screen, will be changed when transmitted.
 - To cancel the transmission, press **[F12]** twice.
- ④ Press **[F12]** of the keyboard to return to receive.

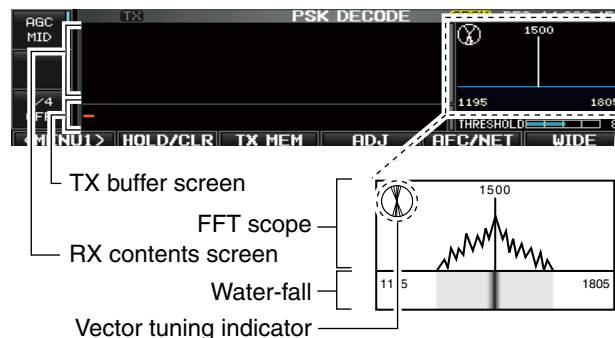
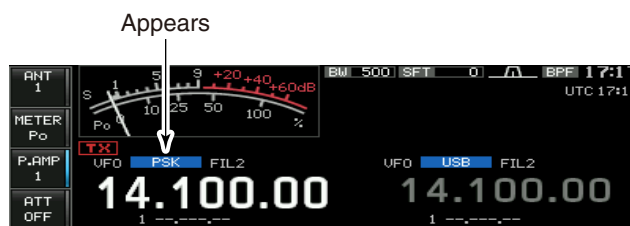
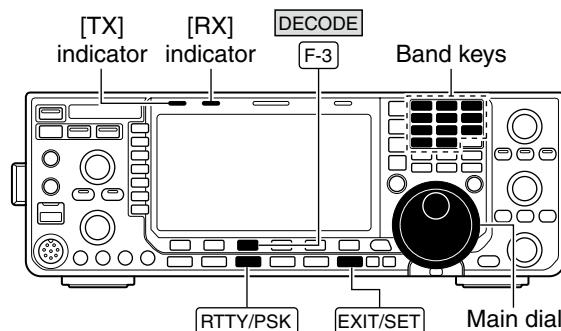

• Vector tuning indicator indication example

Tuned BPSK signal Tuned QPSK signal



BPSK/QPSK idle signal Unmodulated signal



◇ **About BPSK and QPSK modes**

BPSK and QPSK modes are available for PSK.

- BPSK (Binary Phase Shift Keying) mode is the most commonly used mode.
- QPSK (Quadrature Phase Shift Keying) mode has error correction capability to provide better decoding than BPSK mode in marginal condition. However, more accurate tuning is required with QPSK mode, due to the tight phase margin of QPSK.

- ① During PSK mode selection, push [**DECODE**] (**F-3**) to display the PSK decode screen.
- ② Push [**<MENU1>**] (**F-1**) to select PSK decode second menu.
- ③ Push [**B/QPSK**] (**F-2**) to toggle between BPSK and QPSK mode alternately.

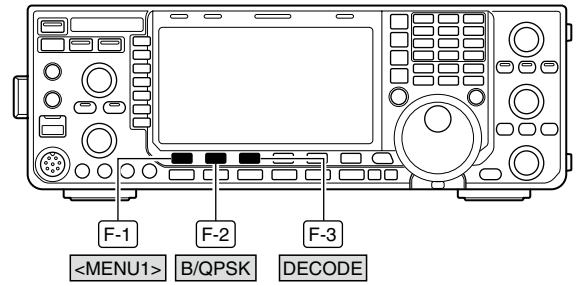

• **PSK decode screen— BPSK mode**



• **PSK decode screen— QPSK mode**



◆ Functions for the PSK decoder indication

- ① Push a band key to select the desired band.
- ② Push **[RTTY/PSK]** to select PSK.
 - After PSK mode is selected, push and hold **[RTTY/PSK]** for 1 sec. to toggle between PSK and PSK-R modes.
 - “PSK” or “PSK-R” appears.
- ③ Push **[DECODE]** (F-3) to display the decode screen.
 - When tuned into a PSK signal, decoded characters are displayed in the RX contents screen.
- ④ Push **[HOLD/CLR]** (F-2) to freeze the current screen.
 - “**HOLD**” appears while the function is in use.
 - Push **[HOLD/CLR]** (F-2) again to release the function.
- ⑤ Push and hold **[HOLD/CLR]** (F-2) for 1 sec. to clear the displayed characters.
 - “**HOLD**” indicator disappears at the same time when the hold function is in use.
- ⑥ Push **[WIDE]** (F-6) to toggle the PSK decode screen size from normal and wide.
 - S/Rf meter type during wide screen indication can be selected in display set mode. (p. 129)
- ⑦ Push **[AFC/NET]** (F-5) to turn the AFC function ON.
 - “**AFC**” appears.
 - If a PSK signal is received within the AFC tuning range, the decoder automatically tunes into the signal and the offset frequency is displayed.
 - The AFC tuning range is set to ± 15 Hz as the default. Optional ± 8 Hz setting is available in PSK decode set mode. (p. 59)

NOTE: The AFC function may not tune the signal properly when a weak PSK signal is received.

- ⑧ Push **[AFC/NET]** (F-5) again to turn the NET function ON.
 - “**NET**” appears additionally.
- ⑨ Push and hold **[AFC/NET]** (F-5) for 1 sec. to add the offset frequency to the displayed frequency.
- ⑩ Push **[EXIT/SET]** to close the PSK decode screen.

◆ Setting the decoder threshold level

Adjust the PSK decoder threshold level if some characters are displayed when no signal is received.

- ① Call up the PSK decode screen as described above.
- ② Push **[ADJ]** (F-4) to select the threshold level setting condition.
- ③ Rotate the main dial to adjust the PSK decoder threshold level.
 - Push and hold **[DEF]** (F-5) for 1 sec. to select the default setting.
- ④ Push **[ADJ]** (F-4) to exit from the threshold level setting condition.

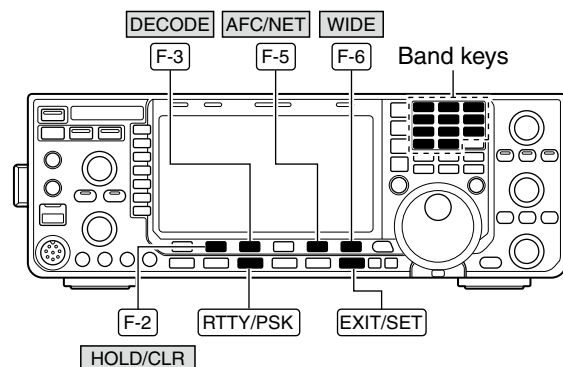

• AFC/NET indications



“AFC” and “NET” Offset frequency indicators

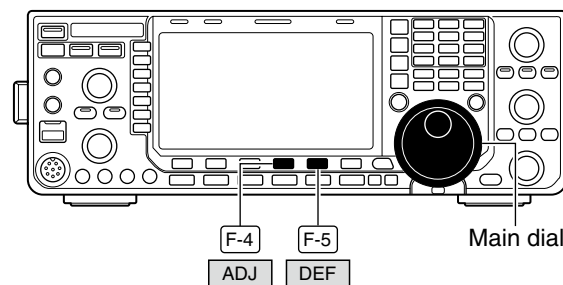

Threshold level indication bar

◆ **PSK memory transmission**

Pre-set characters can be sent using the PSK memory. Contents of the memory are set using the edit menu.

- ① During PSK mode operation, push **[DECODE] (F-3)** to select PSK decode screen.
- ② Push **[TX MEM] (F-3)** to select PSK memory screen.
- ③ Push **[1-4/5-8] (F-6)** to select memory bank then push one of the function keys (**[PT1] (F-1)** to **[PT4] (F-4)** or **[PT5] (F-1)** to **[PT8] (F-4)**).
 - When no keyboard is connected, the selected memory contents will be transmitted immediately.
 - When a keyboard is connected, the memory contents will be transmitted immediately when **[F1]** to **[F8]** on the connected keyboard is pressed, or transmitted after **[F12]** is pressed, depending on auto transmission/reception setting (see below).
 - The transmission date, time, reception date and/or time may be displayed in RX contents screen, depending on setting.

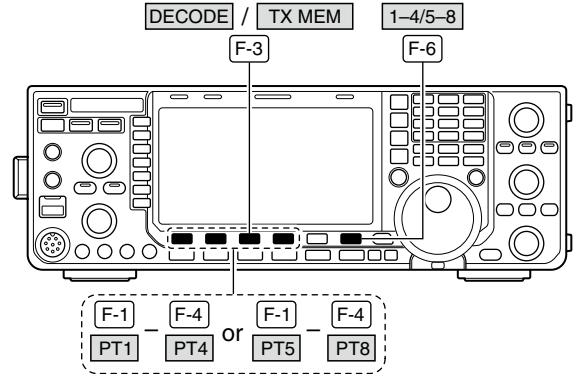

PSK MEMORY			
AGC MID	PT1	„DE Icom Icom K„	AUTO TX/RX
	PT2	„DE Icom Icom Icom K„	AUTO TX/RX
	PT3	„QSL UR 599 599 BK„	AUTO TX/RX
1/4 OFF	PT4	„QSL DE Icom Icom UR 599 599 BK„	AUTO TX/RX
	PT1	PT2	PT3
	PT4	EDIT	1-4/5-8

▨ **For your information**

When an external keypad is connected to [MIC] connector on the front panel, the programmed contents, PT1—PT4, can be transmitted. (pgs. 18, 133)

◆ **Automatic transmission/reception setting**

- ① During PSK mode operation, push **[DECODE] (F-3)** to select PSK decode screen.
- ② Push **[TX MEM] (F-3)** to select PSK memory screen, then push **[EDIT] (F-5)** to select PSK memory edit screen.
 - PSK memory contents of Channel 1 (PT1) is selected.
- ③ Push **[PT1..PT8] (F-6)** several times to select the desired PSK memory.
- ④ Push **[AUTO TX] (F-5)** several times to select the desired condition, as follows.
 - **AUTO TX/RX** : Automatically transmits the selected memory and returns to receive after the transmission.
 - **AUTO TX** : Automatically transmits the selected memory. To return to receive, press **[F12]** on the keyboard.
 - **AUTO RX** : Press **[F12]** on the keyboard to transmit the selected memory. Automatically returns to receive after the transmission.
 - **No indication** : Press **[F12]** on the keyboard to transmit the selected memory and press **[F12]** again to return to receive.
- ⑤ Push **[EXIT/SET]** to return to exit from PSK memory edit condition.

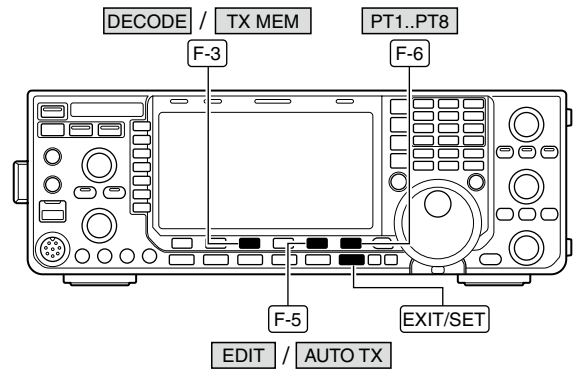

Auto TX/RX settings

PSK MEMORY EDIT			
ABC	PT1	„DE Icom Icom K„	AUTO TX/RX
ABC	PT2	„DE Icom Icom Icom K„	AUTO TX/RX
	PT3	„QSL UR 599 599 BK„	AUTO TX/RX
123	PT4	„QSL DE Icom Icom UR 599 599 BK„	AUTO TX/RX
		DEL	SPACE
		AUTO TX	PT1..PT8

▨ **NOTE:** The transceiver always functions in the “AUTO TX/RX” setting when no keyboard is connected.

◇ Editing PSK memory

The contents of the PSK memories can be set using the memory edit menu. The memory can store and re-transmit 8 PSK message for often-used PSK information. Total capacity of the memory is 70 characters per memory channel.

• Programming contents

- ① During PSK mode operation, push **[DECODE] (F-3)** to select PSK decode screen.
- ② Push **[TX MEM] (F-3)** to select PSK memory screen, then push **[EDIT] (F-5)** to select PSK memory edit screen.
 - PSK memory contents of the Channel 1 (PT1) is selected.
- ③ Push **[PT1..PT8] (F-6)** several times to select the desired PSK memory channel to be edited.
- ④ Push **[ABC]/[abc] (MF6)** or **[123]/[Symbol] (MF7)** to select the character group, then rotate the main dial to select the character, or push the keypad for number input.
 - **[abc] (MF6)** appears when **[ABC] (MF6)** is pushed when "ABC" character group is selected. and **[Symbol] (MF7)** appears when **[123] (MF7)** is pushed when "123" character group is selected.
 - Selectable characters (using the main dial);

Key selection	Characters
ABC	A to Z (capital letters)
abc	a to z (small letters)
123	0 to 9 (numbers)
Symbol	! # \$ % & ¥ ? " ' ` ^ + - * / . , ; : = < > () [] { } _ ~ @ `

- ⑤ Push **[◀] (F-1)** or **[▶] (F-2)** to move the cursor backwards or forwards, respectively.
 - Pushing **[DEL] (F-3)** deletes a character and **[SPACE] (F-4)** inserts a space.
- ⑥ Repeat steps ④ and ⑤ to input the desired characters.
- ⑦ Push **[EXIT/SET]** to set the contents and exit PSK memory edit screen.

✓ For your convenience

When a PC keyboard is connected to [USB] connector on the front panel, the PSK memory contents can also be edited from the keyboard.

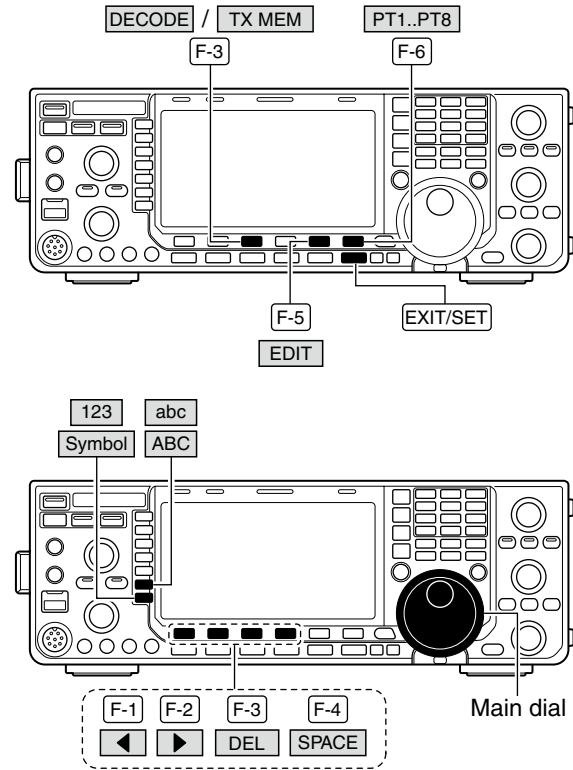

• PSK memory edit screen



• Pre-programmed contents

CH	Contents
PT1	DE Icom Icom K
PT2	DE Icom Icom Icom K
PT3	QSL UR 599 599 BK
PT4	QSL DE Icom Icom UR 599 599 BK
PT5	73 GL SK
PT6	CQ CQ CQ DE Icom Icom Icom K
PT7	My transceiver is IC-7600 & Antenna is a 3-element triband yagi.
PT8	My PSK equipment is internal modulator & demodulator of the IC-7600.

◇ PSK decode set mode

This set mode is used to set the PSK AFC range, time stamp setting, etc.

• Setting contents

- ① During PSK mode operation, push [DECODE] (F-3) to select PSK decode screen.
- ② Push [<MENU1>] (F-1) to select the second PSK decode menu, then push [SET] (F-5) to select PSK decode set mode.
 - Push [WIDE] (F-6) to toggle the screen size from normal and wide.
- ③ Push [▲] (F-1) or [▼] (F-2) to select the desired set item.
- ④ Set the desired condition using the main dial.
 - Push and hold [DEF] (F-4) for 1 sec. to select a default condition or value.
 - Push [◀ ▶] (F-3) to select the set contents for some items.
- ⑤ Push [EXIT/SET] to exit from set mode.

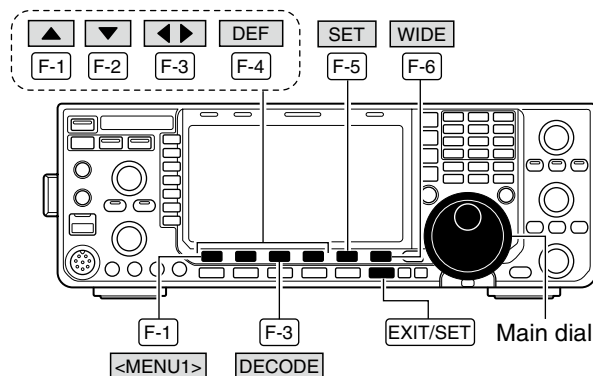



PSK FFT Scope Averaging	OFF
Select the FFT scope waveform averaging function from 2 to 4 and OFF. (default: OFF)	Recommendation! If you use the FFT scope waveform for tuning, using the default or smaller averaging setting is recommended.
PSK FFT Scope Waveform Color	
Set the color for the FFT scope waveform. <ul style="list-style-type: none"> • The color is set in RGB format. • The set color is indicated in the box beside the RGB scale. 	<ul style="list-style-type: none"> • Push [◀ ▶] (F-3) to select R (Red), G (Green) and B (Blue), and then rotate the main dial to set the ratio from 0 to 255.
PSK AFC Range	±15Hz
Select the AFC (Automatic Frequency Control) function operating range from ±15 Hz (default) and ±8 Hz.	NOTE: The AFC function may not tune the signal properly when a weak PSK signal is received.
PSK Time Stamp	ON
Turn the time stamp (date, transmission or reception time) display ON and OFF.	<ul style="list-style-type: none"> • ON : Displays the time stamp. • OFF : No time stamp display.
PSK Time Stamp (Time)	Local
Selects the clock display for time stamp usage.	<ul style="list-style-type: none"> • Local : Selects the time that set in "Time (Now)." • UTC* : Selects the time that set in "CLOCK2." <p>*The name of choice may differ according to "CLOCK2 Name" setting (p. 115). "UTC" is the default name of CLOCK2.</p>
NOTE: The time won't be displayed when "OFF" is selected in "PSK Time Stamp" as above.	

PSK Time Stamp (Frequency)	OFF
Selects the operating frequency display for time stamp usage. NOTE: The frequency won't be displayed when "OFF" is selected in "PSK Time Stamp" as below left.	<ul style="list-style-type: none">• ON : Displays the operating frequency.• OFF : No operating frequency display.

PSK Font Color (Receive)	
Set the text color for received characters. <ul style="list-style-type: none">• The color is set in RGB format.• The set color is indicated in the box beside the RGB scale.	<ul style="list-style-type: none">• Push [◀ ▶] (F-3) to select R (Red), G (Green) and B (Blue), and then rotate the main dial to set the ratio from 0 to 255.

PSK Font Color (Transmit)	
Set the text color for transmitted characters. <ul style="list-style-type: none">• The color is set in RGB format.• The set color is indicated in the box beside the RGB scale.	<ul style="list-style-type: none">• Push [◀ ▶] (F-3) to select R (Red), G (Green) and B (Blue), and then rotate the main dial to set the ratio from 0 to 255.

PSK Font Color (Time Stamp)	
Set the text color for time stamp indication. <ul style="list-style-type: none">• The color is set in RGB format.• The set color is indicated in the box beside the RGB scale.	<ul style="list-style-type: none">• Push [◀ ▶] (F-3) to select R (Red), G (Green) and B (Blue), and then rotate the main dial to set the ratio from 0 to 255.

PSK Font Color (TX Buffer)	
Set the text color in the TX buffer screen. <ul style="list-style-type: none">• The color is set in RGB format.• The set color is indicated in the box beside the RGB scale.	<ul style="list-style-type: none">• Push [◀ ▶] (F-3) to select R (Red), G (Green) and B (Blue), and then rotate the main dial to set the ratio from 0 to 255.

**Downloaded by
RadioAmateur.EU**

◆ Data saving

The contents of the PSK memory/received signal can be saved into the USB-Memory.

- ① During PSK decode screen indication, push [**<MENU1>**] (F-1) to select the PSK decode second menu.
- ② Push [**SAVE**] (F-4) to select decode file save screen.
- ③ Change the following conditions if desired.

• File name:

- ① Push [**EDIT**] (F-4) to select file name edit condition.
 - Push [**DIR/FILE**] (F-1) several times to select the file name, if necessary.
- ② Push [**ABC**] (MF6) or [**123**]/[**Symbol**] (MF7) to select the character group, then rotate the main dial to select the character.
 - [**ABC**] (MF6): A to Z (capital letters); [**123**] (MF7): 0 to 9 (numerals); [**Symbol**] (MF7): ! # \$ % & ' ` ^ - () { } _ - @ can be selected.
 - Push [**◀**] (F-1) to move the cursor left, push [**▶**] (F-2) to move the cursor right, [**DEL**] (F-3) delete a character and push [**SPACE**] (F-4) to insert a space.

- ③ Push [**EXIT/SET**] to set the file name.

• File format

- ① Push and hold [**SAVE/OPT**] (F-5) for 1 sec. to enter save option screen.
- ② Rotate the main dial to select the saving format from Text to HTML.
 - “Text” is the default setting.
 - Push and hold [**DEF**] (F-4) for 1 sec. to select the default setting.
- ③ Push [**EXIT/SET**] to return to the previous indication.

• Saving location

- ① Push [**DIR/FILE**] (F-1) to select tree view screen.
- ② Select the desired directory or folder in the USB-Memory.
 - Push [**◀▶**] (F-4) to select the upper directory.
 - Push [**▲**] (F-2) or [**▼**] (F-3) to select folder in the same directory.
 - Push and hold [**◀▶**] (F-4) for 1 sec. to select a folder in the directory.
 - Push [**REN**] (MF5) to rename the folder.
 - Push and hold [**DEL**] (MF6) for 1 sec. to delete the folder.
 - Push and hold [**MAKE**] (MF7) for 1 sec. to making a new folder. (Edit the name with the same manner as the “• File name” above.)
- ③ Push [**DIR/FILE**] (F-1) twice to select the file name.
- ④ Push [**SAVE/OPT**] (F-5).
 - After saving is completed, returns to PSK decode second menu automatically.

✓ For your convenience!

Two data formats, Text and HTML, are available for PC data storage.

The USB-Memory is not supplied by Icom.

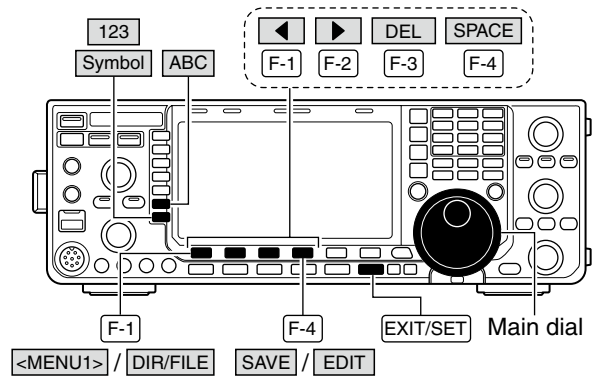

• Decode file save screen— file name edit

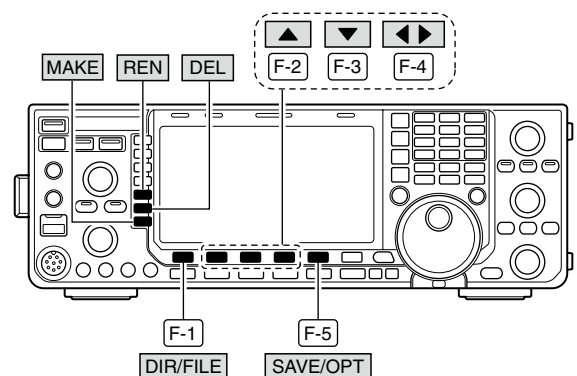
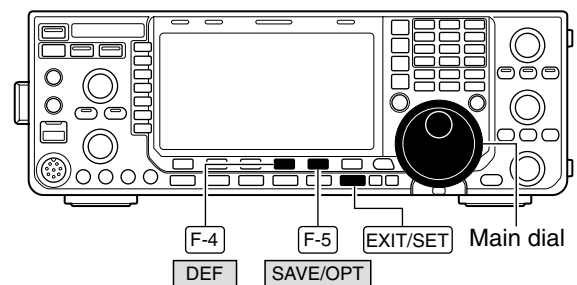

• Save option screen



When a PC keyboard is connected to [USB] connector on the front panel, the file name can also be edited from the keyboard. In this case, a USB hub is required.

■ Repeater operation

A repeater retransmits a received signal on a different frequency. When using a repeater, the transmit frequency is shifted from the receive frequency by an offset frequency. A repeater can be accessed using split frequency operation with the transmit frequency shifted to the repeater's receive frequency.

For accessing a repeater which requires an access tone, set the tone frequency in tone frequency set mode as described below.

- ① Set the offset frequencies (HF, 50 MHz) and turn ON the quick split function in others set mode in advance. (pgs. 89, 129)
- ② Push **[VFO/MEMO]** to select VFO mode.
- ③ Push the desired band key.
- ④ Push **[AM/FM]** several times to select FM mode.
- ⑤ Set the receive frequency (repeater output frequency).
- ⑥ Push and hold **[SPLIT]** for 1 sec. to start repeater operation.
 - Repeater tone is turned ON automatically.
 - **[SPLIT]** indicator lights and "**SPLIT**" appears on the LCD.
 - The tone encoder function is turned ON in FM mode.
 - Shifted transmit frequency and "TX" appear in the sub band.
 - The transmit frequency can be monitored while pushing **[XFC]**.
- ⑦ Push and hold **[PTT]** to transmit; release **[PTT]** to receive.
- ⑧ To return to simplex, push **[SPLIT]** momentarily.

◇ Repeater access tone frequency setting

Some repeaters require subaudible tones to be accessed. Subaudible tones are superimposed on your normal signal and must be set in advance. The transceiver has 50 tones from 67.0 Hz to 254.1 Hz.

- ① During FM mode operation, push and hold **[TONE] (MF7)** for 1 sec. to enter tone frequency set mode.
- ② Push **[▲] (F-1)** or **[▼] (F-2)** to select REPEATER TONE item.
- ③ Rotate the main dial to select the desired repeater tone frequency.
 - Push and hold **[DEF] (F-4)** for 1 sec. to select the default setting.
- ④ Push **[EXIT/SET]** to return to the previous indication.

• Available tone frequencies (unit: Hz)

67.0	85.4	107.2	136.5	165.5	186.2	210.7	254.1
69.3	88.5	110.9	141.3	167.9	189.9	218.1	
71.9	91.5	114.8	146.2	171.3	192.8	225.7	
74.4	94.8	118.8	151.4	173.8	196.6	229.1	
77.0	97.4	123.0	156.7	177.3	199.5	233.6	
79.7	100.0	127.3	159.8	179.9	203.5	241.8	
82.5	103.5	131.8	162.2	183.5	206.5	250.3	

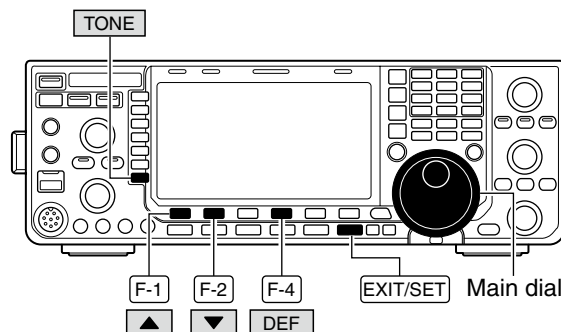
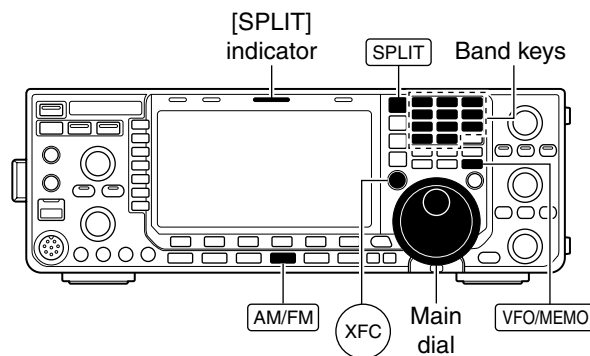

• Tone frequency set mode



■ Tone squelch operation

The tone squelch opens only when receiving a signal containing a matching subaudible tone. You can silently wait for calls from group members using the same tone.

- ① Set the desired frequency band and select FM mode.
- ② Push **[TONE] (MF7)** several times to turn the tone squelch function ON.
 - “**TSQL**” appears
- ③ Push and hold **[TONE] (MF7)** for 1 sec. to enter tone frequency set mode.
- ④ Push **[▲] (F-1)** or **[▼] (F-2)** to select T-SQL TONE item.
- ⑤ Rotate the main dial to select the desired tone squelch frequency.
 - Push and hold **[DEF] (F-4)** for 1 sec. to select the default setting.
- ⑥ Push **[EXIT/SET]** to return to the previous indication.
- ⑦ When the received signal includes a matching tone, squelch opens and the signal can be heard.
 - When the received signal’s tone does not match, tone squelch does not open. However, the S-indicator shows signal strength.
 - To open the squelch manually, push **[XFC]**.
- ⑧ Operate the transceiver in the normal way.
- ⑨ To cancel the tone squelch, push **[TONE] (MF7)** to clear “TSQL.”

• Available tone frequencies (unit: Hz)

67.0	85.4	107.2	136.5	165.5	186.2	210.7	254.1
69.3	88.5	110.9	141.3	167.9	189.9	218.1	
71.9	91.5	114.8	146.2	171.3	192.8	225.7	
74.4	94.8	118.8	151.4	173.8	196.6	229.1	
77.0	97.4	123.0	156.7	177.3	199.5	233.6	
79.7	100.0	127.3	159.8	179.9	203.5	241.8	
82.5	103.5	131.8	162.2	183.5	206.5	250.3	

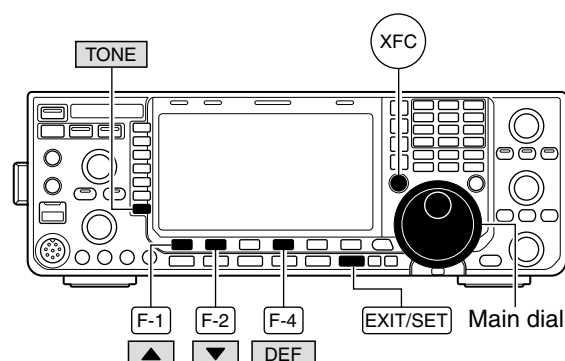

Appears



• Tone frequency set mode



■ Data mode (AFSK) operation

When operating AMTOR or PACKET with your TNC and/or PC software, consult the manual that comes with the TNC and/or the software.

- ① Connect a PC and TNC to the transceiver. (p. 22)
- ② Push a band key to select the desired band.
- ③ Push **[SSB]** or **[AM/FM]** to select the desired operating mode.
- ④ Push and hold **[SSB]** or **[AM/FM]** that is pushed in step ③ for 1 sec. to turn data mode ON.
 - One of “-D1,” “-D2” or “-D3” is additionally appears.
 - During data mode selection, push and hold **[SSB]** or **[AM/FM]** for 1 sec. to select data mode 1 (D1), 2 (D2) and 3 (D3) in sequence.
- ⑤ Rotate the main dial to tune to the desired signal and decode it correctly.
 - Also use the tuning indicator of the TNC or software.
 - During SSB data mode, the 1/4 tuning function can be used for critical tuning.
- ⑥ Operate the PC (software) or TNC to transmit.
 - When operating in SSB data mode, adjust the TNC output level so that the ALC meter reading doesn't go outside the ALC zone.

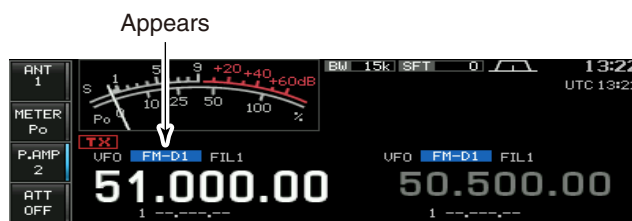
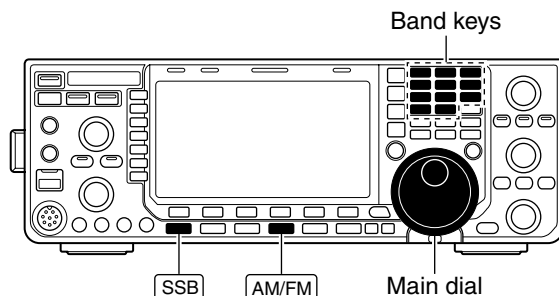

NOTE: When data mode is selected, the audio input from the [ACC1] (pin 4) is used for transmission instead of [MIC]'s depending on the set mode settings. Modulation input connector can be changed in ACC set mode (p. 124)

The fixed condition is used for SSB data transmission as follows:

- [COMP] : OFF
- Tx bandwidth : MID*
- Tx Tone (Bass) : 0
- Tx Tone (Trebles) : 0

*Fixed to the default value (lower: 300, higher: 2700). (p. 122)

✓ For your information

Carrier frequency is displayed when SSB data mode is selected.

See the diagram at right for the tone-pair example.

• Tone-pair example

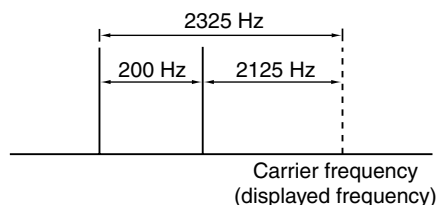

■ Spectrum scope screen

This DSP-based spectrum scope allows you to display the frequency and relative signal strength of received signals on the strengths of signals. The IC-7600 has two modes for the spectrum display— one is center mode, and the other is fixed mode.

In addition, the IC-7600 has a mini scope screen to save screen space.

◇ Center mode

Displays signals around the set frequency within the selected span. The set frequency is always displayed at the center of the screen.

- ① Push **[EXIT/SET]** several times to close a multi-function screen, if necessary.
- ② Push **[SCOPE] (F-1)** to select the scope screen.
- ③ Push **[CENT/FIX] (F-5)** several times to select the center mode.
 - “**CENTER**” is displayed when center mode is selected.
- ④ Push **[SPAN] (F-1)** several times to select the scope span.
 - ± 2.5 , ± 5.0 , ± 10 , ± 25 , ± 50 , ± 100 and ± 250 kHz are available.
 - Push and hold **[SPAN] (F-1)** for 1 sec. to return to ± 2.5 kHz span.
 - Sweep speed is selectable for each span independently in scope set mode. (pgs. 68, 69)
- ⑤ Push **[ATT] (F-2)** several times to activate an attenuator or turn the attenuator OFF.
 - 10, 20 and 30 dB attenuators are available.
 - Push and hold **[ATT] (F-2)** for 1 sec. to turn OFF the attenuator.
- ⑥ Push **[MARKER] (F-3)** several times to turn the marker for transmit frequency and/or sub readout frequency ON or OFF.
 - “**T**” displays the marker at the transmit frequency.
 - “**S**” displays the marker at the sub readout frequency.
 - “<<” or “>>” appears when the marker is out of range.
 - The spectrum scope shows the transmit signal while transmitting. This can be deactivated in scope set mode. (p. 68)
 - The spectrum scope shows the peak level hold function. Peak levels are displayed in the background of the current spectrum in a different color. This can be deactivated and the waveform color can be set in scope set mode. (p. 68)
- ⑦ Push **[HOLD] (F-4)** to freeze the current spectrum display.
 - “**HOLD**” appears while the function is in use.
 - Push and hold **[HOLD] (F-4)** to clear the current spectrum waveform.
- ⑧ Push **[EXIT/SET]** to exit the scope screen.

NOTE: If a strong signal is received, a ghost signal may also appear. Push **[ATT] (F-2)** several times to activate the spectrum scope attenuator in this case.

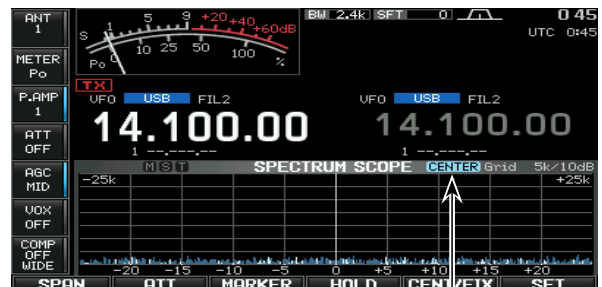
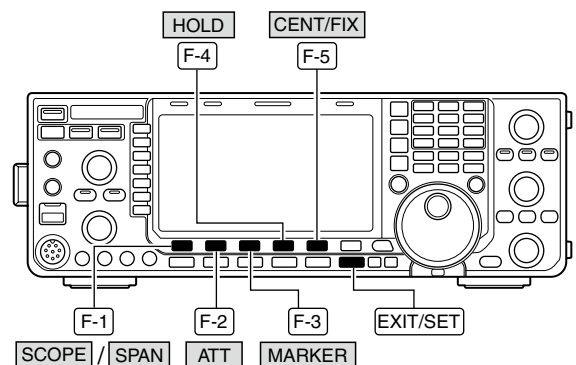

Appears

• Scope spurious signal example

Spurious signals may be received on the spectrum scope screen regardless of the transceiver's state (TX or RX). They are generated in the scope circuit. This does not indicate a transceiver malfunction.

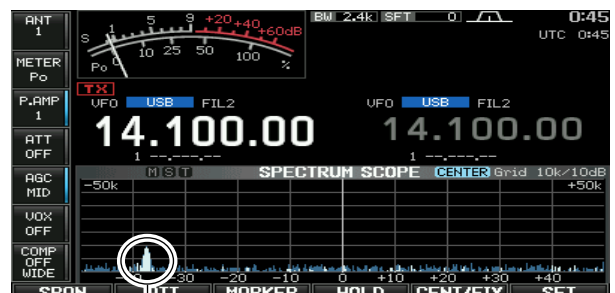

Scope spurious example

◆ Fixed mode

Displays signals within the specified frequency range. Conditions on the selected frequency band can be observed at a glance when using this mode.

- ① Push **[EXIT/SET]** several times to close a multi-function screen, if necessary.
- ② Push **[SCOPE] (F-1)** to select the scope screen.
- ③ Push **[CENT/FIX] (F-5)** several times to select the fixed mode.
 - “**FIX**” is displayed when fixed mode is selected.
- ④ Push **[ATT] (F-2)** several times to activate an attenuator or turn the attenuator OFF.
 - 10, 20 and 30 dB attenuators are available.
 - Push and hold **[ATT] (F-2)** for 1 sec. to turn OFF the attenuator.
- ⑤ Push **[MARKER] (F-3)** several times to turn the marker for transmit frequency and/or sub readout frequency ON or OFF.
 - “**T**” displays the marker at the transmit frequency.
 - “**S**” displays the marker at the sub readout frequency.
 - “**M**” displays the marker at the main readout frequency. (always displayed)
 - “<<” or “>>” appears when the marker is out of range.
 - The spectrum scope shows the transmit signal while transmitting. This can be deactivated in scope set mode. (p. 68)
 - The spectrum scope shows the peak level hold function. Peak levels are displayed in the background of the current spectrum in a different color. This can be deactivated and the waveform color can be set in scope set mode. (p. 68)
- ⑥ Push **[HOLD] (F-4)** to freeze the current spectrum waveform.
 - “**HOLD**” appears while the function is in use.
 - Push and hold **[HOLD] (F-4)** to clear the current spectrum waveform.
- ⑦ Push **[EXIT/SET]** to exit the scope screen.

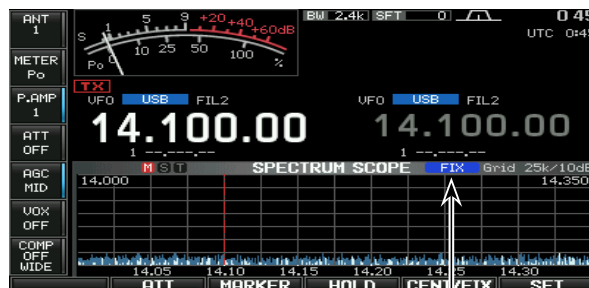
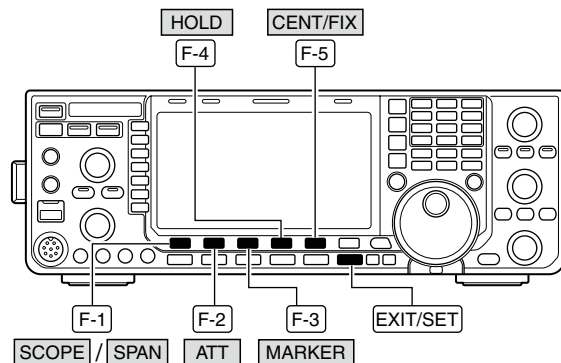

Appears

NOTE: If a strong signal is received, a ghost signal may appear. Push **[ATT] (F-2)** several times to activate the spectrum scope attenuator in this case.

The scope bandwidth can be specified for each frequency band independently in scope set mode. (pgs. 69 to 71)

◆ **Mini scope screen indication**

The mini scope screen can be displayed with another screen display, such as set mode menu, decode screen, memory list screen, etc. simultaneously.

- ① Set the scope mode (center or fixed), marker, attenuator, span, etc. in advance. (pgs. 65, 66)
- ② Push and hold **[MAIN/SUB M.SCOPE]** for 1 sec. to select the mini scope indication.
 - The S/RF meter type during mini scope indication can be selected in display set mode (Meter Type (Wide Screen) item). (p. 126)

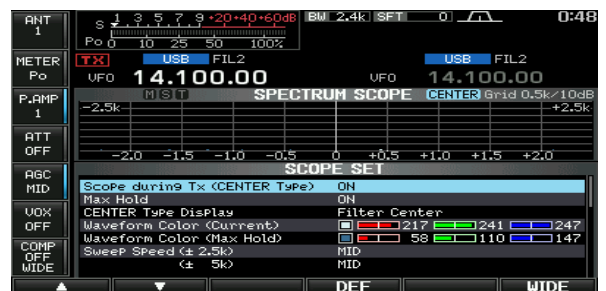
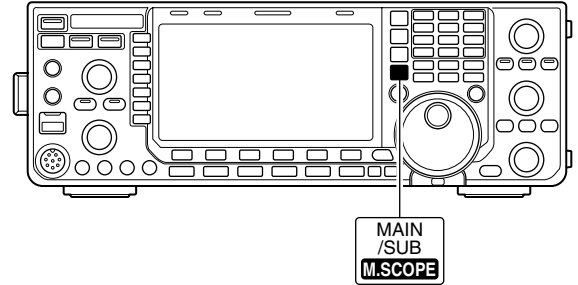

◆ **Scope set mode**

This set mode is used to set the waveform color, sweeping speed, scope range for fixed mode, etc.

- ① During spectrum scope display ON, push **[SET] (F-6)** to select scope set mode screen.
 - Push **[WIDE] (F-6)** to toggle the screen size between normal and wide.
- ② Push **[▲] (F-1)** or **[▼] (F-2)** to select the desired set item.
- ③ Set the desired condition using the main dial.
 - Push and hold **[DEF] (F-4)** for 1 sec. to select the default condition or value.
 - Push **[◀ ▶] (F-3)** to select the set contents for some items.
- ④ Push **[EXIT/SET]** to exit from set mode.

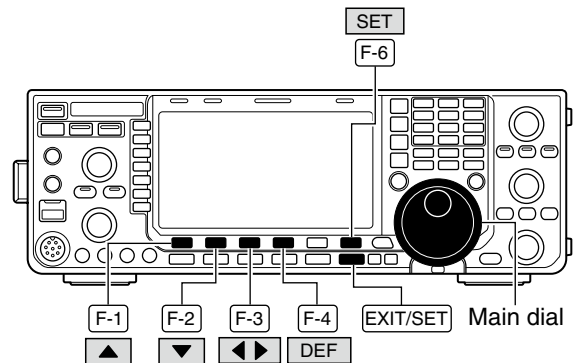

Scope during Tx (CENTER Type)	ON
Turn display of the transmit signal ON and OFF.	 NOTE: Transmit signal display is available for the center mode only.

Max Hold	ON
Turn the peak level hold function ON and OFF.	

CENTER Type Display	Filter Center
Select the center frequency of the spectrum scope indication (center mode only).	<ul style="list-style-type: none"> • Filter Center : Shows the selected filter's center frequency at the center. • Carrier Point Center : Shows the selected operating mode carrier point frequency at the center. • Carrier Point Center (Abs. Freq.) : In addition to the carrier point center setting above, the actual frequency is displayed for the bottom of the scope.

Waveform Color (Current)	
Set the waveform color for the currently received signals.	<ul style="list-style-type: none"> • The color is set in RGB format. • Push [◀ ▶] (F-3) to select R (Red), G (Green) and B (Blue), and rotate the ratio from 0 to 255 range. • The set color is indicated in the box beside the RGB scale.

Waveform Color (Max Hold)	
Set the waveform color for the received signals maximum level.	<ul style="list-style-type: none"> • The color is set in RGB format. • Push [◀ ▶] (F-3) to select R (Red), G (Green) and B (Blue), and rotate the ratio from 0 to 255 range. • The set color is indicated in the box beside the RGB scale.

Sweep Speed (± 2.5k)	MID
Select the sweep speed for the ±2.5 kHz span selection from SLOW, MID and FAST.	 NOTE: Signals may be displayed incorrectly with "FAST" setting.

Sweep Speed (± 5k)	MID
Select the sweep speed for the ±5 kHz span selection from SLOW, MID and FAST.	 NOTE: Signals may be displayed incorrectly with "FAST" setting.

Sweep Speed (± 10k)	FAST
Select the sweep speed for the ±10 kHz span selection from SLOW, MID and FAST.	

➤ Continues to the next page.

◇ Scope set mode (continued)

Sweep Speed (± 25k) FAST

Select the sweep speed for the ±25 kHz span selection from SLOW, MID and FAST.

Sweep Speed (± 50k) FAST

Select the sweep speed for the ±50 kHz span selection from SLOW, MID and FAST.

Sweep Speed (± 100k) FAST

Select the sweep speed for the ±100 kHz span selection from SLOW, MID and FAST.

Sweep Speed (± 250k) FAST

Select the sweep speed for the ±250 kHz span selection from SLOW, MID and FAST.

Fixed Edges (0.03 – 1.60) 0.750 – 1.250 MHz

Set the scope edge frequencies for fixed mode for bands below 1.6 MHz.

- Set the frequencies within 0.030 to 1.600 MHz range in 1 kHz steps.

/// As edge frequencies are set, the other edge frequency will be automatically set for a display band width of 5 kHz to a maximum of 500 kHz.

Fixed Edges (1.60 – 2.00) 1.800 – 2.000 MHz

Set the scope edge frequencies for fixed mode scope when the 1.6 to 2 MHz band is selected.

- Set the frequencies within 1.600 to 2.000 MHz range in 1 kHz steps.

Fixed Edges (2.00 – 6.00) 3.500 – 4.000 MHz

Set the scope edge frequencies for fixed mode scope when the 2 to 6 MHz band is selected.

- Set the frequencies within 2.000 to 6.000 MHz range in 1 kHz steps.

/// As edge frequencies are set, the other edge frequency will be automatically set for a display band width of 5 kHz to a maximum of 500 kHz.

Fixed Edges (6.00 – 8.00) 7.000 – 7.300 MHz

Set the scope edge frequencies for fixed mode scope when the 6 to 8 MHz band is selected.

- Set the frequencies within 6.000 to 8.000 MHz range in 1 kHz steps.

/// As edge frequencies are set, the other edge frequency will be automatically set for a display band width of 5 kHz to a maximum of 500 kHz.

Fixed Edges (8.00 – 11.00) 10.100 – 10.150 MHz

Set the scope edge frequencies for fixed mode scope when the 8 to 11 MHz band is selected.

- Set the frequencies within 8.000 to 11.000 MHz range in 1 kHz steps.

/// As edge frequencies are set, the other edge frequency will be automatically set for a display band width of 5 kHz to a maximum of 500 kHz.

Fixed Edges (11.00 – 15.00) 14.000 – 14.350 MHz

Set the scope edge frequencies for fixed mode scope when the 11 to 15 MHz band is selected.

- Set the frequencies within 11.000 to 15.000 MHz range in 1 kHz steps.

/// As edge frequencies are set, the other edge frequency will be automatically set for a display band width of 5 kHz to a maximum of 500 kHz.

Fixed Edges (15.00 – 20.00) 18.068 – 18.168 MHz

Set the scope edge frequencies for fixed mode scope when the 15 to 20 MHz band is selected.

- Set the frequencies within 15.000 to 20.000 MHz range in 1 kHz steps.

/// As edge frequencies are set, the other edge frequency will be automatically set for a display band width of 5 kHz to a maximum of 500 kHz.

Fixed Edges (20.00 – 22.00) 21.000 – 21.450 MHz

Set the scope edge frequencies for fixed mode scope when the 20 to 22 MHz band is selected.

- Set the frequencies within 20.000 to 22.000 MHz range in 1 kHz steps.

/// As edge frequencies are set, the other edge frequency will be automatically set for a display band width of 5 kHz to a maximum of 500 kHz.

Fixed Edges (22.00 – 26.00) 24.890 – 24.990 MHz

Set the scope edge frequencies for fixed mode scope when the 22 to 26 MHz band is selected.

- Set the frequencies within 22.000 to 26.000 MHz range in 1 kHz steps.

/// As edge frequencies are set, the other edge frequency will be automatically set for a display band width of 5 kHz to a maximum of 500 kHz.

➤ Continues to the next page.

◇ Scope set mode (continued)

Fixed Edges (26.00 – 30.00)	28.000 – 28.500 MHz
Set the scope edge frequencies for fixed mode scope when the 26 to 30 MHz band is selected.	<ul style="list-style-type: none"> • Set the frequencies within 26.000 to 30.000 MHz range in 1 kHz steps. /// As edge frequencies are set, the other edge frequency will be automatically set for a display band width of 5 kHz to a maximum of 500 kHz.
Fixed Edges (30.00 – 45.00)	30.000 – 30.500 MHz
Set the scope edge frequencies for fixed mode scope when the 30 to 45 MHz band is selected.	<ul style="list-style-type: none"> • Set the frequencies within 30.000 to 45.000 MHz range in 1 kHz steps. /// As edge frequencies are set, the other edge frequency will be automatically set for a display band width of 5 kHz to a maximum of 500 kHz.
Fixed Edges (45.00 – 60.00)	50.000 – 50.500 MHz
Set the scope edge frequencies for fixed mode scope when the 45 to 60 MHz band is selected.	<ul style="list-style-type: none"> • Set the frequencies within 45.000 to 60.000 MHz range in 1 kHz steps. /// As edge frequencies are set, the other edge frequency will be automatically set for a display band width of 5 kHz to a maximum of 500 kHz.

■ Preamplifier

The preamp amplifies received signals in the receiver front end, to improve the S/N ratio and sensitivity. Set this to preamp 1 or preamp 2 when receiving weak signals.

- ➔ Push **[P.AMP] (MF3)** several times to set the preamp OFF, preamp 1 ON or preamp 2 ON.
- ➔ Push and hold **[P.AMP] (MF3)** for 1 sec. to turn the preamp function OFF.

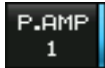

For all HF and 50 MHz bands



High-gain preamp for 24 MHz band and above (Available for all HF and 50 MHz bands)

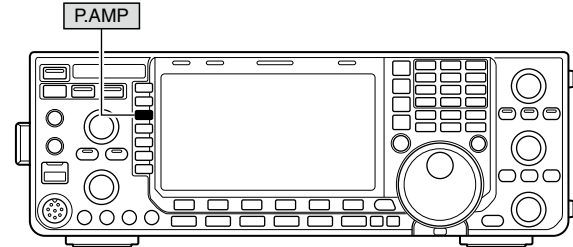

✓ About the "P.AMP2"

The "P.AMP 2" is a high gain receive amplifier. When the "P.AMP 2" is used in the presence of strong electromagnetic fields, distortion sometimes results. In such cases, use the transceiver with the "P.AMP 1" or "P.AMP OFF" setting.

The "P.AMP 2" is most effective when:

- Used on bands above 24 MHz and when signals are weak.
- Receive sensitivity is insufficient when using low-gain antennas, or while using a narrow band antenna (such as small loop, a Beverage antenna or a short Yagi antenna).

■ Attenuator

The attenuator prevents a desired signal from distortion when very strong signals are near the desired frequency or when very strong electromagnetic fields, such as from broadcast stations near your location.

- ➔ Push **[ATT] (MF4)** several times to set the attenuator 6 dB, 12 dB, 18 dB or attenuator OFF.
- ➔ Push and hold **[ATT] (MF4)** for 1 sec. to turn the attenuator function OFF.

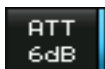

6 dB attenuation

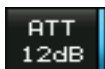

12 dB attenuation



18 dB attenuation

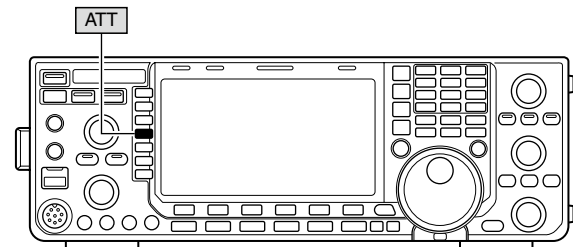

■ RIT function

The RIT (Receive Increment Tuning) function compensates for off-frequency operation of the received station.

The function shifts the receive frequency up to ± 9.999 kHz in 1 Hz steps (10 Hz steps when cancelling the 1 Hz step readout) without moving the transmit frequency.

- ① Push **[RIT]** to turn the RIT function ON and OFF.
 - “**RIT**” and the shifting frequency appear when the function is ON.
- ② Rotate the **[RIT/ Δ TX]** control.
 - Push and hold **[CLEAR]** for 1 sec. to reset the RIT frequency.
 - Push **[CLEAR]** momentarily to reset the RIT frequency when the quick RIT/ Δ TX clear function is ON. (p. 132)
 - Push and hold **[RIT]** for 1 sec. to add the shift frequency to the operating frequency.

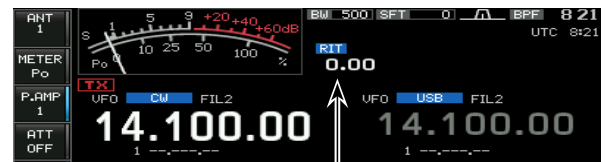
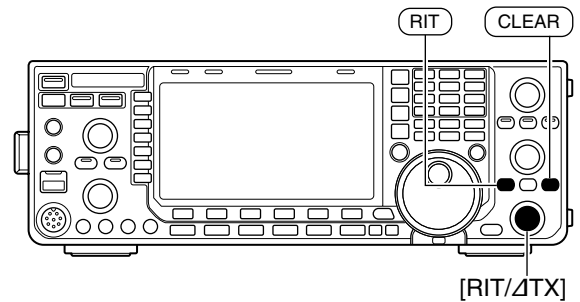

RIT shifting frequency

◇ RIT monitor function

When the RIT function is ON, pushing and holding **[XFC]** allows you to monitor the operating frequency directly (RIT is temporarily cancelled).

✓ For your convenience— Calculate function

The shift frequency of the RIT function can be added/subtracted to the displayed frequency.

- ➔ While displaying the RIT shift frequency, push and hold **[RIT]** for 1 sec.

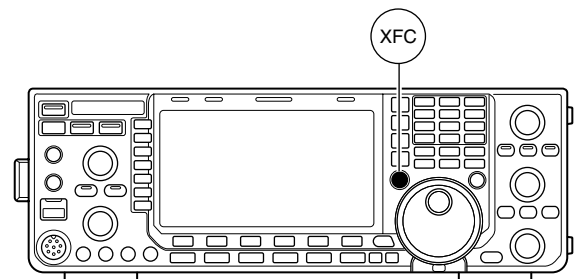

■ AGC function

The AGC (auto gain control) controls receiver gain to produce a constant audio output level even when the received signal strength varies greatly.

The transceiver has 3 preset AGC characteristics (time constant: fast, mid, slow) for non-FM mode.

▨ The FM mode AGC time constant is fixed as 'FAST' (0.1 sec.) and AGC time constant cannot be changed.

◇ Selecting the preset value

- ① Select any non-FM mode.
- ② Push **[AGC] (MF5)** several times to select AGC fast, AGC medium (MID) or AGC slow.

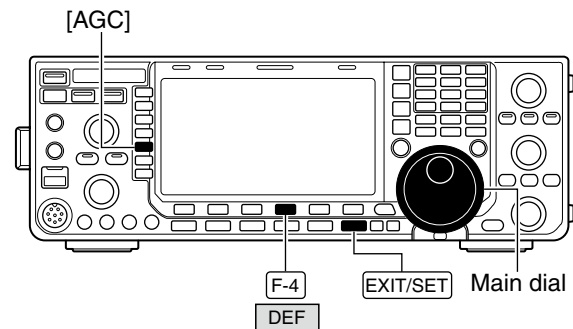

◇ Setting the AGC time constant preset value

- ① Select any non-FM mode.
- ② Push and hold **[AGC] (MF5)** for 1 sec. to enter AGC set mode.
- ③ Push **[AGC] (MF5)** several times to select FAST time constant.
 - AGC time constant can be set between 0.1 to 8.0 sec. (depends on mode) or turned OFF.
 - Push and hold **[DEF] (F-4)** for 1 sec. to select a default value.
- ④ Push **[AGC] (MF5)** to select medium time constant.
 - AGC time constant can be set between 0.1 to 8.0 sec. (depends on mode) or turned OFF.
 - Push and hold **[DEF] (F-4)** for 1 sec. to select a default value.
- ⑤ Rotate the main dial to set the desired time constant for 'AGC FAST.'
- ⑥ Rotate the main dial to set the desired time constant for 'AGC MID.'
 - AGC time constant can be set between 0.1 to 8.0 sec. (depends on mode) or turned OFF.
 - Push and hold **[DEF] (F-4)** for 1 sec. to select a default value.
- ⑦ Push **[AGC] (MF5)** to select slow time constant.
- ⑧ Rotate the main dial to set the desired time constant for 'AGC SLOW.'
 - AGC time constant can be set between 0.1 to 8.0 sec. (depends on mode) or turned OFF.
 - Push and hold **[DEF] (F-4)** for 1 sec. to select a default value.
- ⑨ Select another non-FM mode, then repeat steps ③ to ⑧ if desired.
- ⑩ Push **[EXIT/SET]** to exit the AGC set mode screen.

• AGC set mode screen



• Selectable AGC time constant (unit: sec.)

Mode	Default	Selectable AGC time constant
SSB	0.3 (FAST) 2.0 (MID) 6.0 (SLOW)	OFF, 0.1, 0.2, 0.3, 0.5, 0.8, 1.2, 1.6, 2.0, 2.5, 3.0, 4.0, 5.0, 6.0
CW	0.1 (FAST) 0.5 (MID) 1.2 (SLOW)	OFF, 0.1, 0.2, 0.3, 0.5, 0.8, 1.2, 1.6, 2.0, 2.5, 3.0, 4.0, 5.0, 6.0
RTTY PSK	0.1 (FAST) 0.5 (MID) 1.2 (SLOW)	OFF, 0.1, 0.2, 0.3, 0.5, 0.8, 1.2, 1.6, 2.0, 2.5, 3.0, 4.0, 5.0, 6.0
AM	3.0 (FAST) 5.0 (MID) 7.0 (SLOW)	OFF, 0.3, 0.5, 0.8, 1.2, 1.6, 2.0, 2.5, 3.0, 4.0, 5.0, 6.0, 7.0, 8.0
FM	0.1 (FAST)	Fixed

■ Twin PBT operation

<MODE> SSB/CW/RTTY/PSK/AM

PBT (Passband Tuning) electronically narrows the IF passband width by shifting the IF frequency slightly outside of the IF filter passband to reject interference. The IC-7600 uses DSP for the PBT function. Moving both **[TWIN-PBT]** controls to the same position shifts the IF both above and below the received frequency.

- The LCD shows the passband width and shift frequency graphically.
 - The indicator on the **[PBT-CLR]** switch lights when PBT is in use.
- Push and hold **[FILTER]** for 1 sec. to enter the filter set screen. Current passband width and shift frequency is displayed in the filter set screen.
- To set the **[TWIN-PBT]** controls to the center positions, push and hold **[PBT-CLR]** for 1 sec.

The variable range depends on the passband width and mode. The edge of the variable range is half of the passband width, and PBT is adjustable in 25 (SSB/CW/RTTY/PSK modes) or 100 Hz (AM mode) steps.

- The **[TWIN-PBT]** controls should normally be set to the center positions (PBT setting is cleared) when there is no interference.
- When PBT is used, the audio tone may be changed.
- Not available for FM mode.
- While rotating the **[TWIN-PBT]** controls, noise may occur. This comes from the DSP unit and does not indicate an equipment malfunction.
- Push and hold **[DEF]** (**F-4**) for 1 sec. to select a default value.

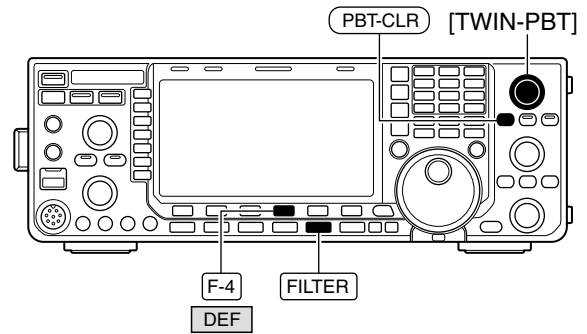

Shows filter width, shifting value and condition

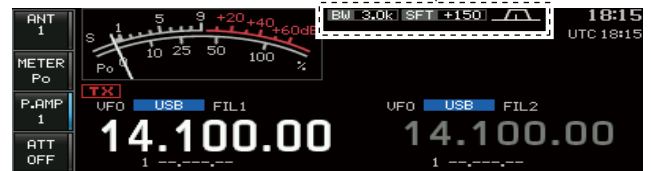

• Filter set screen



"SHARP" is selected.

• PBT operation example

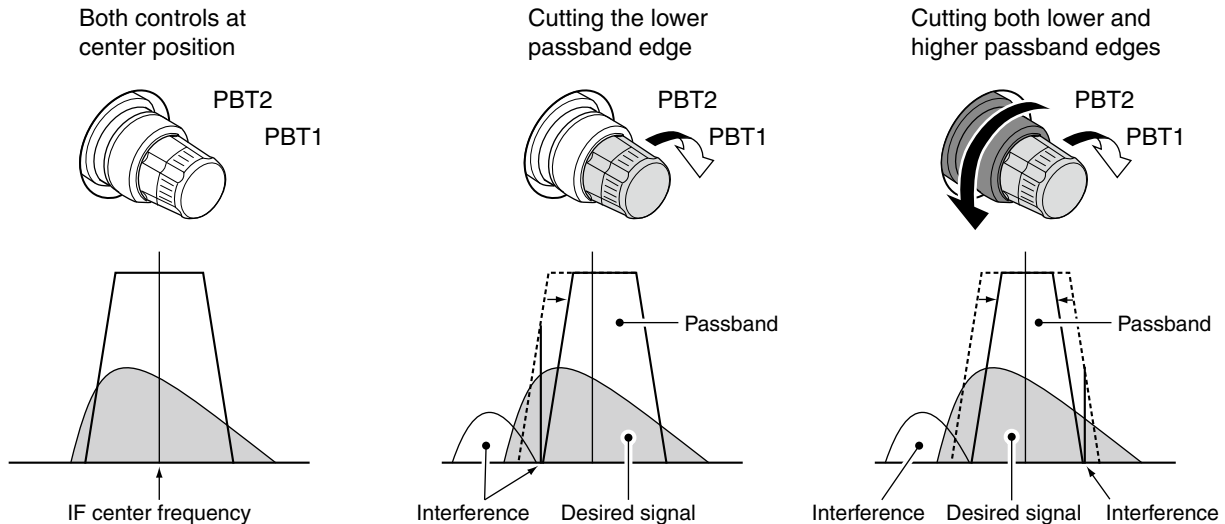

IF filter selection

The transceiver has 3 passband width IF filters for each mode.

For SSB, CW and PSK modes, the passband width can be set within 50 to 3600 Hz in 50 or 100 Hz steps. A total of 41 passband widths are available.

For RTTY mode, the passband width can be set within 50 to 2700 Hz in 50 or 100 Hz steps. A total of 32 passband widths are available.

For AM mode, the passband width can be set within 200 Hz to 10 kHz in 200 Hz steps. A total of 50 passband widths are available.

For FM mode, the passband width is fixed and 3 passband widths are available.

The filter selection is automatically memorized in each mode.
The PBT shift frequencies are automatically memorized in each filter.

IF filter selection

- ① Select the desired mode.
- ② Push **[FILTER]** several times to select the IF filter 1, 2 or 3.
 - The selected passband width and filter number is displayed in the LCD.

Filter passband width setting (except FM mode)

- ① Push and hold **[FILTER]** for 1 sec. to enter filter set screen.
- ② Select any mode except FM.
 - Passband widths for FM modes are fixed and cannot be set.
- ③ Push **[FILTER]** several times to select the desired IF filter.
- ④ Push **[BW]** (**F-1**), then rotate the main dial to adjust the desired passband width. Then push **[BW]** (**F-1**) to set.
 - While pushing and holding **[BW]** (**F-1**), rotating the main dial also adjusts the passband width. After adjustment, release **[BW]** (**F-1**) to set.
 - In SSB, CW and PSK modes, the passband width can be set within the following range.

50 to 500 Hz	50 Hz steps
600 to 3600 Hz	100 Hz steps
 - In RTTY mode, the passband width can be set within the following range.

50 to 500 Hz	50 Hz steps
600 to 2700 Hz	100 Hz steps
 - In AM mode, the passband width can be set within the following range.

200 Hz to 10 kHz	200 Hz steps
------------------	--------------
 - Push and hold **[DEF]** (**F-4**) for 1 sec. to select a default value. (Roofing filter setting also selects a default value.)
- ⑤ Repeat steps ② to ④ if desired for other modes.
- ⑥ Push **[EXIT/SET]** to exit filter set screen.

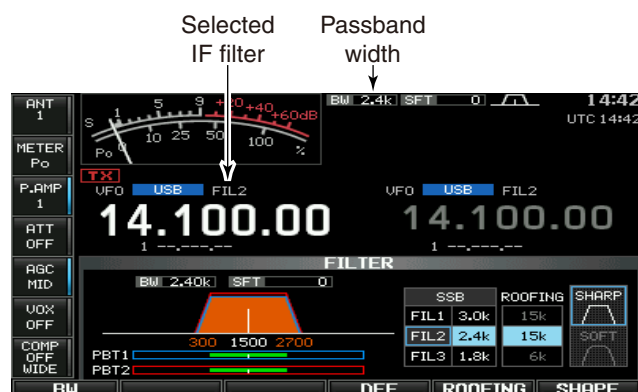
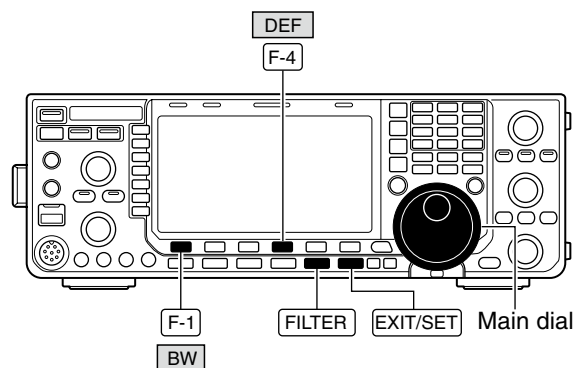

- During the passband width setting



- The PBT shift frequencies are cleared when the passband width is changed.
- This filter set screen graphically displays the PBT shift frequencies and CW pitch operations.

◆ Roofing filter selection

The IC-7600 has 3, 6 and 15 kHz roofing filters at the 1st IF frequency. The roofing filter provides interference reduction from nearby strong signals.

- ① Push and hold **[FILTER]** for 1 sec. to enter filter set screen.
- ② Select any mode except FM.
- ③ Push **[ROOFING] (F-5)** to select the desired filter width from 15 kHz, 6 kHz and 3 kHz.
 - Push and hold **[DEF] (F-4)** for 1 sec. to select a default value. (Filter passband width setting also selects a default value.)
- ④ Push **[EXIT/SET]** to exit filter set screen.

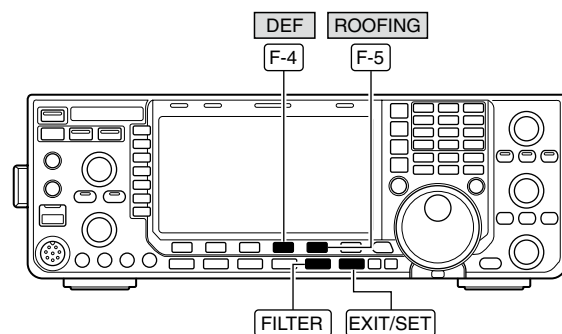

• Filter set screen

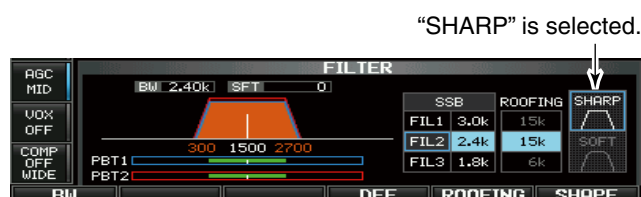

• Default roofing filter

(unit: kHz)

Mode	FIL1	FIL2	FIL3	Mode	FIL1	FIL2	FIL3
SSB	15	15	6	RTTY	15	6	6
SSB-D	6	6	6	PSK	6	6	6
CW	6	6	6	AM	15	15	15

◆ DSP filter shape

The type of DSP filter shape for each SSB, SSB data and CW can be selected independently from soft and sharp.

- ① Push and hold **[FILTER]** for 1 sec. to enter filter set screen.
- ② Select SSB, SSB data or CW mode.
- ③ Push **[SHAPE] (F-6)** several times to select the desired filter shape from soft and sharp.
- ④ Push **[EXIT/SET]** to exit filter set screen.

The filter shape can be set for each band (HF and 50 MHz bands), mode, as well as the passband width setting (CW only) independently from your default setting in filter shape set mode.

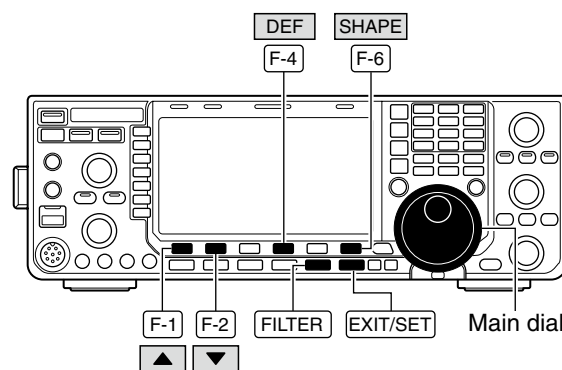

◇ Filter shape set mode

The type of DSP filter shape for SSB, SSB data and CW can be selected independently from soft and sharp.

- ① Push and hold **[FILTER]** for 1 sec. to enter filter set screen.
- ② Push and hold **[SHAPE] (F-6)** for 1 sec. to enter filter shape set mode.
- ③ Select the desired item using **[▲] (F-1)** or **[▼] (F-2)**.
- ④ Rotate the main dial to select the filter shape from soft and sharp.
 - Push and hold **[DEF] (F-4)** for 1 sec. to select a default value.
- ⑤ Push **[EXIT/SET]** to exit filter shape set mode.

• Filter shape set mode



HF SSB (600Hz -)	SHARP
Select the filter shape for SSB mode in HF bands.	▨ The set filter shape is automatically used only when the IF filter is set to 600 Hz or wider.
SSB-D (600Hz -)	SHARP
Select the filter shape for SSB data mode in HF bands.	▨ The set filter shape is automatically used only when the IF filter is set to 600 Hz or wider.
CW (- 500Hz)	SHARP
Select the filter shape for CW mode in HF bands.	▨ The set filter shape is automatically used only when the IF filter is set to 500 Hz or narrower.
CW (600Hz -)	SHARP
Select the filter shape for CW mode in HF bands.	▨ The set filter shape is automatically used only when the IF filter is set to 600 Hz or wider.
50M SSB (600Hz -)	SOFT
Select the filter shape for SSB mode in 50 MHz band.	▨ The set filter shape is automatically used only when the IF filter is set to 600 Hz or wider.
SSB-D (600Hz -)	SHARP
Select the filter shape for SSB data mode in 50 MHz band.	▨ The set filter shape is automatically used only when the IF filter is set to 600 Hz or wider.
CW (- 500Hz)	SHARP
Select the filter shape for CW mode in 50 MHz band.	▨ The set filter shape is automatically used only when the IF filter is set to 500 Hz or narrower.
CW (600Hz -)	SHARP
Select the filter shape for CW mode in 50 MHz band.	▨ The set filter shape is automatically used only when the IF filter is set to 600 Hz or wider.

■ Dualwatch operation

Dualwatch monitors 2 frequencies with the same mode simultaneously.

During dualwatch, both frequencies should be on the same band, because the bandpass filter in the RF circuit is selected for the main readout frequency.

- ① Set a desired frequency into the main band.
- ② Push and hold **[DUALWATCH]** for 1 sec.
 - “**DUAL-W**” appears.
 - The sub readout operating mode is equalized to the main readout.
 - Equalized receive frequency appears on the sub band frequency readout. This quick dualwatch function can be turned OFF in others set mode. (p. 128)
 - Pushing **[DUALWATCH]** momentarily activates the dualwatch with the previously operated frequency.
- ③ Rotate the main dial to set another desired frequency.
- ④ Push **[MAIN/SUB M.SCOPE]** to enables the sub band access when changing the frequency, etc. in sub band.
 - Push **[MAIN/SUB M.SCOPE]** again for the main band access.
- ⑤ Adjust the **[BAL]** control to set a suitable signal strength balance between the main and sub readout frequencies.
 - S-meter shows the combined signal strength.
- ⑥ To transmit on the sub readout frequency, push **[CHANGE]** or **[SPLIT]**.

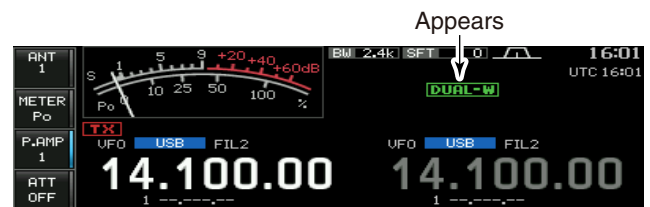
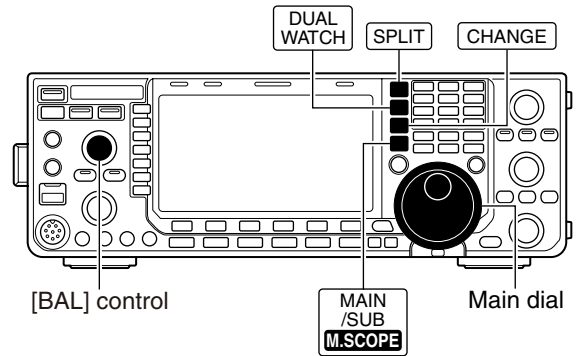

NOTE:

- A beat note may be heard depending on the frequency combination.
- The RIT function can be used for the main readout only.
- The Δ TX function can be used for the transmit readout (main readout when the split function OFF; sub readout when the split function ON).

• Scanning during dualwatch

Scanning operates only for the main readout. To operate the scan during dualwatch, scan on the main readout and use the sub readout for your QSO using both dualwatch and split frequency operation.

- ① Program the desired programmed scan edges in the same amateur band. See p. 101 for programming.
 - If you plan to operate a ΔF scan, programming the scan edges may not be necessary.
- ② Push **[SPLIT]** to turn the split frequency function ON.
 - “**SPLIT**” appears.
- ③ Select VFO mode for the main readout.
- ④ Set the desired operating frequency for the main readout.
- ⑤ Push and hold **[DUALWATCH]** for 1 sec.
 - “**DUAL-W**” appears.
 - Equalized receive frequency and operating mode appear on the sub band readout and the dualwatch function is turned ON.
- ⑥ Push **[SCAN]** (F-5) to select the scan screen.
 - Push **[EXIT/SET]** several times to close a multi-function screen, if necessary.
- ⑦ Push **[PROG]** (F-1) or **[ΔF]** (F-2) to start the programmed scan or ΔF scan, respectively.
 - Scan activates on the main readout between the programmed scan edges or within the ΔF span.
 - Transmitting on the sub readout stops the scan.
- ⑧ To cancel the scan, push **[EXIT/SET]**.

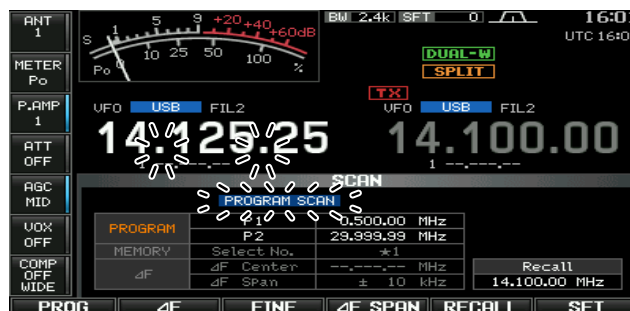
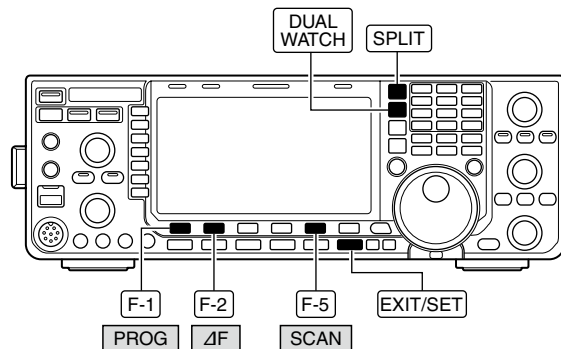

■ Noise blanker

<MODE> SSB/CW/RTTY/PSK/AM

The noise blanker eliminates pulse-type noise such as the noise from car ignitions. The noise blanker is not available for FM mode.

➔ Push **[NB]** to turn the noise blanker function ON and OFF.

- The indicator on this switch lights green when the noise blanker is ON.

⚡ When using the noise blanker, received signals may be distorted if they are excessively strong or for other types of noise than impulse. Turn the noise blanker OFF, or set the noise blanker threshold level (see below) to a shallow position in this case.

◇ NB set mode

To deal with various type of noise, attenuation level and noise blanking duration can be set in NB set mode.

- ① Push and hold **[NB]** for 1 sec. to enter NB set mode.
- ② Select the desired item using **[▲]** (F-1) or **[▼]** (F-2).
- ③ Rotate the main dial to the desired set value or condition.
 - Push and hold **[DEF]** (F-4) for 1 sec. to select a default value.
- ④ Push **[EXIT/SET]** to exit NB set mode.

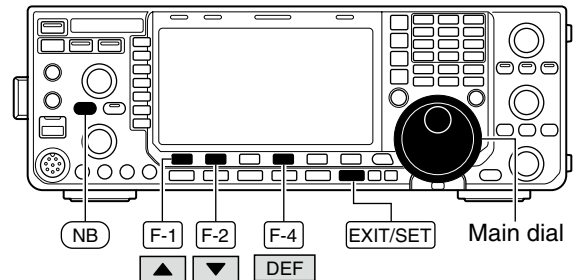

• NB set mode



NB Level 50%

Set the noise blanker threshold level from 0% to 100%.

NB Depth 8

Set the noise attenuation level from 1 to 10.

NB Width 50

Set the blanking duration from 1 to 100.

■ Noise reduction

The noise reduction function reduces random noise components and enhances desired signals which are buried in noise. The DSP performs the random noise reduction function.

- ① Push **[NR]** to turn the noise reduction ON.
 - The indicator on this switch lights green.
- ② Rotate the **[NR]** control to adjust the noise reduction level.
- ③ Push **[NR]** to turn the noise reduction OFF.
 - The indicator goes off.

Large rotations of the **[NR]** control results in audio signal masking or distortion. Set the **[NR]** control for maximum readability.

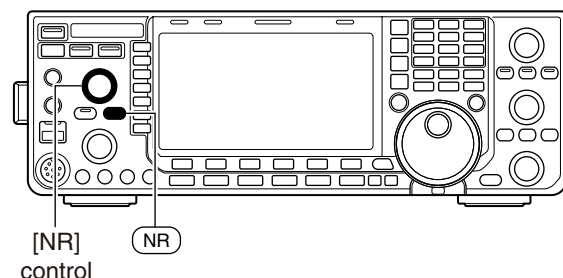

Noise reduction OFF

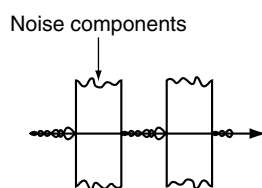

Noise reduction activated

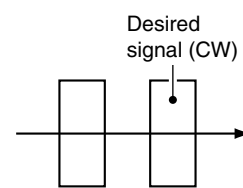

■ Dial lock function

The dial lock function prevents frequency changes by accidental movement of the tuning dial. The lock function electronically locks the dial.

- ➔ Push and hold **[SPEECH/LOCK]** for 1 sec. to toggle the dial lock function ON and OFF.
 - The **[LOCK]** indicator lights when the dial lock function is in use.
 - While split frequency operation is ON, the split lock function may be turned ON. (p. 89)

NOTE: When "LOCK/SPEECH" is selected in [[SPEECH/LOCK] Switch] item in others set mode, pushing **[SPEECH/LOCK]** activates the dial lock function. (p. 131)

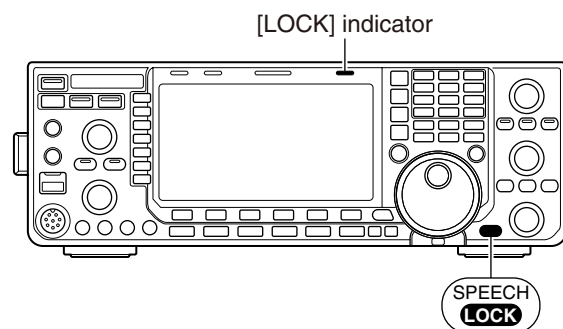

Notch function

This transceiver has auto and manual notch functions.

The auto notch function uses DSP to automatically attenuate beat tones, tuning signals, etc., even if they are moving. The manual notch can be set to attenuate a frequency via the **[NOTCH]** control.

The auto notch can be used in SSB, AM and FM mode.

The manual notch can be used in SSB, CW, RTTY, PSK and AM modes.

➔ Push **[NOTCH]** to toggle the notch function between auto, manual and OFF in SSB and AM modes.

- Either auto or manual notch function can be deactivated in others set mode. (p. 132)

➔ Push **[NOTCH]** to turn the manual notch function ON and OFF in CW, RTTY, PSK modes.

➔ Push **[NOTCH]** to turn the auto notch function ON and OFF in FM mode.

- The indicator on this switch lights green when the auto or manual notch function is ON.
- When the manual notch function is ON, push and hold **[NOTCH]** for 1 sec. to select the notch filter width for manual notch from wide, middle and narrow.
- Set to attenuate a frequency for manual notch via the **[NOTCH]** control.
- “**AN**” appears when auto notch is in use.
- “**MN**” appears when manual notch is in use.

⚡ While tuning the manual notch, noise may be heard. This comes from the DSP unit and does not indicate an equipment malfunction.

Auto tune function

<MODE> CW/AM

The automatic tuning function tunes the displayed frequency automatically when an off-frequency signal is received within the range ± 500 Hz (CW) or ± 5 kHz (AM). This function is active while in CW or AM mode is selected.

➔ Push **[AUTO TUNE]** to toggle the auto tune function ON or OFF.

- “**AUTOTUNE**” blinks when auto tune function is activated.
- After 2 sec. has passed, the auto tune function stops tuning automatically even it's still off-frequency.

⚡ IMPORTANT!

When receiving a weak signal, or receiving a signal with interference, the automatic tuning function may tune the receiver to an undesired signal.

⚡ **NOTE:** The automatic tuning function does not active on the sub band.

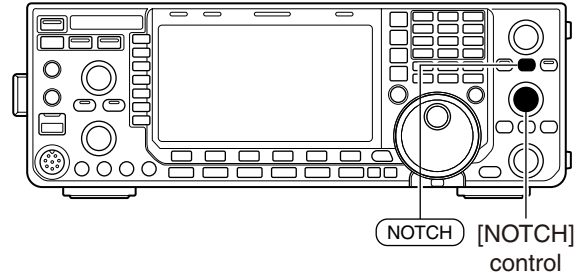

• Auto notch indication

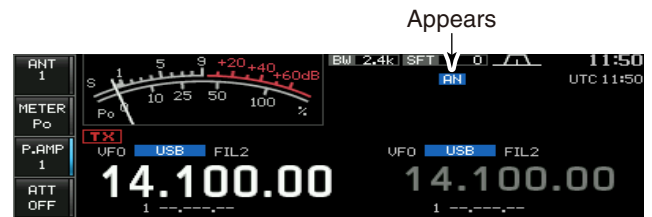

• Manual notch indication

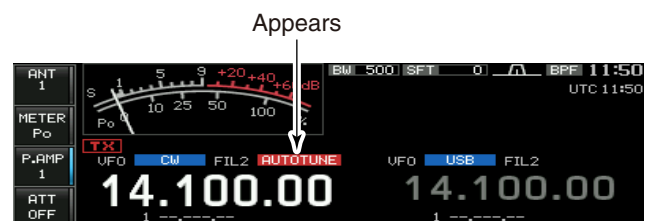
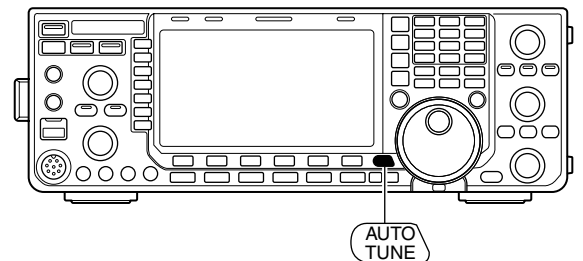
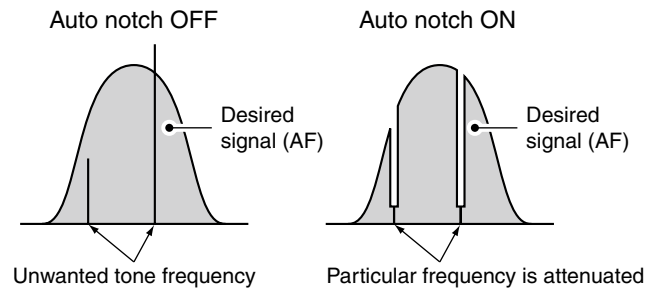
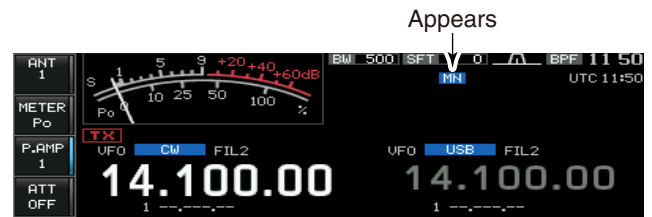

■ VOX function

<MODE> SSB/AM/FM

The VOX (Voice-Operated Transmission) function switches between transmit and receive with your voice. This function provides “hands-free” operation.

◇ Using the VOX function

- ① Select a phone mode (SSB, AM, FM).
- ② Push **[VOX] (MF6)** to turn the VOX function ON or OFF.
 - “VOX” appears while the VOX is in use.

◇ Adjusting the VOX function



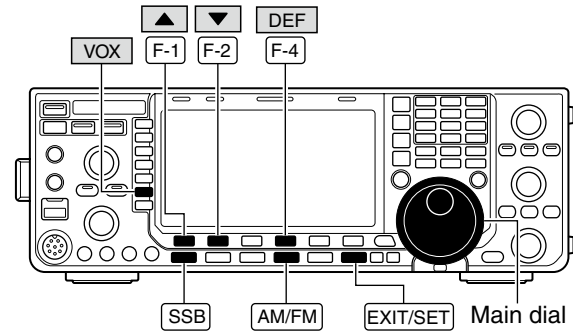

- ① Push **[SSB]** or **[AM/FM]** to select a phone mode (SSB, AM, FM).
- ② Push and hold **[VOX] (MF6)** for 1 sec. to enter VOX set mode.
- ③ Select the VOX gain item using **[▲] (F-1)** or **[▼] (F-2)**.
- ④ While speaking into the microphone, rotate the main dial to the point where the transceiver is continuously transmitting.
- ⑤ If the receive audio from the speaker causes the VOX circuit to switch to, adjust the anti-VOX setting to the point where speaker audio does not activate the VOX.
 - Select the Anti-VOX item using **[▲] (F-1)** or **[▼] (F-2)**.
 - Rotate the main dial.
- ⑥ Adjust the VOX delay for a convenient interval before returning to receive.
- ⑦ Set the VOX voice delay if desired.
- ⑧ Push **[EXIT/SET]** to exit VOX set mode.



• VOX set mode screen



Push and hold for 1 sec. to select a default value.

VOX Gain	 50%
This item adjusts the VOX gain for the VOX function. Higher values make the VOX function more sensitive to your voice.	This setting can be adjusted from 0% to 100% in 1% steps.
Anti-VOX	 50%
This item adjusts the ANTI-VOX gain for the VOX function. Higher values make the VOX function less sensitive to receiver output audio from a speaker or headphones.	This setting can be adjusted from 0% to 100% in 1% steps.
VOX Delay	 0.2s
Set the VOX delay for a convenient interval before returning to receive within 0.0 to 2.0 sec. range.	
VOX Voice Delay	OFF
Set the VOX voice delay to prevent clipping of the first few syllables of a transmission when switching to transmit. OFF, Short, Mid and Long settings are available.	 When using the VOX voice delay, turn the TX monitor function OFF to prevent transmitted audio from be echoed.

■ Break-in function

<MODE> CW

The break-in function is used in CW mode to automatically toggle the transceiver between transmit and receive when keying. The IC-7600 is capable of full break-in or semi break-in.

◇ Semi break-in operation

During semi break-in operation, the transceiver immediately transmits when keying, then returns to receive after a pre-set delay time has passed from when you stop keying.

- ① Push **[CW]** to select CW or CW-R mode.
- ② Push **[BK-IN] (MF6)** once or twice to turn the semi break-in function ON.
 - “BKIN” appears.
- ③ Rotate **[BK-IN DELAY]** to set the break-in delay time (the delay from transmit to receive).

▨ When using a paddle, rotate **[KEY SPEED]** to adjust the keying speed.

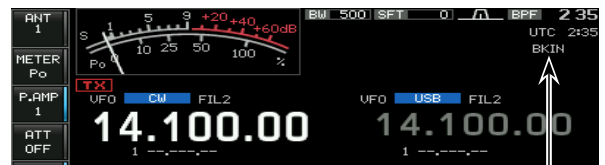
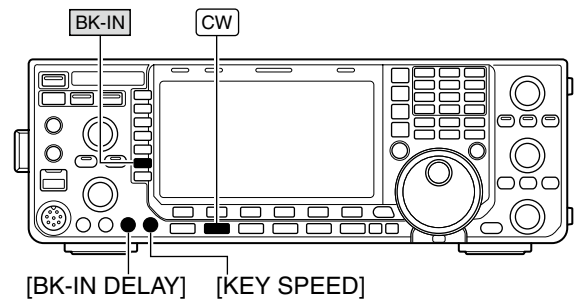

Appears

◇ Full break-in operation

During full break-in operation, the transceiver immediately transmits when keying, then returns to receive after you stop keying.

- ① Push **[CW]** to select CW or CW-R mode.
- ② Push **[BK-IN] (MF6)** once or twice to turn the full break-in function ON.
 - “F-BKIN” appears.

▨ When using a paddle, rotate **[KEY SPEED]** to adjust the keying speed.

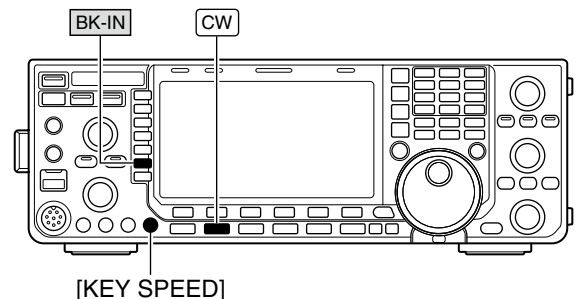

Appears

■ Speech compressor

<MODE> SSB

The speech compressor increases average RF output power, improving signal strength and readability.

- ① Push **[SSB]** to select USB or LSB mode.
- ② Push and hold **[COMP] (MF7)** for 1 sec. to select COMP TBW set screen.
- ③ Adjust the **[MIC GAIN]** control so that the ALC meter reads within the ALC zone, whether or not you speak softly or loudly.
- ④ Push **[COMP] (MF7)** to turn the speech compressor ON.
- ⑤ While speaking into the microphone, rotate the main dial, so that the COMP meter reads within the COMP zone (10 to 20 dB range) for your normal voice level.
 - ▨ When the COMP meter peaks exceed 20 dB, your transmitted voice may be distorted.
- ⑥ Push **[COMP] (MF7)** or **[EXIT/SET]** to exit COMP TBW set screen.
- ⑦ Adjust the drive gain to set the ALC meter reading within the 30 to 50% range of the ALC scale. (p. 37)

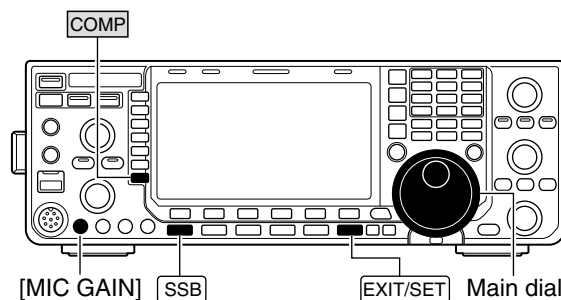

• COMP/TBW set screen

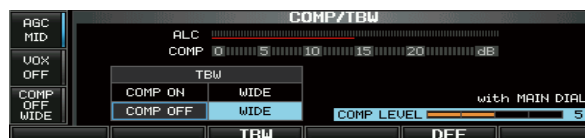

Speech compressor is OFF



Speech compressor is ON

■ Transmit filter width setting

<MODE> SSB

The transmit filter width for SSB mode can be selected from wide, middle and narrow.

- ① Push **[SSB]** to select USB or LSB mode.
- ② Push and hold **[COMP] (MF7)** for 1 sec. to select COMP TBW set screen.
- ③ Push **[COMP] (MF7)** to turn the speech compressor ON or OFF.
- ④ Push **[TBW] (F-3)** several times to select the desired transmit filter width from wide, middle and narrow.
 - The filter can be independently set on the speech compressor function is ON and OFF.
 - The following filters are specified as the default. Each of the filter width can be re-set in level set mode. (p. 122)
 - WIDE : 100 Hz to 2.9 kHz
 - MID : 300 Hz to 2.7 kHz
 - NAR : 500 Hz to 2.5 kHz
- ⑤ Push **[COMP] (MF7)** or **[EXIT/SET]** to exit COMP TBW set screen.

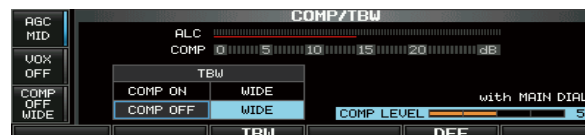
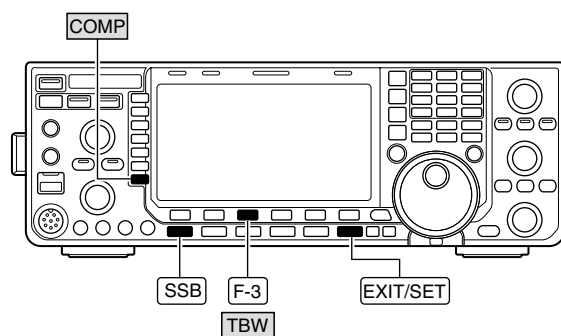

"WIDE" setting

■ Δ TX function

The Δ TX function shifts the transmit frequency up to ± 9.999 kHz in 1 Hz steps (10 Hz steps when canceling the 1 Hz step readout) without moving the receive frequency.

- ① Push [**Δ TX**] to turn Δ TX function ON.
 - “ **Δ TX**” and the shifting frequency appear when the function is ON.
- ② Rotate the [**RIT/ Δ TX**] control.
- ③ To reset the Δ TX frequency, push and hold [**CLEAR**] for 1 sec.
 - Push [**CLEAR**] momentarily to reset the Δ TX frequency when the quick RIT/ Δ TX clear function is ON. (p. 132)
- ④ To cancel the Δ TX function, push [**Δ TX**] again.
 - “ **Δ TX**” and the shifting frequency disappears.

When RIT and Δ TX are ON at the same time, the [**RIT/ Δ TX**] control shifts both the transmit and receive frequencies from the displayed frequency at the same time.

◇ Δ TX monitor function

When the Δ TX function is ON, pushing and holding [**XFC**] allows you to monitor the operating frequency directly.

✓ For your convenience— Calculate function

The shift frequency of the Δ TX function can be added/subtracted to the displayed frequency.

While displaying the Δ TX shift frequency, push and hold [**Δ TX**] for 1 sec.

■ Monitor function

The monitor function allows you to monitor your transmit IF signals in any mode. Use this to check voice characteristics while adjusting SSB transmit parameter (p. 121).

The CW sidetone functions regardless of the [**MONITOR**] switch setting.

- ① Push [**MONITOR**] to turn the monitor function ON and OFF.
 - The indicator on this switch lights green when the monitor function is ON.
- ② Push and hold [**MONITOR**] to monitor set mode.
- ③ Rotate the main dial to adjust the monitor level.
 - Push and hold [**DEF**] (**F-4**) for 1 sec. to select a default value.
- ④ Push [**EXIT/SET**] to exit monitor set mode.

NOTE: When using the VOX voice delay, turn the monitor function OFF; or transmitted audio will be echoed.

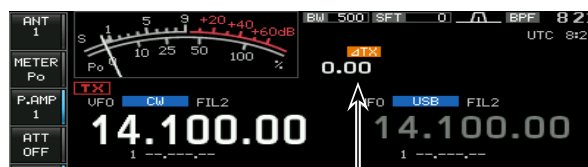
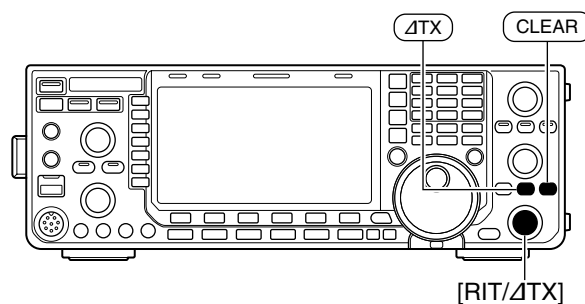

Appears

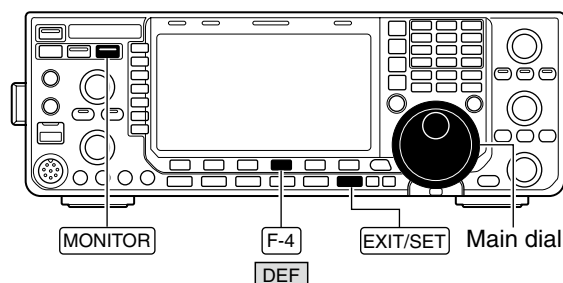
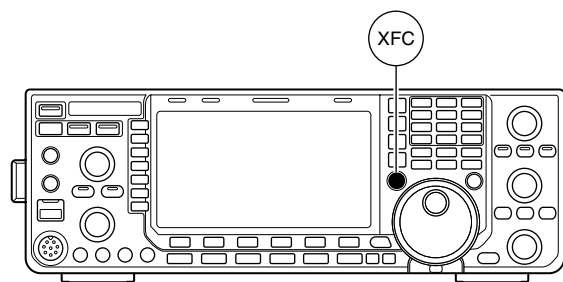

• Monitor set mode

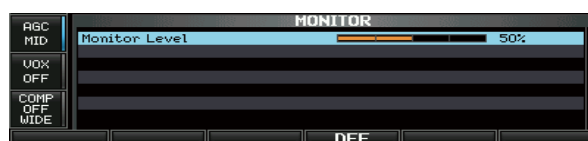

■ Split frequency operation

Split frequency operation allows you to transmit and receive in the same mode on two different frequencies. Split frequency operation is performed using 2 frequencies on the main and sub readouts.

The following is an example of setting 21.290 MHz for receiving and 21.310 MHz for transmitting.

- ① Set 21.290 MHz (USB) in VFO mode.
- ② Push **[SPLIT]**, then push and hold **[CHANGE]** for 1 sec.
 - The quick split function is much more convenient for selecting the transmit frequency. See the next section for details.
 - The equalized transmit frequency and “**SPLIT**” appear on the LCD.
 - **[SPLIT]** indicator lights.
 - “**TX**” appears to show the transmit frequency readout.
- ③ While pushing and holding **[XFC]**, rotate the main dial to set the transmit frequency to 21.310 MHz.
 - The transmit frequency can be monitored while pushing **[XFC]**.
- ④ Now you can receive on 21.290 MHz and transmit on 21.310 MHz.

To change the transmit and receive frequencies, push **[CHANGE]** to exchange the main and sub readouts.

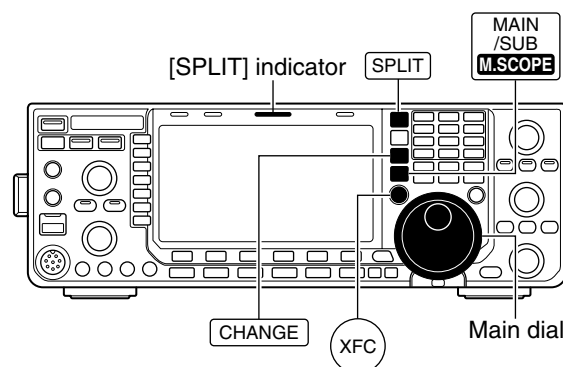

• When the split function ON

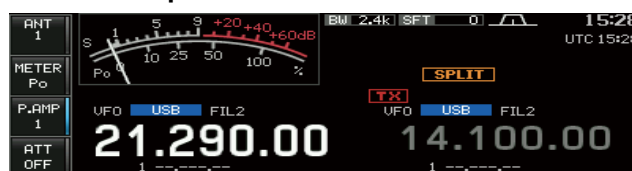

• When [XFC] is pushed

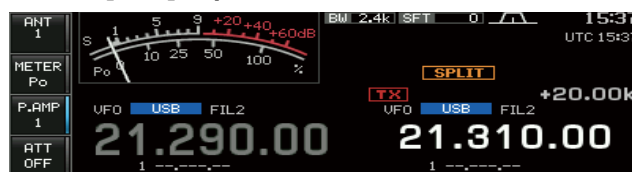

• The split frequency operation is ready

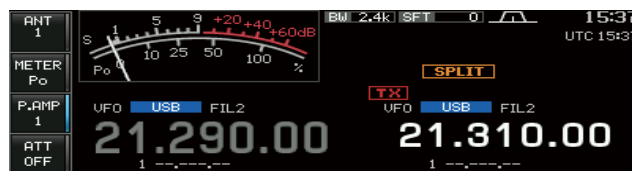

✓ CONVENIENT

• Direct shift frequency input

The shift frequency can be entered directly.

- ① Push **[F-INP ENT]**.
- ② Enter the desired shift frequency with the digit keys.
 - 1 kHz to 9.999 MHz can be set.
 - When you require a negative shift direction, push **[GENE •]** in advance.
- ③ Push **[SPLIT]** to input the shift frequency in the sub readout and the split function is turned ON.

• Dualwatch function

The dualwatch function is convenient for tuning the transmit frequency while monitoring both frequencies used for transmitting and receiving.

• Split lock function (p. 129)

Accidentally releasing **[XFC]** while rotating the main dial changes the receive frequency. To prevent this, use both the split lock and dial lock functions to change the transmit frequency only. The split lock function cancels the dial lock function while pushing **[XFC]** during split frequency operation.

The split lock function is OFF by default, but can be turned ON in others set mode.

■ Quick split function

When you find a DX station, an important consideration is how to set the split frequency.

When you push and hold the **[SPLIT]** switch for 1 sec., the split frequency operation is turned ON, and the sub readout frequency and operating mode is equalized to the main readout, then enters standby for transmit frequency input.

This shortens the time needed to begin split frequency operation.

The quick split function is ON by default. For your convenience, it can be turned OFF in others set mode. (p. 129) In this case, the **[SPLIT]** switch does not equalize the main and sub readout frequencies.

- ① Suppose you are operating at 21.290 MHz (USB) in VFO mode.
- ② Push and hold **[SPLIT]** for 1 sec.
 - Split frequency operation is turned ON.
 - **[SPLIT]** indicator lights.
 - The sub readout frequency and operating mode is equalized to the main readout.
 - The sub readout enters standby for transmit frequency input and "**F-INP**" appears.
 - During FM mode operation, the sub readout frequency shifts from the main readout frequency according to the others set mode setting. (p. 129)
 - The tone encoder function is turned ON in FM mode.
- ③ Rotate the main dial to set the transmit frequency; or, input the transmit frequency using the keypad and **[F-INP ENT]**; or, input a shift frequency using the keypad and **[SPLIT]**.
 - "**F-INP**" disappears when **[F-INP ENT]** is pushed.
 - Offset frequency setting with the keypad and **[SPLIT]**.
[Example]
To transmit on 1 kHz higher frequency:
- Push **[1.8 1]** then **[SPLIT]**.
To transmit on 3 kHz lower frequency:
- Push **[GENE •]**, **[7 3]** then **[SPLIT]**.

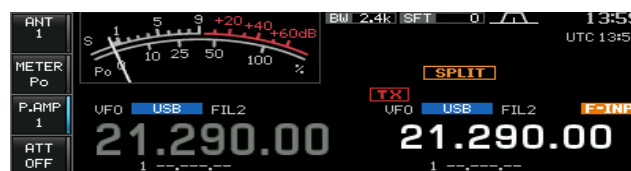
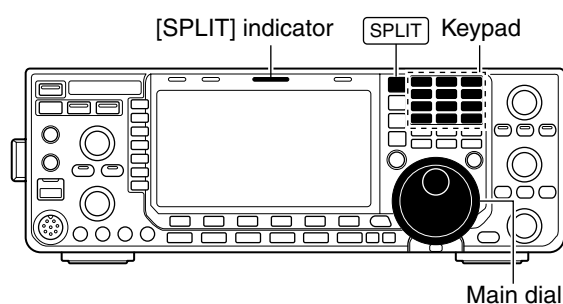

◇ Split lock function

The split lock function is convenient for changing only the transmit frequency. When the split lock function is not used, accidentally releasing **[XFC]** while rotating the main dial, changes the receive frequency. The split lock function is OFF by default, but can be turned ON in others set mode. (p. 129)

- ① While split frequency operation is ON, push and hold **[SPEECH/LOCK]** for 1 sec. to activate the split lock function.
 - **[LOCK]** indicator lights.
- ② While pushing and holding **[XFC]**, rotate the main dial to change the transmit frequency.
 - If you accidentally release **[XFC]** while rotating the main dial, the receive frequency does NOT change.

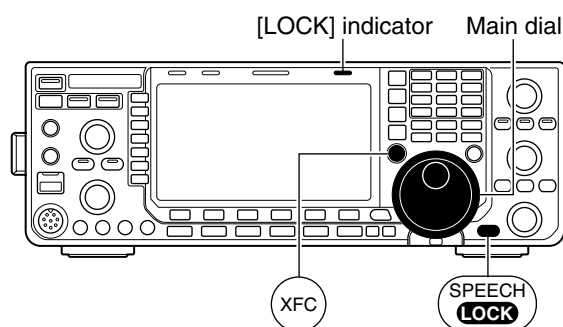

About digital voice recorder

The IC-7600 has digital voice memories, up to 4 messages for transmit, and up to 20 messages for receive.

A maximum message length of 30 sec. can be recorded into receive memory (total message length for all channels of up to 209 sec.) and a total message length of up to 99 sec. can be recorded in transmit memory.

The transmit memory is very convenient for repeated CQ and exchange transmissions in contests, as well as when making repeated calls to DX'peditions.

- ① Select any mode.
- ② Push **[VOICE]** (F-2) to display voice recorder screen.
- ③ Push **[EXIT/SET]** to display voice recorder menu.
- ④ Push **[PLAY]** (F-1) or **[MIC REC]** (F-2) to select the desired memory channel screen, then record audio or playback the contents.
- ⑤ Push **[EXIT/SET]** twice to exit voice recorder screen.

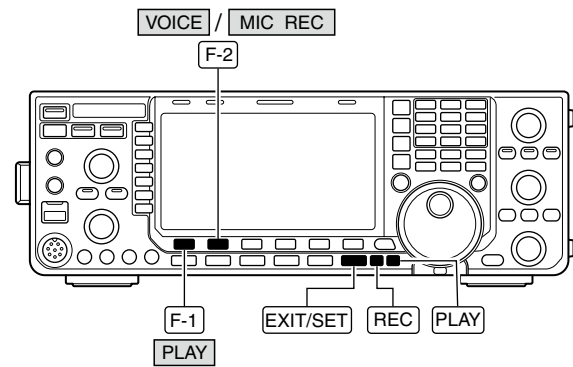

4
5

About recording received audio and playing back the contents

• Example— When [REC] is pushed and held for 1 sec.

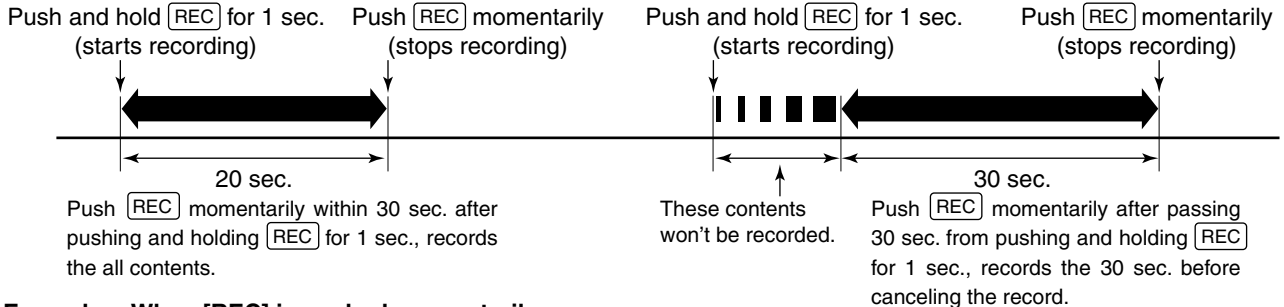

• Example— When [REC] is pushed momentarily

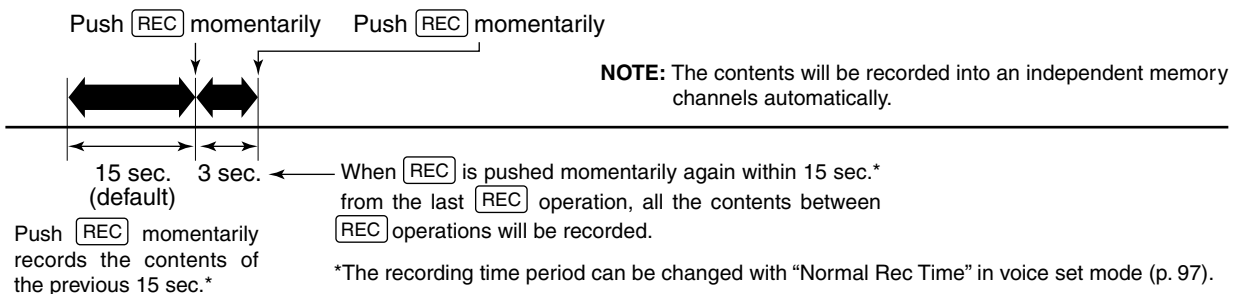

• Playing back the all contents in a channel

Push **[PLAY]** (F-3) momentarily.
Or, push and hold **[PLAY]** for 1 sec.

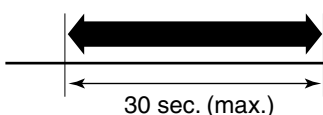

• Playing back the end of 5 sec.* in a channel

Push **[PLAY]** momentarily.

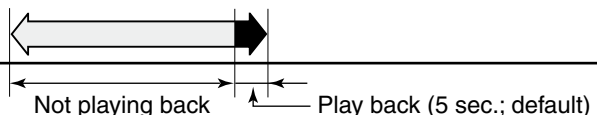

*The playing back time period can be changed with "Short Play Time" in voice set mode (p. 97).

■ Recording a received audio

Up to 20 receive voice memories are available in the IC-7600. A total of 209 sec. of audio can be recorded in receive messages. However, the maximum recordable length of a single message is 30 sec.

This voice recorder records not only the received audio, but also the information such as set operating frequency, mode, and the recording time for your future reference.

◇ Basic recording

- ① Push **[EXIT/SET]** several times to close a multi-function screen, if necessary.
- ② Select the desired mode.
- ③ Push **[VOICE] (F-2)** to call up the voice recorder screen.
 - Previously selected screen, TX or RX memory, is displayed. If the TX memory channel (T1–T4) appears, push **[T/R] (F-6)** to select RX memory channel.
- ④ Push and hold **[REC]** for 1 sec. to start recording.
 - The operating frequency, mode and current time are programmed as the memory names automatically.
- ⑤ Push **[REC]** momentarily to stop recording.

IMPORTANT!

Push **[REC]** to stop recording before, or when 30 sec. has elapsed from the start of recording.

The voice recorder memory records 30 sec. (max.) of audio before **[REC]** is pushed.

For example, when recording 40 sec. of audio, the first 10 sec. audio will be over-written with the last 10 sec., so that the total of audio recorded is only 30 sec.

When you record the 21st audio message, or when the total audio length exceeds 209 sec., the oldest recorded audio is automatically erased to make room for the new audio.

- ⑥ Push **[EXIT/SET]** twice to exit the voice recorder screen.

NOTE: When transmit (or **[PTT]** is pushed) while recording, no audio will be recorded.

◇ One-touch recording

To record the received signal immediately, one-touch voice recording is available.

- ➔ Push **[REC]** momentarily to store the previous 15 sec. audio.
 - The recordable time period can be set in voice set mode. (p. 97)

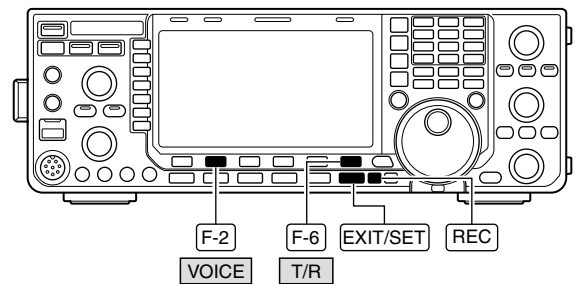

The remaining time for recording is indicated.

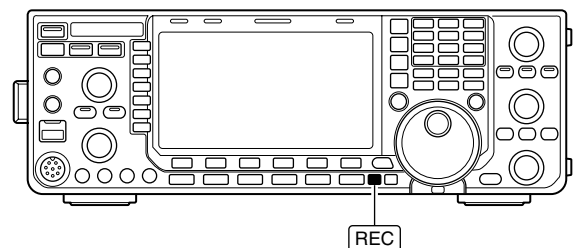

■ Playing the recorded audio

◇ Basic playing

- ① Push **[EXIT/SET]** several times to close a multi-function screen, if necessary.
- ② Push **[VOICE] (F-2)** to call up the voice recorder screen.
 - Previously selected screen, TX or RX memory, is displayed. If the TX memory message (T1–T4) appears, push **[T/R] (F-6)** to select RX memory message.
- ③ Push **[▲] (F-1)** or **[▼] (F-2)** to select the desired voice memory to playback.
- ④ Push **[PLAY] (F-3)** to start playback.
 - “▶PLAY” indicators appear and the timer counts down.
- ⑤ Push **[PLAY] (F-3)** again to stop playback if desired.
 - Playback is terminated automatically when all of the recorded contents in the message are played.
- ⑥ Push **[EXIT/SET]** twice to exit the voice recorder screen.

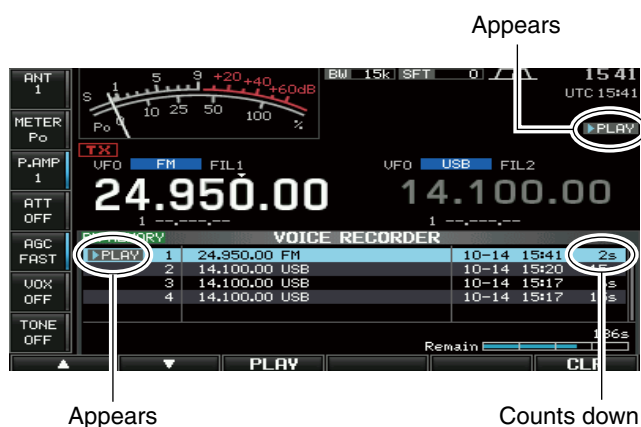
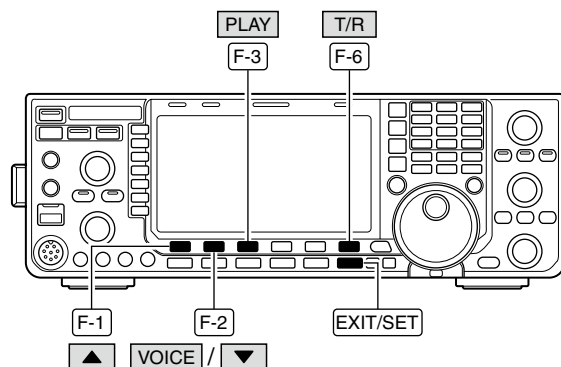

◇ One-touch playing

The previously recorded audio in message 1 can be played back without selecting voice recorder screen.

- ➔ Push **[PLAY]** momentarily to playback the last 5 sec. of the previously recorded audio.
 - To playback all contents of the previously recorded audio, push and hold **[PLAY]** for 1 sec.
 - “▶PLAY” indicator appears.
 - Playback is terminated automatically when all of the recorded contents in the message are played, or after 5 sec.
 - The playback time period can be set in voice set mode. (p. 97)

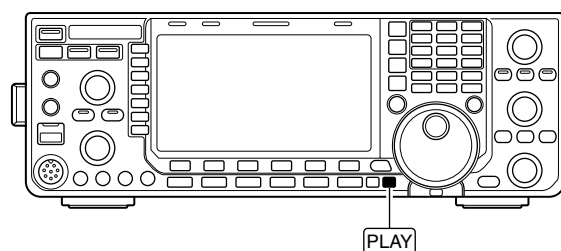

■ Protect the recorded contents

The protect function is available to protect the recorded contents from accidental erasure, such as over-writing, etc.

- ① Call up the voice recorder screen, RX memory.
- ② Push **[▲] (F-1)** or **[▼] (F-2)** to select the desired voice message.
- ③ Push **[PROTECT] (F-4)** to turn the protect function ON and OFF.
 - “” indicator appears when the contents is protected.
- ④ Push **[EXIT/SET]** twice to exit the voice recorder screen.

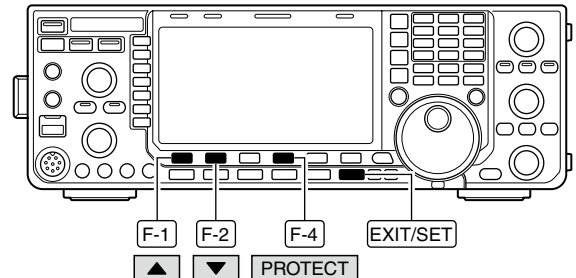

■ Erasing the recorded contents

The recorded contents can be erased independently by message.

- ① Call up the voice recorder screen, RX memory.
- ② Push **[▲] (F-1)** or **[▼] (F-2)** to select the desired voice message to be erased.
- ③ Push **[PLAY] (F-3)** to start playback.
 - “PLAY” indicators appear and the timer counts down.
- ④ Push and hold **[CLR] (F-6)** for 1 sec. to erase the contents.
 - Push **[PROTECT] (F-4)** to release the protection in advance if necessary.
- ⑤ Push **[EXIT/SET]** twice to exit the voice recorder screen.

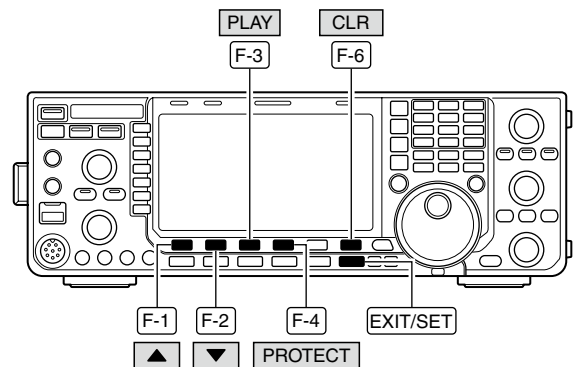

■ Recording a message for transmit

To transmit a message using the voice recorder, record the desired message in advance as described below.

The IC-7600 has digital voice memories for transmission, up to 4 messages and a total message length of up to 99 sec. can be recorded.

◇ Recording

- ① Push **[EXIT/SET]** several times to close a multi-function screen, if necessary.
- ② Push **[VOICE] (F-2)** to call up the voice recorder screen.
- ③ Push **[EXIT/SET]** to select voice recorder menu.
- ④ Push **[MIC REC] (F-2)** to select the voice mic. record screen.
- ⑤ Push **[▲] (F-1)** or **[▼] (F-2)** to select the desired message.
- ⑥ While speaking into the microphone with your normal voice level, adjust the **[MIC GAIN]** control so that the **[MIC-REC LEVEL]** indicator reads within 100%.
- ⑦ Push and hold **[REC] (F-4)** for 1 sec. to start recording.
 - “**REC**” indicator appears.
 - Speak into the microphone without pushing **[PTT]**.
 - Previously recorded contents are cleared.
 - Audio output from the internal speaker is automatically muted.
- ⑧ Push **[REC] (F-4)** momentarily to stop recording.
 - The recording is terminated automatically when the remaining time becomes 0 sec.
- ⑨ Push **[EXIT/SET]** twice to exit the voice recorder screen.

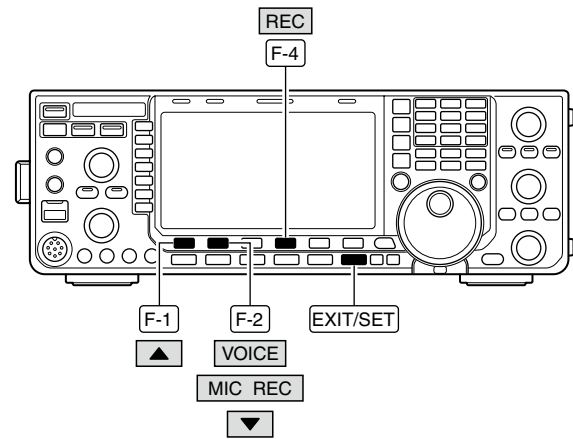

Appears Adjust **[MIC GAIN]** control so that this indicator reads within 100%.

◇ Confirming a message for transmit

- ① Perform the steps ① to ④ as “◇ Recording” above.
- ② Push **[▲] (F-1)** or **[▼] (F-2)** to select the desired message.
- ③ Push **[PLAY] (F-3)** to playback the recorded contents.
 - “**PLAY**” indicator appears.
 - Push and hold **[CLR] (F-6)** for 1 sec. to erase the contents.
- ④ Push **[PLAY] (F-3)** again to stop playback.
 - Playback is terminated automatically when all of the recorded contents in the message are played.
- ⑤ Push **[EXIT/SET]** twice to exit the voice recorder screen.

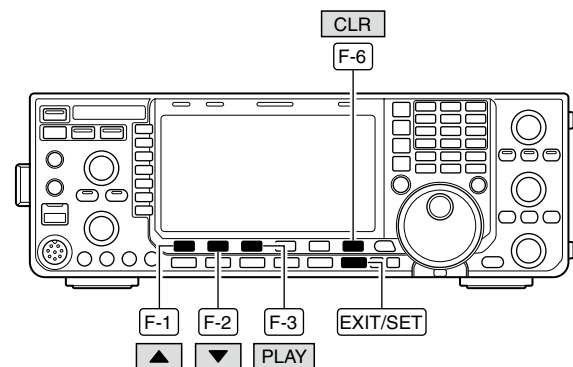

■ Programming a memory name

Memory messages can be tagged with alphanumeric names of up to 30 characters each.

Capital letters, small letters, numerals, some symbols (! # \$ % & ¥ ? " ' ` ^ + - * / . , ; = < > () [] { } | _ - @) and spaces can be used. (See the table below.)

- ① Record a message as described in page 94.
- ② During the voice mic. record screen indication, push **[NAME] (F-5)** to enter memory name edit condition.
 - A cursor appears and blinks.
- ③ Push **[T1..T4] (F-6)** several times to select the desired voice message.
 - A cursor appears and blinks.
- ④ Input the desired character by rotating the main dial or by pushing the band key for number input.
 - Push **[ABC] (MF6)** or **[abc] (MF6)** to toggle capital and small letters.
 - Push **[123] (MF7)** or **[Symbol] (MF7)** to toggle numerals and symbols.
 - Push **[◀] (F-1)** or **[▶] (F-2)** for cursor movement.
 - Push **[DEL] (F-3)** to delete the selected character.
 - Push **[SPACE] (F-4)** to input a space.
 - Pushing the transceiver's keypad, [0]–[9] and [.] can also enter numerals.
- ⑤ Push **[EXIT/SET]** to input and set the name.
 - The cursor disappears.
- ⑥ Repeat steps ③ to ⑤ to program another voice message's name, if desired.
- ⑦ Push **[EXIT/SET]** twice to exit the voice recorder screen.

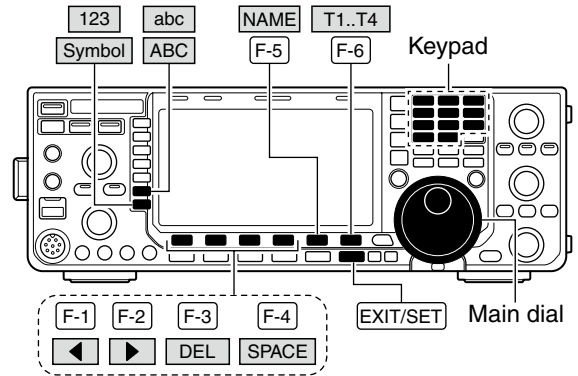

• Voice mic. record screen



• Usable characters

Key selection	Editable characters
ABC	A to Z (capital letters)
abc	a to z (small letters)
123	0 to 9 (numerals)
Symbol	! # \$ % & ¥ ? " ' ` ^ + - * / . , ; = < > () [] { } _ - @

✓ For your convenience

When a PC keyboard is connected to [USB] (A) connector on the front panel, the memory name can also be edited from the keyboard.

Voice memory name editing example

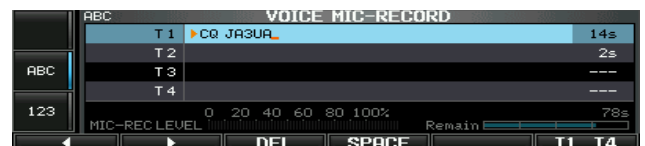

■ Sending a recorded message

- ① Push **[EXIT/SET]** several times to close a multi-function screen, if necessary.
- ② Select a phone mode by pushing **[SSB]** or **[AM/FM]**.
- ③ Push **[VOICE] (F-2)** to call up the voice recorder screen.
 - If the receive voice message appears, push **[T/R] (F-6)** to select TX message (T1–T4).
- ④ Push the desired message switch, **[T1] (F-1)** to **[T4] (F-4)**, momentarily to transmit the contents.
 - The transceiver transmits automatically.
 - “**SEND**” indicator appears and the memory timer counts down.
 - You hear the transmitted message from the speaker as the default. This can be turned OFF in voice set mode. (p. 97)
- ⑤ Push the selected message switch, **[T1] (F-1)** to **[T4] (F-4)**, again to stop, if desired.
 - The transceiver returns to receive automatically when all of the recorded contents in the message are transmitted.
- ⑥ Push **[EXIT/SET]** twice to exit the voice memory screen.

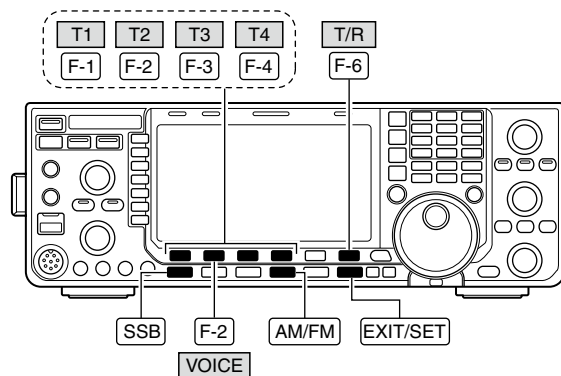

Appears

Counts down

For your information

When an external keypad is connected to [MIC] connector on the front panel, or one of [F1]–[F4] key of the keyboard that is connected to the [USB] (A) connector on the front panel is pushed, the recorded message, T1–T4, can be transmitted without opening the voice recorder screen.

See pages 18, 133, 134 for details.

◇ Transmit level setting

- ① Call up the voice recorder screen as described as above.
- ② Push **[TX LEV.] (F-5)** to select the voice memory transmit level set condition.
- ③ Push the desired message switch, **[T1] (F-1)** to **[T4] (F-4)**, momentarily to transmit the contents.
 - The transceiver transmits automatically.
 - “**SEND**” indicator appears and the memory timer counts down.
- ④ Rotate the main dial to adjust the transmit voice level.
 - Push and hold **[DEF] (F-6)** for 1 sec. to select the default condition.
- ⑤ Push **[EXIT/SET]** to return to the voice recorder screen.

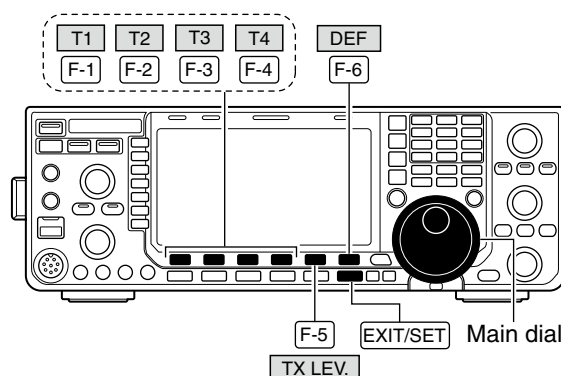

Appears

Adjust the transmit voice level from 0 to 100 %.

■ Voice set mode

Sets the automatic monitor function, short play and normal recording times for voice recorder.

- ① Push **[EXIT/SET]** several times to close a multi-function screen, if necessary.
- ② Push **[VOICE] (F-2)** to call up the voice recorder screen.
- ③ Push **[EXIT/SET]** to select voice recorder menu.
- ④ Push **[SET] (F-6)** to select voice set mode screen.
- ⑤ Push **[▲] (F-1)** or **[▼] (F-2)** to select the desired item.
- ⑥ Rotate the main dial to set the desired condition or value.
 - Push and hold **[DEF] (F-4)** for 1 sec. to select the default condition or value.
- ⑦ Push **[EXIT/SET]** to exit the voice set mode screen.

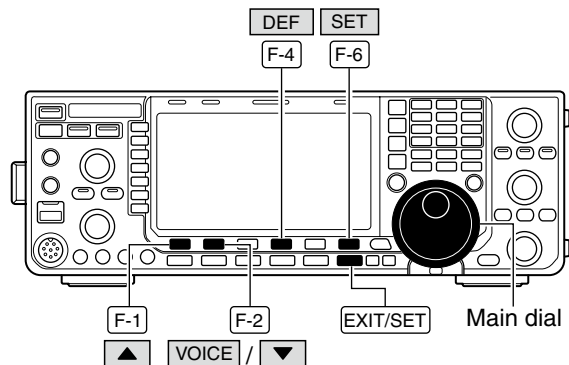

Auto Monitor	ON
Turn on the automatic monitor function for recorded audio contents transmission.	<ul style="list-style-type: none"> • ON : Monitors transmit audio automatically when sending a recorded audio. • OFF : Monitors transmit audio only when the monitor function is in use.
Short Play Time	5s
Set the desired time period for one-touch playback (when [PLAY] is pushed momentarily).	<ul style="list-style-type: none"> • 3 to 10 sec. in 1 sec. steps can be set. (default: 5 sec.)
Normal Rec Time	15s
Set the desired time period for one-touch recording (when [REC] is pushed momentarily).	<ul style="list-style-type: none"> • 5 to 15 sec. in 1 sec. steps can be set. (default: 15 sec.)

■ Saving a voice message into the USB-Memory

◇ Saving the received audio memory

The recorded RX memory contents can be saved into the USB-Memory.

- ① During voice recorder RX memory screen display, push **[SAVE] (F-5)** to select voice file save screen.
 - Previously selected screen, TX or RX memory, is displayed. If the TX message (T1–T4) appears, push **[T/R] (F-6)** to select RX message.
- ② Change the following conditions if desired.

• File name:

- 1 Push **[EDIT] (F-4)** to select file name edit condition.
 - Push **[DIR/FILE] (F-1)** several times to select the file name, if necessary.
- 2 Push **[ABC] (MF6)**, **[123] (MF7)** or **[Symbol] (MF7)** to select the character group, then rotate the main dial to select the character.
 - **[ABC] (MF6)** : A to Z (capital letters); **[123] (MF7)**: 0 to 9 (numerals); **[Symbol] (MF7)**: ! # \$ % & ' ` ^ - () { } _ ~ @ can be selected.
 - Push **[◀] (F-1)** to move the cursor left, push **[▶] (F-2)** to move the cursor right, push **[DEL] (F-3)** to delete a character and push **[SPACE] (F-4)** to insert a space.
- 3 Push **[EXIT/SET]** to set the file name.

• Saving location

- 1 Push **[DIR/FILE] (F-1)** to select tree view screen.
 - 2 Select the desired directory or folder in the USB-Memory.
 - Push **[◀▶] (F-4)** to select the upper directory.
 - Push **[▲] (F-2)** or **[▼] (F-3)** to select folder in the same directory.
 - Push and hold **[◀▶] (F-4)** for 1 sec. to select a folder in the directory.
 - Push **[REN] (MF5)** to rename the folder.
 - Push and hold **[DEL] (MF6)** for 1 sec. to delete the folder.
 - Push and hold **[MAKE] (MF7)** for 1 sec. to making a new folder. (Edit the name with the same manner as the “• File name” above.)
 - 3 Push **[DIR/FILE] (F-1)** twice to select the file name.
- ③ Push **[SAVE] (F-5)**.
- After the saving is completed, return to voice recorder RX memory screen automatically.

◇ Saving the TX memory

The TX memory contents can also be saved into the USB-Memory. However, the contents are saved with the message list, set mode conditions, etc. at the same time. See page 139 for details.

The USB-Memory is not supplied by Icom.

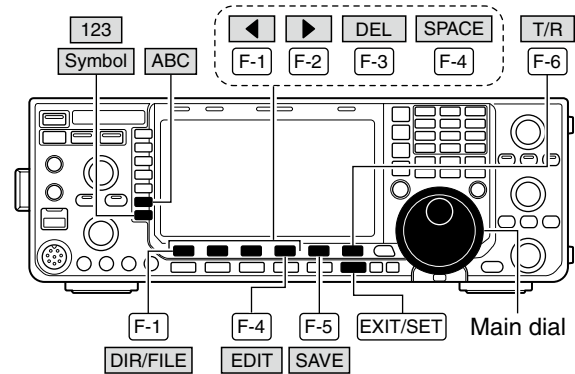

• Voice recorder RX memory screen



• Voice file save screen— file name edit

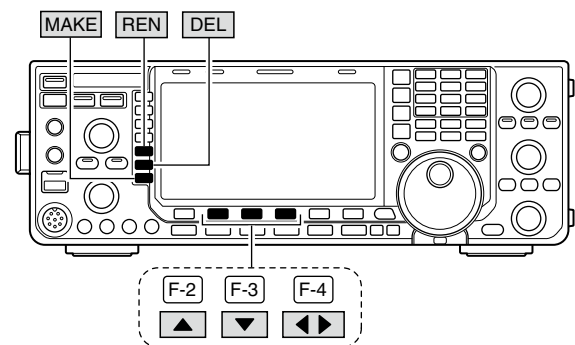

• While saving

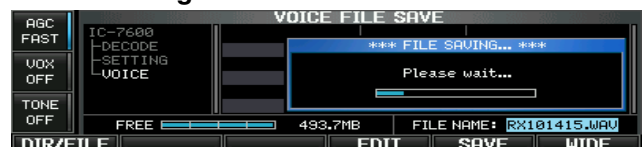

When a PC keyboard is connected to [USB] connector on the front panel, the file name can also be edited from the keyboard. In this case, a USB hub is required.

■ Memory channels

The transceiver has 101 memory channels. Memory mode is very useful for quick change to often-used frequencies.

All 101 memory channels are tunable which means the programmed frequency can be tuned temporarily with the main dial, etc. in memory mode.

MEMORY CHANNEL	MEMORY CHANNEL NUMBER	CAPABILITY	TRANSFER TO VFO	OVER-WRITING	CLEAR
Regular memory channels	1–99	One frequency and one mode in each memory channel.	Yes	Yes	Yes
Scan edge memory channels	P1, P2	One frequency and one mode in each memory channel as scan edges for programmed scan.	Yes	Yes	No

■ Memory channel selection

◇ Using the [▲]/[▼] keys

- ① Push [VFO/MEMO] to select memory mode.
- ② Push [▲]/[▼] several times to select the desired memory channel.
 - Push and hold [▲]/[▼] for continuous selection.
 - [UP] and [DN] on the microphone can also be used.
- ③ To return to VFO mode, push [VFO/MEMO] again.

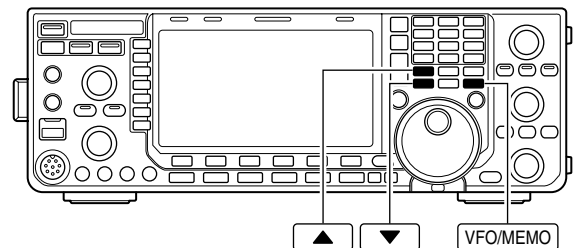

◇ Using the keypad

- ① Push [VFO/MEMO] to select memory mode.
- ② Push [F-INP ENT].
- ③ Push the desired memory channel number using the keypad.
 - Enter 100 or 101 to select scan edge channel P1 or P2, respectively.
- ④ Push [▲] or [▼] to set the memory channel.

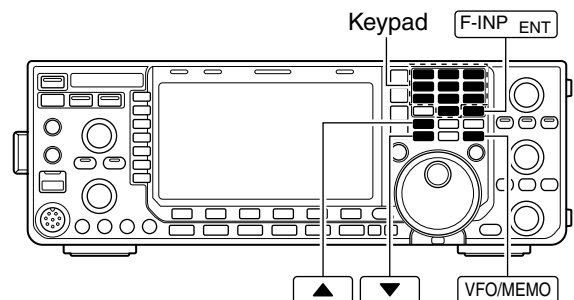

[EXAMPLE]

To select the memory channel 3;
- Push [F-INP ENT], [7 3], then push [▲] or [▼].

To select the memory channel 12;
- Push [F-INP ENT], [1.8 1], [3.5 2], then push [▲] or [▼].

To select the scan edge channel P1;
- Push [F-INP ENT], [1.8 1], [50 0], [50 0], then push [▲] or [▼].

To select the scan edge channel P2;
- Push [F-INP ENT], [1.8 1], [50 0], [1.8 1], then push [▲] or [▼].

■ Memory list screen

The memory list screen simultaneously shows 7 memory channels and their programmed contents. 13 memory channels can be displayed in the wide memory list screen.

You can select a desired memory channel from the memory list screen.

◇ Selecting a memory channel using the memory list screen

- ① Push **[EXIT/SET]** several times to close a multi-function screen, if necessary.
- ② Push **[MEMORY]** (**F-4**) to select memory list screen.
 - Pushing **[WIDE]** (**F-6**) switches the standard and wide screens.
- ③ While pushing and holding **[SET]** (**F-2**), rotate the main dial to select the desired memory channel.
 - **[▲]** and **[▼]** can also be used.
- ④ Push **[EXIT/SET]** to exit memory list screen.

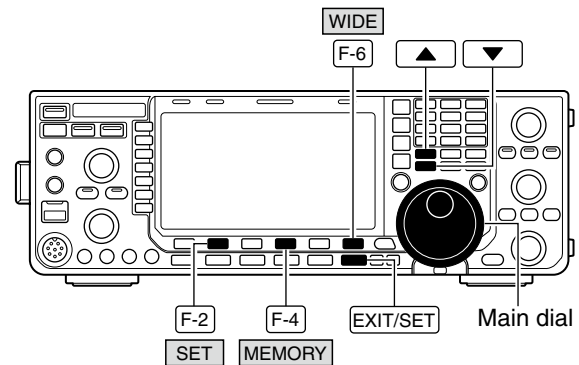

• Memory list screen



◇ Confirming programmed memory channels

- ① Select memory list screen as described above.
- ② While pushing **[ROLL]** (**F-1**), rotate the main dial to scroll the screen.
- ③ Push **[SET]** (**F-2**) to select the highlighted memory channel, if desired.
 - "▶" appears beside the selected memory channel number in the memory list screen and the selected memory channel contents are displayed below the frequency readout.
- ④ Push **[EXIT/SET]** to exit memory list screen.

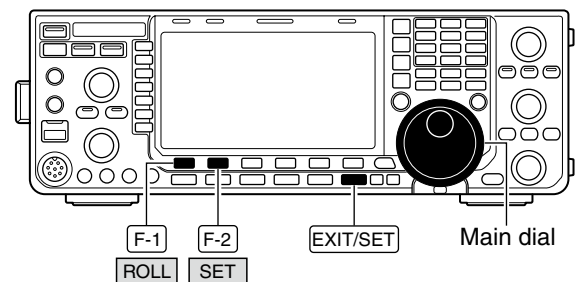

Memory channel programming

Memory channel programming can be performed either in VFO mode or in memory mode.

Programming in VFO mode

- ① Set the desired frequency, operating mode and filter width in VFO mode.
- ② Push **[▲]**/**[▼]** several times to select the desired memory channel.
 - Memory list screen is convenient for selecting the desired channel. (p. 100)
 - Memory channel contents appear in the memory channel readout (below the frequency readout).
 - “--.--.--” appears if the selected memory channel is a blank channel (and does not have contents).
- ③ Push and hold **[MW]** for 1 sec. to program the displayed frequency, operating mode, etc., into the memory channel.

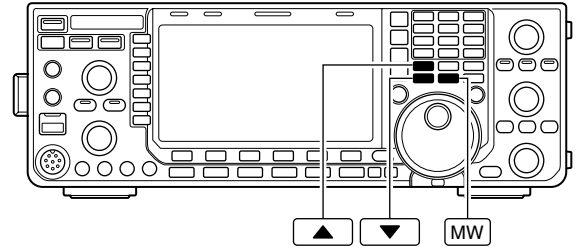

[EXAMPLE]:
Programming 7.088 MHz/LSB into memory channel 12.



Programming in memory mode

- ① Select the desired memory channel with **[▲]**/**[▼]** in memory mode.
 - Memory channel contents appear in the memory channel readout instead of the frequency readout.
 - No indication appears if the selected memory channel is a blank channel (and does not have contents).
- ② Set the desired frequency and operating mode in memory mode.
 - To program a blank channel, use direct frequency entry with the keypad or memo pads, etc. (p. 28)
- ③ Push and hold **[MW]** for 1 sec. to program the displayed frequency and operating mode into the memory channel.

[EXAMPLE]:
Programming 21.280 MHz/USB into memory channel 19.

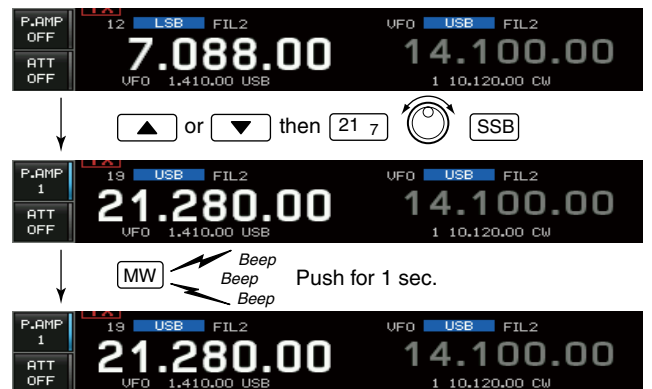

■ Frequency transfers

The frequency and operating mode in a memory channel can be transferred to the VFO. Frequency transfers can be performed in either VFO mode or memory mode.

◇ Transferring in VFO mode

This is useful for transferring programmed contents to a VFO.

- ① Select VFO mode with [VFO/MEMO].
- ② Select the memory channel to be transferred with [▲]/[▼].
 - Memory list screen is convenient for selecting the desired channel.
 - Memory channel contents appear in the memory channel readout (below the frequency readout).
 - “--.--.--” appears if the selected memory channel is a blank channel. In this case transferring is not possible.
- ③ Push and hold [VFO/MEMO] for 1 sec. to transfer the frequency and operating mode.
 - Transferred frequency and operating mode appear on the frequency readout.

TRANSFER EXAMPLE IN VFO MODE

Operating frequency : 21.320 MHz/USB (VFO)
Contents of M-ch 16 : 14.018 MHz/CW

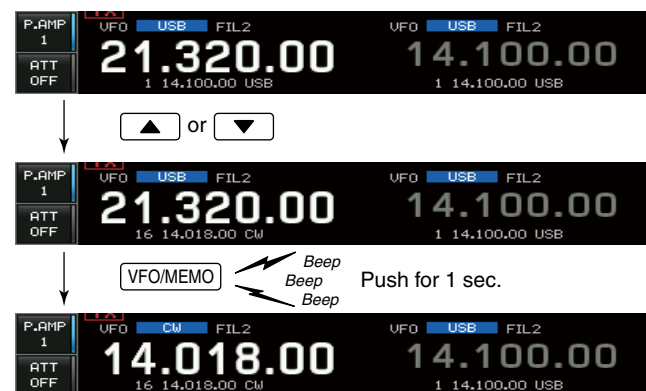

◇ Transferring in memory mode

This is useful for transferring frequency and operating mode while operating in memory mode.

When you have changed the frequency or operating mode in the selected memory channel:

- **Displayed** frequency, mode and filter setting are transferred.
- **Programmed** frequency, mode and filter in the memory channel are not transferred, and they remain in the memory channel.

- ① Select the memory channel to be transferred with [▲]/[▼] in memory mode.
 - Then, set the frequency or operating mode if required.
- ② Push and hold [VFO/MEMO] for 1 sec. to transfer the frequency, mode and filter.
 - Displayed frequency, mode and filter are transferred to the VFO.
- ③ To return to VFO mode, push [VFO/MEMO] momentarily.

TRANSFER EXAMPLE IN MEMORY MODE

VFO frequency : 21.320 MHz/USB
Contents of M-ch 16 : 14.018 MHz/CW

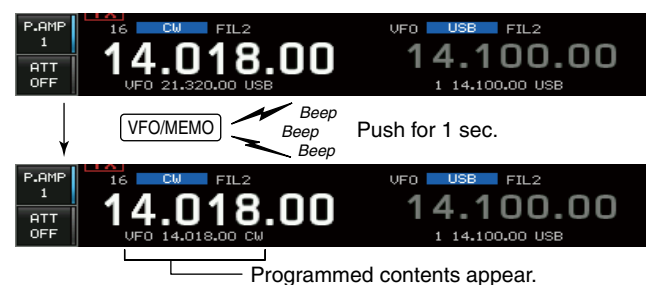

Memory names

All memory channels (including scan edges) can be tagged with alphanumeric names of up to 10 characters each.

Capital letters, small letters, numerals, some symbols (! # \$ % & ¥ ? " ' ` ^ + - * / . , ; = < > () [] { } | _ - @) and space can be used.

Editing (programming) memory names

- ① Push **[EXIT/SET]** several times to close a multi-function screen, if necessary.
- ② Push **[MEMORY] (F-4)** to select memory list screen.
- ③ Select the desired memory channel with **[▲]/[▼]**.
- ④ Push **[NAME] (F-4)** to edit memory channel name.
 - A cursor appears and blinks.
 - Memory channel names of blank channels cannot be edited.
- ⑤ Input the desired character by rotating the main dial or by pushing the keypad for number input.
 - Push **[ABC]** or **[abc]** to toggle capital and small letters.
 - Push **[123]** or **[Symbol]** to toggle numerals and symbols.
 - Push **[◀] (F-1)** or **[▶] (F-2)** for cursor movement.
 - Push **[DEL] (F-3)** to delete the selected character.
 - Push **[SPACE] (F-4)** to input a space.
 - Pushing the transceiver's keypad, **[0]–[9]** and **[.]** can also enter numerals.
- ⑥ Push **[EXIT/SET]** to input and set the name.
 - The cursor disappears.
- ⑦ Repeat steps ③ to ⑥ to program another memory channel's name, if desired.
- ⑧ Push **[EXIT/SET]** to exit memory list screen.

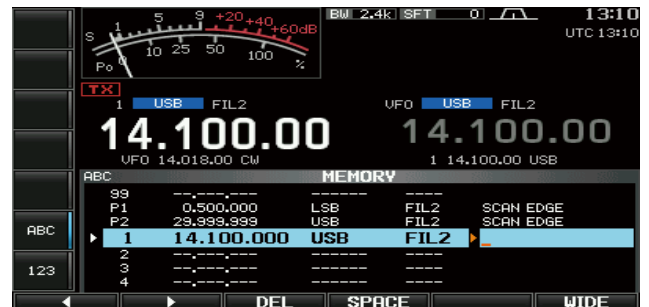
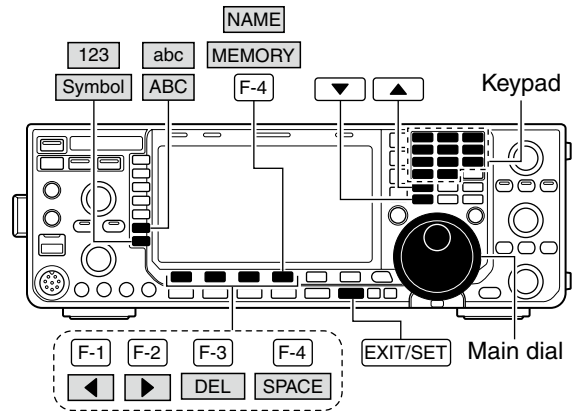

For your convenience

When a PC keyboard is connected to [USB] (A) connector on the front panel, the memory name can also be edited from the keyboard.

Memory clearing

Any unused memory channels can be cleared. The cleared memory channels become blank channels.

- ① Select memory mode with **[VFO/MEMO]**.
- ② Push **[MEMORY] (F-4)** to select memory list screen.
- ③ Select the desired memory channel with **[▲]/[▼]**.
- ④ Push and hold **[CLR] (F-5)** for 1 sec. to clear the contents.
 - The programmed frequency, operating mode and filter disappear.
- ⑤ To clear other memory channels, repeat steps ③ and ④.

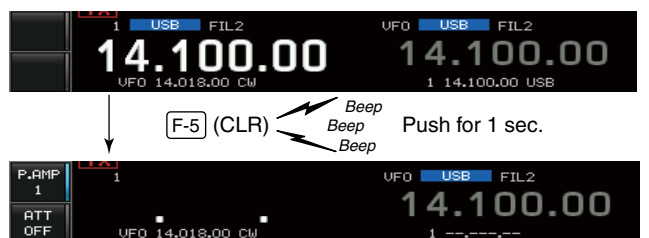
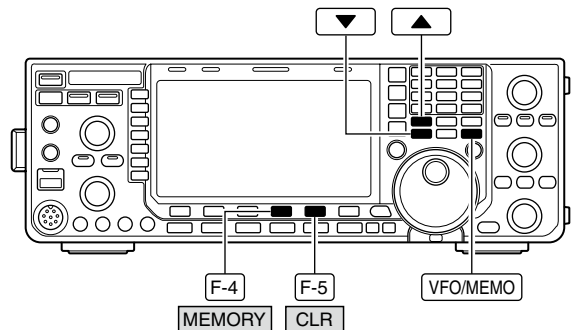

■ Memo pads

The transceiver has a memo pad function to store frequency and operating mode for easy writing and recalling. The memo pads are separate from memory channels.

The default number of memo pads is 5, however, this can be increased to 10 in set mode if desired. (p. 132)

Memo pads are convenient when you want to memorize a frequency and operating mode temporarily, such as when you find a DX station in a pile-up, or when a desired station is busy for a long time and you want to temporarily search for other stations.

Use the transceiver's memo pads instead of relying on hastily scribbled notes that are easily misplaced.

◇ Writing frequencies and operating modes into memo pads

You can store the readout frequency and operating mode by pushing **[MP-W]**.

When you store the 6th frequency and operating mode, the oldest stored frequency and operating mode are automatically erased to make room for the new settings.

Each memo pad must have its own unique combination of frequency and operating mode; memo pads having identical settings cannot be written.

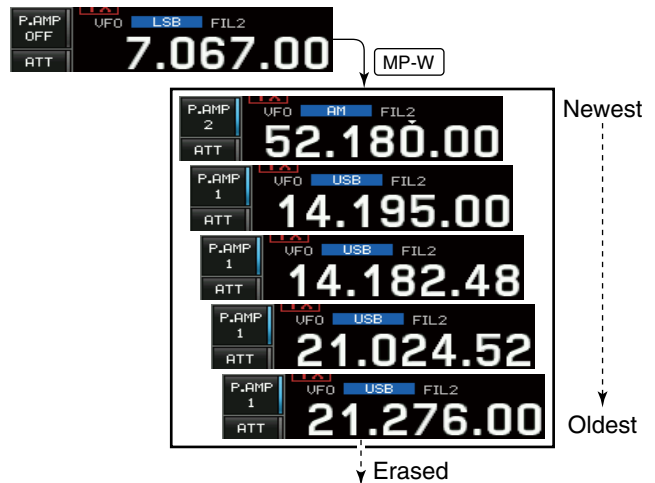
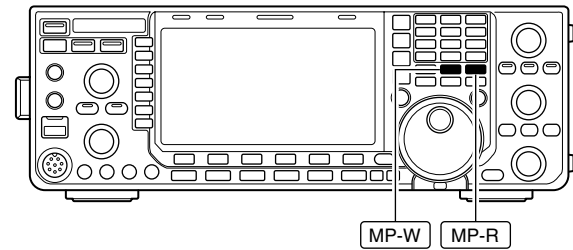

In this example, 21.276 MHz (USB) will be erased when 7.067 MHz (LSB) is written.

◇ Calling up a frequency from a memo pad

You can call up the desired frequency and operating mode of a memo pad by pushing **[MP-R]** several times.

- Both VFO and memory modes can be used.
- The frequency and operating mode are called up, starting from the most recently written.

When you call up a frequency and an operating mode from memo pads with **[MP-R]**, the previously displayed frequency and operating mode are automatically stored in a temporary pad. The frequency and operating mode in the temporary pad can be recalled by pushing **[MP-R]** several times.

- You may think there are 6 memo pads because 6 different frequencies (5 are in memo pads and 1 is in the temporary pad) are called up by **[MP-R]**.

If you change the frequency or operating mode called up from a memo pad with the main dial, etc., the frequency and operating mode in the temporary pad are erased.

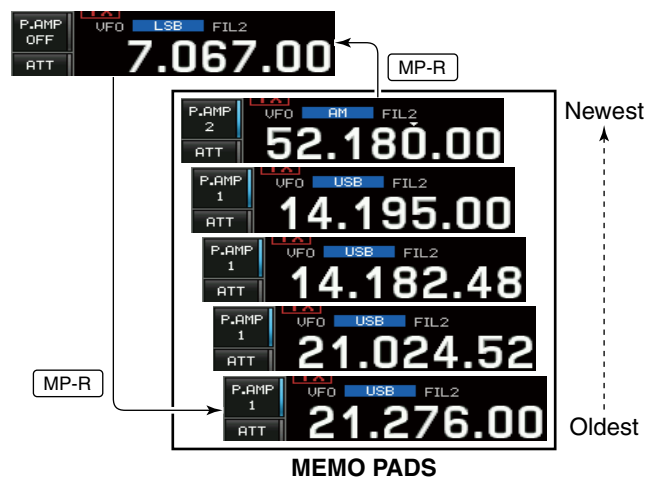

■ Scan types

PROGRAMMED SCAN

Repeatedly scans between two scan edge frequencies (scan edge memory channels P1 and P2).

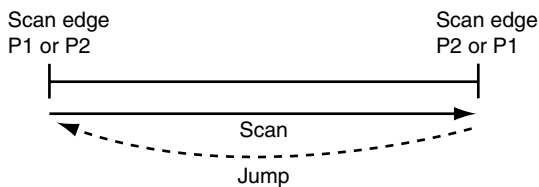

This scan operates in VFO mode.

MEMORY SCAN

Repeatedly scans all programmed memory channels.

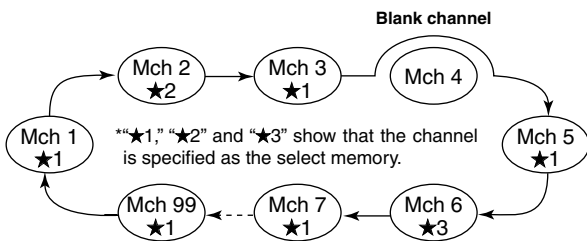

This scan operates in memory mode.

- The scan function can be used on the main read-out only.
- You can perform a scan while operating on a frequency using the dualwatch or split functions.

ΔF SCAN

Repeatedly scans within ΔF span area.

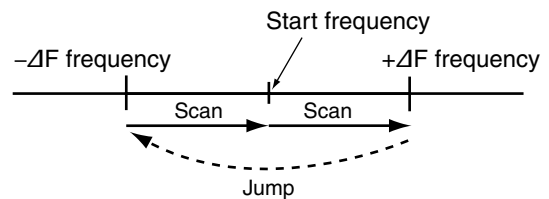

This scan operates in both VFO and memory modes.

SELECT MEMORY SCAN

Repeatedly scans all or one of 3 select memory channels.

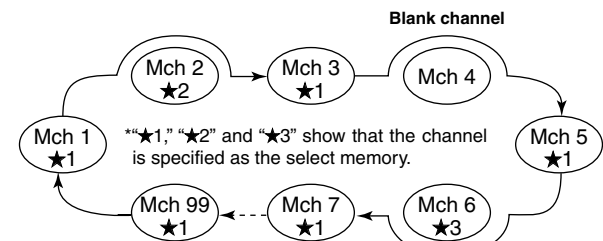

This scan operates in memory mode.

■ Preparation

• Channels

For programmed scan:

Program scan edge frequencies into scan edge memory channels P1 and P2. (p. 101)

For ΔF scan:

Set the ΔF span (ΔF scan range) in the scan screen.

For memory scan:

Program 2 or more memory channels except scan edge memory channels.

For select memory scan:

Designate 2 or more memory channels as select memory channels. To designate the channel as a select memory channel, choose a memory channel, then push [SELECT] (F-3) in the scan screen (memory mode) or in the memory list screen.

• Scan resume ON/OFF

You can select the scan to resume or cancel when detecting a signal in scan set mode. Scan resume ON/OFF must be set before performing a scan. See p. 106 for ON/OFF setting and scan resume condition details.

• Scan speed

Scan speed can be selected from 2 levels, high or low, in scan set mode. See p. 106 for details.

• Squelch condition

○ Scan starts with squelch open

For programmed scan:

When tuning step is 1 kHz or less:

The scan continues until it is stopped manually— it does not pause* even if signals are detected.

* The scan is paused when the squelch is closed and then opened (scan resumes after 10 sec. has passed when the scan resume is ON; scan is cancelled when the scan resume is OFF).

When tuning step is more than 5 kHz:

The scan pauses on each step when the scan resume is ON; not applicable when the scan resume is OFF.

For memory scan:

Scan pauses on each channel when the scan resume is ON; not applicable when the scan resume is OFF.

○ Scan starts with squelch closed

Scan stops when a signal is detected.

- If the scan resume is set to ON in scan set mode, the scan pauses for 10 sec. when detecting a signal, then resumes. When a signal disappears while scan is paused, scan resumes 2 sec. later.

■ Scan set mode

Scan speed and the scan resume condition can be set using the scan set mode.

- ① Push **[SCAN] (F-5)** to select scan screen.
- ② Push **[SET] (F-6)** to select scan set mode.
- ③ Push **[▲] (F-1)** or **[▼] (F-2)** to select the desired item.
- ④ Rotate the main dial to select the desired condition.
 - Push and hold **[DEF] (F-4)** for 1 sec. to select the default setting.
- ⑤ Push **[EXIT/SET]** to return to scan menu.

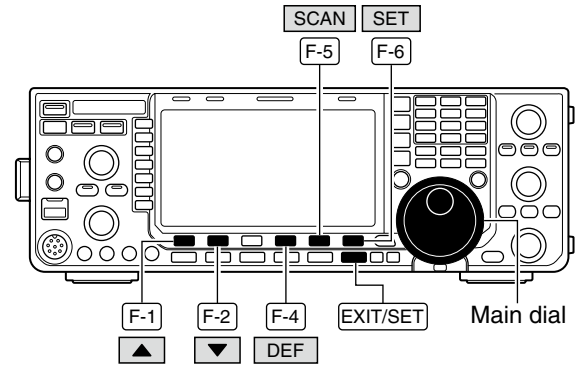

Scan Speed	HIGH
Select the desired scan speed from high and low.	<ul style="list-style-type: none"> • HIGH : scan is faster. • LOW : scan is slower.
Scan Resume	ON
Set the scan resume function ON and OFF.	<ul style="list-style-type: none"> • ON : When detecting a signal, scan pauses for 10 sec., then resumes. When a signal disappears, scan resumes 2 sec. later. • OFF : When detecting a signal, cancels scanning.

Programmed scan operation

- ① Push **[EXIT/SET]** several times to close a multi-function screen, if necessary.
- ② Select VFO mode.
- ③ Select the desired operating mode.
 - The operating mode can also be changed while scanning.
- ④ Push **[SCAN] (F-5)** to select the scan screen.
- ⑤ Set **[RF/SQL]** open or closed.
 - See p. 105 for squelch condition.
 - If the **[RF/SQL]** control function is set as "AUTO," the squelch is always open in SSB, CW, RTTY and PSK modes. (pgs. 2, 33, 128)
- ⑥ Push **[PROG] (F-1)** to start the programmed scan.
 - "PROGRAM SCAN" and decimal points blink while scanning.
- ⑦ When the scan detects a signal, scan stops, pauses or ignores it depending on the resume setting and the squelch status.
- ⑧ To cancel the scan, push **[PROG] (F-1)**.
 - Rotating the main dial also cancels the scan.
- ⑨ Push and hold **[RECALL] (F-5)** for 1 sec. to recall the frequency that is set before starting the scan, if desired.

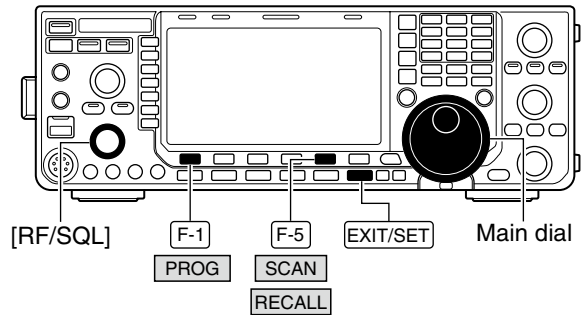

▨ If the same frequencies are programmed into the scan edge memory channel P1 and P2, programmed scan will not start.

ΔF scan operation

- ① Push **[EXIT/SET]** several times to close a multi-function screen, if necessary.
- ② Select VFO mode or a memory channel.
- ③ Select the desired operating mode.
 - The operating mode can also be changed while scanning.
- ④ Push **[SCAN] (F-5)** to select the scan screen.
- ⑤ Set **[RF/SQL]** open or closed.
 - See p. 105 for squelch condition.
 - If the **[RF/SQL]** control function is set as "AUTO," the squelch is always open in SSB, CW, RTTY and PSK modes. (pgs. 2, 33, 128)
- ⑥ Set the ΔF span by pushing **[ΔF SPAN] (F-4)**.
 - ± 5 kHz, ± 10 kHz, ± 20 kHz, ± 50 kHz, ± 100 kHz, ± 500 kHz and ± 1000 kHz are selectable.
- ⑦ Rotate the main dial to set a center frequency of the ΔF span.
- ⑧ Push **[ΔF] (F-2)** to start the ΔF scan.
 - " ΔF SCAN" and decimal points blink while scanning.
- ⑨ When the scan detects a signal, the scan stops, pauses or ignores it depending on the resume setting and the squelch status.
- ⑩ To cancel the scan, push **[ΔF] (F-2)**.
 - Rotating the main dial also cancels the scan.
- ⑪ Push and hold **[RECALL] (F-5)** for 1 sec. to recall the frequency that was set before starting the scan.

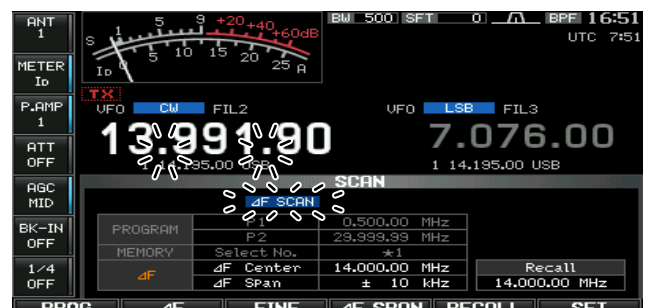
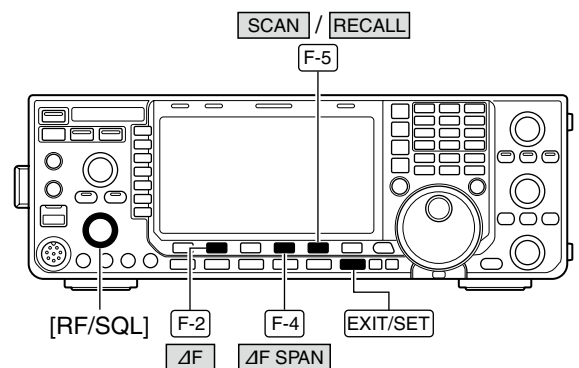

■ Fine programmed scan/Fine ΔF scan

In fine scan (programmed or ΔF), the scan speed decreases when the squelch opens, but the transceiver keeps scanning. The scanning tuning step shifts from 50 Hz to 10 Hz when the squelch opens.

- ① Push **[EXIT/SET]** several times to close a multi-function screen, if necessary.
- ② Push **[SCAN] (F-5)** to select the scan screen.
- ③ Set for programmed scan or ΔF scan as described on previous page.
- ④ Push **[PROG] (F-1)** or **[ΔF] (F-2)** to start a scan.
 - “**PROGRAM SCAN**” or “ **ΔF SCAN**” and decimal points blink while scanning.
- ⑤ Push **[FINE] (F-3)** to start a fine scan.
 - “**FINE PROGRAM SCAN**” or “**FINE ΔF SCAN**” blinks instead of “**PROGRAM SCAN**” or “ **ΔF SCAN**,” respectively.
- ⑥ When the scan detects a signal, the scan speed decreases but scan does not stop.
- ⑦ Push **[PROG] (F-1)** or **[ΔF] (F-2)** to stop the scan; push **[FINE] (F-3)** to cancel the fine scan.
 - Rotating the main dial also cancels the scan.
- ⑧ Push and hold **[RECALL] (F-5)** for 1 sec. to recall the frequency that is set before starting the scan, if desired.

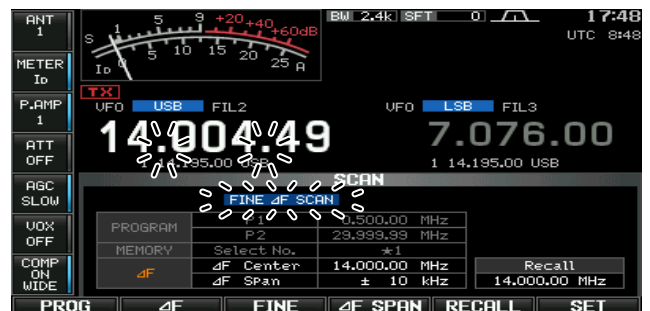
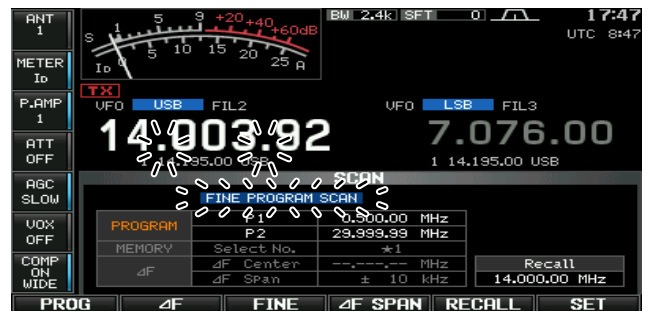
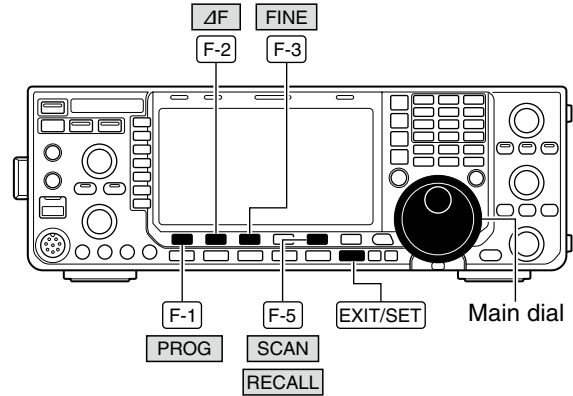

Memory scan operation

- ① Push **[EXIT/SET]** several times to close a multi-function screen, if necessary.
- ② Select memory mode.
- ③ Push **[SCAN] (F-5)** to select the scan screen.
- ④ Set **[RF/SQL]** open or closed.
 - See p. 105 for squelch condition.
 - If the **[RF/SQL]** control function is set as "AUTO," the squelch is always open in SSB, CW, RTTY and PSK modes. (pgs. 2, 33, 128)
- ⑤ Push **[MEMO] (F-1)** to start the memory scan.
 - "MEMORY SCAN" and decimal points blink while scanning.
- ⑥ When the scan detects a signal, the scan stops, pauses or ignores it depending on the resume setting and the squelch condition.
- ⑦ To cancel the scan, push **[MEMO] (F-1)**.
 - Rotating the main dial also cancels the scan.

2 or more memory channels must be programmed for memory scan to start.

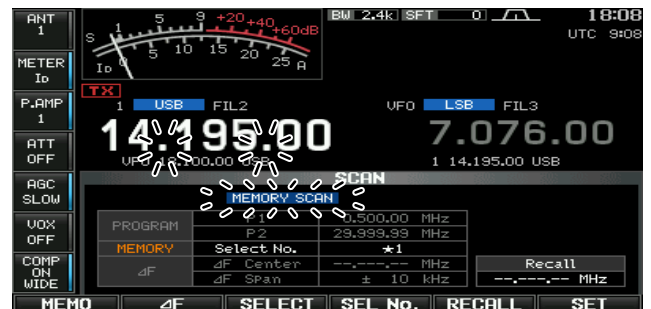
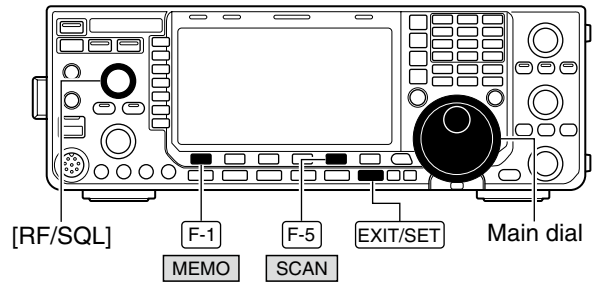

Select memory scan operation

- ① Push **[EXIT/SET]** several times to close a multi-function screen, if necessary.
- ② Select memory mode.
- ③ Push **[SCAN] (F-5)** to select the scan screen.
- ④ Set **[RF/SQL]** open or closed.
 - See p. 105 for squelch condition.
 - If the **[RF/SQL]** control function is set as "AUTO," the squelch is always open in SSB, CW, RTTY and PSK modes. (pgs. 2, 33, 128)
- ⑤ Push **[MEMO] (F-1)** to start the memory scan.
 - "MEMORY SCAN" and decimal points blink while scanning.
- ⑥ Push **[SEL No.] (F-4)** several times to select the select scan number from ★1, ★2, ★3 and ★1,2,3.
- ⑦ Push **[SELECT] (F-3)** to start select memory scan; push **[SELECT] (F-3)** again to return to memory scan, if desired.
 - "SELECT MEMORY SCAN" blinks instead of "MEMORY SCAN" during select memory scan.
- ⑧ When the scan detects a signal, the scan stops, pauses or ignores it depending on the resume setting and the squelch condition.
- ⑨ To cancel the scan, push **[MEMO] (F-1)**.
 - Rotating the main dial also cancels the scan.

2 or more memory channels must be designated as select memory channels, as well as the same select scan channel number, for select memory scan to start.

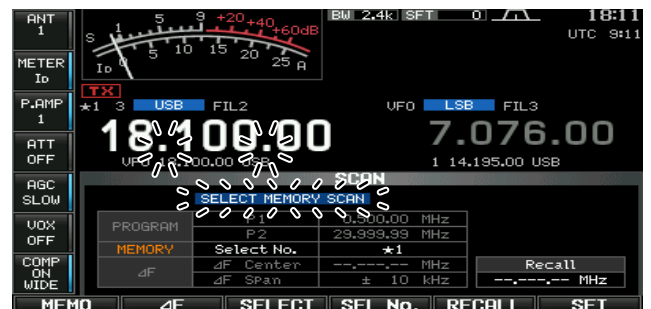
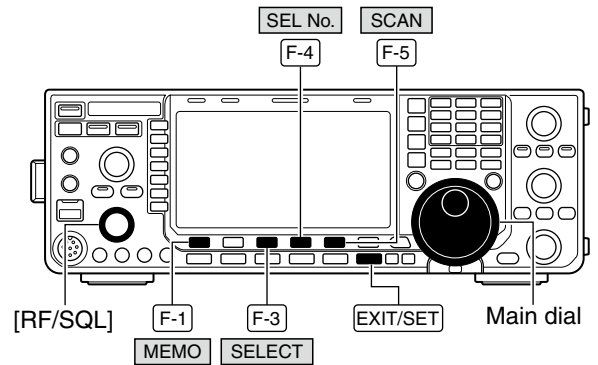

■ Setting select memory channels

◇ Setting in scan screen

- ① Push **[EXIT/SET]** several times to close a multi-function screen, if necessary.
- ② Select memory mode.
- ③ Push **[SCAN] (F-5)** to select the scan screen.
- ④ Select the desired memory channel to set as a select memory channel.
 - **[▲]/[▼]** keys and direct keypad selections can be used. (p. 99)
- ⑤ Push **[SELECT] (F-3)** several times to set the memory channel as a select memory ★1, ★2, ★3 or not.
 - “★1,” “★2” or “★3” appears on the LCD to show that the channel is specified as the select memory.
- ⑥ Repeat steps ④ to ⑤ to program another memory channel as a select memory channel.
- ⑦ Push **[EXIT/SET]** to exit the scan screen.

◇ Setting in memory list screen

- ① Push **[EXIT/SET]** several times to close a multi-function screen, if necessary.
- ② Push **[MEMORY] (F-4)** to select memory list screen.
- ③ Rotate the main dial while pushing **[ROLL] (F-1)** or **[SET] (F-2)** to select the desired memory channel.
 - **[▲]/[▼]** keys and direct keypad selections can be used. (p. 99)
- ④ Push **[SELECT] (F-3)** several times to set the memory channel as a select memory ★1, ★2, ★3 or not.
 - “★1,” “★2” or “★3” appears on the LCD to show that the channel is specified as the select memory.
- ⑤ Repeat steps ③ to ④ to program another memory channel as a select memory channel.
- ⑥ Push **[EXIT/SET]** to exit the memory list screen.

◇ Erasing the select scan setting

- ① Push **[EXIT/SET]** several times to close a multi-function screen, if necessary.
- ② Push **[MEMORY] (F-4)** to select memory list screen, or push **[SCAN] (F-5)** to select scan screen.
- ③ Push and hold **[SELECT] (F-3)** for 1 sec. to display memory select all clear window.
- ④ Push one of the following keys to clear all select scan settings.
 - [★1] (F-1)** : Clears all ★1 settings.
 - [★2] (F-2)** : Clears all ★2 settings.
 - [★3] (F-3)** : Clears all ★3 settings.
 - [★1,2,3] (F-4)** : Clears all select settings.
- ⑤ Push **[EXIT/SET]** to exit the memory list screen.

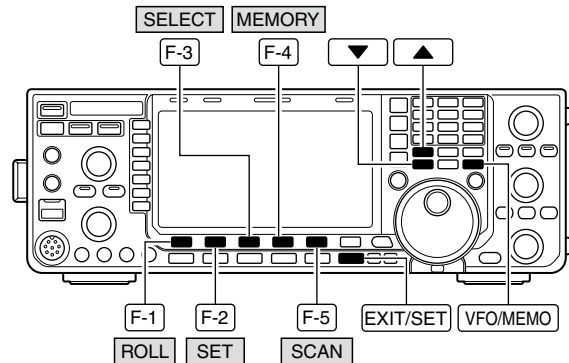

• Scan screen



• Memory list screen

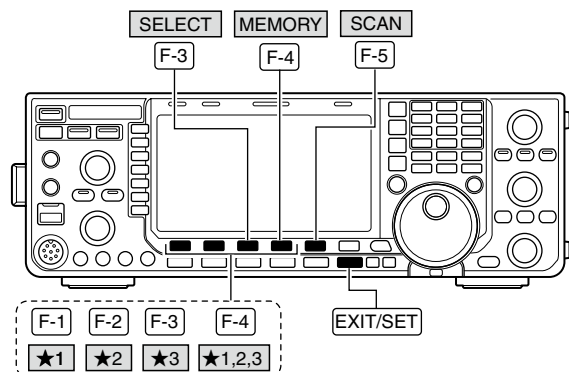

■ Tone scan

The transceiver can detect subaudible tones in a received signal. By monitoring a signal that is being transmitted on a repeater input frequency, you can determine the tone frequency required to access the repeater.

- ① Set the desired frequency or memory channel to be checked for a tone frequency.
- ② Push **[AM/FM]** several times to select FM mode.
- ③ Push and hold **[TONE] (MF7)** for 1 sec. to enter tone frequency screen.
- ④ Push **[▲] (F-1)** or **[▼] (F-2)** to check the repeater tone frequency or tone squelch frequency, respectively.
- ⑤ Push **[T-SCAN] (F-6)** to start the tone scan.
 - "SCAN" blinks while scanning.
- ⑥ When a matching tone frequency is detected, the tone scan pauses.
 - The tone frequency is set temporarily on a memory channel. Program the memory channel to store the tone frequency permanently.
 - The decoded tone frequency is used for the repeater tone frequency or tone squelch frequency.
- ⑦ To stop the scan, push **[T-SCAN] (F-6)**.
 - Push and hold **[DEF] (F-4)** for 1 sec. to select the default frequency.
- ⑧ Push **[EXIT/SET]** to exit tone frequency screen.

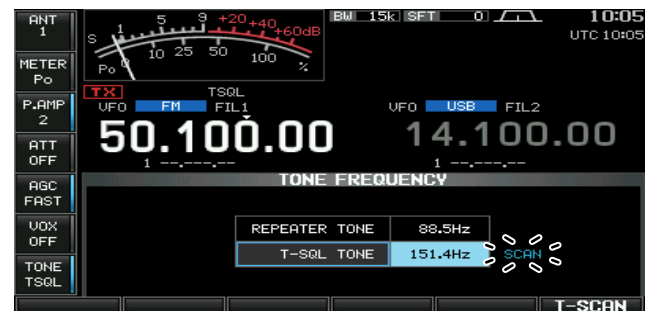
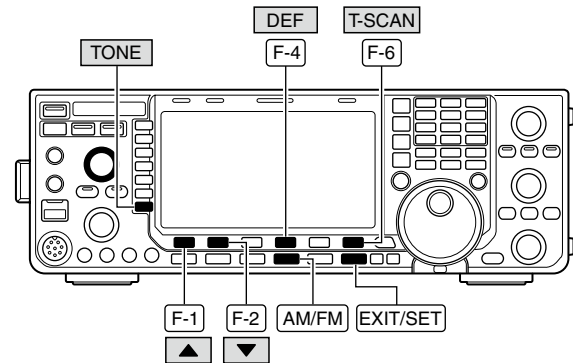

■ Automatic antenna selection

The transceiver covers 0.03–60 MHz over 10 bands. Each band key has a band memory which can memorize a selected antenna (ANT1, ANT2, ANT1/RX antenna and ANT2/RX antenna). When you change the operating frequency beyond a band, the previously used antenna is automatically selected. This function is convenient when you use 2 or 3 antennas.

To use the band memory, enter set mode and confirm that “Auto” is selected as the [ANT] switch item. (p. 130)

- **Antenna selection mode: “Auto”** (default)

The antenna tuner ON/OFF condition is also memorized in the band memory.

[Example]: a 3.5/7 MHz antenna is connected to [ANT1], a 21/28/50 MHz antenna is connected to [ANT2]. When the antenna selector function is set to “Auto,” an antenna is automatically selected when the transceiver changes bands.

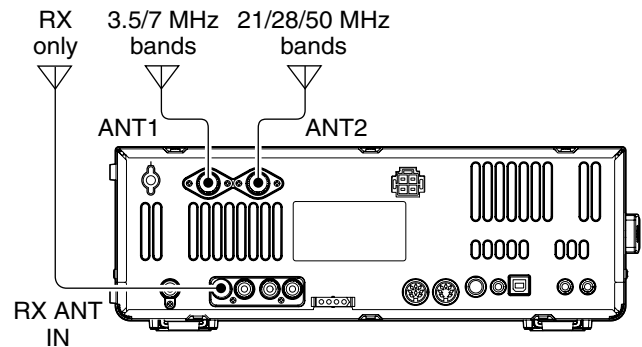

- **Antenna selection mode: “Manual”**

[ANT] (MF1) functions, however, band memory does not function. In this case, you must select an antenna manually.

When using an external antenna selector for more than 3 antennas (except for receive antenna), “Manual” should be selected as the [ANT] switch set mode item. (p. 130)

NOTE: When “Auto” or “Manual” is selected, the antenna tuner ON/OFF condition is consistent with [ANT] (MF1).

- **Antenna selection mode: “OFF”**

[ANT] (MF1) does not function and [ANT1] is always selected.

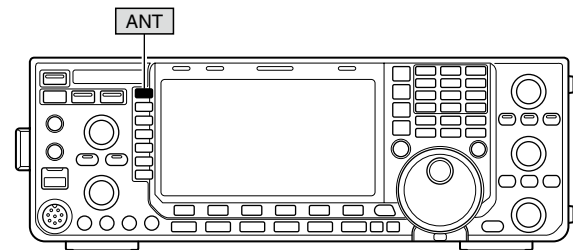

■ Antenna tuner operation

The internal automatic antenna tuner matches the transceiver to the connected antenna automatically. After the tuner matches an antenna, the variable capacitor settings are memorized as a preset point for each frequency range (100 kHz steps). Therefore, when you change the frequency range, the variable capacitors are automatically preset to the memorized setting.

CAUTION: NEVER transmit with the tuner ON when no antenna is connected. This will damage the transceiver. Be careful of the antenna selection.

✓ For your convenience

When you purchase a brand-new antenna, or you want to change the antenna settings, you can erase the all of the internal antenna tuner preset points with "Tuner Preset Memory Clear" in others set mode. (p. 130)

◇ Tuner operation

➔ Push **[TUNER]** to turn the internal antenna tuner ON. The antenna is tuned automatically when the antenna SWR is higher than 1.5:1.

- When the tuner is ON, the indicator on the switch lights green.
- While tuning, the indicator on the switch blinks.

◇ Manual tuning

During SSB operation at low voice levels, the internal tuner may not automatically tune correctly. In such cases, manual tuning is helpful.

➔ Push and hold **[TUNER]** for 1 sec., to start manual tuning.

- A sidetone is emitted and the indicator on the switch blinks red while tuning.
- If the tuner cannot reduce the SWR to less than 1.5:1 after 20 sec. of tuning, the indicator on the switch goes out.

○ If the tuner cannot tune the antenna

Check the following and try again:

- the **[ANT]** connector selection.
- the antenna connection and feedline.
- the untuned antenna SWR. (Less than 3:1 for HF bands; Less than 2.5:1 for 50 MHz band)
- the transmit power. (8 W for HF bands; 15 W for 50 MHz band)
- the power source voltage/capacity.

If the tuner cannot reduce the SWR to less than 1.5:1 after checking the above, perform the following:

- repeat manual tuning several times.
- adjust the antenna feedline length. (This is effective for higher frequencies in some cases.)

Even if the manual tune does not tune the antenna and the tuner turns OFF at the first time, it may tune the antenna at the second time.

NOTES:

- NEVER transmit without an antenna properly connected to antenna port in use.
- When 2 antennas are connected, select the antenna to be used with **[ANT] (MF1)**.
- If the SWR is higher than about 1.5:1 when tuning farther than 100 kHz from an antenna's programmed preset point, push and hold **[TUNER]** for 1 sec. to start manual tuning.
- The internal tuner may not be able to tune in AM mode. In such cases, push and hold **[TUNER]** for 1 sec. to manually tune.

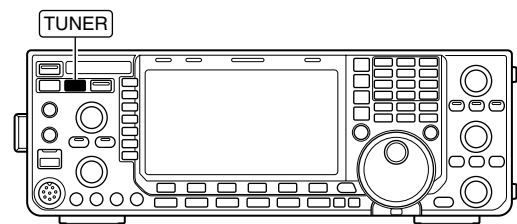

○ Tuning a narrow bandwidth antenna

Some antennas, especially for the low bands, have a narrow bandwidth. These antennas may not be tuned beyond the edge of their operating bandwidth, therefore, tune such an antenna as follows:

[Example]: Suppose you have an antenna which has an SWR of 1.5:1 at 3.55 MHz and an SWR of 3:1 at 3.8 MHz.

- ① Set 3.55 MHz and push and hold **[TUNER]** for 1 sec. to start manual tuning.
- ② Set 3.80 MHz and push and hold **[TUNER]** for 1 sec. to start manual tuning.

• **Automatic tuner start** (HF bands only)

If you want to deactivate the tuner under conditions of VSWR 1.5:1 or less, use the auto tuner start function and turn the tuner OFF. This function activates the tuner automatically when the SWR is high.

This function is controlled in set mode. (p. 129).

- The tuner may not be activated if the TX power is not output stably longer than the specified time period as SSB or CW mode operation.

• **PTT tuner start**

Tuning of the internal*/external antenna tuner starts when [PTT] is pushed on a new frequency (more than 1% from last-tuned frequency). This function removes the “push and hold [TUNER]” operation and activates for the first transmission on a new frequency.

*Tuning starts if the internal antenna tuner is ON.

This function is turned ON in set mode. (p. 129).

■ Optional external tuner operation

• **AH-4 HF AUTOMATIC ANTENNA TUNER**

The AH-4 matches the IC-7600 to a long wire antenna more than 7 m/23 ft long (3.5 MHz and above).

- See p. 18 for the transceiver and AH-4 connection.
- See the AH-4 instruction manual for AH-4 installation and antenna connection details.

AH-4 setting example:

For mobile operation

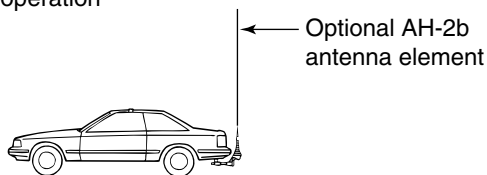

For outdoor operation

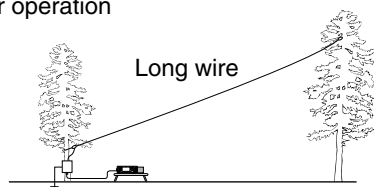

⚠ DANGER: HIGH VOLTAGE!

NEVER touch the antenna element while tuning or transmitting.

NEVER operate the AH-4 without an antenna wire. The tuner and transceiver will be damaged.

NEVER operate the AH-4 when it is not grounded.

Transmitting before tuning may damage the transceiver. Note that the AH-4 cannot tune when using a $\frac{1}{2} \lambda$ long wire or multiple of the operating frequency.

When connecting the AH-4, the antenna connector assignments are [ANT2] for the internal tuner and [ANT1] for the AH-4. The antenna indicator in the LCD displays “ANT1(EXT)” when the AH-4 is connected and selected.

• **AH-4 operation**

Tuning is required for each frequency. Be sure to re-tune the antenna before transmitting when you change the frequency— even slightly.

- ① Set the desired frequency in an HF or 50 MHz band for use with the AH-4.
 - The AH-4 will not operate on frequencies outside of ham bands.
- ② Push and hold [TUNER] for 1 sec.
 - The indicator on the switch blinks while tuning.

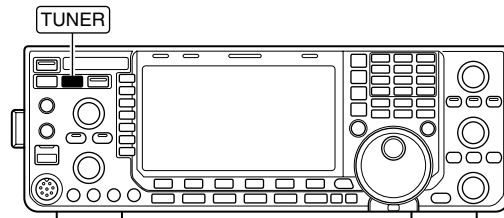

- ③ The indicator on the switch lights constantly when tuning is complete.
 - When the connected wire cannot be tuned, the indicator on the switch goes out and the AH-4 is bypassed. At that point the antenna wire connection is to the transceiver directly, and not via the AH-4 antenna tuner.
- ④ To bypass the AH-4 manually, push [TUNER].

NOTE: PTT tuner function is also available. See p. 129 for details.

• **Antenna tuner of the IC-PW1/EURO**

When using an external antenna tuner such as the IC-PW1/EURO’s tuner, tune with the external antenna tuner, while the internal tuner is turned OFF. After tuning is completed, turn the internal tuner ON.

Otherwise, both tuners tune simultaneously and correct tuning may not be obtained.

See the instruction manual included with each antenna tuner for their respective operations.

■ Clock set mode

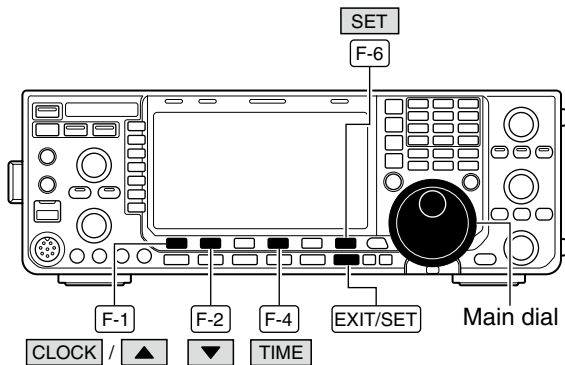

The IC-7600 has a built-in calendar and 24-hour clock (accuracy ± 75 sec. per month) with daily power ON/OFF timer functions. Before operating these timer functions, set the current date and time.

- ① Push **[EXIT/SET]** several times to close multi-function screen, if necessary.
- ② Push **[SET] (F-6)** to select set mode menu screen.
- ③ Push **[TIME] (F-4)** to select time set mode.
- ④ Push **[CLOCK] (F-1)** to select clock set mode.
- ⑤ Push **[▲] (F-1)** or **[▼] (F-2)** to select the desired item, then rotate the main dial to set or select the desired value or condition.
 - Pushing **[◀ ▶] (F-3)** operation may be necessary for some items.
 - Push and hold **[DEF] (F-4)** to select a default condition or value.
- ⑥ Push **[EXIT/SET]** to exit time set mode.

Date	2000 – 1 – 1 (Sat)
Sets the date.	<ol style="list-style-type: none"> ① Push [◀ ▶] (F-3) to select between the year and the month/day, then rotate the main dial to select them. <ul style="list-style-type: none"> • The date setting and “DATE-set Push [SET]” indication blink. ② Push [SET] (F-5) to set the date.
Time (Now)	0:00
Sets the local time.	<ol style="list-style-type: none"> ① Rotate the main dial to set the local time. <ul style="list-style-type: none"> • The time setting and “TIME-set Push [SET]” indication blink. ② Push [SET] (F-5) to set the time.
CLOCK2 Function	ON
Turns the CLOCK2 indicator ON and OFF. CLOCK2 is convenient to indicate UTC or other country's local time, etc.	<ul style="list-style-type: none"> • ON : The CLOCK2 indicator is displayed below the local time indication. • OFF : The CLOCK2 indicator does not display.
CLOCK2 Offset	± 0:00
Sets the desired off-set time period for CLOCK2 display within –24:00 to +24:00 in 5 min. steps.	
CLOCK2 Name	UTC
Sets the desired 3-character name for CLOCK2. Capital letters, small letters, numerals, some symbols (! # \$ % & ¥ ? " ' ` ^ + - * / . , : ; = < > () [] { } _ - @) and spaces can be used.	<ol style="list-style-type: none"> ① Push [EDIT] (F-5) to select the name edit condition. <ul style="list-style-type: none"> • The cursor under the 1st character blinks. ② Push [ABC]/[abc] (MF6) or [123]/[Symbol] (MF7) to select the character group, then rotate the main dial to select the character. <ul style="list-style-type: none"> • Push [ABC] or [abc] to toggle capital and small letters. • Push [123] or [Symbol] to toggle numerals and symbols. • Push [◀] (F-1) or [▶] (F-2) for cursor movement. • Push [DEL] (F-3) to delete the selected character. • Push [SPACE] (F-4) to input a space. • Pushing the transceiver's keypad, [0]–[9] and [.] can also enter numerals. ③ Push [EXIT/SET] to set the name.

Daily timer setting

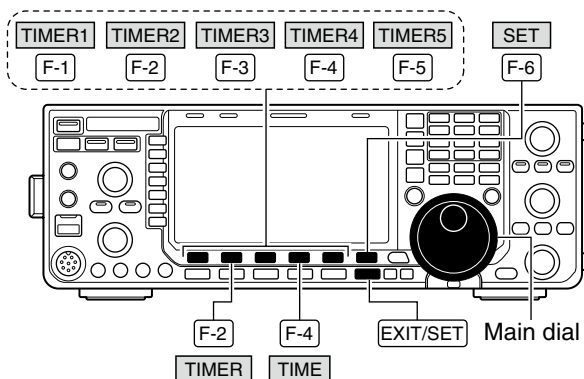

• Timer set mode screen

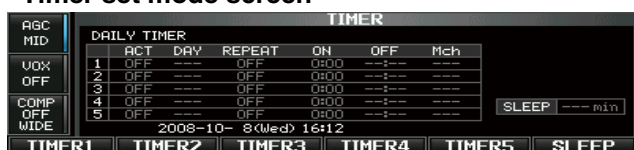

• During [Timer1] is selected

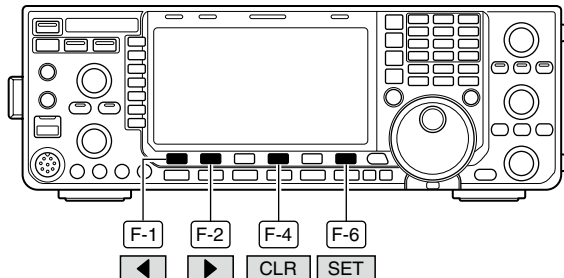

The transceiver turns power ON and/or OFF automatically on the specified day and time, with the specified frequency settings.

- ① Push [EXIT/SET] several times to close multi-function screen, if necessary.
- ② Push [SET] (F-6) to select set mode menu screen.
- ③ Push [TIME] (F-4) to select time set mode.
- ④ Push [TIMER] (F-2) to select timer set mode.
- ⑤ Push one of [TIMER1] (F-1) to [TIMER5] (F-5) to select the desired timer.
- ⑥ Rotate the main dial to select the timer action ON and OFF.
- ⑦ Push [▶] (F-2) to select the “DAY” cell, then rotate the main dial to select the desired day of the week.
 - Select “- - -” not to specify the day of the week. The timer will function every day in this case.
 - Once a day of the week is selected, push [CLR] (F-4) to select “- - -”.
- ⑧ Push [▶] (F-2) to select the “REPEAT” cell, then rotate the main dial to select the repeat function ON and OFF.
 - ON : The timer functions every selected day of the week (repeats).
 - OFF : The timer does not repeat.
- ⑨ Push [▶] (F-2) to select the “ON” cell, then rotate the main dial to set the desired transceiver power ON time.
 - When using power OFF timer only, push [CLR] (F-4) to select “- - - -.” This setting cannot be set when the power OFF timer is set to “- - - -.”
- ⑩ Push [▶] (F-2) to select the “OFF” cell, then rotate the main dial to set the desired transceiver power OFF time.
 - When using power ON timer only, push [CLR] (F-4) to select “- - - -.” This setting cannot be set when the power ON timer is set to “- - - -.”
- ⑪ Push [▶] (F-2) to select the “Mch” cell, then rotate the main dial to select the desired memory channel number.
 - If using the currently set VFO condition, push [CLR] (F-4) to select “- - -.”
- ⑫ Push [SET] (F-6) to set the timer.
 - The timer indicator appears.
- ⑬ Repeat steps ⑤ to ⑫ to set other timers, if desired.
- ⑭ Push [EXIT/SET] to exit timer set screen.

Setting sleep timer

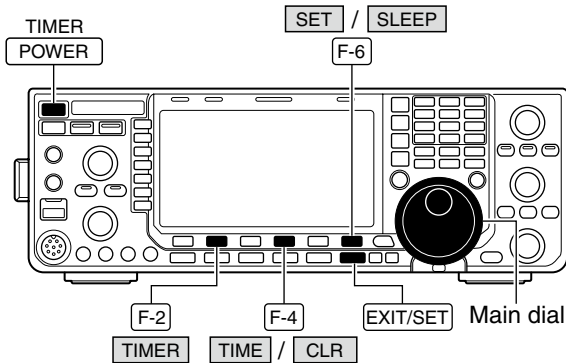

• Sleep timer set condition



The sleep timer turns the transceiver power OFF automatically after passing the set period. The timer can be set to 5–120 min. in 5 min. steps.

The sleep timer function counts the ‘minute’ units, and does not count the ‘second’ units. For example, when the sleep timer is started at 12:00 59, First one minute past for just 1 sec. The maximum error is therefore 59 sec. This is normal, not a malfunction.

- ① Push **[EXIT/SET]** several times to close multi-function screen, if necessary.
- ② Push **[SET] (F-6)** to select set mode menu screen.
- ③ Push **[TIME] (F-4)** to select time set mode.
- ④ Push **[TIMER] (F-2)** to select timer set mode.
- ⑤ Push **[SLEEP] (F-6)** to select the sleep timer set condition.
 - “---” blinks.
- ⑥ Set the desired time period using the main dial.
 - “TIMER–set Push [SET]” blinks.
 - Push **[CLR] (F-4)** to select “---” to cancel the setting.
- ⑦ Push **[SET] (F-6)** to set the time.
 - Push **[EXIT/SET]** to cancel the setting.
 - The timer indicator appears.
- ⑧ Push **[EXIT/SET]** to exit timer set screen.
- ⑨ The transceiver emits 10 beeps and turns OFF after the sleep timer period elapses.
 - The timer indicator blinks while beeping.
 - Push **[POWER]** momentarily to cancel the sleep timer, if desired.

Timer operation

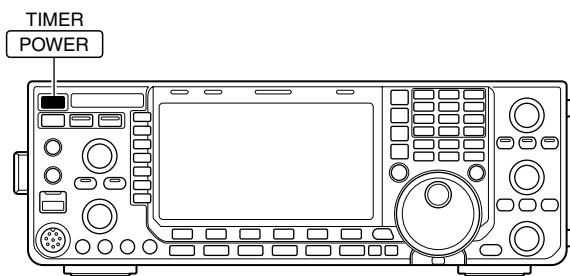

Appears

- ① Preset the daily timer as described on previously to turn the timer function ON.
 - The timer indicator appears.
- ② Push and hold **[POWER]** for 1 sec. to turn the power OFF.
 - The indicator on this switch lights red when the timer function is ON.
- ③ When the set time arrives, the power is automatically turned ON.
- ④ The transceiver emits 10 beeps and turns OFF after the power-off period elapses.
 - The timer indicator blinks while beeping.
 - Push **[POWER]** momentarily to turn the timer function OFF, if desired.

Timer action in the timer set screen must be selected ON to enable timer operation, described in page 116 step ⑥.

■ Set mode description

Set mode is used for programming infrequently changed values or conditions of functions. The IC-7600 has a level set mode, display set mode, time set mode, accessory set mode, others set mode and USB-Memory set menu.

◇ Set mode operation

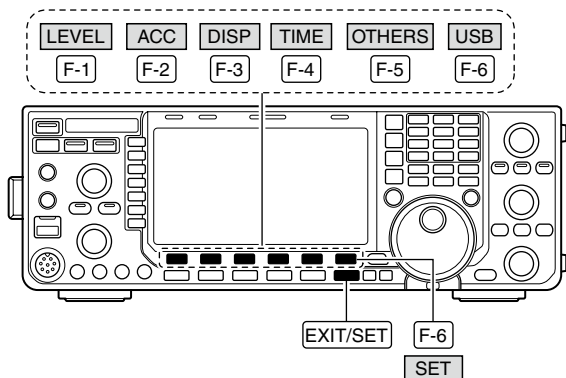

• Set mode screen

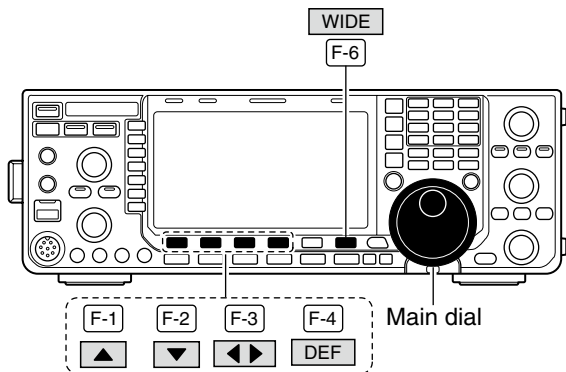

- ① Push **[EXIT/SET]** several times to close a multi-function screen, if necessary.
- ② Push **[SET] (F-6)** to select set mode menu screen.
 - Pushing and holding **[EXIT/SET]** for 1 sec. also selects set mode menu screen.
- ③ Push **[LEVEL] (F-1)**, **[ACC] (F-2)**, **[DISP] (F-3)**, **[TIME] (F-4)**, **[OTHERS] (F-5)** or **[USB] (F-6)** to enter the desired set mode.
- ④ For level, accessory, display and Others set mode, push **[WIDE] (F-6)** to toggle wide and normal screen.
- ⑤ Push **[▲] (F-1)** or **[▼] (F-2)** to select the desired item, then rotate the main dial to adjust/select the desired value or condition.
 - Pushing **[◀ ▶] (F-3)** operation may be necessary for some items.
 - Push and hold **[DEF] (F-4)** select a default condition or value.
- ⑥ Push **[EXIT/SET]** twice to exit set mode.

◆ Screen arrangement



• Display set mode (p. 126)



• Set mode menu screen (p. 118)

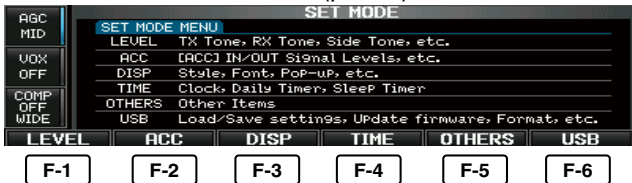

• Time set mode (p. 115)



• Level set mode (p. 120)



• Others set mode (p. 128)

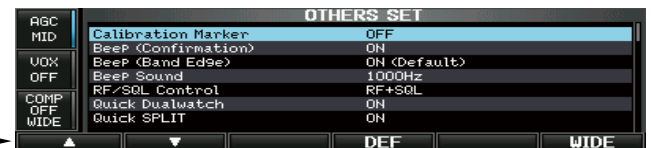

• ACC set mode (p. 124)



• USB-Memory set menu (p. 136)



■ Level set mode

SSB RX HPF/LPF 	
Sets the high-pass filter (100 to 2000 Hz) and low-pass filter (500 to 2400 Hz) of the receive audio in 100 Hz steps in SSB mode. (default: OFF)	
NOTE: When this setting is active, below 2 items will be reset to default value, '0.'	
SSB RX Tone (Bass)  0	
Sets the bass level of the receive audio tone in SSB mode from -5 to +5. (default: 0)	
SSB RX Tone (Treble)  0	
Sets the treble level of the receive audio tone in SSB mode from -5 to +5. (default: 0)	
AM RX HPF/LPF 	
Sets the high-pass filter (100 to 2000 Hz) and low-pass filter (500 to 2400 Hz) of the receive audio in 100 Hz steps in AM mode. (default: OFF)	
NOTE: When this setting is active, below 2 items will be reset to default value, '0.'	
AM RX Tone (Bass)  0	
Sets the bass level of the receive audio tone in AM mode from -5 to +5. (default: 0)	
AM RX Tone (Treble)  0	
Sets the treble level of the receive audio tone in AM mode from -5 to +5. (default: 0)	
FM RX HPF/LPF 	
Sets the high-pass filter (100 to 2000 Hz) and low-pass filter (500 to 2400 Hz) of the receive audio in 100 Hz steps in FM mode. (default: OFF)	
NOTE: When this setting is active, below 2 items will be reset to default value, '0.'	
FM RX Tone (Bass)  0	
Sets the bass level of the receive audio tone in FM mode from -5 to +5. (default: 0)	
FM RX Tone (Treble)  0	
Sets the treble level of the receive audio tone in FM mode from -5 to +5. (default: 0)	

■ Level set mode (Continued)

CW RX HPF/LPF

Sets the high-pass filter (100 to 2000 Hz) and low-pass filter (500 to 2400 Hz) of the receive audio in 100 Hz steps in CW mode. (default: OFF)

RTTY RX HPF/LPF

Sets the high-pass filter (100 to 2000 Hz) and low-pass filter (500 to 2400 Hz) of the receive audio in 100 Hz steps in RTTY mode. (default: OFF)

PSK RX HPF/LPF

Sets the high-pass filter (100 to 2000 Hz) and low-pass filter (500 to 2400 Hz) of the receive audio in 100 Hz steps in PSK mode. (default: OFF)

SSB TX Tone (Bass)

Sets the bass level of the transmit audio tone in SSB mode from -5 to +5. (default: 0)

SSB TX Tone (Treble)

Sets the treble level of the transmit audio tone in SSB mode from -5 to +5. (default: 0)

AM TX Tone (Bass)

Sets the bass level of the transmit audio tone in AM mode from -5 to +5. (default: 0)

AM TX Tone (Treble)

Sets the treble level of the transmit audio tone in AM mode from -5 to +5. (default: 0)

FM TX Tone (Bass)

Sets the bass level of the transmit audio tone in FM mode from -5 to +5. (default: 0)

FM TX Tone (Treble)

Sets the treble level of the transmit audio tone in FM mode from -5 to +5. (default: 0)

SSB TBW (WIDE)	100 – 2900
Sets the transmission passband width to a wide setting by changing the lower and higher cut-off frequencies.	<ul style="list-style-type: none"> • Lower freq. : 100 (default), 200, 300 and 500 Hz • Higher freq. : 2500, 2700, 2800 and 2900 Hz (default)

SSB TBW (MID)	300 – 2700
Sets the transmission passband width to a middle setting by changing the lower and higher cut-off frequencies.	<ul style="list-style-type: none"> • Lower freq. : 100, 200, 300 (default) and 500 Hz • Higher freq. : 2500, 2700 (default), 2800 and 2900 Hz

SSB TBW (NAR)	500 – 2500
Sets the transmission passband width to a narrow setting by changing the lower and higher cut-off frequencies.	<ul style="list-style-type: none"> • Lower freq. : 100, 200, 300 and 500 Hz (default) • Higher freq. : 2500 (default), 2700, 2800 and 2900 Hz

Drive Gain	 50%
Sets the drive gain level from 0% to 100% in 1% steps. (default: 50%) While talking into the microphone, keying down or transmitting, rotate the main dial so that the ALC meter reading is between 30% to 50% of the ALC scale. (p. 37) The drive gain is active for all modes other than SSB mode with speech compressor OFF.	

Speech Level	 50%
Sets the voice synthesizer audio output level from 0% to 100% in 1% steps. (default: 50%)	

Side Tone Level	 50%
Sets the sidetone output level from 0% to 100% in 1% steps. (default: 50%)	

Side Tone Level Limit	ON
Turns the sidetone output level limiting capability ON and OFF. (default: ON) When this item is set to ON, the CW sidetone is linked to the [AF] control until rotation of the [AF] control reaches to the specified level—further rotation will not increase the volume of the CW sidetones.	<ul style="list-style-type: none"> • OFF : CW sidetone level is linked to the [AF] control. • ON : CW sidetone level is limited with the [AF] control.

☞ Continues to the next page.

■ Level set mode (Continued)

Beep Level		50%
Sets the beep output level from 0% to 100% in 1% steps. (default: 50%)		

Beep Level Limit	ON
Turns the beep tone output level limiting capability ON and OFF for the confirmation and band edge beep tones. (default: ON)	<ul style="list-style-type: none">• OFF : Beep level is linked to the [AF] control.• ON : Beep level is limited with the [AF] control.
When this item is set to ON, the beep tones are linked to the [AF] control until rotation of the [AF] control reaches to the specified level—further rotation will not increase the volume of the beep tones.	

■ ACC set mode

USB Audio SQL	OFF (OPEN)
<p>Sets the squelch condition of the USB audio which is output from the [USB] (B) connector on the rear panel.</p> <p>The same audio signals are output from [USB] (B) and the ACC sockets.</p> <ul style="list-style-type: none"> • The beep tones and the voice synthesizer announcements are not output. • The received audio output level cannot be adjusted with the [AF] control. 	<ul style="list-style-type: none"> • OFF (OPEN) : The received audio is always output regardless of the squelch condition. (default) • ON : The received audio is output according to the squelch condition (open/close).

USB MOD Level	 50%
<p>Sets the input modulation level of the [USB] (B) connector from 0% to 100% in 1% steps. (default: 50%)</p>	

DATA OFF MOD	MIC,ACC
<p>Selects the desired connector(s) for modulation input when data mode is not in use.</p>	<ul style="list-style-type: none"> • MIC : Use the signals from [MIC]. • ACC : Use the signals from [ACC1] (pin 4). • MIC,ACC : Use the signals from [MIC] and [ACC1] (pin 4). (default) • USB : Use the signals from [USB] (B).

DATA1 MOD	ACC
<p>Selects the desired connector(s) for modulation input when data 1 mode (D1) is in use.</p>	<ul style="list-style-type: none"> • MIC : Use the signals from [MIC]. • ACC : Use the signals from [ACC1] (pin 4). (default) • MIC,ACC : Use the signals from [MIC] and [ACC1] (pin 4). • USB : Use the signals from [USB] (B).

DATA2 MOD	MIC,ACC
<p>Selects the desired connector(s) for modulation input when data 2 mode (D2) is in use.</p>	<ul style="list-style-type: none"> • MIC : Use the signals from [MIC]. • ACC : Use the signals from [ACC1] (pin 4). • MIC,ACC : Use the signals from [MIC] and [ACC1] (pin 4). (default) • USB : Use the signals from [USB] (B).

DATA3 MOD	MIC
<p>Selects the desired connector(s) for modulation input when data 3 mode (D3) is in use.</p>	<ul style="list-style-type: none"> • MIC : Use the signals from [MIC]. (default) • ACC : Use the signals from [ACC1] (pin 4). • MIC,ACC : Use the signals from [MIC] and [ACC1] (pin 4). • USB : Use the signals from [USB] (B).



☞ Continues to the next page.

■ ACC set mode (Continued)



SEND Relay Type	Lead
<p>Selects the switching relay type for [RELAY] from Lead and MOSFET.</p> <p>Select the suitable relay type when connecting a non-lcom linear amplifier.</p>	<ul style="list-style-type: none"> • Lead : Use mechanical relay. (16 V DC/0.5 A max.; default) • MOS-FET : Use semiconductor type relay. (250 V/200 mA max.)

External Meter Output	Auto
<p>Selects the desired item for an external meter indication.</p>	<ul style="list-style-type: none"> • Auto : Outputs the receiving signal strength level during receive, and outputs the selected level (selected with [METER]), during transmit. (default) • S : Outputs the receiving signal strength level during receive. • Po : Outputs the transmitting power level during transmit. • SWR : Outputs the VSWR level during transmit. • ALC : Outputs the ALC level during transmit. • COMP : Outputs the compression level during transmit. • Vd : Outputs the drain terminal voltage of the final amplifier MOSFETs. • Id : Outputs the drain current of the final amplifier MOSFETs.

External Meter Level	 50%
<p>Sets the output level for an external meter indication with in 0% to 100% range in 1% steps.</p> <ul style="list-style-type: none"> • Approx. 2.5 V at 50% (default) setting for full-scale indication. (4.7 kΩ impedance) 	

REF Adjust	 50 % (Example)
<p>Adjusts the internal reference signal frequency within 0% to 100% range in 1% steps during frequency calibration.</p> <p> NOTE: Default setting is different for each transceiver.</p>	

■ Display set mode

Bright (LCD)		50%
Adjusts the LCD unit brightness from 0% (dark) to 100% (bright) range in 1% steps. (default: 50%)		
Backlight (Switches)		80
Adjusts the switch indicators brightness from 1 (dark) to 100 (bright) range in 1 steps. (default: 80)		
Display Type	A	
Selects the desired display type from A (Black back) and B (Blue back). (default: A)		
See p. 146 for details.		
Display Font	Basic	
Selects the desired font for frequency readout from Basic, Italic and Round. (default: Basic)		
See p. 146 for details.		
Meter Response	MID	
Set meter needle response from SLOW, MID and FAST. (default: MID)		
This setting is effective for the standard and edge-wise meter type selections only.		
Meter Type (Normal Screen)	Standard	
Selects the desired S/RF meter type during normal screen indication from Standard, Edgewise and Bar. (default: Standard)		
Meter Type (Wide Screen)	Bar	
Selects the desired S/RF meter type during wide screen or mini scope indication from Edgewise and Bar. (default: Bar)		
Meter Peak Hold (Bar)	ON	
Turns the meter peak hold function ON and OFF. (default: ON)		
This function is used for the bar meter only.		
Memory Name	ON	
Sets the memory name indication, during memory mode operation, ON and OFF. (default: ON)		
<ul style="list-style-type: none"> • OFF : No memory name is displayed even a memory name is programmed. • ON : The programmed memory name is displayed above the frequency indication. 		

➤ Continues to the next page.

■ Display set mode (Continued)

APF-Width Popup (APF OFF→ON) ON

Selects the pop-up display for the APF filter width from ON and OFF. (default: ON)

MN-Q Popup (MN OFF→ON) ON

Enables the pop-up indication capability when the notch filter width is changed from ON to OFF. (default: ON)

Screen Saver Function 60min

Turns the screen saver function ON (15, 30 or 60 minutes) and OFF. (default: 60 min.)

The screen saver will activate when no operation is performed for the selected time period to protect the LCD from the “burn-in” effect.

Screen Saver Type Bound

Selects the screen saver type from “Bound,” “Rotation” and “Twist.” (default: Bound)

The screen saver indication can be displayed for your reference while pushing and holding [PREVIEW] (F-5).

Opening Message ON

Turns the opening message screen indication capability ON and OFF. (default: ON)

My Call

Sets the introductory text, up to 10-character long, displayed in the opening screen.

Usually, you set your call sign for the opening screen.

Capital letters, numerals, some symbols (– / . @) and spaces can be used.

When a PC keyboard is connected to [USB] connector on the front panel, the call sign can also be edited from the keyboard.

- 1 Push [EDIT] (F-5) to select the name edit condition.
 - The cursor under the 1st character blinks.
- 2 Push [ABC] (MF6), [123] (MF7) or [Symbol] (MF7) to select the character group, then rotate the main dial to select the character.
 - Push [123] (MF7) or [Symbol] (MF7) to toggle numerals and symbols.
 - Push [◀] (F-1) or [▶] (F-2) for cursor movement.
 - Push [DEL] (F-3) to delete the selected character.
 - Push [SPACE] (F-4) to input a space.
 - Pushing the transceiver’s keypad, [0]–[9] and [.] can also enter numerals.
- 3 Push [EXIT/SET] to set the name.

Others set mode

<p>Calibration Marker</p> <p>This item is used for a simple frequency check of the transceiver. (default: OFF) See p. 147 for calibration procedure.</p> <p>/// NOTE: Turn the calibration marker OFF after checking the frequency of the transceiver.</p>	<p>OFF</p> <ul style="list-style-type: none"> • OFF : Calibration marker OFF • ON : Calibration marker ON
<p>Beep (Confirmation)</p> <p>A beep sounds each time a switch is pushed to confirm it. This function can be turned OFF for silent operation. (default: ON)</p> <p>The beep output level can be set in level set mode. (p. 123)</p>	<p>ON</p> <ul style="list-style-type: none"> • OFF : Confirmation beep OFF • ON : Confirmation beep ON
<p>Beep (Band Edge)</p> <p>A beep sounds when an operating frequency enters or exits an amateur band. This functions independent of the confirmation beep setting (above).</p> <p>The beep output level can be set in level set mode. (p. 123)</p> <p>When “ON (User)” or “ON (User) & TX Limit” is selected, [BAND] appears in the display above the function switch (F-5), and up to 30 band edge frequencies can be set in band edge screen.</p>	<p>ON (Default)</p> <ul style="list-style-type: none"> • OFF : Band edge beep OFF • ON (Default): Band edge beep sounds when an operating frequency enters or exits a default amateur band. (default) • ON (User) : A beep sounds when an operating frequency enters or exits an amateur band that is set in band edge screen. (p. 31) • ON (User) & TX Limit : A beep sounds when an operating frequency enters or exits an amateur band that is set in band edge screen and TX is limited out of the band. (p. 31)
<p>Beep Sound</p> <p>Sets the desired beep frequency within 500 to 2000 Hz in 10 Hz steps. (default: 1000 Hz)</p>	<p>1000Hz</p>
<p>RF/SQL Control</p> <p>The [RF/SQL] control can be set as the RF/squelch control (default), the squelch control only (RF gain is fixed at maximum) or ‘Auto’ (RF gain control in SSB, CW, RTTY and PSK; squelch control in AM and FM).</p> <p>See pgs. 2, 33 for details.</p>	<p>RF+SQL</p> <ul style="list-style-type: none"> • AUTO : [RF/SQL] control as RF gain control in SSB, CW, RTTY and PSK; squelch control in AM and FM • SQL : [RF/SQL] control as squelch control • RF+SQL : [RF/SQL] control as RF/squelch control (default)
<p>Quick Dualwatch</p> <p>When this item is set to ON, pushing and holding [DUALWATCH] for 1 sec. sets the sub readout frequency to the main readout frequency, and activates dualwatch operation. (default: ON)</p>	<p>ON</p> <ul style="list-style-type: none"> • OFF : Quick dualwatch OFF • ON : Quick dualwatch ON

☞ Continues to the next page.

■ Others set mode (Continued)

Quick SPLIT**ON**

When this item is set to ON, pushing and holding [SPLIT] for 1 sec. sets the unselected VFO's readout frequency and operating mode to the selected VFO's readout, and activates split operation. (default: ON)

- OFF : Quick split OFF
- ON : Quick split ON

See p. 89 for details.

FM SPLIT Offset (HF)**-0.100MHz**

Sets the offset (difference between transmit and receive frequencies) for the quick split function. This setting is used for HF bands in FM mode only and is used to input the repeater offset for an HF band.

The offset frequency can be set from -9.999 to +9.999 MHz in 1 kHz steps. (default: -0.100 MHz)

FM SPLIT Offset (50M)**-0.500MHz**

Sets the offset (difference between transmit and receive frequencies) for the quick split function. This setting is used for 50 MHz band FM mode only, and is used to input the repeater offset for the 50 MHz band.

The offset frequency can be set from -9.999 to +9.999 MHz in 1 kHz steps. (default: -0.500 MHz)

SPLIT LOCK**OFF**

When this item is ON, the main dial can be used to adjust the transmit frequency while pushing [XFC] even while the lock function is activated. (default: OFF)

- OFF : Split lock OFF
- ON : Split lock ON

See pgs. 88, 89 for split frequency operation details.

Tuner (Auto Start)**OFF**

The internal antenna tuner has an automatic start capability which starts tuning if the SWR is high. (default: OFF)

- OFF : The tuner remains OFF even when the SWR is high.
- ON : Automatic tune starts even when the tuner is turned OFF during HF bands operation.

Tuner (PTT Start)**OFF**

Tuning of the internal/external antenna tuner can be started automatically at the moment the [PTT] is pushed after the operating frequency is changed (more than 1% from last-tuned frequency). (default: OFF)

- OFF : Tuning starts only when [TUNER] is pushed.
- ON : **(Internal antenna tuner)** Tuning starts when [PTT] is pushed on a new frequency (more than 1% from last-tuned frequency) if the internal antenna tuner is ON.
(External antenna tuner) Tuning always starts when [PTT] is pushed on a new frequency (more than 1%) regardless of the external antenna tuner ON/OFF.

Tuner Preset Memory Clear

The preset memory* of the selected antenna can be cleared with pushing [CLR] (F-5).

* The variable capacitor settings are memorized as a preset point for each frequency range (100 kHz steps) after the tuner matches an antenna.

- ANT1 Push [CLR] : The preset memory of the antenna that is connected to [ANT 1] is cleared after pushing [CLR] (F-5).
- ANT2 Push [CLR] : The preset memory of the antenna that is connected to [ANT 2] is cleared after pushing [CLR] (F-5).

[ANT] Switch

You can set the antenna connector selection to automatic, manual or non-selection (when using 1 antenna only). (default: Auto)

Auto

- OFF : Antenna switch is not activated and does not function. The [ANT1] connector is always selected.
- Manual : Antenna switch is activated and selects an antenna manually.
- Auto : Antenna switch is activated and the band memory memorizes the selected antenna. See p. 112 for details.

Transverter Function

Selects the transverter operation condition from Auto and ON. (default: Auto)

Auto

- Auto : The transceiver turns into transverter operation condition when 2 to 13.8 V DC is applied to [ACC2] pin 6.
- ON : Turn the transverter operation ON.

Transverter Offset

16.000MHz (14.100.0→30.100.0)

Sets the desired offset frequency for the transverter operation within 0.000 to 99.999 MHz in 1 kHz steps. (default: 16.000 MHz)

RTTY Mark Frequency

2125

Selects the RTTY mark frequency. RTTY mark frequency is switched between 1275, 1615 and 2125 Hz. (default: 2125 Hz)

2125 Hz is automatically selected when the internal RTTY decoder is used.

RTTY Shift Width

170

Selects the RTTY shift width. There are 3 selectable values: 170, 200 and 425 Hz. (default: 170 Hz)

170 Hz is automatically selected when the internal RTTY decoder is used.

☞ Continues to the next page.

■ Others set mode (Continued)

<p>RTTY Keying Polarity</p> <p>Selects the RTTY keying polarity. Normal or reverse keying polarity can be selected. (default: Normal)</p> <p>When reverse polarity is selected, Mark and Space are reversed.</p>	<p>Normal</p> <ul style="list-style-type: none"> • Normal : Key open/close = Mark/Space • Reverse : Key open/close = Space/Mark
<p>PSK Tone Frequency</p> <p>Selects the desired PSK tone frequency for the PSK reception from 1000, 1500 and 2000 Hz. (default: 1500 Hz)</p>	<p>1500</p>
<p>SPEECH Language</p> <p>Selects the speech language from English and Japanese. (default: English)</p>	<p>English</p>
<p>SPEECH Speed</p> <p>Selects the speech speed from HIGH (faster) and LOW (slower). (default: HIGH)</p>	<p>HIGH</p>
<p>SPEECH S-Level</p> <p>The IC-7600 speech processor can announce frequency, mode and signal level. Signal level announcement can be deactivated if desired. (default: ON)</p> <p>When "OFF" is selected, the signal level is not announced.</p>	<p>ON</p> <ul style="list-style-type: none"> • OFF : Signal level is not announced. (Operating frequency and mode is announced.) • ON : Signal level, operating frequency and mode is announced.
<p>SPEECH [MODE] Switch</p> <p>Selects the operating mode speech capability when a mode switch is pushed; ON or OFF. (default: OFF)</p>	<p>OFF</p> <ul style="list-style-type: none"> • OFF : Operating mode speech capability OFF • ON : Operating mode speech capability ON The selected operating mode is announced when a mode switch is pushed.
<p>[SPEECH/LOCK] Switch</p> <p>Selects the [SPEECH/LOCK] switch action. (default: SPEECH/LOCK)</p>	<p>SPEECH/LOCK</p> <ul style="list-style-type: none"> • SPEECH/LOCK : (Push) The voice synthesizer function is activated. (Push and hold) The dial lock function is turned ON or OFF. • LOCK/SPEECH : (Push) The dial lock function is turned ON or OFF. (Push and hold) The voice synthesizer function is activated.

Memopad Numbers	5
<p>Sets the number of memo pad channels available. 5 or 10 memo pads can be selected. (default: 5)</p>	
MAIN DIAL Auto TS	HIGH
<p>Sets the auto tuning step function for the main dial. When rotating the main dial rapidly, the tuning step automatically changes several times as selected.</p> <p>There are 2 type of auto tuning steps: HIGH (Fastest) and LOW (Faster). (default: HIGH)</p> <ul style="list-style-type: none"> • HIGH : Approx. 5 times faster when the tuning step is set to 1 kHz or smaller steps; approx. 2 times faster when the tuning step is set to 5 kHz or larger steps. • LOW : Approx. 2 times faster • OFF : Auto tuning step is turned OFF. 	
MIC Up/Down Speed	HIGH
<p>Sets the rate at which frequencies are scanned when the microphone [UP]/[DN] switches are pushed and held. HIGH or LOW can be selected.</p> <ul style="list-style-type: none"> • LOW : Low speed (25 tuning steps/sec.) • HIGH : High speed (default; 50 tuning steps/sec.) 	
Quick RIT/ΔTX Clear	OFF
<p>Selects the RIT/ΔTX frequency clearing instruction with [CLEAR]. (default: OFF)</p> <ul style="list-style-type: none"> • OFF : Clears the RIT/ΔTX frequency when [CLEAR] is pushed and held for 1 sec. • ON : Clears the RIT/ΔTX frequency when [CLEAR] is pushed momentarily. 	
[NOTCH] Switch (SSB)	Auto/Manual
<p>Selects notch functions for SSB mode operation from Auto, Manual and Auto/Manual. (default: Auto/Manual)</p> <ul style="list-style-type: none"> • Auto : Only the auto notch can be used. • Manual : Only the manual notch can be used. • Auto/Manual : Both the auto and manual notch can be used. (default) 	
[NOTCH] Switch (AM)	Auto/Manual
<p>Selects notch functions for AM mode operation from Auto, Manual and Auto/Manual. (default: Auto/Manual)</p> <ul style="list-style-type: none"> • Auto : Only the auto notch can be used. • Manual : Only the manual notch can be used. • Auto/Manual : Both the auto and manual notch can be used. 	
SSB/CW Synchronous Tuning	OFF
<p>Selects the displayed frequency shift function from ON and OFF. (default: OFF)</p> <p>When this function is activated, the audio pitch or tones of the received signal will remain the same even when the operating mode is changed between SSB and CW.</p> <p>/// The amount of frequency shift may differ according to the CW pitch setting.</p> <ul style="list-style-type: none"> • OFF : The displayed frequency does not shift. • ON : The displayed frequency shifts when the operating mode is changed between SSB and CW. 	

☞ Continues to the next page.

■ Others set mode (Continued)

<p>CW Normal Side</p> <p>Selects the sideband used to receive CW in CW normal mode from LSB and USB. (default: LSB)</p>	<p>LSB</p>
<p>APF Type</p> <p>Select audio filter shape for APF from SOFT and SHARP. (default: SOFT)</p>	<p>SOFT</p> <ul style="list-style-type: none"> • SHARP : Sharp filter shape rejects interfering signals more aggressively. • SOFT : Soft filter shape makes distinguishing noise and signals easier. The audio filter width is related to the CW pitch setting.
<p>External Keypad (VOICE)</p> <p>Sets the external keypad for voice message transmission capability ON and OFF. (default: OFF)</p> <p>See page 18 for the equivalent circuit of an external keypad and connection.</p>	<p>OFF</p> <ul style="list-style-type: none"> • OFF : External keypad does not function. • ON : Pushing one of external keypad switches, transmits the desired voice message contents during a phone mode operation.
<p>External Keypad (KEYER)</p> <p>Sets the external keypad for keyer memory transmission capability ON and OFF. (default: OFF)</p> <p>See page 18 for the equivalent circuit of an external keypad and connection.</p>	<p>OFF</p> <ul style="list-style-type: none"> • OFF : External keypad does not function. • ON : Pushing one of external keypad switches, transmits the desired keyer memory contents during CW mode operation.
<p>External Keypad (RTTY)</p> <p>Sets the external keypad for RTTY TX memory (RT1 to RT4) transmission capability ON and OFF. (default: OFF)</p> <p>See page 18 for the equivalent circuit of an external keypad and connection.</p>	<p>OFF</p> <ul style="list-style-type: none"> • OFF : External keypad does not function. • ON : Pushing one of external keypad switches, transmits the desired RTTY TX memory contents during RTTY mode operation.
<p>External Keypad (PSK)</p> <p>Sets the external keypad for PSK TX memory (PT1 to PT4) transmission capability ON and OFF. (default: OFF)</p> <p>See page 18 for the equivalent circuit of an external keypad and connection.</p>	<p>OFF</p> <ul style="list-style-type: none"> • OFF : External keypad does not function. • ON : Pushing one of external keypad switches, transmits the desired PSK TX memory contents during PSK mode operation.

Keyboard [F1]–[F4] (VOICE)	OFF
Sets the voice message transmission capability ON and OFF when one of [F1]–[F4] key of the keyboard that is connected to the [USB] (A) connector on the front panel is pushed. (default: OFF)	<ul style="list-style-type: none">• OFF : [F1]–[F4] key of the connected keyboard does not function.• ON : Pushing one of [F1]–[F4] key of the connected keyboard transmits the desired voice message contents during a phone mode operation.

Keyboard [F1]–[F4] (KEYER)	OFF
Sets the keyer memory transmission capability ON and OFF when one of [F1]–[F4] key of the keyboard that is connected to the [USB] (A) connector on the front panel is pushed. (default: OFF)	<ul style="list-style-type: none">• OFF : [F1]–[F4] key of the connected keyboard does not function.• ON : Pushing one of [F1]–[F4] key of the connected keyboard transmits the desired keyer memory contents during CW mode operation.

CI–V Baud Rate	Auto
Sets the CI–V data transfer rate. 300, 1200, 4800, 9600, 19200 bps and “Auto” are available. (default: Auto)	
When “Auto” is selected, the baud rate is automatically set according to the data rate of connected controller.	

CI–V Address	7Ah
To distinguish equipment, each CI–V transceiver has its own Icom standard address in hexadecimal code. The IC-7600’s address is 7Ah.	
When 2 or more IC-7600’s are connected to an optional CT-17 CI–V LEVEL CONVERTER, rotate the main dial to select a different address for each IC-7600; the range is 01h to 7Fh.	

CI–V Transceive	ON
Transceive operation is possible with the IC-7600 connected to other Icom HF transceivers or receivers. (default: ON)	<ul style="list-style-type: none">• OFF : Transceive operation OFF• ON : Transceive operation ON Changing the frequency, operating mode, etc. on the IC-7600 automatically changes those of connected transceivers (or receivers) and vice versa.

USB Serial Function	CI–V
Select [USB] connector output data format from CI–V and Decode. (default: CI–V)	<ul style="list-style-type: none">• CI–V : Outputs data in CI–V format.• Decode : Outputs decoded contents in ASCII code format.

➤ Continues to the next page.

■ Others set mode (Continued)

Decode Baud Rate **9600**

Selects data transmission speed (Baud rate) when “Decode” is selected in “USB Serial Function”; settings are 300, 1200, 4800, 9600 and 19200 bps. (default: 9600)

Keyboard Type **English**

Selects the connected keyboard type from English, Japanese, United Kingdom, French, French (Canadian), German, Portuguese, Portuguese (Brazilian), Spanish, Spanish (Latin American) and Italian. (default: English)

Keyboard Repeat Delay **250ms**

Sets the time period for delay from 100 to 1000 msec. in 50 msec. steps. (default: 250 msec.)

When a key of the connected keyboard is pushed and held for the set period, the character is input continuously.

Keyboard Repeat Rate **10.9cps**

Sets the repeating rate for the connected keyboard within 2.0 to 30.0 cps. (default: 10.9 cps)

*cps=character per second

When a key of the connected keyboard is pushed and held, the character is repeatedly input with the set speed.

• Available repeating rate

2.0, 2.1, 2.3, 2.5, 2.7, 3.0, 3.3, 3.7, 4.0, 4.3, 4.6, 5.0, 5.5, 6.0, 6.7, 7.5, 8.0, 8.6, 9.2, 10.0, 10.9, 12.0, 13.3, 15.0, 16.0, 17.1, 18.5, 20.0, 21.8, 24.0, 26.7, 30.0

■ USB-Memory set menu

◇ USB-Memory set screen arrangement

• USB-Memory set menu

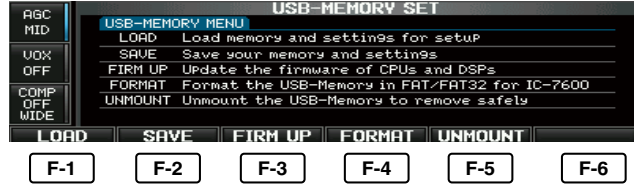

The USB-Memory is not supplied by Icom.

• Setting load screen (p. 137)

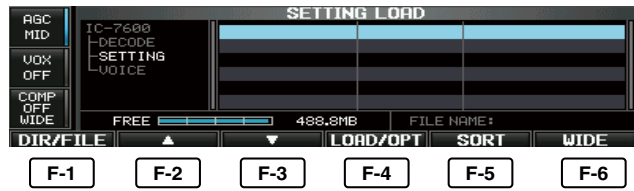

Push and hold for 1 sec.

• Load option set mode (p. 138)

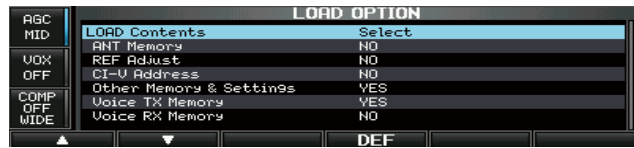

• Firmware update (p. 164)



• Format menu (p. 143)



• Setting save screen (p. 139)

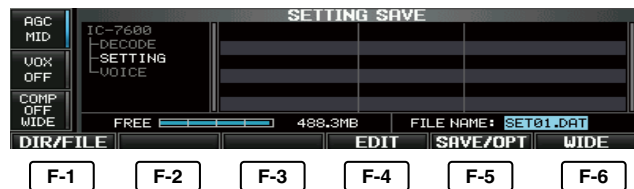

Push and hold for 1 sec.

• Save option set mode (p. 140)

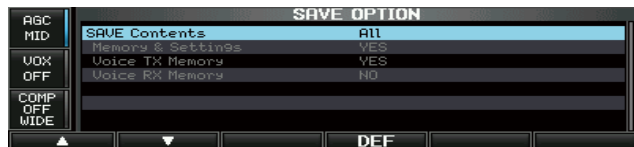

• Unmount USB-Memory (p. 142)



■ File loading

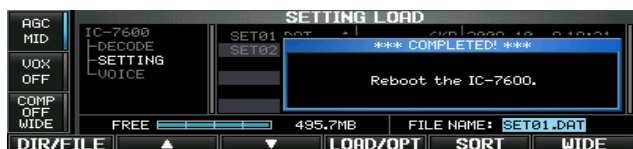
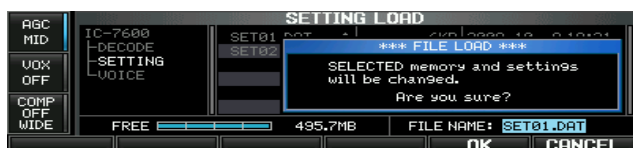
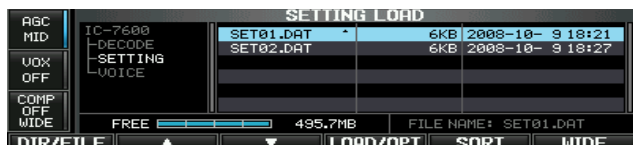
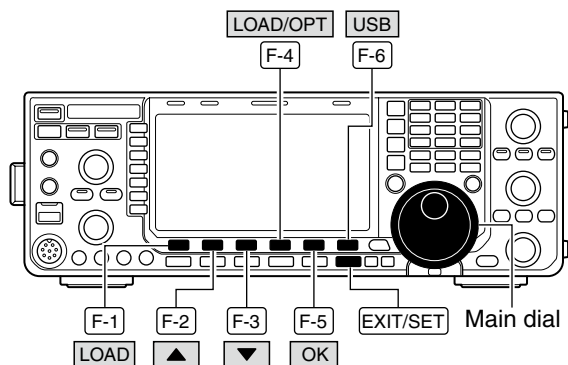

By loading the saved setting file from the USB-Memory, you can easily set up another IC-7600 or apply the several operators settings to one IC-7600.

- ① During set mode menu screen indication, push **[USB] (F-6)** to select USB set menu screen.
- ② Push **[LOAD] (F-1)** to select setting load screen.
- ③ Push and hold **[LOAD/OPT] (F-4)** for 1 sec. to select load option set mode, then rotate the main dial to set the desired loading conditions, if desired.
 - See page 138 for details.
- ④ Push **[EXIT/SET]** to set.
- ⑤ Push **[▲] (F-2)** or **[▼] (F-3)** to select the desired setting file.
 - Confirmation screen appears.
- ⑥ Push **[LOAD/OPT] (F-4)**.
 - Confirmation screen appears.
- ⑦ Push **[OK] (F-5)** to starts loading.
 - After the loading is completed, the message dialog, "Reboot the IC-7600," appears.
- ⑧ Turn the transceiver power OFF then ON to make the setting effective.

◇ Load option set mode

LOAD Contents	Select
Selects file load condition from All and Select. (default: Select)	<ul style="list-style-type: none"> • All : Loads and sets the all following contents. • Select : Loads and sets the selected contents only.
ANT Memory	NO
Selects the antenna memory setting loading condition from YES and NO. (default: NO)	<ul style="list-style-type: none"> • YES : Loads and sets the antenna memory. • NO : Use the original antenna memory setting.
REF Adjust	NO
Selects the reference signal setting load condition from YES and NO. (default: NO)	<ul style="list-style-type: none"> • YES : Loads and sets the reference signal setting. • NO : Use the original reference signal setting.
CI-V Address	NO
Selects the CI-V address setting load condition from YES and NO. (default: NO).	<ul style="list-style-type: none"> • YES : Loads and sets the CI-V address setting. • NO : Use the original CI-V address setting.
Other Memory & Settings	YES
This setting is fixed "YES."	<ul style="list-style-type: none"> • YES : Loads and sets memory channel contents and other settings.
Voice TX Memory	YES
Selects the voice TX message load condition from YES and NO. (default: YES)	<ul style="list-style-type: none"> • YES : Loads and sets voice TX message. • NO : Use the original voice TX message.
Voice RX Memory	NO
Selects the voice RX message load condition from YES and NO. (default: NO)	<ul style="list-style-type: none"> • YES : Loads and sets voice RX message. • NO : Use the original voice RX message.

■ File saving

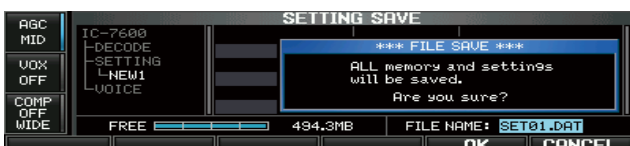
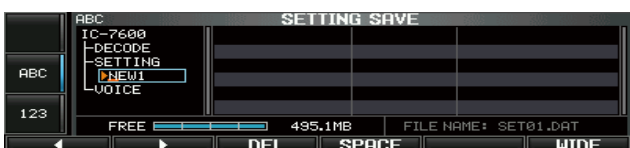
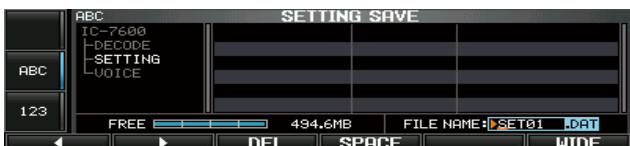
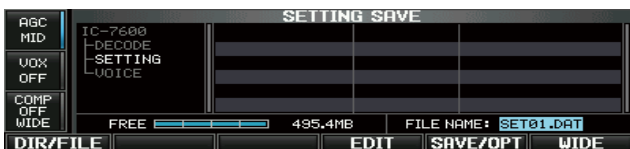
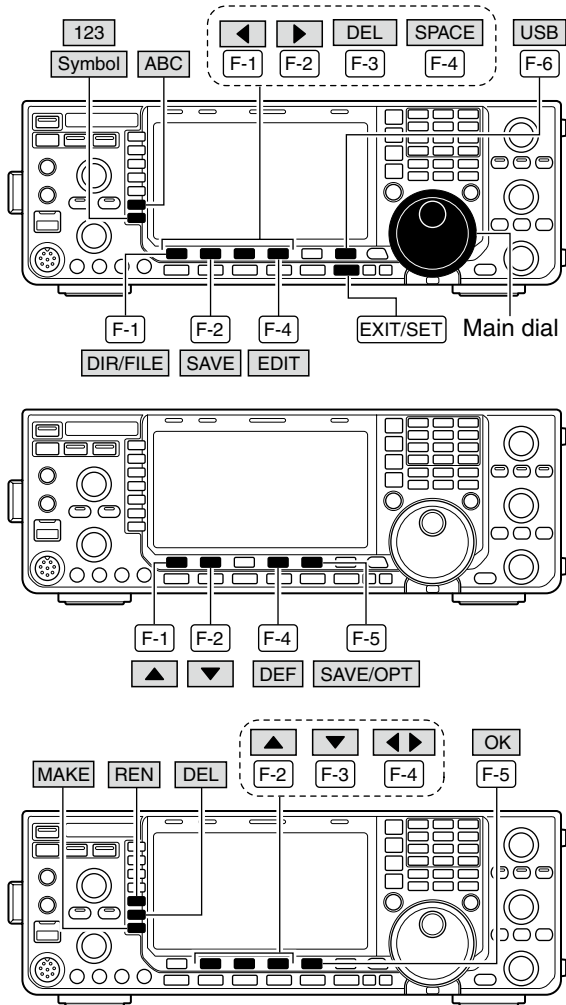

Memory channel contents, set mode settings, etc. can be saved into the USB-Memory for backup.

- ① During set mode menu screen indication, push **[USB] (F-6)** to select USB-Memory set menu screen.
- ② Push **[SAVE] (F-2)** to select setting save screen.
- ③ Change the following conditions if desired.

• File name:

- ① Push **[EDIT] (F-4)** to select file name edit condition.
 - Push **[DIR/FILE] (F-1)** several times to select the file name, if necessary.
- ② Push **[ABC] (MF6)** or **[123]/[Symbol] (MF7)** to select the character group, then rotate the main dial to select the character.
 - **[ABC] (MF6)**: A to Z (capital letters); **[123] (MF7)**: 0 to 9 (numerals); **[Symbol] (MF7)**: ! # \$ % & ' ` ^ - () { } _ ~ @ can be selected.
 - Push **[◀] (F-1)** to move the cursor left, push **[▶] (F-2)** to move the cursor right, push **[DEL] (F-3)** to delete a character and push **[SPACE] (F-4)** to insert a space.
- ③ Push **[EXIT/SET]** to set the file name.

• Save option

- ① Push and hold **[SAVE/OPT] (F-5)** for 1 sec. to enter save option set mode.
- ② Push **[▲] (F-1)** or **[▼] (F-2)** to select the item, then rotate the main dial to select the desired setting. (see p. 140 for details)
 - Push and hold **[DEF] (F-4)** for 1 sec. to select the default setting.
- ③ Push **[EXIT/SET]** to return to the previous indication.

• Saving location

- ① Push **[DIR/FILE] (F-1)** to select tree view screen.
- ② Select the desired directory or folder in the USB-Memory.
 - Push **[◀ ▶] (F-4)** to select the upper directory.
 - Push **[▲] (F-2)** or **[▼] (F-3)** to select folder in the same directory.
 - Push and hold **[◀ ▶] (F-4)** for 1 sec. to select a folder in the directory.
 - Push **[REN] (MF5)** to rename the folder.
 - Push and hold **[DEL] (MF6)** for 1 sec. to delete the folder.
 - Push and hold **[MAKE] (MF7)** for 1 sec. to making a new folder. (Edit the name with the same manner as the “File name” above.)
- ③ Push **[DIR/FILE] (F-1)** twice to select the file name.

- ④ Push **[SAVE/OPT] (F-5)**.

- Confirmation screen appears.

- ⑤ Push **[OK] (F-5)** to save.

- After saving is completed, return to USB-Memory set menu automatically.

When a PC keyboard is connected to [USB] connector on the front panel, the file name can also be edited from the keyboard. In this case, a USB hub is required.

◇ Save option set mode

SAVE Contents	All
Selects file save condition from All and Select. (default: All)	<ul style="list-style-type: none">• All : Saves all the following contents.• Select : Saves the selected contents only.
Memory & Settings	YES
This setting is fixed "YES."	<ul style="list-style-type: none">• YES : Saves memory channel contents and settings of set modes.
Voice TX Memory	YES
Selects the voice TX message save condition from YES and NO. (default: YES)	<ul style="list-style-type: none">• YES : Saves the voice TX message.• NO : Does not save.
Voice RX Memory	NO
Selects the voice RX message save condition from YES and NO. (default: NO)	<ul style="list-style-type: none">• YES : Saves the voice RX message.• NO : Does not save.

■ Changing a file name

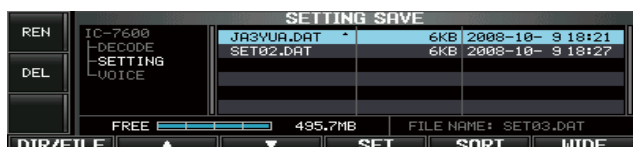
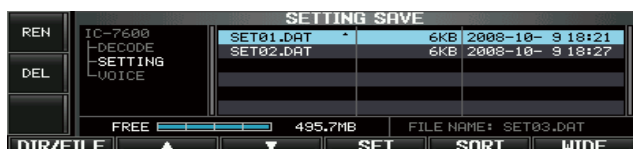
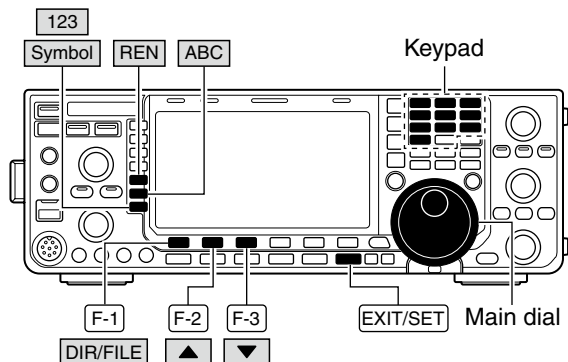

When a PC keyboard is connected to [USB] connector on the front panel, the file name can also be edited from the keyboard. In this case, a USB hub is required.

The file name, saved in the USB-Memory, can be re-named from the transceiver as desired.

- ① During setting save screen indication, push **[DIR/FILE] (F-1)** to select tree view screen.
 - Push **[▲] (F-2)** or **[▼] (F-3)** to select the desired folder.
 - “DECODE,” “SETTING” and “VOICE” folders are available as the default.
 - After the folder is selected, push and hold **[◀ ▶] (F-4)** for 1 sec. to display content folder(s), if available.
- ② Push **[DIR/FILE] (F-1)** to select file list screen.
- ③ Push **[▲] (F-2)** or **[▼] (F-3)** to select the desired file.
- ④ Push **[REN] (MF5)** momentarily to select the file name edit condition.
- ⑤ Push **[ABC] (MF6)** or **[123]/[Symbol] (MF7)** to select the character group, then rotate the main dial to select the character.
 - **[ABC] (MF6)**: A to Z (capital letters); **[123] (MF7)**: 0 to 9 (numerals); **[Symbol] (MF7)**: ! # \$ % & ' ` ^ - () { } _ - @ can be selected.
 - Push **[◀] (F-1)** to move the cursor left, push **[▶] (F-2)** to move the cursor right, push **[DEL] (F-3)** to delete a character and push **[SPACE] (F-4)** to insert a space.
 - Pushing the transceiver's keypad, [0]–[9] and [.] can also enter numerals.
- ⑥ Push **[EXIT/SET]** to set the file name.

■ Deleting a file

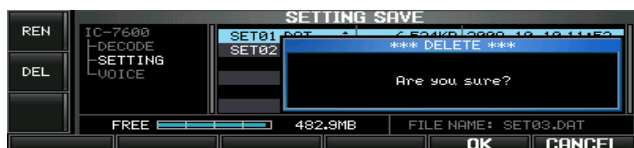
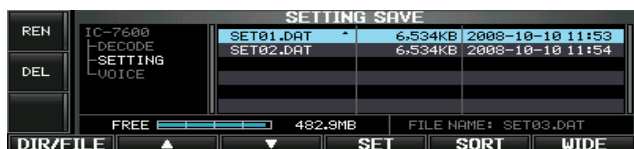
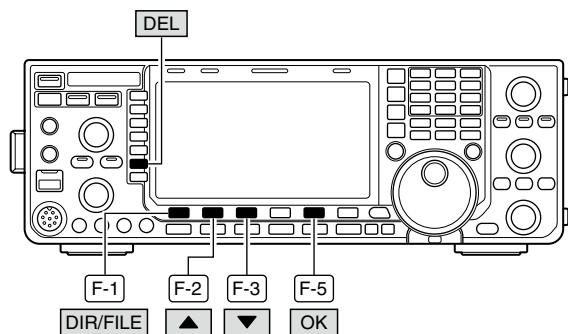

RECOMMENDATION! Deleting the setting file is irreversible. Confirm the contents before deleting a setting file!

- ① During setting save screen indication, push **[DIR/FILE] (F-1)** to select tree view screen.
 - Push **[▲] (F-2)** or **[▼] (F-3)** to select the desired folder.
 - “DECODE,” “SETTING” and “VOICE” folders are available as the default.
 - After folder is selected, push and hold **[◀ ▶] (F-4)** for 1 sec. to display content folder(s), if available.
- ② Push **[DIR/FILE] (F-1)** to select file list screen.
- ③ Push **[▲] (F-2)** or **[▼] (F-3)** to select the desired file to be deleted.
- ④ Push and hold **[DEL] (MF6)** for 1 sec.
 - Confirmation screen appears.
- ⑤ Push **[OK] (F-5)** to delete.
 - After the deleting, return to setting save screen automatically.

■ Unmounting USB-Memory

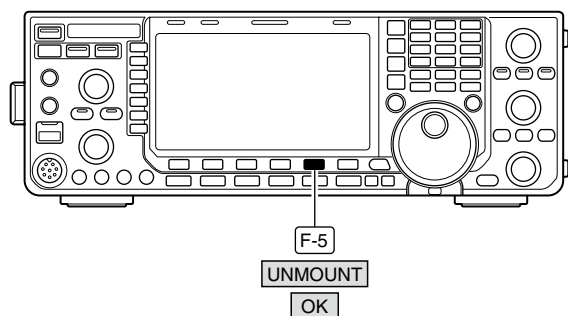

CAUTION: When removing the USB-Memory, unmount operation is recommended. If you do not unmount the memory in this case, data in the USB-memory may be corrupted.

- ① During USB-Memory set menu screen indication, push and hold **[UNMOUNT] (F-5)** for 1 sec.
 - Confirmation screen appears.
- ② Push **[OK] (F-5)** to unmount the USB-Memory.
- ③ After the indicator above **[USB] (A)** connector goes off, remove the USB-Memory.

■ Formatting the USB-Memory

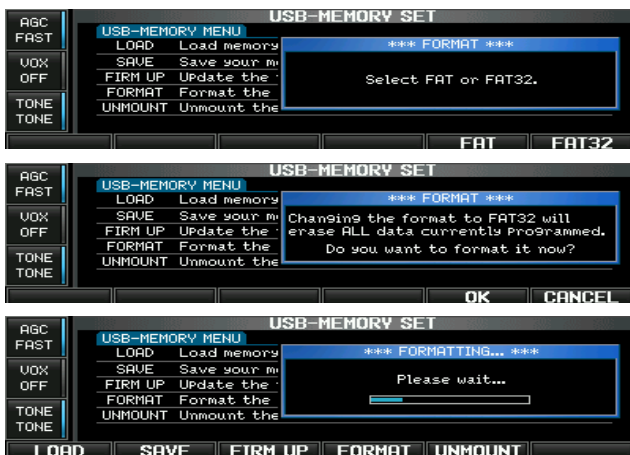
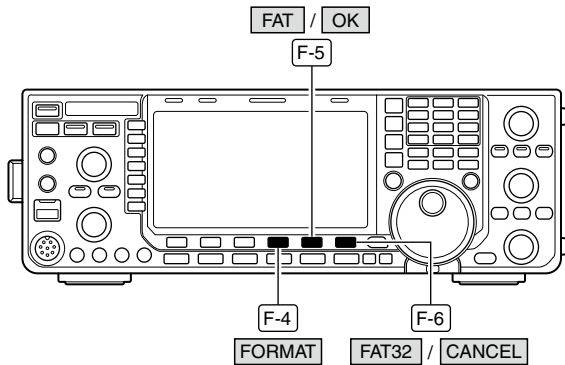

Saved data in the USB-Memory can be erased.

IMPORTANT! Formatting erases all saved data in the USB-Memory. Making a backup file on your PC is recommended.

- ① During USB-Memory set menu screen indication, push and hold **[FORMAT] (F-4)** for 1 sec.
 - Confirmation screen appears.
- ② Push **[FAT] (F-5)** or **[FAT32] (F-6)** to select the format type, FAT or FAT32, respectively.
 - Confirmation screen appears.
- ③ Push **[OK] (F-5)** to format.
 - Push **[CANCEL] (F-6)** to cancel.
- ④ Returns to USB-Memory set menu indication automatically.

NOTE: If no USB-Memory is inserted and **[FORMAT] (F-4)** is selected as in step ①, an error message appears as below.

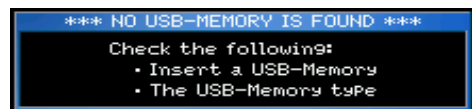

■ Troubleshooting

The following chart is designed to help you correct problems which are not equipment malfunctions.

If you are unable to locate the cause of a problem or solve it through the use of this chart, contact your nearest Icom Dealer or Service Center.

◇ Transceiver power

PROBLEM	POSSIBLE CAUSE	SOLUTION	REF.
Power does not come on when the [POWER] switch is pushed.	<ul style="list-style-type: none"> • Power cable is improperly connected. • Fuse is blown. 	<ul style="list-style-type: none"> • Re-connect the DC power cable correctly. • Check for the cause, then replace the fuse with the spare one. (Fuses are installed in the DC power cable and the internal PA unit.) 	p. 20 p. 149

◇ Transmit and receive

PROBLEM	POSSIBLE CAUSE	SOLUTION	REF.
No sounds from the speaker.	<ul style="list-style-type: none"> • Volume level is too low. • The squelch is closed. • The transceiver is in transmit. 	<ul style="list-style-type: none"> • Rotate the [AF] control clockwise to obtain a suitable listening level. • Rotate the [RF/SQL] control to 11 o'clock position to open the squelch. • Push [TRANSMIT] to receive or check the SEND line of an external unit, if connected. 	p. 34 p. 33 p. 36
Sensitivity is too low, and only strong signals are audible.	<ul style="list-style-type: none"> • The antenna is not connected properly. • The antenna for another band is selected. • The antenna is not properly tuned. • The attenuator is activated. 	<ul style="list-style-type: none"> • Re-connect to the antenna connector. • Select an antenna suitable for the operating frequency. • Push and hold [TUNER] for 1 sec. to manually tune the antenna. • Push [ATT] (MF4) several times to select "ATT OFF." 	— p. 112 p. 113 p. 72
Received audio is unclear or distorted.	<ul style="list-style-type: none"> • Wrong operating mode is selected. • PBT function is activated. • Noise blanker is turned ON when receiving a strong signal. • Preamp is activated. • The noise reduction is activated and the [NR] control is too far clockwise. 	<ul style="list-style-type: none"> • Select a suitable operating mode. • Push and hold [PBT-CLR] for 1 sec. to reset the function. • Push [NB] to turn the noise blanker OFF. • Push [P.AMP] (MF3) once or twice to turn the function OFF. • Set the [NR] control for maximum readability. 	p. 32 p. 75 p. 81 p. 72 p. 82
The [ANT] switch does not function	<ul style="list-style-type: none"> • The antenna switch has not been activated. 	<ul style="list-style-type: none"> • Set the antenna switch in set mode to "Auto" or "Manual." 	p. 130
Transmitting is impossible.	<ul style="list-style-type: none"> • The operating frequency is not inside a ham band. 	<ul style="list-style-type: none"> • Set the frequency to be in a ham band. 	p. 28
Output power is too low.	<ul style="list-style-type: none"> • The [RF POWER] control is set too far counterclockwise • The drive gain level is set too high. • The [MIC GAIN] control is set too far counterclockwise • The antenna for another band is selected. • The antenna is not properly tuned. 	<ul style="list-style-type: none"> • Rotate the [RF POWER] control clockwise. • Set the drive gain level to a suitable level. • Set the [MIC GAIN] control to a suitable position. • Select an antenna suitable for the operating frequency. • Push and hold [TUNER] for 1 sec. to manually tune the antenna. 	p. 36 p. 37 p. 36 p. 112 p. 113
No contact can be made with another station.	<ul style="list-style-type: none"> • RIT or ΔTX function is activated. • Split frequency function and/or dualwatch are/is activated. 	<ul style="list-style-type: none"> • Push [RIT] or [ΔTX] to turn the function OFF. • Push [SPLIT] and/or [DUALWATCH] to turn the function OFF. 	pgs. 73, 87 pgs. 79, 88
Transmit signal is unclear or distorted.	<ul style="list-style-type: none"> • The [MIC GAIN] control is set too far clockwise. • The speech compressor function is activated. 	<ul style="list-style-type: none"> • Set the [MIC GAIN] control to a suitable position. • Push [COMP] (MF7) to turn the function OFF. 	p. 37 p. 86
Repeater cannot be accessed.	<ul style="list-style-type: none"> • Split frequency function is not activated. • Programmed subaudible tone frequency is wrong. 	<ul style="list-style-type: none"> • Push [SPLIT] to to turn the function ON • Reset the frequency using set mode. 	p. 88 p. 28

◇ Scanning

PROBLEM	POSSIBLE CAUSE	SOLUTION	REF.
Programmed scan does not stop.	• Squelch is open.	• Set the [RF/SQL] control to the threshold point.	p. 33
Programmed scan does not start.	• The same frequencies have been programmed in scan edge memory channels P1 and P2.	• Program different frequencies in scan edge memory channel P1 and P2.	p. 101
Memory scan does not start.	• 2 or more memory channels have not been programmed.	• Program more than 2 memory channels.	p. 101
Select memory scan does not start.	• 2 or more memory channels have not been designated as select channels.	• Designate more than 2 memory channels as select channels for the scan.	p. 110

◇ Display

PROBLEM	POSSIBLE CAUSE	SOLUTION	REF.
The displayed frequency does not change properly.	• The dial lock function is activated.	• Push and hold [SPEECH/LOCK] for 1 sec. to turn the function OFF.	p. 82
	• A set mode screen is selected.	• Push [EXIT/SET] several times to exit the set mode screen.	p. 118
	• The internal CPU has malfunctioned.	• Reset the CPU.	p. 149
The display indicates the IC-7600 screen with “bound,” “rotation” or “twist” condition.	• The screen saver function is activated.	• Operate the transceiver. • Set the screen saver function in set mode to “OFF.”	— p. 127

◇ Format USB-Memory

PROBLEM	POSSIBLE CAUSE	SOLUTION	REF.
Format error appears when formatting in FAT32	• The inserted USB-Memory capacity is smaller than 64 MB.	• Insert a USB-Memory larger than 64 MB or select the FAT format.	p. 143
Format error appears when formatting in FAT	• The inserted USB-Memory capacity is larger than 2 GB.	• Insert a USB-Memory smaller than 2 GB or select the FAT32 format.	p. 143

■ Main dial brake adjustment

The tension of the main dial may be adjusted to suit your preference.

The brake adjustment is located on the bottom side of the front panel. See the figure at right.

Slide the brake adjustment to a comfortable tension level while turning the dial continuously and evenly in one direction.

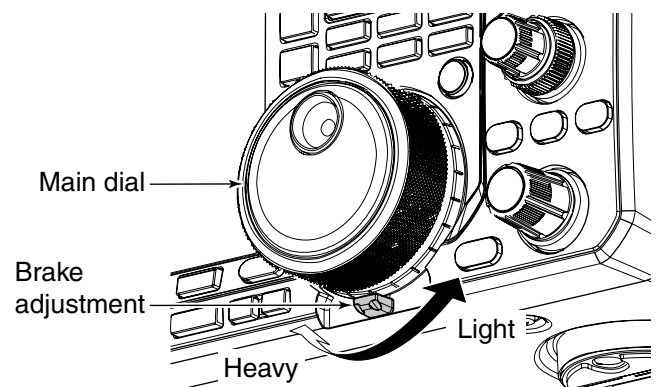

■ SWR reading

The SWR meter indicates the SWR over the transmission line in all modes.

- ① Push **[TUNER]** to turn the antenna tuner OFF.
- ② Push and hold **[METER] (MF2)** for 1 sec. to display multi-function meter.
- ③ Push **[RTTY/PSK]** once or twice to select RTTY mode.
- ④ Push **[TRANSMIT]**.
- ⑤ Rotate **[RF POWER]** clockwise past the 12 o'clock position for more than 30 W output power.
- ⑥ Read the SWR on the SWR meter gage.
- ⑦ Push **[EXIT/SET]** to close multi-function meter.

The built-in antenna tuner matches the transmitter to the antenna when the SWR is lower than 3 : 1.

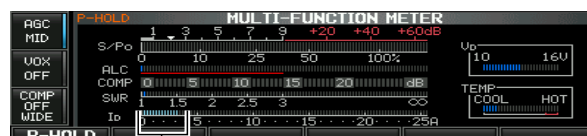
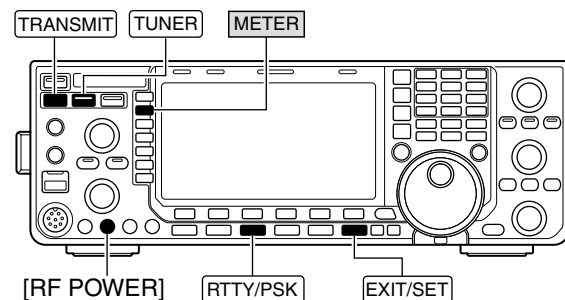

Better than 1.5:1

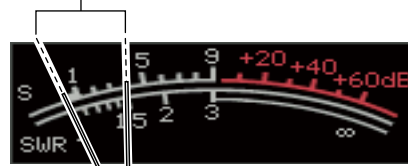

■ Screen type and font selections

2 types of screen images and 3 types of frequency readout indication fonts are available in the IC-7600.

- ① Push **[EXIT/SET]** several times to close multi-function screen, if necessary.
- ② Push **[SET] (F-6)** to select set mode menu screen.
- ③ Push **[DISP] (F-3)** to enter display set mode.
- ④ Push **[▲] (F-1)** or **[▼] (F-2)** to select “Display Type” item when selecting the screen image, select “Display Font” when selecting the frequency readout indication font.
- ⑤ Rotate the main dial to select the desired screen image or font.
 - Screen image is selectable from A (Black back) and B (Blue back).
 - Basic, Italic and Round are available for the frequency readout font.
- ⑥ Push **[EXIT/SET]** twice to exit from display set mode.

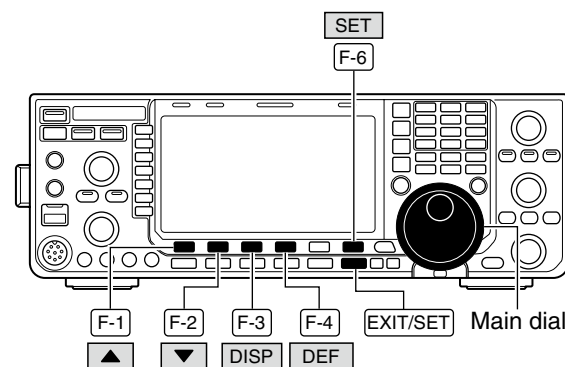

- Screen image example—
Display Type: B, Display Font: Italic

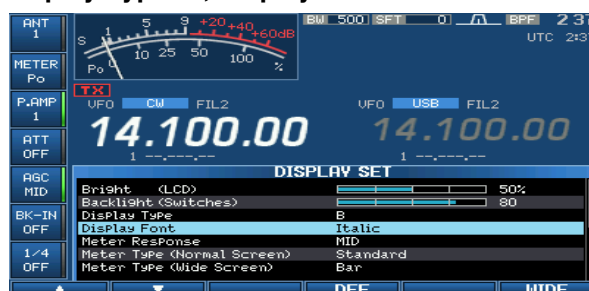

■ Frequency calibration (approximate)

A very accurate frequency counter is required to calibrate the frequency of the transceiver. However, a rough check may be performed by receiving radio station WWV, WWVH, or other standard frequency signals.

CAUTION: The IC-7600 has been thoroughly adjusted and tested at the factory before being shipped. You should not have to re-calibrate it.

- ① Push **[SSB]** to select USB mode.
- ② Push and hold **[PBT-CLR]** for 1 sec. to clear the PBT setting and make sure that the RIT/ Δ TX function is not activated.
- ③ Set the frequency to the standard frequency station minus 1 kHz.
 - When receiving WWV or WWVH (at 15.00000 MHz) as a standard frequency, set the operating frequency for 14.99900 MHz.
 - Other standard frequencies can be used.
- ④ Push **[EXIT/SET]** several times to close a multi-function screen, if necessary.
- ⑤ Push **[SET] (F-6)** to select set mode menu screen.
- ⑥ Push **[OTHERS] (F-5)** to enter others set mode.
- ⑦ Push **[▲] (F-1)** several times to select the “Calibration Marker” item.
- ⑧ Rotate the main dial clockwise to turn the calibration marker ON.
- ⑨ Push **[EXIT/SET]** once to return to set mode menu screen.
- ⑩ Push **[ACC] (F-2)** to enter accessory set mode.
- ⑪ Push **[▼] (F-2)** several times to select the “REF Adjust” item.
- ⑫ Rotate the main dial to adjust for a zero beat with the received standard signal as shown at right.
 - Zero beat means that two signals are exactly the same frequency, resulting in a single tone being emitted.
- ⑬ Turn the calibration marker OFF in others set mode.
- ⑭ Push **[EXIT/SET]** twice to exit set mode.

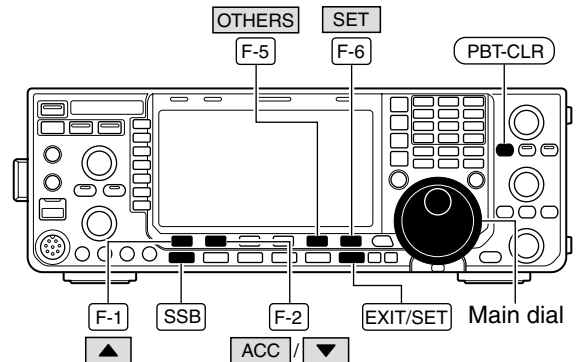

• Calibration marker item

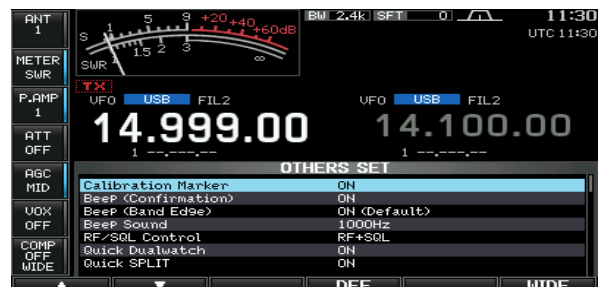

• REF Adjust item

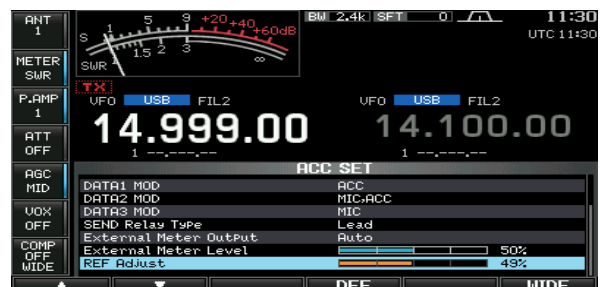

■ Opening the transceiver's case

Follow the case opening procedures shown here when you want to replace the clock backup battery or internal fuse.

CAUTION: Turn the power OFF and disconnect the DC power cable from the transceiver before performing any work on the transceiver. Otherwise, there is danger of electric shock and/or equipment damage.

- ① Remove the two screws from the carrying handle and remove the handle from the transceiver.
- ② Remove the 6 screws from the top of the transceiver and the 4 screws from the sides, then lift up the top cover.
- ③ Turn the transceiver upside-down.

CAUTION: NEVER HOLD THE MAIN DIAL OR ANY OTHER KNOBS when the transceiver is being turned upside down. This may damage the transceiver.

- ④ Remove 6 screws from the bottom, then lift up the bottom cover.

✓ About the leg pads

To detach the leg pads from the right side panel of the top/bottom cover, push them from the inner side of each cover after steps ① to ④ as above.

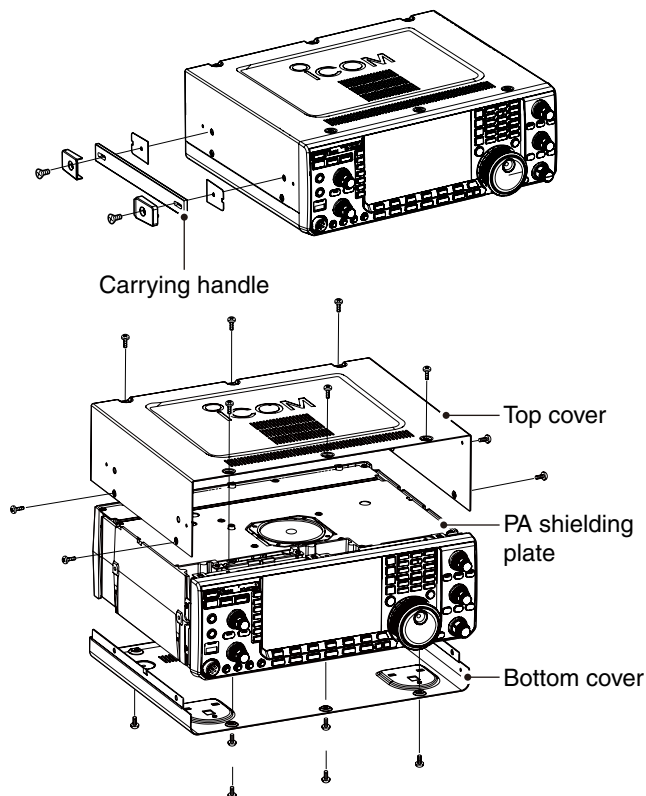

■ Clock backup battery replacement

The IC-7600 has a lithium backup battery (CR2032) inside for clock and timer functions. The usual life of the backup battery is approximately 2 years.

When the backup battery is discharged, the transceiver transmits and receives normally but cannot retain the current time.

CAUTION: Turn the power OFF and disconnect the DC power cable from the transceiver before removing the transceiver's cover.

- ① Remove the bottom cover as shown above.
- ② Replace the clock backup battery, located on the front panel as illustrated at right.
 - Make sure the battery polarity is correct.
- ③ Return the bottom cover to the original position.
- ④ Set the date and time in time set mode. (p. 116)

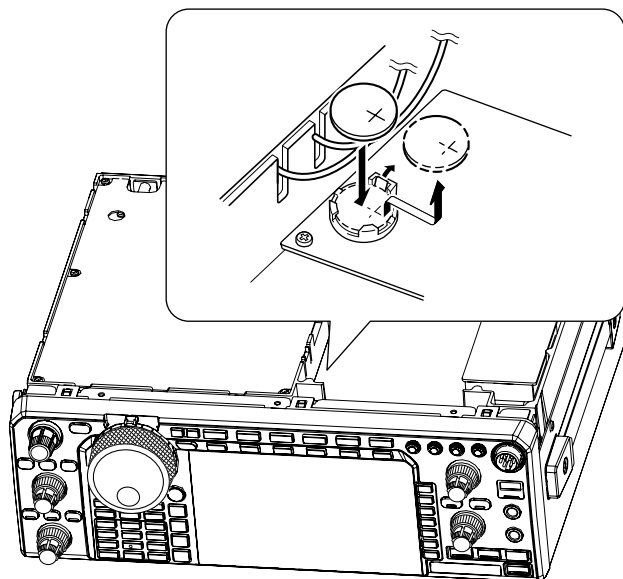

■ Fuse replacement

If a fuse blows or the transceiver stops functioning, try to find the source of the problem, and replace the damaged fuse with a new, adequately rated fuse.

CAUTION: Turn the power OFF and disconnect the DC power cable from the transceiver before removing the transceiver's cover.

◇ DC power cable fuse replacement

Refer the figure illustrated at right for the DC power cable fuse replacement.

The IC-7600 has two fuse types as below installed for transceiver protection.

- DC power cable fuses ATC 30 A
- Circuitry fuse ATC 5 A

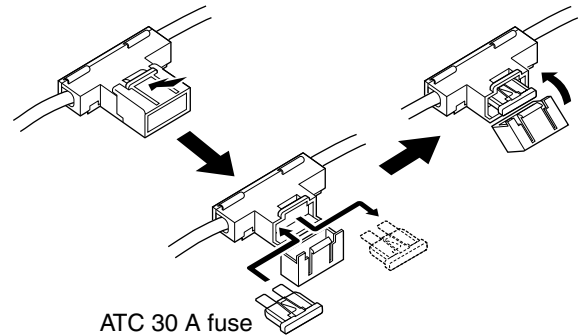

◇ Circuitry fuse replacement

The 13.8 V DC from the DC power cable is applied to all units in the IC-7600, except for the power amplifier, through the circuitry fuse. This fuse is installed in the PA unit.

- ① Remove the top cover. (p. 148)
- ② Remove the 11 screws, then remove the bottom cover and the PA shielding plate as shown at right.
- ③ Replace the circuitry fuse as shown in the diagram as at right.
- ④ Replace the PA shielding plate, top cover and screws to their original position.

WARNING: DO NOT pull the speaker cable when removing or replacing the PA shielding plate. Otherwise, a fire, injury or damage the transceiver may occur.

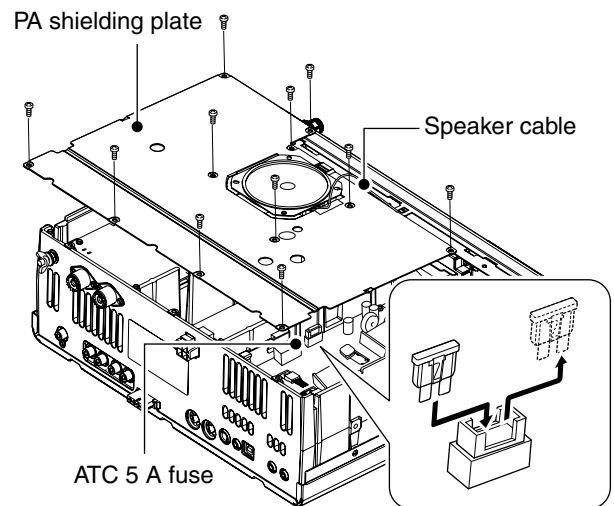

■ Resetting the CPU

- ① Turn the transceiver power OFF in advance.
- ② While pushing and holding [F-INP ENT] and [MW], push [POWER] to turn power ON.
 - The internal CPU is reset.
 - The CPU start-up takes approx. 5 sec.
 - The transceiver displays its initial VFO frequencies when resetting is complete.
- ③ Correct the set mode settings after resetting, if desired.

NOTE: Resetting **CLEARs** all programmed contents in memory channels and returns programmed values in set mode to default values.

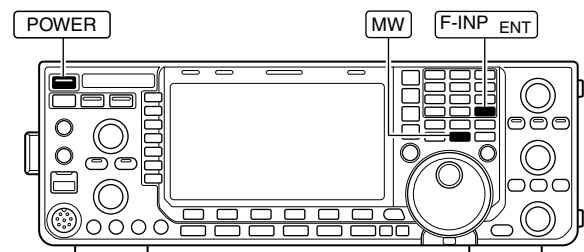

■ About protection indications

The IC-7600 has a 2-step protection function to protect the final power amplifiers.

The protector monitors the power amplifier temperature and activates when the temperature becomes extremely high.

- **Power down transmission**

Reduces the transmit output power to 50 W.
“LMT” appears beside the TX indicator (p. 14) during transmit.

- **Transmission inhibit**

Deactivates the transmitter.
The TX indicator (p. 14) is displayed in gray during transmit.

When the protector is activated, wait until the power amplifier cools down using the transceiver in stand-by or receive condition.

NOTE: DO NOT turn the transceiver power OFF when the protector is ON. If you do, the cooling fan will not function and it will take longer to cool the transceiver.

The power amplifier temperature can be monitored in the multi-function meter, TEMP gauge.

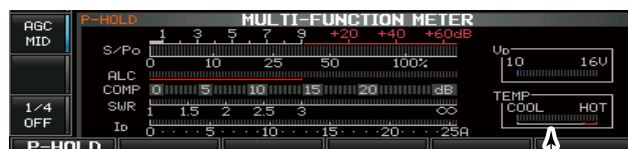

Check the temperature

■ Screen saver function

The IC-7600 has a screen saver function to protect the LCD from the “burn-in” effect.

- ① Push **[EXIT/SET]** several times to close a multi-function screen, if necessary.
- ② Push **[SET] (F-6)** to select set mode menu screen.
- ③ Push **[DISP] (F-3)** to enter display set mode.
- ④ Push **[▲] (F-1)** or **[▼] (F-2)** several times to select the “Screen Saver Function” item.
- ⑤ Rotate the main dial to select the desired time period for the screen saver activation from 15, 30, 60 min. and OFF.
 - Deactivate the screen saver with “OFF” selection.
- ⑥ Push **[▼] (F-2)** to select the “Screen Saver Type” item.
- ⑦ Rotate the main dial to select the screen saver type from “Bound,” “Rotation” and “Twist.”
 - Push and hold **[PREVIEW] (F-5)** to display the indication for your reference.
- ⑧ Push **[EXIT/SET]** twice to exit set mode.

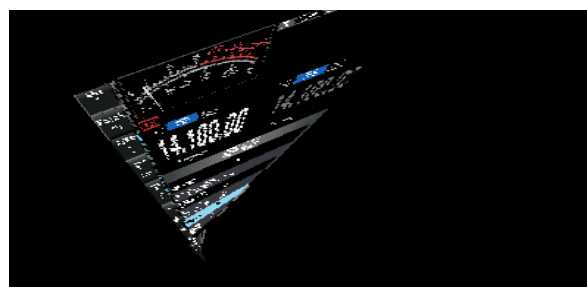
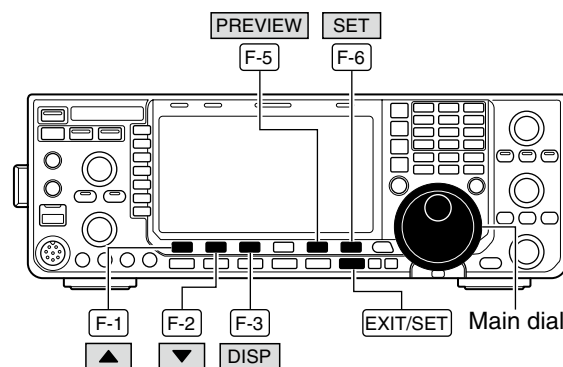

When “Twist” is selected

Remote jack (CI-V) information

CI-V connection example

The transceiver can be connected to an optional CT-17 CI-V LEVEL CONVERTER to a PC equipped with an RS-232C port. The Icom Communications Interface-V (CI-V) controls the transceiver.

Up to 4 Icom CI-V transceivers or receivers can be connected to a PC equipped with an RS-232C port. See p. 134 for setting the CI-V condition using set mode.

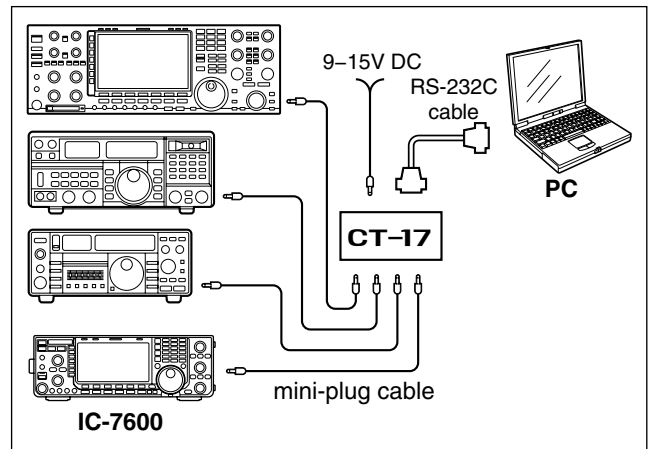

When the transceiver is connected to a PC with the USB cable (third party), the optional CT-17 is not required.

Data format

The CI-V system can be operated using the following data formats. Data formats differ according to command numbers. A data area or sub command is added for some commands.

Controller to IC-7600

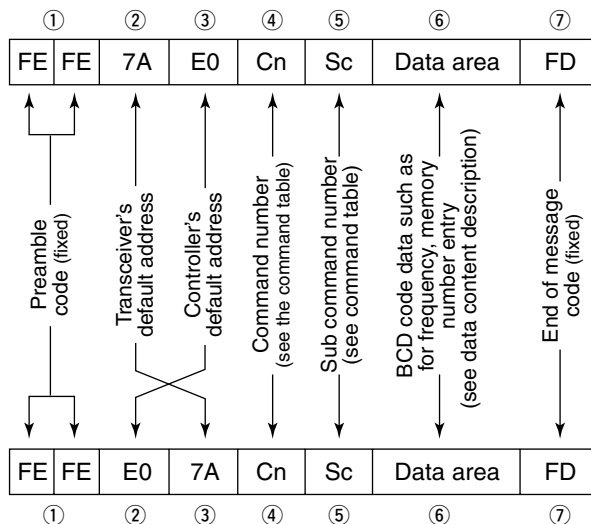

IC-7600 to controller

OK message to controller

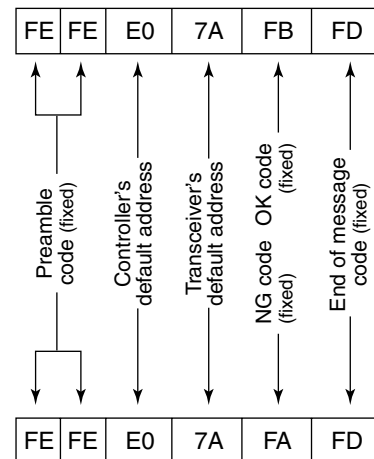

NG message to controller

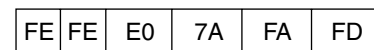

◆ Command table

Cmd.	Sub cmd.	Data	Description
00		see p. 157	Send frequency data (transceive)
01		see p. 157	Operating mode selection for transceive
02		see p. 159	Read band edge frequencies
03		see p. 157	Read operating frequency
04		see p. 157	Read operating mode
05		see p. 157	Set operating frequency
06		see p. 157	Operating mode selection for transceive
07			Select VFO mode
	B0		Exchange main and sub bands
	B1		Equalize main and sub bands
	C0		Turn the dualwatch OFF
	C1		Turn the dualwatch ON
	D0		Select main band
	D1		Select sub band
08			Select memory mode
		0001 to 0099	Select memory channel (0001=M-CH01, 0099=M-CH99)
		0100	Select program scan edge channel P1
		0101	Select program scan edge channel P2
09			Memory write
0A			Memory to VFO
0B			Memory clear
0E	00		Scan stop
	01		Programmed/memory scan start
	02		Programmed scan start
	03		∠IF scan start
	12		Fine programmed scan start
	13		Fine ∠IF scan start
	22		Memory scan start
	23		Select memory scan start
	A1		Select ∠IF scan span ±5 kHz
	A2		Select ∠IF scan span ±10 kHz
	A3		Select ∠IF scan span ±20 kHz
	A4		Select ∠IF scan span ±50 kHz
	A5		Select ∠IF scan span ±100 kHz
	A6		Select ∠IF scan span ±500 kHz
	A7		Select ∠IF scan span ±1 MHz
	B0		Set as non-select channel
	B1		Set as select channel (The previously set number by CI-V is set after turning power ON, or "1" is selected if no selection is performed.)
		01	Set as select channel "★1"
		02	Set as select channel "★2"
		03	Set as select channel "★3"
	B2	00	Set "ALL" for select memory scan
		01	Set "★1" for select memory scan
		02	Set "★2" for select memory scan
		03	Set "★3" for select memory scan
	D0		Set scan resume OFF
	D3		Set scan resume ON
0F	00		Turn the split function OFF
	01		Turn the split function ON

Cmd.	Sub cmd.	Data	Description
10		00	Select 10 Hz (1 Hz) tuning step
		01	Select 100 Hz tuning step
		02	Select 1 kHz tuning step
		03	Select 5 kHz tuning step
		04	Select 9 kHz tuning step
		05	Select 10 kHz tuning step
		06	Select 12.5 kHz tuning step
		07	Select 20 kHz tuning step
		08	Select 25 kHz tuning step
11		00	Send/read attenuator OFF
		06	Send/read 6 dB attenuator
		12	Send/read 12 dB attenuator
		18	Send/read 18 dB attenuator
12		0000	Send/read ANT1 selection (RX ANT OFF)
		0001	Send/read ANT1 selection (RX ANT ON)
		0100	Send/read ANT2 selection (RX ANT OFF)
		0101	Send/read ANT2 selection (RX ANT ON)
13	00		Announce all data with voice synthesizer
	01		Announce frequency and S-meter level with voice synthesizer
	02		Announce receive mode with voice synthesizer
14	01	0000 to 0255	Send/read [AF] level (0000=max. CCW, 0255=max. CW)
	02	0000 to 0255	Send/read [RF] level (0000=max. CCW, 0255=11 o'clock)
	03	0000 to 0255	Send/read [SQL] level (0000=11 o'clock, 0255=max. CW)
	06	0000 to 0255	Send/read [NR] level (0000=0%, 0255=100%)
	07	0000 to 0255	Send/read inner [TWIN PBT] position (0000=max. CCW, 0128=center, 0255=max. CW)
	08	0000 to 0255	Send/read outer [TWIN PBT] position (0000=max. CCW, 0128=center, 0255=max. CW)
	09	0000 to 0255	Send/read CW pitch (0000=300 Hz, 0128=600 Hz, 0255=900 Hz; 5 Hz steps)
	0A	0000 to 0255	Send/read [RF POWER] level (0000=max. CCW, 0255=max. CW)
	0B	0000 to 0255	Send/read [MIC GAIN] level (0000=max. CCW, 0255=max. CW)
	0C	0000 to 0255	Send/read [KEY SPEED] level (0000=max. CCW, 0255=max. CW)
	0D	0000 to 0255	Send/read [NOTCH] position (0000=max. CCW, 0128=center, 0255=max. CW)
	0E	0000 to 0255	Send/read COMP level (0000=0, 0255=10)
	0F	0000 to 0255	Send/read [BK-IN DELAY] position (0000=max. CCW, 0255=max. CW)
	10	0000 to 0255	Send/read [BAL] position (0000=max. CCW, 0128=center, 0255=max. CW)
	12	0000 to 0255	Send/read NB level (0000=0%, 0255=100%)
	14	0000 to 0255	Send/read DRIVE gain (0000=0%, 0255=100%)
	15	0000 to 0255	Send/read Monitor gain (0000=0%, 0255=100%)
	16	0000 to 0255	Send/read VOX gain (0000=0%, 0255=100%)
	17	0000 to 0255	Send/read Anti VOX gain (0000=0%, 0255=100%)
	19	0000 to 0255	Send/read BRIGHT level (0000=0%, 0255=100%)
15	01	00	Read squelch condition (squelch close)
		01	Read squelch condition (squelch open)
	02	0000 to 0255	Read S-meter level (0000=S0, 0120=S9, 0241=S9+60 dB)
	11	0000 to 0255	Read RF power meter (0000=0%, 0143=50%, 0213=100%)
	12	0000 to 0255	Read SWR meter (0000=SWR1.0, 0048=SWR1.5, 0080=SWR2.0)
	13	0000 to 0255	Read ALC meter (0000=0, 0120=Max.)
	14	0000 to 0255	Read COMP meter (0000=0 dB, 0130=15 dB, 0241=30 dB)

◇ Command table (continued)

Cmd.	Sub cmd.	Data	Description	Cmd.	Sub cmd.	Data	Description
15	15	0000 to 0255	Read VD meter (0152=10 V, 0181=13 V, 0212=16 V)	1A	05	0015	00 to 10 Send/read AM TX Tone (Bass) level (00=-5, 10=+5)
	16	0000 to 0255	Read ID meter (0000=0 A, 0097=10 A, 0241=25 A)			0016	00 to 10 Send/read AM TX Tone (Treble) level (00=-5, 10=+5)
16	02	00	Preamp OFF		0017	00 to 10 Send/read FM TX Tone (Bass) level (00=-5, 10=+5)	
		01	Preamp 1 ON		0018	00 to 10 Send/read FM TX Tone (Treble) level (00=-5, 10=+5)	
		02	Preamp 2 ON		0019	see p. 122 Send/read SSB TX bandwidth for WIDE	
	12	00	AGC FAST selection		0020	see p. 122 Send/read SSB TX bandwidth for MID.	
		01	AGC MID selection		0021	see p. 122 Send/read SSB TX bandwidth for NARROW	
		02	AGC SLOW selection		0022	0000 to 0255 Send/read DRIVE gain (0000=0%, 0255=100%)	
	22	00	Noise blanker OFF		0023	0000 to 0255 Send/read speech level (0000=0%, 0255=100%)	
		01	Noise blanker ON		0024	0000 to 0255 Send/read CW sidetone level (0000=0%, 0255=100%)	
	32	00	Audio peak filter OFF		0025	00 CW sidetone level limit OFF	
		01	Audio peak filter WIDE ON (320 Hz is selected when SHARP APF is set)		01	CW sidetone level limit ON	
		02	Audio peak filter MID ON (160 Hz is selected when SHARP APF is set)		0026	0000 to 0255 Send/read beep level (0000=0%, 0255=100%)	
	40	00	Noise reduction OFF		0027	00 Beep level limit OFF	
		01	Noise reduction ON		01	Beep level limit ON	
	41	00	Auto notch function OFF		0028	00 Squelch mute effect OFF (squelch is fixed open) for audio output from USB-B connector	
		01	Auto notch function ON			01 Squelch mute effect ON for audio output from USB-B connector	
	42	00	Repeater tone OFF		0029	0000 to 0255 Send/read modulation level for audio input to USB-B connector (0000=0%, 0255=100%)	
		01	Repeater tone ON			0030	00 [MIC] selection for MOD input connector during DATA OFF
	43	00	Tone squelch OFF			01	[ACC] selection for MOD input connector during DATA OFF
		01	Tone squelch ON		02	Both [MIC] and [ACC] selection for MOD input connector during DATA OFF	
		01	Tone squelch ON		03	[USB] selection for MOD input connector during DATA OFF	
44	00	Speech compressor OFF	0031		00 [MIC] selection for MOD input connector during DATA1		
	01	Speech compressor ON			01 [ACC] selection for MOD input connector during DATA1		
45	00	Monitor function OFF			02	Both [MIC] and [ACC] selection for MOD input connector during DATA1	
	01	Monitor function ON	03		[USB] selection for MOD input connector during DATA1		
46	00	VOX function OFF	0032		00 [MIC] selection for MOD input connector during DATA2		
	01	VOX function ON			01 [ACC] selection for MOD input connector during DATA2		
	00	BK-IN function OFF		02	Both [MIC] and [ACC] selection for MOD input connector during DATA2		
47	01	Semi BK-IN function ON	03	[USB] selection for MOD input connector during DATA2			
	02	Full BK-IN function ON	0033	00 [MIC] selection for MOD input connector during DATA3			
	48	00		Manual notch function OFF	01 [ACC] selection for MOD input connector during DATA3		
01		Manual notch function ON		02	Both [MIC] and [ACC] selection for MOD input connector during DATA3		
4F	00	Twin peak filter OFF	03	[USB] selection for MOD input connector during DATA3			
	01	Twin peak filter ON	0034	00 Lead selection for SEND relay type			
50	00	Dial lock function OFF		01	MOS-FET selection for SEND relay type		
	01	Dial lock function ON	0035	00 Auto selection for external meter output			
19	00	Read the transceiver ID		01	S (receiving signal strength) selection for external meter output		
	1A	00		see p. 159 Send/read memory contents	02	Po (RF power) selection for external meter selection	
		01		see p. 157 Send/read band stacking register contents	03	SWR selection for external meter output	
		02		see p. 157 Send/read memory keyer contents	04	ALC selection for external meter output	
		03		00 to 49 Send/read the selected filter width (SSB, CW, PSK: 00=50 Hz, 40=3600 Hz; RTTY: 00=50 Hz, 31=2700 Hz; AM: 00=200 Hz, 49=10 kHz)	05	COMP selection for external meter output	
	04	00 to 13 Send/read the selected AGC time constant (00=OFF, 01=0.1/0.3 sec., 13=6.0/8.0 sec.)		0036	06	Vd selection for external meter output	
	05	0001	see p. 120 Send/read SSB RX HPF/LPF		07	Id selection for external meter output	
		0002	00 to 10 Send/read SSB RX Tone (Bass) level (00=-5, 10=+5)		0000 to 0255	Send/read external meter output level (see p. 125)	
		0003	00 to 10 Send/read SSB RX Tone (Treble) level (00=-5, 10=+5)				
		0004	see p. 120 Send/read AM RX HPF/LPF				
		0005	00 to 10 Send/read AM RX tone (Bass) level (00=-5, 10=+5)				
		0006	00 to 10 Send/read AM RX Tone (Treble) level (00=-5, 10=+5)				
		0007	see p. 120 Send/read FM RX HPF/LPF				
		0008	00 to 10 Send/read FM RX tone (Bass) level (00=-5, 10=+5)				
		0009	00 to 10 Send/read FM RX Tone (Treble) level (00=-5, 10=+5)				
		0010	see p. 121 Send/read CW RX HPF/LPF				
		0011	see p. 121 Send/read RTTY RX HPF/LPF				
		0012	see p. 121 Send/read PSK RX HPF/LPF				
		0013	00 to 10 Send/read SSB TX Tone (Bass) level (00=-5, 10=+5)				
0014		00 to 10 Send/read SSB TX Tone (Treble) level (00=-5, 10=+5)					

Cmd.	Sub cmd.	Data	Description	
1A	05	0037	0000 to 0255 Send/read reference frequency (0000=0%, 0255=100%)	
		0038	0000 to 0255 Send/read LCD backlight brightness level (0000=0% (dark), 0255=100% (bright))	
		0039	0000 to 0255 Send/read key backlight brightness level (0000=0% (dark), 0255=100% (bright))	
		0040	00	Display type A selection
			01	Display type B selection
		0041	00	Basic font selection
			01	Italic font selection
			02	Round font selection
		0042	00	SLOW selection for meter response
			01	MID selection for meter response
			02	FAST selection for meter response
		0043	00	Standard meter selection for normal screen indication
			01	Edgewise meter selection for normal screen indication
			02	Bar meter selection for normal screen indication
		0044	00	Edgewise meter selection for wide screen indication
			01	Bar meter selection for wide screen indication
		0045	00	Meter peak hold function for Bar meter OFF
			01	Meter peak hold function for Bar meter ON
		0046	00	Memory name indication OFF
			01	Memory name indication ON
		0047	00	Audio peak filter width pop-up indication OFF
			01	Audio peak filter width pop-up indication ON
		0048	00	Manual notch filter width pop-up indication OFF
			01	Manual notch filter width pop-up indication ON
		0049	00	Screen saver OFF
			01	15 min. selection for screen saver
			02	30 min. selection for screen saver
			03	60 min. selection for screen saver
		0050	00	Bound selection for screen saver type
			01	Round selection for screen saver type
			02	Twist selection for screen saver type
		0051	00	Opening screen indication OFF
			01	Opening screen indication ON
		0052	see p. 158	Send/read opening screen contents.
		0053	20000101 to 20991231	Send/read date (20000101=1st Jan. 2000, 20991231=31st Dec. 2099)
		0054	0000 to 2359	Send/read time (0000=00:00, 2359=23:59)
			00	Clock 2 OFF
		0055	00	Clock 2 OFF
			01	Clock 2 ON
		0056	see p. 157	Send/read offset time for clock 2
		0057	see p. 158	Send/read clock 2 name *Up to 3 characters
		0058	00	Calibration marker OFF
			01	Calibration marker ON
		0059	00	Confirmation beep OFF
			01	Confirmation beep ON
		0060	00	Band edge beep OFF
			01	Band edge beep ON (Beep sounds with a default amateur band)
			02	Band edge beep with user setting ON
			03	Band edge beep with user setting/TX limit ON
		0061	0050 to 0200	Send/read beep audio frequency (0050=500 Hz, 0200=2000 Hz)
00	Auto selection for [RF/SQ]			
0062	01	SQL selection for [RF/SQ]		
	02	RF+SQL selection for [RF/SQ]		
	00	Quick dualwatch OFF		
0063	01	Quick dualwatch ON		
	00	Quick split function OFF		
0064	00	Quick split function OFF		
	01	Quick split function ON		
0065	see p. 158	FM split offset frequency setting for HF		
0066	see p. 158	FM split offset frequency setting for 50 MHz		
0067	00	Split lock function OFF		
	01	Split lock function ON		
0068	00	Tuner auto start OFF		
	01	Tuner auto start ON		

Cmd.	Sub cmd.	Data	Description	
1A	05	0069	00 PTT tune OFF	
		01	PTT tune ON	
		0070	00	Antenna selection OFF
			01	Manual antenna selection
		0071	02	Auto antenna selection
			00	Transverter functions automatically
		0072	01	Transverter function ON
			see p. 158	Transverter offset frequency
		0073	00	1275 Hz selection for RTTY mark frequency
			01	1615 Hz selection for RTTY mark frequency
			02	2125 Hz selection for RTTY mark frequency
		0074	00	170 Hz selection for RTTY shift width
			01	200 Hz selection for RTTY shift width
			02	425 Hz selection for RTTY shift width
		0075	00	RTTY keying with normal polarity
			01	RTTY keying with reverse polarity
		0076	00	1000 Hz selection for PSK tone frequency
			01	1500 Hz selection for PSK tone frequency
			02	2000 Hz selection for PSK tone frequency
		0077	00	English selection for voice synthesizer speech language
			01	Japanese selection for voice synthesizer speech language
		0078	00	Speech speed slow
			01	Speech speed fast
		0079	00	S-meter level announcement OFF
			01	S-meter announcement ON
		0080	00	Operating mode announcement (after pushing mode switch) OFF
			01	Operating mode announcement (after pushing mode switch) ON
		0081	00	[SPEECH/LOCK] key function setting (Push momentarily=SPEECH, Push and hold=LOCK)
			01	[SPEECH/LOCK] key function setting (Push momentarily=LOCK, Push and hold=SPEECH)
		0082	00	Number of memo pad channels 5
			01	Number of memo pad channels 10
		0083	00	Auto TS for main dial OFF
			01	Auto TS for main dial ON with LOW
		0084	02	Auto TS for main dial ON with HIGH
			00	LOW selection for microphone Up/Down speed
		0085	01	HIGH selection for microphone Up/Down speed
			00	Quick RIT/ΔTX clear OFF
		0086	01	Quick RIT/ΔTX clear ON
			00	Auto notch selection for SSB operation
		0087	01	Manual notch selection for SSB operation
			02	Auto/Manual notch selection for SSB operation
			00	Auto notch selection for AM operation
0088	01	Manual notch selection for AM operation		
	02	Auto/Manual notch selection for AM operation		
	00	SSB/CW synchronous tuning function OFF		
0089	01	SSB/CW synchronous tuning function ON		
	00	LSB selection for CW normal side set		
0090	01	USB selection for CW normal side set		
	00	SHARP selection for APF type		
0091	01	SOFT selection for APF type		
	00	Voice memory transmission OFF with external keypad		
0092	01	Voice memory transmission ON with external keypad		
	00	Memory keyer transmission OFF with external keypad		
0093	01	Memory keyer transmission ON with external keypad		
	00	RTTY memory transmission OFF with external keypad		
0094	01	RTTY memory transmission ON with external keypad		
	00	PSK memory transmission OFF with external keypad		
0094	01	PSK memory transmission ON with external keypad		

◇ Command table (continued)

Cmd.	Sub cmd.	Data	Description	
1A	05	0095	00	Voice memory transmission OFF with [F1]–[F4] on the keyboard
			01	Voice memory transmission ON with [F1]–[F4] on the keyboard
		0096	00	Memory keyer transmission OFF with [F1]–[F4] on the keyboard
			01	Memory keyer transmission ON with [F1]–[F4] on the keyboard
		0097	00	CI-V transceiver OFF
			01	CI-V transceiver ON
		0098	00	CI-V selection for [USB-B] usage
			01	Decode selection for [USB-B] usage
		0099	00	300 bps selection for decode speed
			01	1200 bps selection for decode speed
			02	4800 bps selection for decode speed
			03	9600 bps selection for decode speed
			04	19200 bps selection for decode speed
		0100	00	English keyboard selection
			01	Japanese keyboard selection
			02	United Kingdom keyboard selection
			03	French keyboard selection
			04	French (Canadian) keyboard selection
			05	German keyboard selection
			06	Portuguese keyboard selection
			07	Portuguese (Brazilian) keyboard selection
			08	Spanish keyboard selection
			09	Spanish (Latin American) keyboard selection
		10	Italian keyboard selection	
		0101	0010 to 0100	Send/read keyboard repeat delay (0010=100 msec., 0100=1000 msec.; 50 msec. steps)
		0102	00 to 31	Send/read keyboard repeat speed (00=2.0 cps, 31=30.0 cps)
		0103	00	Scope indication during TX OFF
			01	Scope indication during TX ON
		0104	00	Scope max. hold function OFF
			01	Scope max. hold function ON
		0105	00	Filter center selection for scope center frequency (center mode only)
			01	Carrier point center selection for scope center frequency (center mode only)
			02	Carrier point center (Abs. Freq.) selection for scope center frequency (center mode only)
		0106	see p. 158	Send/read waveform color for receiving signal
		0107	see p. 158	Send/read waveform color for max. hold
		0108	00	SLOW selection for scope sweep speed in ±2.5 kHz span
			01	MID selection for scope sweep speed in ±2.5 kHz span
			02	FAST selection for scope sweep speed in ±2.5 kHz span
		0109	00	SLOW selection for scope sweep speed in ±5 kHz span
			01	MID selection for scope sweep speed in ±5 kHz span
			02	FAST selection for scope sweep speed in ±5 kHz span
		0110	00	SLOW selection for scope sweep speed in ±10 kHz span
			01	MID selection for scope sweep speed in ±10 kHz span
			02	FAST selection for scope sweep speed in ±10 kHz span
		0111	00	SLOW selection for scope sweep speed in ±25 kHz span
			01	MID selection for scope sweep speed in ±25 kHz span
			02	FAST selection for scope sweep speed in ±25 kHz span
		0112	00	SLOW selection for scope sweep speed in ±50 kHz span
			01	MID selection for scope sweep speed in ±50 kHz span
			02	FAST selection for scope sweep speed in ±50 kHz span

Cmd.	Sub cmd.	Data	Description	
1A	05	0113	00	SLOW selection for scope sweep speed in ±100 kHz span
			01	MID selection for scope sweep speed in ±100 kHz span
		0114	02	FAST selection for scope sweep speed in ±100 kHz span
			00	SLOW selection for scope sweep speed in ±250 kHz span
		0115	01	MID selection for scope sweep speed in ±250 kHz span
			02	FAST selection for scope sweep speed in ±250 kHz span
		0115	see p. 158	Scope edge frequencies for 0.03 to 1.60 MHz band
		0116	see p. 158	Scope edge frequencies for 1.60 MHz to 2.00 MHz band
		0117	see p. 158	Scope edge frequencies for 2.00 MHz to 6.00 MHz band
		0118	see p. 158	Scope edge frequencies for 6.00 MHz to 8.00 MHz band
		0119	see p. 158	Scope edge frequencies for 8.00 MHz to 11.00 MHz band
		0120	see p. 158	Scope edge frequencies for 11.00 MHz to 15.00 MHz band
		0121	see p. 158	Scope edge frequencies for 15.00 MHz to 20.00 MHz band
		0122	see p. 158	Scope edge frequencies for 20.00 MHz to 22.00 MHz band
		0123	see p. 158	Scope edge frequencies for 22.00 MHz to 26.00 MHz band
		0124	see p. 158	Scope edge frequencies for 26.00 MHz to 30.00 MHz band
		0125	see p. 158	Scope edge frequencies for 30.00 MHz to 45.00 MHz band
		0126	see p. 158	Scope edge frequencies for 45.00 MHz to 60.00 MHz band
		0127	00	Auto monitor function OFF during voice memory transmission
			01	Auto monitor function ON during voice memory transmission
		0128	03 to 10	Send/read voice memory short play time (03=3 sec., 10=10 sec.)
		0129	05 to 15	Send/read voice memory normal record time (05=5 sec., 15=15 sec.)
		0130	00	Normal selection for contest number style
			01	"190 → ANO" selection for contest number style
			02	"190 → ANT" selection for contest number style
			03	"90 → NO" selection for contest number style
		0131	04	"90 → NT" selection for contest number style
			01	M1 selection for count up trigger channel
			02	M2 selection for count up trigger channel
			03	M3 selection for count up trigger channel
		0132	04	M4 selection for count up trigger channel
			0001 to 9999	Send/read present number (0001=1, 9999=9999)
			01 to 60	Send/read CW keyer repeat time (01=1 sec., 60=60 sec.)
			0134	28 to 45
		0135	00	2 msec. selection for rise time of the transmitted CW envelope
			01	4 msec. selection for rise time of the transmitted CW envelope
			02	6 msec. selection for rise time of the transmitted CW envelope
			03	8 msec. selection for rise time of the transmitted CW envelope
		0136	04	10 msec. selection for rise time of the transmitted CW envelope
			00	Normal selection for paddle polarity
			01	Reverse selection for paddle polarity
			0137	00
		01		BUG-KEY selection for keyer type
		02		ELEC-KEY selection for keyer type
		0138	00	Mic. up/down keyer function OFF
			01	Mic. up/down keyer function ON

Cmd.	Sub cmd.	Data	Description
1A	05	0139	00 RTTY decoder FFT scope averaging function OFF
		01 Number 2 selection for RTTY decoder FFT scope averaging function	
		02 Number 3 selection for RTTY decoder FFT scope averaging function	
		03 Number 4 selection for RTTY decoder FFT scope averaging function	
	0140	see p. 158	Set/read FFT scope waveform color set for RTTY decoder
	0141	00 RTTY decode USOS function OFF	
		01 RTTY decode USOS function ON	
	0142	00 "CR,LF,CR+LF" selection for RTTY decode new line code	
		01 "CR+LF" selection for RTTY decode new line code	
	0143	00 OFF selection for RTTY diddle	
		01 BLANK selection for RTTY diddle	
		02 LTRS selection for RTTY diddle	
	0144	00 RTTY encode USOS function OFF	
		01 RTTY encode USOS function ON	
	0145	00 RTTY auto CR+LF by keyboard's [F12] OFF	
		01 RTTY auto CR+LF by keyboard's [F12] ON	
	0146	00 RTTY time stamp OFF	
		01 RTTY time stamp ON	
	0147	00 Local time selection for RTTY time stamp	
		01 Clock2 selection for RTTY time stamp	
	0148	00 Frequency stamp for RTTY time stamp OFF	
		01 Frequency stamp for RTTY time stamp ON	
	0149	see p. 158	Send/read received text font color for RTTY decoder
	0150	see p. 158	Send/read transmitted text font color (RTTY)
	0151	see p. 158	Send/read time stamp text font color (RTTY)
	0152	see p. 158	Send/read text font color in TX buffer (RTTY)
	0153	00 PSK decoder FFT scope averaging function OFF	
		01 Number 2 selection for PSK decoder FFT scope averaging function	
		02 Number 3 selection for PSK decoder FFT scope averaging function	
		03 Number 4 selection for PSK decoder FFT scope averaging function	
	0154	see p. 158	Set/read FFT scope waveform color set for PSK decoder
	0155	00 ±8 Hz selection for PSK AFC function tuning range	
		01 ±15 Hz selection for PSK AFC function tuning range	
	0156	00 PSK time stamp OFF	
		01 PSK time stamp ON	
	0157	00 Local time selection for PSK time stamp	
		01 Clock2 selection for PSK time stamp	
	0158	00 Frequency stamp for PSK time stamp OFF	
		01 Frequency stamp for PSK time stamp ON	
	0159	see p. 158	Send/read received text font color for PSK decoder
	0160	see p. 158	Send/read transmitted text font color (PSK)
	0161	see p. 158	Send/read time stamp text font color (PSK)
	0162	see p. 158	Send/read text font color in TX buffer (PSK)
	0163	00 LOW scan speed selection	
		01 HIGH scan speed selection	
	0164	00 Scan resume OFF	
		01 Scan resume ON	
0165	0000 to 0255	Send/read VOX gain (0000=0%, 0255=100%)	
0166	0000 to 0255	Send/read ANTI-VOX gain (0000=0%, 0255=100%)	
0167	00 to 20	Send/read VOX delay time (00=0.0 sec., 20=2.0 sec.)	
0168	00 VOX voice delay function OFF		
	01 Short selection for VOX voice delay		
	02 Mid selection for VOX voice delay		
	03 Long selection for VOX voice delay		

Cmd.	Sub cmd.	Data	Description
1A	05	0169	0000 to 0255 Send/read NB level (0000=0%, 0255=100%)
		0170	00 to 09 Send/read NB depth (00=1, 09=10)
		0171	0000 to 0255 Send/read NB width (0000=1, 0255=100)
		0172	0000 to 0255 Send/read MONITOR gain (0000=0%, 0255=100%)
	06	see p. 158	Send/read DATA mode with filter set
	07	00 WIDE selection for SSB transmit bandwidth	
		01 MID selection for SSB transmit bandwidth	
		02 NAR selection for SSB transmit bandwidth	
		08	00 SHARP selection for DSP filter type
		01 SOFT selection for DSP filter type	
		09	00 3 kHz roofing filter selection
	01	01 6 kHz roofing filter selection	
		02 15 kHz roofing filter selection	
		0A	00 WIDE selection for manual notch width
	01	01 MID selection for manual notch width	
		02 NAR selection for manual notch width	
1B	00	see p. 159	Send/read repeater tone frequency
	01	see p. 159	Send/read tone squelch frequency
1C	00	00	Transceiver's condition (RX)
		01	Transceiver's condition (TX)
	01	00	Antenna tuner OFF (through)
		01	Antenna tuner ON
02	01	Tuning	
	02	Tuning	
1E	00		Read number of available TX frequency band
	01	see p. 159	Read TX band edge frequencies
	02		Read number of user-set TX frequency band
	03	see p. 159	Send/read user-set TX band edge frequencies

◇ Data content description

• Operating frequency

Command : 00, 03, 05

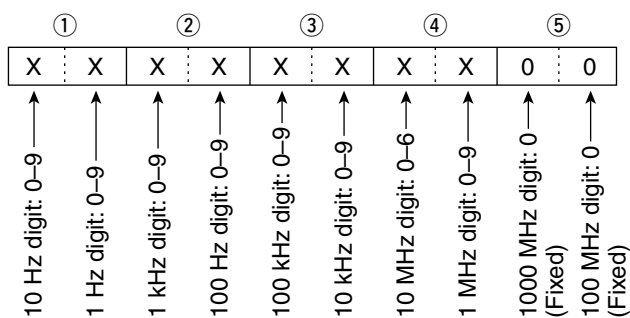

• Operating mode

Command : 01, 04, 06

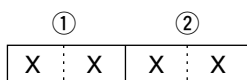

① Operating mode	② Filter setting
00: LSB	05: FM
01: USB	07: CW-R
02: AM	08: RTTY-R
03: CW	12: PSK
04: RTTY	13: PSK-R
	01: FIL1
	02: FIL2
	03: FIL3

Filter setting (②) can be skipped with command 01 and 06. In that case, "FIL1" is selected with command 01 and the default filter setting of the operating mode is selected with command 06, automatically.

• Memory keyer contents

Command : 1A 02

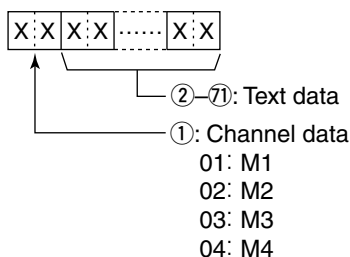

• Character's code

Character	ASCII code	Description
0-9	30-39	Numerals
A-Z	41-5A	Alphabetical characters
space	20	Word space
/	2F	Symbol
?	3F	Symbol
,	2C	Symbol
.	2E	Symbol
@	40	Symbol
^	5E	e.g., to send BT, enter ^BT
*	2A	Inserts contest number (can be used for 1 channel only)

• Band stacking register

Command : 1A 01

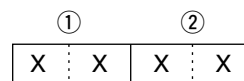

① Frequency band code

Code	Freq. band	Frequency range (unit: MHz)
01	1.8	1.800000- 1.999999
02	3.5	3.400000- 4.099999
03	7	6.900000- 7.499999
04	10	9.900000-10.499999
05	14	13.900000-14.499999
06	18	17.900000-18.499999
07	21	20.900000-21.499999
08	24	24.400000-25.099999
09	28	28.000000-29.999999
10	50	50.000000-54.000000
11	GENE	Other than above

② Register code

Code	Registered No.
01	1 (latest)
02	2
03	3 (oldest)

For example, when reading the oldest contents in the 21 MHz band, the code "0703" is used.

When sending the contents, the following code should be added after code ②.

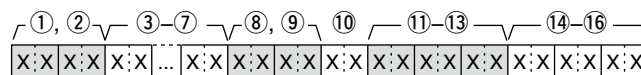

③-⑦ Operating frequency setting

See "• Operating frequency."

⑧, ⑨ Operating mode setting

See "• Operating mode."

⑩ Data mode setting

1 byte data (XX)

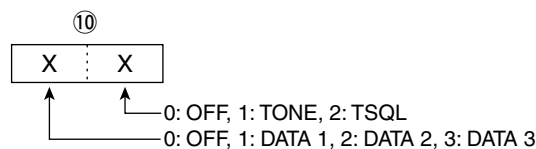

⑪-⑬ Repeater tone frequency setting

⑭-⑯ Tone squelch frequency setting

See "• Repeater tone/tone squelch setting."

• Clock 2 offset time setting

Command : 1A 05 0056

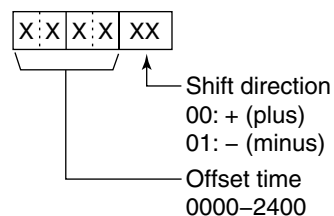

• **Offset frequency setting**

Command : 1A 05 0065, 0066, 0072

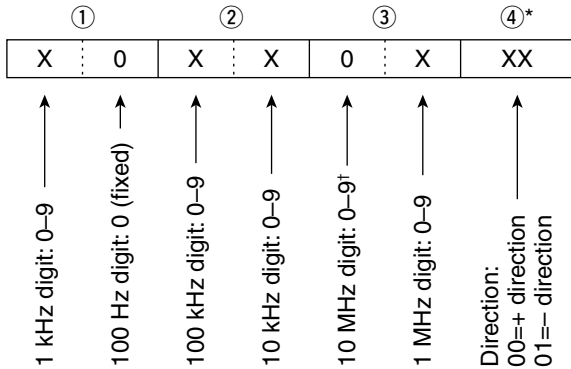

*No need to enter for transverter offset frequency setting.
†Transverter offset only; Fix to '0' for split offset setting.

• **Codes for memory name, opening message and CLOCK2 name contents**

To send or read the desired memory name settings, the character codes, instructed codes for memory keyer contents, and follows are used.

• **Character's code— Alphabetical characters**

Character	ASCII code	Character	ASCII code
a-z	61-7A	—	—

• **Character's code— Symbols**

Character	ASCII code	Character	ASCII code
!	21	#	23
\$	24	%	25
&	26	¥	5C
?	3F	"	22
'	27	`	60
+	2B	-	2D
:	3A	;	3B
=	3D	<	3C
>	3E	(28
)	29	[5B
]	5D	{	7B
}	7D		7C
_	5F	-	7E
@	40		

• **Color setting**

Command : 1A 05 0106, 0107, 0140, 0149, 0150, 0151, 0152, 0154, 0159, 0160, 0161, 0162

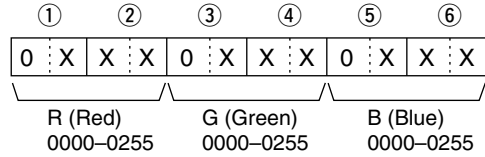

• **Bandscope edge frequency setting**

Command : 1A 05 0115, 0116, 0117, 0118, 0119, 0120, 0121, 0122, 0123, 0124, 0125, 0126

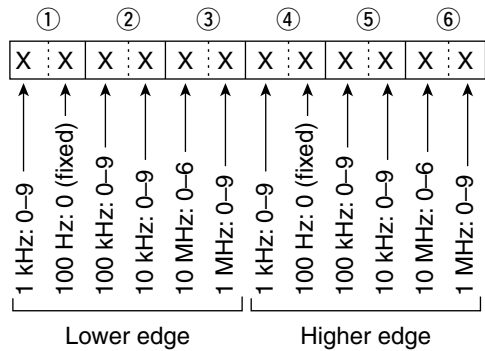

• **Data mode with filter width setting**

Command : 1A 06

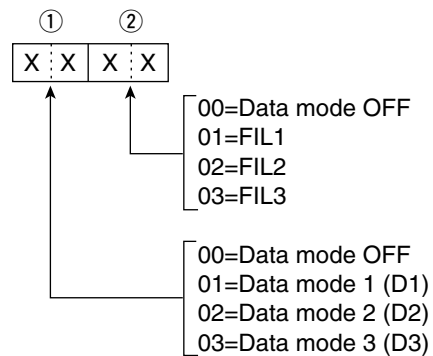

Command	Set item/Available characters
1A00	Memory name All characters are available.
1A05 0052	Opening message Capital letters, numerals, some symbols (- / . @) and space are available.
1A05 0057	CLOCK 2 name Capital letters, small letters, numerals, some symbols (! # \$ % & ¥ ? " ' ` ^ + - * / . , ; = < > () [] { } _ - @) and space are available.

◇ Data content description (continued)

• **Repeater tone/tone squelch frequency setting**

Command : 1B 00, 1B 01

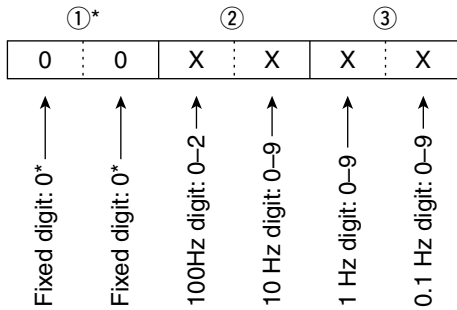

*Not necessary when setting a frequency.

• **Band edge frequency setting**

Command 02*, 1E 01, 1E 03

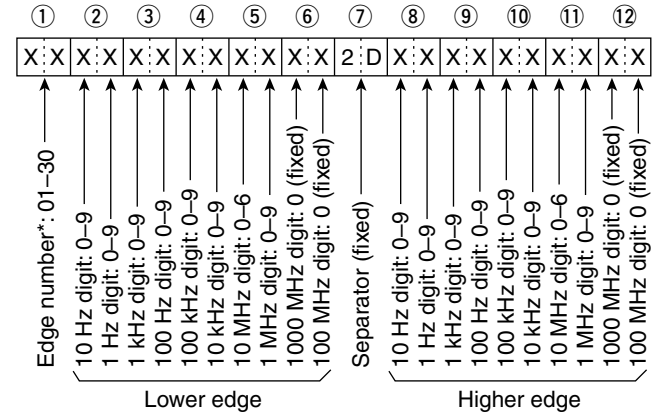

* Edge number setting is not necessary with command 02.

• **Memory content setting**

Command : 1A 00

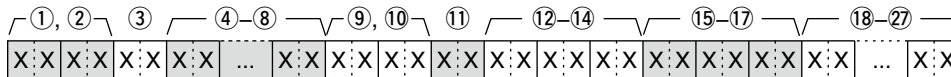

- ①, ② **Memory channel number**
0000–0099 : Memory channel 0 to 99
0100 : Programmed scan edge P1
0101 : Programmed scan edge P2

- ③ **Select memory setting**
00: OFF
01: ★1
02: ★2
03: ★3

- ④–⑧ **Operating frequency setting**
See “• Operating frequency.”

- ⑨, ⑩ **Operating mode setting**
See “• Operating mode.”

- ⑪ **Data mode setting**
1 byte data (XX)

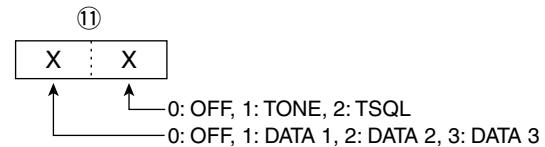

- ⑫–⑭ **Repeater tone frequency setting**
- ⑮–⑰ **Tone squelch frequency setting**
See “• Repeater tone/tone squelch setting.”

- ⑱–⑳ **Memory name setting**
Up to 10 characters.
See “• Codes for memory name, opening message and Clock 2 name contents.”

■ General

- Frequency coverage : (unit: MHz)
 - Receive : 0.030–60.000*1*2
 - Transmit :
 - 1.800–1.999*2, 3.500–3.999*2,
 - 5.33050*3, 5.34650*3, 5.36650*3,
 - 5.37150*3, 5.40350*3,
 - 7.000–7.300*2, 10.100–10.150*2,
 - 14.000–14.350*2, 18.068–18.168*2,
 - 21.000–21.450*2, 24.890–24.990*2,
 - 28.000–29.700*2, 50.000–54.000*2
- *1Some frequency bands are not guaranteed.
- *2Depending on version. *3USA version only.
- Mode : USB, LSB, CW, RTTY, PSK, AM, FM
- No. of memory channels : 101 (99 regular, 2 scan edges)
- Antenna connector type : SO-239 × 2 and phono jack (RCA; 50 Ω impedance)
- Temperature range : 0°C to +50°C (+32°F to +122°F)
- Frequency stability : Less than ±0.5 ppm 5 min. after power ON. (0°C to +50°C; +32°F to +122°F)
- Frequency resolution : 1 Hz
- Power supply : 13.8 V DC ±15% (negative ground)
- Power consumption
 - Transmit : Max. power 23 A
 - Receive : Standby 3.0 A
Max. audio 3.5 A
- Dimensions : 340(W) × 116(H) × 279.3(D) mm (projections not included)
13³/₈(W) × 4⁹/₁₆(H) × 11(D) in
- Weight (approx.) : 10.0 kg; 22 lb
- ACC 1 connector : 8-pin DIN connector
- ACC 2 connector : 7-pin DIN connector
- CI-V connector : 2-conductor 3.5 (d) mm (1/8")
- Display : 5.8-inch (diagonal) TFT color LCD

■ Transmitter

- Output power (continuously adjustable)
 - SSB/CW/RTTY/FM : Less than 2 to 100 W
 - AM : Less than 1 to 30 W
- Modulation system
 - SSB : Digital PSN modulation
 - AM : Digital Low power modulation
 - FM : Digital Phase modulation
- Spurious emission
 - HF bands : Less than –50 dB
 - 50 MHz band : Less than –63 dB
- Carrier suppression : More than 40 dB
- Unwanted sideband suppression : More than 55 dB
- ΔTX variable range : ±9.999 kHz
- Microphone connector : 8-pin connector (600 Ω)
- ELEC-KEY connector : 3-conductor 6.35(d) mm (1/4")
- KEY connector : 3-conductor 6.35(d) mm (1/4")
- SEND connector : Phono jack (RCA)
- ALC connector : Phono jack (RCA)

■ Receiver

- Receive system : Double superheterodyne system
- Intermediate frequencies
 - 1st : 64.455 MHz
 - 2nd : 36 kHz
- Sensitivity (typical)
 - SSB, CW, RTTY : 0.15 μV (1.80–29.99 MHz)*1
 - (10 dB S/N) BW=2.4 kHz : 0.12 μV (50.0–54.0 MHz)*2
 - AM (10 dB S/N) : 6.3 μV (0.1–1.799 MHz)*1
 - BW=6 kHz : 2 μV (1.80–29.99 MHz)*1
 - 1.6 μV (50.0–54.0 MHz)*2
 - FM (12 dB SINAD) : 0.5 μV (28.0–29.99 MHz)*1
 - BW=15 kHz : 0.3 μV (50.0–54.0 MHz)*2
- *1Pre-amp 1 is ON. *2Pre-amp 2 is ON.
- Squelch sensitivity (Pre-amp: ON)
 - SSB : Less than 3.2 μV
 - FM : Less than 0.3 μV
- Selectivity (IF filter shape is set to SHARP.)
 - SSB (BW: 2.4 kHz) : More than 2.4 kHz/–6 dB
Less than 3.8 kHz/–60 dB
 - CW (BW: 500 Hz) : More than 500 Hz/–6 dB
Less than 900 Hz/–60 dB
 - RTTY (BW: 350 Hz) : More than 350 Hz/–6 dB
Less than 650 Hz/–60 dB
 - AM (BW: 6 kHz) : More than 6.0 kHz/–6 dB
Less than 15.0 kHz/–60 dB
 - FM (BW: 15 kHz) : More than 12.0 kHz/–6 dB
Less than 20.0 kHz/–60 dB
- Spurious and image rejection ratio : More than 70 dB (except IF through on 50 MHz band)
- AF output power : More than 2.0 W at 10% distortion with an 8 Ω load
- RIT variable range : ±9.999 kHz
- PHONES connector : 3-conductor 6.35 (d) mm (1/4")
- External SP connector : 2-conductor 3.5 (d) mm (1/8")/8 Ω
- DSP ANF attenuation : More than 30 dB (with 1 kHz single tone)
- DSP NR attenuation : More than 6 dB (noise rejection in SSB)

■ Antenna tuner

- Matching impedance range
 - HF bands : 16.7 to 150 Ω unbalanced (Less than VSWR 3:1)
 - 50 MHz band : 20 to 125 Ω unbalanced (Less than VSWR 2.5:1)
- Minimum operating input power : 8 W (HF bands)
15 W (50MHz band)
- Tuning accuracy : VSWR 1.5:1 or less
- Insertion loss : Less than 1.0 dB (after tuning at RF power 100W)

Spurious signals may be displayed on the spectrum scope screen regardless of the transceiver's state (Tx or Rx). They are generated in the scope circuit. This does not indicate a transceiver malfunction.

All stated specifications are typical and subject to change without notice or obligation.

Options

IC-PW1/EURO HF/50 MHz ALL BAND 1 kW LINEAR AMPLIFIER



Full-duty 1 kW linear amplifier including an automatic antenna tuner. Has automatic tuning and band selection capability. Full break-in (QSK) operation is possible. The amplifier/power supply unit and the remote control unit are separated.

AH-4 HF AUTOMATIC ANTENNA TUNER



Specially designed to tune a long wire antenna for HF/50 MHz bands particularly in portable or mobile operation. The "PTT tune" function provides simple operation.

- Input power rating: 120 W

PS-126 DC POWER SUPPLY



- Output voltage : 13.8 V DC
- Max. output current : 25 A

SP-23 EXTERNAL SPEAKER



- 4 audio filters; headphone jack; can connect to 2 transceivers.
- Input impedance: 8 Ω
 - Max. input power: 4 W

AH-2b ANTENNA ELEMENT



A 2.5 m long antenna element for mobile operation with the AH-4.

- Frequency coverage 7–54 MHz band with the AH-4

HM-36 HAND MICROPHONE



Hand microphone equipped with [UP]/[DOWN] switches.

SM-20 DESKTOP MICROPHONE



Includes [UP]/[DOWN] switches and a low cut function.

SM-50 DESKTOP MICROPHONE



Flexible arm dynamic microphone including [UP]/[DOWN] switches and a low cut function.

CT-17 CI-V LEVEL CONVERTER UNIT



For remote transceiver control using a personal computer equipped with an RS-232C port. You can change frequencies, operating mode, memory channels, etc., via your computer.

• MB-121 CARRYING HANDLE

Convenient when carrying the transceiver. The same as that attached with the transceiver.

■ General

The IC-7600's firmware can be updated if desired. By updating the firmware, new function(s) can be added and the improvement of performance parameters can be obtained.

Refer to ■ Preparation (p. 163) and ■ Firmware update (p. 164) for details.

Ask your dealer or distributor about how to update the firmware if you have no PC.

The downloaded firmware data (e.g. 7600_110.dat) should be copied to the USB-Memory (in "IC-7600" folder) using an available USB port (USB hub may be required; purchased separately from your PC dealer).

■ Caution

CAUTION: NEVER turn the transceiver power OFF while updating the firmware.

You can turn the transceiver power OFF only when the transceiver displays that rebooting is required.

If you turn the transceiver power OFF, or if a power failure occurs during updating, the transceiver firmware will be corrupted and you will have to send the transceiver back to the nearest Icom distributor for repair. This type of repair is out of warranty even if the warranty period is still valid.

Recommendation!

Backing up the settings and/or memory contents to the USB-Memory before starting the firmware update is recommended.

Settings and/or memory contents will be lost or returned to default settings when the firmware update is performed.

■ Preparation

◇ Firmware and firm utility

The latest firmware can be downloaded from the Icom home page via the Internet. Access the following URL to download the firm utility and the latest firmware.

<http://www.icom.co.jp/world/support/index.html>

Information

The downloaded firmware data (e.g. 7600_110.dat) should be copied to the USB-Memory (in "IC-7600" folder) using an available USB port (USB hub may be required; purchased separately from your PC dealer).

◇ File downloading

- ① Access the following URL directly.
<http://www.icom.co.jp/world/support/index.html>
- ② Click "Firmware Updates/Software Downloads" link then click the firmware file link.

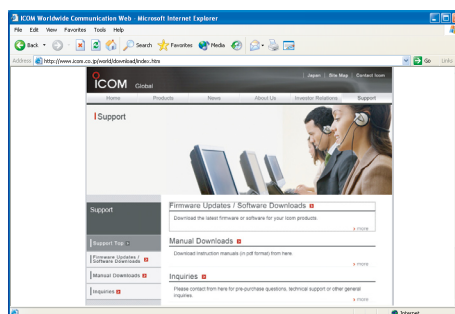

- ③ Read "Regarding this Download Service" carefully, then click [AGREE].

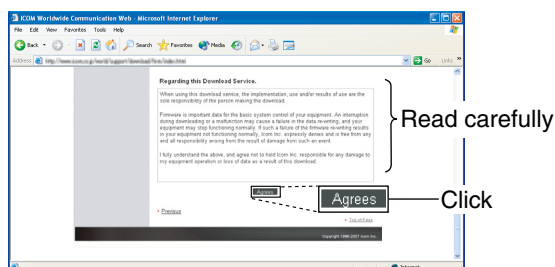

- ④ Click [Save] in the displayed File Download dialog.

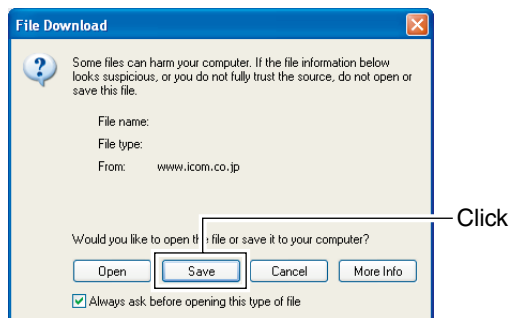

- ⑤ Select the desired location in which you want to save the firmware, then click [Save] in the displayed File Download dialog.

- File download starts.

- ⑥ After download is completed, extract the file.
 - The firmware and the firm utility are compressed in "zip" format, respectively.
 - When updating the transceiver using with the USB-Memory, copy the extracted firmware (e.g. 7600_110.dat) to the USB-Memory IC-7600 folder.
 - The USB-Memory must have been formatted by the IC-7600. (p. 143)

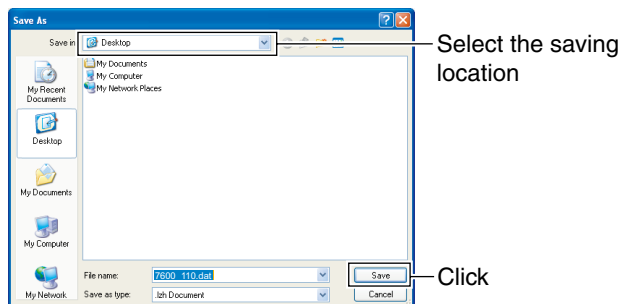

■ Firmware update

The transceiver indicates its firmware version information after turning power ON if the opening message screen indication capability is ON. (p. 127)

- ① Copy the downloaded firmware data into the "IC-7600" folder of the USB-Memory.
 - The USB-Memory must have been formatted by the IC-7600.
- ② Insert the USB-Memory into the [USB] (A) connector on the front panel.
- ③ Push [EXIT/SET] several times to close a multi-function screen, if necessary.
- ④ Push [SET] (F-6) to select set mode menu screen.
- ⑤ Push [USB] (F-6) to select USB-Memory set menu.
- ⑥ Push and hold [FIRM UP] (F-3) for 1 sec.

- ⑦ Read the displayed precaution carefully.
 - Push [▲] (F-1) or [▼] (F-2) to scroll the indication.
 - Push [CANCEL] (F-6) to cancel the firmware updating.

- ⑧ After you read and understand all of the precautions, push [OK] (F-5).
 - [OK] (F-5) appears only following the precautions.
 - Push [CANCEL] (F-6) to cancel the firmware updating.

- ⑨ Push [▲] (F-2) or [▼] (F-3) to select the firmware file, then push [FIRM UP] (F-4).

- ⑩ Read the displayed precautions carefully.

- ⑪ If you agree, push and hold [OK] (F-5) for 1 sec. to start the firmware update.
 - Push [CANCEL] (F-6) to cancel the firmware updating.

- ⑫ While loading the firmware from the USB-Memory, the dialog as at left is displayed.

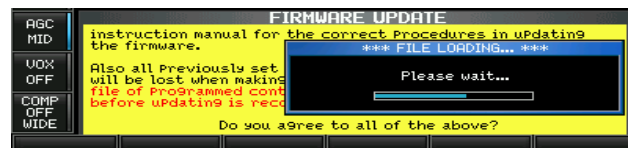
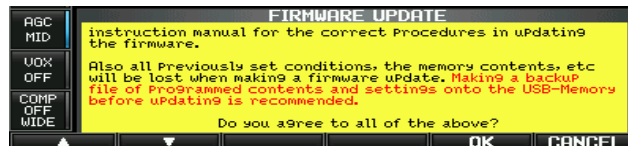
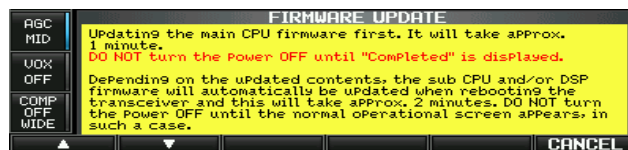
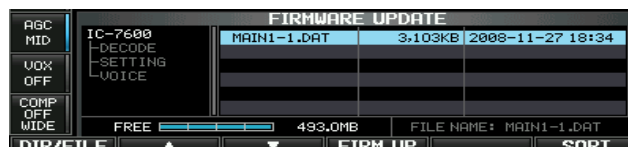
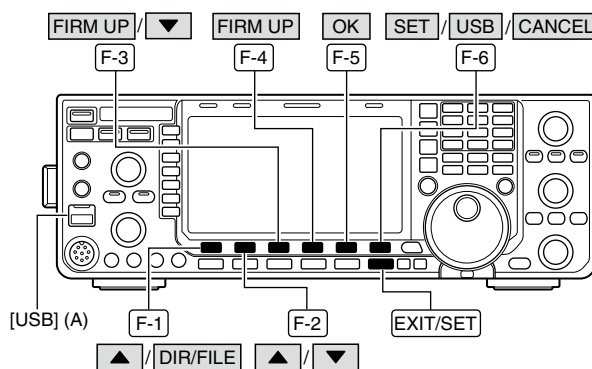

Continues to the next page.

■ Firmware update (Continued)

⑬ After the firmware loading is completed, the transceiver starts the update automatically and the dialog at right is displayed.

⚠ **WARNING: NEVER** turn the IC-7600 power OFF at this stage.
 ⚠ The transceiver firmware will be corrupted.

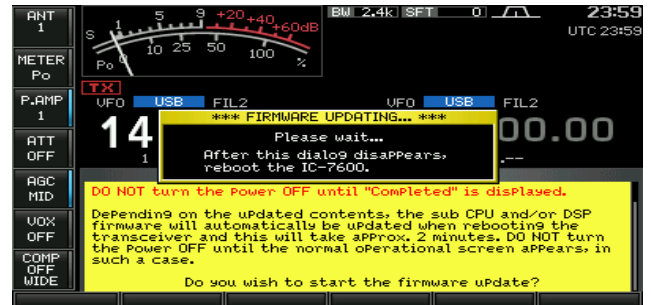

⑭ When the dialog disappears, the precaution at left is displayed.

⑮ Read the precaution carefully, and then push **[OK] (F-5)**.
 • Return to USB-Memory set menu.

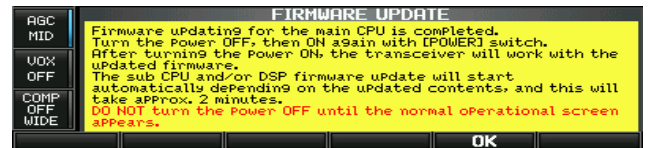

⑯ Push **[POWER]** to turn the IC-7600 power OFF, then ON again.

⑰ Depending on the update, one or two dialog boxes as at right appear in sequence.

⚠ **WARNING: NEVER** turn the IC-7600 power OFF at this stage.
 ⚠ The transceiver firmware will be corrupted.

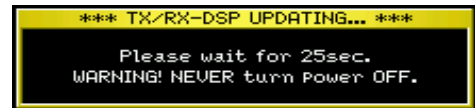
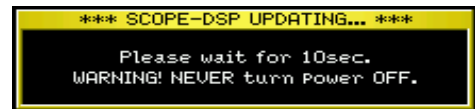

⑱ After the dialog disappears, the firmware updating is completed and normal operation screen appears.

INSTALLATION NOTES

For amateur base station installations it is recommended that the forward clearance in front of the antenna array is calculated relative to the EIRP (Effective Isotropic Radiated Power). The clearance height below the antenna array can be determined in most cases from the RF power at the antenna input terminals.

As different exposure limits have been recommended for different frequencies, a relative table shows a guideline for installation considerations.

Below 30 MHz, the recommended limits are specified in terms of V/m or A/m fields as they are likely to fall within the near-field region. Similarly, the antennas may be physically short in terms of electrical length and that the installation will require some antenna matching device which can create local, high intensity magnetic fields. Analysis of such MF installations is best considered in association with published guidance notes such as the FCC OET Bulletin 65 Edition 97-01 and its annexes relative to amateur transmitter installations.

The EC recommended limits are almost identical to the FCC specified 'uncontrolled' limits and tables exist that show pre-calculated safe distances for different antenna types for different frequency bands. Further information can be found at <http://www.arrl.org/>.

• Typical amateur radio installation

Exposure distance assumes that the predominant radiation pattern is forward and that radiation vertically downwards is at unity gain (sidelobe suppression is equal to main lobe gain). This is true of almost every gain antenna today. Exposed persons are assumed to be beneath the antenna array and have a typical height of 1.8 m.

The figures assume the worst case emission of a constant carrier.

For the bands 10 MHz and higher the following power density limits have been recommended:

10–50 MHz 2 W/sq m

Vertical clearance by EIRP output

1 Watts	2.1 m
10 Watts	2.8 m
25 Watts	3.4 m
100 Watts	5 m
1000 Watts	12 m

Forward clearance by EIRP output

100 Watts	2 m
1000 Watts	6.5 m
10,000 Watts	20 m
100,000 Watts	65 m

In all cases any possible risk depends on the transmitter being activated for long periods. (actual recommendation limits are specified as an average during 6 minutes) Normally the transmitter is not active for long periods of time. Some radio licenses will require that a timer circuit automatically cuts off the transmitter after 1–2 minutes etc.

Similarly some modes of transmission, SSB, CW, AM etc. have a lower 'average' output power and the assessed risk is even lower.

 Versions of the IC-7600 which display the "CE" symbol on the serial number seal, comply with the essential requirements of the European Radio and Telecommunication Terminal Directive 1999/5/EC.

 This warning symbol indicates that this equipment operates in non-harmonised frequency bands and/or may be subject to licensing conditions in the country of use. Be sure to check that you have the correct version of this radio or the correct programming of this radio, to comply with national licensing requirement.

• List of Country codes (ISO 3166-1)

	Country	Codes		Country	Codes
1	Austria	AT	18	Liechtenstein	LI
2	Belgium	BE	19	Lithuania	LT
3	Bulgaria	BG	20	Luxembourg	LU
4	Croatia	HR	21	Malta	MT
5	Czech Republic	CZ	22	Netherlands	NL
6	Cyprus	CY	23	Norway	NO
7	Denmark	DK	24	Poland	PL
8	Estonia	EE	25	Portugal	PT
9	Finland	FI	26	Romania	RO
10	France	FR	27	Slovakia	SK
11	Germany	DE	28	Slovenia	SI
12	Greece	GR	29	Spain	ES
13	Hungary	HU	30	Sweden	SE
14	Iceland	IS	31	Switzerland	CH
15	Ireland	IE	32	Turkey	TR
16	Italy	IT	33	United Kingdom	GB
17	Latvia	LV			



**DECLARATION
OF CONFORMITY**

We Icom Inc. Japan
1-1-32, Kamiminami, Hirano-ku
Osaka 547-0003, Japan

Declare on our sole responsibility that this equipment complies with the essential requirements of the Radio and Telecommunications Terminal Equipment Directive, 1999/5/EC, and that any applicable Essential Test Suite measurements have been performed.

Kind of equipment: HF/50 MHz TRANSCEIVER

Type-designation: IC-7600

Version (where applicable):

This compliance is based on conformity with the following harmonised standards, specifications or documents:

- i) EN 301 489-1 v1.6.1 (September 2005)
- ii) EN 301 489-15 v1.2.1 (August 2002)
- iii) EN 301 783-2 v1.1.1 (September 2000)
- iv) EN 60950-1 : 2001



Düsseldorf 23rd Jan. 2009
Place and date of issue

Icom (Europe) GmbH
Himmelgeisterstraße 100
D-40225 Düsseldorf

Authorized representative name

Y. Furukawa
General Manager

Signature

Icom Inc.

IC-7600 #03
(Europe)

< Intended Country of Use >
AT BE CY CZ DK EE
FI FR DE GR HU IE
IT LV LT LU MT NL
PL PT SK SI ES SE
GB IS LI NO CH BG
RO TR HR

IC-7600 #04
(Europe-1)

< Intended Country of Use >
AT BE CY CZ DK EE
FI FR DE GR HU IE
IT LV LT LU MT NL
PL PT SK SI ES SE
GB IS LI NO CH BG
RO TR HR

IC-7600 #05
(Spain)

< Intended Country of Use >
AT BE CY CZ DK EE
FI FR DE GR HU IE
IT LV LT LU MT NL
PL PT SK SI ES SE
GB IS LI NO CH BG
RO TR HR

IC-7600 #09
(Italy)

< Intended Country of Use >
AT BE CY CZ DK EE
FI FR DE GR HU IE
IT LV LT LU MT NL
PL PT SK SI ES SE
GB IS LI NO CH BG
RO TR HR

IC-7600 #10
(France)

< Intended Country of Use >
AT BE CY CZ DK EE
FI FR DE GR HU IE
IT LV LT LU MT NL
PL PT SK SI ES SE
GB IS LI NO CH BG
RO TR HR