

THE TRANSCEIVER
IC-7800
Instruction Manual

FOREWORD

Congratulations! You are the owner of the world's most advanced amateur HF/50 MHz transceiver— IC-7800. The IC-7800 is designed and built with Icom's superior technology and craftsmanship. With proper care, this product should provide you with years of trouble-free operation.

We would like to take a few moments of your time to thank you for making the IC-7800 your radio of choice, and hope you agree with Icom's philosophy of "technology first." Many hours of research and development went into the design of your IC-7800.

◇ **FEATURES**

- *Ultimate receiver performance: third-order intercept (IP3) of +40 dBm (HF bands only), both main and sub*
- *Independent identical receiver circuits for main and sub bands provide perfect no-compromise Dualwatch operation*
- *Built-in Baudot RTTY and PSK31 modulator/demodulator and direct PC keyboard connection capability for RTTY and PSK31 operation without a PC*
- *Upgraded real-time spectrum scope— center frequency and fix frequency modes, plus mini-scope displays*

IMPORTANT

READ THIS INSTRUCTION MANUAL CAREFULLY before attempting to operate the transceiver.

SAVE THIS INSTRUCTION MANUAL. This manual contains important safety and operating instructions for the IC-7800.

EXPLICIT DEFINITIONS

WORD	DEFINITION
⚠ DANGER!	Personal death, serious injury or an explosion may occur.
⚠ WARNING!	Personal injury, fire hazard or electric shock may occur.
CAUTION	Equipment damage may occur.
NOTE	Recommended for optimum use. No risk of personal injury, fire or electric shock.

TRADEMARKS

Icom, Icom Inc. and the Icom logo are registered trademarks of Icom Incorporated (Japan) in Japan, the United States, the United Kingdom, Germany, France, Spain, Russia, Australia, New Zealand, and/or other countries.

PRECAUTIONS

⚠ DANGER HIGH RF VOLTAGE! NEVER attach an antenna or internal antenna connector during transmission. This may result in an electrical shock or burn.

⚠ WARNING! NEVER operate the transceiver with a headset or other audio accessories at high volume levels. Hearing experts advise against continuous high volume operation. If you experience a ringing in your ears, reduce the volume or discontinue use.

⚠ WARNING! NEVER operate or touch the transceiver with wet hands. This may result in an electric shock or damage to the transceiver.

⚠ WARNING! NEVER let metal, wire or other objects protrude into the transceiver or into connectors on the rear panel. This may result in an electric shock.

⚠ WARNING! Immediately turn the transceiver power OFF and remove the power cable if it emits an abnormal odor, sound or smoke. Contact your Icom dealer or distributor for advice.

CAUTION: NEVER put the transceiver in any unstable place (such as on a slanted surface or vibrated place). This may cause injury and/or damage to the transceiver.

CAUTION: NEVER change the internal settings of the transceiver. This may reduce transceiver performance and/or damage to the transceiver.

In particular, incorrect settings for transmitter circuits, such as output power, idling current, etc., might damage the expensive final devices.

The transceiver warranty does not cover any problems caused by unauthorized internal adjustment.

CAUTION: NEVER block any cooling vents on the top, rear or bottom of the transceiver.

CAUTION: NEVER expose the transceiver to rain, snow or any liquids.

CAUTION: NEVER install the transceiver in a place without adequate ventilation. Heat dissipation may be reduced, and the transceiver may be damaged.

CAUTION: The line-voltage receptacle must be near the transceiver and must be easily accessible. Avoid extension cords.

CAUTION: The transceiver weighs approximately 25 kg (55 lb). Always have two people available to carry, lift or turn over the transceiver.

DO NOT use harsh solvents such as benzine or alcohol when cleaning, as they can damage the transceiver's surfaces.

DO NOT push the PTT switch when you don't actually desire to transmit.

DO NOT use or place the transceiver in areas with temperatures below $\pm 0^{\circ}\text{C}$ ($+32^{\circ}\text{F}$) or above $+50^{\circ}\text{C}$ ($+122^{\circ}\text{F}$).

DO NOT place the transceiver in excessively dusty environments or in direct sunlight.

DO NOT place the transceiver against walls or putting anything on top of the transceiver. This may overheat the transceiver.

Always place unit in a secure place to avoid inadvertent use by children.

BE CAREFUL! If you use a linear amplifier, set the transceiver's RF output power to less than the linear amplifier's maximum input level, otherwise, the linear amplifier will be damaged.

BE CAREFUL! NEVER touch the transceiver top cover when transmitting continuously for long periods. The top cover may be hot.

Use Icom microphones only (supplied or optional). Other manufacturers' microphones have different pin assignments, and connection to the IC-7800 may damage the transceiver or microphone.

The LCD display may have cosmetic imperfections that appear as small dark or light spots. This is not a malfunction or defect, but a normal characteristic of LCD displays.

During maritime mobile operation, keep the transceiver and microphone as far away as possible from the magnetic navigation compass to prevent erroneous indications.

Turn [I/O] switch (on the rear panel) OFF and/or disconnect the AC power cable from the AC outlet when you will not use the transceiver for long period of time.

SUPPLIED ACCESSORIES

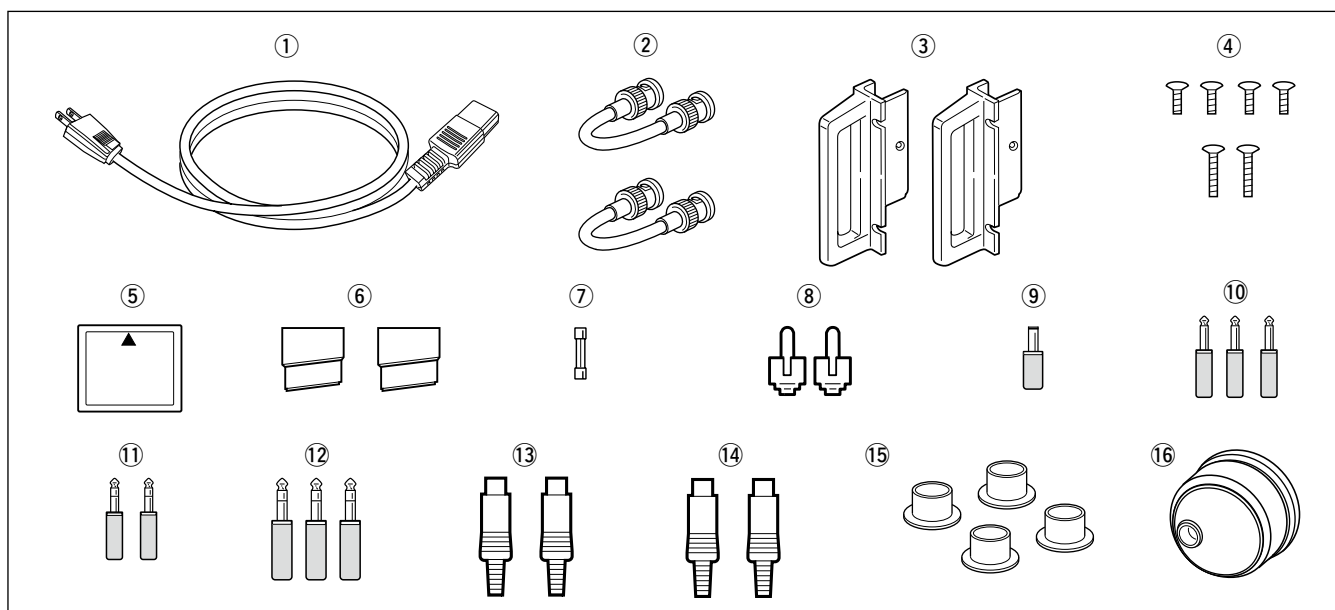

① AC power cable* ¹	1
② Antenna jumper cables	2
③ Rack mounting handles	1 pair
④ Screws for rack mounting handles	1 set
⑤ CF (Compact Flash) memory card	1
⑥ Stands	1 pair
⑦ Spare fuse (FGB 2 A)	1
⑧ RCA plugs	2
⑨ DC power plug	1

⑩ 2-conductor 1/8" plugs	3
⑪ 3-conductor 1/8" plugs	2
⑫ 3-conductor 1/4" plugs	3
⑬ ACC plugs (7-pin)	2
⑭ ACC plugs (8-pin)	2
⑮ Antenna connector caps	4
⑯ Main dial* ²	1

*¹May differ from that shown depending on the version

*²See the "Information—About the Main Dial" leaflet that comes with the IC-7800, for dial attachment details.

FCC INFORMATION

FOR CLASS B UNINTENTIONAL RADIATORS

This equipment has been tested and found to comply with the limits for a Class B digital device, pursuant to part 15 of the FCC Rules. These limits are designed to provide reasonable protection against harmful interference in a residential installation. This equipment generates, uses and can radiate radio frequency energy and, if not installed and used in accordance with the instructions, may cause harmful interference to radio communications. However, there is no guarantee that interference will not occur in a particular installation. If this equipment does cause harmful interference to radio or television reception, which can be determined by turning the equipment off and on, the user is encouraged to try to correct the interference by one or more of the following measures:

- Reorient or relocate the receiving antenna.
- Increase the separation between the equipment and receiver.
- Connect the equipment into an outlet on a circuit different from that to which the receiver is connected.
- Consult the dealer or an experienced radio/TV technician for help.

CAUTION: Changes or modifications to this device, not expressly approved by Icom Inc., could void your authority to operate this device under FCC regulations.

TABLE OF CONTENTS

Section 1	PANEL DESCRIPTION	
	■ Front panel	1-2
	■ Rear panel	1-12
	■ Accessory connector information	1-14
	■ LCD display	1-15
	■ Screen menu arrangement	1-16
Section 2	INSTALLATION AND CONNECTIONS	
	■ Unpacking	2-2
	■ Antenna jumper cable connection	2-2
	■ Selecting a location	2-2
	■ Rack mounting handle attachment	2-2
	■ Grounding	2-3
	■ Antenna connection	2-3
	■ CF (Compact Flash) memory card	2-3
	■ Required connections	2-4
	◇ Front panel	2-4
	◇ Rear panel	2-4
	■ Advanced connections	2-5
	◇ Front panel	2-5
	◇ Rear panel—1	2-5
	◇ Rear panel—2	2-6
	■ Linear amplifier connections	2-7
	◇ Connecting the IC-PW1/EURO	2-7
	◇ Connecting a non-Icom linear amplifier	2-7
	■ Transverter jack information	2-8
	■ FSK and AFSK connections	2-8
	◇ When using the ACC socket or the microphone connector	2-8
	■ Microphones (options)	2-9
	◇ SM-50	2-9
	◇ SM-30	2-9
	◇ HM-36	2-10
	■ Microphone connector information	2-10
Section 3	BASIC OPERATIONS	
	■ When first applying power (CPU resetting)	3-2
	■ Initial settings	3-2
	■ Main/Sub band selection	3-3
	■ Selecting VFO/memory mode	3-3
	■ Selecting an operating band	3-4
	◇ Using the band stacking registers	3-4
	■ Frequency setting	3-5
	◇ Tuning with the main dial	3-5
	◇ Direct frequency entry with the keypad	3-5
	◇ Quick tuning step	3-6
	◇ Selecting “kHz” step	3-6
	◇ 1/4 tuning step function	3-6
	◇ Selecting 1 Hz step	3-7
	◇ Auto tuning step function	3-7
	■ Operating mode selection	3-8
	■ Volume setting	3-9
	■ RF gain adjustment	3-9
	■ Squelch level adjustment	3-9
	■ Meter indication selection	3-10
	◇ Multi-function digital meter	3-10
	◇ Meter type selection	3-11

TABLE OF CONTENTS

■ Basic transmit operation	3-12
◇ Transmitting	3-12
◇ Microphone gain adjustment	3-12
◇ Drive gain adjustment	3-13
■ Band edge warning beep	3-13
◇ Programming the user band edge	3-14
Section 4 RECEIVE AND TRANSMIT	
■ Operating SSB	4-2
◇ Convenient functions for receive	4-2
◇ Convenient functions for transmit	4-3
◇ About 5 MHz band operation (USA version only)	4-3
■ Operating CW	4-4
◇ Convenient functions for receive	4-4
◇ Convenient functions for transmit	4-5
◇ About CW reverse mode	4-5
◇ About CW pitch control	4-5
◇ CW side tone function	4-5
◇ APF (Audio Peak Filter) operation	4-6
◇ About 137 kHz band operation (Europe, UK, Italy, Spain, France versions only)	4-6
■ Electronic keyer functions	4-7
◇ Memory keyer screen	4-8
◇ Editing a memory keyer	4-9
◇ Contest number set mode	4-10
◇ Keyer set mode	4-11
■ Operating RTTY (FSK)	4-13
◇ Convenient functions for receive	4-14
◇ About RTTY reverse mode	4-14
◇ Twin peak filter	4-14
◇ Functions for the RTTY decoder indication	4-15
◇ Setting the decoder threshold level	4-15
◇ RTTY memory transmission	4-16
◇ Automatic transmission/reception setting	4-16
◇ Editing RTTY memory	4-17
◇ RTTY decode set mode	4-18
◇ Data saving	4-20
■ Operating PSK	4-21
◇ Convenient functions for receive	4-22
◇ About BPSK and QPSK mode	4-22
◇ Functions for the PSK decoder indication	4-23
◇ Setting the decoder threshold level	4-23
◇ PSK memory transmission	4-24
◇ Automatic transmission/reception setting	4-24
◇ Editing PSK memory	4-25
◇ PSK decode set mode	4-26
◇ Data saving	4-28
■ Operating AM	4-29
◇ Convenient functions for receive	4-29
◇ Convenient functions for transmit	4-30
■ Operating FM	4-31
◇ Convenient functions for receive	4-31
◇ Convenient functions for transmit	4-31
■ Repeater operation	4-32
◇ Repeater tone frequency setting	4-32
■ Tone squelch operation	4-33
■ Data mode (AFSK) operation	4-34

TABLE OF CONTENTS

Section 5	FUNCTIONS FOR RECEIVE	
	■ Spectrum scope screen	5-2
	◇ Center mode	5-2
	◇ Fix mode	5-3
	◇ Mini scope screen indication	5-4
	◇ Scope set mode	5-4
	◇ USB mouse operation	5-9
	■ Preamplifier	5-10
	■ Attenuator	5-10
	■ RIT function	5-11
	◇ RIT monitor function	5-11
	■ AGC function	5-12
	◇ Selecting the preset value	5-12
	◇ Adjusting the AGC time constant	5-12
	◇ Setting the AGC time constant preset value	5-12
	■ Twin PBT operation	5-13
	■ IF filter selection	5-14
	◇ IF filter selection	5-14
	◇ Filter passband width setting (except FM mode)	5-14
	◇ Roofing filter selection	5-15
	◇ DSP filter shape	5-15
	◇ Filter shape set mode	5-15
	■ Dualwatch operation	5-17
	■ Noise blanker	5-18
	◇ NB set mode	5-18
	■ Noise reduction	5-19
	■ Dial lock function	5-19
	■ Notch function	5-20
	■ Digital selector	5-20
	■ Audio scope screen	5-21
	◇ Audio scope set mode	5-22
Section 6	FUNCTIONS FOR TRANSMIT	
	■ VOX function	6-2
	◇ Using the VOX function	6-2
	◇ Adjusting the VOX function	6-2
	◇ VOX set mode	6-2
	■ Break-in function	6-3
	◇ Semi break-in operation	6-3
	◇ Full break-in operation	6-3
	■ ΔTX function	6-4
	◇ ΔTX monitor function	6-4
	■ Monitor function	6-4
	■ Transmit filter width setting (SSB only)	6-5
	■ Speech compressor (SSB only)	6-5
	■ Split frequency operation	6-6
	■ Quick split function	6-7
	◇ Split lock function	6-7

TABLE OF CONTENTS

Section 7	VOICE RECORDER FUNCTIONS	
	■ Recording a QSO audio	7-2
	◇ To start or stop recording	7-2
	■ Recording quick operation	7-2
	◇ To start or stop recording	7-2
	■ Playing back recorded audio (QSO)	7-3
	◇ Basic playing	7-3
	◇ Operating while playing back	7-4
	■ Deleting recorded audio file	7-5
	■ Deleting recorded audio folder.....	7-5
	■ About digital voice recorder	7-6
	■ Recording a received audio (Short REC)	7-7
	◇ One-touch recording	7-7
	■ Playing back the recorded audio (Short REC)	7-7
	◇ Basic playing	7-7
	◇ One-touch playing	7-8
	■ Protect the recorded contents	7-8
	■ Erasing the recorded contents.....	7-8
	■ Recording a message for transmit	7-9
	◇ Recording	7-9
	◇ Confirming a message for transmit.....	7-9
	■ Programming a memory name	7-10
	■ Sending a recorded message	7-11
	◇ Single TX.....	7-11
	◇ Repeat TX	7-11
	◇ Transmit level setting	7-12
	■ Voice set mode	7-12
	■ Saving a voice memory into the memory device	7-15
	◇ Saving the received audio memory	7-15
	◇ Saving the TX memory	7-15
Section 8	MEMORY OPERATION	
	■ Memory channels	8-2
	■ Memory channel selection	8-2
	◇ Using the [▲]/[▼] keys	8-2
	◇ Using the keypad	8-2
	■ Memory list screen.....	8-3
	◇ Selecting a memory channel using the memory list screen	8-3
	◇ Confirming programmed memory channels	8-3
	■ Memory channel programming	8-4
	◇ Programming in VFO mode	8-4
	◇ Programming in memory mode	8-4
	■ Frequency transferring	8-5
	◇ Transferring in VFO mode	8-5
	◇ Transferring in memory mode	8-5
	■ Memory names	8-6
	◇ Editing (programming) memory names	8-6
	■ Memory clearing.....	8-6
	■ Memo pads	8-7
	◇ Writing frequencies and operating modes into memo pads	8-7
	◇ Calling up a frequency and operating mode from a memo pad...	8-7
Section 9	SCANS	
	■ Scan types	9-2
	■ Preparation	9-2
	■ Voice squelch control function	9-3
	■ Scan set mode	9-3
	■ Programmed scan operation	9-4

TABLE OF CONTENTS

	■ Δ F scan operation	9-4
	■ Fine programmed scan/ Δ F scan	9-5
	■ Memory scan operation	9-6
	■ Select memory scan operation	9-6
	■ Setting select memory channels	9-7
	◇ Setting in scan screen	9-7
	◇ Setting in memory list screen	9-7
	◇ Erasing the select scan setting	9-7
	■ Tone scan	9-8
Section 10	ANTENNA TUNER OPERATION	
	■ Antenna connection and selection	10-2
	■ Antenna memory settings	10-3
	◇ Antenna type selection	10-3
	◇ Temporary memory	10-4
	◇ Antenna selection mode	10-4
	■ Antenna tuner operation	10-5
	◇ Tuner operation	10-5
	◇ If the tuner cannot tune the antenna	10-6
Section 11	CLOCK AND TIMERS	
	■ Time set mode	11-2
	■ Daily timer setting	11-3
	■ Setting sleep timer	11-4
	■ Timer operation	11-4
Section 12	SET MODE	
	■ Set mode description	12-2
	◇ Set mode operation	12-2
	◇ Screen arrangement	12-3
	■ Level set mode	12-4
	■ ACC set mode	12-6
	■ Display set mode	12-11
	■ Others set mode	12-14
	■ CF/USB-MEMORY set menu	12-27
	◇ CF/USB-MEMORY set screen arrangement	12-27
	◇ Save option set mode	12-28
	◇ Load option set mode	12-29
	■ File saving	12-30
	■ File loading	12-31
	■ Changing the file name	12-32
	■ Deleting a file	12-33
	■ Formatting the memory device	12-33
	■ Unmounting the memory device	12-34
Section 13	MAINTENANCE	
	■ Troubleshooting	13-2
	◇ Transceiver power	13-2
	◇ Transmit and receive	13-2
	◇ Scanning	13-3
	◇ Display	13-3
	■ Main dial brake adjustment	13-3
	■ Voice synthesizer operation	13-3
	■ SWR reading	13-4
	■ Screen type and font selections	13-4
	■ Frequency calibration (approximate)	13-5
	■ Opening the transceiver's case	13-6
	■ Clock backup battery replacement	13-6

TABLE OF CONTENTS

	■ Fuse replacement	13-7
	■ Resetting the CPU	13-7
	■ About protection indications	13-8
	■ Screen saver function	13-8
Section 14	CONTROL COMMAND	
	■ Remote jack (CI-V) information	14-2
	◇ CI-V connection example	14-2
	◇ Data format	14-2
	◇ Command table	14-3
	◇ Data contents description	14-10
Section 15	SPECIFICATIONS AND OPTIONS	
	■ Specifications	15-2
	◇ General	15-2
	◇ Transmitter	15-2
	◇ Receiver	15-3
	◇ Antenna tuner	15-3
	■ Options	15-4
Section 16	UPDATING THE FIRMWARE	
	■ General	16-2
	■ Caution	16-2
	■ Preparation	16-3
	◇ Firmware and firm utility	16-3
	◇ File downloading	16-3
	■ Firmware update— Memory device	16-4
	■ Firmware update— PC	16-6
	◇ Connections	16-6
	◇ IP address setting	16-7
	◇ Updating from the PC	16-8

PANEL DESCRIPTION

Section 1

■ Front panel	1-2
■ Rear panel	1-12
■ Accessory connector information	1-14
■ LCD display	1-15
■ Screen menu arrangement	1-16

■ Front panel

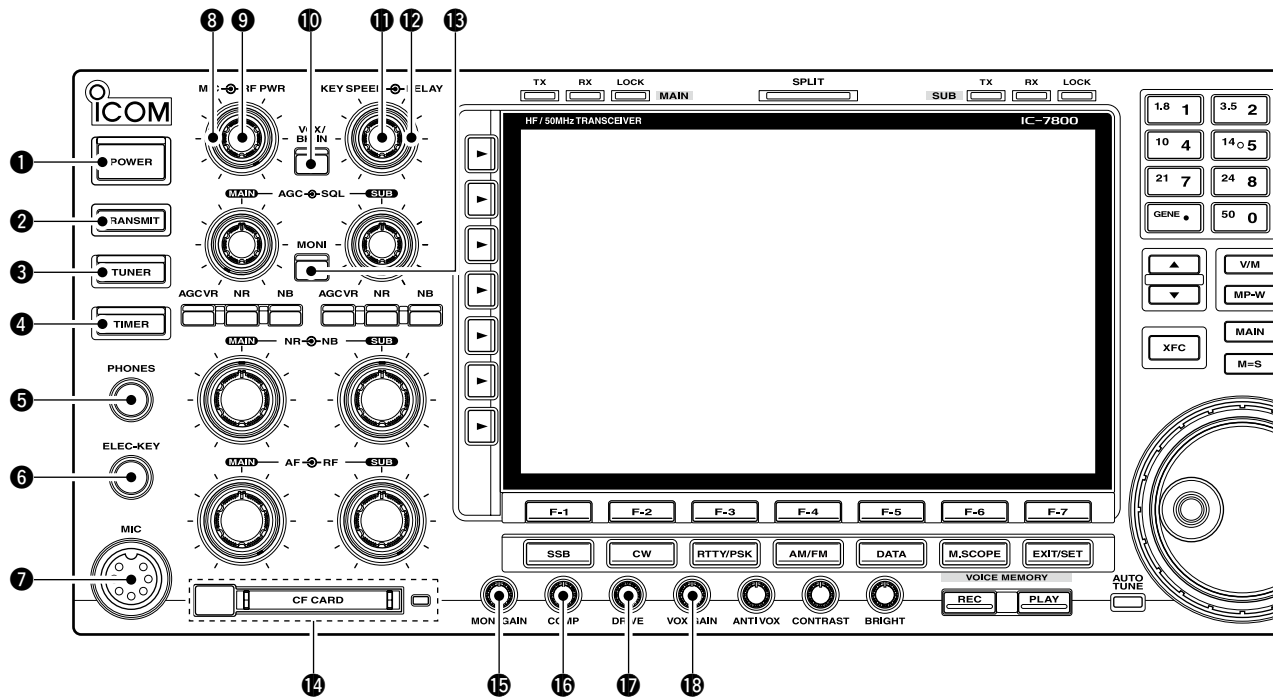

1 POWER SWITCH [POWER] (p. 3-2)

Turn the internal power supply ON in advance. The internal power supply switch is located on the rear panel. (p. 3-2)

- ➔ Push to turn the transceiver power ON.
 - The [POWER] indicator above this switch lights green when powered ON.
- ➔ Hold down for 1 second to turn the transceiver power OFF.
 - The [POWER] indicator lights orange when the transceiver is OFF when the internal power supply is switched ON.

2 TRANSMIT SWITCH [TRANSMIT]

Selects transmitting or receiving.

- The [TX] indicator lights red while transmitting and the [RX] indicator lights green when the squelch is open.

3 ANTENNA TUNER SWITCH [TUNER] (p. 10-5)

- ➔ Turns the internal antenna tuner ON or OFF (bypass) when pushed momentarily.
 - The [TUNER] indicator above this switch lights green when the tuner is turned ON, goes off when tuner is turned OFF (bypassed).
- ➔ Tunes the antenna tuner manually when held down for 1 second.
 - The [TUNER] indicator blinks red during manual tuning.
 - When the tuner cannot tune the antenna, the tuning circuit is bypassed automatically after 20 seconds.

4 TIMER SWITCH [TIMER] (p. 11-4)

- ➔ Turns the sleep or daily timer function ON or OFF.
 - The [TIMER] indicator above this switch lights green when the timer is in use.
- ➔ Enters timer set mode when held down for 1 second.

5 HEADPHONE JACK [PHONES]

Accepts standard stereo headphones.

- Output power: 50 mW with an 8 Ω load.
- When headphones are connected, the internal speaker or connected external speaker does not function.

6 ELECTRONIC KEYS JACK [ELEC-KEY] (p. 2-4)

Accepts a paddle to activate the internal electronic keyer for CW operation.

- You can select internal electronic keyer, bug-key or straight key operation in keyer set mode. (p. 4-12)
- A straight key jack is located on the rear panel. See [KEY] on p. 1-13.
- Keyer polarity (dot and dash) can be reversed in keyer set mode. (p. 4-12)
- 4-channel memory keyer is available for your convenience. (p. 4-8)

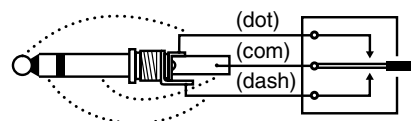

7 MICROPHONE CONNECTOR [MIC]

Accepts an optional microphone.

- See p. 15-4 for appropriate microphones.
- See p. 2-10 for microphone connector information.

8 RF POWER CONTROL [RF PWR] (p. 3-12)

Continuously varies the RF output power from minimum (5 W*) to maximum (200 W*).

*AM mode: 5 W to 50 W

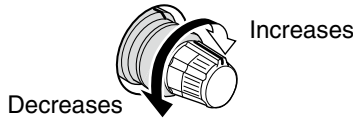

9 MIC GAIN CONTROL [MIC]

Adjusts microphone gain.

- The transmit audio tone in SSB, AM and FM modes can be adjusted independently in set mode. (p. 12-4)

✓ How to set the microphone gain.

Set the [MIC] control so that the ALC meter swings within the ALC range during normal voice level transmission in the SSB or AM modes. (The ALC meter must be selected.)

Recommended level for an Icom microphone

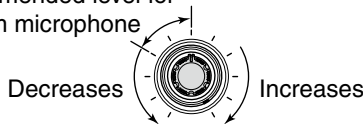

10 VOX/BREAK-IN SWITCH [VOX/BK-IN]

- ➔ Push to turn the VOX function ON or OFF during SSB, AM and FM mode operation. (p. 6-2)
- ➔ Push to turn the break-in function ON (semi-break-in, full-break-in) or OFF during CW mode operation. (p. 6-3)
- ➔ Hold down for 1 second to enter VOX set mode. (p. 6-2)

✓ What is the VOX function?

The VOX function (voice operated transmission) starts transmission without pushing the transmit switch or PTT switch when you speak into the microphone; then, automatically returns to receive when you stop speaking.

✓ What is the break-in function?

The break-in function switches transmit and receive with CW keying. Full break-in (QSK) can monitor the receive signal during keying.

11 ELECTRONIC CW KEYSER SPEED CONTROL [KEY SPEED] (p. 4-4)

Adjusts the internal electronic CW keyer's speed.

- 6 wpm (min.) to 48 wpm (max.) can be set.

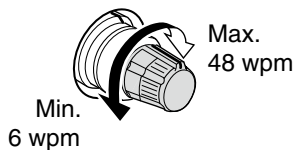

12 BREAK-IN DELAY CONTROL [DELAY] (p. 6-3)

Adjusts the transmit-to-rotate switching delay time for CW semi-break-in operations.

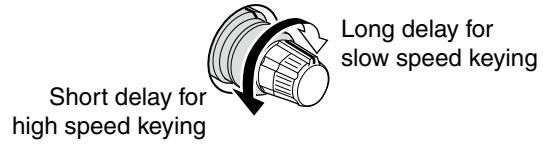

13 MONITOR SWITCH [MONI] (p. 6-4)

Monitors your transmitted IF signal.

- The CW sidetone functions regardless of [MONI] switch setting in CW mode.
- The [MONI] indicator above this switch lights green while the function is activated.

14 MEMORY CARD SLOT [CF CARD] (p. 2-3)

Insert the supplied CF (Compact Flash) memory card for both reading/storing a wide variety of the transceiver's information and data.

- The indicator beside the slot lights or blinks when the transceiver reads or writes to the memory card.
- Push the eject button to remove the memory card.

15 MONITOR GAIN CONTROL [MONI GAIN] (p. 6-4)

Adjusts the transmit IF signal monitor level.

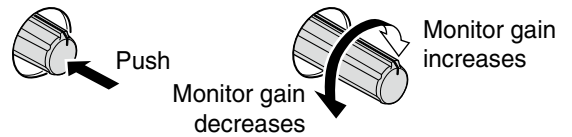

16 COMPRESSION LEVEL CONTROL [COMP] (p. 6-5)

Adjusts the speech compression level in SSB.

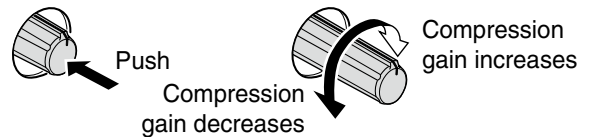

17 DRIVE GAIN CONTROL [DRIVE] (p. 3-13)

Adjusts the transmitter level at the driver stage. Activate in all modes (except SSB with [COMP] OFF).



18 VOX GAIN CONTROL [VOX GAIN] (p. 6-2)

Adjusts the transmit/rotate switching threshold level for VOX operation.

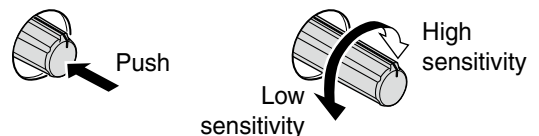

■ Front panel (continued)

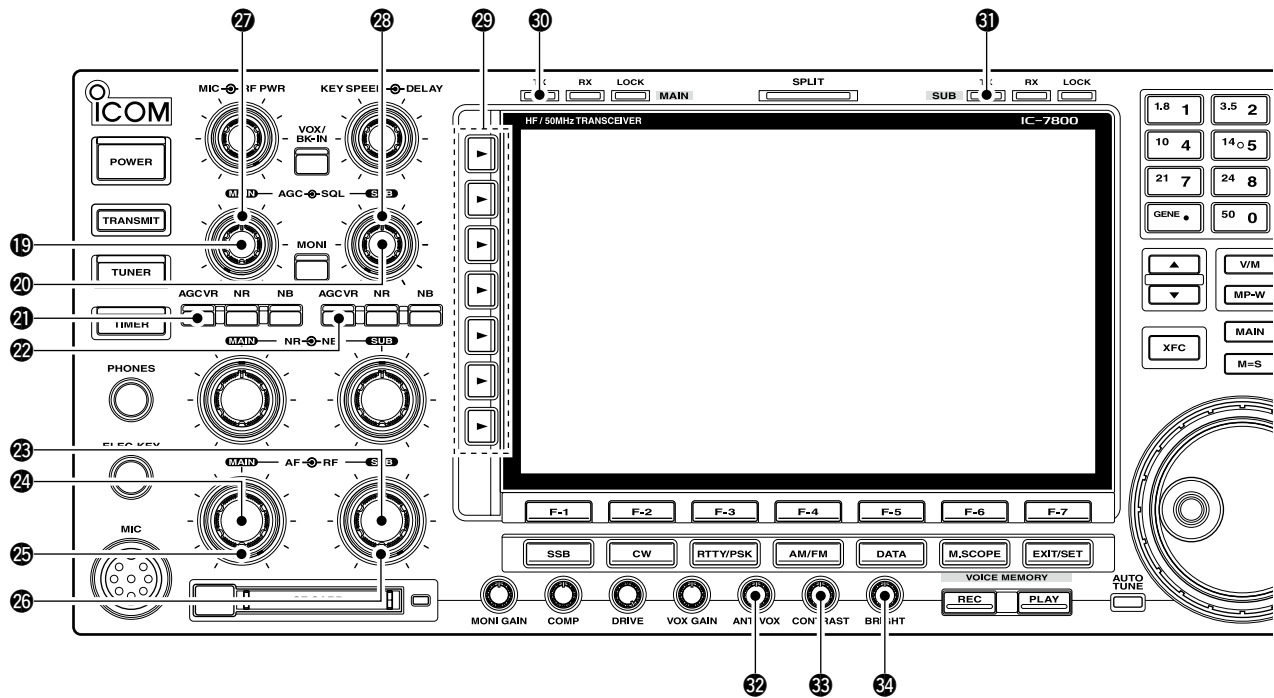

- 19 **AGC CONTROL [AGC]** (for MAIN band; p. 5-12)
- 20 **AGC CONTROL [AGC]** (for SUB band; p. 5-12)
Adjusts the continuously-variable AGC circuit time constant.
 - To use [AGC] control, push the appropriate band's [AGC VR] ([AGC VR] indicator lights).



- 21 **AGC VOLUME SWITCH [AGC VR]**
(for MAIN band; p. 5-12)
- 22 **AGC VOLUME SWITCH [AGC VR]**
(for SUB band; p. 5-12)
 - Push to toggle [AGC] control usage ON or OFF.
 - Use [AGC] control to set the AGC time constant when switched ON.
 - The [AGC VR] indicator above this switch lights green when the control is ON.
 - Turns the AGC function OFF when held down for 1 second.

- 23 **AF CONTROL [AF]** (inner control; for SUB band)
- 24 **AF CONTROL [AF]** (inner control; for MAIN band)
Varies the audio output level of the speaker or headphones.

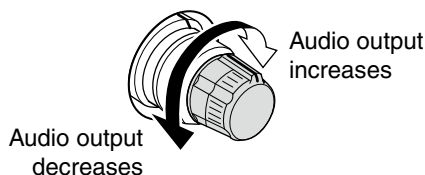

- 25 **RF GAIN CONTROL [RF]**
(outer control; for MAIN band; p. 3-9)
- 26 **RF GAIN CONTROL [RF]**
(outer control; for SUB band; p. 3-9)
Adjusts the RF gain level.
 - ⚡ While rotating the RF gain control, you may hear noise. This comes from the DSP unit and does not indicate a malfunction.

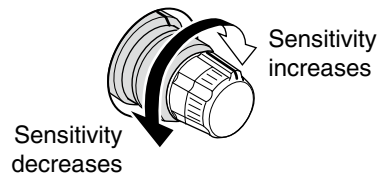

- 27 **SQUELCH CONTROL [SQL]**
(outer control; for MAIN band; p. 3-9)
- 28 **SQUELCH CONTROL [SQL]**
(outer control; for SUB band; p. 3-9)
Adjusts the squelch threshold level. The squelch removes noise output from the speaker (closed condition) when no signal is received.
 - The squelch is particularly effective for FM. It is also available for other modes.
 - 11 to 12 o'clock position is recommended for any setting of the [SQL] control.

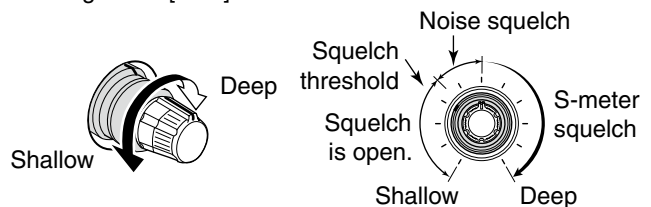

29 MULTI-FUNCTION SWITCHES

Push to select the functions indicated in the LCD display to the right of these switches.

- Functions vary depending on the operating condition.



- ➔ Selects the antenna connector from ANT1, ANT2, ANT3 or ANT4 when pushed. (p. 10-2)
- ➔ Displays antenna selection memory when held down for 1 second.
 - When the receive antenna is activated, the antenna which is connected to [ANT4] is used for receive only.

When a transverter is in use, this [ANT] does not function and 'TRV' appears.



- ➔ Selects RF power (Po), SWR, ALC, COMP, Vd or Id metering during transmit. (p. 3-10)
- ➔ Switches the multi-function digital meter ON or OFF when held down for 1 second. (p. 3-10)



- ➔ Selects one of 2 receive RF preamps or bypasses them. (p. 5-10)
 - "P. AMP1" activates 10 dB preamp.
 - "P. AMP2" activates 16 dB high-gain preamp.

✓ What is the preamp?

The preamp amplifies received signals in the front end circuit to improve S/N ratio and sensitivity. Select "P. AMP1" or "P. AMP2" when receiving weak signals.



- ➔ Selects 6 dB, 12 dB or 18 dB attenuator when pushed. (p. 5-10)
- ➔ Selects 3 dB, 6 dB, 9 dB, 12 dB, 18 dB, or 21 dB attenuator when held down for 1 second. (p. 5-10)

✓ What is the attenuator?

The attenuator prevents a desired signal from distorting when very strong signals are near the desired frequency, or when very strong electric fields, such as from a broadcasting station, are near your location.



- ➔ Activates and selects fast, middle or slow AGC time constant when pushed. (p. 5-12)
 - In FM mode, only "FAST" is available.
- ➔ Enters the AGC set mode when held down for 1 second. (p. 5-12)

AGC time constant can be set between 0.1 to 8.0 second (depends on mode), or turned OFF. When AGC is "OFF," the S-meter does not function.

✓ What is the AGC?

The AGC controls receiver gain to produce a constant audio output level, even when the received signal strength varies dramatically. Select "FAST" for tuning and then select "MID" or "SLOW" depending on the receiving condition.



- ➔ Turns the speech compressor ON or OFF in SSB mode. (p. 6-5)
- ➔ Switches the narrow, middle or wide compression when held down for 1 second.

✓ What is the speech compressor?

The speech compressor compresses the transmitter audio input to increase the average audio output level, to increase talk power. This function is effective for long-distance communication or when propagation conditions are poor.



- ➔ Turns the 1/4-speed tuning function ON or OFF in SSB data, CW, RTTY and PSK modes. (p. 3-6)
 - 1/4 function sets dial rotation to 1/4 of normal speed for fine tuning.

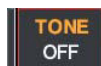

- ➔ Switches between the tone encoder, tone squelch function and no-tone operation when pushed in FM mode. (pp. 4-32, 4-33)
- ➔ Enters the tone set mode when held down for 1 second in FM mode. (pp. 4-32, 4-33)



- ➔ Switches the voice squelch control function ON or OFF; useful for scanning. (p. 9-3)

30 TRANSMIT INDICATOR [TX] (for MAIN band)

31 TRANSMIT INDICATOR [TX] (for SUB band)

- Lights red while transmitting.
 - SUB band's [TX] indicator lights only when in split operation.

32 ANTI VOX CONTROL [ANTI VOX] (p. 6-2)

Adjusts the VOX deactivate level to prevent unwanted VOX activation from the speaker audio.



33 LCD CONTRAST CONTROL [CONTRAST]

Adjusts the LCD contrast.

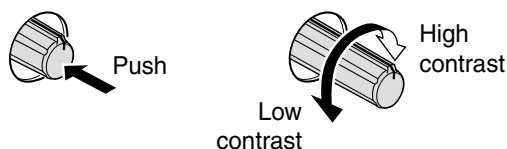

34 LCD BRIGHTNESS CONTROL [BRIGHT]

Adjusts the LCD brightness.



■ Front panel (continued)

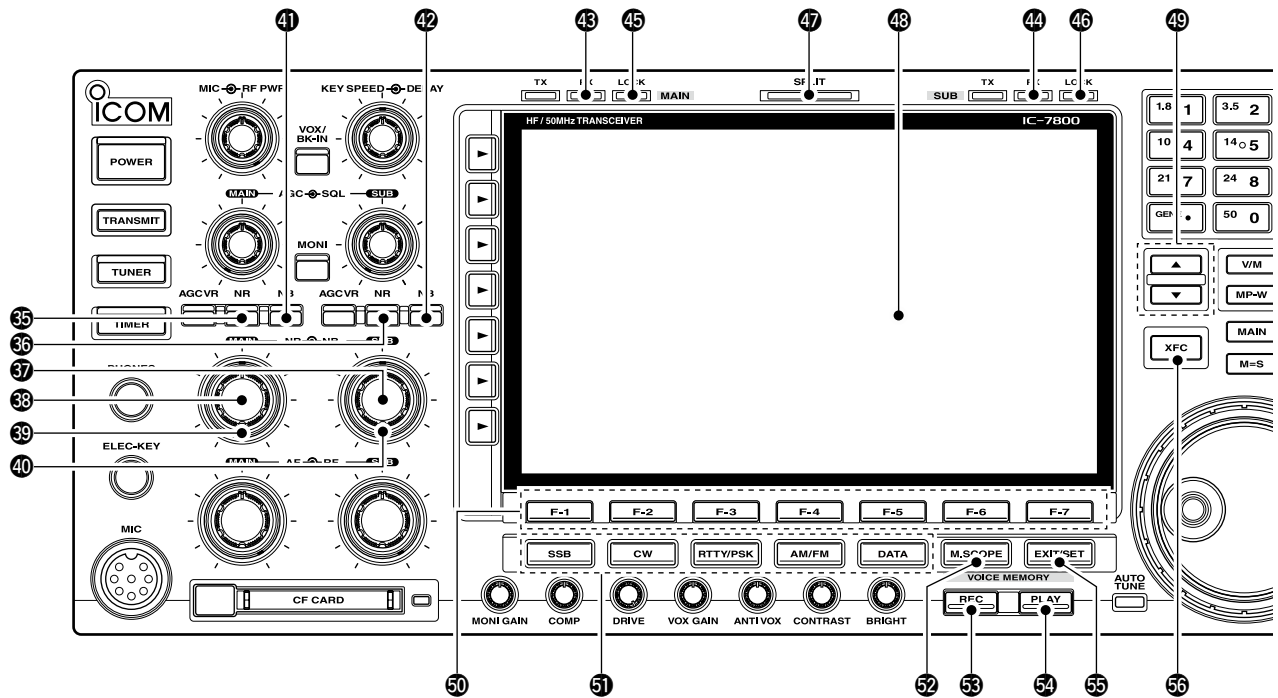

- 35 NOISE REDUCTION SWITCH [NR] (for MAIN band; p. 5-19)
- 36 NOISE REDUCTION SWITCH [NR] (for SUB band; p. 5-19)
Push to switch the DSP noise reduction ON or OFF.
 - The [NR] indicator above this switch lights green when the function is activated.

- 37 NOISE REDUCTION LEVEL CONTROL [NR] (inner control; for SUB band; p. 5-19)
- 38 NOISE REDUCTION LEVEL CONTROL [NR] (inner control; for MAIN band; p. 5-19)
Adjusts the DSP noise reduction level when the noise reduction is in use. Set for maximum readability.
 - To use this control, push the appropriate band's [NR].

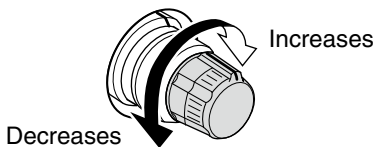

- 39 NOISE BLANKER CONTROL [NB] (outer control; for MAIN band; p. 5-18)
- 40 NOISE BLANKER CONTROL [NB] (outer control; for SUB band; p. 5-17)
Adjust the noise blanker threshold level.
 - To use this control, push appropriate band's [NB] switch.

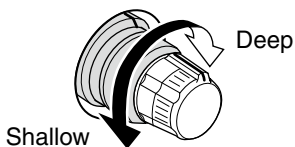

- 41 NOISE BLANKER SWITCH [NB] (for MAIN band; p. 5-18)
- 42 NOISE BLANKER SWITCH [NB] (for SUB band; p. 5-18)
Switches the noise blanker ON or OFF when pushed. The noise blanker reduces pulse-type noise such as that generated by automobile ignition systems. This function cannot be used for FM, or non-pulse-type noise.
 - The [NB] indicator above this switch lights green while the function is activated.
 - ➔ Enters blank-width set mode when held down for 1 second.

- 43 RECEIVE INDICATOR [RX] (for MAIN band)
- 44 RECEIVE INDICATOR [RX] (for SUB band)
Lights green while receiving a signal and when the squelch is open.
- 45 LOCK INDICATOR [LOCK] (for MAIN band; p. 5-19)
- 46 LOCK INDICATOR [LOCK] (for SUB band; p. 5-19)
Lights when the dial lock function is activated.

- 47 SPLIT OPERATION INDICATOR [SPLIT]
Lights during split frequency operation.

- 48 LCD FUNCTION DISPLAY (p. 1-15)
Shows the operating frequency, function switch menus, spectrum scope screen, memory channel screen, set mode settings, etc.

- 49 MEMORY UP/DOWN SWITCHES [▲]/[▼]** (p. 8-2)
 Push to select the desired memory channel.
- Memory channels can be selected both in VFO and memory modes.

- 50 LCD FUNCTION SWITCHES [F-1]–[F-7]**
 Push to select the function indicated in the LCD display above these switches.
- Functions vary depending on the operating condition.

- 51 MODE SWITCHES**
 Selects the desired mode. (p. 3-8)
- Announces selected mode via the speech synthesizer. (p. 12-17)

SSB ➔ Selects USB or LSB modes alternately.

CW ➔ Selects CW or CW-R (CW reverse) modes alternately.

RTTY/PSK ➔ Switches between RTTY and PSK mode.
 ➔ Switches RTTY or RTTY-R (RTTY reverse) mode when held down for 1 second in RTTY mode.
 ➔ Switches PSK or PSK-R (PSK reverse) mode when held down for 1 second in PSK mode.

AM/FM ➔ Selects AM or FM modes alternately.

DATA ➔ Selects SSB, AM or FM data mode (USB-D, LSB-D, AM-D, FM-D) when pushed in SSB, AM or FM mode, respectively.
 ➔ Switches D1, D2 or D3 when held down for 1 second.

- 52 MINI SPECTRUM SCOPE SWITCH [M.SCOPE]** (p. 5-4)
 ➔ Push to turn ON or OFF the mini spectrum scope screen.
- The mini spectrum scope screen can be displayed with another screen, such as memory or set mode screen, simultaneously.
- ➔ Hold down for 1 second to turn ON the spectrum scope screen.

- 53 VOICE MEMORY RECORD SWITCH [REC]**
- ➔ Push to store the previous received signal for the preset time period. (p. 7-7)
 - The preset time period can be set in the voice set mode. (p. 7-13)
 - ➔ Hold down for 1 second to record a QSO (Communication) audio onto a memory device. (p. 7-2)
 - Hold down this switch for 1 second again to stop recording.
 - The recorded memory device can be changed in the voice set mode. (p. 7-13)

- 54 VOICE MEMORY PLAY BACK SWITCH [PLAY]** (p. 7-8)
 ➔ Push to playback the selected voice memory in the RX memory screen for the preset time period.
- When the RX memory screen is not displayed, the previously recorded audio is played back for the preset time period.
- ➔ Hold down for 1 second to playback all of the selected voice memory in the RX memory screen.
- When the RX memory screen is not displayed, all of the previously recorded audio is played back.

- 55 EXIT/SET SWITCH [EXIT/SET]**
- ➔ Push to exit, or return to the previous screen indication during spectrum scope, memory, scan or set mode screen display.
 - ➔ Displays set mode menu screen when held down for 1 second.

- 56 TRANSMIT FREQUENCY CHECK SWITCH [XFC]** (p. 6-6)
 Monitors the transmit frequency (including Δ TX frequency offset) when held down during split frequency operation.
- While holding down this switch, the transmit frequency can be changed with the main dial, keypad, memo pad or [▲]/[▼] switches.
 - When the split lock function is turned ON, pushing [XFC] cancels the dial lock function. (p. 6-7)

■ Front panel (continued)

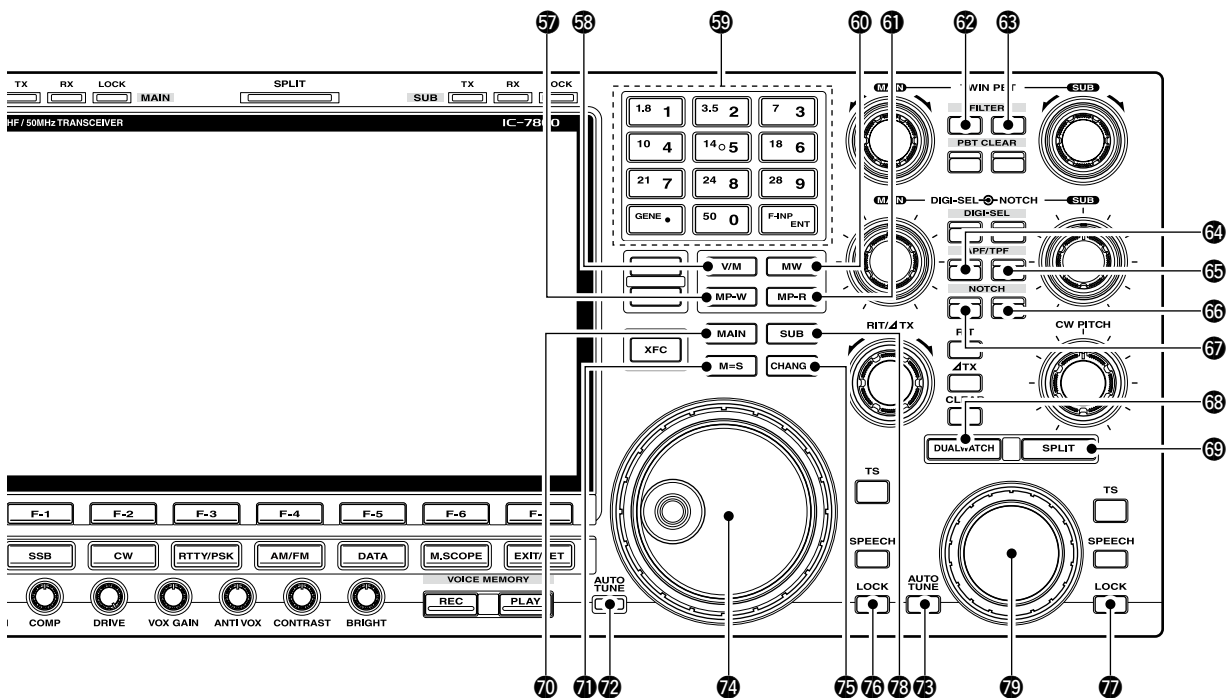

57 MEMO PAD-WRITE SWITCH [MP-W] (p. 8-7)
 Programs the selected readout frequency and operating mode into a memo pad.

- The 5 most recent entries remain in memo pads.
- The memo pad capacity can be expanded from 5 to 10 in set mode. (p. 12-18)

58 VFO/MEMORY SWITCH [V/M]

- Switches the selected readout operating mode between the VFO and memory when pushed. (pp. 3-3, 8-2)
- Transfers the memory contents to VFO when held down for 1 second. (p. 5-5)

59 KEYPAD

- Pushing a key selects the operating band.
 - [GENE•.] selects the general coverage band.
- Pushing the same key 2 or 3 times calls up other stacked frequencies in the band. (p. 3-4)
 - Icom's triple band stacking register memorizes 3 frequencies in each band.
- After pushing [F-INP•ENT], enters a frequency or memory channel. Pushing [F-INP•ENT] or [▲/▼] is necessary to end. (pp. 3-5, 8-2)
 - e.g. to enter 14.195 MHz, push [F-INP] [1.8•1] [10•4] [GENE•] [1.8•1] [28•9] [14•5] [F-INP•ENT].

60 MEMORY WRITE SWITCH [MW] (p. 8-4)
 Stores the selected readout frequency and operating mode into the displayed memory channel when held down for 1 second.

- This function is available both in VFO and memory modes.

61 MEMO PAD-READ SWITCH [MP-R] (p. 8-7)
 Each push calls up a frequency and operating mode in a memo pad. The 5 (or 10) most recently programmed frequencies and operating modes can be recalled, starting from the most recent.

- The memo pad capacity can be expanded from 5 to 10 in set mode. (p. 12-18)

62 FILTER SWITCH [FILTER] (for MAIN band; p. 5-14)
63 FILTER SWITCH [FILTER] (for SUB band; p. 5-14)

- Selects one of 3 IF filter settings.
- Enters the filter set screen when held down for 1 second.

64 AUDIO PEAK FILTER/TWIN PEAK FILTER SWITCH [APF/TPF] (for MAIN band)
65 AUDIO PEAK FILTER/TWIN PEAK FILTER SWITCH [APF/TPF] (for SUB band)

- Push to turn the audio peak filter ON or OFF during CW mode operation. (p. 4-6)
- Push to turn the twin peak filter ON or OFF during RTTY mode operation. (p. 4-14)
 - “**APF**” appears when audio peak filter is in use.
 - “**TPF**” appears when twin peak filter is in use.
- During CW mode operation, hold down for 1 second to select the APF passband width from 80, 160 and 320 Hz. (p. 4-6)

- 66 NOTCH SWITCH [NOTCH]** (for SUB band; p. 5-20)
- 67 NOTCH SWITCH [NOTCH]** (for MAIN band; p. 5-20)
- ➔ Switches the notch function between auto, manual or OFF in SSB and AM modes.
 - ➔ Turns the manual notch function ON or OFF when pushed in CW, RTTY and PSK31 mode.
 - ➔ Turns the auto notch function ON or OFF when pushed in FM mode.
 - “**AN**” appears when auto notch is in use.
 - “**MN**” appears when manual notch is in use.
 - ➔ Switches the manual notch characteristics from wide, middle or narrow when held down for 1 second.

✓ **What is the notch function?**

The notch function eliminates unwanted CW or AM carrier tones while preserving the desired voice signal. The DSP circuit automatically adjusts the filtering frequency to effectively eliminate unwanted tones.

- 68 DUALWATCH SWITCH [DUALWATCH]** (p. 5-17)
- ➔ Turns the dualwatch function ON or OFF when pushed.
 - ➔ Turns the dualwatch function ON, and equalizes the main/sub readout frequency to the sub/main readout when held down for 1 second. (Quick dualwatch function)
 - The quick dualwatch function can be turned OFF using set mode. (p. 12-15)
- 69 SPLIT SWITCH [SPLIT]** (p. 6-6)
- ➔ Push to turn ON or OFF the split function.
 - ➔ Hold down for 1 second to turn the split function ON and equalizes the sub readout frequency to the main readout in non-FM modes, and then sets the sub readout for frequency input mode. (Quick split function)
 - In the FM mode, the sub readout frequency is shifted the preset frequency offset from the main readout frequency. (pp. 12-15, 12-16)
 - The quick split function can be turned OFF using set mode. (p. 12-15)
 - ➔ After inputting a frequency offset, push to turn the split function ON, and the sub readout frequency is shifted the amount of frequency from the main readout frequency.
- 70 MAIN BAND ACCESS SWITCH [MAIN]**
- Selects the main readout.
- The main readout frequency is clearly displayed. The sub readout functions only during split operation or dualwatch.
- 71 MAIN/SUB EQUALIZING SWITCH [M=S]**
- Hold down for 1 second to equalize the sub readout frequency to the main readout frequency.

- 72 AUTOMATIC TUNING SWITCH [AUTO TUNE]** (for MAIN band)
- 73 AUTOMATIC TUNING SWITCH [AUTO TUNE]** (for SUB band)
- Turns the automatic tuning function ON or OFF in CW and AM modes.

IMPORTANT!

When receiving a weak signal, or receiving a signal with interference, the automatic tuning function may tune the receiver to an undesired signal.

- 74 MAIN DIAL**
- Changes the displayed frequency (main band), selects set mode setting, etc.
- 75 MAIN/SUB CHANGE SWITCH [CHANGE]**
- Switches the frequency and selected memory channel between main and sub readouts when pushed.
- Switches between transmit frequency and receive frequency when the split frequency function is ON. (p. 6-6)
- 76 LOCK SWITCH [LOCK]** (for MAIN band; p. 5-19)
- 77 LOCK SWITCH [LOCK]** (for SUB band; p. 5-19)
- Push to switch the dial lock function ON or OFF.
- 78 SUB BAND ACCESS SWITCH [SUB]**
- Selects the sub readout.
- The sub readout frequency is clearly displayed. The main readout functions only during split operation or dualwatch.
- 79 SUB DIAL**
- Changes the displayed frequency in sub band.

■ Front panel (continued)

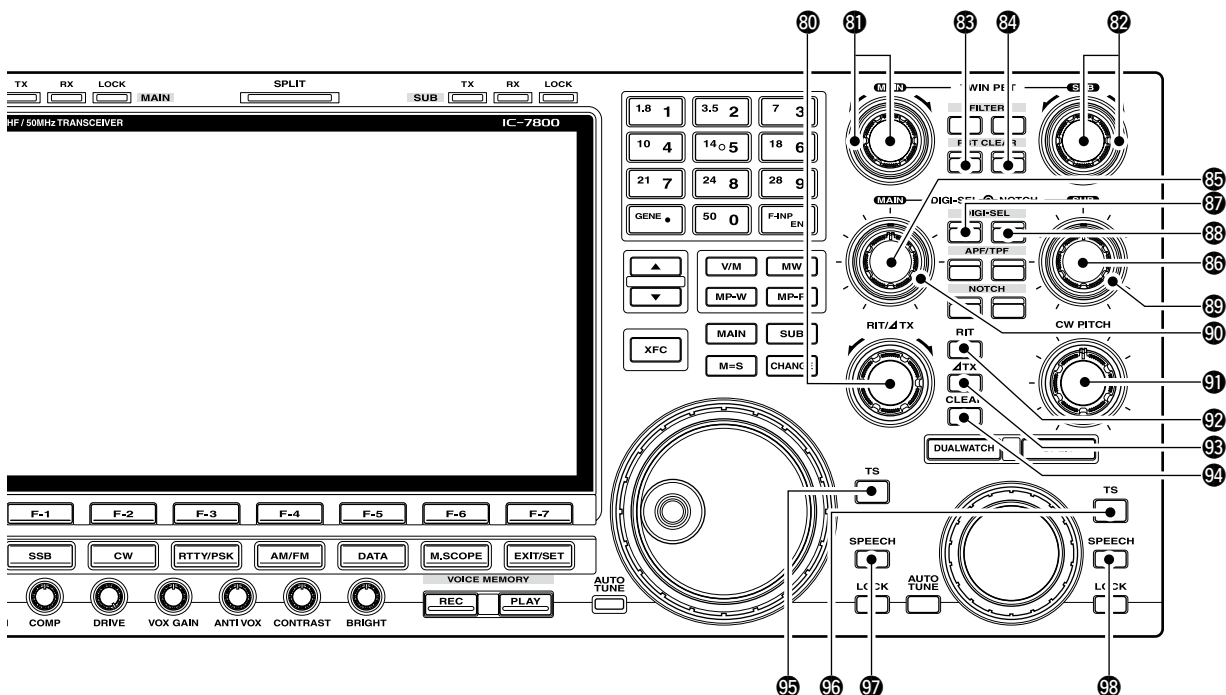

- 80 RIT/ΔTX CONTROL [RIT/ΔTX]** (pp. 5-11, 6-4)
 Shifts the receive and/or transmit frequency without changing the transmit and/or receive frequency.
- Rotate the control clockwise to increase the frequency, or rotate the control counterclockwise to decrease the frequency. The RIT or ΔTX functions must be ON.
 - The shift frequency range is ±9.999 kHz in 1 Hz steps (or ±9.99 kHz in 10 Hz steps).

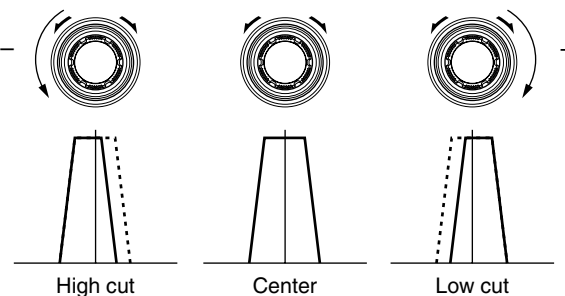
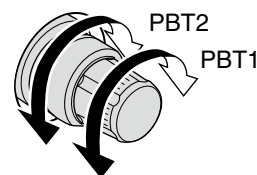
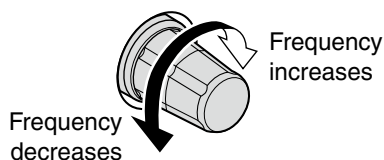

- 81 PASSBAND TUNING CONTROLS [TWIN PBT]**
 (for MAIN band; p. 5-13)
- 82 PASSBAND TUNING CONTROLS [TWIN PBT]**
 (for SUB band; p. 5-13)
 Adjusts the receiver's IF filter "passband width" via the DSP.
- Passband width and shift frequency are displayed in the multi-function display.
 - Hold down [PBT CLEAR] for 1 second to clear the PBT settings.
 - The adjustment range is half of the passband width, and the value is adjustable in 25 Hz steps for the SSB/CW/RTTY/PSK modes, and 100 Hz steps for the AM mode.

- 83 PBT CLEAR SWITCH [PBT CLEAR]**
 (for MAIN band; p. 5-13)
- 84 PBT CLEAR SWITCH [PBT CLEAR]**
 (for SUB band; p. 5-13)
 Clears the PBT settings when held down for 1 second.
- The [PBT CLEAR] indicator above this switch lights when PBT is in use.

✓ **What is the PBT control?**

The PBT function electronically modifies the IF passband width to reject interference. This transceiver uses the DSP circuit for the PBT function.

85 DIGITAL RF SELECTOR CONTROL [DIGI-SEL]
(for MAIN band; p. 5-20)

86 DIGITAL RF SELECTOR CONTROL [DIGI-SEL]
(for SUB band; p. 5-20)

Adjusts the digital RF selector center frequency.

- The control can be reassigned as the audio peak filter adjustment (p. 12-19)

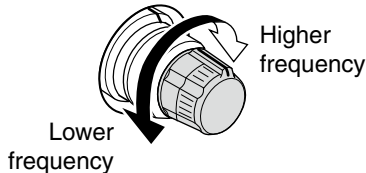

87 DIGITAL RF SELECTOR SWITCH [DIGI-SEL]
(for MAIN band; p. 5-20)

88 DIGITAL RF SELECTOR SWITCH [DIGI-SEL]
(for SUB band; p. 5-20)

Turns the digital RF preselector ON or OFF.

- The [DIGI-SEL] indicator lights green when the preselector is in use.

89 MANUAL NOTCH FILTER CONTROL [NOTCH]
(for SUB band; outer control; p. 5-20)

90 MANUAL NOTCH FILTER CONTROL [NOTCH]
(for MAIN band; outer control; p. 5-20)

Varies the “valley” frequency of the manual notch filter to reject an interfering signal while the manual notch function is ON.

- Notch filter center frequency:
SSB : -1060 Hz to 4040 Hz
CW : CW pitch freq. + 2540 Hz to CW pitch freq. -2540 Hz
AM : -5100 Hz to 5100 Hz

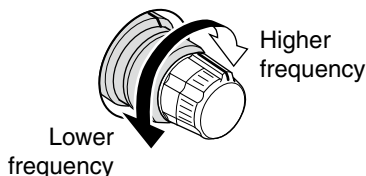

91 CW PITCH CONTROL [CW PITCH] (p. 4-5)

Shifts the received CW audio pitch and the CW side tone pitch without changing the operating frequency.

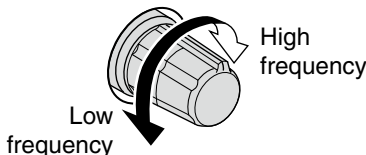

92 RIT SWITCH [RIT] (p. 5-11)

- ➔ Turns the RIT function ON or OFF when pushed.
 - Use [RIT/ Δ TX] control to vary the RIT frequency.
- ➔ Adds the RIT shift frequency to the operating frequency when held down for 1 second.

✓ What is the RIT function?

Receiver incremental tuning (RIT) shifts the receive frequency without shifting the transmit frequency.

This is useful for fine tuning stations calling you on off-frequency or when you prefer to listen to slightly different-sounding voice characteristics, etc.

93 Δ TX SWITCH [Δ TX] (p. 6-4)

- ➔ Turns the Δ TX function ON or OFF when pushed.
 - Use [RIT/ Δ TX] control to vary the Δ TX frequency.
- ➔ Adds the Δ TX shift frequency to the operating frequency when held down for 1 second.

✓ What is the Δ TX function?

Δ TX shifts the transmit frequency without shifting the receive frequency. This is useful for simple split frequency operation in CW, etc.

94 CLEAR SWITCH [CLEAR] (pp. 5-11, 6-4)

Clears the RIT/ Δ TX shift frequency when held down for 1 second or when pushed momentarily, depending on the quick RIT/ Δ TX clear function setting (p. 12-18).

95 QUICK TUNING SWITCH [TS] (for MAIN band)

96 QUICK TUNING SWITCH [TS] (for SUB band)

- ➔ Turns the quick tuning step ON or OFF. (p. 3-6)
 - While the quick tuning indicator, “▼,” is displayed above the frequency indication, the frequency can be changed in programmed kHz steps.
 - 0.1, 1, 5, 9, 10, 12.5, 20 and 25 kHz steps are available for each operating mode independently.
- ➔ When the quick tuning step is OFF, held down for 1 second to turn the 1 Hz tuning step ON or OFF. (p. 3-7)
- ➔ When the quick tuning step is ON, hold down for 1 second to enter quick tuning step set mode. (p. 3-6)

97 SPEECH SWITCH [SPEECH]
(for MAIN band; p. 13-3)

98 SPEECH SWITCH [SPEECH]
(for SUB band; p. 13-3)

- ➔ Push to announce the S-meter indication and the selected readout frequency.
- ➔ The selected operating mode is additionally announced when held down for 1 second.

■ Rear panel

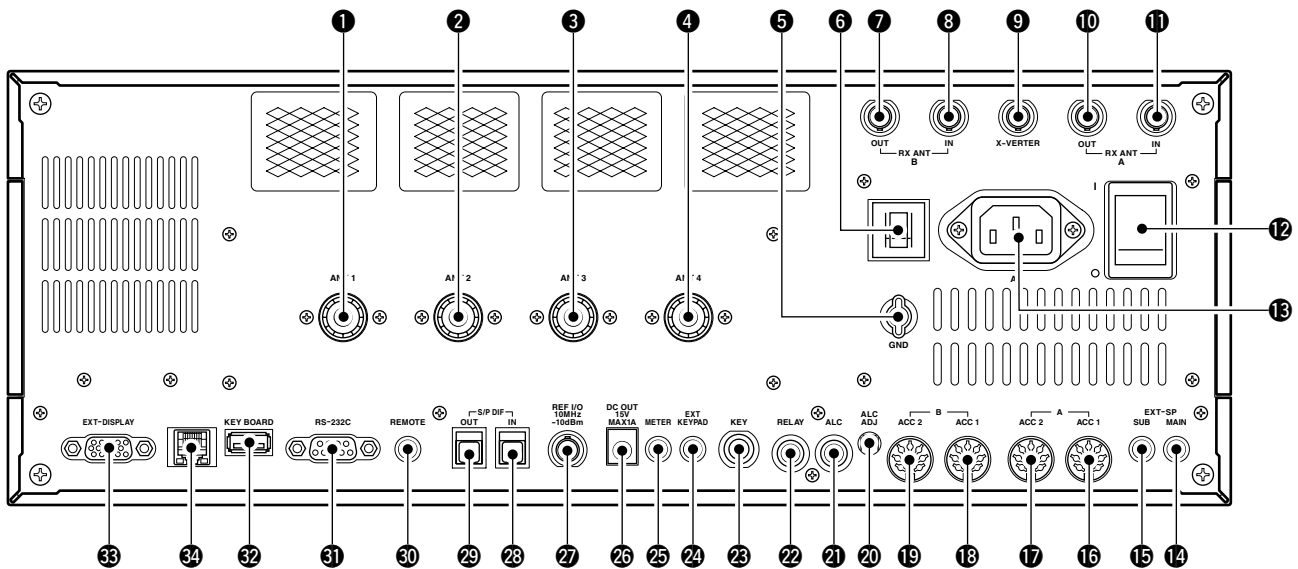

- 1 ANTENNA CONNECTOR 1 [ANT 1]** (p. 2-4)
- 2 ANTENNA CONNECTOR 2 [ANT 2]** (p. 2-4)
- 3 ANTENNA CONNECTOR 3 [ANT 3]** (p. 2-4)
- 4 ANTENNA CONNECTOR 4 [ANT 4]** (p. 2-4)
Accept a 50 Ω antenna with a PL-259 plug connector.

- 5 GROUND TERMINAL [GND]** (p. 2-3)
Connect this terminal to a ground to prevent electrical shocks, TVI, BCI and other problems.

- 6 CIRCUIT BREAKER**
Cuts off the AC input when over-current occurs.

- 7 RECEIVE ANTENNA B OUT [RX ANT B- OUT]**
- 8 RECEIVE ANTENNA B IN [RX ANT B- IN]**
Located between the transmit/receive switching circuit and receiver's RF stage in SUB band (MAIN band during split operation).

Connects an external unit, such as preamplifier or RF filter, using BNC connectors, if desired.

When no external unit is connected, [RX ANT B- OUT] and [RX ANT B- IN] must be shorted with the supplied coaxial cable. (p. 2-2)

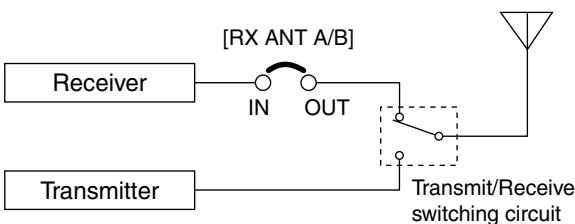

- 9 TRANSVERTER CONNECTOR [X-VERTER]** (p. 2-5)
External transverter input/output connector. Activated by voltage applied to [ACC 2] pin 6, or when the transverter function is in use. (pp. 1-14, 4-6)

- 10 RECEIVE ANTENNA A OUT [RX ANT A- OUT]**
- 11 RECEIVE ANTENNA A IN [RX ANT A- IN]**
Located between the transmit/receive switching circuit and receiver's RF stage in MAIN band (SUB band during split operation).

Connects an external unit, such as preamplifier or RF filter, using BNC connectors, if desired.

When no external unit is connected, [RX ANT A- OUT] and [RX ANT A- IN] must be shorted with the supplied coaxial cable. (p. 2-2)

- 12 MAIN POWER SWITCH [I/O]** (p. 3-2)
Turns the internal power supply ON or OFF.

- 13 AC POWER SOCKET [AC]** (p. 2-4)
Connects the supplied AC power cable to an AC line-voltage receptacle.

- 14 EXTERNAL SPEAKER JACK MAIN [EXT-SP MAIN]** (p. 2-5)
- 15 EXTERNAL SPEAKER JACK SUB [EXT-SP SUB]** (p. 2-5)
Connects an external speaker (4–8 Ω), if desired.

16 ACCESSORY SOCKET 1 A [ACC 1-A]

17 ACCESSORY SOCKET 2 A [ACC 2-A]

18 ACCESSORY SOCKET 1 B [ACC 1-B]

19 ACCESSORY SOCKET 2 B [ACC 2-B]

Enable connection of external equipment such as a linear amplifier, an automatic antenna selector/tuner, a TNC for data communications, etc.

- See page 1-14 for socket information.

20 ALC LEVEL ADJUSTMENT POT [ALC ADJ]

Adjusts the ALC levels.

No adjustment is required when the ALC output level of the connected non-Icom linear amplifier is 0 to -4 V DC.

21 ALC INPUT JACK [ALC] (p. 2-7)

Connects to the ALC output jack of a non-Icom linear amplifier.

22 T/R CONTROL JACK [RELAY] (p. 2-7)

Goes to ground when transmitting to control an external unit, such as a non-Icom linear amplifier.

NOTE: T/R control voltage and current must be lower than 16 V DC/0.5 A with Reed switching, or 250 V AC/200 mA with MOS-FET switching.

23 STRAIGHT KEY JACK [KEY] (p. 2-4)

Accepts a straight key or external electronic keyer with 1/4 inch standard plug.

- [ELEC-KEY] on the front panel can be used for a straight key or external electronic keyer. Deactivate the internal electronic keyer in keyer set mode. (p. 4-12)

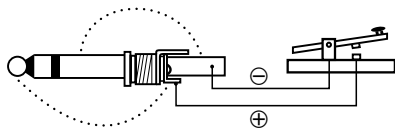

24 EXTERNAL KEYPAD JACK [EXT KEYPAD]

(p. 2-6)

Connects an external keypad for direct voice memory (p. 7-11), memory keyer (p. 4-8), RTTY memory (p. 4-16) or PSK memory (p. 4-24) transmission.

Transceiver mute control line (both transmit and receive) is also supported.

25 METER JACK [METER] (p. 2-6)

Outputs the receiving signal strength level signal, transmit output power, VSWR, ALC, speech compression, Vd or Id level for external meter indication.

26 DC OUTPUT JACK [DC OUT] (p. 2-6)

Outputs a regulated 14 V DC (approximately) for external equipment. Connected in parallel with 13.8 V outputs of [ACC 1] and [ACC 2]. (max. 1 A in total)



27 REFERENCE SIGNAL INPUT/OUTPUT TERMINAL [REF I/O]

Inputs/outputs a 10 MHz reference signal.

28 S/P DIF INPUT TERMINAL [S/P DIF- IN] (p. 2-6)

29 S/P DIF OUTPUT TERMINAL [S/P DIF- OUT]

(p. 2-6)

Connects external equipment that supports S/P DIF input/output.

30 CI-V REMOTE CONTROL JACK [REMOTE]

(p. 2-5)

➤ Connects a PC via the optional CT-17 CI-V LEVEL CONVERTER for external control of the transceiver.

➤ Used for transceive operation with another Icom CI-V transceiver or receiver.

31 RS-232C TERMINAL [RS-232C] (p. 2-5)

Connects an RS-232C cable, D-sub 9-pin to connect the IC-7800 to a PC.

Can be used for remotely control the IC-7800 without the optional CT-17, or for RTTY/PSK31 decoded signal output. The [RS-232C] interface is wired as a modem (DCE).

32 KEYBOARD CONNECTOR [KEYBOARD]

(p. 2-6)

Connects a USB (Universal Serial Bus) device that is a keyboard, mouse, hub or memory (USB flash drive).

33 EXTERNAL DISPLAY TERMINAL [EXT-DISPLAY]

(p. 2-6)

Connects to an external display monitor.

- At least 800×600 pixel display is necessary.

34 ETHERNET CONNECTOR [LAN] (p. 16-6)

Connects to a PC network through a LAN (Local Area Network).

About the [KEYBOARD] connector:

- Supported only USB flash drive, keyboard, mouse or hub.
- **KEEP** the transceiver power OFF when connecting or disconnecting a USB keyboard, mouse or hub.
- **DO NOT** connect the following devices:
 - Two or more the same kind of USB devices. (Example: Two USB hubs or two USB mice)
 - Multimedia adapter
 - USB HDD
 - Larger than 32 GB USB flash drives
 - Bluetooth® keyboard or mouse.

1 PANEL DESCRIPTION

■ Accessory connector information

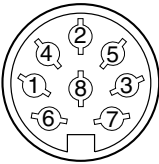
ACC 1	PIN No.	NAME	DESCRIPTION	SPECIFICATIONS	
	1	RTTY	Controls RTTY keying	"High level" : More than 2.4 V "High level" : Less than 0.6 V Output current : Less than 2 mA	
	2	GND	Connects to ground. Connected in parallel with ACC 2 pin 2.	—	
	3	SEND*	Input/output pin. Connected in parallel with ACC 2 pin 3.	An external equipment controls the transceiver. When this pin goes low, the transceiver transmits. The transceiver outputs a low signal to control external equipment.	Input voltage (High) : 2.0 V to 20.0 V Input voltage (Low) : -0.5 V to 0.8 V Current flow : Max. 20 mA Output voltage (Low) : Less than 0.1 V Current flow : Max. 200 mA
	4	MOD	Modulator input. Connects to a modulator.	Input impedance : 10 kΩ Output level : Approximately 100 mV rms	
	5	AF	AF detector output. Fixed level, regardless of [AF] position in default settings. (see notes below)	Output impedance : 4.7 kΩ Output level : 100–300 mV rms	
	6	SQLS	Squelch output. Grounded when squelch opens.	SQL open : Less than 0.3 V/5 mA SQL closed : More than 6.0 V/100 μA	
	7	13.8 V	13.8 V output when power is ON. Connected in parallel with ACC 2 pin 7.	Output current : Max. 1 A	
	8	ALC	ALC voltage input. Connected in parallel with ACC 2 pin 5.	Control voltage : -4 V to 0 V Input impedance : More than 10 kΩ	

/// **NOTE:** If the CW side tone level limit or beep level limit is in use, the CW side tone or beep tone decreases from the fixed level when the [AF] control is rotated above a specified level. (pp. 12-5, 12-6)

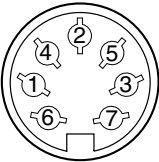
ACC 2	PIN No.	NAME	DESCRIPTION	SPECIFICATIONS
	1	8 V	Regulated 8 V output.	Output voltage : 8 V ±0.3 V Output current : Less than 10 mA
	2	GND	Same as ACC 1 pin 2.	
	3	SEND*	Same as ACC 1 pin 3.	
	4	BAND	Band voltage output. (Varies with amateur band)	Output voltage : 0 V to 8.0 V
	5	ALC	Same as ACC 1 pin 8.	
	6	TRV	Activates [X-VERTER] input/output when "HIGH" voltage is applied	Input impedance : More than 10 kΩ Input voltage : 2 V to 13.8 V
	7	13.8 V	Same as ACC 1 pin 7.	

*When the SEND terminal controls the inductive load (such as a relay), a counter-electromotive force can cause the transceiver's malfunction or damage. To prevent this, we recommend adding a switching diode, such as an "1SS133," on the load side of the circuit to the counter-electromotive force absorption. When the diode is added, a switching delay of the relay may occur. Be sure to check its switching action before operation.

[Example]

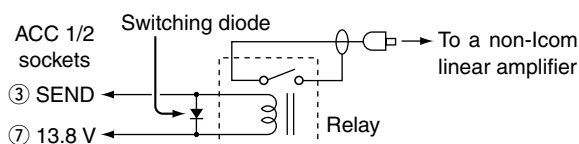

■ LCD display

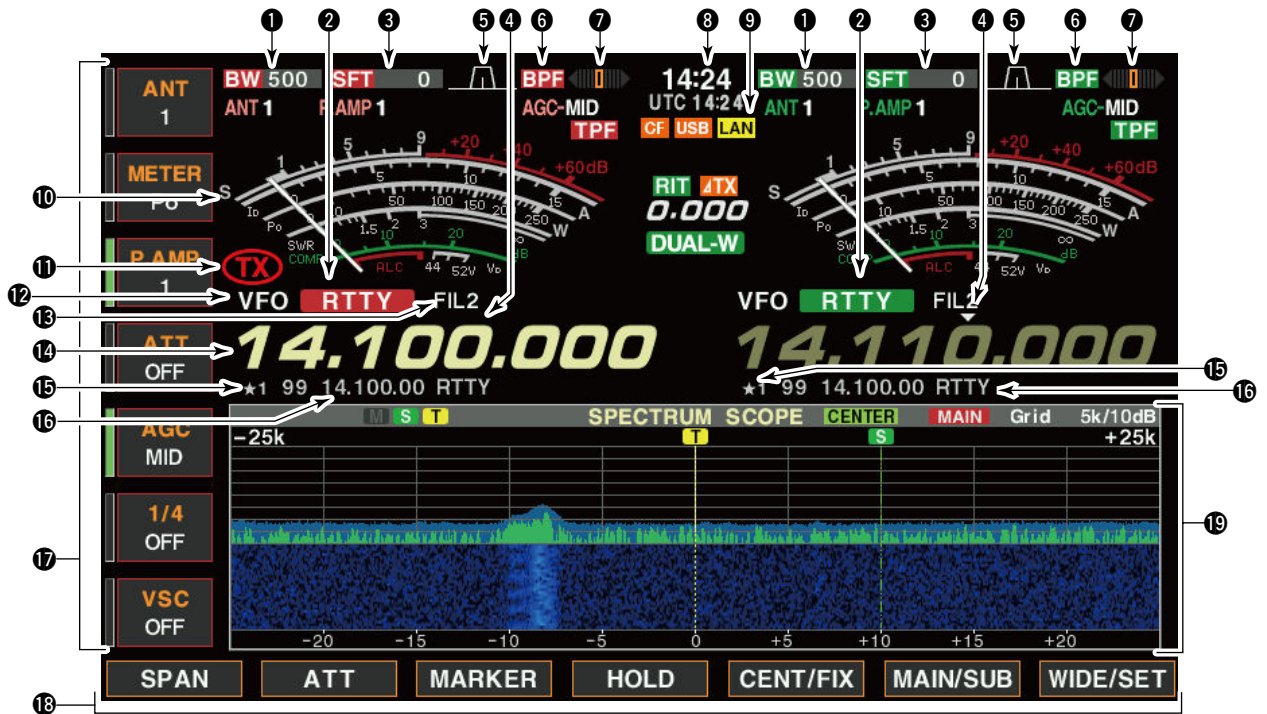

- 1 BAND WIDTH INDICATOR** (p. 5-13)
Shows the passband width of the IF filter.
- 2 MODE INDICATOR**
Shows the selected mode.
- 3 SHIFT FREQUENCY INDICATOR** (p. 5-13)
Shows the shift frequency of the IF filter.
- 4 QUICK TUNING INDICATOR** (p. 3-6)
Appears when the quick tuning step function is in use.
- 5 PASSBAND WIDTH INDICATOR** (p. 5-13)
Graphically displays the passband width for twin PBT operation and center frequency for IF shift operation.
- 6 BANDPASS FILTER INDICATOR**
Appears when the narrow filter (500 Hz or less) is selected during CW, RTTY or PSK31 operation.
- 7 RTTY TUNING INDICATOR**
Shows the tuning level in RTTY mode.
- 8 CLOCK READOUT**
Shows the current time.
- 9 LAN INDICATOR**
Appears when the Remote station access the transceiver through the LAN. (An optional RS-BA1 is required.)
- 10 S/R/METER** (p. 3-10)
Shows the signal strength while receiving. Shows the relative output power, SWR, ALC or compression levels while transmitting.
- 11 TX INDICATOR**
Indicates the frequency readout for transmit.
- 12 VFO/MEMORY CHANNEL INDICATOR** (p. 3-3)
Indicates the VFO mode or selected memory channel number.
- 13 IF FILTER INDICATOR**
Shows the selected IF filter number.
- 14 FREQUENCY READOUTS**
Shows the operating frequency.
• Gray characters are used for non-active readout.
- 15 SELECT MEMORY CHANNEL INDICATOR** (p. 9-7)
Indicates the displayed memory channel is set as a select memory channel.
The desired memory channels can be assigned to 3 select groups, for fast, convenient scanning.
- 16 MEMORY CHANNEL READOUTS**
➔ Shows the selected memory channel contents in VFO mode.
➔ Shows the VFO contents in memory mode.
- 17 MULTI-FUNCTION SWITCH GUIDE**
Indicates the function of the multi-function switches.
- 18 LCD FUNCTION SWITCH GUIDE**
Indicates the function of the LCD function switches ([F-1] – [F-7]).
- 19 MULTI-FUNCTION SCREEN**
Shows the screens for the multi-function digital meter, spectrum scope, audio scope, voice recorder, memory channel, scan, memory keyer, RTTY decoder, PSK decoder, IF filter selection or set modes, etc.

1 PANEL DESCRIPTION

■ Screen menu arrangement

The following screens can be selected from the start up screen. Choose the desired screen using the following chart.

Pushing [EXIT/SET] several times returns to the start up screen. See page 12-3 for set mode arrangement.

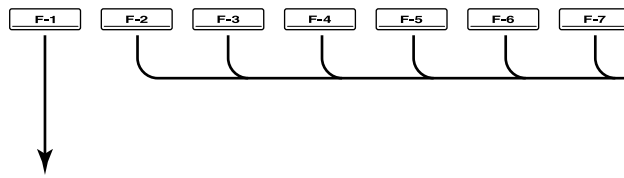
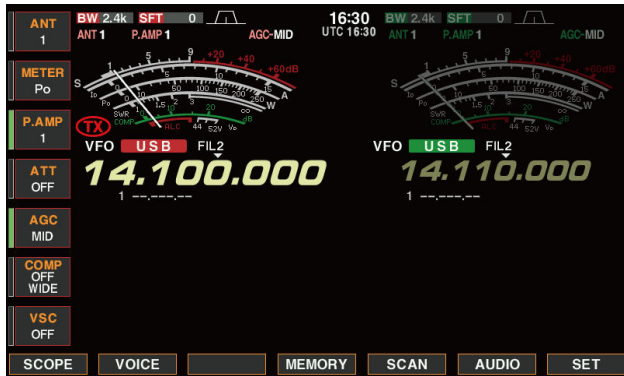

• Spectrum scope screen (p. 5-2)

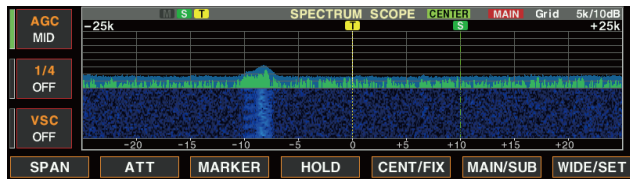

• Voice recorder screen (p. 7-2)



• Memory keyer screen (CW mode; p. 4-8)



• RTTY decoder screen (p. 4-13)

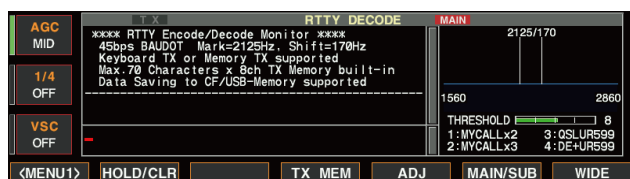

• PSK31 decoder screen (p. 4-21)



• Memory channel screen (p. 8-3)

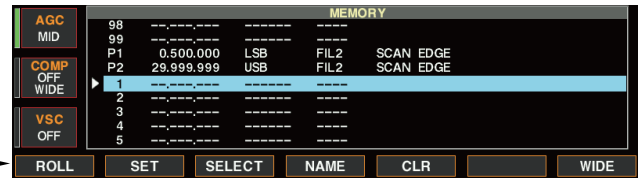

• Scan screen (VFO mode; p. 9-4)

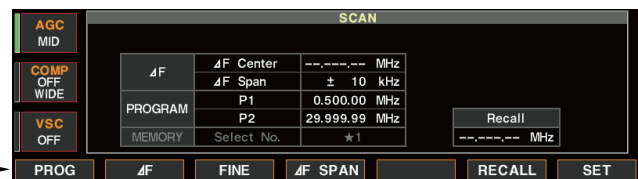

• Scan screen (Memory mode; p. 9-6)

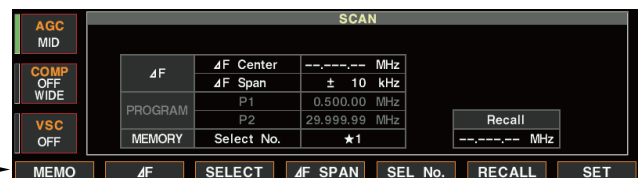

• Audio scope screen (p. 5-21)

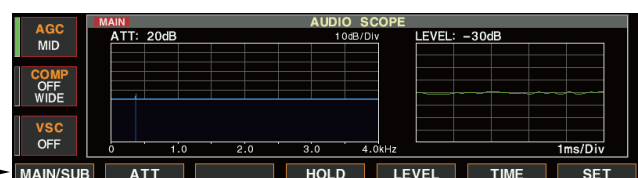

• Set mode menu screen (p. 12-2)

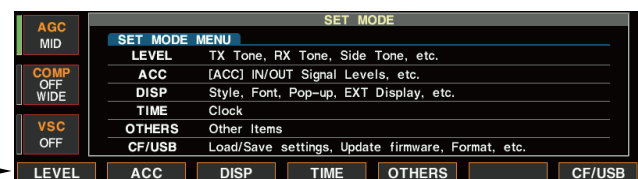

■ Unpacking	2-2
■ Antenna jumper cable connection	2-2
■ Selecting a location	2-2
■ Rack mounting handle attachment	2-2
■ Grounding	2-3
■ Antenna connection	2-3
■ CF (Compact Flash) memory card	2-3
■ Required connections	2-4
◇ Front panel	2-4
◇ Rear panel	2-4
■ Advanced connections	2-5
◇ Front panel	2-5
◇ Rear panel—1	2-5
◇ Rear panel—2	2-6
■ Linear amplifier connections	2-7
◇ Connecting the IC-PW1/EURO	2-7
◇ Connecting a non-Icom linear amplifier	2-7
■ Transverter jack information.....	2-8
■ FSK and AFSK connections.....	2-8
◇ When using the ACC socket or the microphone connector	2-8
■ Microphones (options)	2-9
◇ SM-50	2-9
◇ SM-30	2-9
◇ HM-36	2-10
■ Microphone connector information	2-10

 **CAUTION:** The transceiver weights approximately 25 kg (55 lb). Always have two people available to carry, lift or turn over the transceiver.

■ Unpacking

After unpacking, immediately report any damage to the delivering carrier or dealer. Keep the shipping cartons.

For a description and a diagram of accessory equipment included with the IC-7800, see 'Supplied accessories' on p. iii of this manual.

■ Antenna jumper cable connection

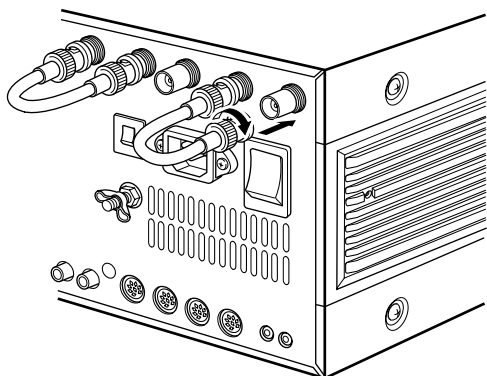

Connect the supplied coaxial cable (terminated with BNC connectors) between [RX ANT A— IN] and [RX ANT A— OUT], and, [RX ANT B— IN] and [RX ANT B— OUT], respectively.

When connecting an external filter unit, pre-amplifier, etc., connect the unit between [RX ANT A/B— IN] and [RX ANT A/B— OUT] connectors.

■ Selecting a location

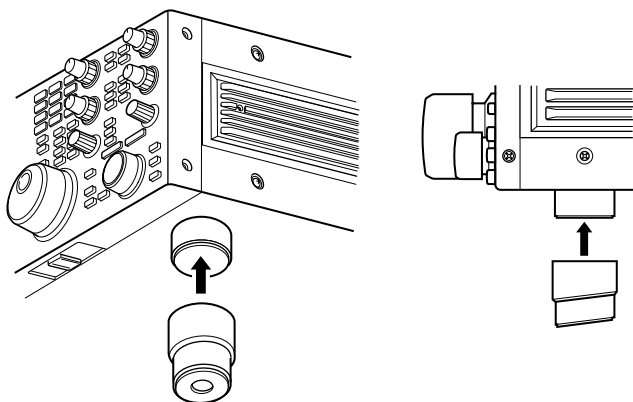

Select a location for the transceiver that allows adequate air circulation, free from extreme heat, cold, or vibrations, and away from TV sets, TV antenna elements, radios and other electromagnetic sources.

The base of the transceiver has an adjustable stand for desktop use. Set the stand to one of two angles depending on your operating preference.

■ Rack mounting handle attachment

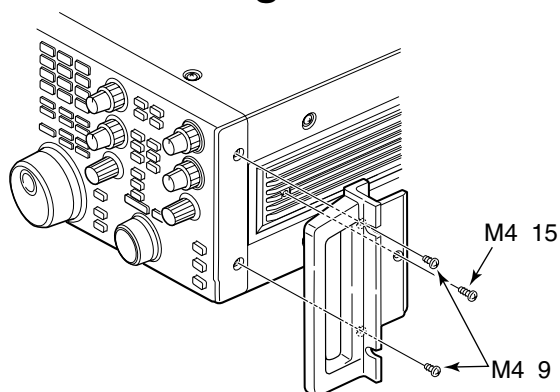

Remove the four screws from both sides of the front panel and the two screws from both sides of the side panel, then attach the rack mounting handles to the sides of the transceiver using the supplied screws.

■ Grounding

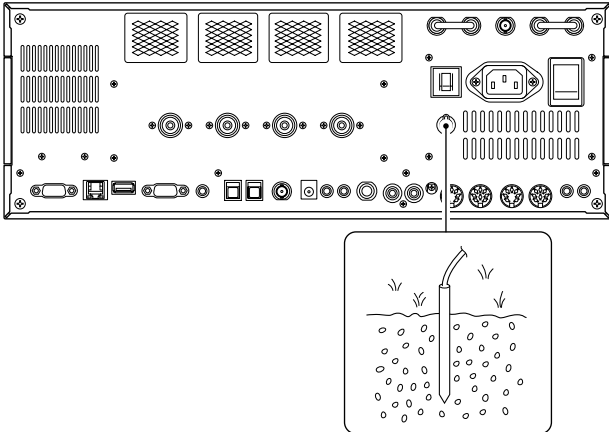

To prevent electrical shock, television interference (TVI), broadcast interference (BCI) and other problems, ground the transceiver through the GROUND terminal on the rear panel.

For best results, connect a heavy gauge wire or strap to a long earth-sunk copper rod. Make the distance between the [GND] terminal and ground as short as possible.

⚠ WARNING! NEVER connect the [GND] terminal to a gas or electric pipe, since the connection could cause an explosion or electric shock.

■ Antenna connection

For radio communications, the antenna is of critical importance, along with output power and receiver sensitivity. Select antenna(s), such as a well-matched 50 Ω antenna, and feedline. We recommend 1.5:1 or better of Voltage Standing Wave Ratio (VSWR) for your desired band. Of course, the transmission line should be a coaxial cable.

When using 1 antenna, use the [ANT1] connector.

⚡ CAUTION: Protect your transceiver from lightning by using a lightning arrester.

Antenna SWR

Each antenna is tuned for a specified frequency range and SWR may be increased out-of-range. When the SWR is higher than approximately 2.0:1, the transceiver's power drops to protect the final transistors. In this case, an antenna tuner is useful to match the transceiver and antenna. Low SWR allows full power for transmitting. The IC-7800 has an SWR meter to monitor the antenna SWR continuously.

■ CF (Compact Flash) memory card

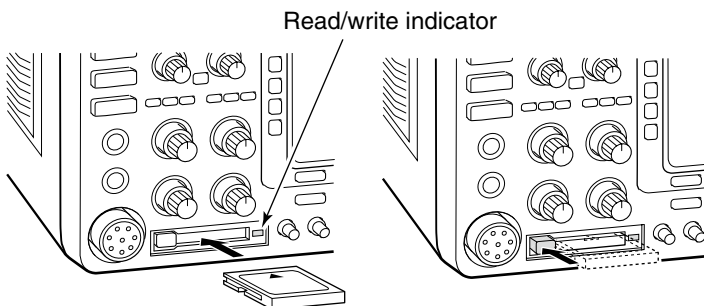

Insert the supplied CF (Compact Flash) memory card into the CF memory card slot.

- To remove the CF memory card, push-in the button, located at left hand side of the slot.

⚡ CAUTION: Make sure to install the memory card correctly. **NEVER** insert or remove the CF memory card when the read/write indicator lights or blinks.

Required connections

Front panel

CW key

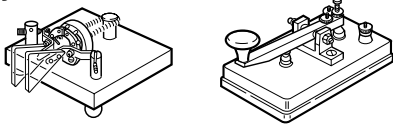

A straight or bug key can be used when the internal electronic keyer is turned OFF in keyer set mode. (p. 4-12)

Microphones (pp. 2-9, 2-10)

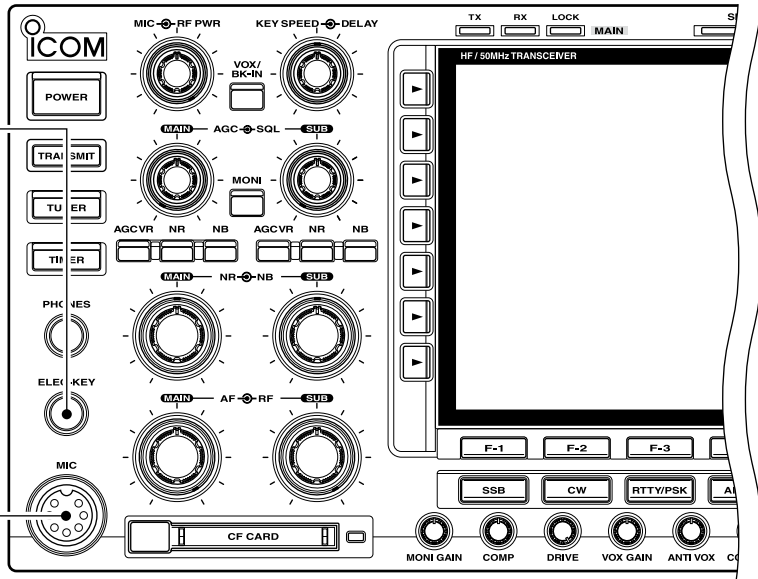
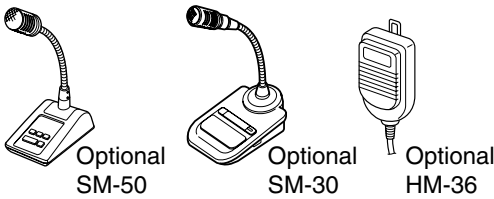

Rear panel

Antenna 1, 2, 3, 4 (p. 2-3)

[Example]: ANT1 for 1.8–18 MHz bands, ANT 2 for 21–28 bands
ANT3 for 50 MHz band, ANT 4 for receive antenna.

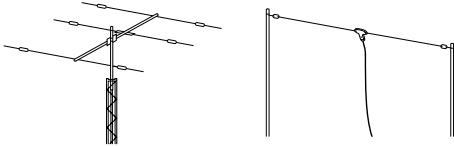

NOTE: Attach the supplied antenna connector cap when no antenna or external equipment is connected.

A jumper cable is connected.

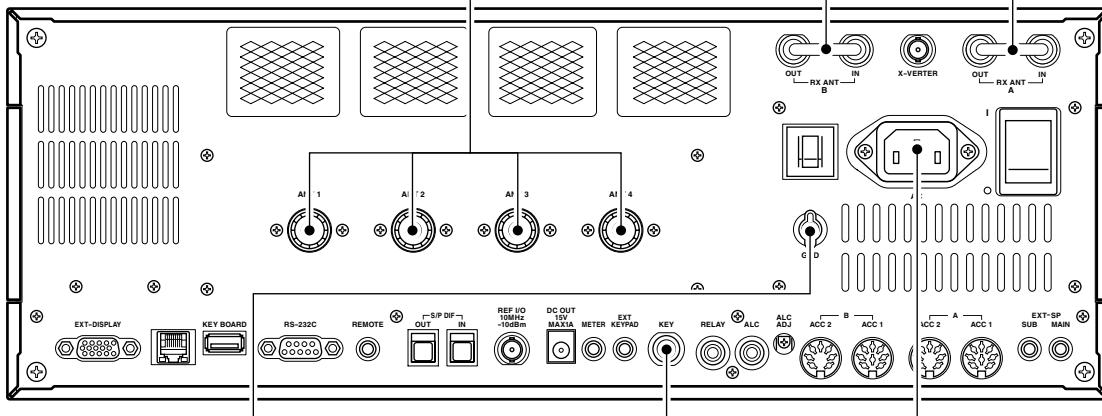

Ground (p. 2-3)

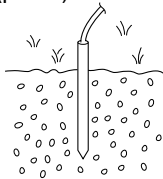

Use the heaviest gauge wire or strap available and make the connection as short as possible.

Grounding prevents electrical shocks, TVI and other problems.

Straight key

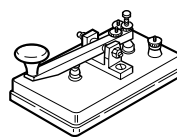

AC outlet

WARNING!
Use the supplied AC power cable only.

Advanced connections

Front panel

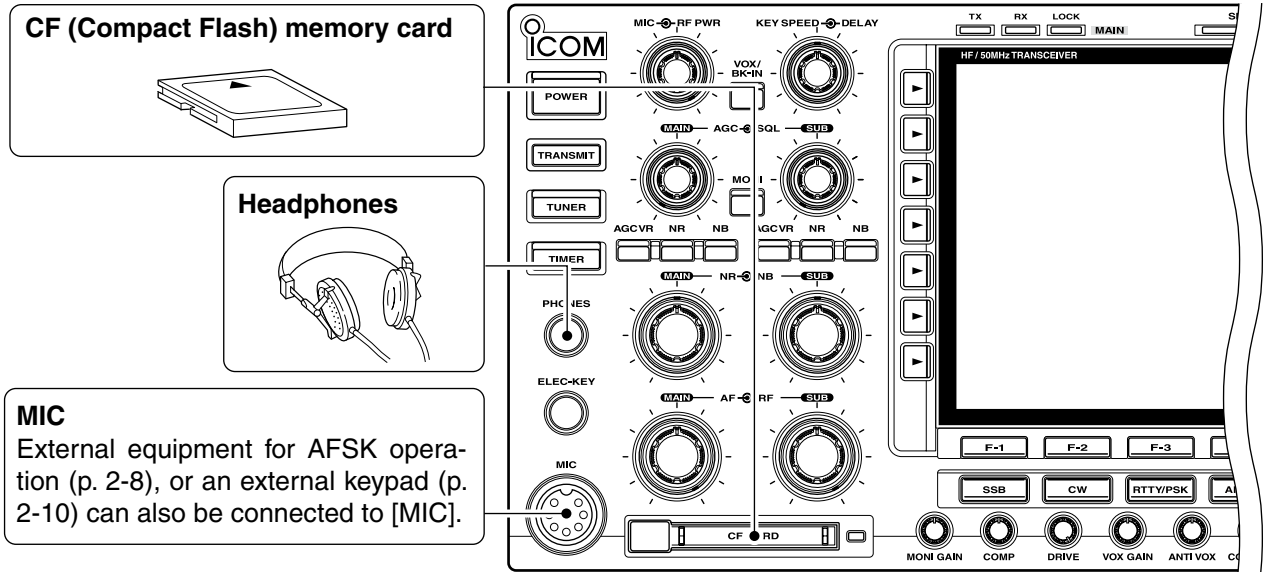

Rear panel— 1

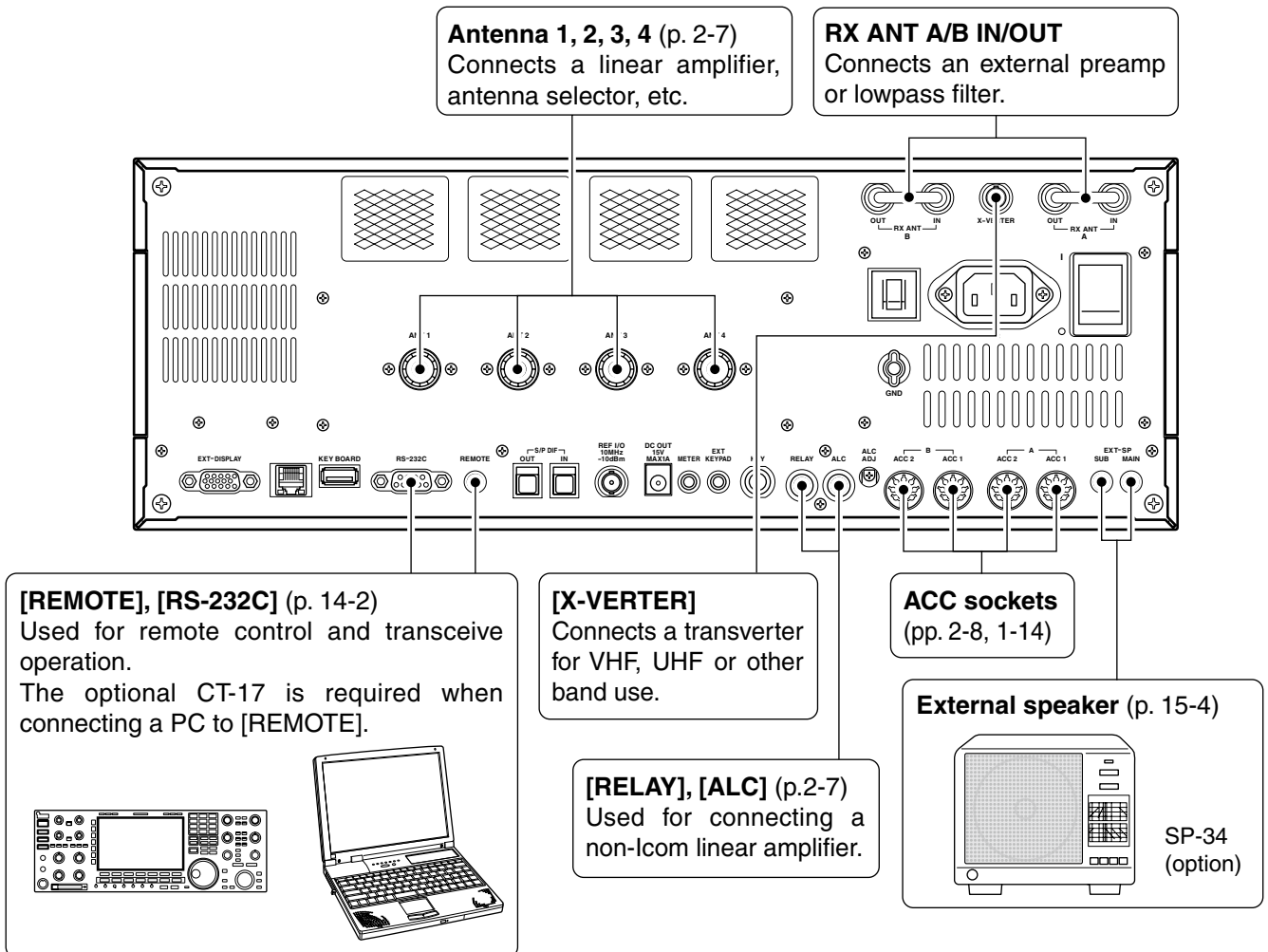

◇ Rear panel— 2

External Display



Connects a PC-style monitor display (at least 800×600 resolution). Video output signal can be turned ON or OFF in Display set mode. (p. 12-12)

Keyboard

Connects a USB device that is a PC keyboard, mouse, hub or memory (USB flash drive).

Only USB (Universal Serial Bus) type is supported.

[DC OUT]

Outputs regulated 14 V (approximately) DC for external equipment power supply. (maximum 1 A capacity)

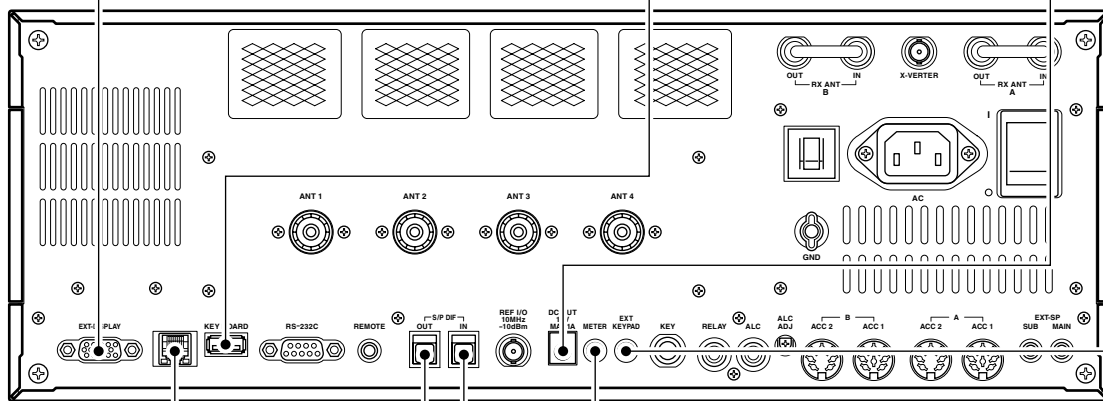

Ethernet connector (p. 16-6)



Connects a PC for remote control through a LAN or the Internet using the RS-BA1, or for updating the CPU firmware.

[METER]

Connects an external meter, etc.

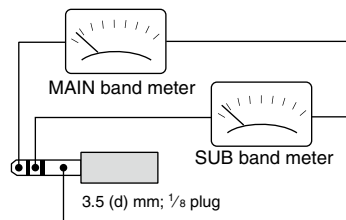

Output impedance : 4.7 kΩ
Output voltage : 2.5 V*
(open circuit)
*default value; Output voltage can be adjusted 0 to 5 V in ACC set mode (p. 12-10)

[S/P DIF IN/OUT]



Connects a PC for audio signal data input/output.

48 kHz, 16-bit Stereo output (L=Main band; R=Sub band)

External keypad

Connects an external keypad for direct voice memory, memory keyer, PSK memory and RTTY memory contents transmission.

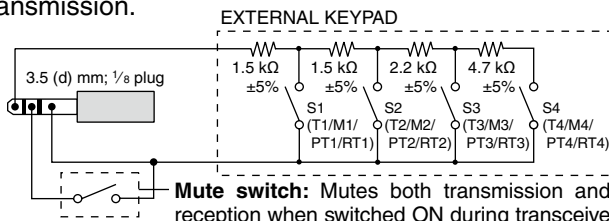

Mute switch: Mutes both transmission and reception when switched ON during transceive operation, etc.

✓ For your information:

An external keypad can also be connected to the microphone connector on the front panel. See page 2-10 for details.

■ Linear amplifier connections

◇ Connecting the IC-PW1/EURO

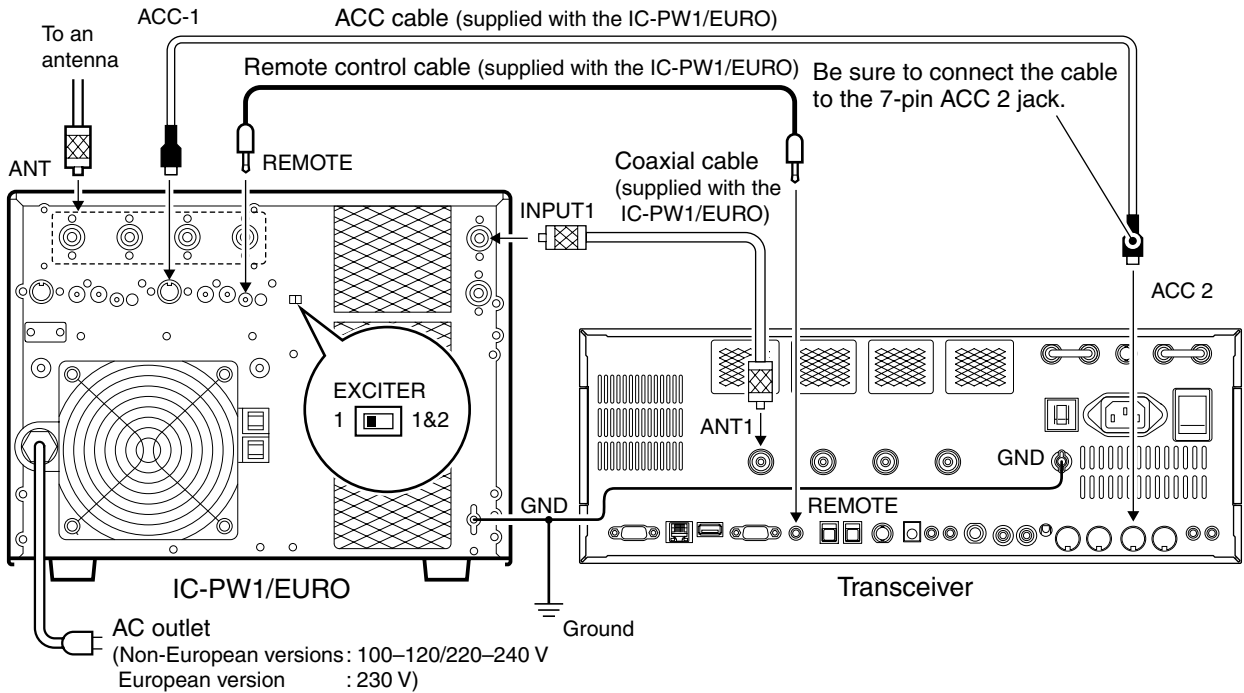

◇ Connecting a non-Icom linear amplifier

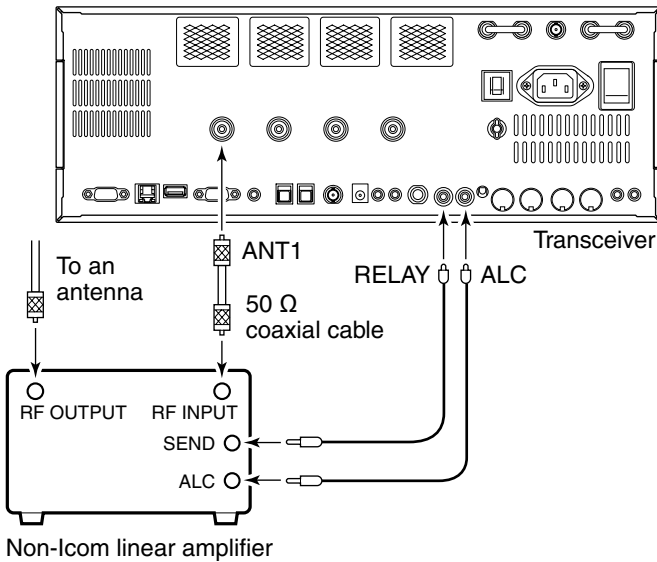

⚠ WARNING!

Set the transceiver output power and linear amplifier ALC output level referring to the linear amplifier instruction manual.

The ALC input level must be in the range 0 V to -4 V. The transceiver does not accept positive voltage. Non-matched ALC and RF power settings could cause a fire or damage the linear amplifier.

The maximum control level of [RELAY] jack is 16 V/0.5 A DC with initial setting, and 250 V/200 mA with "MOS-FET" setting (see p. 12-9 for details). Use an external relay unit when your non-Icom linear amplifier requires control voltage and/or current greater than specified.

When using a linear amplifier that has a time delay between receiving and transmitting, a high SWR might cause the linear amplifier to malfunction. To prevent this, slow the TX Delay the "TX Delay (HF), (50M)" settings in the Others Set mode. (p. 12-15)

SET > OTHERS > TX Delay (HF), (50M)

■ Transverter jack information

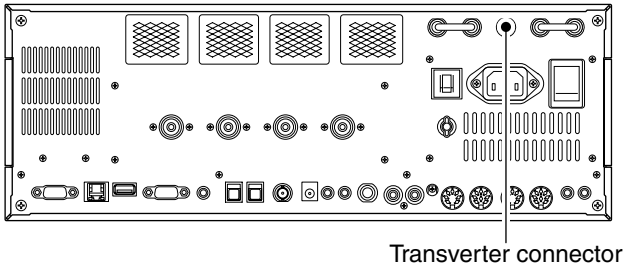

When 2 to 13.8 V is applied to pin 6 of [ACC 2], the [X-VERTER] connector is activated for transverter operation and the antenna connectors do not receive or transmit any signals. (p. 4-6)

While receiving, [X-VERTER] connector can be activated as an input terminal from an external transverter.

While transmitting, the [X-VERTER] connector outputs signals of the displayed frequency at -20 dBm (22 mV) as signals for the external transverter.

■ FSK and AFSK connections

The transceiver has a Modem function for RTTY and PSK. However, if you want to use a PC to operate these digital modes, it is necessary to prepare the following interface circuit, or use a similar 3rd party device.

Refer to the instruction manual for the device prior to connecting it.

◇ When using the ACC socket or the microphone connector

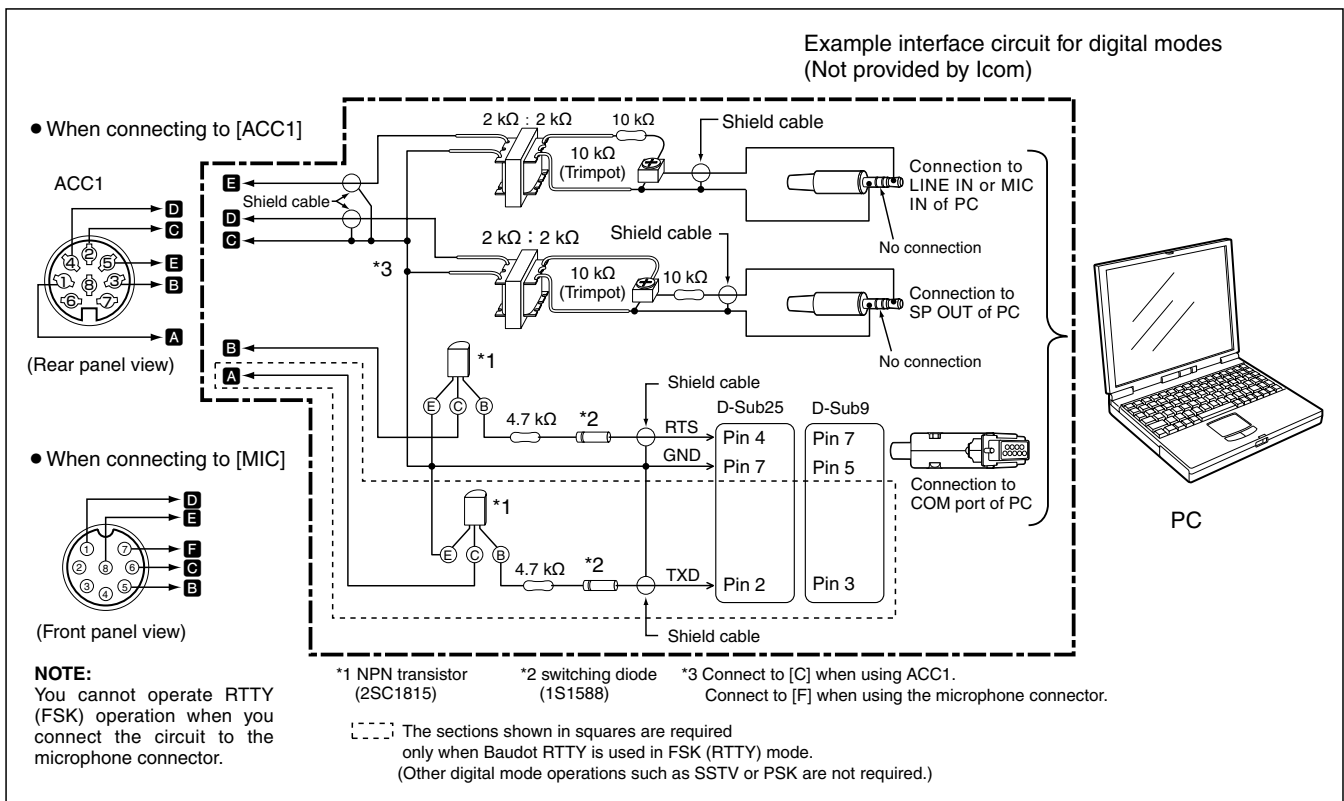

Microphones (options)

◇ SM-50

TOP VIEW

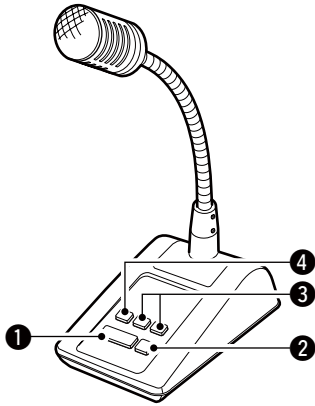

BOTTOM VIEW

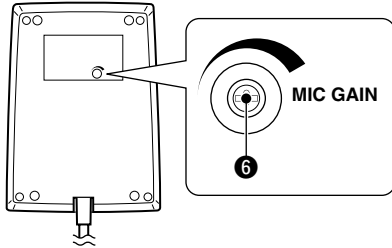

◇ SM-30

TOP VIEW

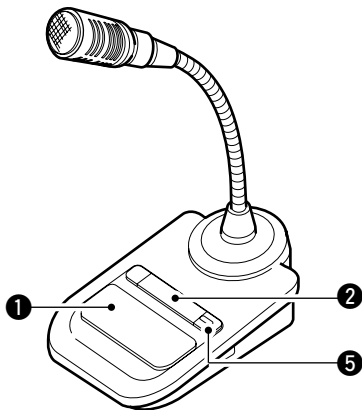

BOTTOM VIEW

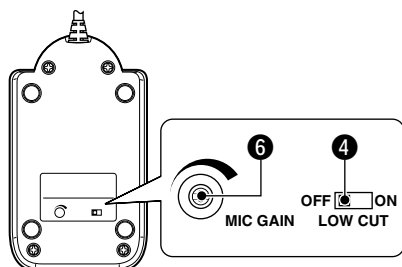

① PTT SWITCH

Hold down to transmit, release to receive.

② PTT LOCK SWITCH

Push to lock the PTT switch in the transmit mode.

③ UP/DOWN SWITCHES [UP]/[DN]

Change the selected readout frequency or memory channel.

- Holding down continuously changes the frequency or memory channel number.
- While holding down [XFC], the transmit readout frequency can be controlled while in the split frequency mode.
- The [UP]/[DN] switch can simulate a key paddle. Preset in the keyer set mode. (p. 4-12)

④ LOW CUT SWITCH

Push (SM-50)/Slide (SM-30) to cut out the low frequency components of input voice signals.

⑤ PTT LOCK INDICATOR [LOCK]

(Only for the SM-30)

Lights red when the PTT lock switch (②) is ON.

⑥ MIC GAIN VOLUME [MIC GAIN]

Rotate to adjust the microphone output level.

- Use this control as an addition to the microphone gain setting of the connected transceiver.

Rotating the control too far clockwise may result in an output level that is too high and transmit signal distortion.

Microphones (options) (continued)

◇ HM-36

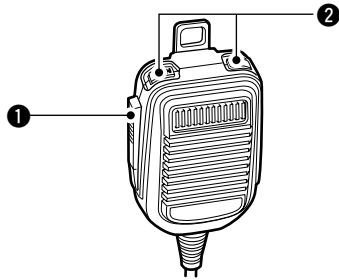

1 PTT SWITCH

Hold down to transmit; release to receive.

2 UP/DOWN SWITCHES [UP]/[DN]

Change the selected readout frequency or memory channel.

- Holding down continuously changes the frequency or memory channel number.
- While holding down [XFC], the transmit readout frequency can be controlled while in the split frequency mode.
- The [UP]/[DN] switch can simulate a key paddle. Preset in the keyer set mode. (p. 4-12)

Microphone connector information

(Front panel view)

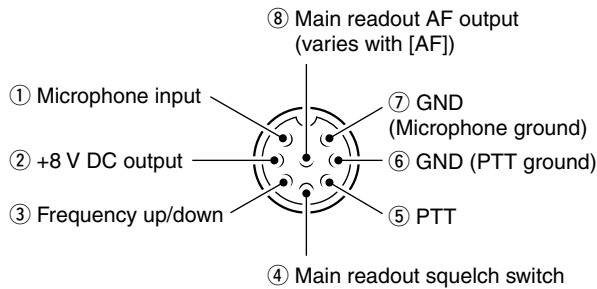

[MIC] Pin No.	FUNCTION	DESCRIPTION
2	+8 V DC output	Max. 10 mA
3	Frequency up	Ground
	Frequency down	Ground through 470 Ω
4	Squelch open	"Low" level
	Squelch closed	"High" level

• EXTERNAL KEYPAD connection

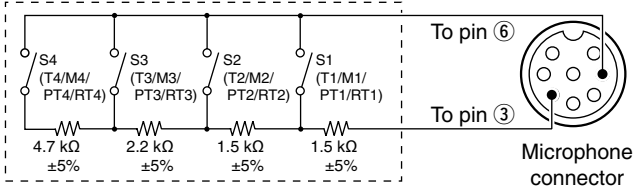

CAUTION:

DO NOT short pin 2 to ground as this can damage the internal 8 V regulator.
DC voltage is applied to pin 1 for microphone operation. Use caution when using a non-Icom microphone.

■ When first applying power (CPU resetting)	3-2
■ Initial settings	3-2
■ Main/Sub band selection	3-3
■ Selecting VFO/memory mode	3-3
■ Selecting an operating band	3-4
◇ Using the band stacking registers	3-4
■ Frequency setting	3-5
◇ Tuning with the main dial	3-5
◇ Direct frequency entry with the keypad	3-5
◇ Quick tuning step	3-6
◇ Selecting "kHz" step	3-6
◇ 1/4 tuning step function	3-6
◇ Selecting 1 Hz step	3-7
◇ Auto tuning step function	3-7
■ Operating mode selection.....	3-8
■ Volume setting	3-9
■ RF gain adjustment	3-9
■ Squelch level adjustment	3-9
■ Meter indication selection.....	3-10
◇ Multi-function digital meter	3-10
◇ Meter type selection	3-11
■ Basic transmit operation	3-12
◇ Transmitting	3-12
◇ Microphone gain adjustment	3-12
◇ Drive gain adjustment	3-13
■ Band edge warning beep	3-13
◇ Programming the user band edge	3-14

■ When first applying power (CPU resetting)

Before first applying power, make sure all connections required for your system are complete by referring to Section 2. Then, reset the transceiver using the following procedure.

Resetting **CLEARs** all programmed contents in memory channels and returns programmed values in set mode to default values.

- ① Turn the main power ON with [I/O] on the rear panel.
 - The transceiver power is still OFF and the [POWER] indicator lights orange.
- ② While holding down [F-INP•ENT] and [MW], push [POWER] to turn power ON.
 - The CPU is reset.
 - The CPU start-up takes approximately 5 seconds.
 - The transceiver displays its initial VFO frequencies when resetting is complete.
- ③ Change the set mode settings after resetting, if desired.

In cooler temperatures, the LCD may appear dark and unstable after turning power ON. This is normal and does not indicate any equipment malfunction.

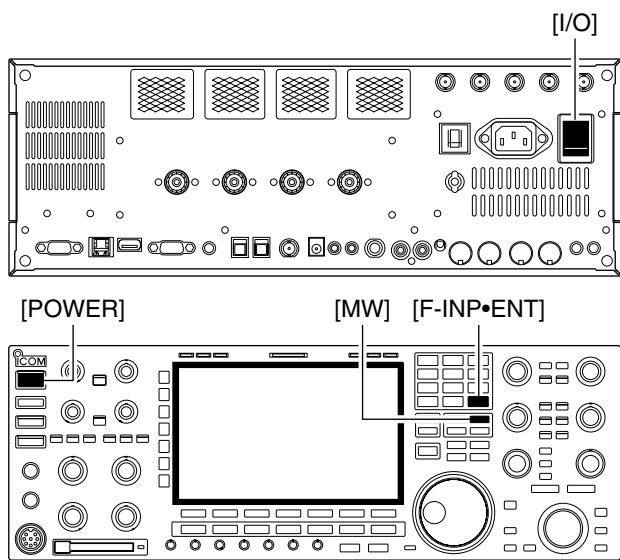

■ Initial settings

After resetting the transceiver, set controls as shown in the figure below.

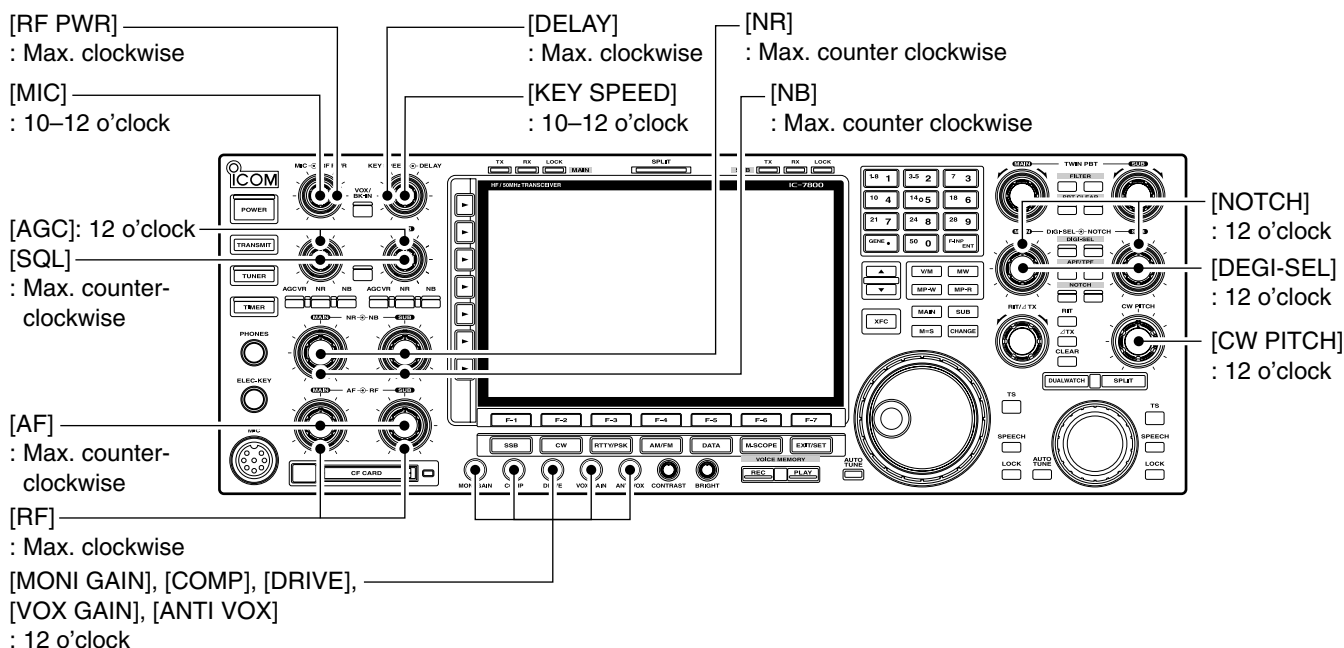

■ Main/Sub band selection

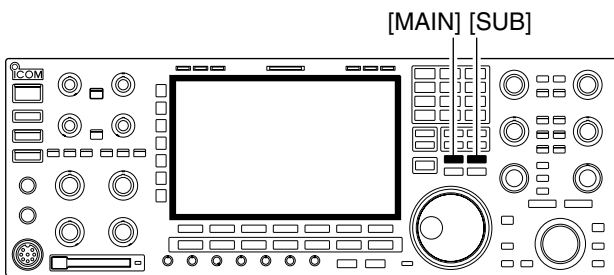

The IC-7800 has 2 identical receivers, main and sub. The main band is displayed on the left hand side, and the sub band is displayed on the right hand side of the LCD. Some functions can only be applied to the selected band and transmission occurs on the main band (except during split frequency operation).

- Push [MAIN] to select the main band.
 - The key backlight for [MAIN] lights.
 - Main band's frequency readout highlighted.
- Push [SUB] to select the sub band.
 - The key backlight for [SUB] lights.
 - Sub band's frequency readout highlighted.

■ Selecting VFO/memory mode

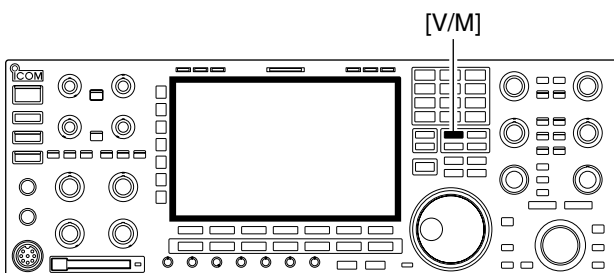

VFO is an abbreviation of Variable Frequency Oscillator, and is commonly referred to as a main tuning function.

The main dial is often called the "VFO knob."

- Push [V/M] to switch between VFO and memory modes.
 - "VFO" appears when in VFO mode, or the selected memory channel number appears when in memory mode.
 - Holding down [V/M] for 1 second transfers the contents of the selected memory channel to VFO. (p. 8-5)



■ Selecting an operating band

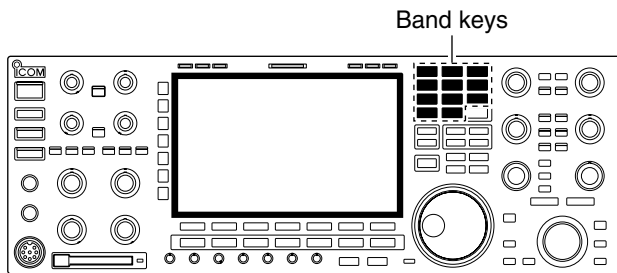

The triple band stacking register provides 3 memories for each band key, storing frequency and mode information.

If a band key is pushed once, the frequency and operating mode last used are called up. When the key is pushed again, another stored frequency and operating mode are called up.

This function is convenient when you operate 3 modes on one band. For example, one register is used for a CW frequency, another for an SSB frequency and the other one for an RTTY frequency.

See the table below for a list of the bands available and the default settings for each band.

BAND	REGISTER 1	REGISTER 2	REGISTER 3
1.8 MHz	1.900000 MHz CW	1.910000 MHz CW	1.915000 MHz CW
3.5 MHz	3.550000 MHz LSB	3.560000 MHz LSB	3.580000 MHz LSB
7 MHz	7.050000 MHz LSB	7.060000 MHz LSB	7.020000 MHz CW
10 MHz	10.120000 MHz CW	10.130000 MHz CW	10.140000 MHz CW
14 MHz	14.100000 MHz USB	14.200000 MHz USB	14.050000 MHz CW
18 MHz	18.100000 MHz USB	18.130000 MHz USB	18.150000 MHz USB
21 MHz	21.200000 MHz USB	21.300000 MHz USB	21.050000 MHz CW
24 MHz	24.950000 MHz USB	24.980000 MHz USB	24.900000 MHz CW
28 MHz	28.500000 MHz USB	29.500000 MHz USB	28.100000 MHz CW
50 MHz	50.100000 MHz USB	50.200000 MHz USB	51.000000 MHz FM
General	15.000000 MHz USB	15.100000 MHz USB	15.200000 MHz USB

◇ Using the band stacking registers

[Example]: 14 MHz band

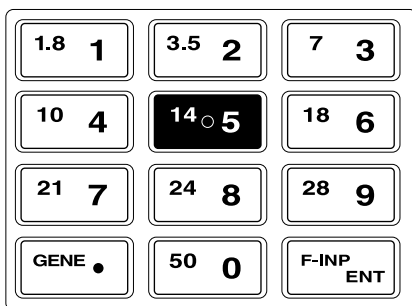

- ① Push [14•5], then select a frequency and an operating mode.
 - The previously selected frequency and an operating mode are memorized in the first band stacking register of that band.
- ② Push [14•5] again, then select another frequency and operating mode.
 - The frequency and operating mode that is selected in step ① are memorized in the 14 MHz's first band stacking register.
- ③ Push [14•5] again, then select another frequency and operating mode.
 - The frequency and operating mode that is selected in step ② are memorized in the 14 MHz's second band stacking register.
- ④ Push [14•5] again, then select another frequency and operating mode.
 - The frequency and operating mode that is selected in step ③ are memorized in the 14 MHz's third band stacking register.
 - When [14•5] is pushed again, the first band stacking register set in step ②, is overwritten.

Frequency setting

◇ Tuning with the main dial

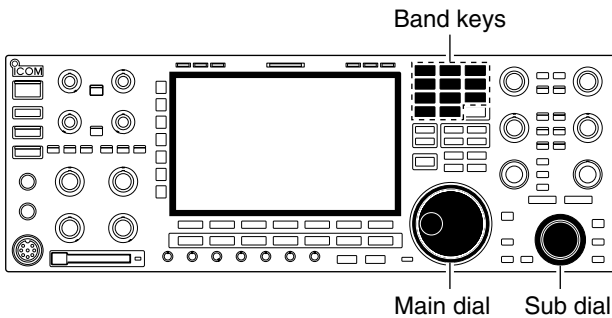

- ① Push the desired band key on the keypad 1–3 times.
 - 3 different frequencies can be selected on each band with the band key.
 - Push [MAIN] or [SUB] to select the band.
- ② Rotate the main dial to set the desired frequency in the main band, rotate the sub dial to set the desired frequency in the sub band.

⚡ If the dial lock function is activated, the lock indicator lights, and the main dial does not function. In this case, push [LOCK] to deactivate the lock function. (see p. 5-20 for details)

✓ CONVENIENT!

The sub dial is always available for tuning the sub band. The sub dial allows quick tuning in the sub band without switching from main to sub.

◇ Direct frequency entry with the keypad

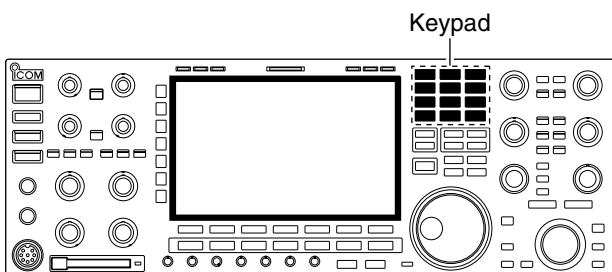

The transceiver has a keypad for direct frequency entry as described below.

- ① Push [MAIN] or [SUB] to select the band.
- ② Push [F-INP•ENT].
 - “**F-INP**” indicator appears and keypad backlight lights.
- ③ Input the desired frequency
 - Push [GENE•.] to input “.” (decimal point) between the MHz units and kHz units.
- ④ Push [F-INP•ENT] to set the input frequency.
 - To cancel the input, push any other key (except [▲]/[▼]) instead of [F-INP•ENT].

[EXAMPLE]

7.0000 MHz

Push **[F-INP ENT]** **21 7** **[F-INP ENT]**

VFO USB FIL2 **F-INP** **. . 7** → VFO USB FIL2 **7.000.00**

21.24000 MHz

Push **[F-INP ENT]** **3.5 2** **1.8 1** **[GENE•.]** **3.5 2** **10 4** **[F-INP ENT]**

VFO USB FIL2 **F-INP** **. . .21** → VFO USB FIL2 **F-INP** **21. .** → VFO USB FIL2 **F-INP** **21. .24** → VFO USB FIL2 **21.240.00**

21.24000 MHz ⇒ 21.36000 MHz

Push **[F-INP ENT]** **[GENE•.]** **7 3** **18 6** **[F-INP ENT]**

VFO USB FIL2 **F-INP** **21. .** → VFO USB FIL2 **F-INP** **21. .36** → VFO USB FIL2 **21.360.00**

3 BASIC OPERATIONS

◇ Quick tuning step

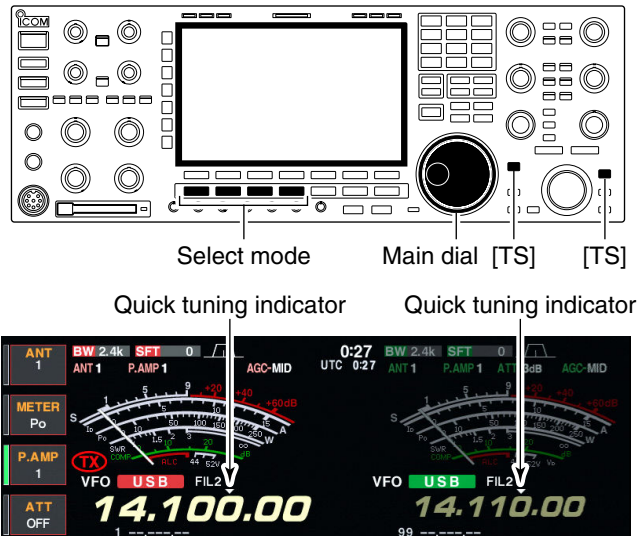

The operating frequency can be changed in kHz steps (0.1, 1, 5, 9, 10, 12.5, 20 or 25 kHz selectable) for quick tuning.

- ① Push [TS] to turn the quick tuning function ON.
 - “▼” appears when the quick tuning function ON.
- ② Rotate the main dial to change the frequency in programmed kHz steps.
- ③ Push [TS] again to turn OFF the indicator.
- ④ Rotate the main dial for normal tuning if desired.

◇ Selecting “kHz” step



- ① Push [TS] to turn the quick tuning function ON or OFF.
 - “▼” appears when the quick tuning function ON.
- ② Hold down [TS] for 1 second to enter tuning step setting display.
 - Selected tuning steps for all modes appear.
- ③ Select the desired operating mode.
- ④ Rotate the main dial to select the desired tuning step.
- ⑤ Repeat steps ③ and ④ to select quick tuning steps for other modes, if desired.
- ⑥ Push [EXIT/SET] to exit the setting display.

NOTE: When entering quick tuning step set mode, the quick tuning function must be activated first. The main and sub bands have independent tuning step settings.

◇ 1/4 tuning step function

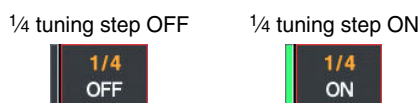

When operating in SSB data, CW, RTTY or PSK, the 1/4 tuning function is selectable. Dial speed is reduced to 1/4 of normal speed when the 1/4 tuning function is ON for finer tuning control.

- Push [1/4] to toggle the 1/4 tuning function ON or OFF.
 - “1/4” appears when the 1/4 tuning function is ON.

◇ Selecting 1 Hz step



The minimum tuning step of 1 Hz can be used for fine tuning.

- ① Push [TS] to turn the quick tuning function OFF.
- ② Hold down [TS] for 1 second to turn the 1 Hz tuning step ON or OFF.

NOTE: 1 Hz tuning step activates for both main and sub bands simultaneously. Therefore, either [TS] can be used for the 1 Hz tuning step selection.

◇ Auto tuning step function

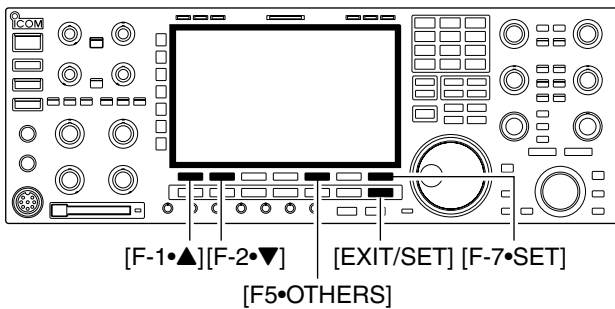

When rotating main or sub dial rapidly, the tuning speed accelerated automatically as selected.

- ① Push [EXIT/SET] several times to close a multi-function screen, if necessary.
- ② Push [F-7•SET] to select set mode menu screen.
 - Holding down [EXIT/SET] for 1 second also selects set mode menu screen.
- ③ Push [F-5•OTHERS] to enter the Others set mode.
- ④ Push [F-1•▲] or [F-2•▼] to select “MAIN DIAL Auto TS” or “SUB DIAL Auto TS.”
 - “MAIN DIAL Auto TS” for main dial, “SUB DIAL Auto TS” for sub dial selection.
- ⑤ Rotate main dial to select the desired condition from high, low and OFF.
 - HIGH: Approximately 5 times faster when the tuning step is set to 1 kHz or smaller steps; approximately 2 times faster when the tuning step is set to 5 kHz or larger steps.
 - LOW: Approximately 2 times faster.
 - OFF : Auto tuning step is turned OFF.
- ⑥ Push [EXIT/SET] to exit the set mode.

■ Operating mode selection

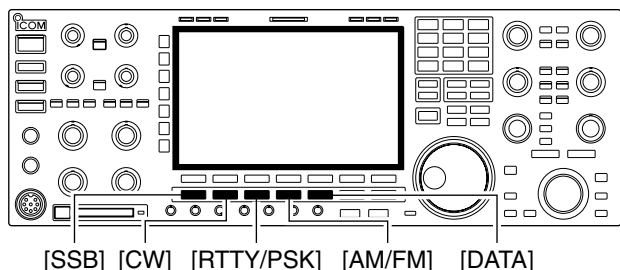

SSB (USB/LSB), SSB data (USB data/LSB data), CW, CW reverse (CW-R), RTTY, RTTY reverse (RTTY-R), PSK, PSK reverse (PSK-R), AM, AM data, FM and FM data modes are selectable in the IC-7800. Select the desired operation mode as follows.

To select a mode of operation, push the desired mode switch momentarily. Push the switch again to toggle between USB and LSB, CW and CW-R, RTTY/RTTY-R and PSK/PSK-R, AM and FM, if desired. Hold down the switch for 1 second to toggle between RTTY and RTTY-R, PSK and PSK-R, if desired. See the diagram below left for the order of selection.

Microphone signals are muted when data mode is selected.

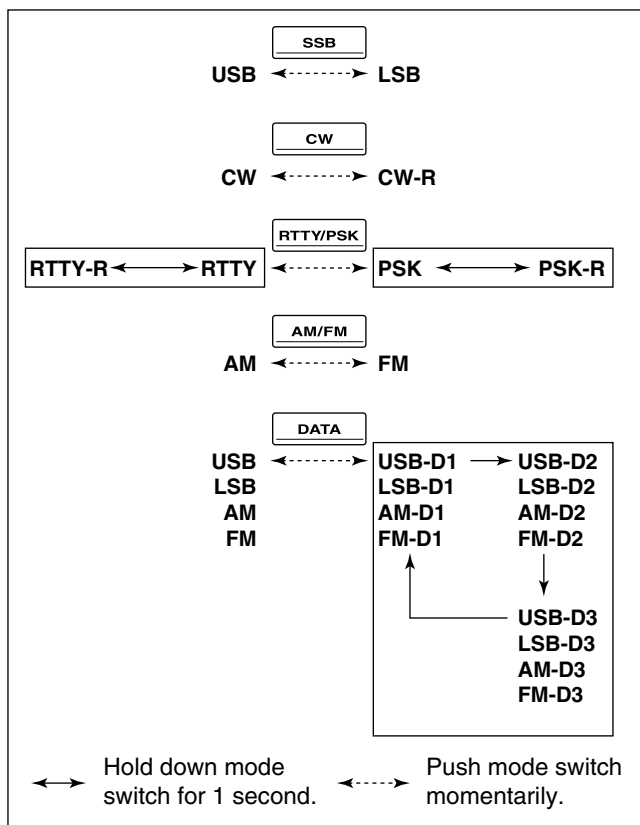

• Selecting SSB mode

- Push [SSB] to select USB or LSB.
 - USB is selected first when above 10 MHz; or LSB is selected first when below 10 MHz operation. (USB is selected when 5 MHz band is selected for the USA version.)
 - After USB or LSB is selected, push [SSB] to toggle between USB and LSB.

• Selecting CW mode

- Push [CW] to select CW.
 - After CW is selected, push [CW] to toggle between CW and CW reverse mode.

• Selecting RTTY/PSK mode

- Push [RTTY/PSK] to select RTTY or PSK.
 - After RTTY or PSK is selected, push [RTTY/PSK] to toggle between RTTY and PSK.
 - After RTTY or PSK is selected, hold down [RTTY/PSK] for 1 second to toggle between RTTY and RTTY reverse, or, PSK and PSK reverse mode, respectively.

• Selecting AM/FM mode

- Push [AM/FM] to select AM or FM.
 - After AM or FM is selected, push [AM/FM] to toggle between AM and FM.

• Selecting DATA mode

- After USB, LSB, AM or FM is selected, push [DATA] to select USB data, LSB data, AM data or FM data mode, respectively.
 - After data mode is selected, push [DATA] to toggle between regular voice and data mode.
 - After data mode is selected, hold down [DATA] for 1 second to select data 1, 2 and 3 in sequence.

■ Volume setting

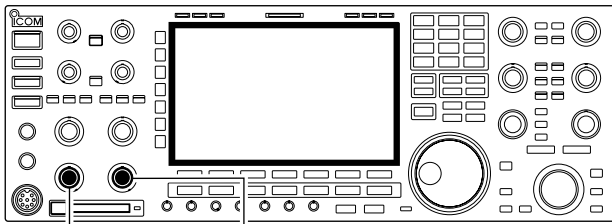

[AF] for main [AF] for sub

- ➔ Rotate [AF] control clockwise to increase, counterclockwise to decrease the audio output level.
 - Set a suitable audio level.

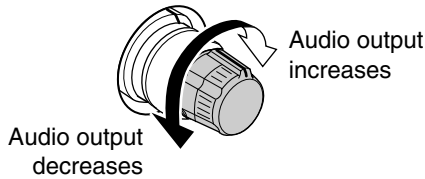

■ RF gain adjustment

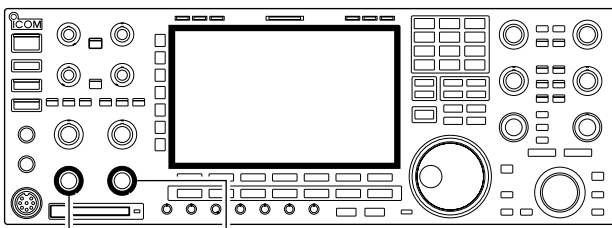

[RF] for main [RF] for sub

- ➔ Rotate [RF] control clockwise to increase, counterclockwise to decrease the receiver sensitivity.

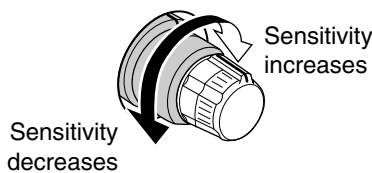

■ Squelch level adjustment

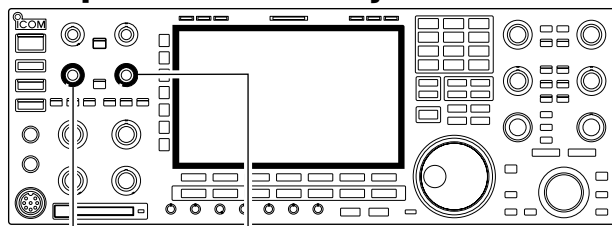

[SQL] for main [SQL] for sub

Noise squelch (Recommended level; FM mode only)

The squelch removes noise output from the speaker (closed position) when no signal is received.

- ➔ When no signal is received, rotate [SQL] control fully counterclockwise first, then rotate [SQL] clockwise to the point that the noise just disappears.

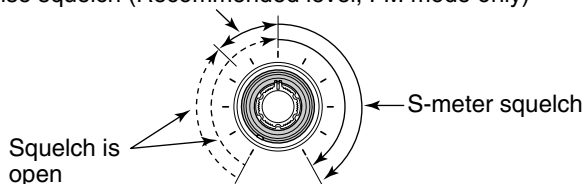

Meter indication selection

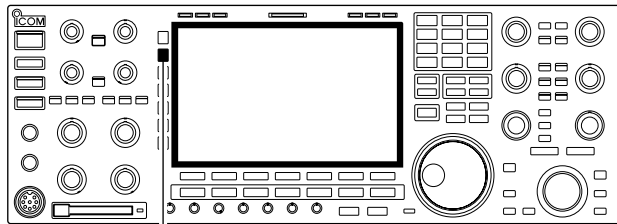

[METER]

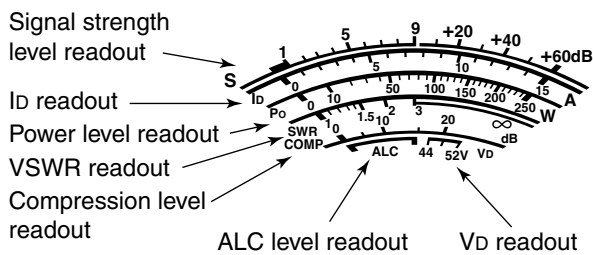

The S/RF meter indication, during transmit, can be selected from the following items as you desire.

➔ Push [METER] several times to select the desired item.

- METER Po** Indicates the RF output power in watts.
- METER SWR** Indicates the VSWR on the transmission line.
- METER ALC** Indicates the ALC level. The ALC circuit begins to activate when the RF output power reaches a preset level.
- METER COMP** Indicates the compression level when the speech compressor is in use.
- METER Id** Indicates the drain current of the final amplifier MOS-FETs.
- METER Vd** Indicates the drain terminal voltage of the final amplifier MOS-FETs.

◇ Multi-function digital meter

The IC-7800 can display the multi-function digital meter in the LCD display. This meter displays all transmit parameters simultaneously.

“P-HOLD” indicator

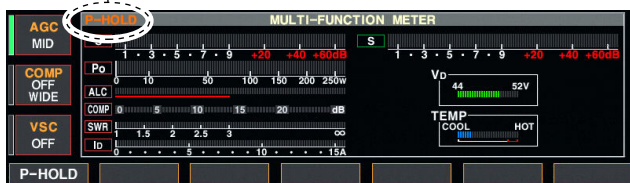

- ① Hold down [METER] for 1 second to turn the multi-function digital meter ON.
- ② Push [F-1•P-HOLD] to toggle the peak level hold function ON.
 - “P-HOLD” appears on the window title when the peak level hold function is ON.
- ③ Hold down [METER] for 1 second, or push [EXIT/SET] to turn the multi-function digital meter OFF.

◇ Meter type selection

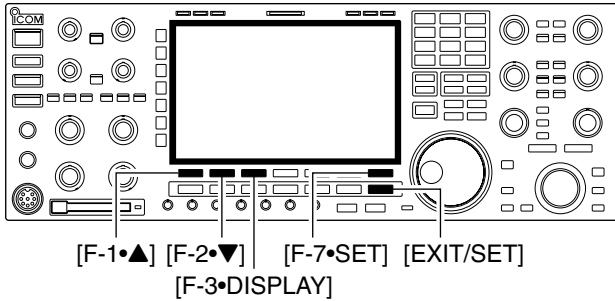

A total of 3 meter types are available in the IC-7800—Standard, Edgewise and Bar meters. Follow the instructions below for the meter type selection.

- ① Push [EXIT/SET] several times to return to normal screen, if necessary.
- ② Push [F-7•SET], then push [F-3•DISPLAY] to select display set mode.
- ③ Push [F-1•▲] or [F-2•▼] to select “Meter type (Normal Screen)” item.
- ④ Rotate main dial to select the desired meter type from “Standard,” “Edgewise” and “Bar.”
- ⑤ Push [EXIT/SET] to exit display set mode.



• Edgewise meter



• Bar meter



Basic transmit operation

Before transmitting, monitor your selected operating frequency to make sure transmitting won't cause interference to other stations on the same frequency. It's good amateur practice to listen first, and then, even if nothing is heard, ask "is the frequency in use" once or twice, before you being operating on that frequency.

Transmitting

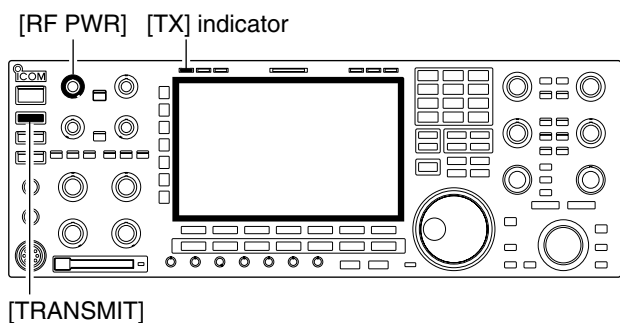

Before transmitting, monitor your selected operating frequency to make sure transmitting won't cause interference to other stations on the same frequency.

- ① Push [TRANSMIT] or [PTT] (microphone) to transmit.
 - The main band's [TX] indicator lights red.
 - When split operation is activated, the sub band's [TX] indicator lights.
- ② Push [TRANSMIT] again or release [PTT] (microphone) to return to receive.

Adjusting the transmit output power

- ➔ Rotate [RF PWR].
 - Adjustable range : 5 W to 200 W
(AM mode: 5 W to 50 W)

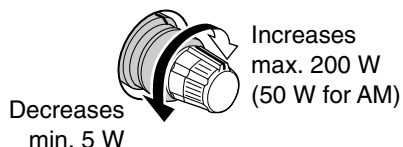

Microphone gain adjustment

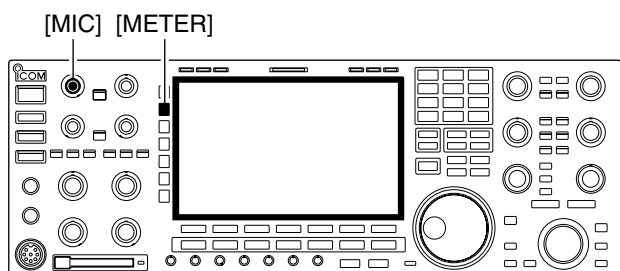

Before transmitting, monitor your selected operating frequency to make sure transmitting won't cause interference to other stations on the same frequency.

- ① Push [METER] to select the ALC meter.
- ② Push [PTT] (microphone) to transmit.
 - Talk into the microphone at your normal voice level.
- ③ While talking into the microphone, rotate [MIC] so that the ALC meter reading doesn't go outside the ALC zone. (see at left)
- ④ Release [PTT] (microphone) to return to receive.

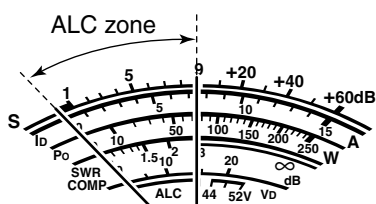

◇ Drive gain adjustment

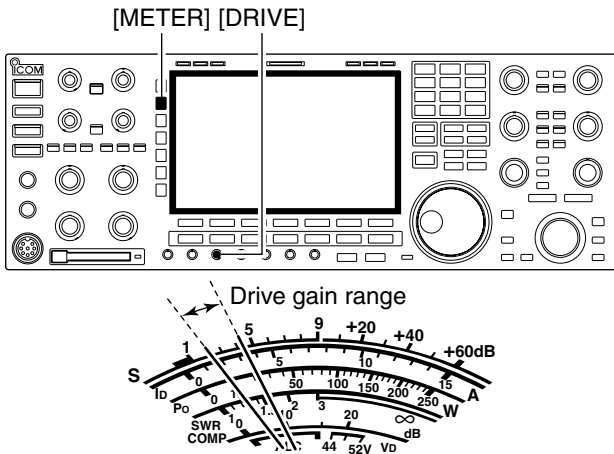

The drive gain is active for all modes except SSB without speech compressor. The [DRIVE] control adjusts the amplifying gain at the driver stage.

Before transmitting, monitor your selected operating frequency to make sure transmitting won't cause interference to other stations on the same frequency.

- ① Push [METER] to select the ALC meter.
- ② Push [PTT] (microphone; SSB with [COMP] ON, AM or FM), key down (CW) or push [TRANSMIT] (RTTY or PSK) to transmit.
- ③ While talking into the microphone, keying down or transmitting, rotate [DRIVE] so that the ALC meter reading swinging within 30 to 50% of the ALC scale. (see left)
 - Talk into the microphone at your normal voice level.
- ④ Release [PTT], stop keying or push [TRANSMIT] again to return to receive.

■ Band edge warning beep

When the transverter function is in use, the band edge warning beep sounds with the default setting.

This function allows you to hear a beep tone when you tune in or out of an amateur band's frequency range. A regular beep sounds when you tune into a range, and an lower tone error beep will sound when you tune out of a range.

Also, the TX indicator shows if the selected frequency is in or out of an amateur band, when an option other than "OFF" is set.

- A TX indicator with dotted oval, "TX" is displayed, instead of the regular "TX" TX indicator, when a frequency outside of an amateur band frequency range is selected.

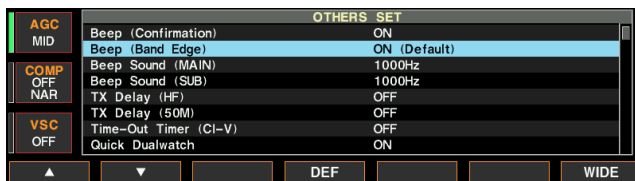
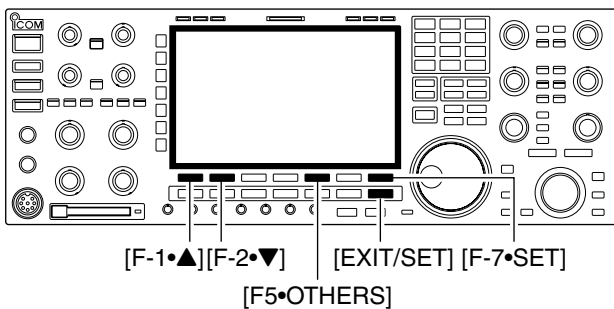

- ① Push [EXIT/SET] several times to close a multifunction screen, if necessary.
- ② Push [F-7•SET], then push [F-5•OTHERS] to select the Others set mode.
- ③ Push [▲] (F-1) or [▼] (F-2) to select "Beep (Band Edge)" option.
- ④ Rotate the main dial to select the desired band edge warning beep setting.
 - OFF : Band edge beep is OFF.
 - ON (Default) : When you tune into or out of the default amateur band's frequency range, a beep sounds. (default)
 - ON (User) : When you tune outside of, or back into a user programmed amateur band's frequency range, a beep sounds.
 - ON (User) & TX Limit : When you tune outside of, or back into a user programmed amateur band's frequency range, a beep sounds. Transmission is also inhibited outside the programmed range.
- ⑤ Push [EXIT/SET] to exit the set mode.

▨ The beep output level can be set in level set mode. (p. 12-5)

3 BASIC OPERATIONS

◇ Programming the user band edge

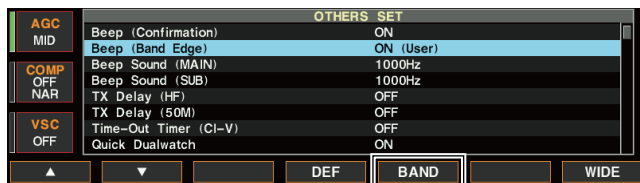

Appears when “ON (User)” or “ON (User) & TX Limit” is selected.

• Band edge screen



- ① Select the Others set mode and select the “Beep (Band Edge)” option.
- ② Rotate the main dial to select either the “ON (User)” or “ON (User) & TX Limit” setting.
 - [BAND] appears above [F-5].
- ③ Push [F-5•BAND] to open the band edge screen.
- ④ Push [F-1•▲] or [F-2•▼] to select the desired band edge.
 - Push [F-3•◀ ▶] to select the upper and lower band edge frequency entry cell.
 - Push [INS] to insert a new blank band edge line.
 - Hold down [DEL] for 1 second to delete the selected band edge line.
- ⑤ Push [F-INP•ENT], and then input the desired frequency with the keypad.
 - Push [GENE •] to input decimal point (“.”) between the MHz and kHz digits.
 - Program each channel from left to right and each frequency must be higher than the preceding frequency.
 - The frequency that is duplicated, or out of an amateur band, cannot be programmed.
 - If you want to return the band edge frequencies to their default (initial) value, hold down [F-4•DEF] for 1 second.

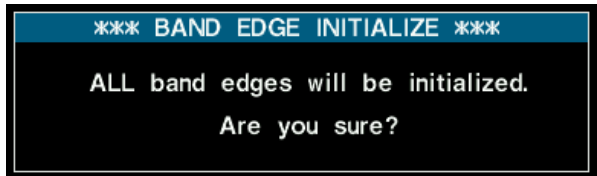

- ⑥ Push [F-INP•ENT] to set the input frequency.
- ⑦ Push [EXIT/SET] to exit the set mode.

■ Operating SSB	4-2
◇ Convenient functions for receive	4-2
◇ Convenient functions for transmit	4-3
◇ About 5 MHz band operation (USA version only)	4-3
■ Operating CW	4-4
◇ Convenient functions for receive	4-4
◇ Convenient functions for transmit	4-5
◇ About CW reverse mode	4-5
◇ About CW pitch control	4-5
◇ CW side tone function	4-5
◇ APF (Audio Peak Filter) operation	4-6
◇ About 137 kHz band operation (Europe, UK, Italy, Spain, France versions only)	4-6
■ Electronic keyer functions	4-7
◇ Memory keyer screen	4-8
◇ Editing a memory keyer	4-9
◇ Contest number set mode	4-10
◇ Keyer set mode	4-11
■ Operating RTTY (FSK)	4-13
◇ Convenient functions for receive	4-14
◇ About RTTY reverse mode	4-14
◇ Twin peak filter	4-14
◇ Functions for the RTTY decoder indication	4-15
◇ Setting the decoder threshold level	4-15
◇ RTTY memory transmission	4-16
◇ Automatic transmission/reception setting	4-16
◇ Editing RTTY memory	4-17
◇ RTTY decode set mode	4-18
◇ Data saving	4-20
■ Operating PSK	4-21
◇ Convenient functions for receive	4-22
◇ About BPSK and QPSK mode	4-22
◇ Functions for the PSK decoder indication	4-23
◇ Setting the decoder threshold level	4-23
◇ PSK memory transmission	4-24
◇ Automatic transmission/reception setting	4-24
◇ Editing PSK memory	4-25
◇ PSK decode set mode	4-26
◇ Data saving	4-28
■ Operating AM	4-29
◇ Convenient functions for receive	4-29
◇ Convenient functions for transmit	4-30
■ Operating FM	4-31
◇ Convenient functions for receive	4-31
◇ Convenient functions for transmit	4-31
■ Repeater operation	4-32
◇ Repeater tone frequency setting	4-32
■ Tone squelch operation	4-33
■ Data mode (AFSK) operation	4-34

■ Operating SSB

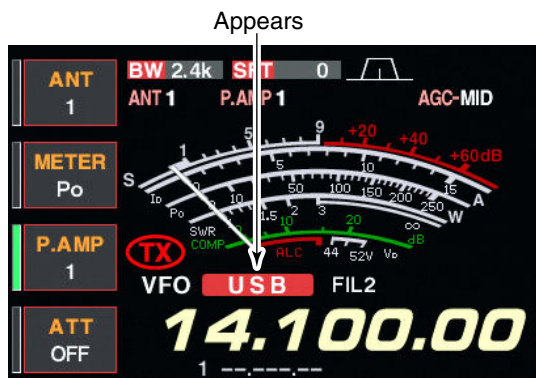
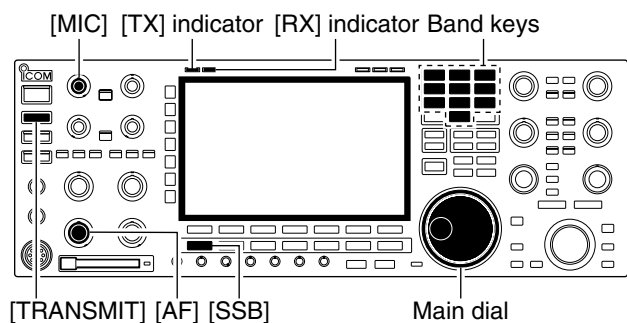

- ① Push a band key to select the desired band.
- ② Push [SSB] to select LSB or USB.
 - “USB” or “LSB” appears.
 - Below 10 MHz LSB is automatically selected; above 10 MHz USB is automatically selected.
- ③ Rotate the main dial to tune a desired signal.
 - The S-meter indicates received signal strength when signal is received.
- ④ Rotate [AF] to set audio to a comfortable listening level.
- ⑤ Push [TRANSMIT] or [PTT] (microphone) to transmit.
 - [TX] indicator lights red.
- ⑥ Speak into the microphone at your normal voice level.
 - Adjust the microphone gain with [MIC] at this step, if necessary.
- ⑦ Push [TRANSMIT] or release [PTT] (microphone) to return to receive.

◇ Convenient functions for receive

- **Preamp** (p. 5-10)
 - ➔ Push [P.AMP] several times to set the preamp OFF, preamp 1 ON or preamp 2 ON.
 - “P.AMP1” or “P.AMP2” appears when the preamp 1 or preamp 2 is ON, respectively. (Main and sub have independent preamp controls.)
- **Attenuator** (p. 5-10)
 - ➔ Push [ATT] several times to set the attenuator in 6 dB steps.
 - Hold down [ATT] for 1 second to set the attenuator in 3 dB steps.
 - “ATT” and attenuation level appear when the attenuator is ON.
- **Noise blanker** (p. 5-18)
 - ➔ Push [NB] switch to turn the noise blanker ON or OFF, and then rotate [NB] control to adjust the threshold level.
 - Noise blanker indicator (above [NB] switch) lights when the noise blanker is ON.
 - Hold down [NB] for 1 second to enter noise blanker set mode.
- **Twin PBT (passband tuning)** (p. 5-13)
 - ➔ Rotate [TWIN PBT] controls (inner/outer).
 - Hold down [PBT CLEAR] for 1 second to clear the settings.
- **Audio tone control** (p. 12-4)
 - ➔ Push [F-7•SET] then [F-1•LEVEL] to enter level set mode. Select an item with [F-1•▲]/[F-2•▼] then rotate the main dial to adjust the audio tone.
- **Noise reduction** (p. 5-19)
 - ➔ Push [NR] switch to turn the noise reduction ON or OFF.
 - Rotate [NR] control to adjust the noise reduction level.
 - Noise reduction indicator (above [NR] switch) lights when the noise reduction is ON.
- **Notch filter** (p. 5-20)
 - ➔ Push [NOTCH] switch to turn the auto or manual notch function ON or OFF.
 - Rotate [NOTCH] control to set the “valley” frequency for manual notch operation.
 - Notch indicator (above [NOTCH] switch) lights when either the auto or manual notch is ON.
- **AGC (auto gain control)** (p. 5-12)
 - ➔ Push [AGC] switch several times to select AGC FAST, AGC MID or AGC SLOW.
 - ➔ Push [AGC VR] to turn the AGC time constant manual setting ON or OFF.
 - Rotate [AGC] control to adjust the time constant.
- **VSC (voice squelch control)** (p. 9-3)
 - ➔ Push [VSC] to turn the VSC function ON or OFF.
 - The VSC indicator appears when the voice squelch function is set to ON.

◇ Convenient functions for transmit

- | | |
|---|---|
| <ul style="list-style-type: none"> • Speech compressor (p. 6-5) <ul style="list-style-type: none"> ➔ Push [COMP] to turn the speech compressor ON or OFF. <ul style="list-style-type: none"> • Hold down [COMP] for 1 second to select the compression bandwidth from wide, middle and narrow. • VOX (voice operated transmit) (p. 6-2) <ul style="list-style-type: none"> ➔ Push [VOX/BK-IN] to turn the VOX function ON or OFF. <ul style="list-style-type: none"> • “VOX” appears when the VOX function is ON. | <ul style="list-style-type: none"> • Transmit quality monitor (p. 6-4) <ul style="list-style-type: none"> ➔ Push [MONI] to turn the monitor function ON or OFF. <ul style="list-style-type: none"> • Rotate [MONI GAIN] to adjust the monitor gain. • Monitor indicator (above [MONI] switch) lights when the monitor function is ON. • Audio tone control (p. 12-4) <ul style="list-style-type: none"> ➔ Push [F-7•SET] then [F-1•LEVEL] to enter level set mode. Select an item with [F-1•▲]/[F-2•▼] then rotate the main dial to adjust the audio tone. |
|---|---|

◇ About the 5 MHz frequency band operation (USA version only)

Operation on the 5 MHz frequency band is allowed on 5 discrete frequencies and must adhere to the following:

- The USB, USB Data, CW, and PSK modes.
- Maximum of 100 watts ERP (Effective Radiated Power)
- 2.8 kHz bandwidth (maximum)

It is your responsibility to set all controls so that transmission in this frequency band meets the stringent conditions under which amateur operations may use these frequencies.

NOTE: We recommend that you store these frequencies, modes and filter settings into memory channels, for easy recall.

To assist you in operating within the rules specified by the FCC, transmission is illegal on any frequencies other than the five shown in the tables below.

• For the USB and USB Data modes

The FCC specifies center frequencies on the 5 MHz frequency band. However, the transceiver displays carrier frequency. Therefore, tune the transceiver to 1.5 kHz below the specified FCC channel center frequency.

Transceiver Displayed Frequency	FCC Channel Center Frequency
5.33050 MHz	5.33200 MHz
5.34650 MHz	5.34800 MHz
5.35700 MHz	5.35850 MHz
5.37150 MHz	5.37300 MHz
5.40350 MHz	5.40500 MHz

• For the CW and PSK modes

The transceiver displays the center frequency. Therefore, tune the transceiver to the specified FCC channel frequency when you operate in these modes.

Transceiver Displayed Frequency	FCC Channel Center Frequency
5.33200 MHz	5.33200 MHz
5.34800 MHz	5.34800 MHz
5.35850 MHz	5.35850 MHz
5.37300 MHz	5.37300 MHz
5.40500 MHz	5.40500 MHz

■ Operating CW

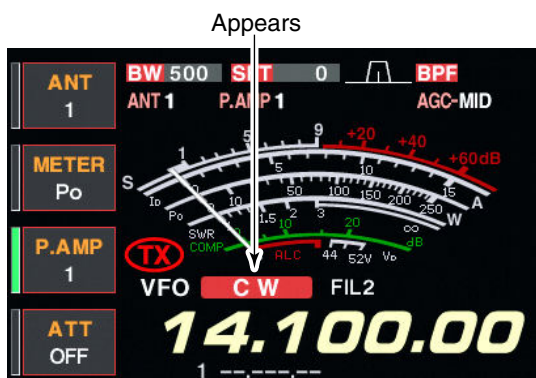
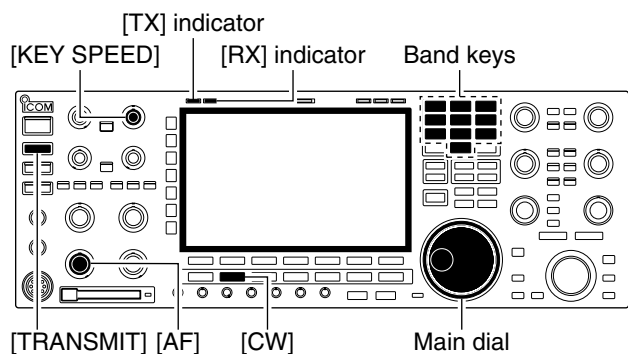

- ① Push a band key to select the desired band.
- ② Push [CW] to select CW.
 - After CW mode is selected, push [CW] to toggle between CW and CW-R modes.
 - “CW” or “CW-R” appears.
- ③ Rotate the main dial to tune a desired signal.
 - Try to match the specified signal’s tone to the side tone frequency.
 - The S-meter indicates received signal strength when signal is received.
- ④ Rotate [AF] to set audio to a comfortable listening level.
- ⑤ Push [TRANSMIT] to transmit.
 - [TX] indicator lights red.
- ⑥ Use the electric keyer or paddle to key your CW signals.
 - The power meter indicates transmitted CW output power.
- ⑦ Adjust CW speed with [KEY SPEED].
 - Adjustable within 6–60 WPM.
- ⑧ Push [TRANSMIT] to return to receive.

◇ Convenient functions for receive

- **Preamp** (p. 5-10)
 - ➔ Push [P.AMP] several times to set the preamp OFF, preamp 1 ON or preamp 2 ON.
 - “P.AMP1” or “P.AMP2” appears when the preamp 1 or preamp 2 is ON. Main and sub have independent preamp controls.
 - **Attenuator** (p. 5-10)
 - ➔ Push [ATT] several times to set the attenuator in 6 dB steps.
 - Hold down [ATT] for 1 second to set the attenuator in 3 dB steps.
 - “ATT” and attenuation level appear when the attenuator is ON.
 - **Noise blanker** (p. 5-18)
 - ➔ Push [NB] switch to turn the noise blanker ON or OFF, and then rotate [NB] control to adjust the threshold level.
 - Noise blanker indicator (above [NB] switch) lights when the noise blanker is ON.
 - Hold down [NB] for 1 second to enter noise blanker set mode.
 - **Noise reduction** (p. 5-19)
 - ➔ Push [NR] switch to turn the noise reduction ON or OFF.
 - Rotate [NR] control to adjust the noise reduction level.
 - Noise reduction indicator (above [NR] switch) lights when the noise reduction is ON.
 - **Twin PBT (passband tuning)** (p. 5-13)
 - ➔ Rotate [TWIN PBT] controls (inner/outer).
 - Hold down [PBT CLEAR] for 1 second to clear the settings.
 - **Manual notch filter** (p. 5-20)
 - ➔ Push [NOTCH] switch to turn the manual notch function ON or OFF.
 - Rotate [NOTCH] control to set the attenuating frequency.
 - Notch indicator (above [NOTCH] switch) lights when the manual notch is ON.
 - **AGC (auto gain control)** (p. 5-12)
 - ➔ Push [AGC] switch several times to select AGC FAST, AGC MID or AGC SLOW.
 - ➔ Push [AGC VR] to turn the AGC time constant manual setting ON or OFF.
 - Rotate [AGC] control to adjust the time constant.
 - **1/4 function** (p. 3-6)
 - ➔ Push [1/4] to turn the 1/4 function ON or OFF.
 - **Auto tuning function** (p. 1-9)
 - ➔ Push [AUTO TUNE] to turn the auto tuning function ON or OFF.
 - The transceiver automatically tunes the desired signal within a ± 500 Hz range.
- IMPORTANT!**
When receiving a weak signal, or receiving a signal with interference, the automatic tuning function may not tune properly, or tune onto an undesired signal.

◇ Convenient functions for transmit

- **Break-in function** (p. 6-3)
 - ➔ Push [VOX/BK-IN] several times to select the break-in OFF, semi break-in and full break-in.
 - “BK IN” or “F-BK IN” appears when the semi break-in or full break-in function is ON, respectively.

● About the 5 MHz frequency band operation (USA version only)

See page 4-3 for details.

◇ About CW reverse mode

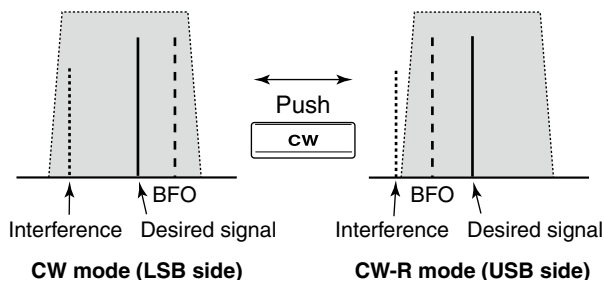

CW-R (CW Reverse) mode uses the opposite side band to receive CW signals.

Use when interfering signals are near a desired signal and you want to use CW-R to reduce the interference.

- ➔ During CW mode, push [CW] to select CW and CW-R mode.

◇ About CW pitch control

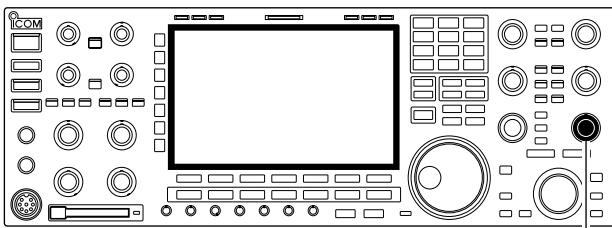

[CW PITCH]

The received CW audio pitch and CW side tone can be adjusted to suit your preference (from 300 to 900 Hz in 5 Hz steps). This does not change the operating frequency.

- ➔ Rotate [CW PITCH] to suit your preference.
 - Adjustable within 300 to 900 Hz in 5 Hz steps.

• Example for the CW pitch frequency display

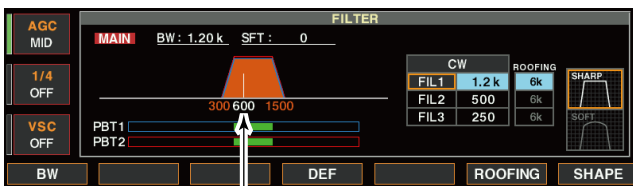

CW pitch frequency (Example: 600 Hz)

✓ For your convenience

The filter set screen graphically displays the CW pitch operations. (See at left.)

- ➔ Hold down [FILTER] for 1 second to access the filter set screen.

- The CW pitch frequency is graphically changed in 5 Hz steps when the selected IF filter passband width is below 500 Hz (“BPF” appears), or in 25 Hz steps when the selected IF filter passband width is above 600 Hz (“BPF” disappears).
- Push [EXIT/SET] or hold down [FILTER] for 1 second to return to the previous screen.

◇ CW side tone function

When the transceiver is in the receive condition (and the break-in function is OFF— p. 6-3) you can listen to the CW side tone without actually transmitting.

This allows you to match your transmit frequency exactly to another station’s by matching the audio tone. You can also use the CW side tone (be sure to turn OFF break-in!) to practice CW sending. CW side tone level can be adjusted in level set mode (p. 12-5).

◇ APF (Audio Peak Filter) operation

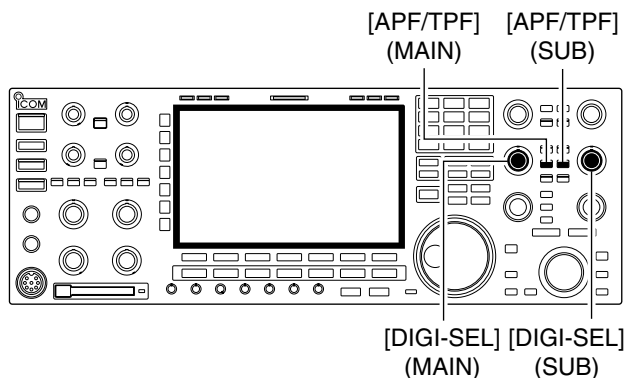

The APF changes the audio frequency response by boosting a particular frequency to enhance a desired CW signal.

The peak frequency can be adjusted with [DIGI-SEL] control when “APF” is selected for “DIGI-SEL VR Operation” in the Others set mode (p. 12-18).

The APF audio level can be adjusted in the Level set mode (p. 12-5).

The audio filter shape is also selectable from “SOFT” and “SHARP” in the Others set mode (p. 12-19).

- ① During CW mode, push [APF/TPF] to turn the audio peak filter ON or OFF.
 - “APF” appears in the display and [APF/TPF] indicator above this switch lights green.
- ② Hold down [APF/TPF] for 1 second several times to select the desired audio filter width.
 - WIDE, MID and NAR filters, or, 320, 160 and 80 Hz filters are available depending on APF type setting in the Others set mode.
- ③ If “APF” is selected for “DIGI-SEL VR Operation,” rotate [DIGI-SEL] control to suit your preference.

◇ About 137 kHz band operation (Europe, UK, Italy, Spain, France versions only)

137 kHz band, within the 135.7 kHz to 137.8 kHz range, operation in CW mode is optionally available with the IC-7800.

The RF signal from [X-VERTER] is used for the 137 kHz band operation, and an external amplifier unit is necessary.

See the connection diagram below for reference.

• Connection diagram for 137 kHz band operation

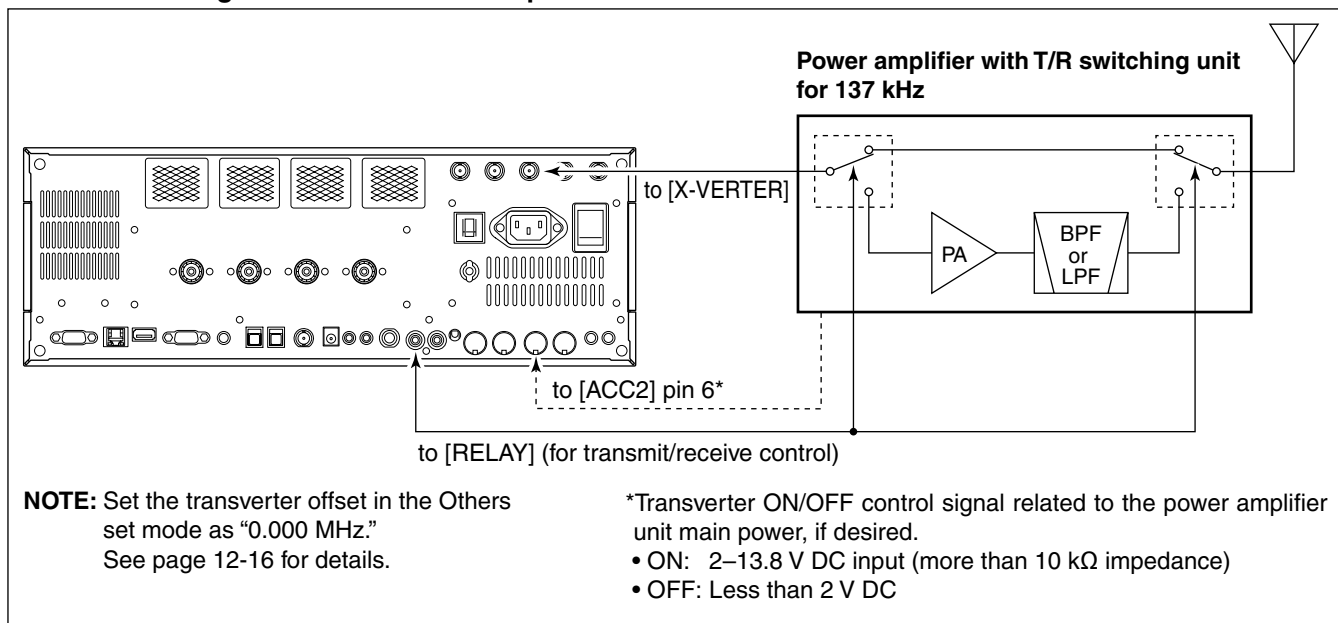

Electronic keyer functions

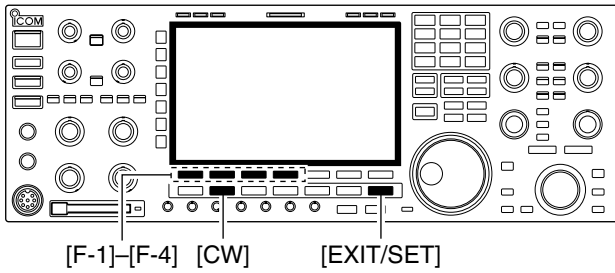

The IC-7800 has a number of convenient functions for the built-in electronic keyer.

- ① During CW mode, push [EXIT/SET] several times to normal screen, if necessary.
- ② Push [F-3•KEYER] to select memory keyer screen.
- ③ Push [EXIT/SET] to select memory keyer menu screen.
- ④ Push one of the multi-function keys ([F-1] to [F-4]) to select the desired menu. See the diagram below.
 - Push [EXIT/SET] to return to the previous display.



• Memory keyer screen (p. 4-8)



• Memory keyer edit screen (p. 4-9)

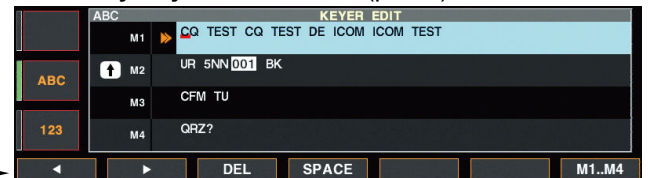

• Memory keyer menu screen

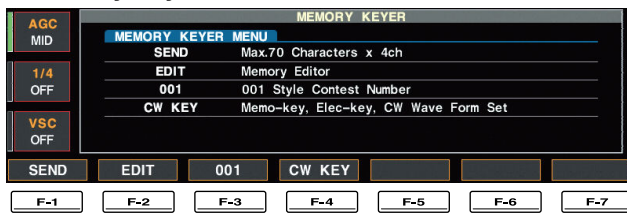

• Contest number set mode (p. 4-10)



• Keyer set mode screen (p. 4-11)

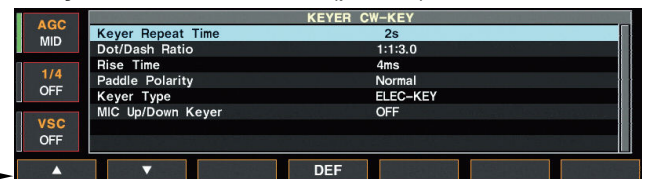

◇ Memory keyer screen

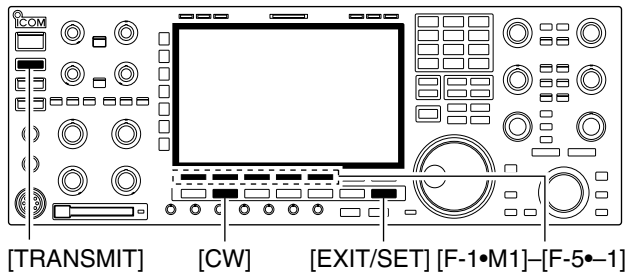

• Memory keyer screen



Preset characters can be sent using the keyer send menu. Contents of the memory keyer are set using the edit menu.

• Transmitting

- ① During CW mode operation, push [F-3•KEYER] to select memory keyer screen.
- ② Push [TRANSMIT] to set the transceiver to transmit, or set the break-in function ON (p. 6-3).
- ③ Push one of the function keys ([F-1•M1] to [F-4•M4]) to send the contents of the memory keyer.
 - Holding down a function key for 1 second repeatedly sends the contents; push any function key to cancel the transmission.
 - The contest serial number counter is increment each time the contents are sent.
 - Push [F-5•-1] to reduce the contest serial number count by 1 when resending contents to unanswered calls.

✓ For your convenience

When an external keypad or PC keyboard is connected, the programmed contents, M1 to M4, can be transmitted without selecting the memory keyer screen.

See pages 2-6, 2-10 and 12-20 for details.

- The programmed contents, M1 to M4 is transmitted once when pushing one of four switches on the external keypad momentarily; the programmed contents are transmitted repeatedly when holding down a switch.
- The programmed contents, M1 to M4 is transmitted once when pushing one of [F1] to [F4] key on the PC keyboard; the programmed contents is transmitted repeatedly when pushing a key while holding down [SHIFT] key.

- ④ Push [EXIT/SET] twice to return to normal screen.

◇ Editing a memory keyer

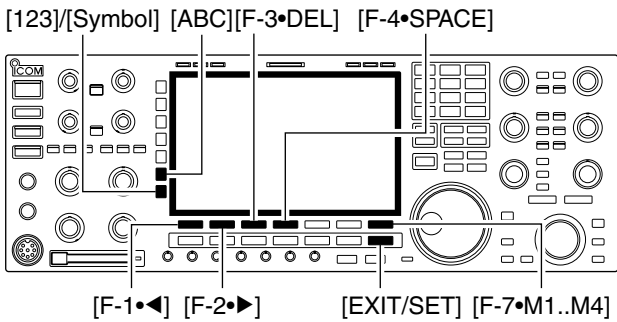

• Memory keyer edit screen

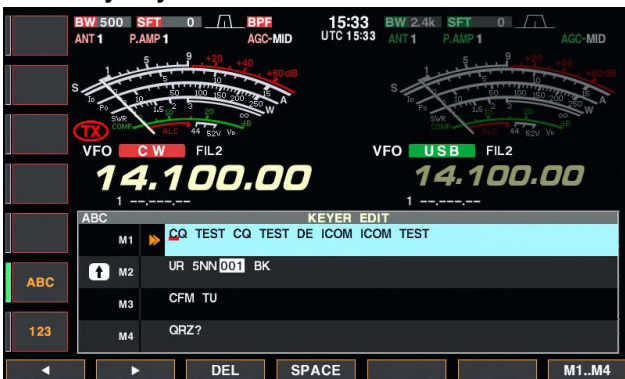

• Example— entered “QSL TU DE JA3YUA TEST” into memory keyer channel 3



• Pre-programmed contents

CH	Contents
M1	CQ TEST CQ TEST DE ICOM ICOM TEST
M2	UR 5NN* BK
M3	CFM TU
M4	QRZ?

The contents of the memory keyer memories can be set using the memory keyer edit menu. The memory keyer can memorize and retransmit four CW key codes for often-used CW sentences, contest serial numbers, etc. Total capacity of the memory keyer is 70 characters per memory channel.

• Programming contents

- ① During CW mode operation, push [F-3•KEYER] to select memory keyer screen.
- ② Push [EXIT•SET] to select memory keyer menu, then push [F-2•EDIT] to select keyer edit screen.
 - Memory keyer contents of Channel 1 (M1) is selected.
- ③ Push [F-7•M1..M4] several times to select the desired memory keyer channel to be edited.
- ④ Push [ABC] or [123] or [Symbol] to select the character group, then rotate the main dial to select the character, or push the keypad for number input.
 - [Symbol] appears when [123] is pushed when “123” character group is selected.

Key selection	Editable characters
ABC	A to Z (capital letters)
123	0 to 9 (numbers)
Symbol	/ ? ^ . , @ *

NOTE:

“^” is used to transmit a following word with no space such as AR. Put “^” before a text string such as ^AR, and the string “AR” is sent with no space.

“*” is used to insert the CW contest serial number. The serial number automatically increments by 1. This function is only available for one memory keyer channel at a time. Memory keyer channel M2 used “*” by default.

✓ For your convenience

When a PC keyboard is connected to [KEYBOARD] connector on the rear panel, the memory keyer contents can also be edited from the keyboard.

- ⑤ Push [F-1•◀] or [F-2•▶] to move the cursor backwards or forwards, respectively.
 - Pushing [F-3•DEL] deletes a character and [F-4•SPACE] inserts a space.
- ⑥ Repeat steps ④ and ⑤ to input the desired characters.
- ⑦ Push [EXIT/SET] twice to return normal screen.

◇ Contest number set mode

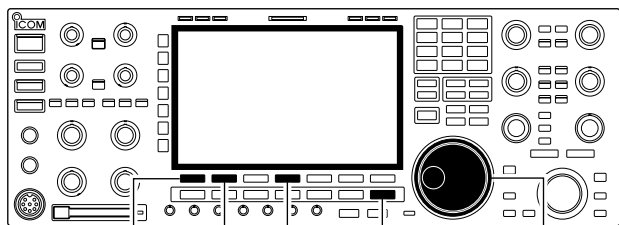

[F-1•▲] [F-2•▼] [F-4•DEF] [EXIT/SET] Main dial

This menu is used to set the contest (serial) number and count up trigger, etc.

• Setting contents

- ① During CW mode operation, push [F-3•KEYER] to select memory keyer screen.
- ② Push [EXIT•SET] to select memory keyer menu, then push [F-3•001] to select contest serial number set mode.
- ③ Push [F-1•▲] or [F-2•▼] to select the desired set item.
- ④ Set the desired condition using the main dial.
 - Hold down [F-4•DEF] for 1 second to select the default condition or value.
- ⑤ Push [EXIT/SET] twice to normal screen.

• Contest number set mode screen



Number Style	Normal
This item sets the numbering system used for contest (serial) numbers— normal or short morse numbers.	<ul style="list-style-type: none"> • Normal : Does not use short morse numbers (default) • 190→ANO : Sets 1 as A, 9 as N and 0 as O. • 190→ANT : Sets 1 as A, 9 as N and 0 as T. • 90→ NO : Sets 9 as N and 0 as O. • 90→ NT : Sets 9 as N and 0 as T.

Count Up Trigger	M2
This selects which of the four memories will contain the contest serial number exchange. The count-up trigger allows the serial number to automatically incremented after each complete serial number exchange is sent.	<ul style="list-style-type: none"> • M1, M2, M3 and M4 can be set. (default: M2)

Present Number	001
This item shows the current number for the count-up trigger channel set above.	<ul style="list-style-type: none"> • Rotate the main dial to change the number, or hold down [F-3•001CLR] for 1 second to reset the current number to 001.

◇ **Keyer set mode**

This set mode is used to set the memory keyer repeat time, dash weight, paddle specifications, keyer type, etc.

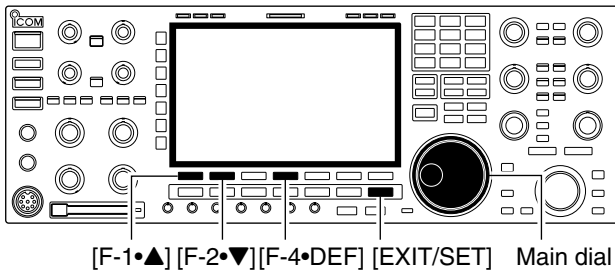

• **Setting contents**

- ① During CW mode operation, push [F-3•KEYER] to select memory keyer screen.
- ② Push [EXIT•SET] to select memory keyer menu, then push [F-4•CW KEY] to select keyer set mode.
- ③ Push [F-1•▲] or [F-2•▼] to select the desired set item.
- ④ Set the desired condition using the main dial.
 - Hold down [F-4•DEF] for 1 second to select the default condition or value.
- ⑤ Push [EXIT/SET] twice to normal screen.

• **Keyer set mode screen**



Keyer Repeat Time	2s
When sending CW using the repeat timer, this item sets the time between transmission.	• 1 to 60 seconds in 1 second steps can be selected. (default: 2 seconds)

Dot/Dash Ratio	1:1:3.0
This item sets the dot/dash ratio.	• 1:1:2.8 to 1:1:4.5 (in 0.1 steps) can be selected. (default: 1:1:3.0)
Keying weight example: Morse code "K"	

Rise Time	4ms
This item sets the rise time of the transmitted CW envelope.	• 2, 4, 6 or 8 milliseconds can be selected. (default: 4 milliseconds)
<p>• About rise time</p>	

to be continued...

◇ Keyer set mode (continued)

Paddle Polarity	Normal
This item sets the paddle polarity.	• Normal and reverse polarity can be selected.

Keyer Type	ELEC-KEY
This item selects the keyer type for [ELEC-KEY] connector on the front panel.	• ELEC-KEY, BUG-KEY and Straight key can be selected. (default: ELEC-KEY)

MIC Up/Down Keyer	OFF
This item allows you to set the microphone [UP]/[DN] keys to be used as a paddle.	<ul style="list-style-type: none">• ON : [UP]/[DN] switches can be used for CW.• OFF : [UP]/[DN] switches cannot be used for CW. <p>NOTE: When “ON” is selected, the frequency and memory channel cannot be changed using the [UP]/[DN] switches.</p>

■ Operating RTTY (FSK)

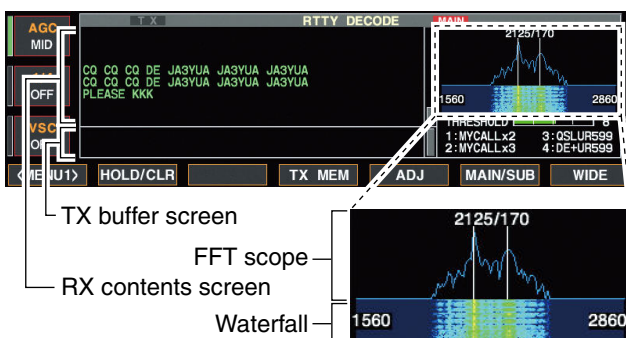
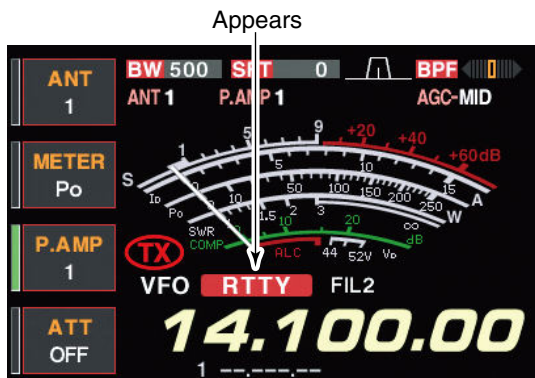
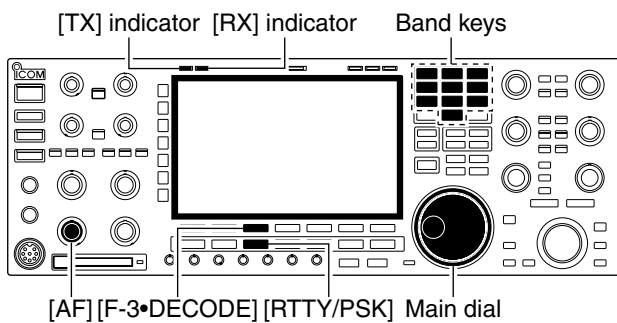

A DSP-based high-quality Baudot RTTY encoder/decoder is built-in to the IC-7800. When connecting a PC keyboard (p. 2-6), you can operate RTTY without an external RTTY terminal or PC. If you would rather use your RTTY terminal, consult the manual that comes with the RTTY terminal.

- ① Push a band key to select the desired band.
- ② Push [RTTY/PSK] to select RTTY.
 - After RTTY mode is selected, hold down [RTTY/PSK] for 1 second to toggle between RTTY and RTTY-R modes.
 - “RTTY” or “RTTY-R” appears.
- ③ Push [F-3•DECODE] to display the decoder screen.
 - The IC-7800 has a built-in Baudot decoder.
- ④ Rotate the main dial to tune the desired signal.
 - Aim for a symmetrical waveform, and ensure the peak points align with the mark (2125 Hz) and shift (170 Hz) frequency lines in the FFT scope.
 - The S-meter indicates received signal strength when signal is received.
- ⑤ Push [F12] on the connected keyboard to transmit.
 - [TX] indicator lights red.
- ⑥ Type from the keyboard to enter the contents that you want to transmit.
 - The typewritten contents are indicated in the TX buffer screen and transmitted immediately.
 - The text color will be changed when transmitted.
 - Push one of [F1]–[F8] to transmit the TX memory contents.
- ⑦ Push [F12] on the keyboard to return to receive.

✓ For your convenience

The transmission contents can be typed before being transmitted.

- ① Perform the steps ① to ④ above.
- ② Type from the connected keyboard to enter the message that you want to transmit.
 - The typewritten contents are indicated in the TX buffer screen.
- ③ Push [F12] of the connected keyboard to transmit the typewritten contents.
 - The color of displayed text, in the TX buffer screen, will be changed when transmitted.
 - To cancel the transmission, push [F12] twice.
- ④ Push [F12] of the keyboard to return to receive.

◇ Convenient functions for receive

- **Preamp** (p. 5-10)
 - ➔ Push [P.AMP] several times to set the preamp OFF, preamp 1 ON or preamp 2 ON.
 - “P.AMP1” or “P.AMP2” appears when the preamp 1 or preamp 2 is ON. Main and sub have independent preamp controls.
- **Attenuator** (p. 5-10)
 - ➔ Push [ATT] several times to set the attenuator in 6 dB steps.
 - Hold down [ATT] for 1 second to set the attenuator in 3 dB steps.
 - “ATT” and attenuation level appear when the attenuator is ON.
- **Noise blanker** (p. 5-18)
 - ➔ Push [NB] switch to turn the noise blanker ON or OFF, and then rotate [NB] control to adjust the threshold level.
 - Noise blanker indicator (above [NB] switch) lights when the noise blanker is ON.
 - Hold down [NB] for 1 second to enter the noise blanker set mode.
- **Twin PBT (passband tuning)** (p. 5-13)
 - ➔ Rotate [TWIN PBT] controls (inner/outer).
 - Hold down [PBT CLEAR] for 1 second to clear the settings.
- **Noise reduction** (p. 5-19)
 - ➔ Push [NR] switch to turn the noise reduction ON or OFF.
 - Rotate [NR] control to adjust the noise reduction level.
 - Noise reduction indicator (above [NR] switch) lights when the noise reduction is ON.
- **Notch filter** (p. 5-20)
 - ➔ Push [NOTCH] switch to turn the manual notch function ON or OFF.
 - Rotate [NOTCH] control to set the attenuating frequency.
 - Notch indicator (above [NOTCH] switch) lights when either the auto or manual notch is ON.
- **AGC (auto gain control)** (p. 5-12)
 - ➔ Push [AGC] switch several times to select AGC FAST, AGC MID or AGC SLOW.
 - ➔ Push [AGC VR] to turn the AGC time constant manual setting ON or OFF.
 - Rotate [AGC] control to adjust the time constant.
- **1/4 function** (p. 3-6)
 - ➔ Push [1/4] to turn the 1/4 function ON or OFF.

◇ About RTTY reverse mode

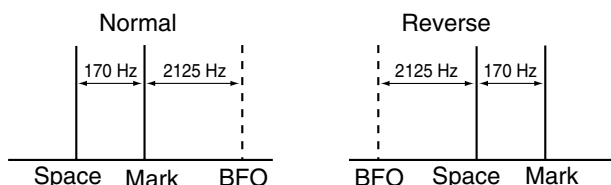

Received characters are occasionally garbled when the received signal has Mark and Space tones reversed. This reversal can be caused by incorrect TNC connections, setting, commands, etc. To receive reversed RTTY signals correctly, select RTTY-R mode.

- ➔ During RTTY mode, hold down [RTTY/PSK] for 1 second to select RTTY and RTTY-R mode.

◇ Twin peak filter

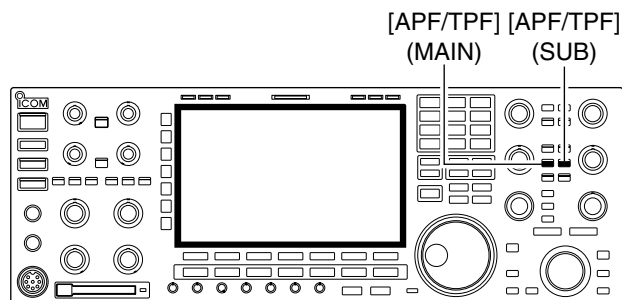

The twin peak filter changes audio frequency response by boosting the mark and space frequencies (2125 and 2295 Hz) for better reception of RTTY signals.

- ➔ During RTTY mode, push [APF/TPF] to turn the twin peak filter ON or OFF.
 - “TPF” appears in the LCD and the [APF/TPF] indicator above this switch lights green while the filter is in use.

NOTE: When the twin peak filter is in use, the received audio output may increase. This is a normal, not a malfunction.

◇ Functions for the RTTY decoder indication



- ① Push a band key to select the desired band.
- ② Push [RTTY/PSK] to select RTTY.
 - After RTTY mode is selected, hold down [RTTY/PSK] for 1 second to toggle between RTTY and RTTY-R modes.
 - “RTTY” or “RTTY-R” appears.
- ③ Push [F-3•DECODE] to display the decoder screen.
 - When tuned into an RTTY signal, decoded characters are displayed in the RX contents screen.
- ④ Push [F-2•HOLD/CLR] to freeze the current screen.
 - “HOLD” appears while the function is in use.
 - Push [F-2•HOLD/CLR] again to release the function.
- ⑤ Hold down [F-2•HOLD/CLR] for 1 second to clear the displayed characters.
 - “HOLD” indicator disappears at the same time as the displayed characters are cleared. (The hold function is cancelled.)
- ⑥ Push [F-7•WIDE] to toggle the RTTY decode screen size from normal and wide.
 - S/RF meter type during wide screen indication can be selected in display set mode. (pp. 3-11, 12-11)
- ⑦ Push [F-6•MAIN/SUB] to toggle the MAIN and SUB band for decode operation.
 - Dualwatch function (p. 5-17) should be ON when SUB band is selected for decode operation.
- ⑧ Push [EXIT/SET] to close the RTTY decode screen.

• Wide screen indication



◇ Setting the decoder threshold level



Adjust the RTTY decoder threshold level if some characters are displayed when no signal is received.

- ① Select the RTTY decoder screen as described above.
- ② Push [F-5•ADJ] to select the threshold level setting condition.
- ③ Rotate the main dial to adjust the RTTY decoder threshold level.
 - Hold down [F-6•DEF] for 1 second to select the default setting.
- ④ Push [F-5•ADJ] to exit from the threshold level setting condition.

▨ The UnShift On Space (USOS) function and new line code can be set in the RTTY set mode. (p. 4-18)

◇ RTTY memory transmission

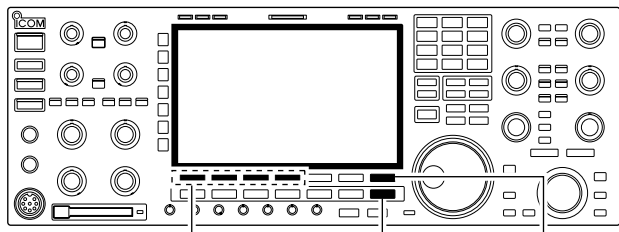

[F-1•RT1]–[F-4•RT4] [EXIT/SET] [F-7•1–4/5–8]
[F-1•RT5]–[F-4•RT8]

RTTY MEMORY				
AGC MID	RT1	MYCALLx2	„DE ICOM ICOM K,“	AUTO TX/RX
1/4 OFF	RT2	MYCALLx3	„DE ICOM ICOM ICOM K,“	AUTO TX/RX
VSC OFF	RT3	QSLUR599	„QSL UR 599–599 BK,“	AUTO TX/RX
	RT4	DE+UR599	„QSL DE ICOM ICOM UR 599–599 BK,“	AUTO TX/RX
	RT1	RT2	RT3	RT4
			EDIT	1–4/5–8

Pre-set characters can be sent using the RTTY memory. Contents of the memory are set using the edit menu.

- ① During RTTY mode operation, push [F-3•DECODE] to select RTTY decode screen.
- ② Push [F-4•TX MEM] to select RTTY memory screen.
- ③ Push [F-7•1–4/5–8] to select memory bank then push one of the function keys ([F-1•RT1] to [F-4•RT4] or [F-1•RT5] to [F-4•RT8]).
 - When no keyboard is connected, the selected memory contents will be transmitted immediately.
 - When a keyboard is connected, the memory contents will be transmitted immediately when function key is pushed, or transmitted after [F12] on the connected keyboard is pushed, depending on auto transmission/reception setting (see below).
 - The transmission date, time, reception date and/or time may be displayed in RX contents screen, depending on setting.

✓ **For your convenience**

When an external keypad is connected, one of RT1 to RT4 RTTY memory contents can be transmitted while the RTTY decoder screen is selected in RTTY mode. See pages 2-6, 2-10 and 12-20 for details.

◇ Automatic transmission/reception setting

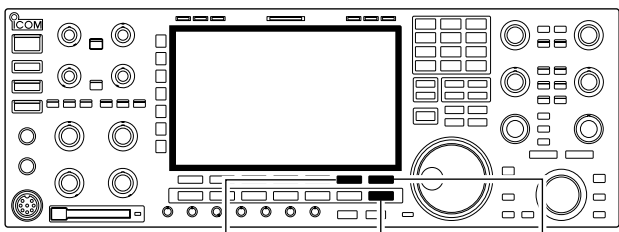

[F-6•AUTO TX] [EXIT/SET] [F-7•RT1..RT8]

RTTY MEMORY EDIT				
ABC	RT1	MYCALLx2	„DE ICOM ICOM K,“	AUTO TX/RX
ABC	RT2	MYCALLx3	„DE ICOM ICOM ICOM K,“	AUTO TX/RX
	RT3	QSLUR599	„QSL UR 599–599 BK,“	AUTO TX/RX
123	RT4	DE+UR599	„QSL DE ICOM ICOM UR 599–599 BK,“	AUTO TX/RX
	←	→	DEL	SPACE
			←	→
			AUTO TX	RT1..RT8

- ① During RTTY mode operation, push [F-3•DECODE] to select RTTY decode screen.
- ② Push [F-4•TX MEM] to select RTTY memory screen, then push [F-6•EDIT] to select RTTY memory edit screen.
 - RTTY memory contents of the Channel 1 (RT1) is selected.
- ③ Push [F-7•RT1..RT8] several times to select the desired RTTY memory.
- ④ Push [F-6•AUTO TX] several times to select the desired condition as follow.
 - **AUTO TX/RX** : Automatically transmits the selected memory and returns to receive after the transmission.
 - **AUTO TX** : Automatically transmits the selected memory. To return to receive, push [F12] on the keyboard.
 - **AUTO RX** : Push [F12] on the keyboard to transmit the selected memory. Automatically returns to receive after the transmission.
 - **No indication** : Push [F12] on the keyboard to transmit the selected memory and push [F12] again to return to receive.
- ⑤ Push [EXIT/SET] to exit RTTY memory edit condition.

NOTE: The transceiver always functions as the “AUTO TX/RX” setting when no keyboard is connected.

◇ Editing RTTY memory

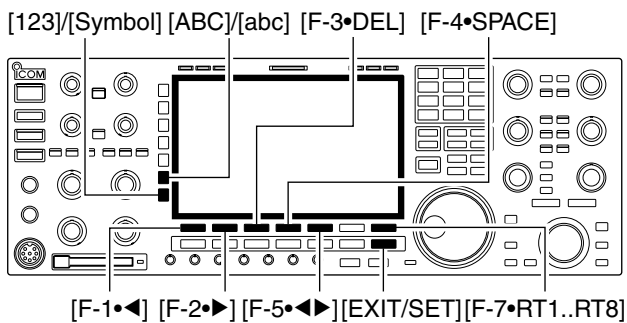

• RTTY memory edit screen



• Pre-programmed contents

CH	Name	Contents
RT1	MYCALLx2	↓DE ICOM ICOM K↓
RT2	MYCALLx3	↓DE ICOM ICOM ICOM K↓
RT3	QSLUR599	↓QSL UR 599-599 BK↓
RT4	DE+UR599	↓QSL DE ICOM ICOM UR 599-599 BK↓
RT5	73 GL SK	↓73 GL SK↓
RT6	CQ CQ CQ	↓CQ CQ CQ DE ICOM ICOM ICOM K↓
RT7	RIG&ANT	↓MY TRANSCEIVER IS IC-7800 & ANTENNA IS A 3-ELEMENT TRIBAND YAGI.↓
RT8	EQUIP.	↓MY RTTY EQUIPMENT IS INTERNAL FSK UNIT & DEMODULATOR OF THE IC-7800. ↓

The contents of the RTTY memories can be set using the memory edit menu. The memory can store and re-transmit 8 RTTY message for often-used RTTY information. Total capacity of the memory is 70 characters per memory channel.

• Programming contents

- ① During RTTY mode operation, push [F-3•DECODE] to select RTTY decode screen.
- ② Push [F-4•TX MEM] to select RTTY memory screen, then push [F-6•EDIT] to select RTTY memory edit screen.
 - RTTY memory contents of the Channel 1 (RT1) is selected.
- ③ Push [F-7•RT1..RT8] to several times to select the desired RTTY memory channel to be edited.
- ④ Push [F-5•◀ ▶] to select the edit item between memory contents and memory name.
 - [abc] appears when [ABC] is pushed when “ABC” character group is selected, and [Symbol] appears when [123] is pushed when “123” character group is selected.
 - Selectable characters (with the main dial);

Key selection	Editable characters
	A to Z (capital letters)
	a to z (small letters) (selectable for memory name only)
	0 to 9 (numbers)
	! # \$ % & ¥ ? “ ’ ` ^ + - * / . , ; = < > () [] { } _ ~ @ (For the memory contents setting, ! \$ & ? “ ’ - / . , ; () ↓ are selectable.)

✓ For your convenience

When a PC keyboard is connected to [KEYBOARD] connector on the rear panel, the RTTY memory contents can also be edited from the keyboard.

- ⑥ Push [F-1•◀] or [F-2•▶] to move the cursor backwards or forwards, respectively.
 - Pushing [F-3•DEL] deletes a character and [F-4•SPACE] inserts a space.
- ⑦ Repeat steps ⑤ and ⑥ to input the desired characters.
- ⑧ Push [EXIT/SET] to set the contents and exit RTTY memory edit screen.

◇ RTTY decode set mode

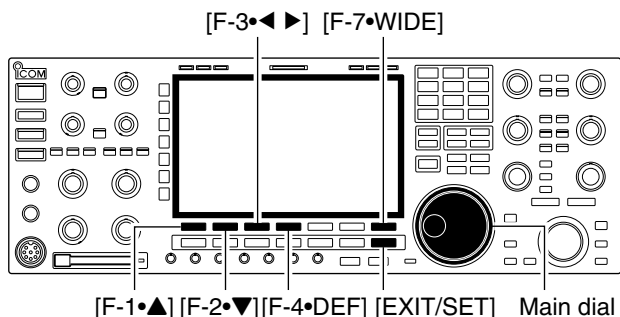

This set mode is used to set the decode USOS function, time stamp setting, etc.

• Setting contents

- ① During RTTY mode operation, push [F-3•DECODE] to select RTTY decode screen.
- ② Push [F-1•<MENU2>] to select RTTY decode menu 2, then push [F-6•SET] to select RTTY decode set mode.
 - Push [F-7•WIDE] to toggle the screen size from normal and wide.
- ③ Push [F-1•▲] or [F-2•▼] to select the desired set item.
- ④ Set the desired condition using the main dial.
 - Hold down [F-4•DEF] for 1 second to select a default condition or value.
 - Push [F-3•◀▶] to select the set contents for some items.
- ⑤ Push [EXIT/SET] to exit from set mode.

• RTTY decode set mode screen



RTTY FFT Scope Averaging	OFF
Set the FFT scope waveform averaging function from 2 to 4 and OFF. (default: OFF)	Recommendation! If you use the FFT scope waveform for tuning, use the default or smaller number setting is recommended.





RTTY FFT Scope Waveform Color	 51 153 255
Set the color for the FFT scope waveform. <ul style="list-style-type: none"> • The color is set in RGB format. • The set color is indicated in the box beside the RGB scale. 	<ul style="list-style-type: none"> • Push [F-3•◀▶] to select R (Red), G (Green) and B (Blue), and then rotate the main dial to set the ratio from 0 to 255.

RTTY Decode USOS	ON
Turn the letter code decoding after receiving a "space" (USOS; UnShift On Space function) capability ON or OFF.	<ul style="list-style-type: none"> • ON : Decode as letter code. • OFF : Decode as character code.

RTTY Decode New Line Code	CR,LF,CR+LF
Selects the new line code of the internal RTTY decoder. CR: Carriage Return, LF: Line Feed	<ul style="list-style-type: none"> • CR,LF,CR+LF: Makes new line with any codes. • CR+LF : Makes new line with CR+LF code only.

RTTY Diddle	BLANK
Selects the diddle condition.	<ul style="list-style-type: none"> • BLANK : Transmits blank code during no code transmission. • LTRS : Transmits letter code during no code transmission. • OFF : Turns the diddle function OFF.

◇ RTTY decode set mode (continued)

<p>RTTY TX USOS</p> <p>Explicitly inserts the FIGS character even though it is not required by the receiving station.</p>	<p>ON</p> <ul style="list-style-type: none"> • ON : Inserts FIGS. • OFF : Does not insert FIGS.
<p>RTTY Time Stamp</p> <p>Turn the time stamp (date, transmission or reception time) indication ON or OFF.</p>	<p>ON</p> <ul style="list-style-type: none"> • ON : Displays the time stamp. • OFF : No time stamp indication.
<p>RTTY Auto CR+LF by TX</p> <p>Selects the automatic new line code (CR+LF) transmission capability.</p>	<p>ON</p> <ul style="list-style-type: none"> • ON : Transmits CR+LF code once. • OFF : Transmits no CR+LF code.
<p>RTTY Time Stamp (Time)</p> <p>Selects the clock indication for time stamp usage.</p> <p>NOTE: The time won't be displayed when "OFF" is selected in "RTTY Time Stamp" as above.</p>	<p>Local</p> <ul style="list-style-type: none"> • Local : Selects the time that set in "Time (Now)." • UTC* : Selects the time that set in "CLOCK2." <p>*The name of choice may differ according to "CLOCK2 Name" setting (p, 11-2). "UTC" is the default name of CLOCK2.</p>
<p>RTTY Time Stamp (Frequency)</p> <p>Selects the operating frequency indication for time stamp usage.</p> <p>NOTE: The frequency won't be displayed when "OFF" is selected in "RTTY Time Stamp" as above.</p>	<p>OFF</p> <ul style="list-style-type: none"> • ON : Displays the operating frequency. • OFF : No operating frequency display.
<p>RTTY Font Color (Receive)</p> <p>Set the text color for received characters.</p> <ul style="list-style-type: none"> • The color is set in RGB format. • The set color is indicated in the box beside the RGB scale. 	<p> 128 255 128</p> <ul style="list-style-type: none"> • Push [F-3•◀▶] to select R (Red), G (Green) and B (Blue), and then rotate the main dial to set the ratio from 0 to 255.
<p>RTTY Font Color (Transmit)</p> <p>Set the text color for transmitted characters.</p> <ul style="list-style-type: none"> • The color is set in RGB format. • The set color is indicated in the box beside the RGB scale. 	<p> 255 106 106</p> <ul style="list-style-type: none"> • Push [F-3•◀▶] to select R (Red), G (Green) and B (Blue), and then rotate the main dial to set the ratio from 0 to 255.
<p>RTTY Font Color (Time Stamp)</p> <p>Set the text color for time stamp indication.</p> <ul style="list-style-type: none"> • The color is set in RGB format. • The set color is indicated in the box beside the RGB scale. 	<p> 0 155 189</p> <ul style="list-style-type: none"> • Push [F-3•◀▶] to select R (Red), G (Green) and B (Blue), and then rotate the main dial to set the ratio from 0 to 255.
<p>RTTY Font Color (TX Buffer)</p> <p>Set the text color in the TX buffer screen.</p> <ul style="list-style-type: none"> • The color is set in RGB format. • The set color is indicated in the box beside the RGB scale. 	<p> 255 255 255</p> <ul style="list-style-type: none"> • Push [F-3•◀▶] to select R (Red), G (Green) and B (Blue), and then rotate the main dial to set the ratio from 0 to 255.

◇ Data saving

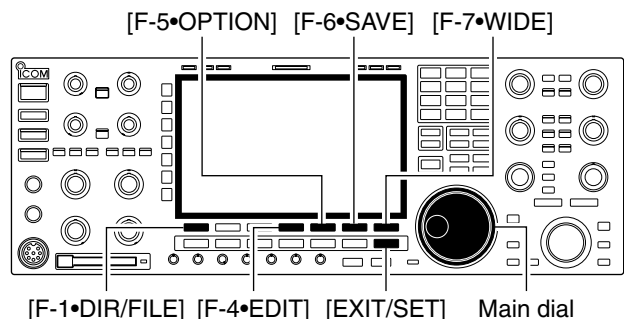

• Decode file save screen



• Decode file save screen— file name edit

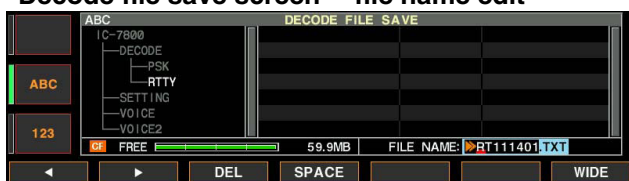

• Save option screen

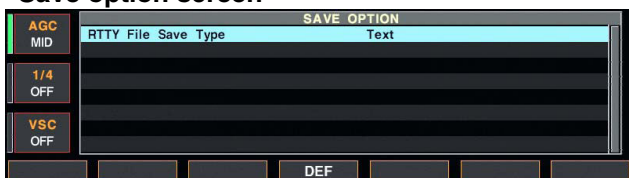

✓ For your convenience!

Two formats, Text and HTML, are selectable for storage of data to your PC.

The contents of the RTTY memory and received signal can be saved into the CF memory card or USB flash drive.

- ① During RTTY decode screen, push [F-1•<MENU1>] to select RTTY decode menu 2.
- ② Push [F-5•SAVE] to select decode file save screen.
- ③ Change the following settings, if desired.

• File name:

- ① Push [F-4•EDIT] to select file name edit condition.
 - Push [F-1•DIR/FILE] several times to select the file name, if necessary.
- ② Push [ABC], [123] or [Symbol] to select the character group, then rotate the main dial to select the character.
 - [ABC] : A to Z (capital letters); [123]: 0 to 9 (numerals); [Symbol]: ! # \$ % & ' ` ^ + - = () [] { } _ ~ @ can be selected.
 - Push [F-1•◀] to move the cursor left, push [F-2•▶] to move the cursor right, [F-3•DEL] delete a character and push [F-4•SPACE] to insert a space.
- ③ Push [EXIT/SET] to set the file name.

• File format

- ① Push [F-5•OPTION] to enter save option screen.
- ② Rotate the main dial to select the saving format from Text or HTML.
 - “Text” is the default setting.
 - Hold down [F-4•DEF] for 1 second to select the default setting.
- ③ Push [EXIT/SET] to return to the previous indication.

• Saving location

- ① Hold down [F-1•DIR/FILE] for 1 second to select the CF memory card or USB flash drive.
- ② Push [F-1•DIR/FILE] to select tree view screen.
- ③ Select the desired directory or folder in the selected memory device.
 - Push [F-4•◀ ▶] to select the upper directory.
 - Push [F-2•▲] or [F-3•▼] to select folder in the same directory.
 - Hold down [F-4•◀ ▶] for 1 second to select a folder in the directory.
 - Push [F-5•REN/DEL] to rename the folder.
 - Hold down [F-5•REN/DEL] for 1 second to delete the folder.
 - Hold down [F-6•MAKE] for 1 second to making a new folder. (Edit the name with the same manner as the “• File name” above.)
- ④ Push [F-1•DIR/FILE] twice to select the file name.

- ④ Push [F-6•SAVE].
 - After the saving is completed, automatically returns to RTTY decode menu 2.

■ Operating PSK

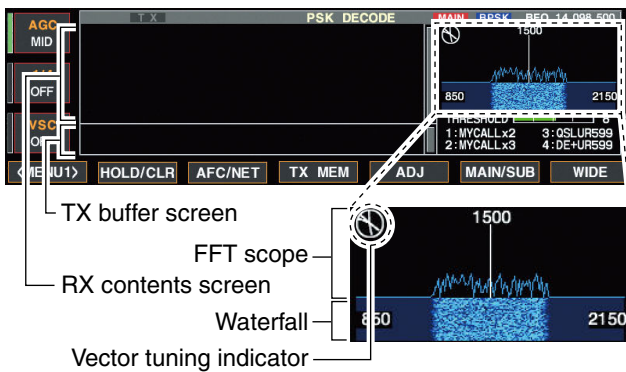
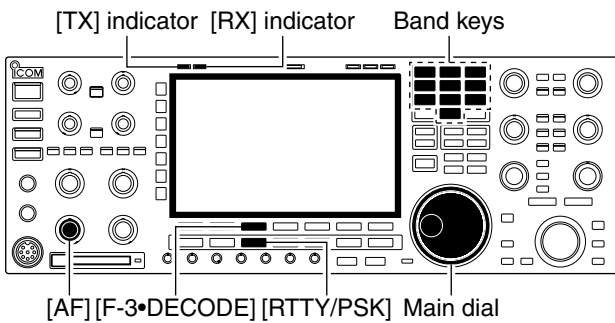

• Vector tuning indicator indication example

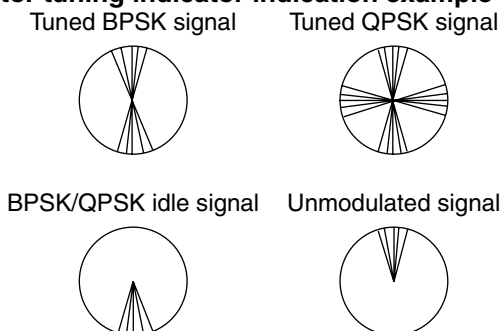

A high-quality DSP-based PSK31 encoder/decoder is built-in to the IC-7800. When connecting a PC keyboard (p. 2-6), PSK31 operation can be performed without PSK software installed on your PC.

If desired, you can also use your PSK software; consult the manual that comes with the software.

- ① Push a band key to select the desired band.
- ② Push [RTTY/PSK] to select PSK.
 - After PSK mode is selected, hold down [RTTY/PSK] for 1 second to toggle between PSK and PSK-R modes.
 - “PSK” or “PSK-R” appears.
- ③ Push [F-3•DECODE] to display the decoder screen.
 - The IC-7800 has a built-in PSK31 decoder.
- ④ Tune the desired signal with the main dial.
 - The signal is properly tuned when the radiated lines in the vector tuning indicator narrow, as show in the example below.
 - The radiated lines in the vector tuning indicator may be displayed sporadically.
 - When a PSK signal is received, the waterfall display is activated.
 - The waterfall display shows the signal condition within the passband and a vertical line appears when a PSK signal is received.
- ⑤ Push [F12] of the connected keyboard to transmit.
 - [TX] indicator lights red.
- ⑥ Type from the connected keyboard to enter the message that you want to transmit.
 - The typewritten contents are indicated in the TX buffer screen and transmitted immediately.
 - The text color will be changed when transmitted.
 - Push one of [F1]–[F8] to transmit the TX memory contents.
- ⑦ Push [F12] of the keyboard to return to receive.

✓ For your convenience

The transmission contents can be typed before being transmitted.

- ① Perform the steps ① to ④ above.
- ② Type from the connected keyboard to enter the message that you want to transmit.
 - The message is shown in the TX buffer screen.
- ③ Push [F12] of the connected keyboard to transmit the message.
 - The color of displayed text, in the TX buffer screen, will be changed when transmitted.
 - To cancel the transmission, push [F12] twice.
- ④ Push [F12] of the keyboard to return to receive.

◇ Convenient functions for receive

- **Preamp** (p. 5-10)
 - ➔ Push [P.AMP] several times to set the preamp OFF, preamp 1 ON or preamp 2 ON.
 - “P.AMP1” or “P.AMP2” appears when the preamp 1 or preamp 2 is ON. Main and sub have independent preamp controls.
- **Attenuator** (p. 5-10)
 - ➔ Push [ATT] several times to set the attenuator in 6 dB steps.
 - Hold down [ATT] for 1 second to set the attenuator in 3 dB steps.
 - “ATT” and attenuation level appear when the attenuator is ON.
- **Noise blanker** (p. 5-18)
 - ➔ Push [NB] switch to turn the noise blanker ON or OFF, and then rotate [NB] control to adjust the threshold level.
 - Noise blanker indicator (above [NB] switch) lights when the noise blanker is ON.
 - Hold down [NB] for 1 second to enter noise blanker set mode.
- **Twin PBT (passband tuning)** (p. 5-13)
 - ➔ Rotate [TWIN PBT] controls (inner/outer).
 - Hold down [PBT CLEAR] for 1 second to clear the settings.
- **Noise reduction** (p. 5-19)
 - ➔ Push [NR] switch to turn the noise reduction ON or OFF.
 - Rotate [NR] control to adjust the noise reduction level.
 - Noise reduction indicator (above [NR] switch) lights when the noise reduction is ON.
- **AGC (auto gain control)** (p. 5-12)
 - ➔ Push [AGC] switch several times to select AGC FAST, AGC MID or AGC SLOW.
 - Rotate [AGC] control to adjust the time constant.
 - ➔ Push [AGC VR] to turn the AGC time constant manual setting ON or OFF.
- **Fine tuning** (p. 3-7)
 - ➔ During PSK, make sure that the kHz tuning step function is OFF (no “▼” indication), hold down [TS] for 1 second.
 - PSK may not be decoded correctly using the 10 Hz step tuning.
- **1/4 function** (p. 3-6)
 - ➔ Push [1/4] to turn the 1/4 function ON or OFF.

● About the 5 MHz frequency band operation (USA version only)

See page 4-3 for details.

◇ About BPSK and QPSK mode

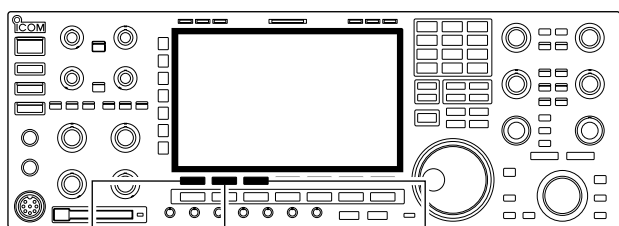

[F-1]•<MENU1> [F-2]•B/QPSK [F-3]•DECODE

• PSK decode screen— BPSK mode



• PSK decode screen— QPSK mode



BPSK and QPSK modes are available for PSK31.

- BPSK (Binary Phase Shift Keying) mode is the most commonly used mode.
- QPSK (Quadrature Phase Shift Keying) mode has error correction capability to provide better decoding than BPSK mode in marginal condition. However, more accurate tuning is required with QPSK mode, due to the tight phase margin of QPSK.

- ① During PSK mode selection, push [F-3]•DECODE] to display the PSK decode screen.
- ② Push [F-1]•<MENU1>] to select PSK decode menu 2.
- ③ Push [F-2]•B/QPSK] to toggle between BPSK and QPSK mode alternately.

◇ Functions for the PSK decoder indication

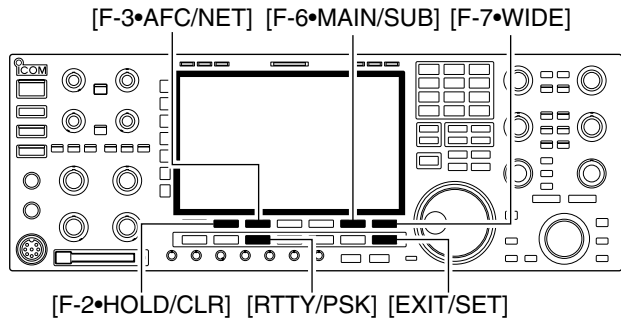

• AFC/NET indications



“AFC” and “NET” indicators Offset frequency

- ① Push a band key to select the desired band.
 - ② Push [RTTY/PSK] to select PSK.
 - After PSK mode is selected, hold down [RTTY/PSK] for 1 second to toggle between PSK and PSK-R modes.
 - “PSK” or “PSK-R” appears.
 - ③ Push [F-3•DECODE] to display the decoder screen.
 - When tuned into a PSK signal, decoded characters are displayed in the RX contents screen.
 - ④ Push [F-2•HOLD/CLR] to freeze the current screen.
 - “HOLD” appears while the function is in use.
 - Push [F-2•HOLD/CLR] again to release the function.
 - ⑤ Hold down [F-2•HOLD/CLR] for 1 second to clear the displayed characters.
 - “HOLD” indicator disappears at the same time as the displayed characters are cleared. (The hold function is cancelled.)
 - ⑥ Push [F-3•AFC/NET] to turn the AFC function ON.
 - “AFC” appears.
 - If a PSK signal is received within the AFC tuning range, the decoder automatically tunes into the signal and the offset frequency is displayed.
 - The AFC tuning range is set to ±15 Hz as the default. Optional ±8 Hz setting is available in PSK decode set mode. (p. 2)
- NOTE:** The AFC function may not tune the signal properly when a weak PSK signal is received.
- ⑦ Push [F-3•AFC/NET] again to turn the NET function ON.
 - “NET” appears.
 - ⑧ Hold down [F-3•AFC/NET] for 1 second to add the offset frequency to the displayed frequency.
 - ⑨ Push [F-7•WIDE] to toggle the PSK decode screen size from normal and wide.
 - S/R/F meter type during wide screen indication can be selected in display set mode. (pp. 3-11, 12-11)
 - ⑩ Push [F-6•MAIN/SUB] to toggle the MAIN and SUB band for decode operation.
 - Dualwatch function (p. 5-17) should be ON when SUB band is selected for decode operation.
 - ⑪ Push [EXIT/SET] to close the PSK decode screen.

◇ Setting the decoder threshold level



Adjust the PSK decoder threshold level if some characters are displayed when no signal is received.

- ① Call up the PSK decoder screen as described above.
- ② Push [F-5•ADJ] to select the threshold level setting condition.
- ③ Rotate the main dial to adjust the PSK decoder threshold level.
 - Hold down [F-6•DEF] for 1 second to select the default setting.
- ④ Push [F-5•ADJ] to exit from the threshold level setting condition.

◇ PSK memory transmission

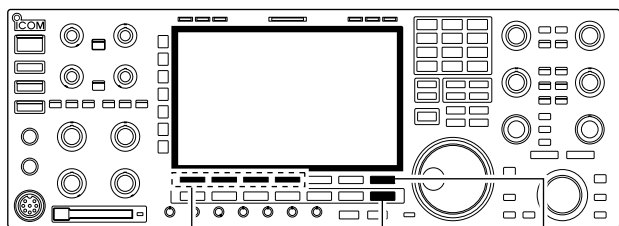

[F-1•PT1]–[F-4•PT4] [EXIT/SET] [F-7•1–4/5–8]
[F-1•PT5]–[F-4•PT8]

		PSK MEMORY				
AGC MID	PT1	MYCALLx2	„DE Icom Icom K„	AUTO TX/RX		
1/4 OFF	PT2	MYCALLx3	„DE Icom Icom Icom K„	AUTO TX/RX		
VSC OFF	PT3	QSLUR599	„QSL UR 599 599 BK„	AUTO TX/RX		
	PT4	DE+UR599	„QSL DE Icom Icom UR 599 599 BK„	AUTO TX/RX		
	PT1	PT2	PT3	PT4	EDIT	1-4/5-8

Pre-set characters can be sent using the PSK memory. Contents of the memory are set using the edit menu.

- ① During PSK mode operation, push [F-3•DECODE] to select PSK decode screen.
- ② Push [F-4•TX MEM] to select PSK memory screen.
- ③ Push [F-7•1–4/5–8] to select memory bank then push one of the function keys ([F-1•PT1] to [F-4•PT4] or [F-1•PT5] to [F-4•PT8]).
 - When no keyboard is connected, the selected memory contents will be transmitted immediately.
 - When a keyboard is connected, the memory contents will be transmitted immediately when function key is pushed, or transmitted after [F12] on the connected keyboard is pushed, depending on auto transmission/reception setting (see below).
 - The transmission date, time, reception date and/or time may be displayed in RX contents screen, depending on setting.

✓ For your convenience

When an external keypad is connected, one of PT1 to PT4 PSK memory contents can be transmitted while the PSK decoder screen is selected in PSK mode. See pages 2-6, 2-10 and 12-20 for details.

◇ Automatic transmission/reception setting

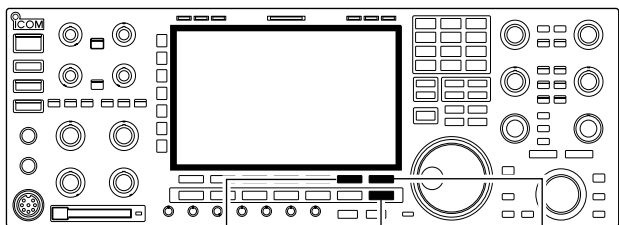

[F-6•AUTO TX] [EXIT/SET] [F-7•PT1..PT8]

		PSK MEMORY EDIT			
ABC	PT1	MYCALLx2	„DE Icom Icom K„	AUTO TX/RX	
	PT2	MYCALLx3	„DE Icom Icom Icom K„	AUTO TX/RX	
	PT3	QSLUR599	„QSL UR 599 599 BK„	AUTO TX/RX	
123	PT4	DE+UR599	„QSL DE Icom Icom UR 599 599 BK„	AUTO TX/RX	
		DEL	SPACE	AUTO TX	PT1..PT8

- ① During PSK mode operation, push [F-3•DECODE] to select PSK decode screen.
- ② Push [F-4•TX MEM] to select PSK memory screen, then push [F-6•EDIT] to select PSK memory edit screen.
 - PSK memory contents of Channel 1 (PT1) is selected.
- ③ Push [F-7•PT1..PT8] several times to select the desired RTTY memory.
- ④ Push [F-6•AUTO TX] several times to select the desired condition, as follows.
 - AUTO TX/RX : Automatically transmits the selected memory and returns to receive after the transmission.
 - AUTO TX : Automatically transmits the selected memory. To return to receive, push [F12] on the keyboard.
 - AUTO RX : Push [F12] on the keyboard to transmit the selected memory. Automatically returns to receive after the transmission.
 - No indication : Push [F12] on the keyboard to transmit the selected memory and push [F12] again to return to receive.
- ⑤ Push [EXIT/SET] to return to exit from PSK memory edit condition.

NOTE: The transceiver always functions as the “AUTO TX/RX” setting when no keyboard is connected.

◇ Editing PSK memory

[123]/[Symbol] [ABC]/[abc] [F-3•DEL] [F-4•SPACE]

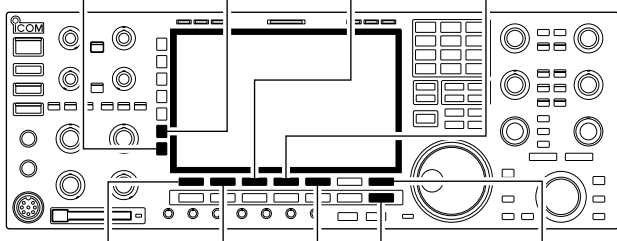

[F-1•◀] [F-2•▶] [F-5•◀▶] [EXIT/SET] [F-7•PT1..PT8]

• PSK memory edit screen

		PSK MEMORY EDIT		
ABC	PT1	MYCALLx2	↓DE Icom Icom K↓	AUTO TX/RX
ABC	PT2	MYCALLx3	↓DE Icom Icom Icom K↓	AUTO TX/RX
	PT3	QSLUR599	↓QSL UR 599 599 BK↓	AUTO TX/RX
123	PT4	DE+UR599	↓QSL DE Icom Icom UR 599 599 BK↓	AUTO TX/RX

Navigation buttons: ◀ ▶ DEL SPACE ▶▶ AUTO TX PT1..PT8

• Pre-programmed contents

CH	Name	Contents
PT1	MYCALLx2	↓DE Icom Icom K↓
PT2	MYCALLx3	↓DE Icom Icom Icom K↓
PT3	QSLUR599	↓QSL UR 599 599 BK↓
PT4	DE+UR599	↓QSL DE Icom Icom UR 599 599 BK↓
PT5	73 GL SK	↓73 GL SK↓
PT6	CQ CQ CQ	↓CQ CQ CQ DE Icom Icom Icom K↓
PT7	RIG&ANT	↓My transceiver is IC-7800 & Antenna is a 3-element triband yagi.↓
PT8	EQUIP.	↓My PSK equipment is internal modulator & demodulator of the IC-7800.↓

The contents of the PSK memories can be set using the memory edit menu. The memory can store 8 PSK messages for often-used PSK information. Total capacity of the memory is 70 characters per memory channel.

• Programming contents

- ① During PSK mode operation, push [F-3•DECODE] to select PSK decode screen.
- ② Push [F-4•TX MEM] to select PSK memory screen, then push [F-6•EDIT] to select PSK memory edit screen.
 - PSK memory contents of the Channel 1 (PT1) is selected.
- ③ Push [F-7•PT1..PT8] several times to select the desired PSK memory channel to be edited.
- ④ Push [F-5•◀ ▶] to select the edit item between memory contents and memory name.
 - [abc] appears when [ABC] is pushed when “ABC” character group is selected, and [Symbol] appears when [123] is pushed when “123” character group is selected.
 - Selectable characters (with the main dial);

Key selection	Editable characters
ABC	A to Z (capital letters)
abc	a to z (small letters)
123	0 to 9 (numbers)
Symbol	! # \$ % & ¥ ? “ ’ ` ^ + - * / . , : ; = < > () [] { } _ ~ @ ↓ (“↓” is for the memory contents setting only.)

✓ For your convenience

When a PC keyboard is connected to [KEYBOARD] connector on the rear panel, the PSK memory contents can also be edited from the keyboard.

- ⑥ Push [F-1•◀] or [F-2•▶] to move the cursor backwards or forwards, respectively.
 - Pushing [F-3•DEL] deletes a character and [F-4•SPACE] inserts a space.
- ⑦ Repeat steps ⑤ and ⑥ to input the desired characters.
- ⑧ Push [EXIT/SET] to set the contents and exit PSK memory edit screen.

◇ PSK decode set mode

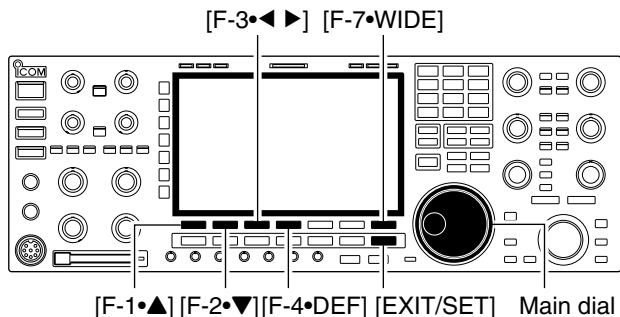

This set mode is used to set the FFT scope setting, time stamp setting, etc.

• Setting contents

- ① During PSK mode operation, push [F-3•DECODE] to select PSK decode screen.
- ② Push [F-1•<MENU2>] to select PSK decode menu 2, then push [F-6•SET] to select PSK decode set mode.
 - Push [F-7•WIDE] to toggle the screen size from normal and wide.
- ③ Push [F-1•▲] or [F-2•▼] to select the desired set item.
- ④ Set the desired condition using the main dial.
 - Hold down [F-4•DEF] for 1 second to select a default condition or value.
 - Push [F-3•◀▶] to select the set contents for some items.
- ⑤ Push [EXIT/SET] to exit from set mode.

PSK FFT Scope Averaging	OFF
Set the FFT scope waveform averaging function from 2 to 4 and OFF. (default: OFF)	Recommendation! If you use the FFT scope waveform for tuning, using the default or smaller number setting is recommended.

PSK FFT Scope Waveform Color	 51 153 255
Set the color for the FFT scope waveform. <ul style="list-style-type: none"> • The color is set in RGB format. • The set color is indicated in the box beside the RGB scale. 	<ul style="list-style-type: none"> • Push [F-3•◀▶] to select R (Red), G (Green) and B (Blue), and then rotate the main dial to set the ratio from 0 to 255.





PSK AFC Range	±15Hz
Select the AFC (Automatic Frequency Control) function operating range from ±15 Hz (default) and ±8 Hz.	NOTE: The AFC function may not tune the signal properly when a weak PSK signal is received.



PSK Time Stamp	ON
Turn the time stamp (date, transmission or reception time) display ON or OFF.	<ul style="list-style-type: none"> • ON : Displays the time stamp. • OFF : No time stamp display.



PSK Time Stamp (Time)	Local
Selects the clock display for time stamp usage. <p>NOTE: The time won't be displayed when "OFF" is selected in "PSK Time Stamp" as above.</p>	<ul style="list-style-type: none"> • Local : Selects the time that set in "Time (Now)." • UTC* : Selects the time that set in "CLOCK2." <p>*The name of choice may differ according to "CLOCK2 Name" setting (p, 11-2). "UTC" is the default name of CLOCK2.</p>



◇ PSK decode set mode (continued)

PSK Time Stamp (Frequency)	OFF
<p>Selects the operating frequency display for time stamp usage.</p> <p>NOTE: The frequency won't be displayed when "OFF" is selected in "PSK Time Stamp" as below left.</p>	<ul style="list-style-type: none"> • ON : Displays the operating frequency. • OFF : No operating frequency display.

PSK Font Color (Receive)	  128  255  128
<p>Set the text color for received characters.</p> <ul style="list-style-type: none"> • The color is set in RGB format. • The set color is indicated in the box beside the RGB scale. 	<ul style="list-style-type: none"> • Push [F-3•◀▶] to select R (Red), G (Green) and B (Blue), and then rotate the main dial to set the ratio from 0 to 255.

PSK Font Color (Transmit)	 255  106  106
<p>Set the text color for transmitted characters.</p> <ul style="list-style-type: none"> • The color is set in RGB format. • The set color is indicated in the box beside the RGB scale. 	<ul style="list-style-type: none"> • Push [F-3•◀▶] to select R (Red), G (Green) and B (Blue), and then rotate the main dial to set the ratio from 0 to 255.

PSK Font Color (Time Stamp)	 0  155  189
<p>Set the text color for time stamp indication.</p> <ul style="list-style-type: none"> • The color is set in RGB format. • The set color is indicated in the box beside the RGB scale. 	<ul style="list-style-type: none"> • Push [F-3•◀▶] to select R (Red), G (Green) and B (Blue), and then rotate the main dial to set the ratio from 0 to 255.

PSK Font Color (TX Buffer)	 255  255  255
<p>Set the text color in the TX buffer screen.</p> <ul style="list-style-type: none"> • The color is set in RGB format. • The set color is indicated in the box beside the RGB scale. 	<ul style="list-style-type: none"> • Push [F-3•◀▶] to select R (Red), G (Green) and B (Blue), and then rotate the main dial to set the ratio from 0 to 255.

◇ Data saving

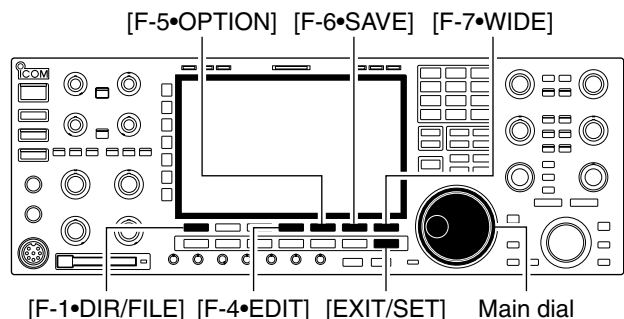

• Decode file save screen



• Decode file save screen— file name edit



• Save option screen



✓ For your convenience!

Two data formats, Text and HTML, are available for PC data storage.

The contents of the PSK memory and received signal can be saved into the CF memory card or USB flash drive.

- ① During PSK decode screen indication, push [F-1•<MENU1>] to select PSK decode menu 2.
- ② Push [F-5•SAVE] to select decode file save screen.
- ③ Change the following conditions if desired.

• File name:

- ① Push [F-4•EDIT] to select file name edit condition.
 - Push [F-1• DIR/FILE] several times to select the file name, if necessary.
- ② Push [ABC], [123] or [Symbol] to select the character group, then rotate the main dial to select the character.
 - [ABC] : A to Z (capital letters); [123]: 0 to 9 (numerals); [Symbol]: ! # \$ % & ' ` ^ + - = () [] { } _ ~ @ can be selected.
 - Push [F-1•◀] to move the cursor left, push [F-2•▶] to move the cursor right, [F-3•DEL] delete a character and push [F-4•SPACE] to insert a space.
- ③ Push [EXIT/SET] to set the file name.

• File format

- ① Push [F-5•OPTION] to enter save option screen.
- ② Rotate the main dial to select the saving format from Text or HTML.
 - “Text” is the default setting.
 - Hold down [F-4•DEF] for 1 second to select the default setting.
- ③ Push [EXIT/SET] to return to the previous indication.

• Saving location

- ① Hold down [F-1•DIR/FILE] for 1 second to select the CF memory card or USB flash drive.
- ② Push [F-1•DIR/FILE] to select tree view screen.
- ③ Select the desired directory or folder in the selected memory device.
 - Push [F-4•◀ ▶] to select the upper directory.
 - Push [F-2•▲] or [F-3•▼] to select folder in the same directory.
 - Hold down [F-4•◀ ▶] for 1 second to select a folder in the directory.
 - Push [F-5•REN/DEL] to rename the folder.
 - Hold down [F-5•REN/DEL] for 1 second to delete the folder.
 - Hold down [F-6•MAKE] for 1 second to make a new folder. (Edit the name with the same manner as the “• File name” above.)
- ④ Push [F-1•DIR/FILE] twice to select the file name.

- ④ Push [F-6•SAVE].
 - After the saving is completed, automatically returns to PSK decode menu 2.

■ Operating AM

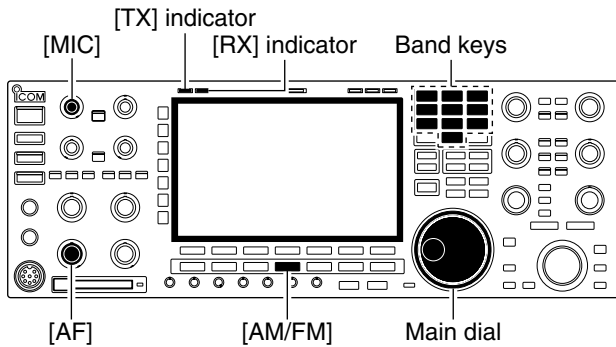

- ① Push a band key to select the desired band.
- ② Push [AM/FM] to select AM.
 - “AM” indicator appears.
 - After AM mode is selected, push [AM/FM] to toggle between AM and FM modes.
- ③ Rotate the main dial to tune the desired frequency.
 - The S-meter indicates received signal strength when signal is received.
- ④ Rotate [AF] to set audio to a comfortable listening level.
- ⑤ Push [TRANSMIT] or [PTT] (microphone) to transmit.
 - The TX indicator lights red.
- ⑥ Speak into the microphone at your normal voice level.
 - Adjust the microphone gain with [MIC] at this step, if necessary.
- ⑦ Push [TRANSMIT] or release [PTT] (microphone) to return to receive.

◇ Convenient functions for receive

- **Preamp** (p. 5-10)
 - ➔ Push [P.AMP] several times to set the preamp OFF, preamp 1 ON or preamp 2 ON.
 - “P.AMP1” or “P.AMP2” appears when the preamp 1 or preamp 2 is ON. Main and sub have independent preamp controls.
 - **Attenuator** (p. 5-10)
 - ➔ Push [ATT] several times to set the attenuator in 6 dB steps.
 - Hold down [ATT] for 1 second to set the attenuator in 3 dB steps.
 - “ATT” and attenuation level appear when the attenuator is ON.
 - **Noise blanker** (p. 5-18)
 - ➔ Push [NB] switch to turn the noise blanker ON or OFF, and then rotate [NB] control to adjust the threshold level.
 - Noise blanker indicator (above [NB] switch) lights when the noise blanker is ON.
 - Hold down [NB] for 1 second to enter noise blanker set mode.
 - **Noise reduction** (p. 5-19)
 - ➔ Push [NR] switch to turn the noise reduction ON or OFF.
 - Rotate [NR] control to adjust the noise reduction level.
 - Noise reduction indicator (above [NR] switch) lights when the noise reduction is ON.
 - **Twin PBT (passband tuning)** (p. 5-13)
 - ➔ Rotate [TWIN PBT] controls (inner/outer).
 - Hold down [PBT CLEAR] for 1 second to clear the settings.
 - **Notch filter** (p. 5-20)
 - ➔ Push [NOTCH] switch to turn the manual notch function ON or OFF.
 - Rotate [NOTCH] control to set the attenuating frequency.
 - Notch indicator (above [NOTCH] switch) lights when either the auto or manual notch is ON.
 - **AGC (auto gain control)** (p. 5-12)
 - ➔ Push [AGC] switch several times to select AGC FAST, AGC MID or AGC SLOW.
 - ➔ Push [AGC VR] to turn the AGC time constant manual setting ON or OFF.
 - Rotate [AGC] control to adjust the time constant.
 - **Auto tuning function** (p. 1-9)
 - ➔ Push [AUTO TUNE] to turn the auto tuning function ON or OFF.
 - The transceiver automatically tunes the desired signal within ± 5 kHz range.
- IMPORTANT!**
When receiving a weak signal, or receiving a signal with interference, the automatic tuning function may not tune, or may tune to an undesired signal.

◇ Convenient functions for transmit

- | | |
|---|---|
| <ul style="list-style-type: none">• VOX (voice operated transmit) (p. 6-2)<ul style="list-style-type: none">➔ Push [VOX/BK-IN] to turn the VOX function ON or OFF.<ul style="list-style-type: none">• “VOX” appears when the VOX function is ON.• Transmit quality monitor (p. 6-4)<ul style="list-style-type: none">➔ Push [MONI] to turn the monitor function ON or OFF.<ul style="list-style-type: none">• Rotate [MONI GAIN] to adjust the monitor gain.• Monitor indicator (above [MONI] switch) lights when the monitor function is ON. | <ul style="list-style-type: none">• Audio tone control (p. 12-4)<ul style="list-style-type: none">➔ Push [F-7•SET] then [F-1•LEVEL] to enter level set mode. Select an item with [F-1•▲]/[F-2•▼] then rotate the main dial to adjust the audio tone. |
|---|---|

■ Operating FM

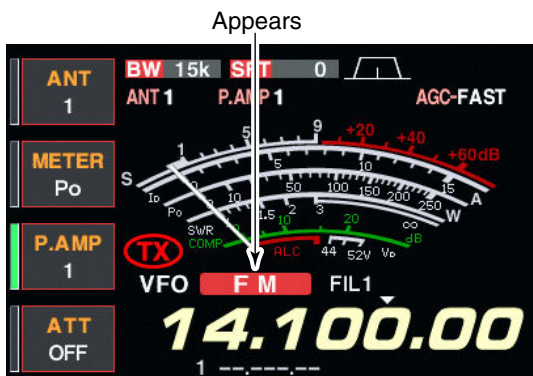
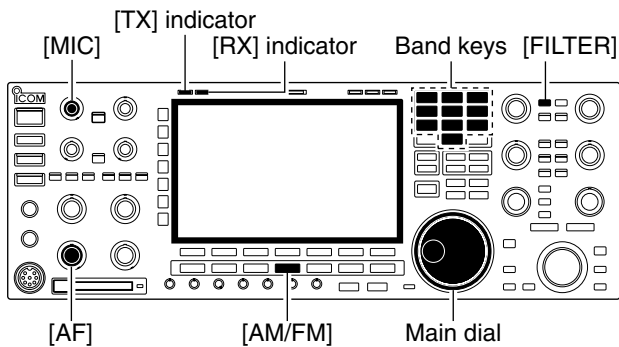

- ① Push a band key to select the desired band.
- ② Push [AM/FM] to select FM.
 - “FM” indicator appears.
 - After FM mode is selected, push [AM/FM] to toggle between FM and AM modes.
- ③ Rotate the main dial to tune the desired frequency.
 - The S-meter indicates received signal strength when signal is received.
 - 10 kHz tuning step is preset for the FM mode.
 - Push [FILTER] several times to select the desired filter width.
- ④ Rotate [AF] to set audio to a comfortable listening level.
- ⑤ Push [TRANSMIT] or [PTT] (microphone) to transmit.
 - The TX indicator lights red.
- ⑥ Speak into the microphone at your normal voice level.
 - Adjust the microphone gain with [MIC] at this step, if necessary.
 - FM narrow transmission is available when “FIL2” or “FIL3” is selected.
- ⑦ Push [TRANSMIT] or release [PTT] (microphone) to return to receive.

◇ Convenient functions for receive

- **Preamp** (p. 5-10)
 - ➔ Push [P.AMP] several times to set the preamp OFF, preamp 1 ON or preamp 2 ON.
 - “P.AMP1” or “P.AMP2” appears when the preamp 1 or preamp 2 is ON. Main and sub have independent preamp controls.
- **Auto notch filter** (p. 5-20)
 - ➔ Push [NOTCH] switch to turn the auto notch function ON or OFF.
 - Notch indicator (above [NOTCH] switch) lights when the auto notch is ON.
- **Attenuator** (p. 5-10)
 - ➔ Push [ATT] several times to set the attenuator in 6 dB steps.
 - Hold down [ATT] for 1 second to set the attenuator in 3 dB steps.
 - “ATT” and attenuation level appear when the attenuator is ON.

◇ Convenient functions for transmit

- **VOX (voice operated transmit)** (p. 6-2)
 - ➔ Push [VOX/BK-IN] to turn the VOX function ON or OFF.
 - “VOX” appears when the VOX function is ON.
- **Transmit quality monitor** (p. 6-4)
 - ➔ Push [MONI] to turn the monitor function ON or OFF.
 - Rotate [MONI GAIN] to adjust the monitor gain.
 - Monitor indicator (above [MONI] switch) lights when the monitor function is ON.
- **Audio tone control** (p. 12-4)
 - ➔ Push [F-7•SET] then [F-1•LEVEL] to enter level set mode. Select an item with [F-1•▲]/[F-2•▼] then rotate the main dial to adjust the audio tone.

■ Repeater operation

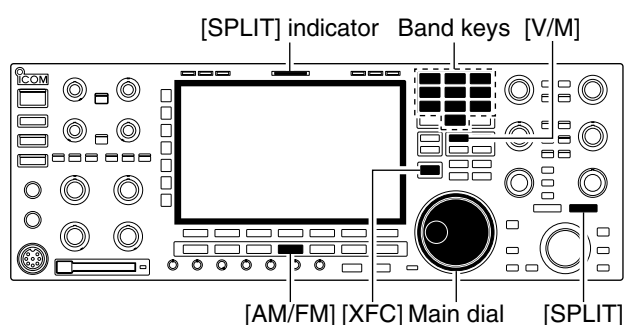

A repeater amplifies received signals and retransmits them at a different frequency. When using a repeater, the transmit frequency is shifted from the receive frequency by an offset frequency. A repeater can be accessed using split frequency operation with the shift frequency set to the repeater's offset frequency.

For accessing a repeater which requires a repeater tone, set the repeater tone frequency in tone frequency set mode as described below.

- ① First, set the offset frequency for HF and 50 MHz bands, then turn ON the quick split function in the Others set mode. (p. 12-15)
- ② Push [V/M] to select VFO mode.
- ③ Push the desired band key.
- ④ Push [AM/FM] several times to select FM mode.
- ⑤ Set the receive frequency (repeater output frequency).
- ⑥ Hold down [SPLIT] for 1 second to start repeater operation.
 - Repeater tone is turned ON automatically.
 - [SPLIT] indicator lights and "SPLIT" appears on the LCD.
 - Shifted transmit frequency and "TX" appear in the sub band.
 - The transmit frequency can be monitored while holding down [XFC] or using dualwatch.
- ⑦ Hold down [PTT] to transmit; release [PTT] to receive.
- ⑧ To return to simplex, push [SPLIT] momentarily.

◇ Repeater tone frequency setting

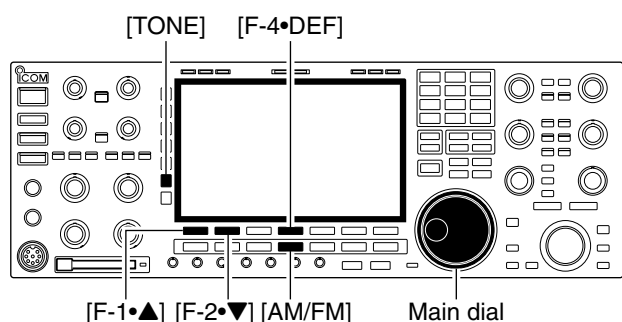

Some repeaters require subaudible tones to be accessed. Subaudible tones are superimposed over your normal signal and must be set in advance. The transceiver has 50 tones from 67.0 Hz to 254.1 Hz.

- ① Select FM mode.
- ② Hold down [TONE] for 1 second to tone frequency set mode.
- ③ Push [F-1•▲] or [F-2•▼] to select REPEATER TONE item.
- ④ Rotate the main dial to select the desired repeater tone frequency.
 - Hold down [F-4•DEF] for 1 second to select the default setting.
- ⑤ Push [EXIT/SET] to return to the previous indication.

• Available tone frequencies (unit: Hz)

67.0	85.4	107.2	136.5	165.5	186.2	210.7	254.1
69.3	88.5	110.9	141.3	167.9	189.9	218.1	
71.9	91.5	114.8	146.2	171.3	192.8	225.7	
74.4	94.8	118.8	151.4	173.8	196.6	229.1	
77.0	97.4	123.0	156.7	177.3	199.5	233.6	
79.7	100.0	127.3	159.8	179.9	203.5	241.8	
82.5	103.5	131.8	162.2	183.5	206.5	250.3	

■ Tone squelch operation

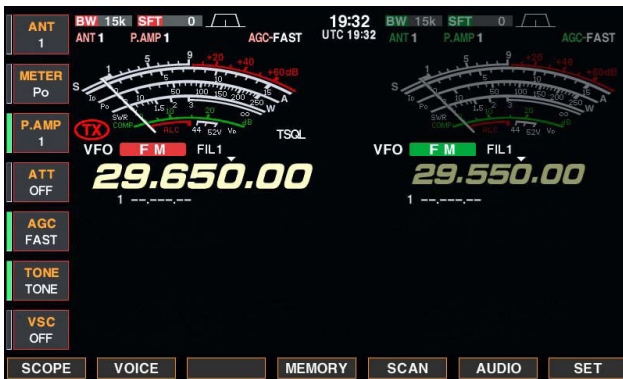
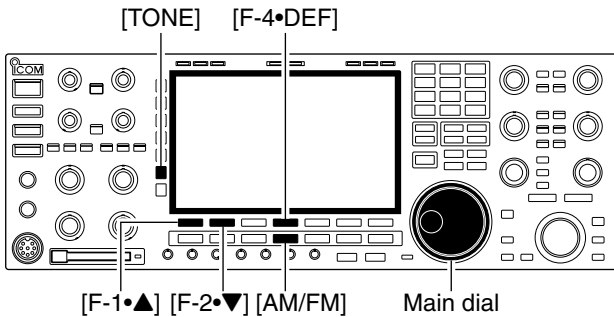

The tone squelch opens only when receiving a signal containing a matching subaudible tone. You can silently wait for calls from group members using the same tone.

- ① Set the desired frequency band and select FM mode.
- ② Push [TONE] to turn the tone squelch function ON.
 - “TSQL” appears
- ③ Hold down [TONE] for 1 second to tone frequency set mode.
- ④ Push [F-1•▲] or [F-2•▼] to select T-SQL TONE item.
- ⑤ Rotate the main dial to select the desired tone squelch frequency.
 - Hold down [F-4•DEF] for 1 second to select the default setting.
- ⑥ Push [EXIT/SET] to return to the previous indication.
- ⑦ When the received signal includes a matching tone, squelch opens and the signal can be heard.
 - When the received signal’s tone does not match, tone squelch does not open, however, the S-indicator shows signal strength.
 - To open the squelch manually, push [XFC].
- ⑧ Operate the transceiver in the normal way.
- ⑨ To cancel the tone squelch, push [TONE] to clear “TSQL.”

• Available tone frequencies (unit: Hz)

67.0	85.4	107.2	136.5	165.5	186.2	210.7	254.1
69.3	88.5	110.9	141.3	167.9	189.9	218.1	
71.9	91.5	114.8	146.2	171.3	192.8	225.7	
74.4	94.8	118.8	151.4	173.8	196.6	229.1	
77.0	97.4	123.0	156.7	177.3	199.5	233.6	
79.7	100.0	127.3	159.8	179.9	203.5	241.8	
82.5	103.5	131.8	162.2	183.5	206.5	250.3	

■ Data mode (AFSK) operation

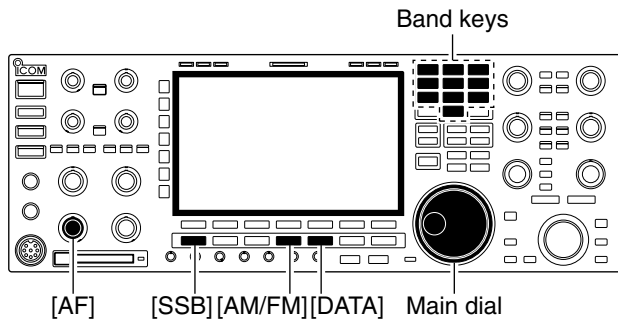

[AF] [SSB] [AM/FM] [DATA] Main dial

Appears



• Mark and Space tones of RTTY in the AFSK mode operating in the LSB mode

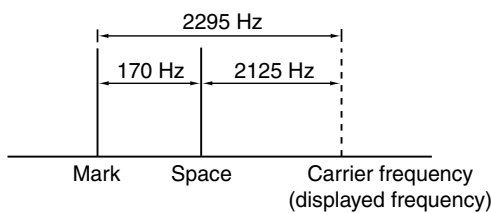

When operating RTTY, SSTV, AMTOR or PACKET with your TNC and/or PC software, consult the manual that comes with the TNC and/or the software.

- ① Connect a PC and TNC to the transceiver. (p. 2-8)
- ② Push a band key to select the desired band.
- ③ Push [SSB] or [AM/FM] to select the desired operating mode.
- ④ Push [DATA] to turn data mode ON.
 - One of “-D1,” “-D2” or “-D3” is additionally appears.
 - During data mode selection, holding down [DATA] for 1 second to select data mode 1 (D1), 2 (D2) and 3 (D3) in sequence.
- ⑤ Rotate the main dial to tune into the desired signal and decoded correctly.
 - Also use the tuning indicator of the TNC or software.
 - During SSB data mode, 1/4 tuning function can be used for critical tuning.
- ⑥ Operate the PC (software) or TNC to transmit.
 - When operating in SSB data mode, adjust the TNC output level so that the ALC meter reading doesn't go outside the ALC zone.

NOTE: When SSB data mode is selected, the audio input from the [ACC1] (pin 6) is used for transmission instead of [MIC]'s.
The fixed condition is used for SSB data transmission as follows:

- [COMP] : OFF
- Tx bandwidth : MID
- Tx Tone (Bass) : 0
- Tx Tone (Trebles) : 0

✓ For your information

Carrier frequency is displayed when SSB data mode is selected.
See the diagram left for the tone-pair example.

■ Spectrum scope screen	5-2
◇ Center mode	5-2
◇ Fix mode	5-3
◇ Mini scope screen indication	5-4
◇ Scope set mode	5-4
◇ USB mouse operation	5-9
■ Preamplifier	5-10
■ Attenuator	5-10
■ RIT function	5-11
◇ RIT monitor function	5-11
■ AGC function	5-12
◇ Selecting the preset value	5-12
◇ Adjusting the AGC time constant	5-12
◇ Setting the AGC time constant preset value	5-12
■ Twin PBT operation	5-13
■ IF filter selection	5-14
◇ IF filter selection	5-14
◇ Filter passband width setting (except FM mode)	5-14
◇ Roofing filter selection	5-15
◇ DSP filter shape	5-15
◇ Filter shape set mode	5-15
■ Dualwatch operation	5-17
■ Noise blanker	5-18
◇ NB set mode	5-18
■ Noise reduction	5-19
■ Dial lock function	5-19
■ Notch function	5-20
■ Digital selector	5-20
■ Audio scope screen	5-21
◇ Audio scope set mode	5-22

■ Spectrum scope screen

◇ Center mode

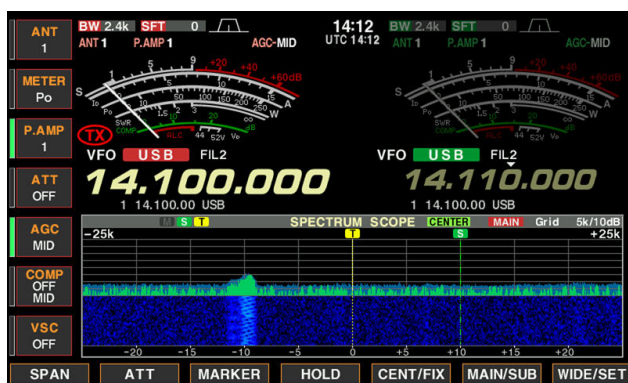
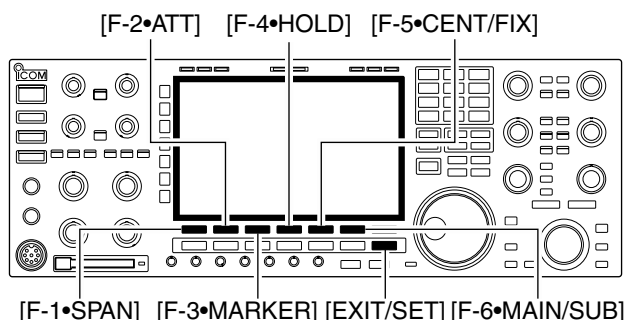

• Spectrum scope

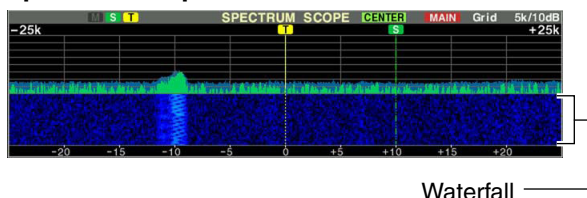

This DSP-based spectrum scope allows you to display the conditions on the selected band, as well as relative strengths of signals. The IC-7800 has two modes for the spectrum indication— one is center mode, and another one is fix mode.

In addition, the IC-7800 has a mini scope screen to save screen space.

Displays signals around the set frequency within the selected span. The set frequency is always displayed at the center of the screen.

- ① Push [EXIT/SET] several times to close a multi-function screen, if necessary.
- ② Push [F-1•SCOPE] to select the scope screen.
 - Push [F-7•WIDE/SET] to toggle the screen size between normal and wide.
- ③ Push [F-5•CENT/FIX] to select the center mode.
 - “**CENTER**” is displayed when center mode is selected.
- ④ Push [F-1•SPAN] several times to select the scope span.
 - ± 2.5 , ± 5.0 , ± 10 , ± 25 , ± 50 , ± 100 and ± 250 kHz are selectable.
 - Sweeping speed is independently selectable for each span in scope set mode. (pp. 5-5, 5-6)
- ⑤ Push [F-2•ATT] several times to activate an attenuator or turn the attenuator OFF.
 - 10, 20 and 30 dB attenuators are selectable.
- ⑥ Push [F-6•MAIN/SUB] to select main band.
 - The spectrum scope with sub band selection is activated during dualwatch or split frequency operation only.
- ⑦ Push [F-3•MARKER] several times to select the marker (sub readout or transmit frequency) or turn the marker OFF.
 - “**T**” displays the marker at the transmit frequency.
 - “**S**” displays the marker at the sub readout frequency.
 - “<<” or “>>” appears when the marker is out of range.
 - The spectrum scope shows the transmit signal waveform while transmitting. This can be deactivated in scope set mode. (p. 5-4)
 - The spectrum scope shows the peak level holding function. Peak levels are displayed in the background of the current spectrum in a different color until the receive frequency changes. This can be deactivated and the waveform color can be set in scope set mode. (p. 5-5)
- ⑧ Push [F-4•HOLD] to freeze the current spectrum waveform.
 - “**HOLD**” appears while the function is in use.
 - The peak hold function can be deactivated in scope set mode.
- ⑨ Push [EXIT/SET] to exit the scope screen.

NOTE: If a strong signal is received, a ghost waveform may appear. Push [F-2•ATT] several times to activate the spectrum scope attenuator in this case. Spurious signal waveforms may be displayed. They are generated in the internal scope circuit and do not indicate a transceiver malfunction.

◇ Fix mode

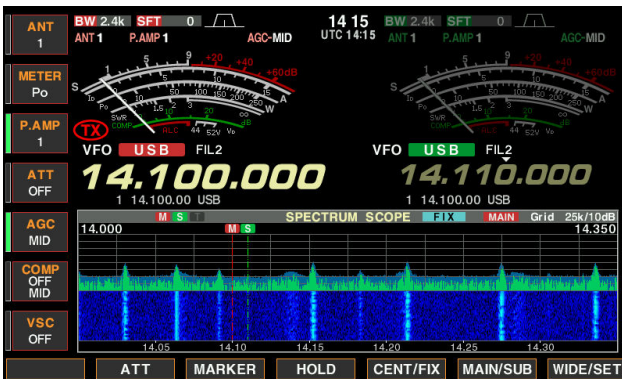
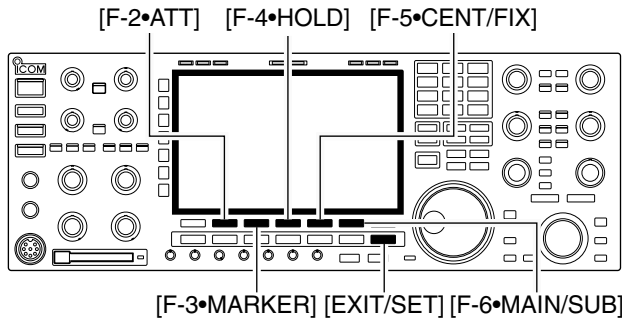

Displays signals within the specified frequency range. The selected frequency band conditions can be observed at a glance when using this mode.

- ① Push [EXIT/SET] several times to close a multi-function screen, if necessary.
- ② Push [F-1•SCOPE] to select the scope screen.
 - Push [F-7•WIDE/SET] to toggle the screen size between normal and wide.
- ③ Push [F-5•CENT/FIX] to select the fix mode.
 - “**FIX**” is displayed when fix mode is selected.
- ④ Push [F-2•ATT] several times to activate an attenuator or turn the attenuator OFF.
 - 10, 20 and 30 dB attenuators are selectable.
- ⑤ Push [F-6•MAIN/SUB] to select main band.
 - The spectrum scope with sub band selection is activated during dualwatch or split frequency operation only.
- ⑥ Push [F-3•MARKER] several times to select the marker (sub readout or transmit frequency) or turn the marker OFF.
 - “**M**” displays the marker at the main readout frequency. (always displayed)
 - “**T**” displays the marker at the transmit frequency.
 - “**S**” displays the marker at the sub readout frequency.
 - “<<” or “>>” appears when the marker is out of range.
 - The spectrum scope shows the transmit signal waveform while transmitting. This can be deactivated in scope set mode. (p. 5-4)
 - The spectrum scope shows the peak level holding function. Peak levels are displayed in the background of the current spectrum in a different color until the receive frequency changes. This can be deactivated and the waveform color can be set in scope set mode. (p. 5-5)
- ⑦ Push [F-4•HOLD] to freeze the current spectrum waveform.
 - “**HOLD**” appears while the function is in use.
 - The peak hold function can be deactivated in scope set mode.
- ⑧ Push [EXIT/SET] to exit the scope screen.

/// **NOTE:** If a strong signal is received, a ghost waveform may appear. Push [F-2•ATT] several times to activate the spectrum scope attenuator in this case.

/// The scope bandwidth can be specified for each operating frequency band independently in scope set mode. (pp. 5-6 to 5-8)

5 FUNCTIONS FOR RECEIVE

◇ Mini scope screen indication

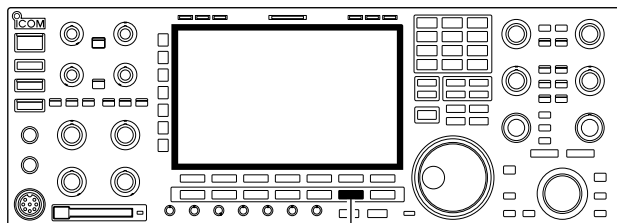

[M.SCOPE]

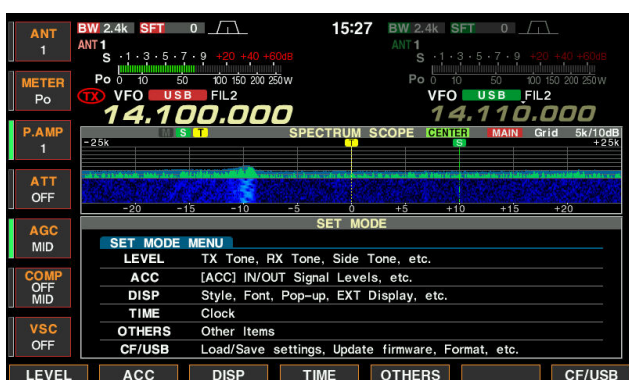

The mini scope screen can be displayed with another screen display, such as set mode menu, decoder screen, memory list screen, etc. simultaneously.

- ① Set the scope mode (center or fix), marker, attenuator, span, etc. in advance. (pp. 5-2, 5-3)
- ② Push [M.SCOPE] to toggle the mini scope indication ON or OFF.
 - The S/RF meter type during mini scope indication can be selected in display set mode (Meter Type (Wide Screen) item). (p. 12-11)

◇ Scope set mode

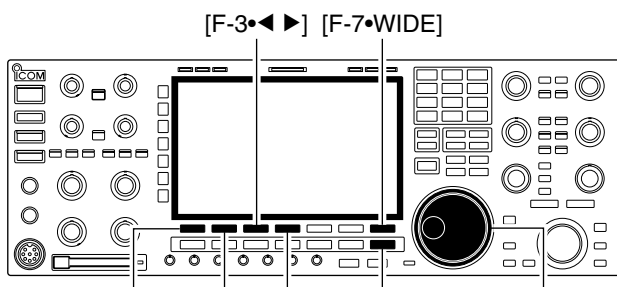

[F-1•▲] [F-2•▼] [F-4•DEF] [EXIT/SET] Main dial

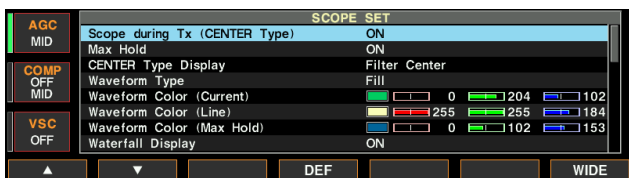

This set mode is used to set the waveform color, sweeping speed, scope range for fix mode, etc.

- ① During spectrum scope display ON, hold down [F-7•WIDE/SET] to select scope set mode screen.
 - Push [F-7•WIDE] to toggle the screen size between normal and wide.
- ② Push [F-1•▲] or [F-2•▼] to select the desired set item.
- ③ Set the desired condition using the main dial.
 - Hold down [F-4•DEF] for 1 second to select the default condition or value.
 - Push [F-3•◀ ▶] to select the set contents for some items.
- ④ Push [EXIT/SET] to exit from set mode.



Scope during Tx (CENTER Type)

ON

Turn the transmitting signal waveform indication ON or OFF.

NOTE: The transmitting signal waveform indication is available for the center mode only.

◇ Scope set mode (continued)

Max Hold ON	
Turn the peak level holding function ON or OFF.	
CENTER Type Display	Filter Center
Select the center frequency of the spectrum scope indication (center mode only).	<ul style="list-style-type: none"> • Filter center : Shows the selected filter's center frequency at the center. • Carrier Point Center : Shows the selected operating mode carrier point frequency at the center. • Carrier Point Center (Abs. Freq.) : In addition to the carrier point center setting above, the actual frequency is displayed for the bottom of the scope.
Waveform Type	Fill
Select the outline indication of the waveform for the spectrum scope.	<ul style="list-style-type: none"> • Fill : The waveform is described by only the color. • Fill + Line : The waveform is described by the color and outline.
Waveform Color (Current)	
Set the waveform color for the currently received signals.	<ul style="list-style-type: none"> • The color is set in RGB format. • Push [F-3•◀ ▶] to select R (Red), G (Green) and B (Blue), and rotate the ratio from 0 to 255 range. • The set color is indicated in the box beside the RGB scale.
Waveform Color (Line)	
Set the waveform outline color for the currently received signals.	<ul style="list-style-type: none"> • The color is set in RGB format. • Push [F-3•◀ ▶] to select R (Red), G (Green) and B (Blue), and rotate the ratio from 0 to 255 range. • The set color is indicated in the box beside the RGB scale.
Waveform Color (Max Hold)	
Set the waveform color for the receiving signals maximum level.	<ul style="list-style-type: none"> • The color is set in RGB format. • Push [F-3•◀ ▶] to select R (Red), G (Green) and B (Blue), and rotate the ratio from 0 to 255 range. • The set color is indicated in the box beside the RGB scale.
Waterfall Display	ON
Set the waterfall display to ON or OFF.	<ul style="list-style-type: none"> • ON : Displays the waterfall of the spectrum scope. • OFF : Does not display the waterfall.

◇ Scope set mode (continued)

Waterfall Peak Color Level	Grid 8
<p>The signal level that reaches a peak color is set to Grid 1 to Grid 8 for the waterfall display.</p> <p>Higher signal levels are Red, Yellow, Green, Light-blue, Blue and Black in order.</p>	

Sweep Speed (± 2.5k)	MID
<p>Select the sweeping speed for the ±2.5 kHz span selection from SLOW, MID and FAST.</p>	<p> NOTE: The waveform may be displayed incorrectly with the “FAST” setting.</p>

(± 5k)	MID
<p>Select the sweeping speed for the ±5 kHz span selection from SLOW, MID and FAST.</p>	<p> NOTE: The waveform may be displayed incorrectly with the “FAST” setting.</p>

(± 10k)	FAST
<p>Select the sweeping speed for the ±10 kHz span selection from SLOW, MID and FAST.</p>	

(± 25k)	FAST
<p>Select the sweeping speed for the ±25 kHz span selection from SLOW, MID and FAST.</p>	

(± 50k)	FAST
<p>Select the sweeping speed for the ±50 kHz span selection from SLOW, MID and FAST.</p>	

(±100k)	FAST
<p>Select the sweeping speed for the ±100 kHz span selection from SLOW, MID and FAST.</p>	

(±250k)	FAST
<p>Select the sweeping speed for the ±250 kHz span selection from SLOW, MID and FAST.</p>	

Fixed Edges (0.03 – 1.60)	0.750 – 1.250 MHz
<p>Set the scope edge frequencies for fixed mode scope with below the 1.6 MHz band selection.</p>	<ul style="list-style-type: none"> • Set the frequencies between 0.030 to 1.600 MHz range in 1 kHz steps. Up to 500 kHz band width can be specified, so either edge frequency will be set to the difference between higher and lower frequencies become 5 to 500 kHz automatically while setting another edge frequency.

◇ Scope set mode (continued)

(1.60 – 2.00)**1.800 – 2.000 MHz**

Set the scope edge frequencies for fixed mode scope when the 1.6 to 2 MHz band is selected.

- Set the frequencies between 1.600 to 2.000 MHz range in 1 kHz steps.

(2.00 – 6.00)**3.500 – 4.000 MHz**

Set the scope edge frequencies for fixed mode scope when the 2 to 6 MHz band is selected.

- Set the frequencies between 2.000 to 6.000 MHz range in 1 kHz steps.
 ▨ Up to 500 kHz band width can be specified, so either edge frequency will be set to the difference between higher and lower frequencies become 5 to 500 kHz automatically while setting another edge frequency.

(6.00 – 8.00)**7.000 – 7.300 MHz**

Set the scope edge frequencies for fixed mode scope when the 6 to 8 MHz band is selected.

- Set the frequencies between 6.000 to 8.000 MHz range in 1 kHz steps.
 ▨ Up to 500 kHz band width can be specified, so either edge frequency will be set to the difference between higher and lower frequencies become 5 to 500 kHz automatically while setting another edge frequency.

(8.00 – 11.00)**10.100 – 10.150 MHz**

Set the scope edge frequencies for fixed mode scope when the 8 to 11 MHz band is selected.

- Set the frequencies between 8.000 to 11.000 MHz range in 1 kHz steps.
 ▨ Up to 500 kHz band width can be specified, so either edge frequency will be set to the difference between higher and lower frequencies become 5 to 500 kHz automatically while setting another edge frequency.

(11.00 – 15.00)**14.000 – 14.350 MHz**

Set the scope edge frequencies for fixed mode scope when the 11 to 15 MHz band is selected.

- Set the frequencies between 11.000 to 15.000 MHz range in 1 kHz steps.
 ▨ Up to 500 kHz band width can be specified, so either edge frequency will be set to the difference between higher and lower frequencies become 5 to 500 kHz automatically while setting another edge frequency.

(15.00 – 20.00)**18.068 – 18.168 MHz**

Set the scope edge frequencies for fixed mode scope when the 15 to 20 MHz band is selected.

- Set the frequencies between 15.000 to 20.000 MHz range in 1 kHz steps.
 ▨ Up to 500 kHz band width can be specified, so either edge frequency will be set to the difference between higher and lower frequencies become 5 to 500 kHz automatically while setting another edge frequency.

◇ **Scope set mode (continued)**

(20.00 – 22.00)	21.000 – 21.450 MHz
Set the scope edge frequencies for fixed mode scope when the 20 to 22 MHz band is selected.	<ul style="list-style-type: none"> • Set the frequencies between 20.000 to 22.000 MHz range in 1 kHz steps. ▨ Up to 500 kHz band width can be specified, so either edge frequency will be set to the difference between higher and lower frequencies become 5 to 500 kHz automatically while setting another edge frequency.

(22.00 – 26.00)	24.890 – 24.990 MHz
Set the scope edge frequencies for fixed mode scope when the 22 to 26 MHz band is selected.	<ul style="list-style-type: none"> • Set the frequencies between 22.000 to 26.000 MHz range in 1 kHz steps. ▨ Up to 500 kHz band width can be specified, so either edge frequency will be set to the difference between higher and lower frequencies become 5 to 500 kHz automatically while setting another edge frequency.

(26.00 – 30.00)	28.000 – 28.500 MHz
Set the scope edge frequencies for fix mode scope when 26 to 30 MHz band is selected.	<ul style="list-style-type: none"> • Set the frequencies between 26.000 to 30.000 MHz range in 1 kHz steps. ▨ Up to 500 kHz band width can be specified, so either edge frequency will be set to the difference between higher and lower frequencies become 5 to 500 kHz automatically while setting another edge frequency.

(30.00 – 45.00)	30.000 – 30.500 MHz
Set the scope edge frequencies for fixed mode scope when the 30 to 45 MHz band is selected.	<ul style="list-style-type: none"> • Set the frequencies between 30.000 to 45.000 MHz range in 1 kHz steps. ▨ Up to 500 kHz band width can be specified, so either edge frequency will be set to the difference between higher and lower frequencies become 5 to 500 kHz automatically while setting another edge frequency.

(45.00 – 60.00)	50.000 – 50.500 MHz
Set the scope edge frequencies for fixed mode scope when the 45 to 60 MHz band is selected.	<ul style="list-style-type: none"> • Set the frequencies between 45.000 to 60.000 MHz range in 1 kHz steps. ▨ Up to 500 kHz band width can be specified, so either edge frequency will be set to the difference between higher and lower frequencies become 5 to 500 kHz automatically while setting another edge frequency.

◇ USB mouse operation

If you connect a USB mouse to the transceiver, a mouse pointer appears on the spectrum scope screen. Now, you can change the frequency by using the mouse.

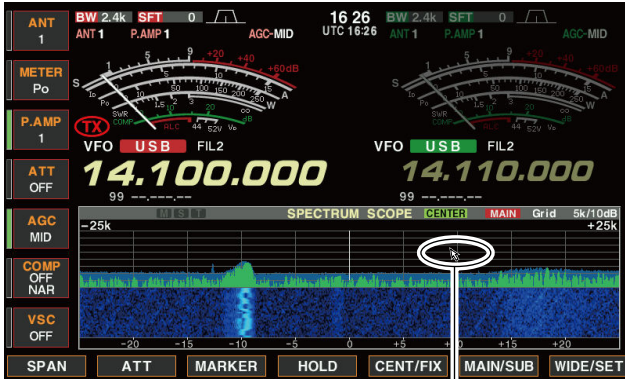

Mouse pointer

▨ The mouse changes the frequency that the scope is selected in either the Main or Sub band. Or while holding down [XFC], it changes the transmit frequency.

• Mouse operation on the Center mode

Button	Operation	Description
Left	Click	The frequency changes to the clicking point and mouse pointer move to the center of the screen.
	Drag	The frequency changes to the clicking point and mouse pointer move to the center of the screen, and then the frequency increases or decreases.
Right	Click/Drag	The Right button temporarily changes the frequency. While holding the button, same action as the Left button, but release it to return to the original frequency.

• Mouse operation on the Fix mode

Button	Operation	Description
Left	Click	The frequency and marker change to the clicking point.
	Drag	The frequency and marker change to the clicking point, and then the frequency increases or decreases.
Right	Click/Drag	The Right button temporarily changes the frequency. While holding the button, same action as the Left button, but release it to return to the original frequency.

■ Preamplifier

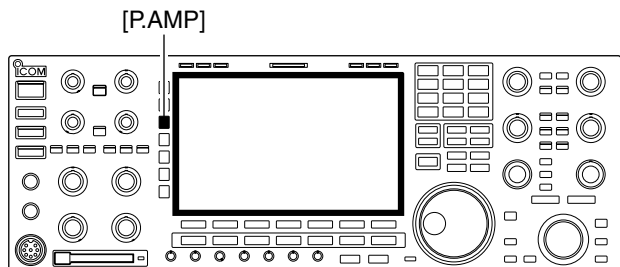

NOTE:
 The preamp (P.AMP1 or P.AMP2) cannot be used while the digital selector is activated.
 Also the preamp is automatically disabled when the digital selector is turned ON.

The preamp amplifies received signals in the receiver front end, to improve the S/N ratio and sensitivity. Set this to preamp 1 or preamp 2 when receiving weak signals.

➔ Push [P.AMP] several times to set the preamp OFF, preamp 1 ON or preamp 2 ON.

- P.AMP 1** For all HF bands
- P.AMP 2** High-gain preamp for 24 MHz band and above (Available for all HF and 50 MHz bands)

✓ About the "P.AMP2"

The "P.AMP 2" is a high gain receive amplifier. When the "P.AMP 2" is used during times of strong electric fields, distortion sometimes results. In such cases, use the transceiver with the "P.AMP 1" or "P.AMP OFF" setting.

The "P.AMP 2" is most effective when:

- Used on bands above 24 MHz and when electric fields are weak.
- Receive sensitivity is insufficient during low gain, or while using a narrow band antenna (such as small loop, a Beverage antenna or a short Yagi antenna).

■ Attenuator

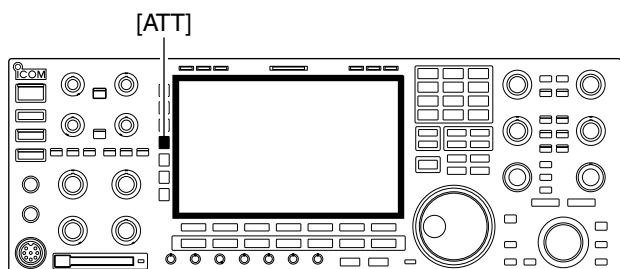

The attenuator prevents a desired signal from distortion when very strong signals are near the desired frequency or when very strong electric fields, such as from broadcasting stations, are near your location.

➔ Push [ATT] several times to set the attenuator 6 dB, 12 dB, 18 dB or attenuator OFF.

➔ Hold down [ATT] for 1 second several times to set the attenuator 3 dB, 6 dB, 9 dB, 12 dB, 15 dB, 18 dB, 21 dB or attenuator OFF.

- | | | | |
|-----------------|-------------------|-----------------|-------------------|
| ATT 3dB | 3 dB attenuation | ATT 15dB | 15 dB attenuation |
| ATT 6dB | 6 dB attenuation | ATT 18dB | 18 dB attenuation |
| ATT 9dB | 9 dB attenuation | ATT 21dB | 21 dB attenuation |
| ATT 12dB | 12 dB attenuation | | |

■ RIT function

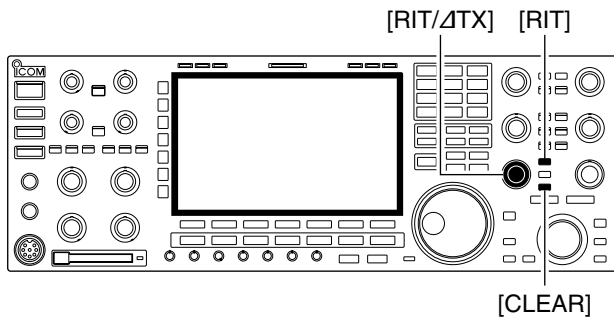

The RIT (Receive Increment Tuning) function compensates for off-frequencies of the communicating station.

The function shifts the receive frequency up to ± 9.99 kHz in 10 Hz steps without moving the transmit frequency.

- ① Push [RIT] to turn the RIT function ON or OFF.
 - “**RIT**” and the shifting frequency appear when the function is ON.
- ② Rotate the [RIT/ΔTX] control.
 - Hold down [CLEAR] for 1 second to reset the RIT frequency.
 - Push [CLEAR] momentarily to reset the RIT frequency when the quick RIT/ΔTX clear function is ON. (p. 12-18)
 - Hold down [RIT] for 1 second to add the shift frequency to the operating frequency.

◇ RIT monitor function

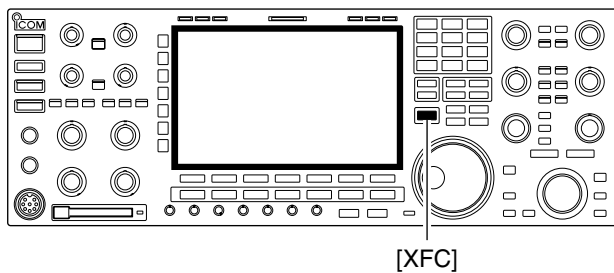

When the RIT function is ON, holding down [XFC] allows you to monitor the operating frequency directly (RIT is temporarily cancelled).

✓ *For your convenience— Calculate function*

The shift frequency of the RIT function can be added/subtracted to the displayed frequency.

- ➔ While displaying the RIT shift frequency, hold down [RIT] for 1 second.
-

AGC function

[AGC] control for main [AGC] control for sub

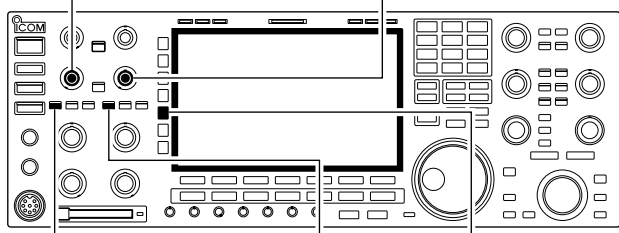

[AGC VR] for main [AGC VR] for sub [AGC]

The AGC (auto gain control) controls receiver gain to produce a constant audio output level even when the received signal strength varies greatly.

The transceiver has 3 preset AGC characteristics (time constant: fast, mid, slow) for non-FM mode.

The FM mode AGC time constant is fixed as 'FAST' (0.1 seconds) and AGC time constant cannot be selected.

Selecting the preset value

- ① Select non-FM mode.
- ② Push [AGC] several times to select AGC fast, AGC medium (MID) or AGC slow.
 - Hold down [AGC VR] for 1 second to turn the AGC function OFF.

Adjusting the AGC time constant

- ① Select non-FM mode.
- ② Push [AGC VR], then rotate [AGC] control to adjust the AGC time constant.
 - [AGC VR] indicator above the switch lights green.

Setting the AGC time constant preset value



- ① Select the desired mode (not FM mode).
- ② Hold down [AGC] for 1 second to enter AGC set mode.
- ③ Push [AGC] several times to select FAST time constant.
- ④ Rotate the main dial to set the desired time constant for 'AGC FAST.'
 - AGC time constant can be set between 0.1 to 8.0 seconds (depends on mode) or turned OFF.
 - Hold down [F-4•DEF] for 1 second to select a default value.
- ⑤ Push [AGC] to select medium time constant.
- ⑥ Rotate the main dial to set the desired time constant for 'AGC MID.'
 - AGC time constant can be set between 0.1 to 8.0 seconds (depends on mode) or turned OFF.
 - Hold down [F-4•DEF] for 1 second to select a default value.
- ⑦ Push [AGC] to select slow time constant.
- ⑧ Rotate the main dial to set the desired time constant for 'AGC SLOW.'
 - AGC time constant can be set between 0.1 to 8.0 seconds (depends on mode) or turned OFF.
 - Hold down [F-4•DEF] for 1 second to select a default value.
- ⑨ Select another mode (not FM). Repeat steps ③ to ⑧ if desired.
- ⑩ Push [EXIT/SET] to exit the AGC set mode screen.

Selectable AGC time constant (unit: sec.)

Mode	Default	Selectable AGC time constant
SSB	0.3 (FAST)	0.1, 0.2, 0.3, 0.5, 0.8, 1.2, 1.6, 2.0, 2.5, 3.0, 4.0, 5.0, 6.0
	2.0 (MID)	
	6.0 (SLOW)	
CW	0.1 (FAST)	0.1, 0.2, 0.3, 0.5, 0.8, 1.2, 1.6, 2.0, 2.5, 3.0, 4.0, 5.0, 6.0
	0.5 (MID)	
	1.2 (SLOW)	
RTTY PSK	0.1 (FAST)	0.1, 0.2, 0.3, 0.5, 0.8, 1.2, 1.6, 2.0, 2.5, 3.0, 4.0, 5.0, 6.0
	0.5 (MID)	
	1.2 (SLOW)	
AM	3.0 (FAST)	0.3, 0.5, 0.8, 1.2, 1.6, 2.0, 2.5, 3.0, 4.0, 5.0, 6.0, 7.0, 8.0
	5.0 (MID)	
	7.0 (SLOW)	
FM	0.1 (FAST)	Fixed

■ Twin PBT operation

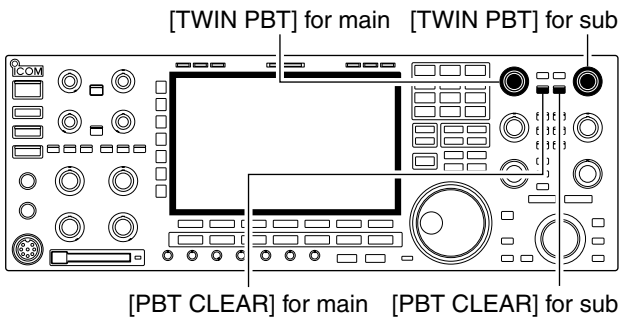

In general PBT (Passband Tuning) electronically narrows the IF passband width by shifting the IF frequency to slightly outside of the IF filter passband to reject interference. The IC-7800 uses DSP for the PBT function. Moving both [TWIN PBT] controls to the same position shifts the IF.

- The LCD shows the passband width and shift frequency graphically.
- Hold down [FILTER] for 1 second to enter the filter set screen. Current passband width and shift frequency is displayed in the filter set screen.
- To set the [TWIN PBT] controls to the center positions, hold down [PBT CLR] for 1 second.

The variable range depends on the passband width and mode. The edge of the variable range is half of the passband width, and PBT is adjustable in 25 Hz steps in the SSB/CW/RTTY/PSK modes, and 100 Hz in the AM mode.

Shows filter width, shifting value and condition



- [TWIN PBT] should normally be set to the center positions (PBT setting is cleared) when there is no interference.
- When PBT is used, the audio tone may be changed.
- Not available for FM mode.
- While rotating [TWIN PBT], noise may occur. This comes from the DSP unit and does not indicate an equipment malfunction.

• PBT operation example

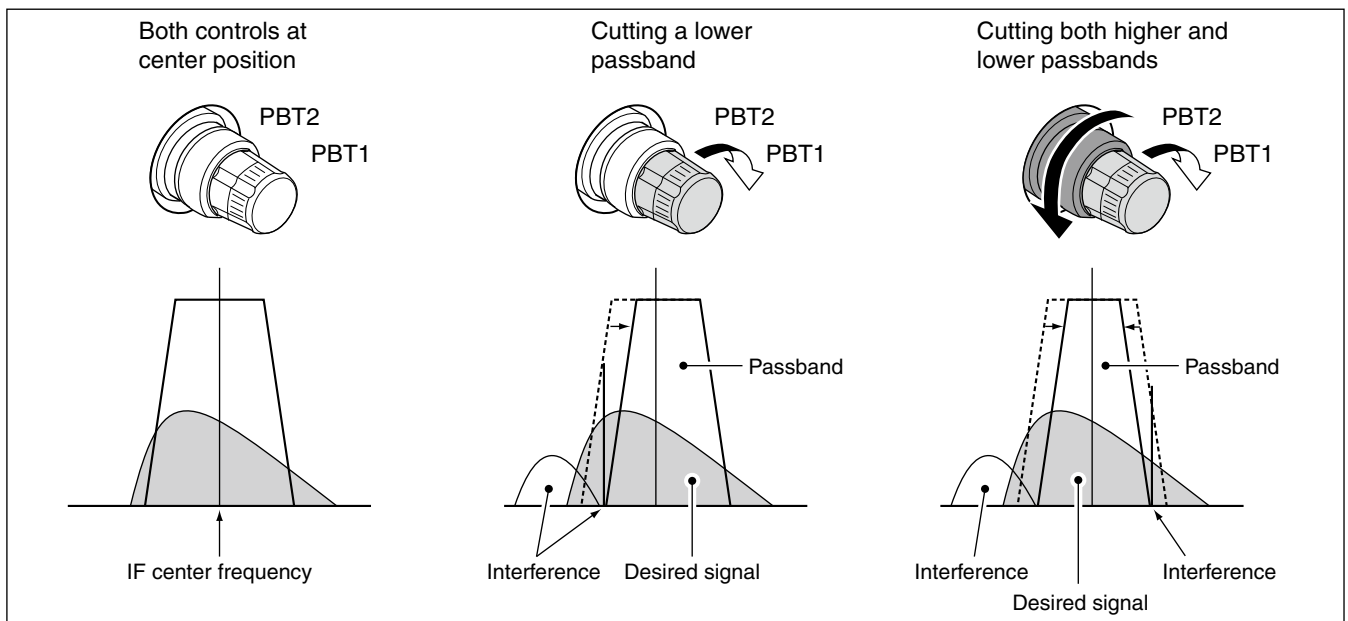

IF filter selection

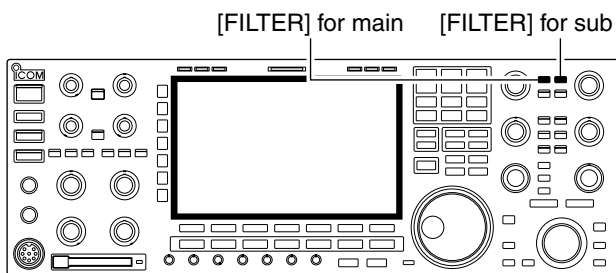

- ▨ The filter selection is automatically memorized in each mode.
- ▨ The PBT shift frequencies are automatically memorized in each filter.

The transceiver has 3 passband width IF filters for each mode.

For SSB, CW and PSK modes, the passband width can be set within 50 to 3600 Hz in 50 or 100 Hz steps. A total of 41 passband widths are available.

For RTTY mode, the passband width can be set within 50 to 2700 Hz in 50 or 100 Hz steps. A total of 32 passband widths are available.

For AM mode, the passband width can be set within 200 Hz to 10 kHz in 200 Hz steps. A total of 50 passband widths are available.

For FM mode, the passband width is fixed and 3 passband widths are available.

◇ IF filter selection

- ① Select the desired mode.
- ② Push [FILTER] several times to select the IF filter 1, 2 or 3.
 - The selected passband width and filter number is displayed in the LCD.

◇ Filter passband width setting (except FM mode)



- During the passband width setting



- ① Hold down [FILTER] for 1 second to enter filter set screen.
- ② Select any mode except FM.
 - Passband widths for FM modes are fixed, and cannot be adjusted.
- ③ Push [FILTER] several times to select the desired IF filter.
- ④ Push [F-1•BW], then rotate the main dial to adjust the desired passband width. Then push [F-1•BW] again.
 - While holding down [F-1•BW], rotating the main dial also adjusts the passband width. After adjustment, release [F-1•BW] to set.
- ⑤ If desired, repeat steps ② to ④.
 - Hold down [F-4•DEF] for 1 second to select the default value.
- ⑥ Push [EXIT/SET] to exit filter set screen.

▨ The PBT shift frequencies are cleared when the passband width is changed.

▨ This filter set screen graphically displays the PBT shift frequencies and CW pitch operations.

Mode	IF filter	Adjustable range (steps)
SSB	FIL1 (3.0 kHz)	50 to 500 Hz (50 Hz)
	FIL2 (2.4 kHz)	600 Hz to 3.6 kHz (100 Hz)
	FIL3 (1.8 kHz)	
SSB-D CW PSK	FIL1 (1.2 kHz)	50 to 500 Hz (50 Hz)
	FIL2 (500 Hz)	600 Hz to 3.6 kHz (100 Hz)
	FIL3 (250 Hz)	
RTTY	FIL1 (2.4 kHz)	50 to 500 Hz (50 Hz)
	FIL2 (500 Hz)	600 Hz to 2.7 kHz (100 Hz)
	FIL3 (250 Hz)	
AM AM-D	FIL1 (9.0 kHz)	200 Hz to 10 kHz (200 Hz)
	FIL2 (6.0 kHz)	
	FIL3 (3.0 kHz)	
FM FM-D	FIL1 (15 kHz)	Fixed
	FIL2 (10 kHz)	
	FIL3 (7.0 kHz)	

◇ Roofing filter selection



The IC-7800 has 3, 6 and 15 kHz roofing filters at the 1st IF frequency. The roofing filter provides interference reduction from nearby strong signals.

- ① Hold down [FILTER] for 1 second to enter filter set screen.
- ② Select any mode except FM.
- ③ Push [F-6•ROOFING] to select the desired filter width from 15 kHz (default), 6 kHz and 3 kHz.
 - Hold down [F-4•DEF] for 1 second to select a default value.
- ④ Push [EXIT•SET] to exit filter set screen.

◇ DSP filter shape



The type of DSP filter shape for each SSB, SSB data and CW can be selected independently from soft and sharp.

- ① Hold down [FILTER] for 1 second to enter filter set screen.
- ② Select SSB, SSB data or CW mode.
- ③ Push [F-7•SHAPE] to select the desired filter shape from soft and sharp.
- ④ Push [EXIT•SET] to exit filter set screen.

The filter shape can be set for each band (HF and 50 MHz bands), mode, as well as the passband width setting (CW only) independently as your default setting in filter shape set mode.

◇ Filter shape set mode

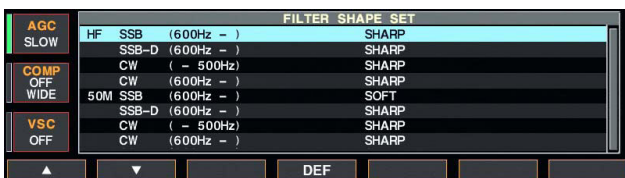

The type of DSP filter shape for each SSB, SSB data and CW can be selected independently from soft and sharp.

- ① Hold down [FILTER] for 1 second to enter filter set screen.
- ② Hold down [F-7•SHAPE] for 1 second to enter filter shape set mode.
- ③ Push [F-1•▲] or [F-2•▼] to select the desired item.
- ④ Rotate the main dial to select the filter shape from soft and sharp.
- ⑤ Push [EXIT/SET] to exit filter shape set mode.

<p>HF SSB (600Hz -)</p> <p>Select the filter shape for SSB mode in HF bands.</p>	<p>SHARP</p> <p>▨ The set filter shape is automatically used only when the IF filter is set to 600 Hz or wider.</p>
--	--

<p>SSB-D (600Hz -)</p> <p>Select the filter shape for SSB data mode in HF bands.</p>	<p>SHARP</p> <p>▨ The set filter shape is automatically used only when the IF filter is set to 600 Hz or wider.</p>
--	--

◇ Filter shape set mode (continued)

CW (- 500Hz)	SHARP
Select the filter shape for CW mode in HF bands.	▨ The set filter shape is automatically used only when the IF filter is set to 500 Hz or narrower.

CW (600Hz -)	SHARP
Select the filter shape for CW mode in HF bands.	▨ The set filter shape is automatically used only when the IF filter is set to 600 Hz or wider.

50M SSB (600Hz -)	SOFT
Select the filter shape for SSB mode in 50 MHz band.	▨ The set filter shape is automatically used only when the IF filter is set to 600 Hz or wider.

SSB-D (600Hz -)	SHARP
Select the filter shape for SSB data mode in 50 MHz band.	▨ The set filter shape is automatically used only when the IF filter is set to 600 Hz or wider.

CW (- 500Hz)	SHARP
Select the filter shape for CW mode in 50 MHz band.	▨ The set filter shape is automatically used only when the IF filter is set to 500 Hz or narrower.

CW (600Hz -)	SHARP
Select the filter shape for CW mode in 50 MHz band.	▨ The set filter shape is automatically used only when the IF filter is set to 600 Hz or wider.

Dualwatch operation

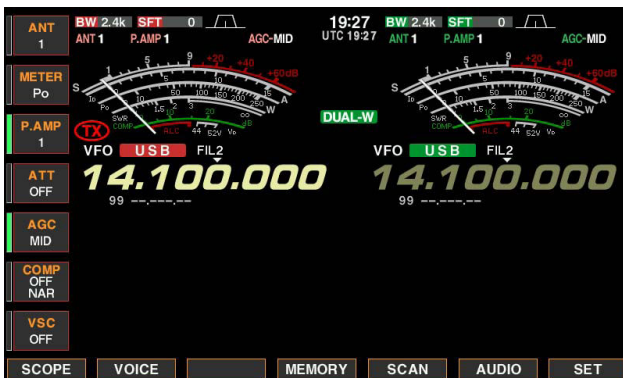
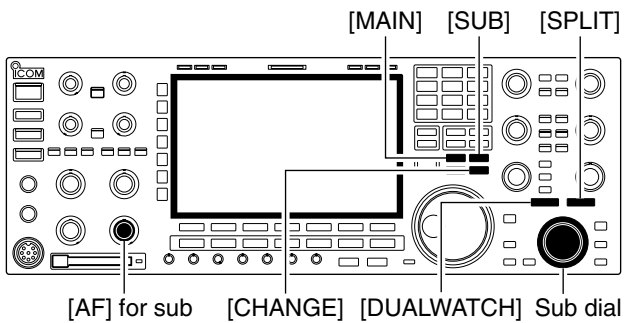

Split frequency operation during dualwatch



Dualwatch monitors 2 frequencies simultaneously. The IC-7800 has 2 independent receiver circuits so that you can use dualwatch with no compromises, even on different bands and modes.

- ① Set the desired frequency and mode into the main band.
- ② Push [DUALWATCH].
 - “DUAL-W” appears.
 - Holding down [DUALWATCH] for 1 second, the sub band is equalized at the same time. This quick dualwatch function can be turned OFF in set mode. (p. 12-15)
- ③ Rotate the sub dial to set the desired frequency.
- ④ Push [SUB] to enables the sub band access when changing the frequency band, operating mode, etc. in sub band.
 - Push [MAIN] for the main band access.
- ⑤ Rotate [AF] for sub band to adjust the sub band audio level.
- ⑥ To transmit on the sub band readout, push [CHANGE] or [SPLIT].

NOTE:

- A beat note may be heard depending on the frequency combination.
- Receiver sensitivity will be decreased when the same frequency band and the same antenna are selected during dualwatch.
- The RIT function can be used for the main readout only.
- The Δ TX function can be used for the transmit readout (main readout when the split function OFF; sub readout when the split function ON).

■ Noise blanker

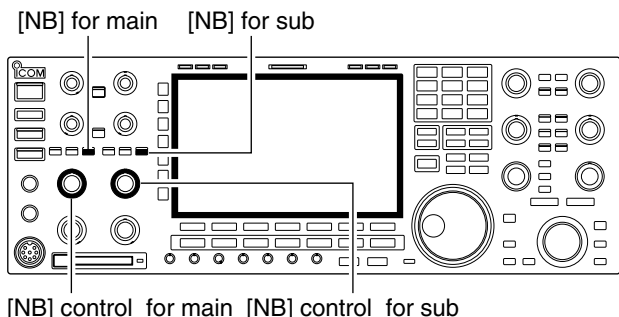

The noise blanker eliminates pulse-type noise such as the noise from car ignitions. The noise blanker is not available for FM mode.

- ① Push [NB] to turn the noise blanker function ON or OFF.
 - [NB] indicator above their switch lights green.
- ② Rotate [NB] control to adjust the noise blanker threshold level.

When using the noise blanker, received signals may be distorted if they are excessively strong or the noise type is other than impulse. Turn the noise blanker OFF, or rotate [NB] control to a shallow position in this case.

◇ NB set mode

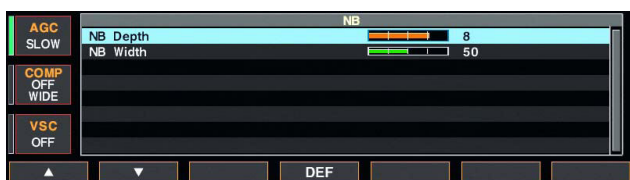

To deal with various type of noises, attenuation level and noise width can be set in NB set mode.

- ① Hold down [NB] for 1 second to enter NB set mode.
- ② Push [F-1•▲] or [F-2•▼] to select the desired item.
- ③ Rotate the main dial to set the desired level or value.
 - Hold down [F-4•DEF] for 1 second to select a default value.
- ④ Push [EXIT/SET] to exit NB set mode.

NB Depth 8

Set the noise attenuation level from 1 to 10.

NB Width 50

Set the noise pulse width from 1 to 100.

■ Noise reduction

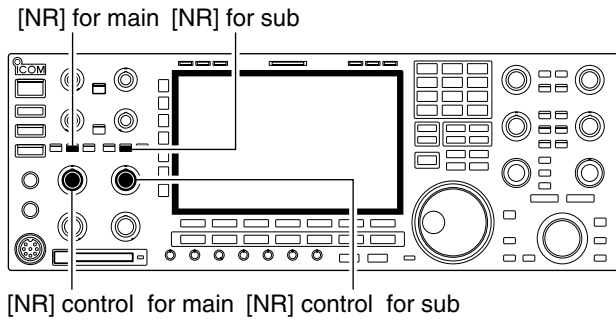

The noise reduction function reduces random noise components and enhances desired signals which are buried in noise. The DSP does the random noise reduction function.

- ① Push the [NR] to turn the noise reduction ON.
 - [NR] indicator above their switch lights green.
- ② Rotate the [NR] control to adjust the noise reduction level.
- ③ Push the [NR] switch to turn the noise reduction OFF.
 - [NR] indicator lights off.

Deep rotation of the [NR] control results in audio signal masking or distortion. Set the [NR] control for maximum readability.

■ Dial lock function

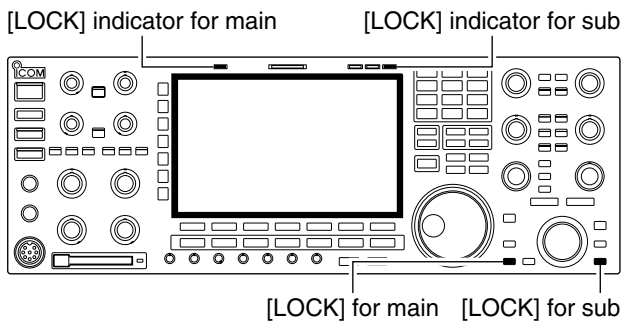

The dial lock function prevents frequency changes by accidental movement of the tuning dial. The lock function electronically locks the dial.

- ➔ Push [LOCK] to toggle the dial lock function ON or OFF.
 - The [LOCK] indicator lights when the dial lock function is in use.

■ Notch function

This transceiver has auto and manual notch functions. The auto notch function uses DSP to automatically attenuates beat tones, tuning signals, etc., even if they are moving. The manual notch can be set to attenuate a frequency via the [NOTCH] control.

The auto notch can be used in SSB, AM and FM modes.

The manual notch can be used in SSB, CW, RTTY, PSK and AM modes.

• Auto notch indication



➤ Push [NOTCH] to toggle the notch function between auto, manual and OFF in SSB and AM modes.

➤ Push [NOTCH] to turn the manual notch function ON or OFF in CW mode.

➤ Push [NOTCH] to turn the auto notch function ON or OFF in FM mode.

• Manual notch indication



- [NOTCH] indicator above their switch lights green.

- Hold down [NOTCH] for 1 second to select the notch filter width for manual notch from wide, middle and narrow.

- Set to attenuate a frequency for manual notch via the [NOTCH] control.

- “AN” appears when auto notch is in use.

- “MN” appears when manual notch is in use.

⚠ While tuning the manual notch, noise may be heard. This comes from the DSP unit and does not indicate an equipment malfunction.

■ Digital selector

[DIGI-SEL] control for main [DIGI-SEL] control for sub

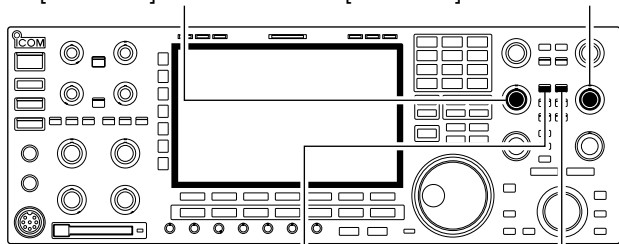

[DIGI-SEL] for main [DIGI-SEL] for sub

The digital selector manually adjusts the center frequency of the automatic pre-selector. The digital selector functions within 1.5 MHz to 29.999999 MHz range.

The automatic pre-selector adds selectivity ahead of the 1st mixer. This reduces intermodulation distortion from the nearby strong signals.

The automatic pre-selector tracks the frequency tuning, changing it's resonant frequency in discrete steps.

① Push [DIGI-SEL] to turn the digital selector ON or OFF.

- [DIGI-SEL] indicator above their switch lights green.

② Rotate [DIGI-SEL] control to adjust the center frequency.

NOTE:

- When rotating the main dial (or sub dial during dualwatch or split function) while the digital selector is activated, mechanical noise may be heard due to the switching noise from internal relays.

- The preamp (P.AMP1 or P.AMP2) cannot be used while the digital selector is activated.

■ Audio scope screen

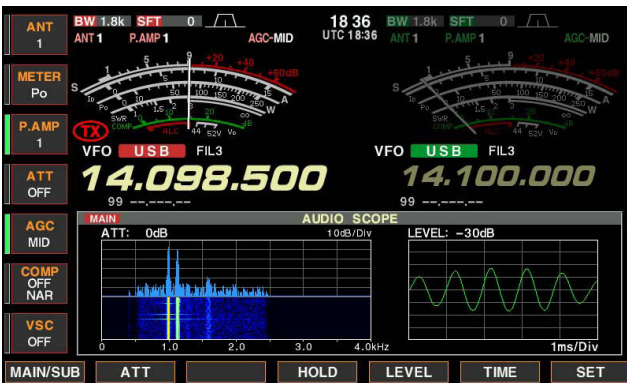
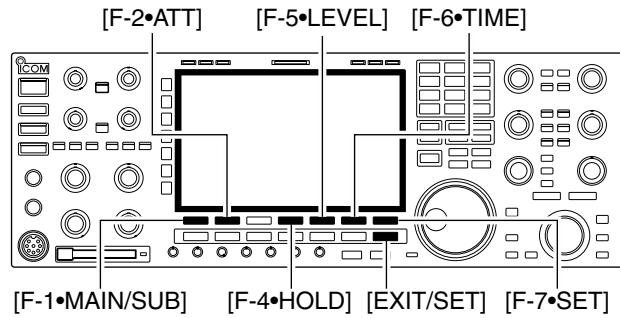

• Audio scope

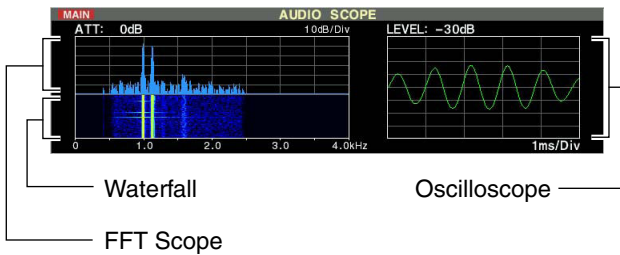

This audio scope allows you to display the received signal's frequency component to the FFT scope, and its waveform component to the Oscilloscope. The FFT scope has an waterfall.

- ① Push [EXIT/SET] several times to close a multi-function screen, if necessary.
- ② Push [F-5•AUDIO] to select the scope screen.
- ③ Push [F-1•MAIN/SUB] to select the band.
 - "MAIN" is displayed when the main band is selected.
 - "SUB" is displayed when the sub band is selected.
- ④ Push [F-2•ATT] several times to activate an attenuator or turn OFF the attenuator for the FFT scope.
 - 0 (OFF), 10, 20 and 30 dB attenuators are selectable.
 - Holding down [F-2•ATT] for 1 second to turn the attenuator OFF.
- ⑤ Push [F-5•LEVEL] to select the level setting for the Oscilloscope.
 - 0, -10, -20 and -30 dB are selectable.
- ⑥ Push [F-6•TIME] several times to select the time setting for the Oscilloscope.
 - 1, 3, 10, 30, 100 and 300 ms/Div are selectable.
- ⑦ Push [F-4•HOLD] to freeze the current audio waveform.
 - "HOLD" appears while the function is in use.
- ⑧ Push [EXIT/SET] to exit the scope screen.

⚡ When the Monitor function is ON, you can see the TX audio on the Audio scope.

◇ Audio scope set mode

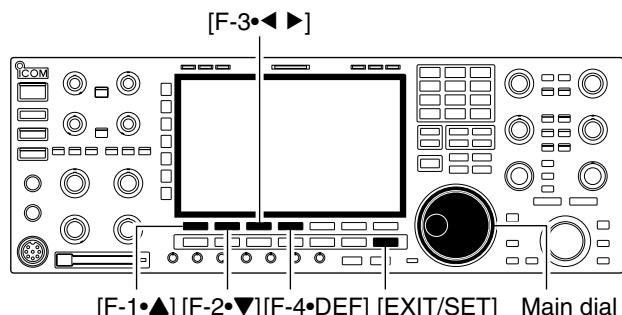

This set mode is used to set the FFT scope waveform type, color, waterfall display and oscilloscope waveform color.

- ① During audio scope display is ON, push [F-7•SET] to select the Audio scope set mode screen.
- ② Push [F-1•▲] or [F-2•▼] to select the desired set item.
- ③ Set the desired condition using the main dial.
 - Hold down [F-4•DEF] for 1 second to select the default condition or value.
 - Push [F-3•◀▶] to select the set contents for some items.
- ④ Push [EXIT/SET] to exit from set mode.

FFT Scope Waveform Type	Fill
Select the waveform type for the FFT scope.	<ul style="list-style-type: none"> • Fill : The waveform is represented by the color. • Line : The waveform is represented by outline.

FFT Scope Waveform Color	51 153 255
Set the waveform color for the FFT scope.	<ul style="list-style-type: none"> • The color is set in RGB format. • Push [F-3•◀▶] to select R (Red), G (Green) and B (Blue), and rotate the ratio from 0 to 255 range. • The set color is indicated in the box beside the RGB scale.

FFT Scope Waterfall Display	ON
Select the waterfall display ON or OFF.	<ul style="list-style-type: none"> • ON : Displays the waterfall on the FFT scope. • OFF : Does not display the waterfall.

Oscilloscope Waveform Color	0 255 0
Set the waveform color for the Oscilloscope.	<ul style="list-style-type: none"> • The color is set in RGB format. • Push [F-3•◀▶] to select R (Red), G (Green) and B (Blue), and rotate the ratio from 0 to 255 range. • The set color is indicated in the box beside the RGB scale.

■ VOX function	6-2
◇ Using the VOX function	6-2
◇ Adjusting the VOX function	6-2
◇ VOX set mode	6-2
■ Break-in function	6-3
◇ Semi break-in operation	6-3
◇ Full break-in operation	6-3
■ ΔTX function	6-4
◇ ΔTX monitor function	6-4
■ Monitor function	6-4
■ Transmit filter width setting (SSB only)	6-5
■ Speech compressor (SSB only)	6-5
■ Split frequency operation	6-6
■ Quick split function.....	6-7
◇ Split lock function	6-7

■ VOX function

The VOX (Voice-Operated Transmission) function switches between transmit and receive with your voice. This function provides “hands-free” operation.

◇ Using the VOX function

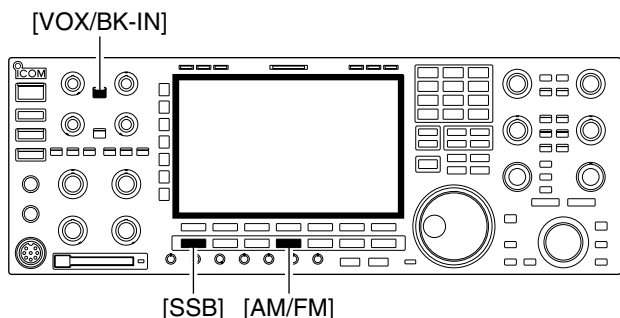

- ① Select a phone mode (SSB, AM, FM).
- ② Push [VOX/BK-IN] to turn the VOX function ON or OFF.
 - “VOX” appears while the VOX is in use.
 - [VOX/BK-IN] indicator above this switch lights green.

◇ Adjusting the VOX function

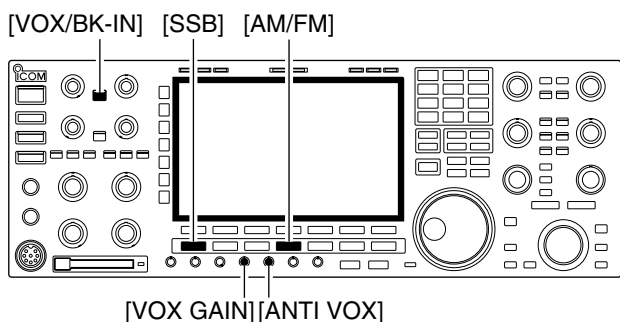

- ① Select a phone mode (SSB, AM, FM).
- ② Push [VOX/BK-IN] to turn VOX function ON.
- ③ While speaking into the microphone with your normal voice level, rotate [VOX GAIN] to the point where the transceiver is continuously transmitting.
- ④ During receive, rotate [ANTI VOX] to the point where the transceiver does not switch to transmit due to received audio from the speaker.
- ⑤ Adjust the VOX delay and the VOX voice delay in VOX set mode, if necessary.

◇ VOX set mode



- ① Hold down [VOX/BK-IN] for 1 second to enter VOX set mode.
- ② Select the desired item using [F-1•▲] or [F-2•▼].
- ③ Rotate the main dial to the desired set value or condition.
 - Hold down [F-4•DEF] for 1 second to select a default value.
- ④ Push [EXIT/SET] to exit VOX set mode.

VOX Delay



Set the VOX delay for a convenient interval before returning to receive within 0 to 2.0 seconds range.

VOX Voice Delay

Short

Set the VOX voice delay to prevent mis-transmission of your voice when switching to transmit. Short, Mid., Long and OFF settings are available.

When using the VOX voice delay, turn the TX monitor function OFF, the transmitted audio will be echoed.

■ Break-in function

The break-in function is used in CW mode to automatically toggle the transceiver between transmit and receive when keying. The IC-7800 is capable for full break-in or semi break-in.

◇ Semi break-in operation

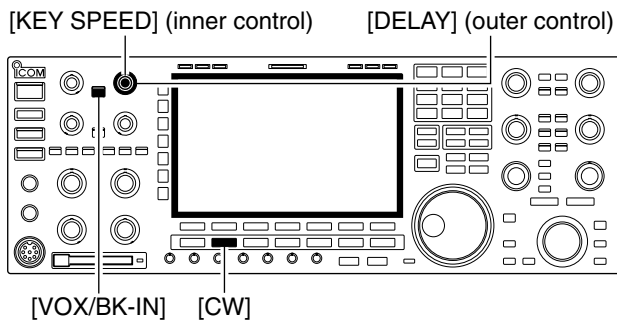

- ① Push [CW] to select CW or CW-R mode.
- ② Push [VOX/BK-IN] several times to turn the semi break-in function ON.
 - “BK IN” appears.
- ③ Rotate [DELAY] to set the break-in delay time (the delay from transmit to receive).

▨ When using a paddle, rotate [KEY SPEED] to adjust the keying speed.

◇ Full break-in operation



During full break-in operation, the transceiver automatically selects transmit while keying and returns to receive immediately after keying is finished.

- ① Push [CW] to select CW or CW-R mode.
- ② Push [VOX/BK-IN] several times to turn the full break-in function ON.
 - “F-BK IN” appears.

▨ When using a paddle, rotate [KEY SPEED] to adjust the keying speed.

■ Δ TX function

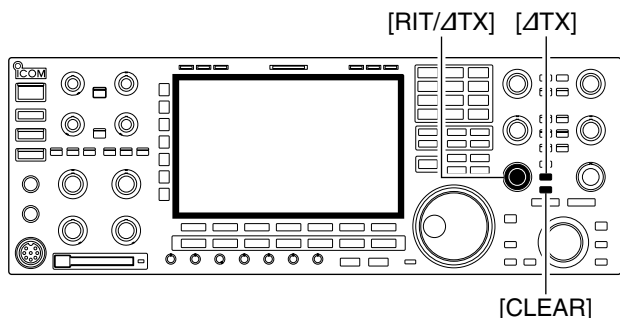

The Δ TX function shifts the transmit frequency up to ± 9.999 kHz in 1 Hz steps (10 Hz steps when cancelling the 1 Hz step readout) without moving the receive frequency.

• See 93 on p. 1-11 for function description.

- ① Push [Δ TX].
 - “ Δ TX” appears.
- ② Rotate [RIT/ Δ TX].
- ③ To reset the Δ TX frequency, hold down [CLEAR] for 1 second.
 - Push [CLEAR] momentarily to reset the RIT frequency when the quick RIT/ Δ TX clear function is ON. (p. 12-18)
- ④ To cancel the Δ TX function, push [Δ TX] again.
 - “ Δ TX” disappears.

◇ Δ TX monitor function

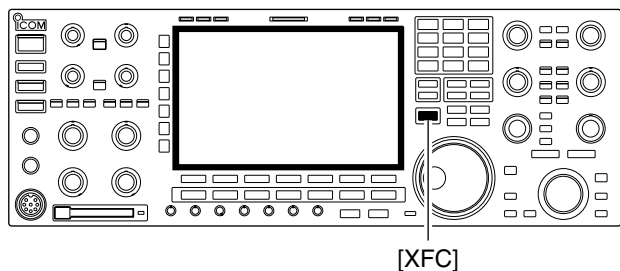

When the Δ TX function is ON, holding down [XFC] allows you to monitor the operating frequency directly.

✓ For your convenience— Calculate function

The shift frequency of the Δ TX function can be added/subtracted to the displayed frequency.

- ➔ While displaying the Δ TX shift frequency, hold down [Δ TX] for 1 second.

■ Monitor function

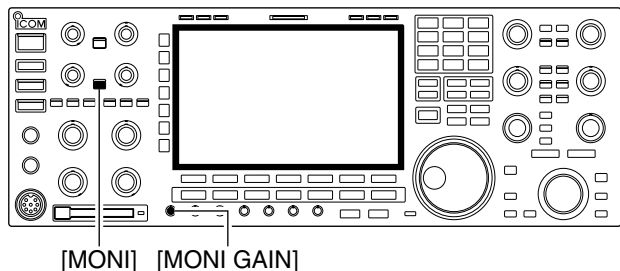

The monitor function allows you to monitor your transmit IF signals in any mode. Use this to check voice characteristics while adjusting SSB transmit parameter. (p. 12-4) The CW sidetone functions regardless of the [MONI] switch setting.

- ① Push [MONI] to switch the monitor function ON or OFF.
 - [MONI] indicator above this switch lights green.
- ② Rotate [MONI GAIN] for the clearest audio output while holding [PTT] and speaking into the microphone.

NOTE: When using the VOX voice delay, turn the monitor function OFF; or transmitted audio will be echoed.

■ Transmit filter width setting (SSB only)

The transmit filter width for SSB mode can be selected from wide, middle and narrow.

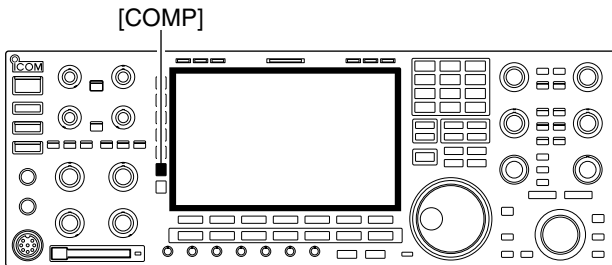

➔ During USB or LSB mode selection, hold down [COMP] for 1 second several times to select the desired transmit filter width from wide, middle and narrow.

- The filter functions regardless of the speech compressor use.
- The following filters are specified as the default. Each of the filter width can be re-set in level set mode. (p. 12-5)

WIDE	: 100 Hz to 2.9 kHz
MID	: 300 Hz to 2.7 kHz
NAR	: 500 Hz to 2.5 kHz

■ Speech compressor (SSB only)

The speech compressor increases average RF output power, improving signal strength and readability in SSB mode only.

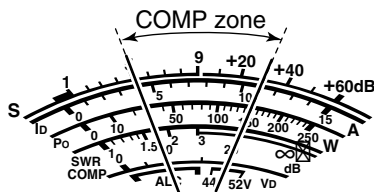
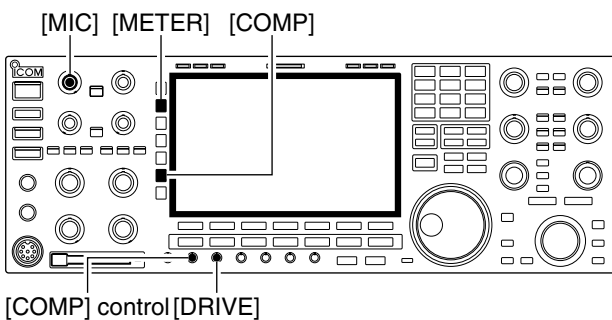

- ① Select USB or LSB mode and adjust [MIC] to a suitable level.
 - Push [METER] several times to select the ALC meter for microphone gain adjustment.
- ② Push [COMP] to turn the speech compressor ON.
- ③ Push [METER] once to select the COMP meter.
- ④ While speaking into the microphone, rotate [COMP] control, so that the COMP meter reads within the COMP zone (10 to 20 dB range) with your normal voice level.
 - ▨ When the COMP meter peaks exceed the COMP zone, your transmitted voice may be distorted.
- ⑤ Push [METER] 5 times to select the ALC meter.
- ⑥ While speaking into the microphone, rotate [DRIVE], so that the ALC meter reads within the 30 to 50% range of the ALC zone with your normal voice level.

✓ For your convenience

Hold down [METER] for 1 second to display the multi-function meter that can check the ALC and COMP level at a glance.

Split frequency operation

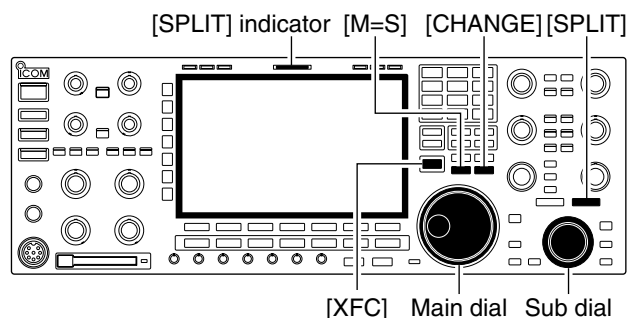

When the split function ON



When [XFC] is pushed



The split frequency operation is ready

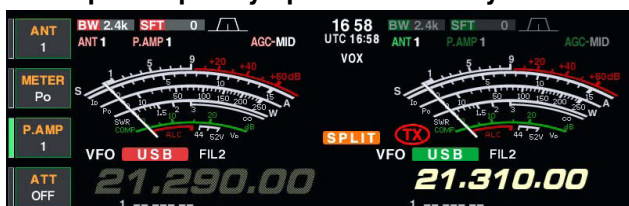

Split frequency operation allows you to transmit and receive in the same mode on two different frequencies. The split frequency operation is performed using 2 frequencies on the main and sub readouts.

The following is an example of setting 21.290 MHz for receiving and 21.310 MHz for transmitting.

- ① Set 21.290 MHz (USB) in VFO mode.
- ② Push [SPLIT] momentarily, then hold down [M=S] for 1 second.
 - The quick split function is much more convenient for selecting the transmit frequency. See the next section for details.
 - The equalized transmit frequency and “**SPLIT**” appear on the LCD.
 - [SPLIT] indicator lights.
 - “TX” appears to show the transmit frequency readout.
- ③ Set the transmit frequency to 21.310 MHz in one of following ways.
 - Rotate the main dial while holding down [XFC].
 - Rotate the sub dial.
 - The transmit frequency can be monitored while holding down [XFC] or using dualwatch.
- ④ Now you can receive on 21.290 MHz and transmit on 21.310 MHz.

To change the transmit and receive frequencies, push [CHANGE] to exchange the main and sub readouts.

✓ CONVENIENT

Direct shift frequency input

The shift frequency can be entered directly.

- ① Push [F-INP•ENT].
- ② Enter the desired shift frequency with the digit keys.
 - 1 kHz to 9.999 MHz can be set.
 - When you require a minus shift direction, push [GENE•.] in advance.
- ③ Push [SPLIT].
 - The shift frequency is input in the sub readout and the split function is turned ON.

[Example]

To transmit on 1 kHz higher frequency:

- Push [F-INP•ENT], [1.8•1] then [SPLIT].

To transmit on 3 kHz lower frequency:

- Push [F-INP•ENT], [GENE•.], [7•3] then [SPLIT].

Split lock function

Accidentally releasing [XFC] while rotating the main dial changes the receive frequency. To prevent this, use both the split lock and dial lock functions to change the transmit frequency only. The split lock function cancels the dial lock function while holding down [XFC] during split frequency operation.

The dial lock's effectiveness during split frequency operation can be selected in the set mode for both receive and transmit frequencies; or only the receive frequency. (p. 12-16)

■ Quick split function

When you find a DX station, an important consideration is how to set the split frequency.

When you hold down the [SPLIT] switch for 1 second, split frequency operation is turned ON, the sub readout is equalized to the main readout frequency and enters standby for transmit frequency input.

This shortens the time needed to start split frequency operation.

The quick split function is ON by default. For your convenience, it can be turned OFF in set mode. (p. 12-15) In this case, the [SPLIT] switch does not equalize the main and sub readout frequencies.

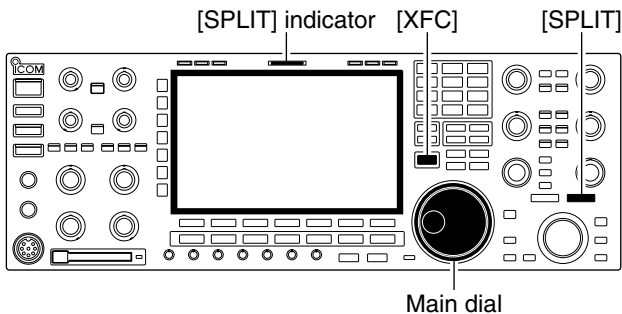

- ① Suppose you are operating at 21.290 MHz (USB) in VFO mode.
- ② Hold down [SPLIT] for 1 second.
 - Split frequency operation is turned ON.
 - The sub readout is equalized to the main readout frequency.
 - “**F-INP**” indicator appears and the sub readout enters standby for transmit frequency input.
- ③ Enter the desired offset frequency from the keypad then push [SPLIT], or set the transmit frequency with the main dial while pushing [XFC], or with the sub dial.
 - “**F-INP**” indicator disappears when [XFC] is pushed or the main/sub dial is rotated.
 - Offset frequency setting with the keypad— example
 To transmit on 1 kHz higher frequency:
 - Push [F-INP•ENT], [1.8•1] then [SPLIT].
 To transmit on 3 kHz lower frequency:
 - Push [F-INP•ENT], [GENE•], [7•3] then [SPLIT].

◇ Split lock function

The split lock function is convenient for changing only the transmit frequency. When the split lock function is not used, accidentally releasing [XFC] while rotating the main dial, changes the receive frequency. The split lock function is ON by default, but can be turned OFF in set mode. (p. 12-16)

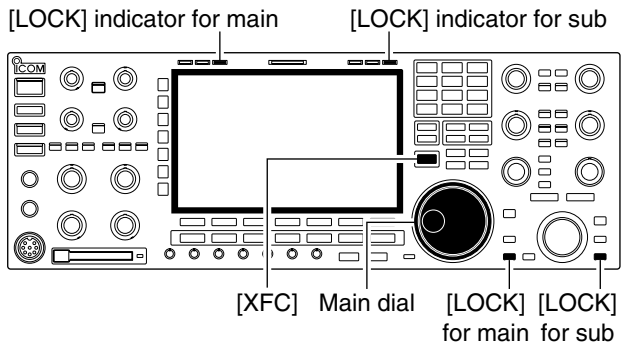

- ① While split frequency operation is ON, push [LOCK] for both main and sub band to activate the split lock function.
- ② While pushing [XFC], rotate the main dial to change the transmit frequency.
 - If you accidentally release [XFC] while rotating the main dial, the receive frequency does NOT change.

■ Recording a QSO audio	7-2
◇ To start or stop recording	7-2
■ Recording quick operation	7-2
◇ To start or stop recording	7-2
■ Playing back the recorded audio (QSO)	7-3
◇ Basic playing	7-3
◇ Operating while playing back	7-4
■ Deleting recorded audio file	7-5
■ Deleting recorded audio folder.....	7-5
■ About digital Voice Recorder	7-6
■ Recording a received audio (Short REC)	7-7
◇ One-touch recording	7-7
■ Playing back the recorded audio (Short REC)	7-7
◇ Basic playing	7-7
◇ One-touch playing	7-8
■ Protect the recorded contents	7-8
■ Erasing the recorded contents.....	7-8
■ Recording a message for transmit	7-9
◇ Recording	7-9
◇ Confirming a message for transmit.....	7-9
■ Programming a memory name	7-10
■ Sending a recorded message	7-11
◇ Single TX.....	7-11
◇ Repeat TX	7-11
◇ Transmit level setting	7-12
■ Voice set mode	7-12
■ Saving a voice memory into the memory device	7-15
◇ Saving the received audio memory	7-15
◇ Saving the TX memory	7-15

Recording a QSO audio

NOTE:

- Be sure to insert a CF memory card into the transceiver or connect a USB flash drive before recording a QSO audio.
- DO NOT insert or connect a memory device while recording a QSO audio to another memory device. Otherwise the recording may interrupt.
- Once recording starts, it continues, even if the transceiver is turned OFF and then ON again.

The Voice recorder function records a QSO (communication) audio onto a memory device. This function enables you to record both received and transmitted audio, a QSO with a DX'pedition, and playback the recorded audio after the QSO.

◇ To start or stop recording

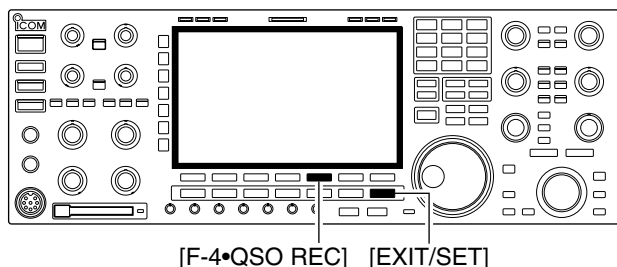

- ① Push [EXIT/SET] several times to close a multi-function screen, if necessary.
- ② Push [F-2•VOICE] to display the Voice Recorder menu.
- ③ Hold down [F-4•QSO REC] for 1 second to start voice recording.
 - The “■” indicator appears and either the “CF” or “USB” indicator blinks.
 - Recording is continuous until you manually stop recording, or the memory device becomes full.
 - If the recording file's content reaches 2GB, the transceiver automatically creates a new file, and continues recording.
 - The “▣” indicator appears instead of the “■” indicator while recording is paused.
- ④ Hold down [F-4•QSO REC] for 1 second to stop recording.
 - The “■” indicator disappears and the “CF” or “USB” indicator stops blinking.
- ⑤ Push [EXIT/SET] to exit the Voice Recorder screen.

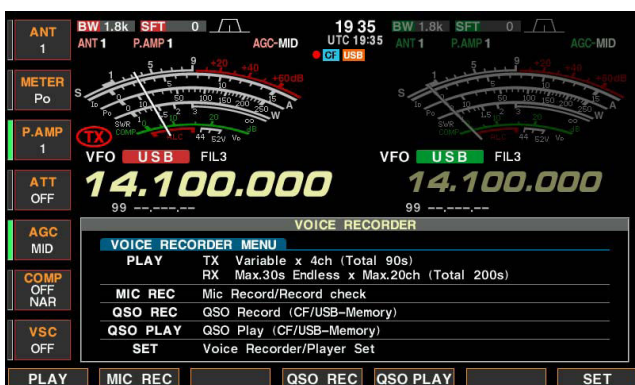

✓ Convenient!

When the PTT Automatic Recording function is set to ON in the Voice set mode, the recording automatically starts when you push [PTT]. (p. 7-14)

Recording quick operation

◇ To start or stop recording

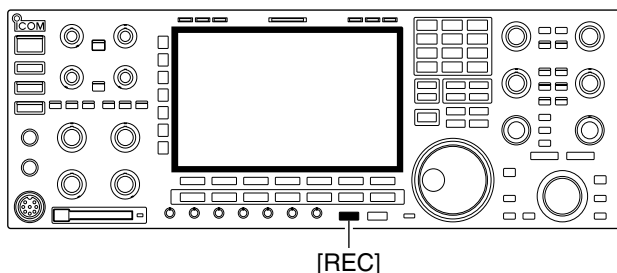

- ① Hold down [REC] for 1 second to start voice recording.
 - The “■” indicator appears and either the “CF” or “USB” indicator blinks.
- ② Hold down [REC] for 1 second again to stop recording.

■ Playing back the recorded audio (QSO)

◇ Basic playing

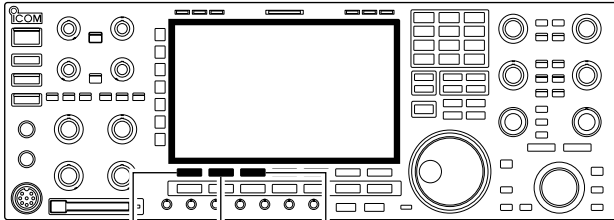

[F-1•▲] [F-2•▼] [F-3•PLAY]



Blinks

Progress bar
Shows the play back progress bar.

Total time
Shows the file's total playback time.

Played back time
Shows the played back time.

Playback mark
Appears while the audio is playing back.
• The mark disappears while pausing.

- ① Push [EXIT/SET] several times to close a multi-function screen, if necessary.
- ② Push [F-2•VOICE] to display the Voice Recorder menu.
- ③ Push [F-5•QSO PLAY] to call up the voice QSO player screen.
 - The folder list is displayed.
 - The folder name is formatted yyyyymmdd (yyyy: year, mm: month, dd: day).
- ④ Push [F-1•▲] or [F-2•▼] to select the folder that contains the file you want to play.
 - Rotating the main dial also selects the folder.
- ⑤ Push [F-3•FILE] to open the folder .
 - The file list is displayed.
 - The file name is formatted yyyy-mm-dd hh:mm:ss (yyyy: year, mm: month, dd: day, hh: hour, mm: minute, ss: second).
- ⑥ Push [F-1•▲] or [F-2•▼] to select the file that you want to play.
 - Rotating the main dial also selects the file.
- ⑦ Push [F-3•PLAY] to start playback.
 - The "CF" or "USB" indicator blinks.
 - Playback continues to next file, and it is terminated when the bottom file in the folder is played.
- ⑧ Push [EXIT/SET] several times to exit the QSO player screen.

■ Playing back the recorded audio (continued)

◇ Operating while playing back

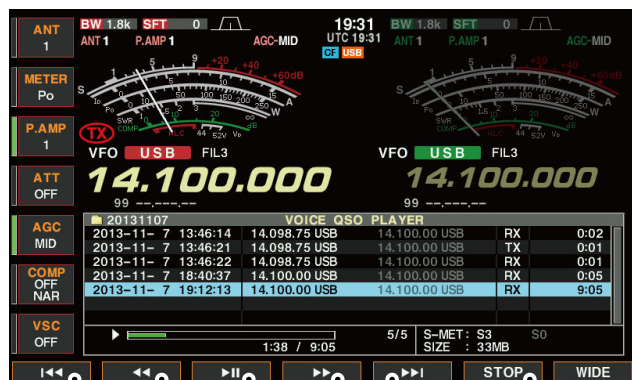
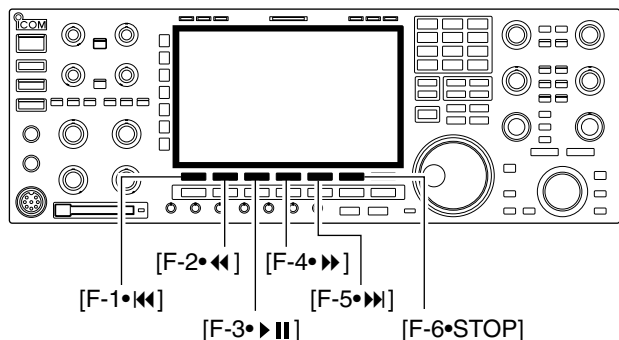

I◀◀ ◀◀ ▶▶ ▶▶▶ STOP WIDE
 Rewind Forward
 Play the previous file Play the next file
 Pause or play Stop playing

✓ Convenient!

You can fast forward or rewind the file that is playing by rotating the main dial.

The fast forward/rewind time is one twentieth of the total file time, regardless of the skip time setting.

Holding down the switch repeats the action until it is released (other than the [F-3▶▶] switch).

Example: Hold down [F-4▶▶] to repeat skipping 10 seconds until you release the [F-4▶▶] switch.

(Default: 10 seconds)

You can fast forward or rewind while playing back.

• Fast forward while playing

Push [F-4▶▶] to fast forward to the skip time point. (Default: 10 seconds)

You can change the skip time in the voice set mode. (p. 7-14)

• Rewind while playing

Push [F-2◀◀] to rewind to the skip time point. (Default: 10 seconds)

You can change the skip time in the voice set mode. (p. 7-14)

- If you push [F-2◀◀] within the first second of the file, the skip time at the end of the previously recorded file will playback.

• Pause while playing

Push [F-3▶▶] to pause.

- Touch [F-3▶▶] again to resume.

• Playing the previous file

Push [F-1◀◀] to play the previous file.

- In case there are other files in the folder, while the oldest file is playing back, Push [F-1◀◀] to start playing the beginning of the file.

• Playing the next file

Push [F-5▶▶▶] to play the next file.

- In case there are other files in the folder, while the most recent file is playing back, Push [F-5▶▶▶] to stop the playback.

• Moving to the beginning of the previous file

When the playback is paused anywhere within the file, Push [F-2◀◀] one or more times to return to the beginning of the file, and pause.

- Push [F-3▶▶] to play it back.

When the playback is paused at beginning of a file, Push [F-1◀◀] to move to the beginning of the previous file, and pause.

- Push [F-3▶▶] to play it back.

• Moving to the beginning of the next file

When the playback is paused, Push [F-5▶▶▶] to move to the beginning of the next file, and pause.

- Push [F-3▶▶] to play it back.

■ Deleting recorded audio file

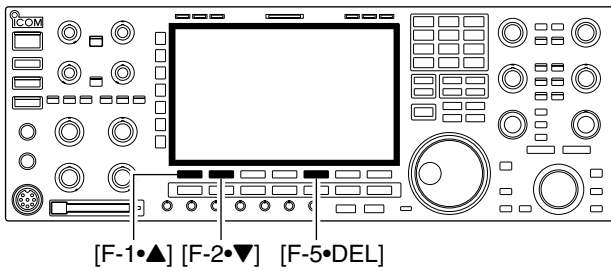

- ① Push [EXIT/SET] several times to close a multi-function screen, if necessary.
- ② Push [F-2•VOICE] to display the Voice Recorder menu.
- ③ Push [F-5•QSO PLAY] to call up the voice QSO player screen.
 - The folder list is displayed.
 - The folder name is formatted yyyyymmdd (yyyy: year, mm: month, dd: day).
- ④ Push [F-1•▲] or [F-2•▼] to select the folder that contains the file you want to delete.
 - Rotating the main dial also selects the folder.
- ⑤ Push [F-3•FILE] to open the folder.
 - The file list is displayed.
 - The file name is formatted yyyy-mm-dd hh:mm:ss (yyyy: year, mm: month, dd: day, hh: hour, mm: minute, ss: second).
- ⑥ Push [F-1•▲] or [F-2•▼] to select the file that you want to delete.
 - Rotating the main dial also selects the file.
- ⑦ Hold down [F-5•DEL] for 1 second to delete the file.
 - The confirmation window “Are you sure?” appears.
- ⑧ Push [F-6•OK] to delete the file.
 - The selected file is deleted.
 - Push [EXIT/SET] to cancel deleting.
- ⑨ Push [EXIT/SET] several times to exit the QSO player screen.

■ Deleting recorded audio folder

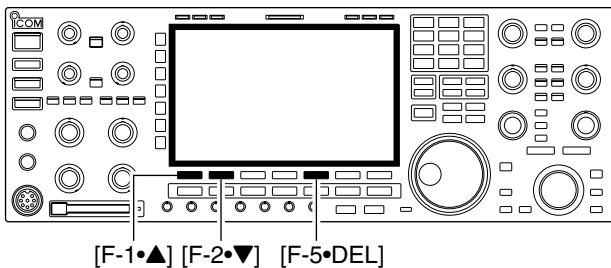

- ① Push [EXIT/SET] several times to close a multi-function screen, if necessary.
- ② Push [F-2•VOICE] to display the Voice Recorder menu.
- ③ Push [F-5•QSO PLAY] to call up the voice QSO player screen.
 - The folder list is displayed.
 - The folder name is formatted yyyyymmdd (yyyy: year, mm: month, dd: day).
- ④ Push [F-1•▲] or [F-2•▼] to select the folder that you want to delete.
 - Rotating the main dial also selects the folder.
- ⑤ Hold down [F-5•DEL] for 1 second to delete the folder.
 - The confirmation window “Are you sure?” appears.
- ⑥ Push [F-6•OK] to delete the folder.
 - The selected folder is deleted.
 - Push [EXIT/SET] to cancel deleting.
- ⑦ Push [EXIT/SET] several times to exit the QSO player screen.

■ About digital Voice Recorder

The IC-7800 has digital voice memories, up to 4 channels for transmit, and up to 20 channels for receive. A maximum message length of 30 seconds can be recorded into a receive channel (total message length for all channels of up to 209 seconds) and a total message length of up to 99 seconds can be recorded in transmit channels.

The transmit memory is very convenient for repeated CQ and number transmissions in contests, as well as when making consecutive calls during DX'peditions.

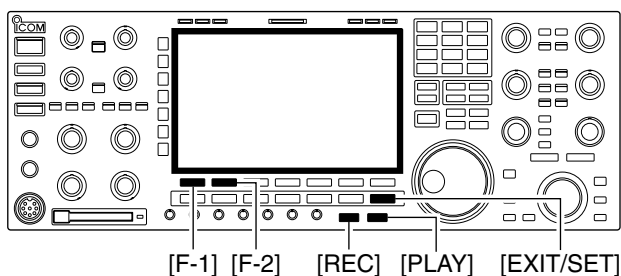

- ① Select any mode.
- ② Push [F-2•VOICE] to display Voice Recorder menu.
- ③ Push [F-1•PLAY] or [F-2•MIC REC] to select the desired memory channel screen, then record audio or playback the contents as described below.
- ④ Push [EXIT/SET] twice to exit Voice Recorder screen.

• About recording received audio and playing back the contents

• Example—When [REC] is pushed momentarily

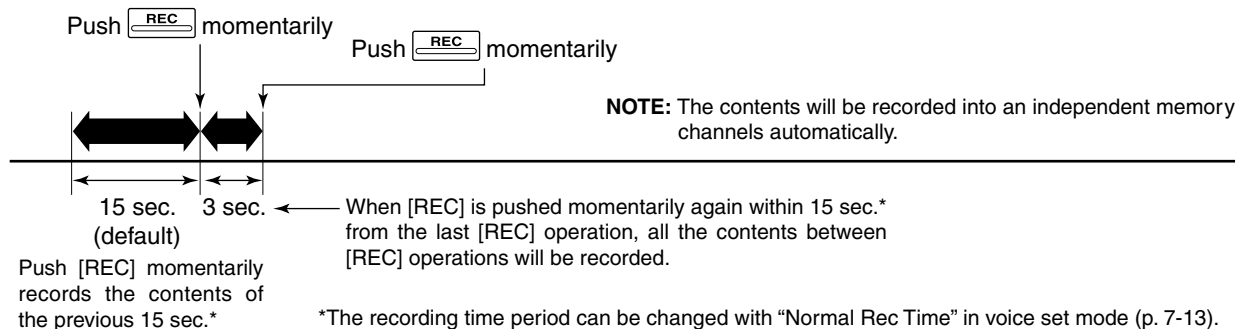

• Playing back the all contents in a channel

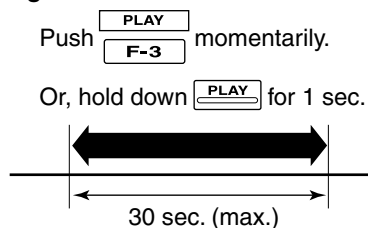

• Playing back the end of 5 sec.* in a channel

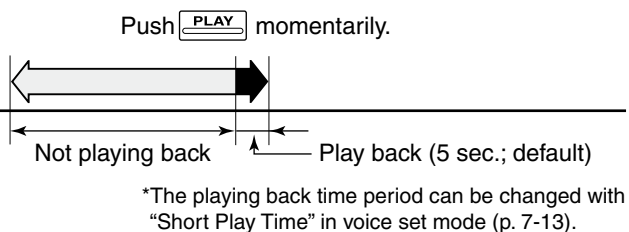

■ Recording a received audio (Short REC)

Up to 20 channels of receive voice memories are available in the IC-7800. And the total audio length of up to 209 seconds can be recorded in receive channels. However, the maximum recordable length into a single channel is 30 seconds.

This Voice Recorder records not only the received audio, but also the information such as set operating frequency, mode, and the recording time for your future reference.

◇ One-touch recording

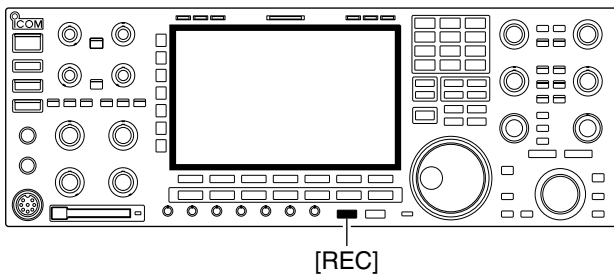

➔ Push [REC] momentarily to records the previous 15 seconds audio.

- The recordable time period can be set in voice set mode. (p. 7-13)
- The operating frequency, mode and current time are automatically programmed as the memory names.

NOTE: When transmit (or [PTT] is pushed) within the set period, no audio will be recorded.

IMPORTANT!

When you record the 21st audio segment, or when the total audio length exceeds 209 seconds, the oldest recorded audio is automatically erased to make room for the new audio.

■ Playing back the recorded audio (Short REC)

◇ Basic playing

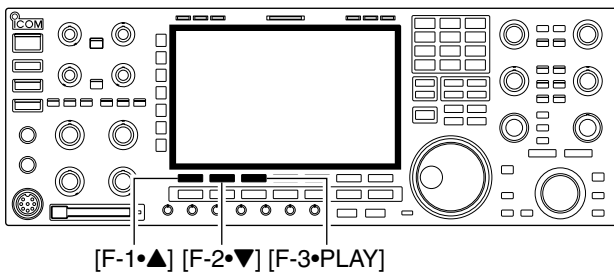

- ① Push [EXIT/SET] several times to close a multi-function screen, if necessary.
- ② Push [F-2•VOICE] to display the Voice Recorder menu.
- ③ Push [F-1•PLAY] to call up the Voice Recorder screen.
 - Previously selected screen, TX or RX memory, is displayed. If the TX memory channel (T1–T4) appears, push [F-7•T/R] to select RX memory channel.
- ④ Push [F-1•▲] or [F-2•▼] to select the desired voice memory to playback.
- ⑤ Push [F-3•PLAY] to start playback.
 - “PLAY” indicators appear and the timer counts down.
- ⑥ Push [F-3•PLAY] again to stop playback if desired.
 - Playback is terminated automatically when all of the recorded contents in the channel are played.
- ⑦ Push [EXIT/SET] twice to exit the Voice Recorder screen.

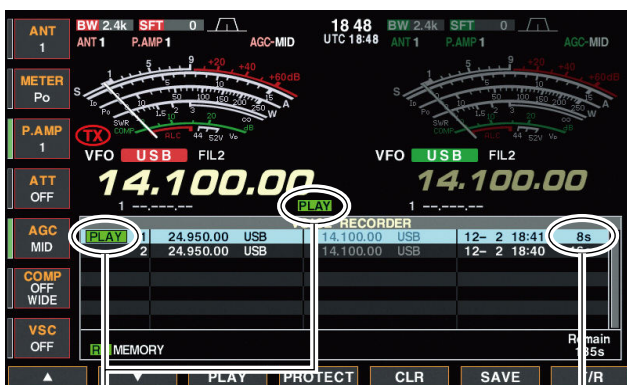

Appear

Counts down

■ Playing the recorded audio (continued)

◇ One-touch playing

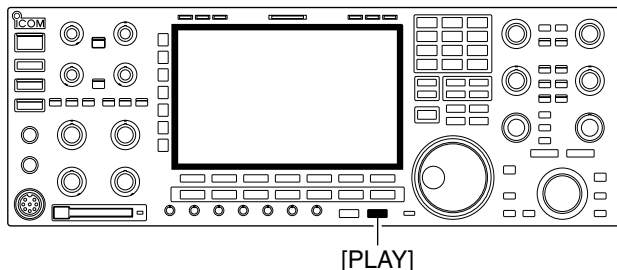

The previously recorded audio in channel 1 can be playback without selecting Voice Recorder screen.

- Push [PLAY] momentarily to playback the last 5 seconds of the previously recorded audio.
 - “PLAY” indicator appears.
 - Playback is terminated automatically after 5 seconds.
 - The playback time period can be set in voice set mode. (p. 7-13)
- Hold down [PLAY] for 1 second to playback all of the previously recorded audio.
 - “PLAY” indicator appears.
 - Playback is terminated automatically when all of the recorded contents in the channel are played.

■ Protect the recorded contents

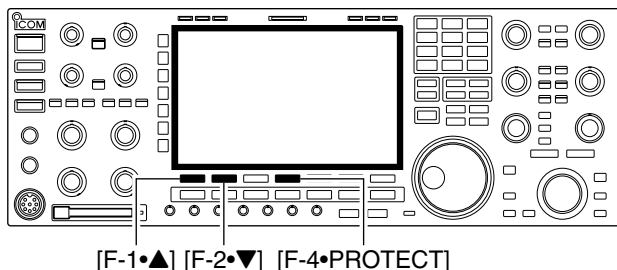

The protect function is available to protect the important recorded contents from accidental erasing, such as over-record, etc.

- ① Push [EXIT/SET] several times to close a multi-function screen, if necessary.
- ② Push [F-2•VOICE] to display the Voice Recorder menu.
- ③ Push [F-1•PLAY] to call up the Voice Recorder screen.
 - Previously selected screen, TX or RX memory, is displayed. If the TX memory channel (T1–T4) appears, push [F-7•T/R] to select RX memory channel.
- ④ Push [F-1•▲] or [F-2•▼] to select the desired voice memory.
- ⑤ Push [F-4•PROTECT] to turn the protect function ON or OFF.
 - “” indicator appears when the contents is protected.
- ⑥ Push [EXIT/SET] twice to exit the Voice Recorder menu.

■ Erasing the recorded contents

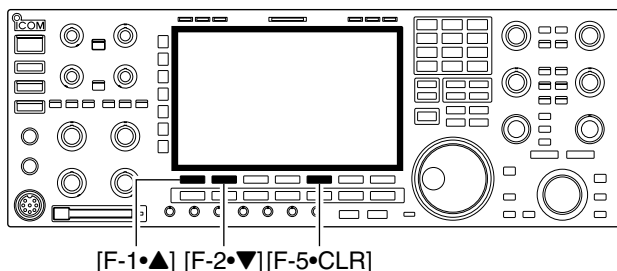

The recorded contents can be erased independently by channel.

- ① Perform the steps ① to ③ as “■ Protect the recorded contents” above.
- ② Push [F-1•▲] or [F-2•▼] to select the desired voice memory to be erased.
- ③ Hold down [F-5•CLR] for 1 second to erase the contents.
 - Push [F-4•PROTECT] to release the protection in advance if necessary.
- ④ Push [EXIT/SET] twice to exit the Voice Recorder menu.

Recording a message for transmit

To transmit a message using the Voice Recorder, record the desired message in advance as described below.

The IC-7800 has digital voice memories for transmission, up to 4 memories and you can record message in length of up to 99 seconds.

Recording

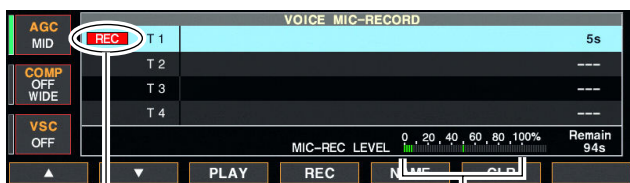
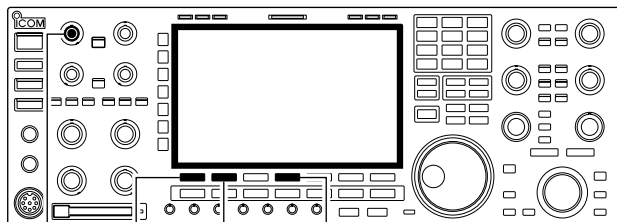

Appears

Adjust [MIC] control so that this indicator reads within 100%.

- ① Push [EXIT/SET] several times to close a multi-function screen, if necessary.
- ② Push [F-2•VOICE] to display the Voice Recorder menu.
- ③ Push [F-2•MIC REC] to select the voice mic. record screen.
- ④ Push [F-1•▲] or [F-2•▼] to select the desired memory channel.
- ⑤ Hold down [F-4•REC] for 1 second to start recording.
 - “REC” indicator appears.
 - Speak into the microphone without holding down [PTT].
 - Previously recorded contents are cleared.
 - Audio output from the internal speaker is automatically muted.
- ⑥ While speaking into the microphone with your normal voice level, adjust the [MIC] control so that the [MIC-REC LEVEL] indicator reads within 100%.
- ⑦ Push [F-4•REC] momentarily to stop recording.
 - The recording is terminated automatically when the remaining time becomes 0 second.
- ⑧ Push [EXIT/SET] twice to exit the Voice Recorder screen.

Confirming a message for transmit

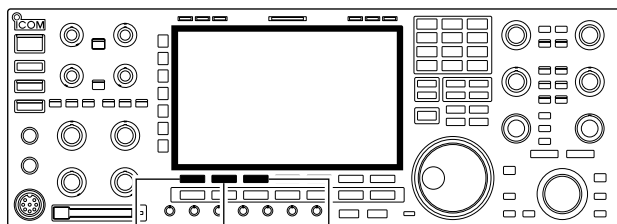

[F-1•▲] [F-2•▼] [F-3•PLAY]

- ① Perform the steps ① to ③ as “Recording” above.
- ② Push [F-1•▲] or [F-2•▼] to select the desired memory channel.
- ③ Push [F-3•PLAY] to playback the recorded contents.
 - “PLAY” indicator appears.
- ④ Push [F-3•PLAY] again to stop playback.
 - Playback is terminated automatically when all of the recorded contents in the channel are played.
- ⑤ Push [EXIT/SET] twice to exit the Voice Recorder screen.

■ Programming a memory name

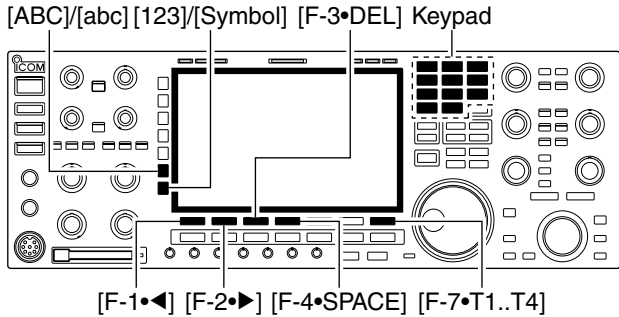

• Voice memory name editing example



Memory channels can be tagged with alphanumeric names of up to 20 characters each.

You can use capital letters, small letters, numerals, some symbols (! # \$ % & ¥ ? “ ‘ ` ^ + - * / . , ; = < > () [] { } | _ ~ @) and spaces. (See the table below.)

- ① Record a message as described in page 7-9.
- ② During the voice mic. record screen indication, push [F-5•NAME] to enter memory name edit condition.
 - A cursor appears and blinks.
- ③ Push [F-7•T1..T4] several times to select the desired voice memory.
- ④ Input the desired character by rotating the main dial or by pushing the band key for number input.
 - Push [ABC] or [abc] to toggle capital and small letters.
 - Push [123] or [Symbol] to toggle numerals and symbols.
 - Push [F-1•◀] or [F-2•▶] for cursor movement.
 - Push [F-3•DEL] to delete the selected character.
 - Push [F-4•SPACE] to input a space.
 - Pushing the transceiver’s keypad, [0]–[9], can also enter numerals.
- ⑤ Push [EXIT/SET] to input and set the name.
 - The cursor disappears.
- ⑥ Repeat steps ③ to ⑤ to program another voice memory’s name, if desired.
- ⑦ Push [EXIT/SET] twice to exit the Voice Recorder screen.

• Usable characters

Key selection	Editable characters
	A to Z (capital letters)
	a to z (small letters)
	0 to 9 (numbers)
	! # \$ % & ¥ ? “ ‘ ` ^ + - * / . , ; = < > () [] { } _ ~ @

■ Sending a recorded message

◇ Single TX

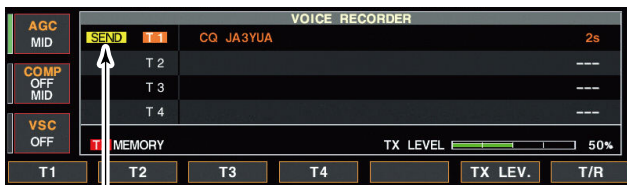
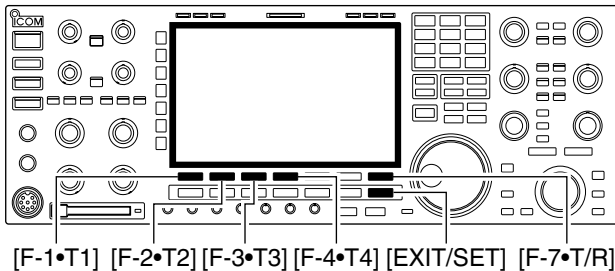

Appears

- ① Push [EXIT/SET] several times to close a multi-function screen, if necessary.
- ② Push [SSB] or [AM/FM] to select a phone mode.
- ③ Push [F-2•VOICE] to enter the Voice Recorder menu.
- ④ Push [F-1•PLAY] to call up the Voice Recorder screen.
 - If the receive voice memory channel appears, push [F-7•T/R] to select TX memory channel (T1–T4).
- ⑤ Push a desired memory channel switch, [F-1•T1] to [F-4•T4], to transmit the recorded voice audio.
 - The transceiver transmits automatically.
 - “SEND” indicator appears and the memory timer counts down.
 - You hear the transmitted message from the speaker as the default setting. This can be turned OFF in voice set mode. (p. 7-13)
- ⑥ Push the selected memory channel switch, [F-1•T1] to [F-4•T4], again to stop, if desired.
 - The transceiver returns to receive automatically when all of the recorded contents in the channel are transmitted.
- ⑦ Push [EXIT/SET] twice to exit the voice memory screen.

◇ Repeat TX

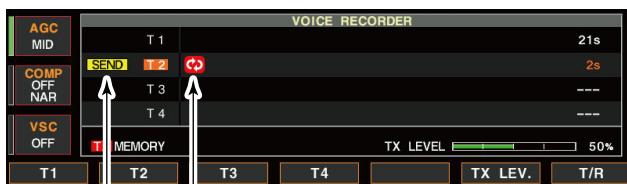
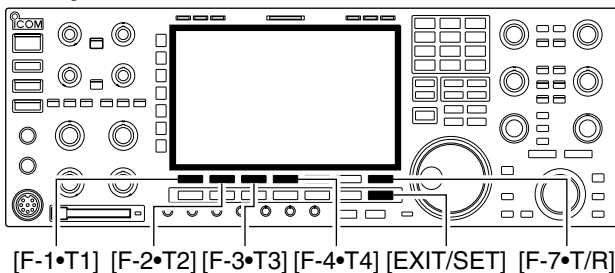

Appears

Repeat indicator

- ① Perform the steps ① to ④ above.
- ② Hold down a desired memory channel switch, [F-1•T1] to [F-4•T4], for 1 second to repeatedly transmit the recorded voice audio for up to 10 minutes at the interval specified in “Repeat Time.”
 - Even if 10 minutes pass while transmitting, the voice audio is completely transmitted.
 - One of the following steps will cancel the transmission.
 - Push the memory again.
 - Push another memory (except for [TX LEV.]).
 - Exit the TX Voice memory screen.
 - Turn OFF the power, then turn it ON again.
 - Activate the transmission.
 - The repeat transmission is cancelled. But while transmitting, the voice audio is completely transmitted.
 - Once the Repeat TX is made, the transceiver pauses until the end of the “Repeat Time,” then transmits again. After the second transmission, the Repeat TX continues pausing, if receiving a signal. But if the squelch is manually opened, the voice audio is repeatedly transmitted, according to the repeat time setting.

✓ For your convenience

When an external keypad or PC keyboard is connected, the recorded message, T1 to T4, can be transmitted without opening the Voice Recorder screen. See pages 2-6, 2-10 and 12-20 for details.

- The recorded message, T1 to T4 is transmitted once when pushing one of four switches on the external keypad; the recorded message is repeatedly transmitted when holding down a switch.
- The recorded message, T1 to T4 is transmitted once when pushing one of [F1] to [F4] key on the PC keyboard; the recorded message is repeatedly transmitted when pushing a key while holding down [SHIFT] key.

■ Sending a recorded message (continued)

◇ Transmit level setting

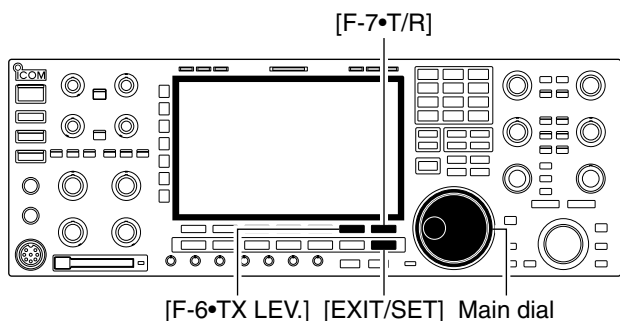

- ① Call up the Voice Recorder screen as described as above.
- ② Push [F-6•TX LEV.] to select the voice memory transmit level set condition.
- ③ Push the desired memory channel switch, [F-1•T1] to [F-4•T4], momentarily to transmit the contents.
 - The transceiver automatically transmits.
 - “SEND” indicator appears and the memory timer counts down.
- ④ Rotate the main dial to adjust the transmit voice level.
 - Hold down [F-7•DEF] for 1 second to select the default condition.
- ⑤ Push [EXIT/SET] to return to the Voice Recorder screen.

■ Voice set mode

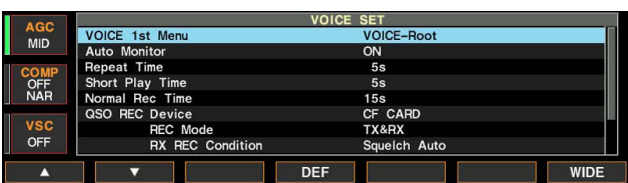
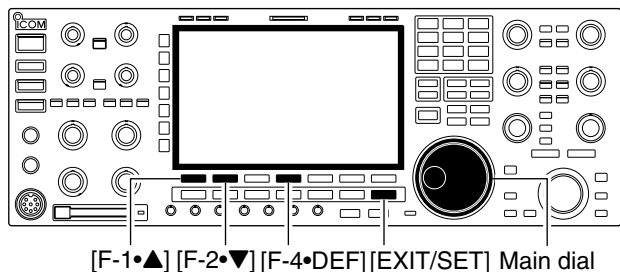

Sets the automatic monitor function, short play and normal recording times for Voice Recorder.

- ① Push [EXIT/SET] several times to close a multi-function screen, if necessary.
- ② Push [F-2•VOICE] to display the Voice Recorder menu.
- ③ Push [F-7•SET] to select voice set mode screen.
- ④ Push [F-1•▲] or [F-2•▼] to select the desired item.
- ⑤ Rotate main dial to set the desired condition or value.
 - Hold down [F-4•DEF] for 1 second to select the default condition or value.
- ⑥ Push [EXIT/SET] to exit the voice set mode screen.

VOICE 1st Menu

Select VOICE-Root or VOICE-PLAY as the menu that appears first after pushing [F-2•VOICE].

VOICE-Root

- VOICE-Root : The voice menu appears first.
- VOICE-PLAY : Either the RX or TX voice Recorder screen appears first.

Auto Monitor

Turn the automatic monitor function for recorded audio contents transmission.

ON

- ON : Monitors transmitting audio automatically when sending a recorded audio.
- OFF : Monitors transmitting audio only when the monitor function is in use.

Repeat Time	5s
<p>Set the repeat interval for the voice repeat transmission to between 1 and 15 seconds (in 1 second steps). The transceiver repeatedly transmits the recorded voice audio at this interval.</p>	

Short Play Time	5s
<p>Set the desired time period for the one-touch playing (when [PLAY] is pushed).</p>	<ul style="list-style-type: none"> • Set between 3 and 10 seconds (in 1 second steps). (default: 5 seconds)

Normal Rec Time	15s
<p>Set the desired time period for the for one-touch recording (when [REC] is pushed).</p>	<ul style="list-style-type: none"> • Set between 5 to 30 seconds (in 1 second steps). (default: 15 seconds)

QSO REC Device	CF CARD
<p>Select a memory device for recording a QSO audio.</p>	<ul style="list-style-type: none"> • CF CARD : Records the QSO audio onto the CF card. • USB-Memory: Records the QSO audio onto the USB flash drive.

REC Mode	TX&RX
<p>Select the recording mode for recording a QSO audio.</p>	<ul style="list-style-type: none"> • TX&RX : Records both the transmitted and received audio. • RX only: Records only the received audio.

RX REC Condition	Squelch Auto
<p>Select whether or not the squelch status affects the RX voice audio recording.</p>	<ul style="list-style-type: none"> • Always: The transceiver always records the RX audio, regardless of the squelch status. • Squelch Auto: The transceiver records the RX audio only when a signal is received (the squelch is opened). When the squelch closes while recording, the recording will continue for 2 seconds, and then pause.

■ Voice set mode (Continued)

File Split	ON
Turn the File Split function ON or OFF.	<ul style="list-style-type: none"> • OFF: The audio is continuously recorded into the file, even if you switch between transmit and receive or the squelch status changes between open and closed. • ON: While recording, and if you switch between transmit and receive, or the squelch status changes between open and closed, a new file is automatically created in the same folder, and the audio is saved into the new one.

PTT Auto REC	OFF
Turn the PTT Automatic Recording function ON or OFF.	<ul style="list-style-type: none"> • OFF: The recording does not start even if a signal is transmitted. • ON: The recording automatically starts when a signal is transmitted. The recording will continue when: <ul style="list-style-type: none"> • A signal is transmitted again within 10 seconds after the last transmission. • A signal is received within 10 seconds after the last transmission, is also recorded. <ul style="list-style-type: none"> - A signal is received within 10 seconds after the last reception. • The squelch is open in the FM modes. The recording will stop when: <ul style="list-style-type: none"> • The frequency or operating mode is changed. • The operating method (V/M, M-CH, Band Stacking Register, and so on) is changed. • 10 minutes has past after the last transmission while the squelch is open in the SSB, CW, RTTY, PSK or AM modes.

QSO PLAY Skip Time	10s
Set the Skip time for forwarding or rewinding while playing back the QSO audio. 3, 5, 10 and 30 seconds are selectable.	

■ Saving a voice memory into the memory device

◇ Saving the received audio memory

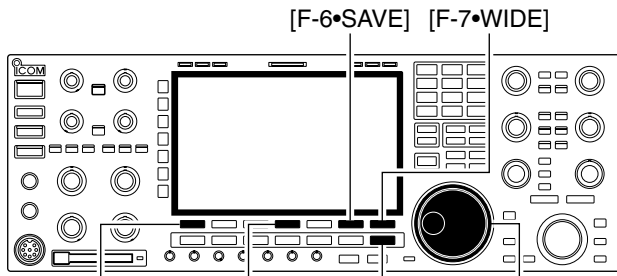

[F-1•DIR/FILE] [F-4•EDIT] [EXIT/SET] Main dial

• Voice recorder RX memory screen

VOICE RECORDER						
AGC	1	14,100.00	USB	14,100.00	USB	11-14 19:32 30s
MID	2	14,100.00	USB	14,100.00	USB	11-14 19:31 23s
	3	14,100.00	USB	14,100.00	USB	11-14 19:31 30s
COMP	4	14,100.00	USB	14,100.00	USB	11-14 15:34 1s
OFF	5	14,100.00	USB	14,100.00	USB	11-14 15:34 1s
WIDE	6	14,100.00	USB	14,100.00	USB	11-14 15:34 1s
	7	14,100.00	USB	14,100.00	USB	11-14 15:34 1s
VSC						Remain 8s
OFF						

• Voice file save screen— file name edit

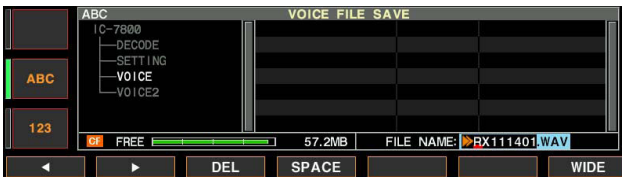

• While saving

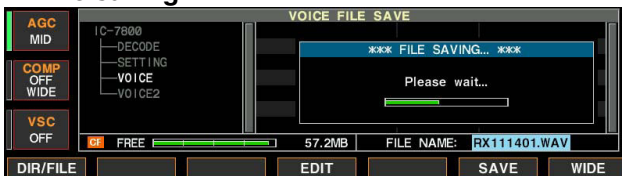

The recorded RX memory contents can be saved into the CF (Compact Flash) memory card or USB flash drive.

- ① During Voice Recorder RX memory screen display, push [F-6•SAVE] to select voice file save screen.
 - Previously selected screen, TX or RX memory, is displayed. If the TX memory channel (T1–T4) appears, push [F-7•T/R] to select RX memory channel.
- ② Change the following conditions, if desired.

• File name:

- ① Push [F-4•EDIT] to select file name edit condition.
 - Push [F-1•DIR/FILE] several times to select the file name, if necessary.
- ② Push [ABC], [123] or [Symbol] to select the character group, then rotate the main dial to select the character.
 - [ABC] : A to Z (capital letters); [123]: 0 to 9 (numerals); [Symbol]: ! # \$ % & ' ` ^ + - = () [] { } _ ~ @ can be selected.
 - Push [F-1•◀] to move the cursor left, push [F-2•▶] to move the cursor right, push [F-3•DEL] to delete a character and push [F-4•SPACE] to insert a space.
- ③ Push [EXIT/SET] to set the file name.

• Saving location

- ① Hold down [F-1•DIR/FILE] for 1 second to select the CF memory card or USB flash drive.
- ② Push [F-1•DIR/FILE] to select tree view screen.
- ③ Select the desired directory or folder in the CF memory card.
 - Push [F-4•◀▶] to select the upper directory.
 - Push [F-2•▲] or [F-3•▼] to select folder in the same directory.
 - Hold down [F-4•◀▶] for 1 second to select a folder in the directory.
 - Push [F-5•REN/DEL] to rename the folder.
 - Hold down [F-5•REN/DEL] for 1 second to delete the folder.
 - Hold down [F-6•MAKE] for 1 second to making a new folder. (Edit the name with the same manner as the “• File name” above.)
- ④ Push [F-1•DIR/FILE] twice to select the file name.

- ③ Push [F-6•SAVE].
 - After the saving is completed, return to Voice Recorder RX memory screen automatically.

◇ Saving the TX memory

The TX memory contents can also be saved into the Memory device. However, the contents are saved with the memory channel list, set mode conditions, etc. at the same time.

See page 12-30 for details.

■ Memory channels	8-2
■ Memory channel selection	8-2
◇ Using the [▲]/[▼] keys	8-2
◇ Using the keypad	8-2
■ Memory list screen.....	8-3
◇ Selecting a memory channel using the memory list screen	8-3
◇ Confirming programmed memory channels	8-3
■ Memory channel programming	8-4
◇ Programming in VFO mode	8-4
◇ Programming in memory mode	8-4
■ Frequency transferring	8-5
◇ Transferring in VFO mode	8-5
◇ Transferring in memory mode	8-5
■ Memory names	8-6
◇ Editing (programming) memory names	8-6
■ Memory clearing.....	8-6
■ Memo pads	8-7
◇ Writing frequencies and operating modes into memo pads	8-7
◇ Calling up a frequency and operating mode from a memo pad ...	8-7

Memory channels

The transceiver has 101 memory channels. Memory mode is very useful for quickly changing to often-used frequencies.

All 101 memory channels are tunable which means the programmed frequency can be tuned temporarily with the main dial, etc. in memory mode.

MEMORY CHANNEL	MEMORY CHANNEL NUMBER	CAPABILITY	TRANSFER TO VFO	OVER-WRITING	CLEAR
Regular memory channels	1-99	One frequency and one mode in each memory channel.	Yes	Yes	Yes
Scan edge memory channels	P1, P2	One frequency and one mode in each memory channel as scan edges for programmed scan.	Yes	Yes	No

Memory channel selection

Using the [▲]/[▼] keys

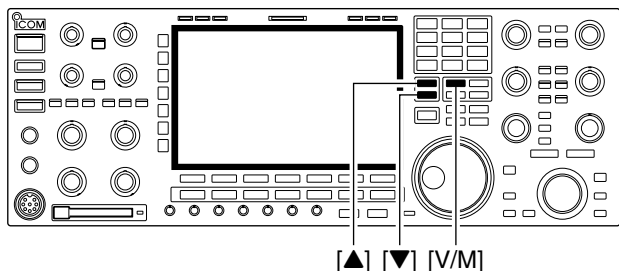

- ① Push [V/M] to select memory mode.
- ② Push [▲]/[▼] several times to select the desired memory channel.
 - Hold down [▲]/[▼] for continuous selection.
 - [UP] and [DN] on the microphone can also be used.
- ③ To return to VFO mode, push [V/M] again.

Using the keypad

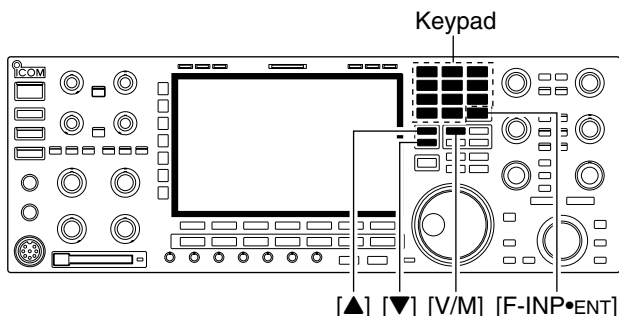

- ① Push [V/M] to select memory mode.
- ② Push [F-INP•ENT].
- ③ Push the desired memory channel number using the keypad.
 - Enter 100 or 101 to select scan edge channel P1 or P2, respectively.
- ④ Push [▲] or [▼] to select the desired memory channel.

[EXAMPLE]

- To select the memory channel 3;
 - Push [F-INP•ENT], [7•3], then push [▲] or [▼].
- To select the memory channel 12;
 - Push [F-INP•ENT], [1.8•1], [3.5•2], then push [▲] or [▼].
- To select the scan edge channel P1;
 - Push [F-INP•ENT], [1.8•1], [50•0], [50•0], then push [▲] or [▼].
- To select the scan edge channel P2;
 - Push [F-INP•ENT], [1.8•1], [50•0], [1.8•1], then push [▲] or [▼].

Memory list screen

The memory list screen simultaneously shows 9 memory channels and their programmed contents. 15 memory channels can be displayed in the wide memory list screen.

You can select a desired memory channel from memory list screen.

◇ Selecting a memory channel using the memory list screen

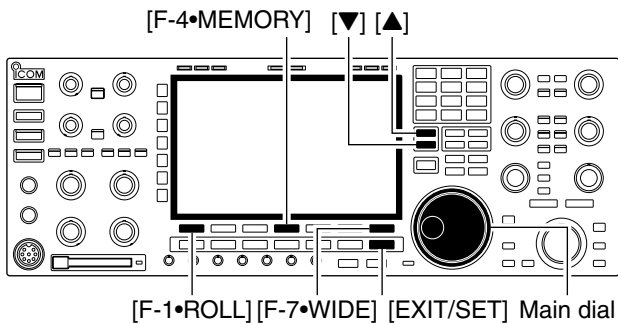

- ① Push [EXIT/SET] several times to close a multi-function screen, if necessary.
- ② Push [F-4•MEMORY] to select memory list screen.
 - [F-7•WIDE] switches the standard and wide screens.
- ③ While pushing [F-1•ROLL], rotate the main dial to select the desired memory channel.
 - [▲] and [▼] can also be used.
- ④ Push [EXIT/SET] to exit memory list screen.

• Memory list screen

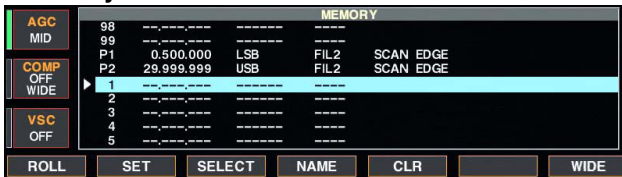

◇ Confirming programmed memory channels

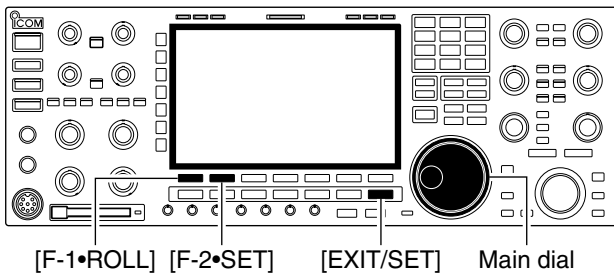

- ① Select memory list screen as described above.
- ② While pushing [F-1•ROLL], rotate the main dial to scroll the screen.
- ③ Push [F-2•SET] to select the highlighted memory channel, if desired.
 - “▶” appears beside the selected memory channel number in the memory list screen and the selected memory channel contents are displayed below the frequency readout.
- ④ Push [EXIT/SET] to exit memory list screen.

Memory channel programming

◇ Programming in VFO mode

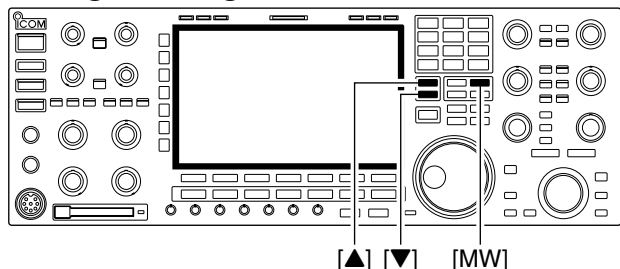

[EXAMPLE]: Programming 7.088 MHz/LSB into memory channel 12.

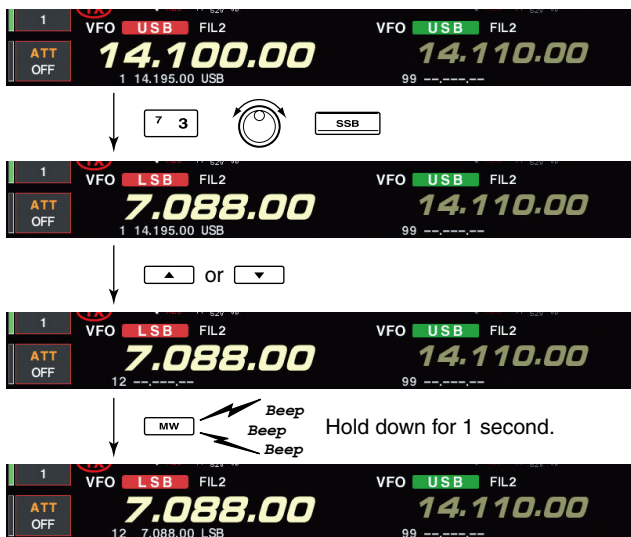

◇ Programming in memory mode

[EXAMPLE]: Programming 21.280 MHz/USB into memory channel 18.

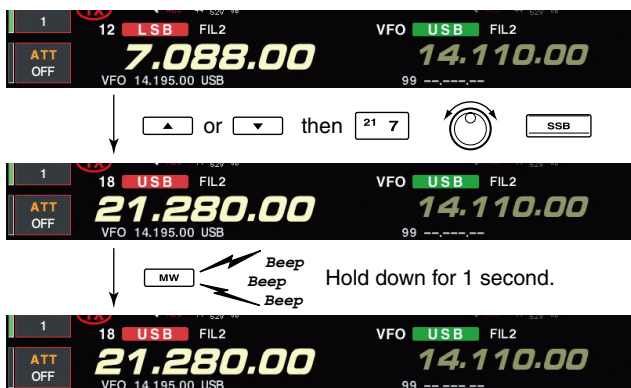

Memory channel programming can be performed either in VFO mode or in memory mode.

- ① Set the desired frequency, operating mode and filter width in VFO mode.
- ② Push [▲]/[▼] several times to select the desired memory channel.
 - Memory list screen is convenient for selecting the desired channel.
 - Memory channel contents appear in the memory channel readout (below the frequency readout).
 - “---,---,---” appears if the selected memory channel is a blank channel (and does not have contents).
- ③ Hold down [MW] for 1 second to program the displayed frequency, operating mode, etc., into the memory channel.

- ① Select the desired memory channel with [▲]/[▼] in memory mode.
 - Memory channel contents appear in the memory channel readout (below the frequency readout).
 - “---,---,---” appears if the selected memory channel is a blank channel (and does not have contents).
- ② Set the desired frequency and operating mode in memory mode.
 - To program a blank channel, use direct frequency entry with the keypad or memo pads, etc.
- ③ Hold down [MW] for 1 second to program the displayed frequency and operating mode into the memory channel.

■ Frequency transferring

◇ Transferring in VFO mode

TRANSFERRING EXAMPLE IN VFO MODE
 Operating frequency : 21.320 MHz/USB (VFO)
 Contents of M-ch 16 : 14.018 MHz/CW

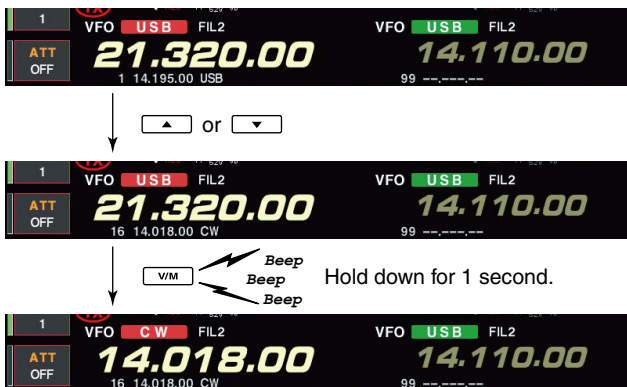

◇ Transferring in memory mode

TRANSFERRING EXAMPLE IN MEMORY MODE
 VFO frequency : 21.320 MHz/USB
 Contents of M-ch 16 : 14.018 MHz/CW

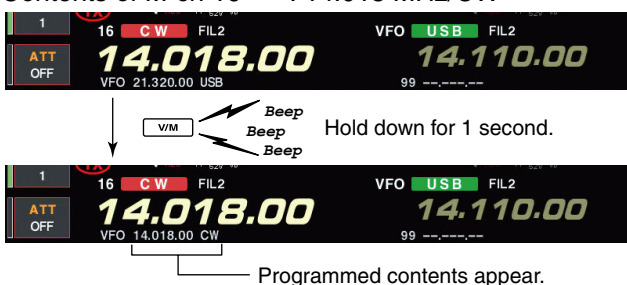

The frequency and operating mode in a memory channel can be transferred to the VFO. Frequency transferring can be performed in either VFO mode or memory mode.

This is useful for transferring programmed contents to VFO.

- ① Select VFO mode with [V/M].
- ② Select the memory channel to be transferred with [▲]/[▼].
 - Memory list screen is convenient for selecting the desired channel.
 - Memory channel contents appear in the memory channel readout (below the frequency readout).
 - “--:--:--” appears if the selected memory channel is a blank channel. In this case transferring is impossible.
- ③ Hold down [V/M] for 1 second to transfer the frequency and operating mode.
 - Transferred frequency and operating mode appear on the frequency readout.

This is useful for transferring frequency and operating mode while operating in memory mode.

- ▨ When you have changed the frequency or operating mode in the selected memory channel:
 - **Displayed** frequency, mode and filter setting are transferred.
 - **Programmed** frequency and mode in the memory channel are not transferred, and they remain in the memory channel.

- ① Select the memory channel to be transferred with [▲]/[▼] in memory mode.
 - And, set the frequency or operating mode if required.
- ② Hold down [V/M] for 1 second to transfer the frequency and operating mode.
 - Displayed frequency and operating mode are transferred to the VFO.
- ③ To return to VFO mode, push [V/M] momentarily.

Memory names

All memory channels (including scan edges) can be tagged with alphanumeric names of up to 10 characters each.

Capital letters, small letters, numerals, some symbols (! # \$ % & ¥ ? " ' ` ^ + - * / . , ; = < > () [] { } | _ ~ @) and spaces can be used.

Editing (programming) memory names

[ABC]/[abc] [123]/[Symbol] [F-3•DEL] Keypad

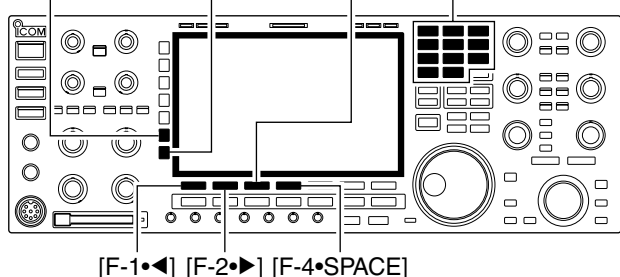

- ① Push [EXIT/SET] several times to close a multi-function screen, if necessary.
- ② Push [F-4•MEMORY] to select memory list screen.
- ③ Select the desired memory channel.
- ④ Push [F-4•NAME] to edit memory channel name.
 - A cursor appears and blinks.
 - Memory channel names of blank channels cannot be edited.
- ⑤ Input the desired character by rotating the main dial or by pushing the band key for number input.
 - Push [ABC] or [abc] to toggle capital and small letters.
 - Push [123] or [Symbol] to toggle numerals and symbols.
 - Push [F-1•◀] or [F-2•▶] for cursor movement.
 - Push [F-3•DEL] to delete the selected character.
 - Push [F-4•SPACE] to input a space.
 - Pushing the transceiver's keypad, [0]–[9], can also enter numerals.
- ⑥ Push [EXIT/SET] to input and set the name.
 - The cursor disappears.
- ⑦ Repeat steps ③ to ⑥ to program another memory channel's name, if desired.
- ⑧ Push [EXIT/SET] to exit memory list screen.

Memory clearing

Any unnecessary memory channels can be cleared. The cleared memory channels become blank channels.

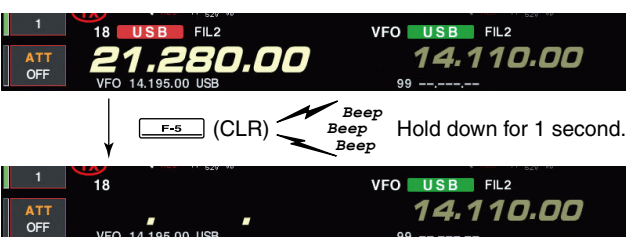
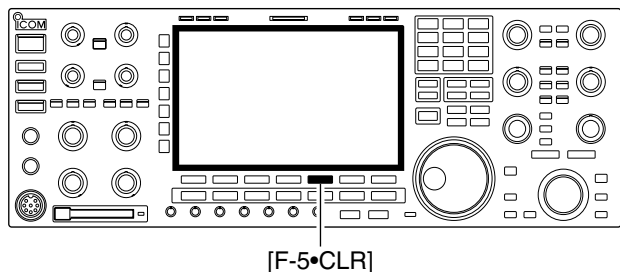

- ① Select memory mode with [V/M].
- ② Push [F-4•MEMORY] to select memory list screen.
- ③ Select the desired memory channel with [▲]/[▼].
- ④ Hold down [F-5•CLR] for 1 second to clear the contents.
 - The programmed frequency and operating mode disappear.
- ⑤ To clear other memory channels, repeat steps ③ and ④.

■ Memo pads

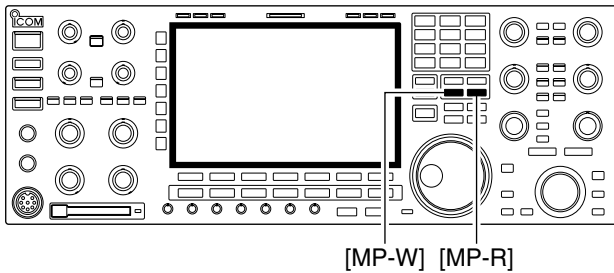

The transceiver has a memo pad function to store frequency and operating mode for easy write and recall. The memo pads are separate from memory channels.

The default number of memo pads is 5, however, this can be increased to 10 in set mode if desired. (p. 12-18)

Memo pads are convenient when you want to memorize a frequency and operating mode temporarily, such as when you find a DX station in a pile-up, or when a desired station is busy for a long time and you want to temporarily search for other stations.

Use the transceiver's memo pads instead of relying on hastily scribbled notes that are easily misplaced.

◇ Writing frequencies and operating modes into memo pads

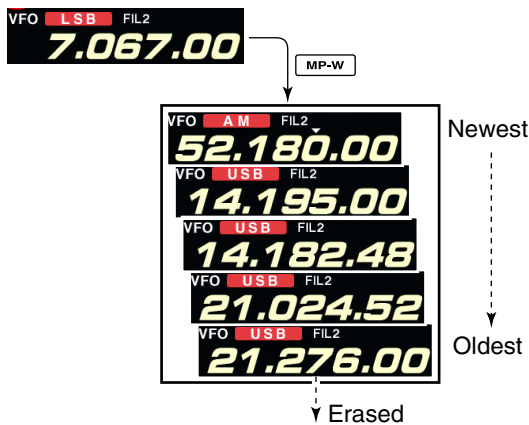

In this example, 21.276 MHz (LSB) will be erased when 7.067 MHz (LSB) is written.

You can simply write the accessed readout frequency and operating mode by pushing [MP-W].

When you write a 6th frequency and operating mode, the oldest written frequency and operating mode are automatically erased to make room for the new settings.

Each memo pad must have its own unique combination of frequency and operating mode; memo pads having identical settings cannot be written.

◇ Calling up a frequency and operating mode from a memo pad

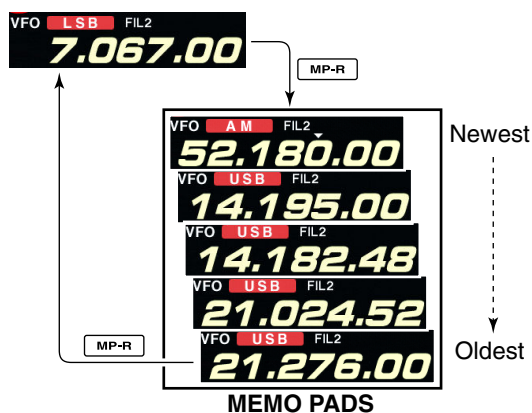

You can simply call up the desired frequency and operating mode of a memo pad by pushing [MP-R] several times.

- Both VFO and memory modes can be used.
- The frequency and operating mode are called up, starting from the most recently written.

When you call up a frequency and an operating mode from memo pads with [MP-R], the previously displayed frequency and operating mode are automatically stored in a temporary pad. The frequency and operating mode in the temporary pad can be recalled by pushing [MP-R] several times.

- You may think there are 6 memo pads because 6 different frequencies (5 are in memo pads and 1 is in the temporary pad) are called up by [MP-R].

If you change the frequency or operating mode called up from a memo pad with the main dial, etc., the frequency and operating mode in the temporary pad are erased.

- Scan types 9-2
- Preparation 9-2
- Voice squelch control function 9-3
- Scan set mode 9-3
- Programmed scan operation 9-4
- ΔF scan operation 9-4
- Fine programmed scan/ ΔF scan 9-5
- Memory scan operation 9-6
- Select memory scan operation 9-6
- Setting select memory channels 9-7
 - ◇ Setting in scan screen 9-7
 - ◇ Setting in memory list screen 9-7
 - ◇ Erasing the select scan setting 9-7
- Tone scan 9-8

■ Scan types

PROGRAMMED SCAN

Repeatedly scans between two scan edge frequencies (scan edge memory channels P1 and P2).

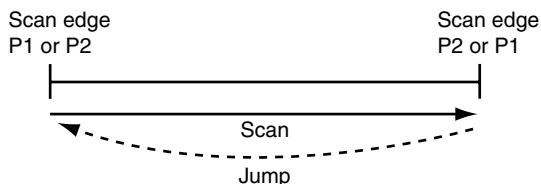

This scan operates in VFO mode.

ΔF SCAN

Repeatedly scans within ΔF span area.

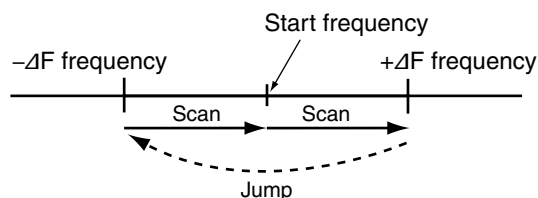

This scan operates in both VFO and memory modes.

MEMORY SCAN

Repeatedly scans all programmed memory channels.

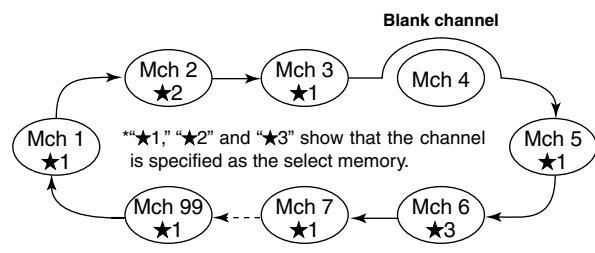

This scan operates in memory mode.

SELECT MEMORY SCAN

Repeatedly scans all or one of 3 select memory channels.

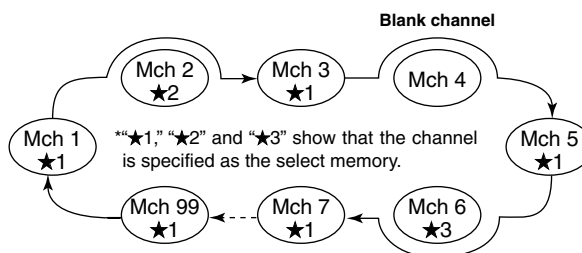

This scan operates in memory mode.

■ Preparation

• Channels

For programmed scan:

Program scan edge frequencies into scan edge memory channels P1 and P2.

For ΔF scan:

Set the ΔF span (ΔF scan range) in the scan screen.

For memory scan:

Program 2 or more memory channels except scan edge memory channels.

For select memory scan:

Designate 2 or more memory channels as select memory channels. To designate the channel as a select memory channel, choose a memory channel, then push [F-3•SELECT] in the scan screen (memory mode) or in the memory list screen.

• Scan resume ON/OFF

You can select the scan to resume or cancel when detecting a signal, in set mode. Scan resume ON/OFF must be set before operating a scan. See page 9-3 for ON/OFF setting and scan resume condition details.

- The scan function can be used on the main read-out only.
- You can operate a scan while operating on a frequency using the dualwatch or split functions.

• Scan speed

Scan speed can be selected from 2 levels, high or low, in scan set mode. See page 9-3 for details.

• Squelch condition

○ Scan starts with squelch open

For programmed scan:

When tuning step is 1 kHz or less:

The scan continues until it is stopped manually—it does not pause* even if signals are detected.

*The scan is paused when the squelch is closed and then opened (scan resumes after 10 seconds has passed when the scan resume is ON; scan is cancelled when the scan resume is OFF).

When tuning step is more than 5 kHz:

The scan pauses on each step when the scan resume is ON; not applicable when the scan resume is OFF.

For memory scan:

Scan pauses on each channel when the scan resume is ON; not applicable when the scan resume is OFF.

○ Scan starts with squelch closed

Scan stops when a signal is detected.

- If the scan resume is set to ON in scan set mode, the scan pauses for 10 seconds when detecting a signal, then resumes. When a signal disappears while scan is paused, scan resumes 2 seconds later.

■ Voice squelch control function

This function is useful when you don't want unmodulated signals pausing or cancelling a scan. When the voice squelch control function is activated, the receiver checks received signals for voice components.

If a receiver signal includes voice components, and the tone of the voice components changes within 1 second, scan pauses (or stops). If the received signal includes no voice components or the tone of the voice components does not change within 1 second, scan resumes.

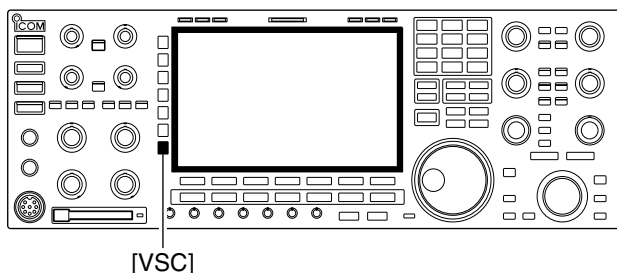

➔ While a phone mode (SSB, AM or FM) is selected, push [VSC] to switch the VSC (Voice Squelch Control) function ON or OFF.

- "VSC" appears when the function is activated.

- ▨ • The VSC function activates for any scan.
- ▨ • The VSC function resumes the scan on unmodulated signals, regardless of whether the scan resume condition is set to ON or OFF.

■ Scan set mode

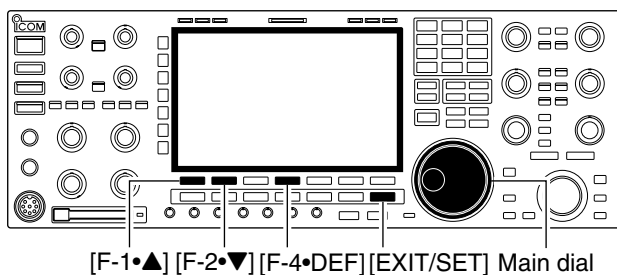

When the squelch is open, scan continues until it is stopped manually—it does not pause on detected signals. When squelch is closed, scan stops when detecting a signal, then resumes according to the scan resume condition. Scan speed and the scan resume condition can be set using the scan set mode.

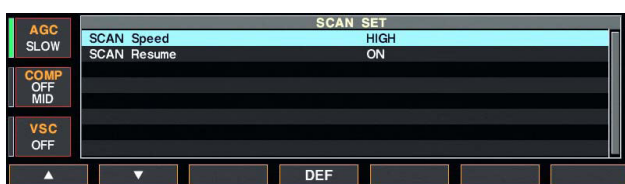

- ① Push [F-5•SCAN] to select scan screen.
- ② Push [F-7•SET] to select scan set mode.
- ③ Push [F-1•▲] or [F-2•▼] to select the desired item.
- ④ Rotate the main dial to select the desired condition.
 - Hold down [F-4•DEF] for 1 second to select the default setting.
- ⑤ Push [EXIT/SET] to return to scan menu.

SCAN Speed	HIGH
Select the desired scan speed from high and low.	<ul style="list-style-type: none"> • HIGH : scan is faster • LOW : scan is slower

SCAN Resume	ON
Set the scan resume function ON or OFF.	<ul style="list-style-type: none"> • ON : When detecting a signal, scan pauses for 10 seconds, then resumes. When a signal disappears, scan resumes 2 seconds later. • OFF : When detecting a signal, cancels scanning.

Programmed scan operation

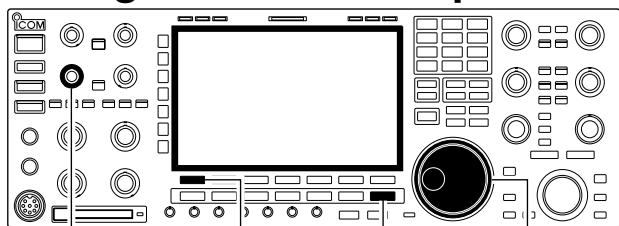

[SQL] for main [F-1•PROG] [EXIT/SET] Main dial

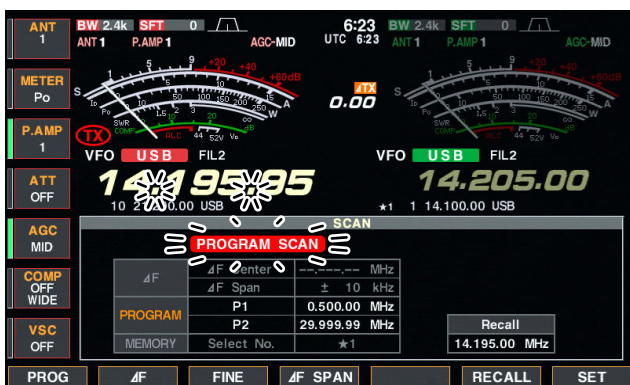

- ① Push [EXIT/SET] several times to close a multi-function screen, if necessary.
- ② Select VFO mode.
- ③ Select the desired operating mode.
 - The operating mode can also be changed while scanning.
- ④ Push [F-5•SCAN] to select the scan screen.
- ⑤ Set the main band's [SQL] open or closed.
 - See page 9-2 for squelch condition.
- ⑥ Push [F-1•PROG] to start the programmed scan.
 - "PROGRAM SCAN" and decimal points blink while scanning.
- ⑦ When the scan detects a signal, the scan stops, pauses or ignores it depending on the resume setting and the squelch condition.
- ⑧ To cancel the scan, push [F-1•PROG].
 - Rotating the main dial also cancels the scan.
- ⑨ Hold down [F-6•RECALL] for 1 second to recall the frequency that is set before starting the scan, if desired.

▨ If the same frequencies are programmed into the scan edge memory channel P1 and P2, programmed scan does not start.

ΔF scan operation

[F-4• ΔF SPAN]

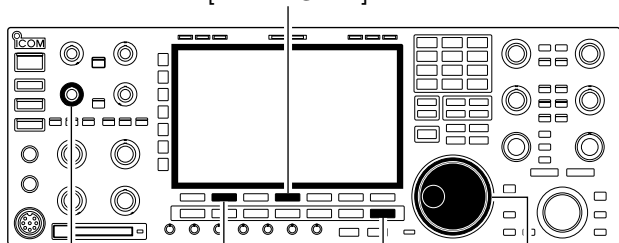

[SQL] for main [F-2• ΔF] [EXIT/SET] Main dial

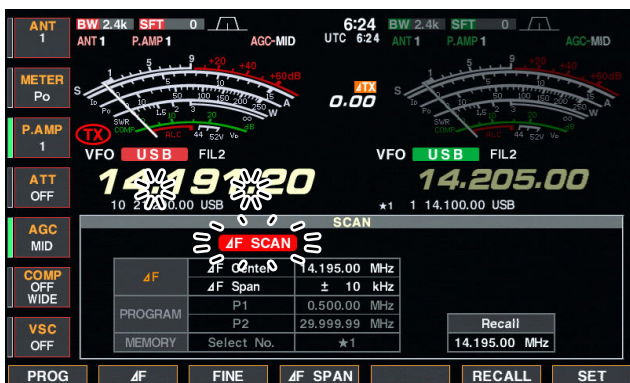

- ① Push [EXIT/SET] several times to close a multi-function screen, if necessary.
- ② Select VFO mode or a memory channel.
- ③ Select the desired operating mode.
 - The operating mode can also be changed while scanning.
- ④ Push [F-5•SCAN] to select the scan screen.
- ⑤ Set the main band's [SQL] open or closed.
 - See page 9-2 for squelch condition.
- ⑥ Set the ΔF span by pushing [F-4• ΔF SPAN].
 - ± 5 kHz, ± 10 kHz, ± 20 kHz, ± 50 kHz, ± 100 kHz, ± 500 kHz and ± 1000 kHz are selectable.
- ⑦ Set center frequency of the ΔF span.
- ⑧ Push [F-2• ΔF] to start the ΔF scan.
 - " ΔF SCAN" and decimal points blink while scanning.
- ⑨ When the scan detects a signal, the scan stops, pauses or ignores it depending on the resume setting and the squelch condition.
- ⑩ To cancel the scan, push [F-2• ΔF].
 - Rotating the main dial also cancels the scan.
- ⑪ Hold down [F-6•RECALL] for 1 second to recall the frequency that is set before starting the scan, if desired.

■ Fine programmed scan/fine ΔF scan

In fine scan (programmed or ΔF), the scan speed decreases when the squelch opens, but the transceiver keeps scanning. The scanning tuning step shifts from 50 Hz to 10 Hz when the squelch opens.

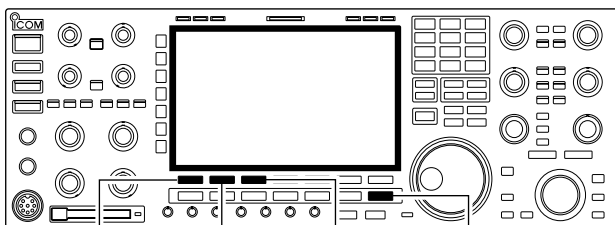

[F-1•PROG] [F-2• ΔF] [F-3•FINE] [EXIT/SET]

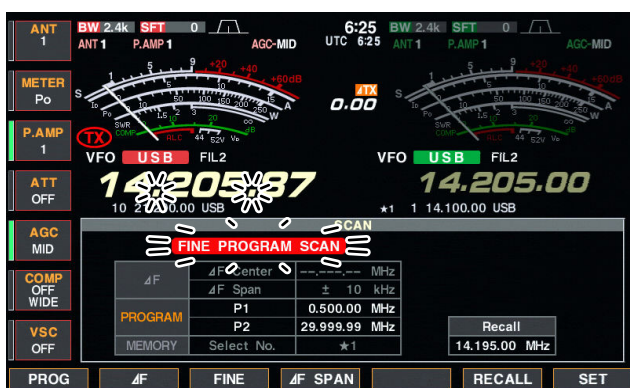

- ① Push [EXIT/SET] several times to close a multi-function screen, if necessary.
- ② Push [F-5•SCAN] to select the scan screen.
- ③ Set for programmed scan or ΔF scan as described on previous page.
- ④ Push [F-1•PROG] or [F-2• ΔF] to start a scan.
 - “PROGRAM SCAN” or “ ΔF SCAN” and decimal points blink while scanning.
- ⑤ Push [F-3•FINE] to start a fine scan.
 - “FINE PROGRAM SCAN” or “FINE ΔF SCAN” blinks instead of “PROGRAM SCAN” or “ ΔF SCAN,” respectively.
- ⑥ When the scan detects a signal, the scan speed decreases but scan does not stop.
- ⑦ Push [F-1•PROG] or [F-2• ΔF] to stop the scan; push [F-3•FINE] to cancel the fine scan.
 - Rotating the main dial also cancels the scan.
- ⑧ Hold down [F-6•RECALL] for 1 second to recall the frequency that is set before starting the scan, if desired.

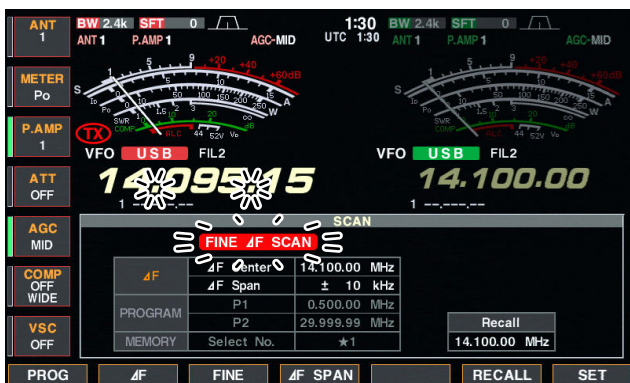

Memory scan operation

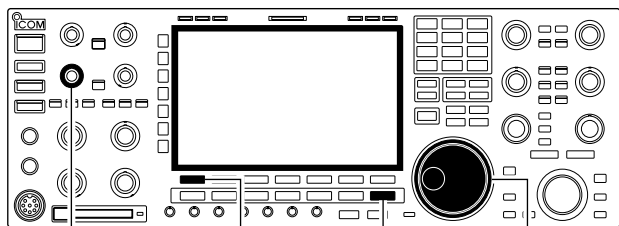

[SQL] for main [F-1•MEMO] [EXIT/SET] Main dial

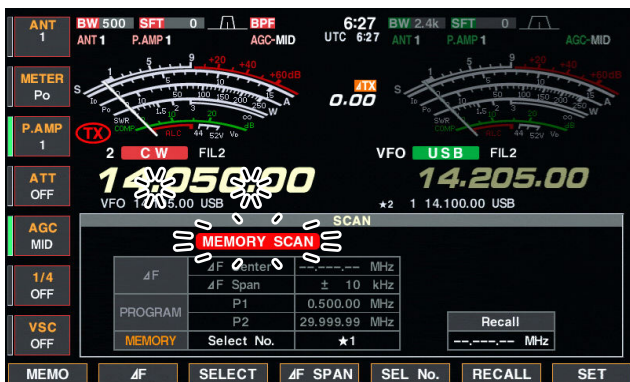

- ① Push [EXIT/SET] several times to close a multi-function screen, if necessary.
- ② Select memory mode.
- ③ Push [F-5•SCAN] to select the scan screen.
- ④ Set the main band's [SQL] open or closed.
 - See page 9-2 for squelch condition.
- ⑤ Push [F-1•MEMO] to start the memory scan.
 - “MEMORY SCAN” and decimal points blink while scanning.
- ⑥ When the scan detects a signal, the scan stops, pauses or ignores it depending on the resume setting and the squelch condition.
- ⑦ To cancel the scan, push [F-1•MEMO].
 - Rotating the main dial also cancels the scan.

2 or more memory channels must be programmed for memory scan to start.

Select memory scan operation

[F-3•SELECT] [F-5•SEL No.]

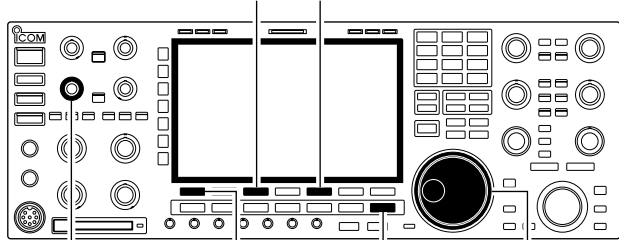

[SQL] for main [F-1•MEMO] [EXIT/SET] Main dial

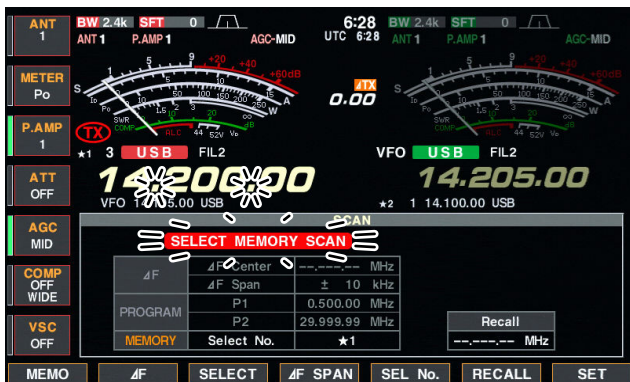

- ① Push [EXIT/SET] several times to close a multi-function screen, if necessary.
- ② Select memory mode.
- ③ Push [F-5•SCAN] to select the scan screen.
- ④ Set the main band's [SQL] open or closed.
 - See page 9-2 for squelch condition.
- ⑤ Push [F-5•SEL No.] several times to select the select scan number from ★1, ★2, ★3 and ★1/★2/★3.
- ⑥ Push [F-1•MEMO] to start the memory scan.
 - “MEMORY SCAN” and decimal points blink while scanning.
- ⑦ Push [F-3•SELECT] to start select memory scan; push [F-3•SELECT] again to return to memory scan, if desired.
 - “SELECT MEMORY SCAN” blinks instead of “MEMORY SCAN” during select memory scan.
- ⑧ When the scan detects a signal, the scan stops, pauses or ignores it depending on the resume setting and the squelch condition.
- ⑨ To cancel the scan, push [F-1•MEMO].
 - Rotating the main dial also cancels the scan.

2 or more memory channels must be designated as select memory channels, as well as the same select scan number, for select memory scan to start.

■ Setting select memory channels

◇ Setting in scan screen



- ① Push [EXIT/SET] several times to close a multi-function screen, if necessary.
- ② Select memory mode.
- ③ Push [F-5•SCAN] to select the scan screen.
- ④ Select the desired memory channel to set as a select memory channel.
 - [▲]/[▼] keys and direct keypad selections can be used.
- ⑤ Push [F-3•SELECT] several times to set the memory channel as a select memory ★1, ★2, ★3 or not.
- ⑥ Repeat steps ④ to ⑤ to program another memory channel as a select memory channel, if desired.
- ⑦ Push [EXIT/SET] to exit the scan screen.

◇ Setting in memory list screen



- ① Push [EXIT/SET] several times to close a multi-function screen, if necessary.
- ② Push [F-4•MEMORY] to select memory list screen.
- ③ Rotate the main dial while pushing [F-1•ROLL] or [F-2•SET] to select the desired memory channel.
 - [▲]/[▼] keys and direct keypad selections can be used.
- ④ Push [F-3•SELECT] several times to set the memory channel as a select memory ★1, ★2, ★3 or not.
- ⑤ Repeat steps ③ to ④ to program another memory channel as a select memory channel, if desired.
- ⑥ Push [EXIT/SET] to exit the memory list screen.

◇ Erasing the select scan setting



- ① Push [EXIT/SET] several times to close a multi-function screen, if necessary.
- ② Push [F-4•MEMORY] to select memory list screen, or push [F-5•SCAN] to select scan screen.
- ③ Hold down [F-3•SELECT] for 1 second to display memory select all clear window.
- ④ Push one of the following keys to clear all select scan setting.
 - [F-1•★1] : Clears all ★1 setting.
 - [F-2•★2] : Clears all ★2 setting.
 - [F-3•★3] : Clears all ★3 setting.
 - [F-4•★1,2,3] : Clears all select setting.
- ⑤ Push [EXIT/SET] to exit the memory list screen.

■ Tone scan

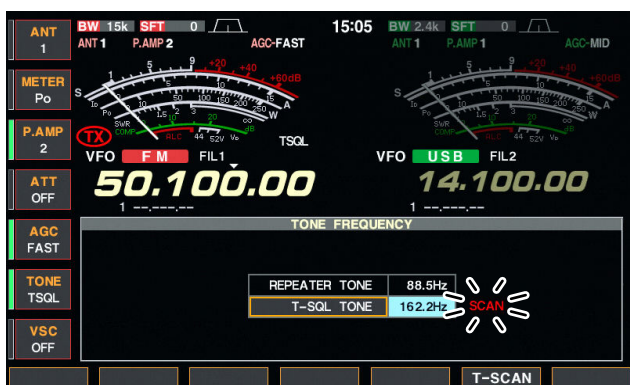
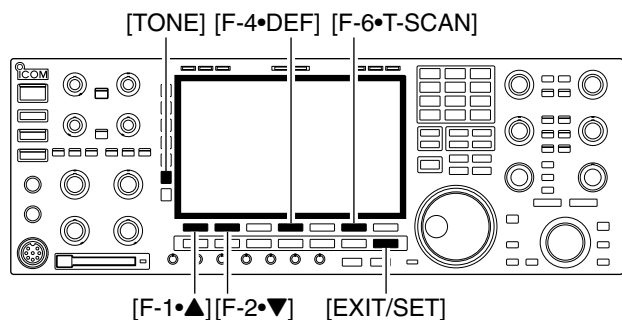

The transceiver can detect subaudible tones in a received signal. By monitoring a signal that is being transmitted on a repeater input frequency, you can determine the tone frequency required to access the repeater.

- ① Set the desired frequency or memory channel to be checked for a tone frequency.
- ② Push [AM/FM] several times to select FM mode.
- ③ Hold down [TONE] for 1 second to enter tone frequency screen.
- ④ Push [F-1•▲] or [F-2•▼] to check the repeater tone frequency or tone squelch frequency, respectively.
- ⑤ Push [F-6•T-SCAN] to start the tone scan.
 - “SCAN” blinks while scanning.
- ⑥ When the tone frequency is detected, the tone scan pauses.
 - The tone frequency is set temporarily on a memory channel. Program into the memory channel to store the tone frequency permanently.
 - The decoded tone frequency is used for the repeater tone frequency or tone squelch frequency.
- ⑦ To stop the scan, push [F-6•T-SCAN].
 - Hold down [F-4•DEF] for 1 second to select the default frequency.
- ⑧ Push [EXIT/SET] to exit tone frequency screen.

■ Antenna connection and selection	10-2
■ Antenna memory settings	10-3
◇ Antenna type selection	10-3
◇ Temporary memory	10-4
◇ Antenna selection mode	10-4
■ Antenna tuner operation	10-5
◇ Tuner operation	10-5
◇ If the tuner cannot tune the antenna	10-6

■ Antenna connection and selection

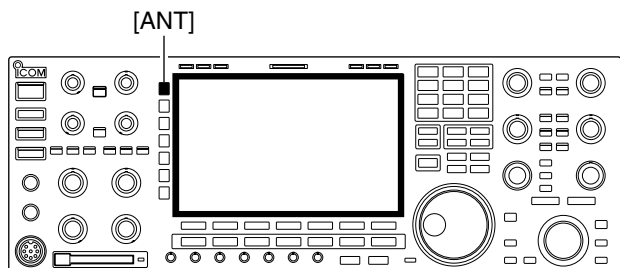

The IC-7800 has 4 antenna connectors for the HF/50 MHz bands, [ANT1], [ANT2], [ANT3], and [ANT4].

For each operating band the IC-7800 covers, there is a band memory which can memorize a selected antenna. When you change the operating frequency beyond a band, the previously used antenna is automatically selected (see below) for the new band. This function allows automatic switching of 4 separate antennas for HF and 50 MHz bands operation.

• Antenna selection mode: “Auto”

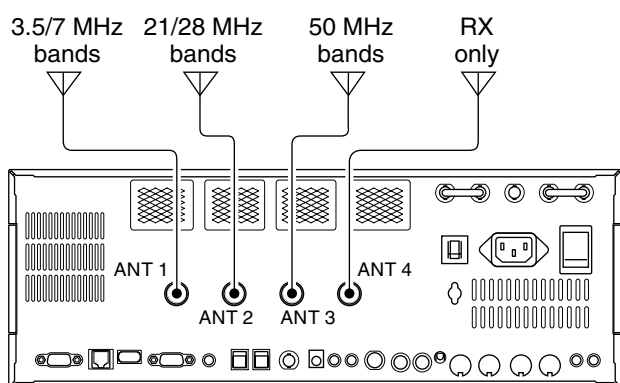

After an antenna has been selected for use (by pushing [ANT]), the antenna is automatically selected whenever that band is used.

[EXAMPLE]: a 3.5/7 MHz antenna is connected to [ANT1], a 21/28 MHz antenna is connected to [ANT2], a 50 MHz antenna is connected to [ANT3]. When the antenna selector function is set to “Auto,” an antenna is automatically selected when changing bands. [ANT4] can be used for receive only.

• Antenna selection mode: “Manual”

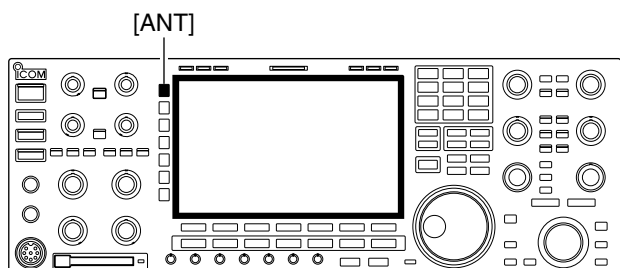

When “Manual” is selected, you can use the all antenna connectors, [ANT1] [ANT2], [ANT3] and [ANT4], however, band memory does not function. In this case you must select an antenna manually.

• Antenna selection mode: “OFF”

In this case, only [ANT1] antenna connector can be used. [ANT] switch does not function.

■ Antenna memory settings

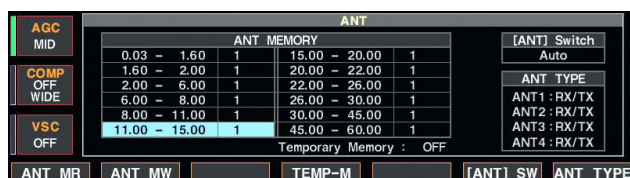
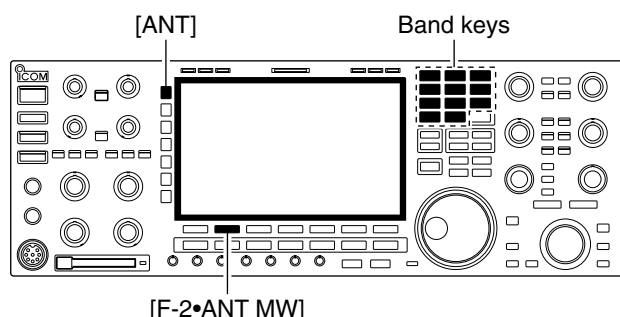

This function stores the antenna connector number for each frequency band.

- ① Push [EXIT/SET] several times to close multi-function screen, if necessary.
- ② Hold down [ANT] for 1 second to select antenna set screen.
- ③ Select the desired frequency band with a band key.
- ④ Push [ANT] several times to select the desired antenna number that you want to set for the selected frequency band.
 - “★” appears.
- ⑤ Hold down [F-2•ANT MW] for 1 second to store the antenna selection into the antenna memory.
 - “★” disappears.
- ⑥ Repeat the steps ③ to ⑤ to store the antenna selection for another frequency bands, if desired.
- ⑦ Push [EXIT/SET] to exit antenna set screen.

◇ Antenna type selection



When no antenna is connected to [ANT2], [ANT3], and/or [ANT4], these antenna connectors can be deactivated— deleting the antenna number from selection. This prevent the transceiver from accidentally transmitting into an empty antenna connector. In addition, a receive-only antenna can be specified for [ANT4].

- ① Select the antenna set screen as described above.
- ② Push [F-7•ANT TYPE] to select antenna type set screen.
- ③ Push [F-1•▲] or [F-2•▼] to select the desired antenna.
- ④ Rotate the main dial to select the desired antenna condition from TX/RX, RX (ANT4 only) and OFF.
 - TX/RX : Select when an antenna is connected.
 - OFF : Select when no antenna is connected.
 - RX : Select when a receive only antenna is connected. (available for the [ANT4] only)
- ⑤ Push [EXIT/SET] to exit antenna type set screen.

✓ For your information

The “OFF” antennas cannot be selected with [ANT] switch operation, or with the antenna memory setting. When “RX” is selected for [ANT4], “1/R,” “2/R” and “3/R” selections will be added for the selection for both [ANT] switch operation and the antenna memory setting. In these selections, using the antenna connected to [ANT1], [ANT2] and/or [ANT3] for transmission and using the antenna connected to [ANT4] for reception.

■ Antenna memory settings (continued)

◇ Temporary memory

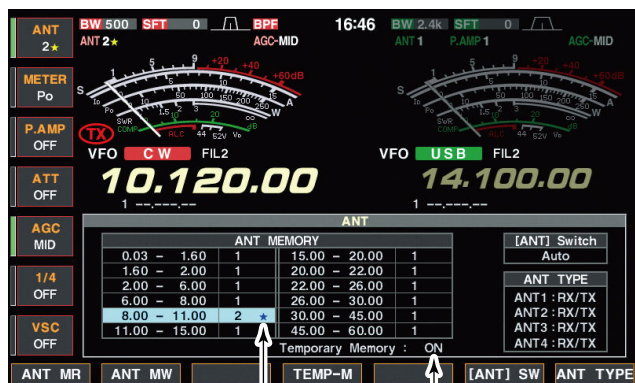

“★” appears when a different antenna from the original is selected.

Push [F-4]•TEMP-M to turn the temporary memory ON and OFF.

The antenna temporary memory memorizes the manually selected antenna. The selected antenna will be re-called even if frequency band has been changed.

- ① Select the antenna set screen.
- ② Push [F-4]•TEMP-M to turn the temporary memory ON or OFF.
- ③ Select the desired frequency band with a band key.
- ④ Push [ANT] to select the desired antenna.
 - “★” appears when a different antenna from the original is selected.
- ⑤ Push [F-1]•ANT MR] to re-call the original antenna.
 - “★” disappears.
- ⑥ Push [EXIT/SET] to exit antenna set screen.

CAUTION: Before transmitting with the manually selected antenna, make sure the selected antenna suits the operating frequency. Otherwise the transmitter may be damaged.

◇ Antenna selection mode

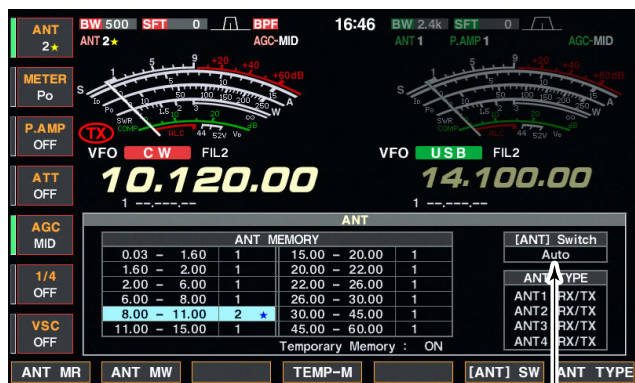

Push [F-6]•[ANT] SW to select the antenna selection mode.

The automatic antenna selection (antenna memory) and the [ANT] switch function can be deactivated if desired.

- ① Select the antenna set screen.
- ② Push [F-6]•[ANT] SW to select the antenna selection from Auto, OFF and Manual.
 - Auto : Use the antenna memory. Antenna selection with [ANT] switch is also available.
 - OFF : Only the antenna connected to [ANT1] can be used. [ANT] switch is deactivated.
 - Manual : Deactivate the antenna memory function. Antenna can be selected with [ANT] switch operation only.
- ③ Push [EXIT/SET] to exit antenna set screen.

■ Antenna tuner operation

The internal automatic antenna tuner matches the transceiver to the connected antenna automatically. After the tuner matches an antenna, the variable capacitor angles are memorized as a preset point for each frequency range (100 kHz steps). Therefore, when you change the frequency range, the variable capacitors are automatically preset to the memorized point.

CAUTION: NEVER transmit with the tuner ON when no antenna is connected. This will damage the transceiver. Be careful of the antenna selection.

◇ Tuner operation

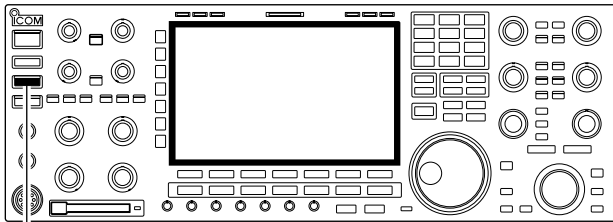

[TUNER]

- ➔ Push [TUNER] to turn the internal antenna tuner ON. The antenna is tuned automatically when the antenna SWR is higher than 1.5:1.
 - When the tuner is ON, [TUNER] switch indicator lights green.
 - While tuning, [TUNER] switch indicator blinks green.

NOTES:

- **NEVER** transmit without an antenna properly connected to antenna port in use.
- When 2 or more antennas are connected, select the antenna to be used with [ANT].
- If the SWR is higher than about 1.5:1 when tuning above 100 kHz on an antenna's preset point, hold down [TUNER] for 1 second to start manual tuning.
- The internal tuner may not be able to tune in AM mode. In such cases, hold down [TUNER] for 1 second to manually tune.

• MANUAL TUNING

During SSB operation at low voice levels, the internal tuner may not be tuned correctly. In such cases, manual tuning is helpful.

- ➔ Hold down [TUNER] for 1 second, to start manual tuning.
 - A side tone is emitted and [TUNER] switch indicator blinks red while tuning.
 - If the tuner cannot reduce the SWR to less than 1.5:1 after 20 seconds of tuning, the [TUNER] switch indicator goes out.

• AUTOMATIC TUNER START (HF bands only)

If you want to deactivate the tuner under conditions of VSWR 1.5:1 or less, use the auto tuner start function and turn the tuner OFF. This function activates the tuner automatically when the SWR exceeds 1.5:1.

This function is turned ON in set mode. (p. 12-16).

■ Antenna tuner operation (continued)

• PTT TUNER START

The tuner is always tuned when the PTT is pushed after the frequency is changed (more than 1% from last-tuned frequency). This function removes the “hold down [TUNER]” operation and activates for the first transmission on a new frequency.

This function is turned ON in set mode. (p. 12-16).

• Antenna tuner of the IC-PW1

When using an external antenna tuner such as the IC-PW1's tuner, tune with the external antenna tuner, and turn OFF the IC-7800's tuner. After tuning is completed, turn the internal tuner ON. Otherwise, both tuners tune simultaneously and correct tuning may not be obtained.

See the instruction manual included with each antenna tuner for their respective operations.

◇ If the tuner cannot tune the antenna

Check the following and try again:

- the [ANT] connector selection.
- the antenna connection and feedline.
- the untuned antenna SWR. (Less than 3:1 for HF bands; Less than 2.5:1 for 50 MHz band)
- the transmit power. (8 W for HF bands; 15 W for 50 MHz band)
- the power source voltage/capacity.

If the tuner cannot reduce the SWR to less than 1.5:1 after checking the above, perform the following:

- repeat manual tuning several times.
- tune with a 50 Ω dummy load and re-tune the antenna.
- turn power OFF and ON.
- adjust the antenna feedline length.
(This is effective for higher frequencies in some cases.)
- Some antennas, especially for low bands, have a narrow bandwidth. These antennas may not be tuned at the edge of their bandwidth, therefore, tune such an antenna as follows:

[Example]: Suppose you have an antenna which has an SWR of 1.5:1 at 3.55 MHz and an SWR of 3:1 at 3.8 MHz.

- ① Set 3.55 MHz and hold down [TUNER] for 1 second to start manual tuning.
- ② Set 3.80 MHz and hold down [TUNER] for 1 second to start manual tuning.

■ Time set mode	11-2
■ Daily timer setting	11-3
■ Setting sleep timer	11-4
■ Timer operation	11-4

Time set mode

[ABC]/[abc] [123]/[Symbol] [F-3•◀▶] [F-5•EDIT]/[F-5•SET]

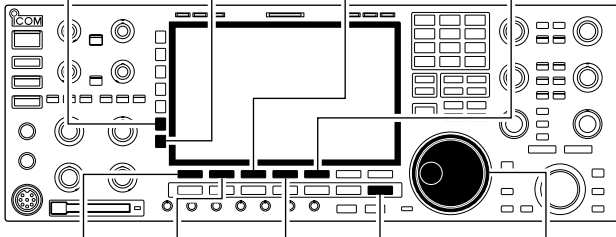

[F-1•▲] [F-2•▼] [F-4•DEF] [EXIT/SET] Main dial

The IC-7800 has a built-in calendar and 24-hour clock with daily power ON/OFF timer functions. Before operating these timer functions, set the current date and time.

- ① Push [EXIT/SET] to close multi-function screen, if necessary.
- ② Push [F-7•SET] to select set mode menu screen.
- ③ Push [F-4•TIME] to select time set mode.
- ④ Push [F-1•▲] or [F-2•▼] to select the desired item.
- ⑤ Rotate the main dial to set or select the desired value or condition.
- ⑥ Push [EXIT/SET] to exit time set mode.

Date	2000 - 1 - 1 (Sat)
Sets the date.	<ol style="list-style-type: none"> ① Push [F-3•◀▶] to select between the year and the month/day, then rotate the main dial to select them. <ul style="list-style-type: none"> • The date setting and “DATE-set Push [SET]” indication blink. ② Push [F-5•SET] to set the date.

Time (Now)	1:23
Sets the local time.	<ol style="list-style-type: none"> ① Rotate the main dial to set the local time. <ul style="list-style-type: none"> • The time setting and “TIME-set Push [SET]” indication blink. ② Push [F-5•SET] to set the time.

CLOCK2 Function	ON
Turns the clock 2 indication ON or OFF. The clock 2 is convenient to indicate the UTC or other country's local time, etc.	<ul style="list-style-type: none"> • ON : The clock 2 is displayed below the local time indication. • OFF : The clock 2 does not display.

CLOCK2 Offset	± 0:00
Sets the desired off-set time period for clock 2 display within -24:00 to +24:00 in 5 min. steps.	<ul style="list-style-type: none"> • Hold down [F-4•DEF] for 1 second to select the default value.

CLOCK2 Name	UTC
Sets the desired 3-character name for clock 2. Capital letters, small letters, numerals, some symbols (! # \$ % & ¥ ? " ' ` ^ + - * / . , ; = < > () [] { } _ ~ @) and spaces can be used.	<ol style="list-style-type: none"> ① Push [F-5•EDIT] to select the name edit condition. <ul style="list-style-type: none"> • The cursor under the 1st character blinks. ② Push [ABC], [abc], [123] or [Symbol] to select the character group, then rotate the main dial to select the character. <ul style="list-style-type: none"> • Push [ABC] or [abc] to toggle capital and small letters. • Push [123] or [Symbol] to toggle numerals and symbols. • Push [F-1•◀] or [F-2•▶] for cursor movement. • Push [F-3•DEL] to delete the selected character. • Push [F-4•SPACE] to input a space. • Pushing the transceiver's keypad, [0]–[9], can also enter numerals. ③ Push [EXIT/SET] to set the name.

■ Daily timer setting

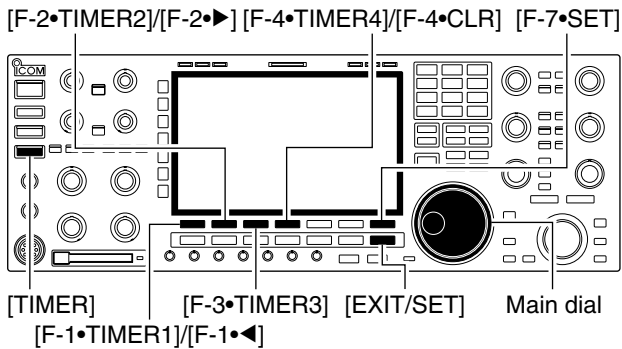

The transceiver turns power ON and/or OFF automatically on the specified day and time, with the specified frequency settings in each main and sub readout.

- ① Push [EXIT/SET] several times to close multi-function screen, if necessary.
- ② Hold down [TIMER] for 1 second to select timer set screen.
- ③ Push one of [F-1•TIMER1] to [F-5•TIMER5] to select the desired timer.
- ④ Rotate the main dial to select the timer action ON or OFF.
- ⑤ Push [F-2•▶] to select the “DAY” cell, then rotate the main dial to select the desired day of the week.
 - Select “- - -” not to specify the day of the week. The timer will function every day in this case.
 - Once a day of the week is selected, hold down [F-4•CLR] for 1 second to select “- - -.”
- ⑥ Push [F-2•▶] to select the “REPEAT” cell, then rotate the main dial to select the repeat function ON or OFF.
 - ON : The timer functions every selected day of the week. (repeats)
 - OFF : The timer does not repeat.
- ⑦ Push [F-2•▶] to select the “ON” cell, then rotate the main dial to set the desired transceiver power ON time.
 - When using power OFF timer only, hold down [F-4•CLR] for 1 second to select “- - -.”
- ⑧ Push [F-2•▶] to select the “OFF” cell, then rotate the main dial to set the desired transceiver power OFF time.
 - When using power ON timer only, hold down [F-4•CLR] for 1 second to select “- - -.”
- ⑨ Push [F-2•▶] to select the “MAIN” cell, then rotate the main dial to select the desired memory channel number in the main readout.
 - If using the currently set VFO condition in main readout, hold down [F-4•CLR] for 1 second to select “- - -.”
- ⑩ Push [F-2•▶] to select the “SUB” cell, then rotate the main dial to select the desired memory channel number in the sub readout.
 - If using the currently set VFO condition in sub readout, hold down [F-4•CLR] for 1 second to select “- - -.”
- ⑪ Push [F-7•SET] to set the timer.
 - The timer indicator above [TIMER] switch lights green.
- ⑫ Repeat steps ③ to ⑪ to set other timers, if desired.
- ⑬ Push [EXIT/SET] to exit timer set screen.

■ Setting sleep timer

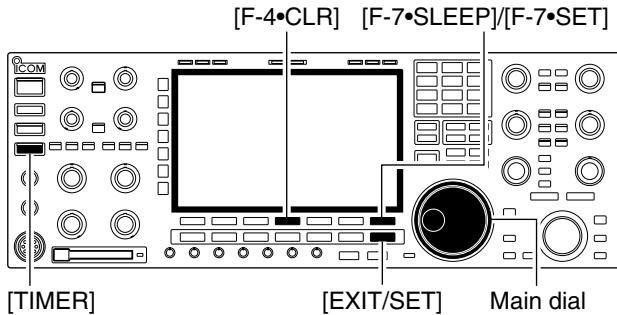

The sleep timer turns the transceiver power OFF automatically after passing the set period. The timer can be set to 5–120 min. in 5 min. steps.

- ① Push [EXIT/SET] several times to close a multi-function screen, if necessary.
- ② Hold down [TIMER] for 1 second to select timer set screen.
- ③ Push [F-7•SLEEP] to select the sleep timer set condition.
 - “--” blinks.
- ④ Set the desired time period using the main dial.
 - “TIMER-set Push [SET]” blinks.
 - Push [F-4•CLR] to select “--” to cancel the setting.
- ⑤ Push [F-7•SET] to set the time.
 - Push [EXIT/SET] to cancel the setting.
 - The timer indicator above [TIMER] switch lights green.
- ⑥ Push [EXIT/SET] to exit timer set screen.
- ⑦ The transceiver emits 10 beeps and turns OFF after the sleep timer period elapses.
 - The timer indicator blinks while beeping.
 - Push [TIMER] momentarily to cancel the sleep timer, if desired.

■ Timer operation

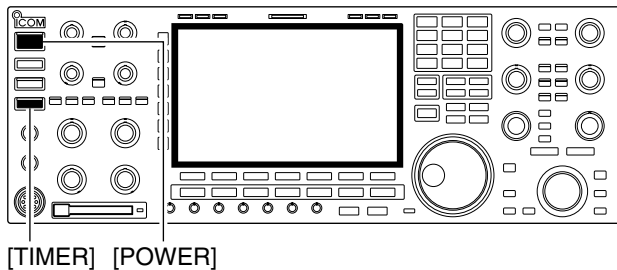

- ① Preset the daily timer as described previously.
- ② Push [TIMER] momentarily to turn the timer function ON.
 - The timer indicator above this switch lights green when the timer function is ON.
- ③ Hold down [POWER] for 1 second to turn the power OFF.
 - The timer indicator lights continuously.
- ④ When the set time arrives, the power is automatically turned ON.
- ⑤ The transceiver emits 10 beeps and turns OFF after the power-off period elapses.
 - The timer indicator blinks while beeping.
 - Push [TIMER] momentarily to cancel the sleep timer, if desired.

▨ The timer action in timer set screen must be selected ON to enable the timer operation, described in page 11-3 steps ④.

■ Set mode description.....	12-2
◇ Set mode operation	12-2
◇ Screen arrangement	12-3
■ Level set mode	12-4
■ ACC set mode	12-6
■ Display set mode	12-11
■ Others set mode.....	12-14
■ CF/USB-MEMORY set menu	12-27
◇ CF/USB-MEMORY set screen arrangement.....	12-27
◇ Save option set mode	12-28
◇ Load option set mode	12-29
■ File saving	12-30
■ File loading	12-31
■ Changing the file name	12-32
■ Deleting a file	12-33
■ Formatting the memory device	12-33
■ Unmounting the memory device	12-34

■ Set mode description

Set mode is used for programming infrequently changed values or conditions of functions. The IC-7800 has a level set mode, display set mode, timer set mode, accessory set mode, others set mode and CF/USB-Memory set mode.

◇ Set mode operation

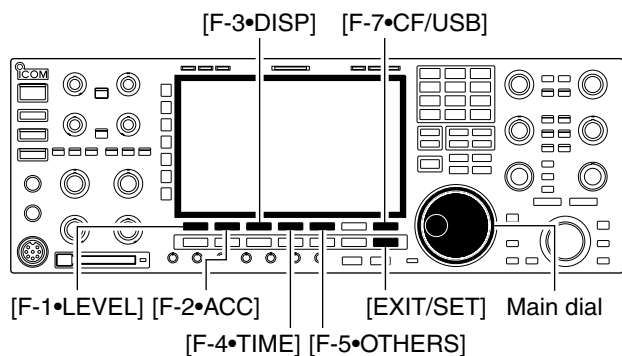

- ① Push [EXIT/SET] several times to close a multi-function screen, if necessary.
- ② Push [F-7•SET] to select set mode menu screen.
 - Holding down [EXIT/SET] for 1 second also selects set mode menu screen.
- ③ Push [F-1•LEVEL], [F-2•ACC], [F-3•DISP], [F-4•TIME], [F-5•OTHERS] or [F-7•CF/USB] to enter a desired set mode.
- ④ For level, accessory, display and others set mode, push [F-7•WIDE] to toggle wide and normal screen.
- ⑤ Push [F-1•▲] or [F-2•▼] to select a desired item, then rotate main dial to adjust/select a desired value or condition.
 - Pushing [F-3•◀ ▶] operation may be necessary for some items.
- ⑥ Push [EXIT/SET] twice to exit set mode.

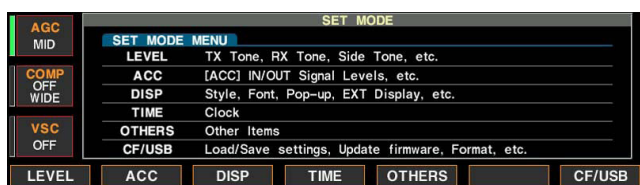

◇ Screen arrangement



• Display set mode (p. 12-11)



• Set mode menu screen (p. 12-2)

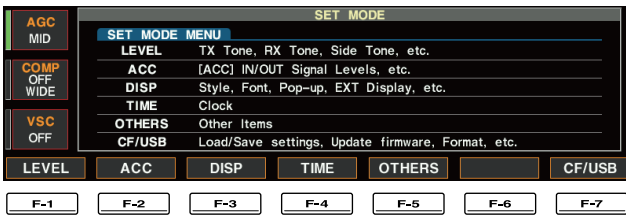

• Time set mode (p. 11-2)



• Level set mode (p. 12-4)



• Others set mode (p. 12-14)

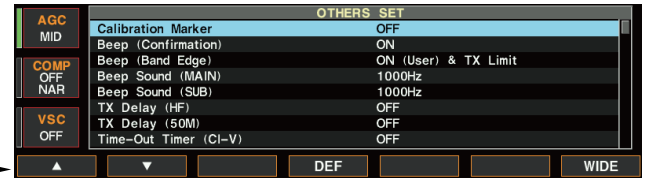

• ACC set mode (p. 12-6)



• CF/USB memory set menu (p. 12-27)

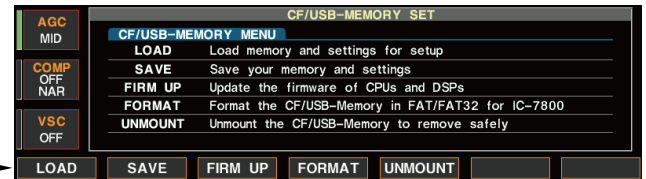

F-2 F-7

■ Level set mode

SSB TX Tone (Bass)  0

Sets the bass level of the transmit audio tone in SSB mode from -5 to +5. (default: 0)

SSB TX Tone (Treble)  0

Sets the treble level of the transmit audio tone in SSB mode from -5 to +5. (default: 0)

AM TX Tone (Bass)  0

Sets the bass level of the transmit audio tone in AM mode from -5 to +5. (default: 0)

AM TX Tone (Treble)  0

Sets the treble level of the transmit audio tone in AM mode from -5 to +5. (default: 0)

FM TX Tone (Bass)  0

Sets the bass level of the transmit audio tone in FM mode from -5 to +5. (default: 0)

FM TX Tone (Treble)  0

Sets the treble level of the transmit audio tone in FM mode from -5 to +5. (default: 0)

SSB RX Tone (Bass)  0

Sets the bass level of the receive audio tone in SSB mode from -5 to +5. (default: 0)

SSB RX Tone (Treble)  0

Sets the treble level of the receive audio tone in SSB mode from -5 to +5. (default: 0)

AM RX Tone (Bass)  0

Sets the bass level of the receive audio tone in AM mode from -5 to +5. (default: 0)

AM RX Tone (Treble)  0

Sets the treble level of the receive audio tone in AM mode from -5 to +5. (default: 0)

■ Level set mode (continued)

FM RX Tone (Bass)

0

Sets the bass level of the receive audio tone in FM mode from -5 to +5. (default: 0)

FM RX Tone (Treble)

0

Sets the treble level of the receive audio tone in FM mode from -5 to +5. (default: 0)

SSB TBW (WIDE)

100 - 2900

Sets the transmission passband width to wide setting by changing the lower and higher cut-off frequencies.

Lower freq. : 100 (default), 200, 300 and 500 Hz
Higher freq.: 2500, 2700, 2800 and 2900 Hz (default)

SSB TBW (MID)

300 - 2700

Sets the transmission passband width to middle setting by changing the lower and higher cut-off frequencies.

Lower freq. : 100, 200, 300 (default) and 500 Hz
Higher freq.: 2500, 2700 (default), 2800 and 2900 Hz

SSB TBW (NAR)

500 - 2500

Sets the transmission passband width to narrow setting by changing the lower and higher cut-off frequencies.

Lower freq. : 100, 200, 300 and 500 Hz (default)
Higher freq.: 2500 (default), 2700, 2800 and 2900 Hz

Speech Level

50%

Sets the voice synthesizer audio output level from 0 to 100% in 1% step. (default: 50%)

Side Tone Level

50%

Sets the CW side tone output level from 0 to 100% in 1% step. (default: 50%)

Side Tone Level Limit

ON

Turns the CW side tone output level limiting capability from ON or OFF. (default: ON)

APF AF Level

0dB

Sets the audio level that the audio peak filter is ON in the CW mode, from 0 to +6 dB in 1dB step. (default: 0dB)

Beep Level

50%

Sets the beep output level from 0 to 100% in 1% steps. (default: 50%)

■ Level set mode (continued)

Beep Level Limit	ON
Turns the beep output level limiting capability ON or OFF. (default: ON)	

Phones Level Ratio	 1.00
Sets the ratio for audio output level from the headphone toward to the internal speaker within 0.60 to 1.40 range in 0.01 steps. (default: 1.00)	

Phone L/R Mix	OFF
Selects the headphone audio output.	<ul style="list-style-type: none"> • OFF : Outputs the main band's audio from the left, and sub band's audio from the right. (default) • ON : Outputs the mixed audio.

■ ACC set mode

ACC-A AF/SQL Output Select	MAIN
Selects the desired band for the audio and squelch signals output from [ACC1-A] (Audio: pin 5, Squelch: pin 6) from MAIN and SUB.	<ul style="list-style-type: none"> • MAIN : Main band's AF and squelch signals are output from [ACC1-A]. (default) • SUB : Sub band's AF and squelch signals are output from [ACC1-A].

ACC-B AF/SQL Output Select	SUB
Selects the desired band for the audio and squelch signals output from [ACC1-B] (Audio: pin 5, Squelch: pin 6) from MAIN and SUB.	<ul style="list-style-type: none"> • MAIN : Main band's AF and squelch signals are output from [ACC1-B]. • SUB : Sub band's AF and squelch signals are output from [ACC1-B]. (default)

ACC-A AF Output Level	 50%
Sets the desired audio output level, output from [ACC1-A], within 0 to 100% in 1% steps.	<ul style="list-style-type: none"> • Outputs approximately 200 mV at 50% (default) setting.

ACC-B AF Output Level	 50%
Sets the desired audio output level, output from [ACC1-B], within 0 to 100% in 1% steps.	<ul style="list-style-type: none"> • Outputs approximately 200 mV at 50% (default) setting.

S/PDIF Output Level	 100%
Sets the desired output level of [S/P DIF], within 0 to 100% in 1% steps. (default: 100%)	

■ ACC set mode (continued)

ACC-A MOD Level			50%
Sets the desired audio input level for modulation from [ACC1-A].		• Approximately 100 mV at 50% (default) setting.	

ACC-B MOD Level			50%
Sets the desired audio input level for modulation from [ACC1-B].		• Approximately 100 mV at 50% (default) setting.	

S/PDIF MOD Level			50%
Sets the desired input level for modulation from [S/P DIF], within 0 to 100% in 1% steps. (default: 50%)			

LAN MOD Level			50%
Sets the desired input level for modulation from [LAN], within 0 to 100% in 1% steps. (default: 50%)			

DATA OFF MOD	MIC,ACC-A,ACC-B	
Selects the desired connector(s) for modulation input when data mode is not in use.	• MIC	: Use the signals from [MIC].
	• ACC-A	: Use the signals from [ACC1-A] (pin 4).
	• ACC-B	: Use the signals from [ACC1-B] (pin 4).
	• MIC,ACC-A	: Use the signals from [MIC] and [ACC1-A] (pin 4).
	• MIC,ACC-B	: Use the signals from [MIC] and [ACC1-B] (pin 4).
	• ACC-A,ACC-B	: Use the signals from [ACC1-A] and [ACC1-B] (pin 4).
	• MIC,ACC-A,ACC-B	: Use the signals from [MIC], [ACC1-A] and [ACC1-B] (pin 4). (default)
	• S/P DIF	: Use the signals from [S/P DIF].
	• LAN	: Use the signals from [LAN].

■ ACC set mode (continued)

DATA1 MOD	ACC-A
Selects the desired connector(s) for modulation input when data 1 mode (D1) is in use.	• MIC : Use the signals from [MIC].
	• ACC-A : Use the signals from [ACC1-A] (pin 4). (default)
	• ACC-B : Use the signals from [ACC1-B] (pin 4).)
	• MIC,ACC-A : Use the signals from [MIC] and [ACC1-A] (pin 4).
	• MIC,ACC-B : Use the signals from [MIC] and [ACC1-B] (pin 4).
	• ACC-A,ACC-B : Use the signals from [ACC1-A] and [ACC1-B] (pin 4).
	• MIC,ACC-A,ACC-B : Use the signals from [MIC], [ACC1-A] and [ACC1-B] (pin 4).
	• S/P DIF : Use the signals from [S/P DIF].
	• LAN : Use the signals from [LAN].

DATA2 MOD	ACC-B
Selects the desired connector(s) for modulation input when data 2 mode (D2) is in use.	• MIC : Use the signals from [MIC].
	• ACC-A : Use the signals from [ACC1-A] (pin 4).
	• ACC-B : Use the signals from [ACC1-B] (pin 4). (default)
	• MIC,ACC-A : Use the signals from [MIC] and [ACC1-A] (pin 4).
	• MIC,ACC-B : Use the signals from [MIC] and [ACC1-B] (pin 4).
	• ACC-A,ACC-B : Use the signals from [ACC1-A] and [ACC1-B] (pin 4).
	• MIC,ACC-A,ACC-B : Use the signals from [MIC], [ACC1-A] and [ACC1-B] (pin 4).
	• S/P DIF : Use the signals from [S/P DIF].
	• LAN : Use the signals from [LAN].

DATA3 MOD	ACC-A,ACC-B
Selects the desired connector(s) for modulation input when data 3 mode (D3) is in use.	• MIC : Use the signals from [MIC].
	• ACC-A : Use the signals from [ACC1-A] (pin 4).
	• ACC-B : Use the signals from [ACC1-B] (pin 4).
	• MIC,ACC-A : Use the signals from [MIC] and [ACC1-A] (pin 4).
	• MIC,ACC-B : Use the signals from [MIC] and [ACC1-B] (pin 4).
	• ACC-A,ACC-B : Use the signals from [ACC1-A] and [ACC1-B] (pin 4). (default)
	• MIC,ACC-A,ACC-B : Use the signals from [MIC], [ACC1-A] and [ACC1-B] (pin 4).
	• S/P DIF : Use the signals from [S/P DIF].
	• LAN : Use the signals from [LAN].

■ ACC set mode (continued)

ACC-A BAND Voltage Output	TX
Selects the desired band for the operating frequency band control signal output from [ACC2-A] (pin 4).	<ul style="list-style-type: none"> • MAIN : Outputs the band signal displayed in main readout. • SUB : Outputs the band signal displayed in sub readout. • TX : Outputs the band signal, that can be transmitted. (default)

ACC-B BAND Voltage Output	TX
Selects the desired band for the operating frequency band control signal output from [ACC2-B] (pin 4).	<ul style="list-style-type: none"> • MAIN : Outputs the band signal displayed in main readout. • SUB : Outputs the band signal displayed in sub readout. • TX : Outputs the band signal, that can be transmitted. (default)

SEND Relay Type	MOS-FET
Selects the switching relay type for [RELAY] from Reed and MOS-FET. Select the suitable relay type when connecting a non-lcom linear amplifier.	<ul style="list-style-type: none"> • Reed : Use mechanical relay. (16 V DC/0.5 A max.) • MOS-FET : Use semiconductor type relay. (250 V/200 mA max.; default)

External Meter Output (M)	Auto
Selects the desired item for an external meter indication (main readout).	<ul style="list-style-type: none"> • Auto : Outputs the receiving signal strength level during receive, and outputs the selected level (selected with [METER]), during transmit. (default) • S(MAIN) : Outputs the receiving signal strength level during receive. • Po : Outputs the transmitting power level during transmit. • SWR : Outputs the VSWR level during transmit. • ALC : Outputs the ALC level during transmit. • COMP : Outputs the compression level during transmit. • V_D : Outputs the drain terminal voltage of the final amplifier MOS-FETs. • I_D : Outputs the drain current of the final amplifier MOS-FETs.

■ ACC set mode (continued)

External Meter Output (S)	Auto
<p>Selects the desired item for an external meter indication (sub readout).</p>	<ul style="list-style-type: none"> • Auto : Outputs the receiving signal strength level during receive, and outputs the selected level (selected with [METER]), during transmit. (default) • S(SUB) : Outputs the receiving signal strength level during receive. • Po : Outputs the transmitting power level during transmit. • SWR : Outputs the VSWR level during transmit. • ALC : Outputs the ALC level during transmit. • COMP : Outputs the compression level during transmit. • Vd : Outputs the drain terminal voltage of the final amplifier MOS-FETs. • Id : Outputs the drain current of the final amplifier MOS-FETs.

External Meter Level (M)	 50%
<p>Sets the output level for an external meter indication (main readout) with in 0 to 100% range in 1% steps.</p>	<ul style="list-style-type: none"> • Approximately 2.5 V at 50% (default) setting for full-scale indication. (4.7 kΩ impedance)

External Meter Level (S)	 50%
<p>Sets the output level for an external meter indication (sub readout) with in 0 to 100% range in 1% steps.</p>	<ul style="list-style-type: none"> • Approximately 2.5 V at 50% (default) setting for full-scale indication. (4.7 kΩ impedance)

REF IN/OUT	OFF
<p>Selects the transceiver's reference signal condition from IN, OFF and OUT.</p>	<ul style="list-style-type: none"> • IN : Use an external reference signal for the IC-7800. Turn the transceiver power OFF then ON to make the setting effective. • OFF : Not input/output the reference signal. (default) • OUT : Outputs the IC-7800 reference signal to externally connected equipment(s) for their reference. <p>  NOTE: If the applied reference signal is off-frequency, or no signal is applied with "IN" selection, the IC-7800 will not work properly. Select "OFF" or "OUT" then reboot the IC-7800 in such case. </p>

REF Adjust	 50%
<p>Adjusts the internal reference signal frequency within 0 to 100% range in 1% steps during frequency calibration.</p>	<p>  NOTE: The default setting is different for each transceiver. </p>

■ Display set mode

LCD Unit Bright

 50%

Adjusts the LCD unit brightness from 0 (dark) to 100% (bright) range in 1% steps. (default: 50%)

Backlight (Switches)

 80

Adjusts the switch indicators brightness from 1 (dark) to 100 (bright) range in 1 steps. (default: 80)

Display Type

A

Selects the desired display type from A, B and C. (default: A)

Display Font

Italic (1)

Selects the desired font for frequency readout from Italic (1), Italic (2), Italic (3), Italic (4), Round (1), Round (2), Round (3), Shadow (1), Shadow (2), Shadow (3), Qubic (1), Qubic (2), Qubic (3), Qubic (4), IC-780 (1), IC-780 (2), IC-780 (3) and IC-780 (4). (default: Italic (1))

Text Font

Normal

Selects the desired font for the displays other than frequency readout from Normal and Slim. (default: Normal)

Meter Response

MID

Set meter needle response from SLOW, MID and FAST. (default: MID)

This setting is effective for the standard and edge-wise meter type selections only.

Meter Type (Normal Screen)

Standard

Selects the desired S/RF meter type during normal screen indication from Standard, Edgewise and Bar. (default: Standard)

Meter Type (Wide Screen)

Edgewise

Selects the desired S/RF meter type during wide screen or mini scope indication from Edgewise and Bar. (default: Edgewise)

Meter Peak Hold (Bar)

ON

Turns the meter peak hold function ON or OFF. (default: ON)
This function is used for the bar meter only.

■ Display set mode (continued)

<p>Memory Name</p> <p>Sets the memory name indication, during memory mode operation, ON or OFF. (default: ON)</p>	<p>ON</p> <ul style="list-style-type: none"> • ON : The programmed memory name is displayed above the frequency indication. • OFF : No memory name is displayed even a memory name is programmed.
<p>APF-Width Popup (APF OFF→ON)</p> <p>Selects the pop-up display for the APF filter width from ON or OFF. (default: ON)</p>	<p>ON</p>
<p>MN-Q Popup (MN OFF→ON)</p> <p>Turns the pop-up indication capability when the notch filter width is changed from OFF to ON. (default: ON)</p>	<p>ON</p>
<p>Screen Saver Function</p> <p>Turns the screen saver function ON (15, 30 or 60 minutes) and OFF. (default: 60 min.)</p>	<p>60min</p> <p>The screen saver will acts when no operation is performed for the selected time period to protect the LCD from the “burn-in” effect.</p>
<p>Screen Saver Type</p> <p>Selects the screen saver type from “Bound,” “Rotation” and “Twist.” (default: Bound)</p>	<p>Bound</p> <p>The screen saver indication can be displayed for your reference while holding down [F-5•PREVIEW].</p>
<p>External Display</p> <p>Select “ON” when the external display is connected. (default: OFF)</p>	<p>OFF</p> <ul style="list-style-type: none"> • At least 800×600 pixel resolution is required for the display.
<p>External Display Sync Pulse</p> <p>Selects the suitable pulse level for the connected external display from H and L. (default: H)</p>	<p>H</p>
<p>Opening Message</p> <p>Turns the opening message screen indication capability ON or OFF. (default: ON)</p>	<p>ON</p>

■ Display set mode (continued)

My Call

Sets the introductory text, up to 10-character long, displayed in the opening screen.

Usually, you set your call sign for the opening screen.

Capital letters, small letters, numerals, some symbols (- / . @) and spaces can be used.

- 1 Push [F-5•EDIT] to select the name edit condition.
 - The cursor under the 1st character blinks.
- 2 Push [ABC], [abc], [123] or [Symbol] to select the character group, then rotate the main dial to select the character.
 - Push [ABC] or [abc] to toggle capital and small letters.
 - Push [123] or [Symbol] to toggle numerals and symbols.
 - Push [F-1•◀] or [F-2•▶] for cursor movement.
 - Push [F-3•DEL] to delete the selected character.
 - Push [F-4•SPACE] to input a space.
 - Pushing the transceiver's keypad, [0]–[9], can also enter numerals.
- 3 Push [EXIT/SET] to set the name.

Others set mode

Calibration Marker	OFF
<p>This item is used for a simple frequency check of the transceiver. (default: OFF) See page 13-5 for calibration procedure.</p> <p>NOTE: Turn the calibration marker OFF after checking the frequency of the transceiver.</p>	

Beep (Confirmation)	ON
<p>A beep sounds each time a switch is pushed to confirm it. This function can be turned OFF for silent operation. (default: ON)</p> <p>The beep output level can be set in level set mode. (p. 12-5)</p>	

Beep (Band Edge)	ON (Default)
<p>When you tune into or out of an amateur band's frequency range, a beep sounds. This functions independently of the confirmation beep setting.</p> <p>The beep output level can be set in level set mode. (p. 12-5)</p> <p>When "ON (User)" or "ON (User) & TX Limit" is selected, [BAND] appears in the display above the function switch (F-5). Up to 30 band edge frequencies can be programmed in the band edge screen. (see the page 3-14 for programming details.)</p>	
	<ul style="list-style-type: none"> • OFF : Band edge beep is OFF. • ON (Default) : When you tune into or out of the default amateur band's frequency range, a beep sounds. (default) • ON (User) : When you tune outside of, or back into a user programmed amateur band's frequency range, a beep sounds. • ON (User) & TX Limit : When you tune outside of, or back into a user programmed amateur band's frequency range, a beep sounds. Transmission is also inhibited outside the programmed band.

Beep Sound (MAIN)	1000Hz
<p>Sets the desired key-touch beep sound frequency during main readout operation within 500 to 2000 Hz in 10 Hz steps. (default: 1000 Hz)</p> <p>Set the different frequency from "Beep Sound (SUB)" as below to distinguish between main and sub.</p>	

Beep Sound (SUB)	1000Hz
<p>Sets the desired key-touch beep sound frequency during sub readout operation within 500 to 2000 Hz in 10 Hz steps. (default: 1000 Hz)</p> <p>Set the different frequency from "Beep Sound (MAIN)" as above to distinguish between main and sub.</p>	

■ Others set mode (continued)

TX Delay (HF)

OFF

Sets the transmission's timing for the HF bands. When an external device, such as a vacuum tube linear amplifier or a receiver preamplifier, is connected to the transceiver and you use the SEND line, a problem could possibly occur. If the device's transmit/receive switching time is slower than the time for the Icom transceiver, the device may not yet ready for a transmitted signal, and could be damaged by the transceiver's RF power.

If necessary to prevent damage to the external device, set an appropriate TX delay.

- OFF : The transmission delay is disabled. (default)
- 10 to 30ms: After transmit operation, the TX output is delayed for the set period of time (10, 15, 20, 25 or 30 milliseconds).

TX Delay (50M)

OFF

Sets the transmission's timing for the 50 MHz band.

See above TX Delay (HF) for more details.

Time-Out Timer (CI-V)

OFF

Turns the Time-Out Timer function ON (3, 5, 10, 20 or 30 minutes) or OFF. If a continuous transmission exceeds the selected time period, the transmission will be cut off, to prevent a prolonged transmission. (default: OFF)

NOTE: This function will be activated only when you transmit using CI-V commands, or pushing [TRANSMIT].

Quick Dualwatch

ON

When this item is set to ON, holding down [DUALWATCH] for 1 second sets the sub readout frequency to the main readout frequency and activates dual-watch operation. (default: ON)

See page 5-17 for details.

Quick SPLIT

ON

When this item is set to ON, holding down [SPLIT] for 1 second sets the sub readout frequency to the main readout frequency and activates split operation. (default: ON)

See page 6-7 for details.

FM SPLIT Offset(HF)

-0.100MHz

Sets the offset (difference between transmit and receive frequencies) for the quick split function. This setting is used for HF bands in FM mode only and is used to input the repeater offset for an HF band.

The offset frequency can be set from -9.999 MHz to +9.999 MHz in 1 kHz steps. (default: -0.100 MHz)

Others set mode (continued)

FM SPLIT Offset(50M)	-0.500MHz
<p>Sets the offset (difference between transmit and receive frequencies) for the quick split function. This setting is used for 50 MHz band FM mode only, and is used to input the repeater offset for the 50 MHz band.</p> <p>The offset frequency can be set from -9.999 MHz to +9.999 MHz in 1 kHz steps. (default: -0.500 MHz)</p>	

SPLIT LOCK	OFF
<p>When this item is ON, the main dial can be used to adjust the transmit frequency while pushing [XFC] even while the lock function is activated. (default: OFF)</p>	<p>See pages 6-6, 6-7 for split frequency operation details.</p>

Tuner (Auto Start)	OFF
<p>The internal antenna tuner has an automatic start capability which starts tuning if the SWR is higher than 1.5-3:1.</p>	<ul style="list-style-type: none"> • OFF : The tuner remains OFF even when the SWR is poor (1.5-3:1). (default) • ON : Automatic tune starts even when the tuner is turned OFF during HF bands operation.

Tuner (PTT Start)	OFF
<p>Tuning of the internal antenna tuner can be started automatically at the moment the PTT is pushed after the operating frequency is changed (more than 1% from last-tuned frequency). (default: OFF)</p>	

Transverter Function	Auto
<p>Selects the transverter operation condition from Auto and ON. (default: Auto)</p>	<ul style="list-style-type: none"> • ON : Turn the transverter operation ON. • Auto: The transceiver turns into transverter operation condition when 2 to 13.8 V DC is applied to [ACC2-A/B] pin 6.

Transverter Offset	16.000MHz (14.016.72 → 30.016.72)
<p>Sets the desired offset frequency for the transverter operation within 0.000 to 99.999 MHz in 1 kHz steps. (default: 16.000 MHz)</p>	

RTTY Mark Frequency	2125
<p>Selects the RTTY mark frequency. RTTY mark frequency is switched between 1275, 1615 and 2125 Hz. (default: 2125 Hz)</p> <p>2125 Hz is automatically selected when the internal RTTY decoder is used.</p>	

■ Others set mode (continued)

RTTY Shift Width 170

Selects the RTTY shift width. There are 3 selectable values: 170, 200 and 425 Hz. (default: 170 Hz)

170 Hz is automatically selected when the internal RTTY decoder is used.

RTTY Keying Polarity Normal

Selects the RTTY keying polarity. Normal or reverse keying polarity can be selected. (default: Normal)

When reverse polarity is selected, Mark and Space are reversed.

- Normal : Key open/close = Mark/Space
- Reverse : Key open/close = Space/Mark

PSK Tone Frequency 1500

Selects the desired PSK tone frequency for the PSK reception from 1000, 1500 and 2000 Hz. (default: 1500 Hz)

SPEECH Language English

Selects the speech language from English and Japanese. (default: English)

SPEECH Speed HIGH

Selects the speech speed from HIGH (faster) and LOW (slower). (default: HIGH)

SPEECH S-Level ON

The IC-7800 speech processor has frequency, mode and signal level announcement. Signal level announcement can be deactivated if desired. (default: ON)

When "OFF" is selected, the signal level is not announced.

SPEECH [MODE] Switch OFF

Selects the operating mode speech capability when a mode switch is pushed; ON or OFF. (default: OFF)

When "ON" is selected, the selected operating mode is announced when a mode switch is pushed.

Others set mode (continued)

Memopad Numbers	5
Sets the number of memo pad channels available. 5 or 10 memo pads can be set. (default: 5)	

MAIN DIAL Operation	MAIN/SUB
<p>Selects the main dial function from MAIN and MAIN/SUB. (default: MAIN/SUB)</p>	<ul style="list-style-type: none"> • MAIN : The main dial functions only when accessing to main readout. • MAIN/SUB : The main dial functions when accessing to main readout, as well as when accessing to sub readout with [SUB] switch operation.

MAIN DIAL Auto TS	HIGH
<p>Sets the auto tuning step function for the main dial. When rotating the main dial rapidly, the tuning step automatically changes several times as selected.</p> <p>There are 2 type of auto tuning steps: HIGH (Fastest) and LOW (Faster). (default: HIGH)</p>	<ul style="list-style-type: none"> • HIGH : Approximately 5 times faster when the tuning step is set to 1 kHz or smaller steps; approximately 2 times faster when the tuning step is set to 5 kHz or larger steps. (default) • LOW : Approximately 2 times faster. • OFF : Auto tuning step is turned OFF.

SUB DIAL Auto TS	HIGH
<p>Sets the auto tuning step function for the sub dial. When rotating the sub dial rapidly, the tuning step automatically changes several times as selected.</p> <p>There are 2 type of auto tuning steps: HIGH (Fastest) and LOW (Faster). (default: HIGH)</p>	<ul style="list-style-type: none"> • HIGH : Auto tuning step is turned ON. Fastest tuning step during rapid rotation. (default) • LOW : Auto tuning step is turned ON. Faster tuning step during rapid rotation. • OFF : Auto tuning step is turned OFF.

MIC Up/Down Speed	HIGH
<p>Sets the rate at which frequencies are scanned when the microphone [UP]/[DN] switches are held down. High or low can be selected.</p>	<ul style="list-style-type: none"> • HIGH : High speed (default; 50 tuning steps/second) • LOW : Low speed (25 tuning steps/second)

Quick RIT/ΔTX Clear	OFF
<p>Selects the RIT/ΔTX frequency clearing instruction with the [CLEAR] switch.</p>	<ul style="list-style-type: none"> • ON : Clears the RIT/ΔTX frequency when [CLEAR] is pushed momentarily. • OFF : Clears the RIT/ΔTX frequency when [CLEAR] is held down for 1 second. (default)

[NOTCH] Switch (SSB)	Auto/Manual
<p>Selects notch functions for SSB mode operation from Auto, Manual and Auto/Manual.</p>	<ul style="list-style-type: none"> • Auto : The auto notch can only be used. • Manual : The manual notch can only be used. • Auto/Manual : Both the auto and manual notch can be used. (default)

■ Others set mode (continued)

[NOTCH] Switch (AM)	Auto/Manual
Selects notch functions for AM mode operation from Auto, Manual and Auto/Manual.	<ul style="list-style-type: none"> • Auto : The auto notch can only be used. • Manual : The manual notch can only be used. • Auto/Manual : Both the auto and manual notch can be used. (default)

DIGI-SEL VR Operation	DIGI-SEL
Selects [DIGI-SEL] control function from DIGI-SEL and APF.	<ul style="list-style-type: none"> • DIGI-SEL : [DIGI-SEL] control functions as the digital selector operation. (default) • APF : [DIGI-SEL] control functions as the audio peak filter adjustment.

FILTER Screen MAIN/SUB Select	Auto (by FILTER,PBT Operation)
Selects filter set screen indication condition from Fix and Auto (by FILTER,PBT Operation).	<ul style="list-style-type: none"> • Fix : When filter screen accessed with the main band's [FILTER] switch, the screen shows main band's filter width and PBT conditions only; when filter set screen accessed with the sub band's [FILTER] switch, the screen shows sub band's filter width and PBT conditions only. • Auto (by FILTER,PBT Operation) : Filter set screen indication can be switched between main and sub bands filter width and PBT conditions when either band's [FILTER] switch or [TWIN PBT] control is operated. (default)

SSB/CW Synchronous Tuning	OFF
<p>Selects the displayed frequency shift function from ON or OFF. (default: OFF)</p> <p>When this function is activated, the receiving signal can be kept to receive even when the operating mode is changed between SSB and CW.</p> <p>/// The frequency shifting value may differ according to the CW pitch setting.</p>	<ul style="list-style-type: none"> • ON : The displayed frequency shifts when the operating mode is changed between SSB and CW. • OFF : The displayed frequency does not shift.

CW Normal Side	LSB
Selects the side band used to receive CW in CW normal mode. (default: LSB)	

APF Type	SOFT
Set audio filter shape for APF from SOFT and SHARP. (default: SOFT)	<ul style="list-style-type: none"> • SOFT : Soft filter shape makes distinguishing noise and signals easier. The audio filter width is related to the CW pitch setting. • SHARP : Sharp filter shape rejects interference signals. The audio filter width is fixed.

Others set mode (continued)

MIC AF Out	MAIN+SUB
<p>Selects the desired band(s) for audio output from [MIC] connector (pin 8) from MAIN+SUB and SUB. (default: MAIN+SUB)</p>	<ul style="list-style-type: none"> • MAIN+SUB: Outputs both main and sub bands audio. • SUB : Outputs sub band audio only.

External Keypad (VOICE)	OFF
<p>Sets the external keypad for voice memory transmission capability ON or OFF.</p> <p>See pages 2-6 and 2-10 for the equivalent circuit of an external keypad and connection.</p>	<ul style="list-style-type: none"> • ON : Pushing one of external keypad switches, transmits the desired voice memory contents during a phone mode operation. Holding down a switch to repeatedly transmit the desired memory contents. • OFF : External keypad does not function. (default)

External Keypad (KEYER)	OFF
<p>Sets the external keypad for keyer memory transmission capability ON or OFF.</p> <p>See pages 2-6 and 2-10 for the equivalent circuit of an external keypad and connection.</p>	<ul style="list-style-type: none"> • ON : Pushing one of external keypad switches momentarily, transmits the desired keyer memory contents once during CW mode operation. Holding down a switch to repeatedly transmit the desired memory contents. • OFF : External keypad does not function. (default)

External Keypad (RTTY)	OFF
<p>Sets the external keypad for RTTY memory transmission capability ON or OFF.</p> <p>NOTE: Only RTTY memory channels RT1, RT2, RT3 and RT4 can be transmitted using with the external keypad.</p> <p>See pages 2-6 and 2-10 for the equivalent circuit of an external keypad and connection details.</p>	<ul style="list-style-type: none"> • ON : In the RTTY mode and while the RTTY decode screen is active, pushing one of the external keypad switches transmits the desired RTTY memory contents. • OFF : External keypad does not function. (default)

External Keypad (PSK)	OFF
<p>Sets the external keypad for PSK memory transmission capability ON or OFF.</p> <p>NOTE: Only PSK memory channels PT1, PT2, PT3 and PT4 can be transmitted using with the external keypad.</p> <p>See pages 2-6 and 2-10 for the equivalent circuit of an external keypad and connection details.</p>	<ul style="list-style-type: none"> • ON : In the PSK mode and while the PSK decode screen is active, pushing one of the external keypad switches transmits the desired PSK memory contents. • OFF : External keypad does not function. (default)

Keyboard [F1]–[F4] (VOICE)	OFF
<p>Sets the voice message transmission capability ON or OFF when one of the [F1] to [F4] keys of the connected keyboard is pushed.</p>	<ul style="list-style-type: none"> • ON : Pushing one of the [F1] to [F4] keys transmits the desired voice message contents during phone mode operation. And while holding down the [SHIFT] key, push [F1] to [F4] keys to repeatedly transmit the desired memory contents. • OFF : [F1] to [F4] keys do not function. (default)

■ Others set mode (continued)

Keyboard [F1]–[F4] (KEYER)	OFF
Sets the keyer memory transmission capability ON or OFF when one of the [F1] to [F4] keys is pushed.	<ul style="list-style-type: none"> • ON : Pushing one of the [F1] to [F4] keys transmits the desired keyer memory contents during CW mode operation. And while holding down the [SHIFT] key, push [F1] to [F4] keys to repeatedly transmit the desired keyer memory contents. • OFF : [F1] to [F4] keys do not function. (default)

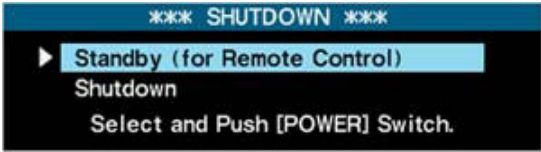
Shutdown Function	Shutdown
<p>Selects the shutdown option between Standby/Shutdown and Shutdown, for turning ON the transceiver by Remote stations.</p> <p style="text-align: right;">(default: Shutdown)</p> <p>When this item is set to “Standby/Shutdown:</p> <p>① Holding down [POWER] for 1 second displays the dialog box below.</p>  <p>② Push [POWER] to turn OFF the power with the Standby mode.</p> <ul style="list-style-type: none"> • If you want to select “Shutdown,” rotate the main dial or push [F-1•▲] or [F-2•▼], then push [POWER]. 	<p>Standby/Shutdown: You can turn ON the transceiver’s power using external equipment such as a PC with RS-BA1.</p> <p>Shutdown: Only the [POWER] switch turns ON the transceiver.</p> <div style="border: 1px solid gray; padding: 5px; margin-top: 10px;"> <p>NOTE while in the standby mode:</p> <ul style="list-style-type: none"> • The internal cooling fan is active, this is normal; not malfunction. • For the remote control, only the [LAN] port or [REMOTE] connector are active. Thus the [RS-232C] port is not accessible. </div>

CI-V Baud Rate	Auto
<p>Sets the CI-V data transfer rate. 300, 1200, 4800, 9600, 19200 bps and “Auto” are available. (default: Auto)</p> <p>When “Auto” is selected, the baud rate is automatically set according to the data rate of connected controller.</p>	

CI-V Address	6Ah
<p>To distinguish equipment, each CI-V transceiver has its own Icom standard address in hexadecimal code. The IC-7800’s address is 6Ah.</p> <p>When 2 or more IC-7800’s are connected to an optional CT-17 CI-V LEVEL CONVERTER, rotate the main dial to select a different address for each IC-7800; the range is 01h to DFh.</p>	

Others set mode (continued)

CI-V Transceive	ON
Transceive operation is possible with the IC-7800 connected to other Icom HF transceivers or receivers.	When "ON" is selected, changing the frequency or operating mode on the IC-7800 automatically changes those of connected transceivers (or receivers) and vice versa.

CI-V LAN→REMOTE Transceive Address	00h
Sets the CI-V address for sending the transceive data from [LAN] to [REMOTE] or [RS-232C]. The [REMOTE] or [RS-232C] connectors output the transceive data with this setting Address.	<p>/// Only when you configure the remote control system using an optional RS-BA1, you need this setting.</p> <p>The IC-PW1 can receive the transceive data from other than 00h, so you can still operate the IC-PW1 by operating RS-BA1. In that case you must reset the IC-PW1 and set the CI-V settings again. See the IC-PW1's instruction manual for details.</p>

CI-V Output (for ANT)	OFF
Enables to output the antenna controller status (frequency and so on) from the [REMOTE] jack.	<ul style="list-style-type: none"> • OFF : Turns OFF the function. (default) • ON : Outputs the status.

RS-232C Function	CI-V
Select [RS-232C] connector output data format from CI-V and Decode.	<ul style="list-style-type: none"> • CI-V : Outputs data in CI-V format. (default) • Decode : Outputs decoded contents in ASCII code format.

Decode Baud Rate	9600
Selects data transmission speed (Baud rate) when "Decode" is selected in "RS-232C Function" above; settings are 300, 1200, 4800, 9600 and 19200 bps. (default: 9600)	

Keyboard Type	English
Selects the connected keyboard type from English, Japanese, United Kingdom, French, French (Canadian), German, Portuguese, Portuguese (Brazilian), Spanish, Spanish (Latin American) and Italian. (default: English)	

Keyboard Repeat Delay	250ms
Sets the time period for delay within 100 to 1000 milliseconds. in 50 milliseconds. steps. (default: 250 milliseconds.)	When a key of the connected keyboard is pushed and held for the set period, the character is input continuously.

■ Others set mode (continued)

Keyboard Repeat Rate 10.9cps

Sets the repeating rate for the connected keyboard within 2.0 to 30.0 cps. (default: 10.9 cps)
*cps=character per second

When a key of the connected keyboard is held down, the character is repeatedly input with the set speed.

IP Address (Valid after Reboot) 192.168. 0. 10

Sets IP address for the IC-7800 when connecting to your PC or LAN (Local Area Network) through the Ethernet connector.

Turn the transceiver power OFF then ON to make the setting effective. See page 16-7 for details.

Subnet Mask (Valid after Reboot) 255.255.255. 0 (24bit)

Sets subnet mask for the IC-7800 when connecting to your PC or LAN (Local Area Network) through the Ethernet connector.

Turn the transceiver power OFF then ON to make the setting effective. See page 16-7 for details.

Default Gateway (Valid after Reboot) . . .

Sets the default gateway of the router that you want to connect the IC-7800 to.

Turn the transceiver power OFF then ON to make the setting effective.

/// Only when you configure the remote control system using an optional RS-BA1 through the Internet, you need this setting.

Network Control (Valid after Reboot) OFF

Selects the remote control capability ON or OFF. (default : OFF)

Turn the transceiver power OFF then ON to make the setting effective.

/// Only when you configure the remote control system using an optional RS-BA1, you need this setting.

Control Port (UDP) (Valid after Reboot) 50001

Sets the Control port of the IC-7800 by accessing from the remote station.

Turn the transceiver power OFF then ON to make the setting effective.

/// Only when you configure the remote control system using an optional RS-BA1, you need this setting.

Others set mode (continued)

Serial Port (UDP) (Valid after Reboot) 50002

Sets the Serial port of the IC-7800 by accessing from the remote station.

Only when you configure the remote control system using an optional RS-BA1, you need this setting.

Turn the transceiver power OFF then ON to make the setting effective.

Audio Port (UDP) (Valid after Reboot) 50003

Sets the Audio port of the IC-7800 by accessing from the remote station.

Only when you configure the remote control system using an optional RS-BA1, you need this setting.

Turn the transceiver power OFF then ON to make the setting effective.

Internet Access Line (Valid after Reboot) FTTH

Selects the your internet access line type.

Only when you configure the remote control system using an optional RS-BA1 through the Internet, you need this setting.

- FTTH : Fiber To The Home
- ADSL/CATV : ADSL or Cable television

Turn the transceiver power OFF then ON to make the setting effective.

Network User1 ID

Register the Users ID to allow them to remotely access the IC-7800. The IC-7800 can register three users to Network User1 ID to Network User3 ID.

Only when you configure the remote control system using an optional RS-BA1, you need this registration.

The IC-7800 verifies the User ID and password when Remote stations attempt to access the transceiver. If the User ID or password is incorrect, the Remote station cannot access the transceiver.

- 1 Push [F-5•EDIT] to enter the User ID Edit mode.
- 2 Rotate the main dial to input a User ID of up to 16 characters.
 - Push [ABC] or [abc] to toggle upper and lower case letters.
 - Push [123] or [Symbol] to toggle between numerals and symbols.
 - You cannot register the same ID with User2 or User3, if the ID is already registered.
 - Push [F-1•◀] or [F-2•▶] for cursor movement.
 - Push [F-3•DEL] to delete the selected character.
- 3 Push [F-5•SET] to set.

Password

Register the password for the Network User1 ID.

- 1 Push [F-5•EDIT] to enter the Password Edit mode.
- 2 Rotate the main dial to input a Password of 8 to 16 characters, case-sensitive.
 - At least two different characters must be used.
 - Push [ABC] or [abc] to toggle upper and lower case letters.
 - Push [123] or [Symbol] to toggle between numerals and symbols.
 - Push [F-1•◀] or [F-2•▶] for cursor movement.
 - Push [F-3•DEL] to delete the selected character.
- 3 Push [F-5•SET] to set.

■ Others set mode (continued)

Administrator	NO
Selects the administrator setting YES or NO for Network User1 ID. (default: NO)	When this item is set to "YES," the Remote station can terminate a connection between another Remote station and the IC-7800.

Network User2 ID	
Register the Users ID to allow them to remotely access the IC-7800. The IC-7800 can register three users to Network User1 ID to Network User3 ID.  Only when you configure the remote control system using an optional RS-BA1, you need this registration.	See the Network User1 ID on the previous page for setting details. <ul style="list-style-type: none"> You cannot register the same ID with User1 or User3, if the ID is already registered.

Password	
Register the password for the Network User2 ID.	See the Password of Network User1 ID on the previous page for setting details.

Administrator	NO
Selects the administrator setting YES or NO for Network User2 ID. (default: NO)	When this item is set to "YES," the Remote station can terminate a connection between another Remote station and the IC-7800.

Network User3 ID	
Register the Users ID to allow them to remotely access the IC-7800. The IC-7800 can register three users to Network User1 ID to Network User3 ID.  Only when you configure the remote control system using an optional RS-BA1, you need this registration.	See the Network User1 ID on the previous page for setting details. <ul style="list-style-type: none"> You cannot register the same ID with User1 or User2, if the ID is already registered.

Password	
Register the password for the Network User3 ID.	See the Password of Network User1 ID on the previous page for setting details.

Administrator	NO
Selects the administrator setting YES or NO for Network User3 ID. (default: NO)	When this item is set to "YES," the Remote station can terminate a connection between another Remote station and the IC-7800.

Others set mode (continued)

Network Radio Name	IC-7800
<p>Enters the Network Radio name of up to 16 characters. The name displays on an RS-BA1's Remote Utility. DO NOT use the duplicated name on your network.</p> <p> Only when you configure the remote control system using an optional RS-BA1, you need this registration.</p>	<ol style="list-style-type: none"> 1 Push [F-5•EDIT] to enter the Network Radio Name Edit mode. 2 Rotate the main dial to input a Network Radio Name of up to 16 characters. <ul style="list-style-type: none"> • Push [ABC] or [abc] to toggle upper and lower case letters. • Push [123] or [Symbol] to toggle between numerals and symbols. • Push [F-1•◀] or [F-2•▶] for cursor movement. • Push [F-3•DEL] to delete the selected character. 3 Push [F-5•SET] to set.

Network AF Sample Rates	8kHz, 12kHz, 16kHz
<p>Selects the limitation of the received audio sampling rate that Remote stations can adjust. 8 kHz, 12 kHz, 16 kHz, 24 kHz and 48 kHz are selectable. (default: 16 kHz)</p>	<p>Higher sampling rates will improve the audio quality. However, they also increase the amount of data, which can cause voice delay or jumpiness, depending on the network condition. Lower sampling rates will decrease the audio quality. However, they also decrease the amount of data.</p>

Codecs	LPCM 8bit, u-law 8bit, LPCM 16bit
<p>Sets the received audio codecs that Remote stations can adjust.</p>	<p>LPCM 8 bit, u-law 8 bit and LPCM 16 bit are selectable. (default: LPCM 8bit, u-law 8bit, LPCM 16bit)</p>

Channels	1ch
<p>Selects whether or not to allow Remote stations to select stereo sound. (default : 1ch)</p>	<p>When you select "1ch" (monaural), Remote stations cannot program "2ch" (stereo). If the Remote station selects "2ch," stereo output (L=Main band; R=Sub band).</p>

Network MOD Use	ON
<p>Selects whether or not to allow Remote stations to send the modulation audio. (default : ON)</p>	<ul style="list-style-type: none"> • ON: The Remote stations send the modulation audio. • OFF: The Remote stations do not send the modulation audio.

Sample Rates	8kHz
<p>Selects the limitation of the modulation audio sampling rate that Remote stations can adjust. 8 kHz, 12 kHz, 16 kHz, 24 kHz and 48 kHz are selectable. (default: 8 kHz)</p>	<p>Higher sampling rates will improve the audio quality. However, they also increase the amount of data, which can cause voice delay or jumpiness, depending on the network condition. Lower sampling rates will decrease the audio quality. However, they also decrease the amount of data.</p>

Codecs	LPCM 8bit, u-law 8bit, LPCM 16bit
<p>Sets the transmit audio codecs that Remote stations can select.</p>	<p>LPCM 8 bit, u-law 8 bit and LPCM 16 bit are selectable. (default: LPCM 8bit, u-law 8bit, LPCM 16bit)</p>

CF/USB-MEMORY set menu

CF/USB-MEMORY set screen arrangement

CF/USB-Memory set menu

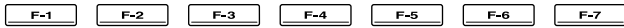
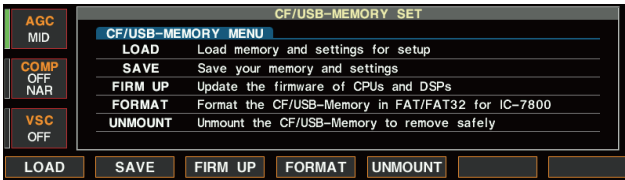

Firmware update (p. 16-4)

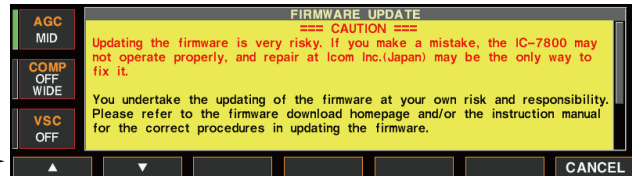

Setting load screen (p. 12-31)

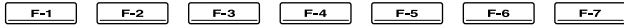
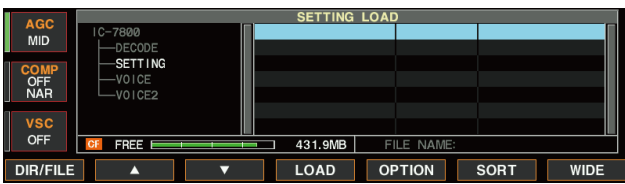

Format screen (p. 12-33)

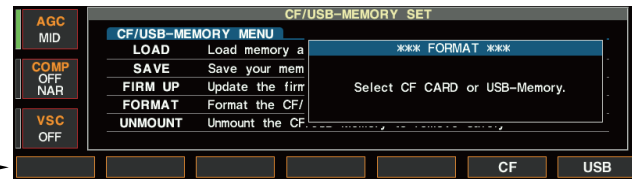

Load option set mode (p. 12-29)

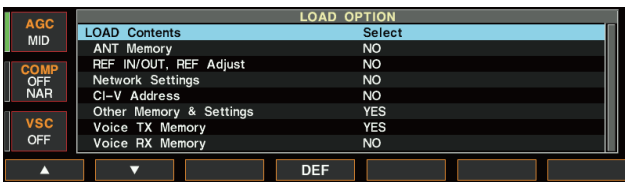

Unmount screen (p. 12-34)

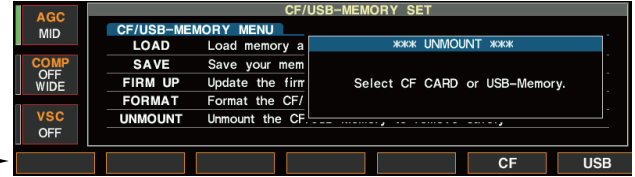

Setting save screen (p. 12-30)

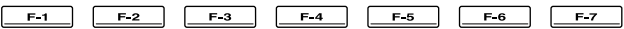
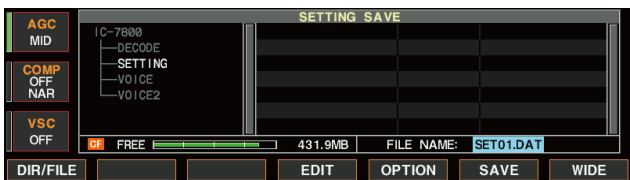

Save option set mode (p. 12-28)

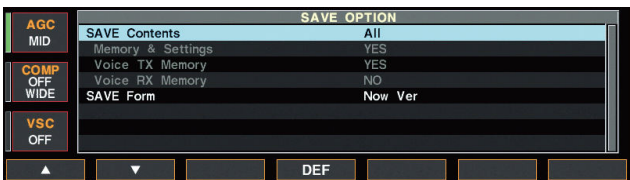

◇ Save option set mode

SAVE Contents	All
Selects file saving condition from All and Select. (default: All)	<ul style="list-style-type: none"> • All : Saves all the following contents. • Select : Saves the selected contents only.

Memory & Settings	YES
Selects memory channel contents and other settings saving condition from YES and NO. (default: YES)	<ul style="list-style-type: none"> • YES : Saves memory channel contents and settings of miscellaneous (Other) set mode. • NO : Does not save.

Voice TX Memory	YES
Selects the voice TX memory saving condition from YES and NO. (default: YES)	<ul style="list-style-type: none"> • YES : Saves the voice TX memory. • NO : Does not save.

Voice RX Memory	NO
Selects the voice RX memory saving condition from YES and NO. (default: NO)	<ul style="list-style-type: none"> • YES : Saves the voice RX memory. • NO : Does not save.

SAVE Form	Now Ver
Selects file saving format from Now Ver and Old Ver. (default: Now Ver) Additional selections are available for Old Ver and indicated in brackets.	<ul style="list-style-type: none"> • Now Ver : Saves the file in the current firmware version format being used. • Old Ver : Saves the file in the firmware version format that is indicated in brackets.
<p>For your information: The current IC-7800 firmware version number can be confirmed when turning the power ON and is displayed in the bottom right corner of the function display, as shown below.</p>  <p>Firmware version number is displayed here →</p>	<p>NOTE: You cannot write the setting file that is saved in the current version format to an older firmware version IC-7800.</p>

◇ Load option set mode

Load Contents	Select
Selects file loading condition from All and Select. (default: Select)	<ul style="list-style-type: none"> • All : Loads and sets the all following contents. • Select : Loads and sets the selected contents only.
ANT Memory	NO
Selects the antenna memory setting loading condition YES and NO. (default: NO).	<ul style="list-style-type: none"> • YES : Loads and sets the antenna memory. • NO : Use the original antenna memory setting.
REF IN/OUT, REF Adjust	NO
Selects the reference signal setting loading condition YES and NO. (default: NO).	<ul style="list-style-type: none"> • YES : Loads and sets the reference signal setting. • NO : Use the original reference signal setting.
Network Settings	NO
Selects the Network settings loading condition YES and NO. (default: NO).	<ul style="list-style-type: none"> • YES : Loads and sets the Network settings. • NO : Use the original Network settings.
CI-V Address	NO
Selects the CI-V address setting loading condition YES and NO. (default: NO).	<ul style="list-style-type: none"> • YES : Loads and sets the CI-V address setting. • NO : Use the original CI-V address setting.
Other Memory & Settings	YES
Selects memory channel contents and other settings loading condition YES and NO. (default: YES).	<ul style="list-style-type: none"> • YES : Loads and sets memory channel contents and other settings. • NO : Use the original memory channel contents and other settings.
Voice TX Memory	YES
Selects the voice TX memory loading condition YES and NO. (default: YES).	<ul style="list-style-type: none"> • YES : Loads and sets the voice TX memory. • NO : Use the original the voice TX memory.
Voice RX Memory	NO
Selects the voice RX memory loading condition YES and NO. (default: NO).	<ul style="list-style-type: none"> • YES : Loads and sets the voice RX memory. • NO : Use the original the voice RX memory.

■ File saving

[F-4•EDIT] [F-5•OPTION] [F-7•WIDE]/[F-7•CANCEL]

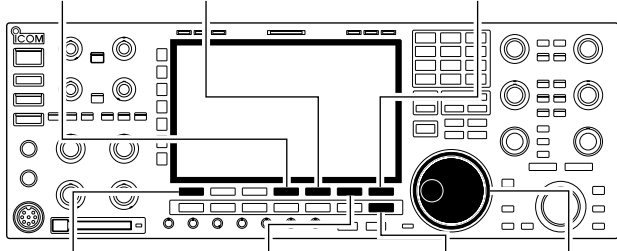

[F-1•DIR/FILE] [F-6•SAVE]/[F-6•OK] [EXIT/SET] Main dial

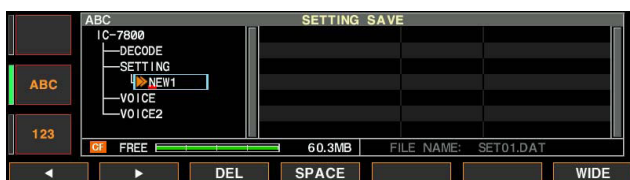
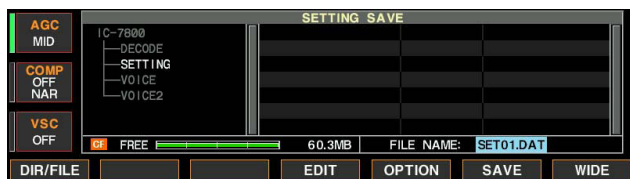
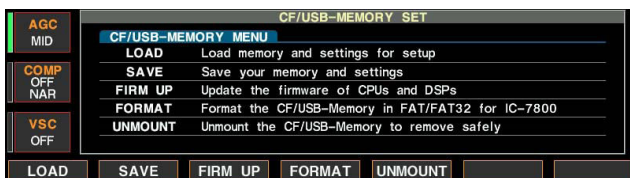

Memory channel contents, set mode settings, etc. can be saved into the CF (Compact Flash) memory card or USB flash drive for backup.

- ① During set mode menu indication, push [F-7•CF/USB] to select CF/USB-Memory set menu.
- ② Push [F-2•SAVE] to select setting save screen.
- ③ Change the following conditions if desired.

• File name:

- ① Push [F-4•EDIT] to select file name edit condition.
 - Push [F-1• DIR/FILE] several times to select the file name, if necessary.
- ② Push [ABC], [123] or [Symbol] to select the character group, then rotate the main dial to select the character.
 - [ABC] : A to Z (capital letters); [123]: 0 to 9 (numerals); [Symbol]: ! # \$ % & ' ` ^ + - = () [] { } _ ~ @ can be selected.
 - Push [F-1•◀] to move the cursor left, push [F-2•▶] to move the cursor right, push [F-3•DEL] to delete a character and push [F-4•SPACE] to insert a space.
- ③ Push [EXIT/SET] to set the file name.

• Save option

- ① Push [F-5•OPTION] to enter save option set mode.
- ② Push [F-1•▲] or [F-2•▼] to select the item, then rotate the main dial to select the desired setting. (see page 12-28 for details)
 - Hold down [F-4•DEF] for 1 second to select the default setting.
- ③ Push [EXIT/SET] to return to the previous indication.

• Saving location

- ① Hold down [F-1•DIR/FILE] for 1 second to select the memory device.
- ② Push [F-1•DIR/FILE] to select tree view screen.
- ③ Select the desired directory or folder in the memory device.
 - Push [F-4•◀ ▶] to select the upper directory.
 - Push [F-2•▲] or [F-3•▼] to select folder in the same directory.
 - Hold down [F-4•◀ ▶] for 1 second to select a folder in the directory.
 - Push [F-5•REN/DEL] to rename the folder.
 - Hold down [F-5•REN/DEL] for 1 second to delete the folder.
 - Hold down [F-6•MAKE] for 1 second to making a new folder. (Edit the name with the same manner as the “• File name” above.)
- ④ Push [F-1•DIR/FILE] twice to select the file name.

- ④ Push [F-6•SAVE].
 - Confirmation screen appears.
- ⑤ Push [F-6•OK] to save.
 - After saving is completed, automatically returns to the CF/USB-Memory set menu screen.

■ File loading

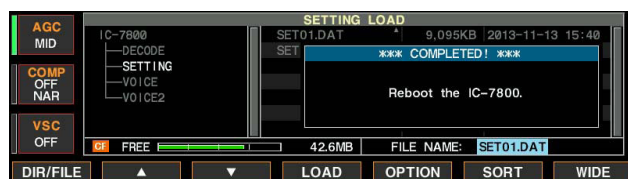
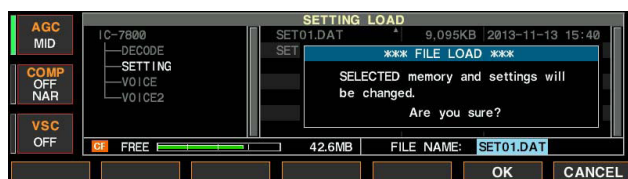
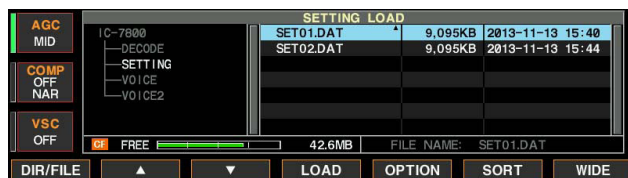
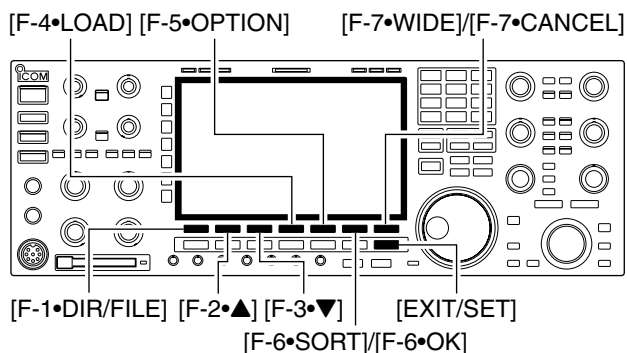

By loading the saved setting file from the memory device, you can easily set up another IC-7800— several operators settings can easily be applied to one IC-7800.

- ① During set mode menu indication, push [F-7•CF/USB] to select CF/USB-Memory set menu screen.
- ② Push [F-1•LOAD] to select setting load screen.
- ③ Hold down [F-1•DIR/FILE] for 1 second to select the CF memory card or USB flash drive, if necessary.
 - Either the “CF” or “USB” indicator blinks.
 - After the memory contents are displayed, the indicator stops blinking.
- ④ Push [F-5•OPTION] to select load option set mode, then set the desired loading conditions, if desired.
 - See page 12-29 for details.
- ⑤ Push [F-2•▲] or [F-3•▼] to select the desired setting file.
- ⑥ Push [F-4•LOAD].
 - The Confirmation window appears.
- ⑦ Push [F-6•OK] to starts loading.
 - After the loading is completed, the message dialog, “Reboot the IC-7800,” appears.
- ⑧ Turn the transceiver power OFF then ON to make the setting effective.

■ Changing the file name

[F-4•◀▶] [F-5•REN/DEL] [F-7•WIDE]/[F-7•CANCEL]

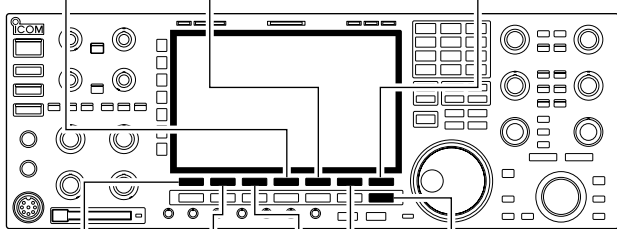

[F-1•DIR/FILE] [F-2•▲] [F-3•▼] [EXIT/SET]
[F-6•MAKE]

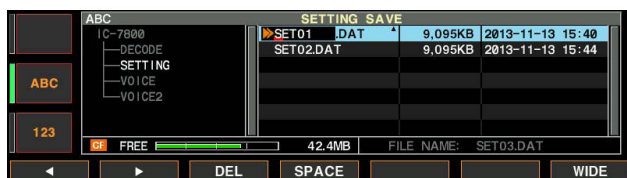
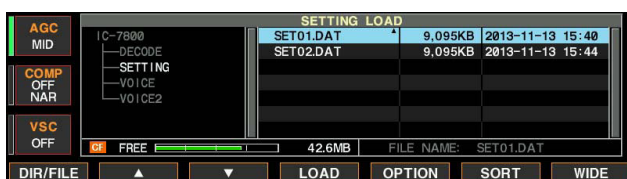

The file name, saved in the memory device, can be re-named from the transceiver as desired.

- ① During setting save screen display, hold down [F-1•DIR/FILE] to select the memory device.
- ② Push [F-1•DIR/FILE] to select tree view screen.
 - Push [F-2•▲] or [F-3•▼] to select the desired folder.
 - “DECODE,” “SETTING” and “VOICE” folders are available as the default.
 - After the folder is selected, hold down [F-2•◀▶] for 1 second to display content folder(s), if available.
- ③ Push [F-1•DIR/FILE] to select file list screen.
- ④ Push [F-2•▲] or [F-3•▼] to select the desired file.
- ⑤ Push [F-5•REN/DEL] momentarily to select the file name edit condition.
- ⑥ Push [ABC], [123] or [Symbol] to select the character group, then rotate the main dial to select the character.
 - [ABC] : A to Z (capital letters); [123]: 0 to 9 (numerals); [Symbol]: ! # \$ % & ' ` ^ + - = () [] { } _ ~ @ can be selected.
 - Push [F-1•◀] to move the cursor left, push [F-2•▶] to move the cursor right, push [F-3•DEL] to delete a character and push [F-4•SPACE] to insert a space.
 - Pushing the transceiver’s keypad, [0]–[9], can also enter numerals.
- ⑦ Push [EXIT/SET] to set the file name.

■ Deleting a file

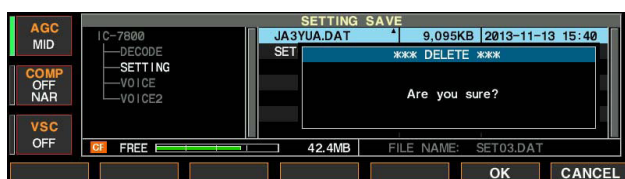
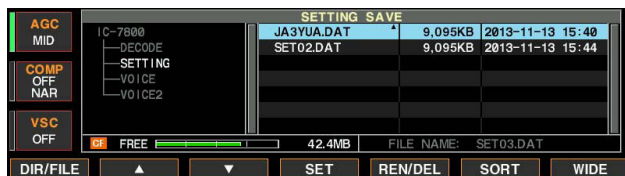

RECOMMENDATION! Deleting the setting file is irreversible. Confirm the contents before deleting a setting file!

- ① During setting save screen display, hold down [F-1•DIR/FILE] to select the memory device.
- ② Push [F-1•DIR/FILE] to select tree view screen.
 - Push [F-2•▲] or [F-3•▼] to select the desired folder.
 - “DECODE,” “SETTING” and “VOICE” folders are available as the default.
 - After the folder is selected, hold down [F-2•◀▶] for 1 second to display content folder(s), if available.
- ③ Push [F-1•DIR/FILE] to select file list screen.
- ④ Push [F-2•▲] or [F-3•▼] to select the desired file to be deleted.
- ⑤ Hold down [F-5•REN/DEL] for 1 second.
 - Confirmation screen appears.
- ⑥ Push [F-6•OK] to delete.
 - After the deleting, return to setting save screen automatically.

■ Formatting the memory device

A saved data in the memory device can be erased.

IMPORTANT! Formatting erases all saved data in the memory device. Making a backup file on your PC is recommended.

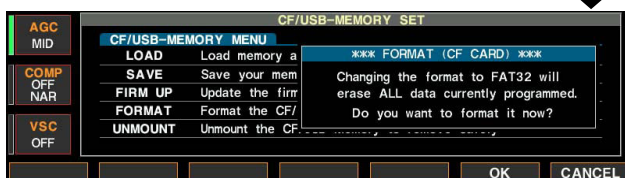
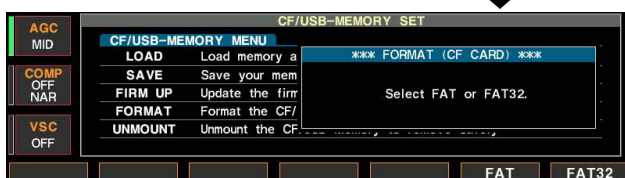
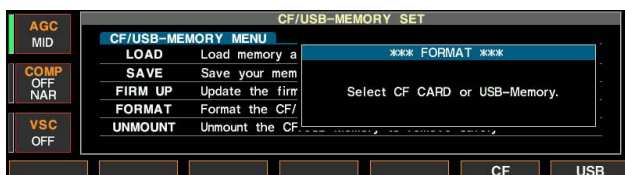

- ① During CF/USB-Memory set menu screen, hold down [F-4•FORMAT] for 1 second.
- ② Push [F-6•CF] or [F-7•USB] to select the memory device.
- ③ Push [F-6•FAT] or [F-7•FAT32] to select the format type.
 - Confirmation screen appears.
- ④ Push [F-6•OK] to format.
 - Push [F-7•CANCEL] to cancel.
- ⑤ Automatically returns to the CF/USB-Memory set menu screen.

■ Unmounting the memory device

CAUTION:

When removing the memory device, unmount operation is recommended. If you do not unmount the memory in this case, data in the memory device may be corrupted.

- ① During CF/USB-Memory set menu screen, hold down [F-6•UNMOUNT] for 1 second.
- ② Push [F-6•CF] or [F-7•USB] to select the memory device.
 - Confirmation screen appears.
- ③ Push [F-6•OK] to unmount the memory device.
 - Push [F-7•CANCEL] to cancel.
- ④ Automatically returns to the CF/USB-Memory set menu screen. Then remove the memory device.

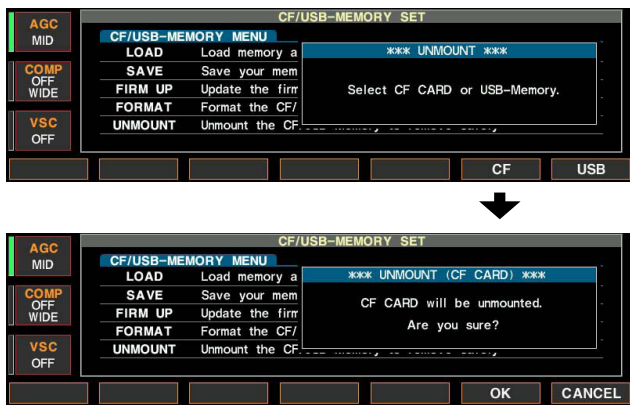

■ Troubleshooting	13-2
◇ Transceiver power	13-2
◇ Transmit and receive	13-2
◇ Scanning	13-3
◇ Display	13-3
■ Main dial brake adjustment	13-3
■ Voice synthesizer operation	13-3
■ SWR reading	13-4
■ Screen type and font selections	13-4
■ Frequency calibration (approximate)	13-5
■ Opening the transceiver's case	13-6
■ Clock backup battery replacement	13-6
■ Fuse replacement	13-7
■ Resetting the CPU	13-7
■ About protection indications	13-8
■ Screen Saver Function	13-8

■ Troubleshooting

The following chart is designed to help you correct problems which are not equipment malfunctions. If you are unable to locate the cause of a problem or solve it through the use of this chart, contact your nearest Icom Dealer or Service Center.

◇ Transceiver power

PROBLEM	POSSIBLE CAUSE	SOLUTION	REF.
Power does not come on when the [POWER] switch is pushed.	<ul style="list-style-type: none"> • Power cable is improperly connected. • The internal power supply is turned OFF. • Circuit breaker is tripped. 	<ul style="list-style-type: none"> • Re-connect the AC power cable correctly. • Turn the internal power supply ON. • Check for the cause, then re-set the circuit breaker. 	<p>p. 2-4 p. 3-2 —</p>

◇ Transmit and receive

PROBLEM	POSSIBLE CAUSE	SOLUTION	REF.
No sounds come out from the speaker.	<ul style="list-style-type: none"> • Volume level is too low. • The squelch is closed. • The transceiver is in transmitting condition. 	<ul style="list-style-type: none"> • Rotate [AF] clockwise to obtain a suitable listening level. • Turn [SQL] to 10 o'clock position to open the squelch. • Push [TRANSMIT] to receive or check the SEND line of an external unit, if connected. 	<p>p. 3-9 p. 3-9 p. 3-12</p>
Sensitivity is too low, and only strong signals are audible.	<ul style="list-style-type: none"> • The antenna is not connected properly. • The antenna for another band is selected. • The antenna is not properly tuned. • The attenuator is activated. 	<ul style="list-style-type: none"> • Re-connect to the antenna connector. • Select an antenna suitable for the operating frequency. • Hold down [TUNER] for 1 second to manually tune the antenna. • Push [ATT] several times to select "ATT OFF." 	<p>— p. 10-2 p. 10-5 p. 5-10</p>
Received audio is unclear or distorted.	<ul style="list-style-type: none"> • Wrong operating mode is selected. • PBT function is activated. • Noise blanker is turned ON when receiving a strong signal. • Preamp is activated. • The noise reduction is activated and the [NR] control is too far clockwise. 	<ul style="list-style-type: none"> • Select a suitable operating mode. • Hold down [PBT CLR] for 1 second to reset the function. • Push [NB] to turn the noise blanker OFF. • Push [P.AMP] once or twice to turn the function OFF. • Set the [NR] control for maximum readability. 	<p>p. 3-8 p. 5-13 p. 5-18 p. 5-10 p. 5-19</p>
The [ANT] switch does not function	<ul style="list-style-type: none"> • The antenna switch has not been activated. 	<ul style="list-style-type: none"> • Set the antenna switch in set mode to "Auto" or "Manual." 	<p>p. 10-4</p>
Transmitting is impossible.	<ul style="list-style-type: none"> • The operating frequency is not inside a ham band. 	<ul style="list-style-type: none"> • Set the frequency to be in a ham band. 	<p>p. 3-5</p>
Output power is too low.	<ul style="list-style-type: none"> • [RF PWR] is set too far counterclockwise • [DRIVE] is set too far counterclockwise • [MIC] is set too far counterclockwise • The antenna for another band is selected. • The antenna is not properly tuned. 	<ul style="list-style-type: none"> • Rotate [RF PWR] clockwise. • Set [DRIVE] to a suitable position. • Set [MIC] to a suitable position. • Select an antenna suitable for the operating frequency. • Hold down [TUNER] for 1 second to manually tune the antenna. 	<p>p. 3-12 p. 3-13 p. 3-12 p. 10-2 p. 10-5</p>
No contact possible with another station.	<ul style="list-style-type: none"> • RIT or ΔTX function is activated. • Split frequency function and/or dualwatch are activated. 	<ul style="list-style-type: none"> • Push [RIT] or [ΔTX] to turn the function OFF. • Push [SPLIT] and/or [DUALWATCH] to turn the function OFF. 	<p>pp. 5-11, 6-4 pp. 5-17, 6-4</p>
Transmit signal is unclear or distorted.	<ul style="list-style-type: none"> • [MIC] is set too far clockwise 	<ul style="list-style-type: none"> • Set [MIC] to a suitable position. 	<p>p. 3-12</p>
Repeater cannot be accessed.	<ul style="list-style-type: none"> • Split frequency function is not activated. • Programmed subaudible tone frequency is wrong. 	<ul style="list-style-type: none"> • Push [SPLIT] to turn the function ON • Reset the frequency using set mode. 	<p>p. 6-6 p. 4-32</p>

◇ Scanning

PROBLEM	POSSIBLE CAUSE	SOLUTION	REF.
Programmed scan does not stop.	• Squelch is open.	• Set [SQL] to the threshold point.	p. 3-9
Programmed scan does not start.	• The same frequencies have been programmed in scan edge memory channels P1 and P2.	• Program different frequencies in scan edge memory channel P1 and P2.	p. 8-4
Memory scan does not start	• 2 or more memory channels have not been programmed.	• Program more than 2 memory channels.	p. 8-4
Select memory scan does not start	• 2 or more memory channels have not been designated as select channels.	• Designate more than 2 memory channels as select channels for the scan.	p. 9-7

◇ Display

PROBLEM	POSSIBLE CAUSE	SOLUTION	REF.
The displayed frequency does not change properly.	• The dial lock function is activated. • A set mode screen is selected. • The internal CPU has malfunctioned.	• Push [LOCK] to turn the function OFF. • Push [EXIT/SET] several times to exit the set mode screen. • Reset the CPU.	p. 5-19 p. 12-2 p. 13-7

■ Main dial brake adjustment

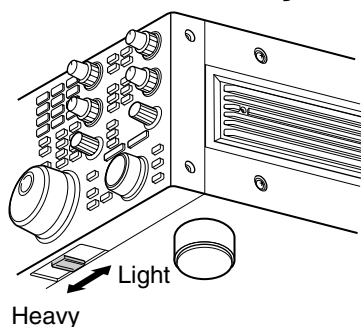

The tension of the main dial may be adjusted to suit your preference.

The brake adjustment is located on the bottom side of the front panel. See the figure at left.

Slide the brake adjustment to comfortable tension level while turning the dial continuously and evenly in one direction.

■ Voice synthesizer operation

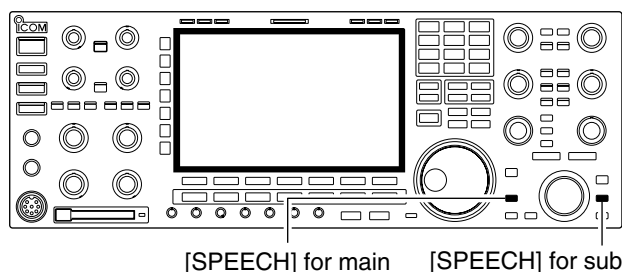

The IC-7800 has built-in voice synthesizer to announce the frequency, mode, etc. (S-meter level can also be announced—p. 12-17) in clear, electronically-generated voice, in English (or Japanese).

- ➔ Push [SPEECH] to announce the currently selected frequency, etc.
 - Hold down [SPEECH] for 1 second to additionally announce the selected mode.

- ➔ Pushing a mode switch also announces the appropriate mode. (p. 12-17)

▨ The output level of the voice synthesizer can be adjusted in level set mode. (p. 12-5)

SWR reading

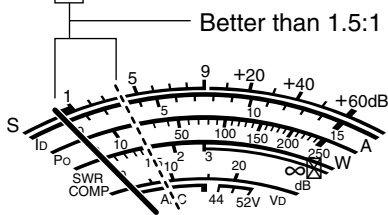
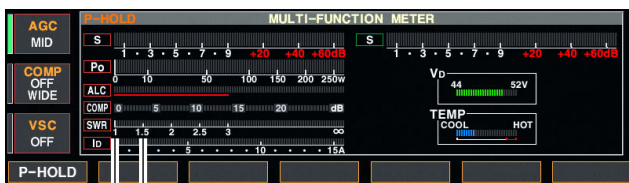
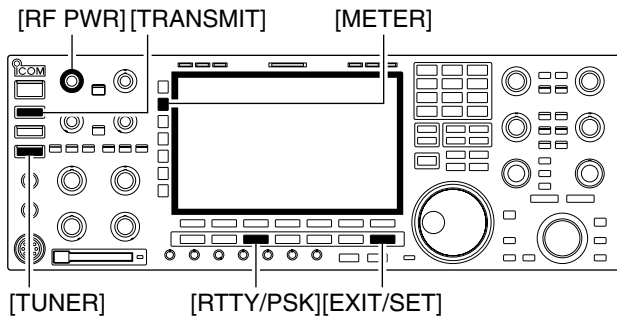

The SWR meter indicates the SWR over the transmission line in all modes.

- ① Push [TUNER] to turn the antenna tuner OFF.
- ② Hold down [METER] for 1 second to display multi-function meter.
- ③ Push [RTTY/PSK] once or twice to select RTTY mode.
- ④ Push [TRANSMIT].
- ⑤ Rotate [RF PWR] clockwise past the 12 o'clock position for more than 30 W output power.
- ⑥ Read the SWR on the SWR meter gage.
- ⑦ Push [EXIT/SET] to close multi-function meter.

⚡ The built-in antenna tuner matches the transmitter to the antenna when the SWR is lower than 3 : 1.

Screen type and font selections

• Screen image example— type C



3 types of screen images and 18 types of frequency readout indication fonts are available in the IC-7800.

- ① Push [EXIT/SET] several times to close multi-function screen, if necessary.
- ② Push [F-7•SET] to select set mode menu screen.
- ③ Push [F-3•DISP] to enter display set mode.
- ④ Push [F-1•▲] or [F-2•▼] to select “Display Type” item when selecting the screen image, select “Display Font” when selecting the frequency readout indication font.
- ⑤ Rotate the main dial to select the desired screen image or font.
 - Screen image is selectable from A, B and C.
 - Italic (1)/(2)/(3)/(4), Round (1)/(2)/(3), Shadow (1)/(2)/(3), Qubic (1)/(2)/(3)/(4) and IC-780 (1)/(2)/(3)/(4) are available for the frequency readout font.
- ⑥ Push [EXIT/SET] twice to exit from display set mode.

■ Frequency calibration (approximate)

A very accurate frequency counter is required to calibrate the frequency of the transceiver. However, a rough check may be performed by receiving radio station WWV, WWVH, or other standard frequency signals.

CAUTION: The IC-7800 has been thoroughly adjusted and tested at the factory before being shipped. You should not have to re-calibrate it.

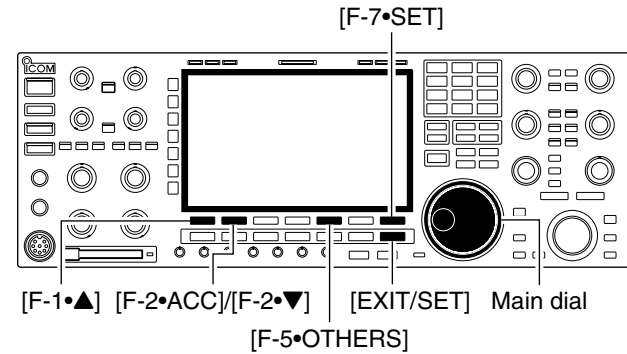

• Calibration marker item

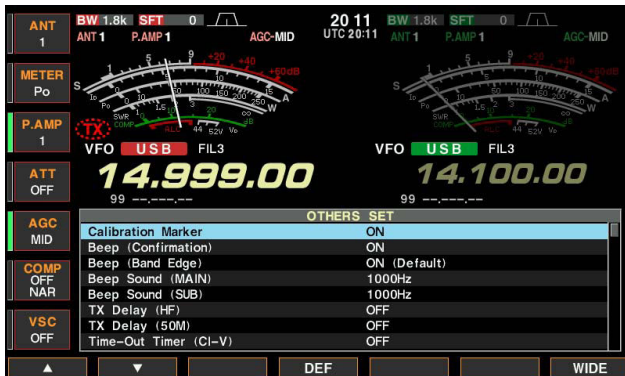

• REF Adjust item

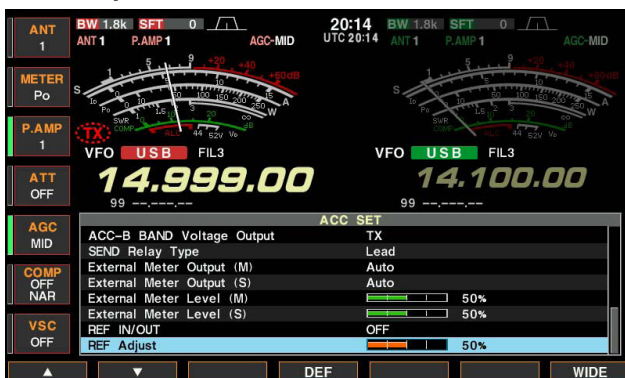

- ① Push [SSB] to select USB mode.
- ② Hold down [PBT CLEAR] for 1 second to clear the PBT setting and make sure that the RIT/ Δ TX function is not activated.
- ③ Set the frequency to the standard frequency station minus 1 kHz.
 - When receiving WWV or WWVH (at 15.00000 MHz) as a standard frequency, set the operating frequency for 14.99900 MHz.
 - Other standard frequencies can be used.
- ④ Push [EXIT/SET] several times to close a multi-function screen, if necessary.
- ⑤ Push [F-7•SET] to select set mode menu screen.
- ⑥ Push [F-5•OTHERS] to enter the Others set mode.
- ⑦ Push [F-1•▲] several times to select the “Calibration Marker” item.
- ⑧ Rotate the main dial clockwise to turn the calibration marker ON.
- ⑨ Push [EXIT/SET] once to return to set mode menu screen.
- ⑩ Push [F-2•ACC] to enter accessory set mode.
- ⑪ Push [F-2•▼] several times to select the “REF Adjust” item.
- ⑫ Rotate the main dial to adjust for a zero beat with the received standard signal as shown at left.
 - Zero beat means that two signals are exactly the same frequency, resulting in a single tone being emitted.
- ⑬ Turn the calibration marker OFF in the Others set mode.
- ⑭ Push [EXIT/SET] twice to exit set mode.

■ Opening the transceiver's case

Follow the case opening procedures shown here when you want to replace the clock backup battery or internal fuse.

⚠ WARNING! DISCONNECT the AC power cable from the transceiver before performing any work on the transceiver. Otherwise, there is danger of electric shock and/or equipment damage.

CAUTION: The transceiver weighs approximately 25 kg (55 lb). Always have two people available to lift or invert over the transceiver.

- ① Remove the 8 screws from the top of the transceiver and the 6 screws from the sides, then lift up the top cover.
- ② Turn the transceiver upside-down.

CAUTION: NEVER HOLD THE MAIN DIAL OR ANY OTHER KNOBS when the transceiver is upside down. This may damage the transceiver.

- ③ Remove 7 screws from the bottom, and the 6 screws from the sides, then lift up the bottom cover.

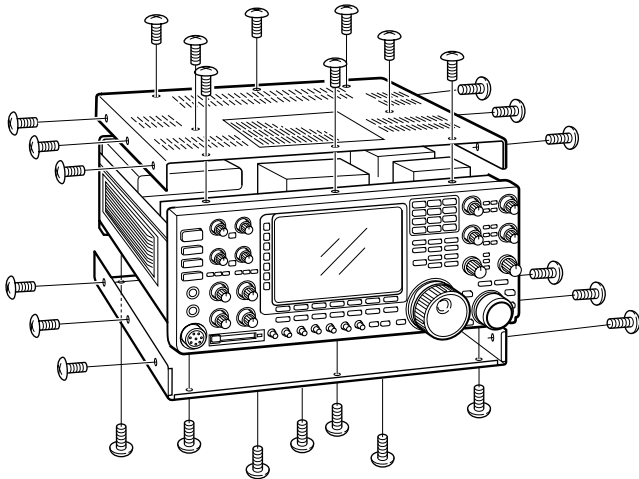

■ Clock backup battery replacement

The IC-7800 has a lithium backup battery (CR2032) inside for clock and timer functions. The usual life of the backup battery is approximately 2 years.

When the backup battery exhausted, the transceiver transmits and receives normally but cannot retain the current time.

⚠ WARNING! DISCONNECT the AC power cable from the AC outlet before removing the transceiver's cover.

- ① Remove the top cover as shown above.
- ② Replace the clock backup battery, located on the front panel as illustrated at left.
 - Make sure the battery polarity is correct.
- ③ Return the top cover to the original position.
- ④ Set the date and time in time set mode. (p. 11-2)

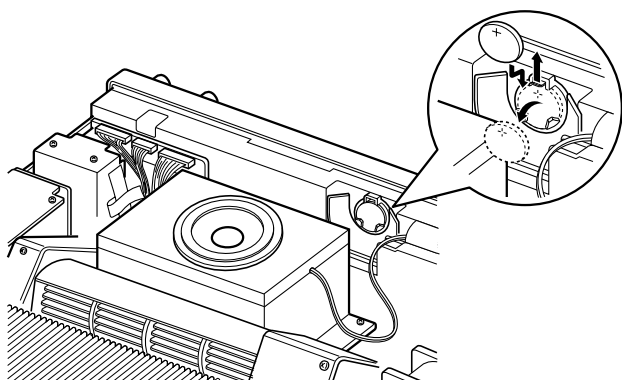

For Users in California (U.S.A.)

This CR2032 Lithium Battery contains Perchlorate Material—special handling may apply.

See <http://www.dtsc.ca.gov/hazardouswaste/perchlorate>

■ Fuse replacement

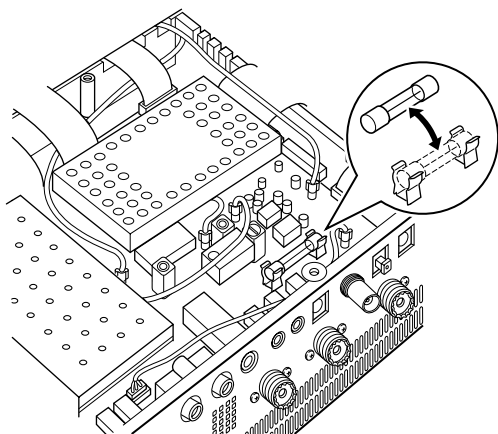

When no external DC output is available from [EXT DC] and ACC connectors, the internal fuse may be open. Replace the fuse in this case.

⚠ **WARNING! DISCONNECT** the AC power cable from the AC outlet before removing the transceiver's cover.

- ① Remove the bottom cover as shown left.
- ② Replace the open fuse with a new, properly rated one (FGB 2 A) as shown at left.
- ③ Replace the bottom cover.

■ Resetting the CPU

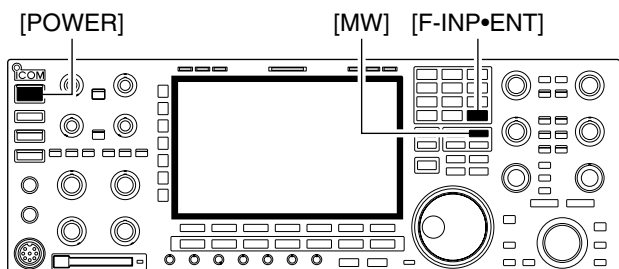

- ① Turn the main power switch on the rear panel ON.
 - Make sure the transceiver power is still OFF.
- ② While holding down [F-INP•ENT] and [MW], push [POWER] to turn power ON.
 - The internal CPU is reset.
 - The CPU start-up takes approximately 5 seconds.
 - The transceiver displays its initial VFO frequencies when resetting is complete.
- ③ Correct the set mode settings after resetting, if desired.

⚠ **NOTE:** Resetting **CLEARs** all programmed contents in memory channels and returns programmed values in set mode to default values.

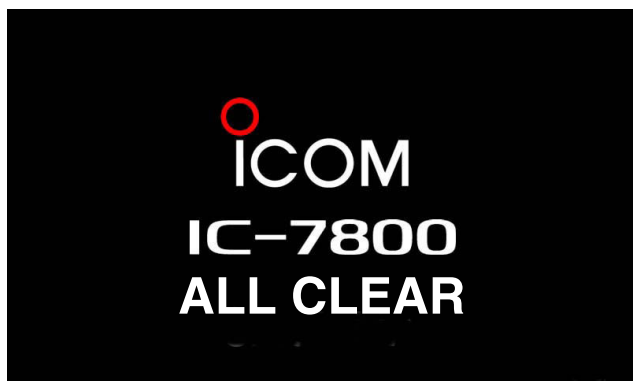

About protection indications

The IC-7800 has a 2-step protection function to protect the final power amplifiers.

The protector detects the power amplifier temperature and activates when the temperature becomes extremely high.

- **Power down transmission**

Reduces the transmit output power to 100 W. “LMT” appears beside the transmit indicator during transmit.

- **Transmission inhibit**

Deactivates the transmitter. The transmit indicator is displayed in gray during transmit.

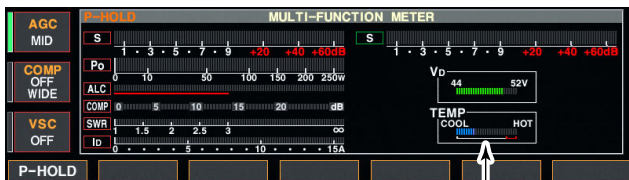

Check the temperature

When the protector is activated, wait until the power amplifier cools down using the transceiver in stand-by or receive condition.

NOTE: DO NOT turn the transceiver power OFF. The internal cooling fan does not function, so it will take longer to cool the transceiver.

The power amplifier temperature can be monitored in the multi-function meter, TEMP gauge.

Screen saver function

The IC-7800 has a screen saver function to protect the LCD from the “burn-in” effect.

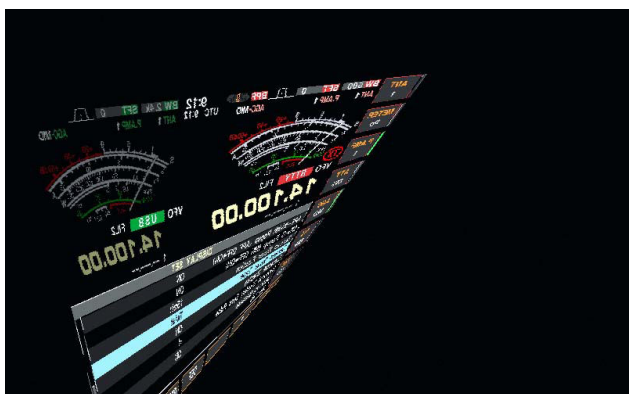
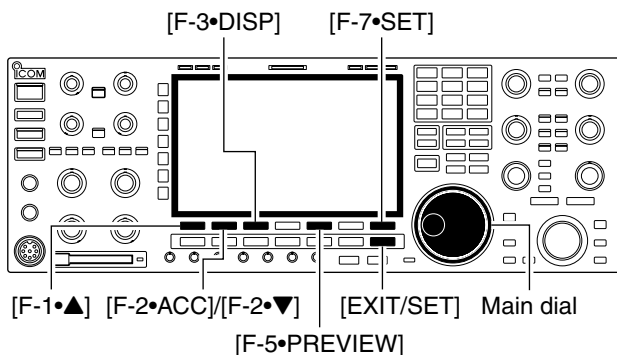

- ① Push [EXIT/SET] several times to close a multi-function screen, if necessary.
- ② Push [F-7•SET] to select set mode menu screen.
- ③ Push [F-3•DISP] to enter display set mode.
- ④ Push [F-1•▲]/[F-2•▼] several times to select the “Screen Saver Function” item.
- ⑤ Rotate main dial to select the desired time period for the screen saver activation from 15, 30, 60 min. and OFF.
 - Deactivate the screen saver with “OFF” selection.
- ⑥ Push [F-2•▼] to select the “Screen Saver Type” item.
- ⑦ Rotate main dial to select the screen saver type from “Bound,” “Rotation” and “Twist.”
 - Hold down [F-5•PREVIEW] to display the indication for your reference.
- ⑧ Push [EXIT/SET] twice to exit set mode.

NOTE: When the screen saver function is activated, the LCD backlight brightness is set to a minimum level. Also, the indicator blinks on the [MAIN] or [SUB] switch, whichever one was selected at the time.

- Remote jack (CI-V) information 14-2
 - ◇ CI-V connection example 14-2
 - ◇ Data format 14-2
 - ◇ Command table 14-3
 - ◇ Data contents description 14-10

Remote jack (CI-V) information

◇ CI-V connection example

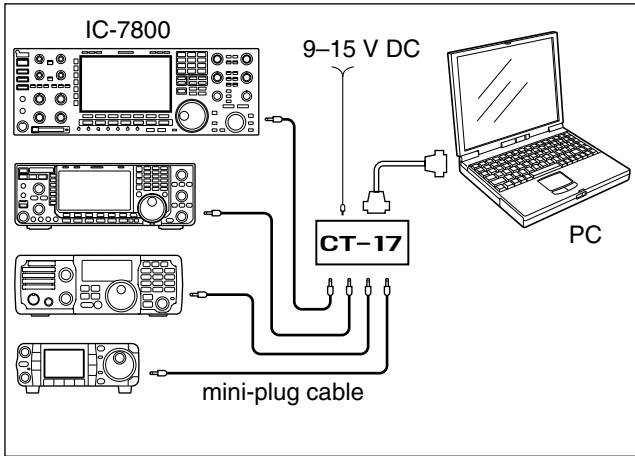

The transceiver can be connected through an optional CT-17 CI-V LEVEL CONVERTER to a PC equipped with an RS-232C port. The Icom Communications Interface-V (CI-V) controls of the transceiver.

Up to 4 Icom CI-V transceivers or receivers can be connected to a PC equipped with an RS-232C port. See page 12-21 for setting the CI-V condition using set mode.

◇ Data format

The CI-V system can be operated using the following data formats. Data formats differ according to command numbers. A data area or sub command is added for some commands.

Controller to IC-7800

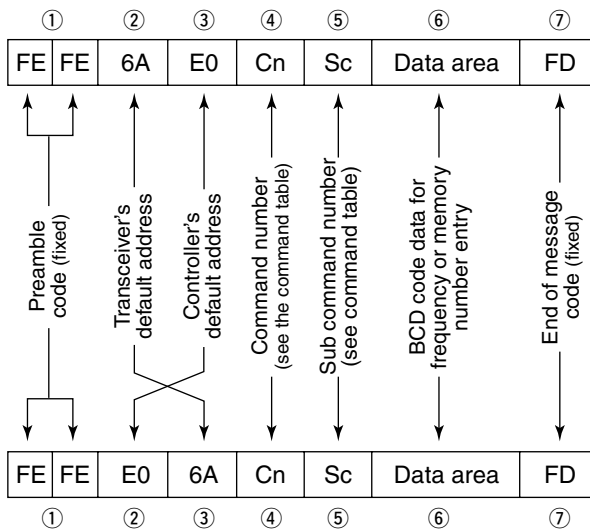

IC-7800 to controller

OK message to controller

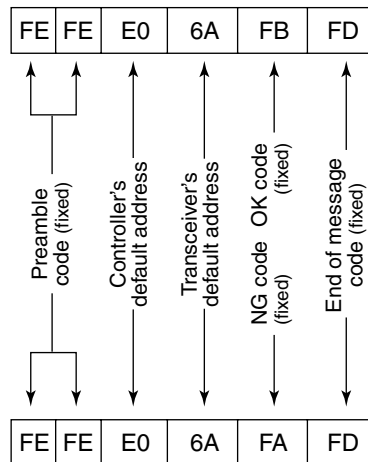

NG message to controller

◇ Command table

Cmd.	Sub Cmd.	Data	Description	
00		see p. 14-10	Send frequency data (transceive)	
01		see p. 14-10	Send mode data (transceive)	
02		see p. 14-12	Read band edge frequencies	
03		see p. 14-10	Read operating frequency	
04		see p. 14-10	Read operating mode	
05		see p. 14-10	Set operating frequency	
06		see p. 14-10	Operating mode selection for transceive	
07			Select VFO mode	
	B0		Exchange main and sub bands	
	B1		Equalize main and sub bands	
	C0		Turn the dualwatch OFF	
	C1		Turn the dualwatch ON	
	C2	00	Send/read the dualwatch setting OFF *Sub command, C0, is also usable for only setting.	
		01	Send/read the dualwatch setting ON *Sub command, C1, is also usable for only setting.	
	D0		Select main band	
	D1		Select sub band	
	D2	00	Send/read Main band selection *Sub command, D0, is also usable for only setting.	
		01	Send/read Main band selection *Sub command, D1, is also usable for only setting.	
	08			Select memory mode
		0001 to 0099		Select memory channel (0001=M-CH01, 0099=M-CH99)
		0100		Select program scan edge channel P1
0101			Select program scan edge channel P2	
09		Memory write		
0A		Memory to VFO		
0B		Memory clear		
0E	00		Scan stop	
	01		Programmed/memory scan start	
	02		Programmed scan start	
	03		∠F scan start	
	12		Fine programmed scan start	
	13		Fine ∠F scan start	
	22		Memory scan start	
	23		Select memory scan start	
	A1		Select ∠F scan span ±5 kHz	
	A2		Select ∠F scan span ±10 kHz	
	A3		Select ∠F scan span ±20 kHz	
	A4		Select ∠F scan span ±50 kHz	
	A5		Select ∠F scan span ±100 kHz	
	A6		Select ∠F scan span ±500 kHz	
	A7		Select ∠F scan span ±1 MHz	
	B0		Set as non-select channel	
	B1			Set as select channel (The previously set number by CI-V is set after turning power ON, or "1" is selected if no selection is performed.)
		01		Set as select channel "★1"
		02		Set as select channel "★2"
		03		Set as select channel "★3"
	B2	00		Set "ALL" for select memory scan
		01		Set "★1" for select memory scan
		02		Set "★2" for select memory scan
03			Set "★3" for select memory scan	
D0		Set scan resume OFF		
D3		Set scan resume ON		

Cmd.	Sub Cmd.	Data	Description	
0F			Read split setting (00=OFF, 01=ON)	
	00		Turn the split function OFF	
	01		Turn the split function ON	
10		00	Send/read tuning step OFF	
		01	Send/read 100 Hz tuning step	
		02	Send/read 1 kHz tuning step	
		03	Send/read 5 kHz tuning step	
		04	Send/read 9 kHz tuning step	
		05	Send/read 10 kHz tuning step	
		06	Send/read 12.5 kHz tuning step	
		07	Send/read 20 kHz tuning step	
11		00	Send/read attenuator OFF	
		03	Send/read 3 dB attenuator	
		06	Send/read 6 dB attenuator	
		09	Send/read 9 dB attenuator	
		12	Send/read 12 dB attenuator	
		15	Send/read 15 dB attenuator	
		18	Send/read 18 dB attenuator	
		21	Send/read 21 dB attenuator	
	12	00	00, 01	Select/read ANT1 selection (00=RX ANT OFF; 01=RX ANT ON)
		01	00, 01	Select/read ANT2 selection (00=RX ANT OFF; 01=RX ANT ON)
02		00, 01	Select/read ANT3 selection (00=RX ANT OFF; 01=RX ANT ON)	
03		00	Select/read ANT4 selection (00=RX ANT OFF; fix)	
13	00		Announce all data with voice synthesizer	
	01		Announce frequency and S-meter level with voice synthesizer	
	02		Announce receive mode with voice synthesizer	
14	01	0000 to 0255	Send/read [AF] level (0000=max. CCW, 0255=max. CW)	
	02	0000 to 0255	Send/read [RF] level (0000=max. CCW, 0255=max. CW)	
	03	0000 to 0255	Send/read [SQL] level (0000=max. CCW, 0255=max. CW)	
	05	0000 to 0255	Send/read [APF] level (0000=Pitch-550 Hz, 0128=Pitch, 0255=Pitch+550 Hz; 10 Hz steps)	
	06	0000 to 0255	Send/read [NR] level (0000=0%, 0255=100%)	
	07	0000 to 0255	Send/read inner [TWIN PBT] position (0000=max. CCW, 0128=center, 0255=max. CW)	
	08	0000 to 0255	Send/read outer [TWIN PBT] position (0000=max. CCW, 0128=center, 0255=max. CW)	
	09	0000 to 0255	Send/read CW pitch (0000=300 Hz, 0128=600 Hz, 0255=900 Hz; 5 Hz steps)	
	0A	0000 to 0255	Send/read [RF PWR] position (0000=max. CCW, 0255=max. CW)	
	0B	0000 to 0255	Send/read [MIC] position (0000=max. CCW, 0255=max. CW)	
	0C	0000 to 0255	Send/read [KEY SPEED] level (0000=6 wpm, 0255=48 wpm)	
	0D	0000 to 0255	Send/read [NOTCH] position (0000=max. CCW, 0128=center, 0255=max. CW)	

14 CONTROL COMMAND

◇ Command table (continued)

Cmd.	Sub Cmd.	Data	Description	
14	0E	0000 to 0255	Send/read COMP level (0000=0, 0255=10)	
	0F	0000 to 0255	Send/read [DELAY] position (0000=max. CCW, 0255=max. CW)	
	11	0000 to 0255	Send/read [AGC] level (0000=max. CCW to 0255=max. CW)	
	12	0000 to 0255	Send/read NB level (0000=0%, 0255=100%)	
	13	0000 to 0255	Send/read [DIGI-SEL] position (0000=max. CCW to 0255=max. CW)	
	14	0000 to 0255	Send/read DRIVE gain (0000=0%, 0255=100%)	
	15	0000 to 0255	Send/read Monitor gain (0000=0%, 0255=100%)	
	16	0000 to 0255	Send/read VOX gain (0000=0%, 0255=100%)	
	17	0000 to 0255	Send/read Anti VOX gain (0000=0%, 0255=100%)	
	18	0000 to 0255	Send/read [CONTRAST] position (0000=max. CCW to 0255=max. CW)	
	19	0000 to 0255	Send/read BRIGHT level (0000=0%, 0255=100%)	
	15	01	00	Read squelch condition (squelch close)
			01	Read squelch condition (squelch open)
02		0000 to 0255	Read S-meter level (0000=S0, 0120=S9, 0241=S9+60 dB)	
05		00	Read noise, S-meter squelch TSQ or VSC status (squelch close)	
		01	Read noise, S-meter squelch TSQ or VSC status (squelch open)	
11		0000 to 0255	Read RF power meter (0000=0 W, 0143=100 W, 0212=200 W)	
12		0000 to 0255	Read SWR meter (0000=SWR1.0, 0048=SWR1.5, 0080=SWR2.0)	
13		0000 to 0255	Read ALC meter (0000=0, 0120=Max.)	
14		0000 to 0255	Read COMP meter (0000=0 dB, 0130=15 dB, 0241=30 dB)	
15		0000 to 0255	Read VD meter (0151=44 V, 0180=48 V, 0211=52 V)	
16		0000 to 0255	Read ID meter (0000=0 A, 0165=10 A, 0241=15 A)	
16	02	00	Preamp OFF	
		01	Preamp 1 ON	
		02	Preamp 2 ON	
	12	00	AGC OFF selection	
		01	AGC FAST selection	
		02	AGC MID selection	
		03	AGC SLOW selection	
	22	00	Noise blanker OFF	
		01	Noise blanker ON	
	32	00	Audio peak filter OFF	
		01	Audio peak filter WIDE ON (320 Hz is selected when SHARP APF is set)	
		02	Audio peak filter MID ON (160 Hz is selected when SHARP APF is set)	
		03	Audio peak filter NAR ON (80 Hz is selected when SHARP APF is set)	
	40	00	Noise reduction OFF	
		01	Noise reduction ON	
	41	00	Auto notch function OFF	
		01	Auto notch function ON	

Cmd.	Sub Cmd.	Data	Description
16	42	00	Repeater tone OFF
		01	Repeater tone ON
	43	00	Tone squelch OFF
		01	Tone squelch ON
	44	00	Speech compressor OFF
		01	Speech compressor ON
	45	00	Monitor function OFF
		01	Monitor function ON
	46	00	VOX function OFF
		01	VOX function ON
	47	00	BK-IN function OFF
		01	Semi BK-IN function ON
		02	Full BK-IN function ON
	48	00	Manual notch function OFF
		01	Manual notch function ON
	4C	00	VSC function OFF
		01	VSC function ON
	4D	00	AGC VR function OFF
		01	AGC VR function ON
	4E	00	DIGI-SEL function OFF
		01	DIGI-SEL function ON
	4F	00	Twin peak filter OFF
		01	Twin peak filter ON
	50	00	Dial lock function OFF
		01	Dial lock function ON
	55	00	15 kHz roofing filter selection
		01	6 kHz roofing filter selection
		02	3 kHz roofing filter selection
	56	00	SHARP selection for DSP filter type
		01	SOFT selection for DSP filter type
	57	00	WIDE selection for manual notch width
		01	MID selection for manual notch width
02		NAR selection for manual notch width	
58	00	WIDE selection for SSB transmit bandwidth	
	01	MID selection for SSB transmit bandwidth	
	02	NAR selection for SSB transmit bandwidth	
17		see p. 14-12	Send CW messages*1
18	00		Turn OFF the transceiver.
	01		Turn ON the transceiver.*2
19	00		Read the transceiver ID
1A	00	see p. 14-13	Send/read memory contents
	01	see p. 14-10	Send/read band stacking register contents
	02	see p. 14-10	Send/read memory keyer contents
	03	00 to 49	Send/read the selected filter width (SSB, CW, PSK: 00=50 Hz to 40=3600 Hz; RTTY: 00=50 Hz to 31=2700 Hz; AM: 00=200 Hz to 49=10 kHz)
	04	00 to 13	Send/read the selected AGC time constant (00=OFF, 01=0.1/0.3 sec., 13=6.0/8.0 sec.)
050001	00 to 10		Send/read SSB TX Tone (Bass) level (00=-5 to 10=+5)

*1 In the CW mode, if the [TRANSMIT] or an external TX switch is ON, or the Break-in function is ON, a message will be transmitted as CW code when you send it from your PC.

*2 The power ON command (18 01) is available only when the transceiver is standby mode.

◇ Command table (continued)

Cmd.	Sub Cmd.	Data	Description
1A	050002	00 to 10	Send/read SSB TX Tone (Treble) level (00=-5 to 10=+5)
	050003	00 to 10	Send/read SSB RX Tone (Bass) level (00 =-5 to 10=+5)
	050004	00 to 10	Send/read SSB RX Tone (Treble) level (00=-5 to 10=+5)
	050005	00 to 10	Send/read AM TX Tone (Bass) level (00 =-5 to 10=+5)
	050006	00 to 10	Send/read AM TX Tone (Treble) level (00=-5 to 10=+5)
	050007	00 to 10	Send/read AM RX Tone (Bass) level (00 =-5 to 10=+5)
	050008	00 to 10	Send/read AM RX Tone (Treble) level (00=-5 to 10=+5)
	050009	00 to 10	Send/read FM TX Tone (Bass) level (00 =-5 to 10=+5)
	050010	00 to 10	Send/read FM TX Tone (Treble) level (00=-5 to 10=+5)
	050011	00 to 10	Send/read FM RX Tone (Bass) level (00 =-5 to 10=+5)
	050012	00 to 10	Send/read FM RX Tone (Treble) level (00=-5 to 10=+5)
	050013	see p. 14-12	Send/read SSB TX bandwidth for wide
	050014	see p. 14-12	Send/read SSB TX bandwidth for mid.
	050015	see p. 14-12	Send/read SSB TX bandwidth for narrow
	050016	0000 to 0255	Send/read speech level (0000=0% to 0255=100%)
	050017	0000 to 0255	Send/read CW side tone gain (0000=0% to 0255=100%)
	050018	00 or 01	Send/read CW side tone gain limit (00=OFF, 01=ON)
	050019	0000 to 0255	Send/read beep gain (0000=min. to 0255=max.)
	050020	00 or 01	Send/read beep gain limit (00=OFF, 01=ON)
	050021	0000 to 0255	Send/read headphones output ratio (0000=0.60 to 0255=1.40)
	050022	00 or 01	Send/read headphone output selection (00=separated, 01=mixed)
	050023	00 or 01	Send/read AF/SQL signal output to ACC-A (00=Main; 01=Sub)
	050024	00 or 01	Send/read AF/SQL signal output to ACC-B (00=Main; 01=Sub)
	050025	0000 to 0255	Send/read AF output level to ACC-A (0000=0% to 0255=100%)
	050026	0000 to 0255	Send/read AF output level to ACC-B (0000=0% to 0255=100%)
	050027	0000 to 0255	Send/read S/P DIF output level (0000=0% to 0255=100%)
	050028	0000 to 0255	Send/read MOD output level to ACC-A (0000=0% to 0255=100%)
	050029	0000 to 0255	Send/read MOD output level to ACC-B (0000=0% to 0255=100%)
	050030	0000 to 0255	Send/read S/P DIF MOD output level (0000=0% to 0255=100%)
	050031	00 to 08	Send/read MOD input connector during DATA OFF (00=MIC; 01=ACC-A; 02=ACC-B; 03=MIC/ACC-A; 04=MIC/ACC-B; 05=ACC-A/ACC-B; 06=MIC/ACCA/ACC-B; 07=S/P DIF, 08=LAN)
	050032	00 to 08	Send/read MOD input connector during DATA1 (00=MIC; 01=ACC-A; 02=ACC-B; 03=MIC/ACC-A; 04=MIC/ACC-B; 05=ACC-A/ACC-B; 06=MIC/ACCA/ACC-B; 07=S/P DIF, 08=LAN)

Cmd.	Sub Cmd.	Data	Description
1A	050033	00 to 08	Send/read MOD input connector during DATA2 (00=MIC; 01=ACC-A; 02=ACC-B; 03=MIC/ACC-A; 04=MIC/ACC-B; 05=ACC-A/ACC-B; 06=MIC/ACCA/ACC-B; 07=S/P DIF, 08=LAN)
	050034	00 to 08	Send/read MOD input connector during DATA3 (00=MIC; 01=ACC-A; 02=ACC-B; 03=MIC/ACC-A; 04=MIC/ACC-B; 05=ACC-A/ACC-B; 06=MIC/ACCA/ACC-B; 07=S/P DIF, 08=LAN)
	050035	00 to 02	Send/read the band selection for operating frequency band signal output to ACC-A (00=MAIN, 01=SUB, 02=TX)
	050036	00 to 02	Send/read the band selection for operating frequency band signal output to ACC-A (00=MAIN, 01=SUB, 02=TX)
	050037	00 or 01	Send/read relay type selection (00=Reed, 01=MOS-FET)
	050038	00 to 07	Send/read main band's external meter output selection (00=Auto, 01=S (main), 02=Po, 03=SWR, 04=ALC, 05=COMP, 06=VD, 07=ID)
	050039	00 to 07	Send/read sub band's external meter output selection (00=Auto, 01=S (sub), 02=Po, 03=SWR, 04=ALC, 05=COMP, 06=VD, 07=ID)
	050040	0000 to 0255	Send/read main band's external meter output level (0000=0% to 0255=100%)
	050041	0000 to 0255	Send/read sub band's external meter output level (0000=0% to 0255=100%)
	050042	00 to 02	Send/read reference signal in/out setting (00=IN, 01=OFF, 02=OUT)
	050043	0000 to 0255	Send/read reference signal frequency setting (0000=0% to 0255=100%)
	050044	0000 to 0255	Send/read LCD unit backlight brightness (0000=0% to 0255=100%)
	050045	0000 to 0255	Send/read switch indicator brightness (0000=1 to 0255=100)
	050046	00 to 02	Send/read screen image type (00=A, 01=B, 02=C)
	050047	00 to 03 04 to 06 07 to 09 10 to 13 14 to 17	Send/read frequency readout font (00=Italic (1), 01=Italic (2), 02=Italic (3), 03=Italic (4), 04=Round (1), 05=Round (2), 06=Round (3), 07=Shadow (1), 08=Shadow (2), 09=Shadow (3), 10=Qubic (1), 11=Qubic (2), 12=Qubic (3), 13=Qubic (4), 14=IC-780 (1), 15=IC-780 (2), 16=IC-780 (3), 17=IC-780 (4))
	050048	00 or 01	Send/read font for other than frequency readout (00=Normal, 01=Slim)
	050049	00 to 02	Send/read meter type (00=Standard, 01=Edgewise, 02=Bar)
	050050	00 or 01	Send/read meter type during wide screen or mini scope indication (00=Edgewise, 01=Bar)
	050051	00 or 01	Send/read peak hold set for Bar meter (00=OFF, 01=ON)
	050052	00 or 01	Send/read memory name indication setting (00=OFF, 01=ON)
	050053	00 or 01	Send/read audio peak filter width pop-up indication setting (00=OFF, 01=ON)

◇ Command table (continued)

Cmd.	Sub Cmd.	Data	Description
1A	050054	00 or 01	Send/read manual notch width pop-up indication setting (00=OFF, 01=ON)
	050055	00 or 01	Send/read output signal setting for external display (00=OFF, 01=ON)
	050056	00 or 01	Send/read synchronous pulse level setting (00=L, 01=H)
	050057	00 or 01	Send/read opening message indication (00=OFF, 01=ON)
	050058	see p. 14-11	Send/read opening message contents
	050059	20000101 to 20991231	Send/read date (20000101=1st Jan. 2000 to 20991231=31st Dec. 2099)
	050060	0000 to 2359	Send/read time (0000=00:00 to 2359=23:59)
	050061	00 or 01	Send/read CLOCK2 function (00=OFF, 01=ON)
	050062	see p. 14-10	Send/read offset time for CLOCK2 (240001=-24:00 to 240000=+24:00)
	050063	see p. 14-11	Send/read CLOCK2 name (up to 3-character)
	050064	00 or 01	Send/read calibration marker (00=OFF, 01=ON)
	050065	00 or 01	Send/read confirmation beep (00=OFF, 01=ON)
	050066	00	Band edge beep OFF
		01	Band edge beep ON (Beep sounds with a default amateur band)
		02	Band edge beep with user setting ON
		03	Band edge beep with user setting/TX limit ON
	050067	0050 to 0200	Send/read main band's beep audio frequency (0050=500 Hz to 0200=2000 Hz)
	050068	0050 to 0200	Send/read sub band's beep audio frequency (0050=500 Hz to 0200=2000 Hz)
	050069	00 or 01	Send/read quick dualwatch function (00=OFF, 01=ON)
	050070	00 or 01	Send/read quick split set (00=OFF, 01=ON)
	050071	see p. 14-11	Send/read FM split offset -9.999 to +9.999 MHz for HF
	050072	see p. 14-11	Send/read FM split offset -9.999 to +9.999 MHz for 50 MHz
	050073	00 or 01	Send/read split lock set (00=OFF, 01=ON)
	050074	00 or 01	Send/read tuner auto start set (00=OFF, 01=ON)
	050075	00 or 01	Send/read PTT tune set (00=OFF, 01=ON)
	050076	00 or 01	Send/read transverter set (00=OFF, 01=ON)
	050077	see p. 14-11	Send/read transverter offset
	050078	00 to 02	Send/read RTTY mark frequency (00=1275 Hz, 01=1615 Hz, 02=2125 Hz)
	050079	00 to 02	Send/read RTTY shift width (00=170 Hz, 01=200 Hz, 02=425 Hz)
	050080	00 or 01	Send/read RTTY keying polarity (00=Normal, 01=Reverse)
	050081	00 to 02	Send/read PSK tone frequency (00=1000 Hz, 01=1500 Hz, 02=2000 Hz)
	050082	00 or 01	Send/read speech language (00=English, 01=Japanese)
050083	00 or 01	Send/read speech speed (00=Slow, 01=Fast)	
050084	00 or 01	Send/read S-level speech (00=OFF, 01=ON)	

Cmd.	Sub Cmd.	Data	Description
1A	050085	00 or 01	Send/read speech with a mode switch operation (00=OFF, 01=ON)
	050086	00 or 01	Send/read memo pad numbers (00=5 ch, 01=10 ch)
	050087	00 or 01	Send/read main dial function (00=MAIN, 01=MAIN+SUB)
	050088	00 to 02	Send/read main dial auto TS (00=OFF, 01=Low, 02=High)
	050089	00 to 02	Send/read sub dial auto TS (00=OFF, 01=Low, 02=High)
	050090	00 or 01	Send/read mic. up/down speed (00=Low, 01=High)
	050091	00 or 01	Send/read quick RIT/ΔTX clear function (00=OFF, 01=ON)
	050092	00 to 02	Send/read SSB notch operation (00=Auto, 01=Manual, 02=Auto/Manual)
	050093	00 to 02	Send/read AM notch operation (00=Auto, 01=Manual, 02=Auto/Manual)
	050094	00 or 01	Send/read DIGI-SEL control function (00=DIGI-SEL, 01=APF)
	050095	00 or 01	Send/read band indication for filter set screen (00=Fix, 01=Auto)
	050096	00 or 01	Send/read SSB/CW synchronous tuning function (00=OFF, 01=ON)
	050097	00 or 01	Send/read CW normal side set (00=LSB, 01=USB)
	050098	00 or 01	Send/read band setting for audio output from mic. connector (00=MAIN+SUB, 01=SUB)
	050099	00 or 01	Send/read external keypad set for voice memory (00=OFF, 01=ON)
	050100	00 or 01	Send/read external keypad set for keyer memory (00=OFF, 01=ON)
	050101	00 or 01	Send/read CI-V transceiver set (00=OFF, 01=ON)
	050102	00 or 01	Send/read RS-232C function (00=CI-V, 01=Decode)
	050103	00 to 04	Send/read RS-232C decode speed (00=300, 01=1200, 02=4800, 03=9600, 04=19200)
	050104	00 to 10	Send/read keyboard type (00=English, 01=Japanese, 02=United Kingdom, 03=French, 04=French (Canadian), 05=German, 06=Portuguese, 07=Portuguese (Brazilian), 08=Spanish, 09=Spanish (Latin American), 10=Italian)
	050105	0010 to 0100	Send/read keyboard repeat delay (0010=100 msec., 0100=1000 msec.; 50 msec. steps)
	050106	00 to 31	Send/read keyboard repeat rate (00=2.0 cps to 31=30.0 cps)
	050107		Send/read IP address set (0000000000000001=0.0.0.1 to 0255 025502550254=255.255.255.254)
	050108	01 to 30	Send/read subnet mask (01=128.0.0.0 to 30=255.255.255.252)
	050109	00 or 01	Send/read scope indication during TX (00=OFF, 01=ON)
	050110	00 or 01	Send/read scope max. hold (00=OFF, 01=ON)
	050111	00 to 02	Send/read scope center frequency set (00=Filter center, 01=Carrier point center, 02=Carrier point center (Abs. Freq.))

◇ Command table (continued)

Cmd.	Sub Cmd.	Data	Description
1A	050112	see p. 14-11	Send/read waveform color for receiving signal
	050113	see p. 14-11	Send/read waveform color for max. hold
	050114	00 to 02	Send/read scope sweep speed for ±2.5 kHz span (00=Slow, 01=Mid., 02=Fast)
	050115	00 to 02	Send/read scope sweep speed for ±5 kHz span (00=Slow, 01=Mid., 02=Fast)
	050116	00 to 02	Send/read scope sweep speed for ±10 kHz span (00=Slow, 01=Mid., 02=Fast)
	050117	00 to 02	Send/read scope sweep speed for ±25 kHz span (00=Slow, 01=Mid., 02=Fast)
	050118	00 to 02	Send/read scope sweep speed for ±50 kHz span (00=Slow, 01=Mid., 02=Fast)
	050119	00 to 02	Send/read scope sweep speed for ±100 kHz span (00=Slow, 01=Mid., 02=Fast)
	050120	00 to 02	Send/read scope sweep speed for ±250 kHz span (00=Slow, 01=Mid., 02=Fast)
	050121	see p. 14-11	Send/read scope edge frequencies for 0.03 to 1.60 MHz band
	050122	see p. 14-11	Send/read scope edge frequencies for 1.60 to 2.00 MHz band
	050123	see p. 14-11	Send/read scope edge frequencies for 2.00 to 6.00 MHz band
	050124	see p. 14-11	Send/read scope edge frequencies for 6.00 to 8.00 MHz band
	050125	see p. 14-11	Send/read scope edge frequencies for 8.00 to 11.00 MHz band
	050126	see p. 14-11	Send/read scope edge frequencies for 11.00 to 15.00 MHz band
	050127	see p. 14-11	Send/read scope edge frequencies for 15.00 to 20.00 MHz band
	050128	see p. 14-11	Send/read scope edge frequencies for 20.00 to 22.00 MHz band
	050129	see p. 14-11	Send/read scope edge frequencies for 22.00 to 26.00 MHz band
	050130	see p. 14-11	Send/read scope edge frequencies for 26.00 to 30.00 MHz band
	050131	see p. 14-11	Send/read scope edge frequencies for 30.00 to 45.00 MHz band
	050132	see p. 14-11	Send/read scope edge frequencies for 45.00 to 60.00 MHz band
	050133	00 or 01	Send/read auto voice monitor set (00=OFF, 01=ON)
	050134	03 to 10	Send/read voice memory short play time (03=3 sec. to 10=10 sec.)
	050135	05 to 30	Send/read voice memory normal record time (05= 5 sec. to 30=30 sec.)
	050136	00	Normal selection for contest number style
		01	"190→ANO" selection for contest number style
		02	"190→ANT" selection for contest number style
		03	"90→NO" selection for contest number style
		04	"90→NT" selection for contest number style
	050137	01 to 04	Send/read count up trigger channel (01=M1, 02=M2, 03=M3, 04=M4)

Cmd.	Sub Cmd.	Data	Description
1A	050138	0001 to 9999	Send/read present number (0001=1, 9999=9999)
	050139	01 to 60	Send/read CW keyer repeat time (01=1 sec. to 60=60 sec.)
	050140	28 to 45	Send/read CW keyer dot/dash ratio (28=1:1:2.8 to 45=1:1:4.5)
	050141	00 to 03	Send/read rise time (00=2 msec., 01=4 msec., 02=6 msec., 03=8 msec.)
	050142	00 or 01	Send/read paddle polarity (00=Normal, 01=Reverse)
	050143	00 to 02	Send/read keyer type (00=Straight, 01=Bug-key, 02=ELEC-Key)
	050144	00 or 01	Send/read mic. up/down keyer set (00=OFF, 01=ON)
	050145	00 or 01	Send/read RTTY decode USOS (00=OFF, 01=ON)
	050146	00 or 01	Send/read RTTY decode new line code (00=CR,LF,CR+LF, 01=CR+LF)
	050147	00 to 02	Send/read RTTY diddle (00=OFF, 01=Blank, 02=LTRS (Letter code))
	050148	00 or 01	Send/read RTTY TX USOS (00=OFF, 01=ON)
	050149	00 or 01	Send/read RTTY auto CR+LF by TX (00=OFF, 01=ON)
	050150	00 or 01	Send/read RTTY time stamp set (00=OFF, 01=ON)
	050151	00 or 01	Send/read clock selection for time stamp (0=Local time, 1=CLOCK2)
	050152	00 or 01	Send/read frequency stamp (00=OFF, 01=ON)
	050153	see p. 14-11	Send/read received text font color
	050154	see p. 14-11	Send/read transmitted text font color
	050155	see p. 14-11	Send/read time stamp text font color
	050156	see p. 14-11	Send/read text font color in TX buffer
	050157	00 or 01	Send/read PSK time stamp set (00=OFF, 01=ON)
	050158	00 or 01	Send/read clock selection for time stamp (00=Local time, 01=Clock 2)
	050159	00 or 01	Send/read frequency stamp (00=OFF, 01=ON)
	050160	see p. 14-11	Send/read received text font color for PSK decoder
	050161	see p. 14-11	Send/read transmitted text font color (PSK)
	050162	see p. 14-11	Send/read time stamp text font color (PSK)
	050163	see p. 14-11	Send/read text font color in TX buffer (PSK)
	050164	00 or 01	Send/read scan speed (00=Low, 01=High)
	050165	00 or 01	Send/read scan resume (00=OFF, 01=ON)
	050166	see p. 14-12	Send/read antenna selection for 0.03 to 1.60 MHz band
	050167	see p. 14-12	Send/read antenna selection for 1.60 to 2.00 MHz band
	050168	see p. 14-12	Send/read antenna selection for 2.00 to 6.00 MHz band
	050169	see p. 14-12	Send/read antenna selection for 6.00 to 8.00 MHz band
050170	see p. 14-12	Send/read antenna selection for 8.00 to 11.00 MHz band	
050171	see p. 14-12	Send/read antenna selection for 11.00 to 15.00 MHz band	
050172	see p. 14-12	Send/read antenna selection for 15.00 to 20.00 MHz band	

◇ Command table (continued)

Cmd.	Sub Cmd.	Data	Description
1A	050173	see p. 14-12	Send/read antenna selection for 20.00 to 22.00 MHz band
	050174	see p. 14-12	Send/read antenna selection for 22.00 to 26.00 MHz band
	050175	see p. 14-12	Send/read antenna selection for 26.00 to 30.00 MHz band
	050176	see p. 14-12	Send/read antenna selection for 30.00 to 45.00 MHz band
	050177	see p. 14-12	Send/read antenna selection for 45.00 to 60.00 MHz band
	050178	00 or 01	Send/read antenna temporary memory set (00=OFF, 01=ON)
	050179	00 to 02	Send/read antenna selection (00=OFF, 01=Manual, 02=Auto)
	050180	00 or 01	Send/read usage for ANT2 (00=OFF, 01=TX/RX)
	050181	00 or 01	Send/read usage for ANT3 (00=OFF, 01=TX/RX)
	050182	00 to 02	Send/read usage for ANT4 (00=OFF, 01=TX/RX, 02=RX)
	050183	00 to 20	Send/read VOX delay (00=0.0 sec. to 20=2.0 sec.)
	050184	00 to 03	Send/read VOX voice delay (00=OFF, 01=Short, 02=Mid., 03=Long)
	050185	00 to 09	Send/read NB depth (00=1 to 09=10)
	050186	0000 to 0255	Send/read NB width (0000=1 to 0255=100)
	050187	00 to 03	Send/read screen saver set (00=OFF, 01=15 min., 02=30 min., 03=60 min.)
	050188	00 to 02	Set/read screen saver type (00=Bound, 01=Rotation, 02=Twist)
	050189	00 to 02	Set/read meter response setting (00=SLOW, 01=MID, 02=FAST)
	050190	00 to 03	Set/read FFT scope averaging set for RTTY decoder (00=OFF, 01=2, 02=3, 03=4)
	050191	see p. 14-11	Set/read FFT scope waveform color set for RTTY decoder
	050192	00 to 03	Set/read FFT scope averaging set for PSK decoder (00=OFF, 01=2, 02=3, 03=4)
	050193	see p. 14-11	Set/read FFT scope waveform color set for PSK decoder
	050194	00 or 01	Set/read PSK AFC function tuning range (00=±8 Hz, 01=±15 Hz)
	050195	00 or 01	Set/read APF type (00=SHARP, 01=SOFT)
	050196	00 or 01	Send/read external keypad set for RTTY memory (00=OFF, 01=ON)
	050197	00 or 01	Send/read external keypad set for PSK memory (00=OFF, 01=ON)
	050198	00 or 01	Voice memory transmission set for [F1]–[F4] on the keyboard (00=OFF, 01=ON)
	050199	00 or 01	Memory keyer transmission set for [F1]–[F4] on the keyboard (00=OFF, 01=ON)
	050200	00	Send/read time-out timer OFF
		01	Send/read 3 min. time-out timer
		02	Send/read 5 min. time-out timer
		03	Send/read 10 min. time-out timer
		04	Send/read 20 min. time-out timer
	050201	00 to 06	Send/read APF AF level. (00=0 dB to 06=+6dB)

Cmd.	Sub Cmd.	Data	Description
1A	050202	0000 to 0255	Send/read LAN MOD output level (0000=0% to 0255=100%)
	050203	00 to 05	Send/read the TX Delay setting (HF) (00=OFF, 01=10 ms, 02=15 ms, 03=20 ms, 04=25 ms, 05=30 ms)
	050204	00 to 05	Send/read the TX Delay setting (50M) (00=OFF, 01=10 ms, 02=15 ms, 03=20 ms, 04=25 ms, 05=30 ms)
	050205	00, 01	Send/read the Shutdown function. (00=Shutdown, 01=Standby/Shutdown)
	050206	0000 to 0223	Send/read the transceiver CI-V Address for LAN to REMOTE in hexadecimal code. (0000=00h to 0223=DFh)
	050207		Send/read the default gateway set (0000000000000001=0.0.0.1 to 0255 025502550254=255.255.255.254, or FF=Blank)
	050208	00, 01	Send/read the remote control capability. (00=OFF, 01=ON)
	050209	000001 to 065535	Send/read the control port setting by accessing from internet. (000001=1 to 065535=65535)
	050210	000001 to 065535	Send/read the serial port setting by accessing from internet. (000001=1 to 065535=65535)
	050211	000001 to 065535	Send/read the audio port setting by accessing from internet. (000001=1 to 065535=65535)
	050212	00, 01	Send/read the internet access line setting. (00=FTTH (Fiber To The Home), 01=ADSL/CATV)
	050213	see p. 14-13	Send/read Network radio name (up to 16-character)
	050214	00 to 04	Send/read the maximum AF sample rates for remote stations. (00=8 kHz, 01=12 kHz, 02=16 kHz, 03=24 kHz, 04=48 kHz)
	050215	00 to 02	Send/read the AF codecs for remote stations. (00=LPCM 8bit, 01=LPCM 8bit, u-law 8bit, 02=LPCM 8bit, u-law 8bit, LPCM 16bit)
	050216	00, 01	Send/read the stereo operation capability for remote stations. (00=1ch, 01=2ch)
	050217	00, 01	Send/read the network TX audio setting for remote stations. (00=OFF, 01=ON)
	050218	00 to 04	Send/read the maximum modulation sample rates for remote stations. (00=8 kHz, 01=12 kHz, 02=16 kHz, 03=24 kHz, 04=48 kHz)
	050219	00 to 02	Send/read the modulation codecs for remote stations. (00=LPCM 8bit, 01=LPCM 8bit, u-law 8bit, 02=LPCM 8bit, u-law 8bit, LPCM 16bit)
	050220	00, 01	Send/read the waveform outline indication on the spectrum scope. (00=Fill, 01=Fill+Line)
	050221	see p. 14-11	Send/read the waveform outline color for receiving signal.
	050222	00, 01	Send/read the waterfall display on the Spectrum scope. (00=OFF, 01=ON)

◇ Command table (continued)

Cmd.	Sub Cmd.	Data	Description	
1A	050223	00 to 07	Send/read the peak color level for displaying the waterfall. 00=Grid 1, 01=Grid 2, 02=Grid 3, 03=Grid 4, 04=Grid 5, 05=Grid 6, 06=Grid 7, 07=Grid 8	
	050224	00, 01	Send/read waveform type on the Audio FFT scope. (00=Fill, 01=Line)	
	050225	see p. 14-11	Send/read waveform color for Audio FFT scope.	
	050226	00, 01	Send/read the waterfall display on the Audio FFT scope. (00=OFF, 01=ON)	
	050227	see p. 14-11	Send/read waveform color for Audio Oscilloscope scope.	
	050228	00, 01	Send/read the voice 1st menu. (00=VOICE-Root, 01=VOICE-PLAY)	
	050229	01 to 15	Send/read the repeat interval to transmit the recorded voice audio. (01=1 sec. to 15=15 sec.)	
	050230	00, 01	Send/read the QSO recording device setting. (00=CF memory card, 01=USB flash drive)	
	050231	00, 01	Send/read the recording mode. (00=TX&RX, 01=RX Only)	
	050232	00, 01	Send/read the squelch status for the RX voice audio recording (00=Always, 01=Squelch Auto)	
	050233	00, 01	Send/read the QSO audio record file Split function setting. (00=OFF, 01=ON)	
	050234	00, 01	Send/read the PTT Automatic Recording function setting. (00=OFF, 01=ON)	
	050235	00 to 03	Send/read QSO PLAY Skip time. (00=3 sec., 01=5 sec., 02=10 sec., 03=30 sec.)	
	050236	00		Send/read command to disable to output the antenna controller status (frequency and so on) from [REMOTE].
		01		Send/read command to enable to output the antenna controller status (frequency and so on) from [REMOTE].
	06	see p. 14-11		Send/read DATA mode with filter set
	07	00		WIDE selection for SSB transmit bandwidth
		01		MID selection for SSB transmit bandwidth
		02		NAR selection for SSB transmit bandwidth
	08	00		SHARP selection for DSP filter type
01			SOFT selection for DSP filter type	
09	00		3 kHz roofing filter selection	
	01		6 kHz roofing filter selection	
	02		15 kHz roofing filter selection	
0A	00		WIDE selection for manual notch width	
	01		MID selection for manual notch width	
	02		NAR selection for manual notch width	

Cmd.	Sub Cmd.	Data	Description
1B	00	see p. 14-11	Send/read repeater tone frequency
	01	see p. 14-11	Set/read TSQL tone frequency
1C	00	00	Send/read transceiver's status (RX). When "CI-V Output (for ANT)" (Command: 1C 04) is set to "ON," automatically outputs when changed.
		01	Send/read transceiver's status (TX). When "CI-V Output (for ANT)" (Command: 1C 04) is set to "ON," automatically outputs when changed.
	01	00	Antenna tuner OFF (through)
		01	Antenna tuner ON
		02	Tuning
	02	00 or 01	Send/read transmit frequency monitor setting (00=OFF, 01=ON)
	03	see p. 14-10	Read transmit frequency. When "CI-V Output (for ANT)" (Command: 1C 04) is set to "ON," automatically outputs when changed.
	04	00	Send/read command to disable to output the antenna controller status (frequency and so on) from [REMOTE].
		01	Send/read command to enable to output the antenna controller status (frequency and so on) from [REMOTE].
	1E	00	
01		see p. 14-12	Read TX band edge frequencies
02			Read number of user-set TX frequency band
03		see p. 14-12	Send/read user-set TX band edge frequencies
21	00	see p. 14-12	Send/read RIT frequency.
	01	00, 01	Send/read RIT setting. (00=OFF, 01=ON)
	02	00, 01	Send/read ΔTX setting. (00=OFF, 01=ON)
25		see p. 14-14	Send/read the Main or Sub band frequency.
26		see p. 14-14	Send/read the Main or Sub band operating mode and filter.

◇ Data contents description

• Operating frequency

Command : 00, 03, 05, 1C 03

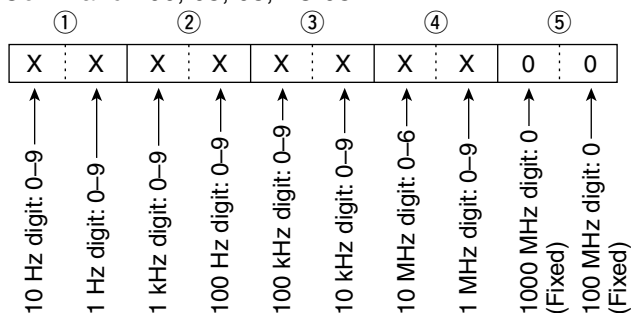

• Operating mode

Command : 01, 04, 06

Filter setting (②) can be skipped with command 01 and 06. In that case, "FIL1" is selected with command 01 and the default filter setting of the operating mode is selected with command 06, automatically.

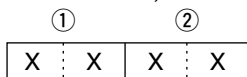

① Operating mode		② Filter setting
00: LSB	05: FM	01: FIL1
01: USB	07: CW-R	02: FIL2
02: AM	08: RTTY-R	03: FIL3
03: CW	12: PSK	
04: RTTY	13: PSK-R	

• Memory keyer contents

Command : 1A 02

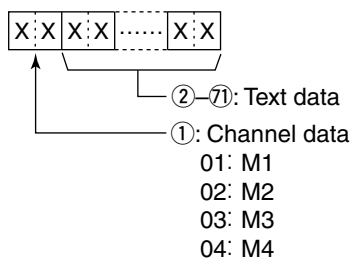

- Character's code

Character	ASCII code	Description
0-9	30-39	Numerals
A-Z	41-5A	Alphabetical characters
space	20	Word space
/	2F	Symbol
?	3F	Symbol
,	2C	Symbol
.	2E	Symbol
@	40	Symbol
^	5E	e.g., to send BT, enter ^4254
*	2A	Inserts contest number (can be used for 1 channel only)

• Band stacking register

Command : 1A 01

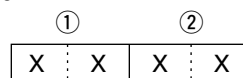

① Frequency band code

Code	Freq. band	Frequency range (unit: MHz)
01	1.8	1.800000-1.999999
02	3.5	3.400000-4.099999
03	7	6.900000-7.499999
04	10	9.900000-10.499999
05	14	13.900000-14.499999
06	18	17.900000-18.499999
07	21	20.900000-21.499999
08	24	24.400000-25.099999
09	28	28.000000-29.999999
10	50	50.000000-54.000000
11	GENE	Other than above

② Register code

Code	Registered number
01	1 (latest)
02	2
03	3 (oldest)

For example, when sending/reading the oldest contents in the 21 MHz band, the code "0703" is used.

When sending the contents, the following code should be added after code ②.

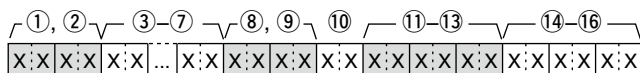

③-⑦ Operating frequency setting

See "• Operating frequency."

⑧, ⑨ Operating mode setting

See "• Operating mode."

⑩ Data mode and tone setting

1 byte data (XX)

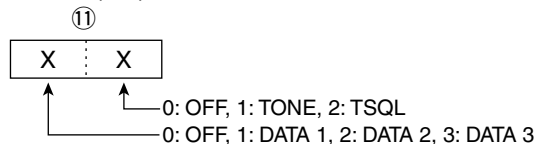

⑪-⑬ Repeater tone frequency setting

⑭-⑯ Tone squelch frequency setting

See "• Repeater tone/tone squelch setting."

• Clock 2 offset time setting

Command : 1A 050062

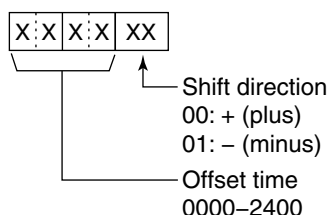

• Offset frequency setting

Command : 1A 050071, 050072, 050077

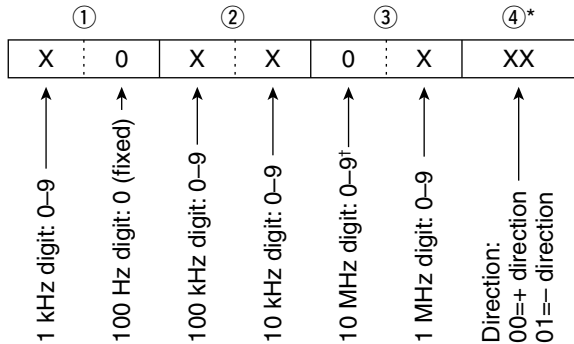

*No need to enter for transverter offset frequency setting.
†Transverter offset only; Fix to '0' for split offset setting.

• Codes for memory name, opening message and CLOCK2 name contents

- Character's code— Alphabetical characters

Character	ASCII code	Character	ASCII code
A-Z	41-5A	a-z	61-7A

- Character's code— Symbols

Character	ASCII code	Character	ASCII code
!	21	#	23
\$	24	%	25
&	26	\	5C
?	3F	"	22
'	27	`	60
^	5E	+	2B
-	2D	*	2A
/	2F	.	2E
,	2C	:	3A
;	3B	=	3D
<	3C	>	3E
(28)	29
[5B]	5D
{	7B	}	7D
	7C	_	5F
-	7E	@	40

Command	Set item/available characters
1A 00	Memory name All characters are available.
1A 050058	Opening message Capital letters, numerals, some symbols (- / . @) and space are available.
1A 050063	CLOCK2 name Capital letters, small letters, numerals, some symbols (! # \$ % & \ ? " ' ` ^ + - * / . , ; = < > () [] { } _ ` @) and space are available.

• Color setting

Command : 1A 050112, 050113, 050153, 050154, 050155, 050156, 050160, 050161, 050162, 050163, 050191, 050193, 050221, 050225, 050227

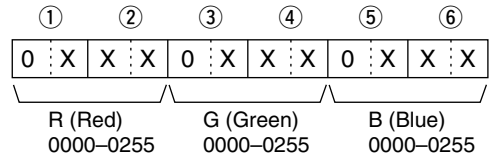

• Bandscope edge frequency setting

Command : 1A 050121, 050122, 050123, 050124, 050125, 050126, 050127, 050128, 050129, 050130, 050131, 050132

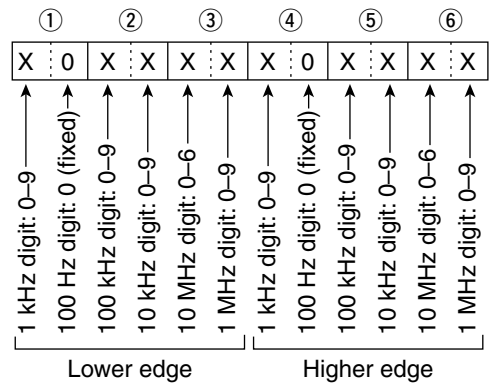

• Data mode with filter width setting

Command : 1A 06

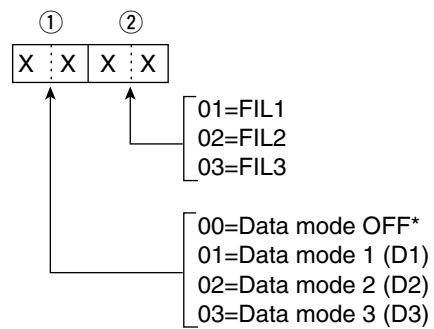

*When "00" is set, set "00" in ②.

• Repeater tone/tone squelch frequency setting

Command : 1B 00, 1B 01

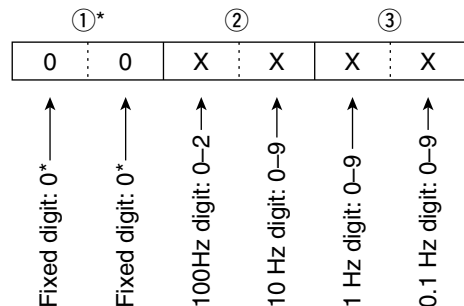

*Not necessary when setting a frequency.

◇ Data contents description (continued)

• SSB transmission passband width setting

Command : 1A 050013, 050014, 050015

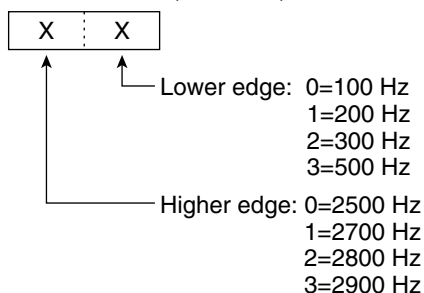

• Antenna memory setting

Command : 1A 050166, 050167, 050168, 050169,
050170, 050171, 050172, 050173,
050174, 050175, 050176, 050177

Data	Antenna selection	
	for TX	for RX
00	ANT1	
01	ANT2	
02	ANT3	
03	ANT4	
04*	ANT1	ANT4
05*	ANT2	ANT4
06*	ANT3	ANT4

**"RX" should be selected for ANT4.

• RIT frequency setting

Command : 21 00

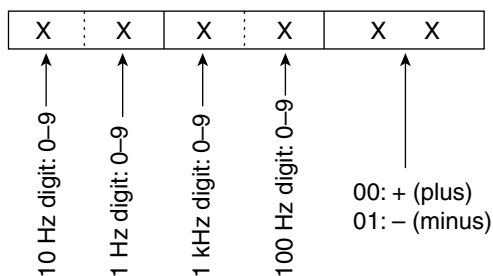

• Band edge frequency setting

Command : 02*, 1E 01, 1E 03

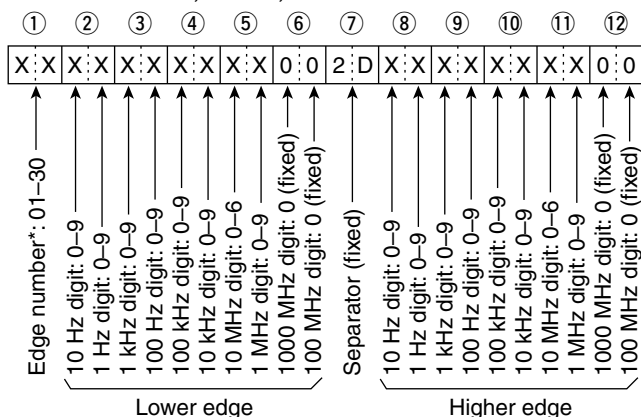

*Edge number setting is not necessary with command 02.

• Codes for CW message contents

To send CW messages, the following character codes are used.

Character	ASCII code	Character	ASCII code
0-9	30-39	'	27
A-Z	41-5A	(28
a-z	61-7A)	29
/	2F	=	3D
?	3F	+	2B
.	2E	"	22
-	2D	@	40
,	2C	Space	20
:	3A		

Command : 17 Up to 30 characters

- "FF" stops sending CW messages.
- "^" is used to transmit a string of characters with no inter-character space.

• **Memory contents setting**

Command : 1A 00

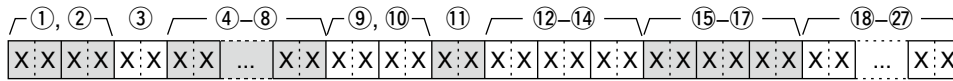

①, ② **Memory channel number**

0001–0099 : Memory channel 1 to 99

0100 : Programmed scan edge P1

0101 : Programmed scan edge P2

/// To clear the memory channel contents, add the code “FF” after the memory channel number. (instead of the data ③ to ㉗)

/// This completes the memory clearing.

③ **Select memory setting**

00 : OFF

01 : ★1

02 : ★2

03 : ★3

④–⑧ **Operating frequency setting**

See “• Operating frequency.”

⑨, ⑩ **Operating mode setting**

See “• Operating mode.”

⑪ **Data mode and tone type setting**

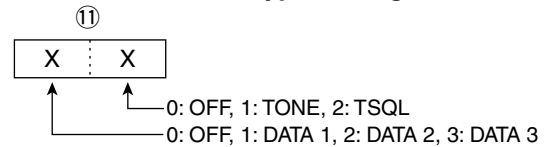

⑫–⑭ **Repeater tone frequency setting**

⑮–⑰ **Tone squelch frequency setting**

See “• Repeater tone/tone squelch setting.”

⑱–㉗ **Memory name setting**

Up to 10 characters.

See “• Codes for memory name, opening message and Clock 2 name contents.”

• **Codes for Network Radio name contents**

Command : 1A 050213

- *Character's code— Number*

Character	ASCII code	Character	ASCII code
0–9	30–39		

- *Character's code— Alphabetical characters*

Character	ASCII code	Character	ASCII code
A–Z	41–5A	a–z	61–7A

- *Character's code— Symbols*

Character	ASCII code	Character	ASCII code
!	21	#	23
\$	24	%	25
&	26	?	3F
”	22	'	27
`	60	^	5E
+	2B	–	2D
*	2A	/	2F
.	2E	,	2C
:	3A	;	3B
=	3D	<	3C
>	3E	(28
)	29	[5B
]	5D	{	7B
}	7D		7C
_	5F	-	7E
@	40		

14 CONTROL COMMAND

◇ Data contents description (continued)

• Main or Sub band's frequency settings

Command: 25

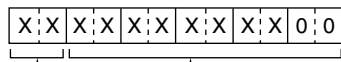

00: MAIN Operating frequency data
 01: SUB (See "Operating frequency" described on page 14-10.)

• Main or Sub band's operating mode and filter settings

Command: 26

Both data and filter settings can be skipped. In that case, "DATA OFF" and the default filter setting of the operating mode is automatically selected.

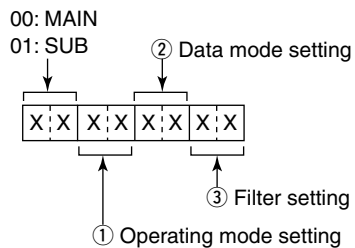

① Operating mode		② Data mode setting	③ Filter setting
00: LSB	05: FM	00: Data mode OFF	01: FIL1
01: USB	07: CW-R	01: Data mode 1 (D1)	02: FIL2
02: AM	08: RTTY-R	02: Data mode 2 (D2)	03: FIL3
03: CW	12: PSK	03: Data mode 3 (D3)	
04: RTTY	13: PSK-R		

■ Specifications	15-2
◇ General	15-2
◇ Transmitter	15-2
◇ Receiver	15-3
◇ Antenna tuner.....	15-3
■ Options	15-4

■ Specifications

◇ General

- **Frequency coverage** (unit: MHz) :
 - Receiver : 0.030000–60.000000*¹
 - Transmitter : 1.800000–1.999999*², 3.500000–3.999999*²,
5.255000 – 5.405000*^{1, 2}, 7.000000–7.300000*²,
10.100000–10.150000*², 14.000000–14.350000*²,
18.068000–18.168000*², 21.000000–21.450000*²,
24.890000–24.990000*², 28.000000–29.700000*²,
50.000000–54.000000*²
- *¹Some frequency ranges are not guaranteed.
- *²Depending on versions.
- **Operating mode** : J3E (USB/LSB), A1A (CW), F1B (RTTY),
G1B (PSK31), A3E (AM), F3E (FM)
- **Number of memory channels** : 101 (99 regular, 2 scan edges)
- **Antenna connector** : SO-239×4 (antenna impedance: 50 Ω)
- **Operating temperature range** : 0°C to +50°C; +32°F to +122°F
- **Frequency stability** : Less than ±0.05 ppm (approximately 5 min. after from
turn the main power, [I/O], ON, 0–50°C; 32–122°F)
- **Frequency resolution** : 1 Hz
- **Power supply requirement** : 85–265 V AC (universal input)
- **Power consumption** :
 - Power OFF : 10 VA typical
 - Stand-by : 200 VA typical
 - Receive : 210 VA typical
 - Stand-by : 800 VA
 - Max. audio : 800 VA
 - Transmit at 200 W : 800 VA
- **Dimensions** (projections not included) : 424×149×435 mm; 16¹¹/₁₆×57⁷/₈×17³/₁₆ in
- **Weight** : Approximately 25 kg; 55 lb
- **ACC 1 connectors** : 8-pin DIN connector×2
- **ACC 2 connectors** : 7-pin DIN connector×2
- **Display*** : 7-inch (diagonal) TFT color LCD (800×480)
- **EXT-DISPLAY connector** : D-sub 15S
- **CI-V connector** : 2-conductor 3.5 (d) mm (1/8")
- **RS-232C connector** : D-sub 9-pin
- **KEYBOARD connector** : USB

◇ Transmitter

- **Transmit output power** :
 - SSB, CW, RTTY, PSK31, FM : 5–200 W
 - AM : 5–50 W
 - 137 kHz band : More than –20 dBm (Except for USA and Korean versions)
- **Modulation system** :
 - SSB : D.P.S.N. modulation
 - AM : Digital low power modulation
 - FM : Digital phase modulation
- **Spurious emission** :
 - More than 60 dB (HF bands)
 - More than 70 dB (50 MHz band)
- **Carrier suppression** : More than 63 dB
- **Unwanted side-band suppression** : More than 80 dB
- **ΔTX variable range** : ±9.999 kHz
- **Microphone connector** : 8-pin connector (600 Ω)
- **ELEC-KEY connector** : 3-conductor 6.35 (d) mm (1/4")
- **KEY connector** : 3-conductor 6.35 (d) mm (1/4")
- **RELAY connector** : Phono (RCA)
- **ALC connector** : Phono (RCA)

◇ **Receiver**

- **Receive system** : Double conversion superheterodyne system
- **Intermediate frequencies** :
 - 1st 64.455 MHz (MAIN band)
 - 64.555 MHz (SUB band)
 - 2nd 36 kHz
- **Sensitivity** :
 - SSB, CW, RTTY (BW=2.4 kHz, 10 dB S/N)
 - 0.100–1.799 MHz 0.5 μV (pre-amp 1 ON)
 - 1.800–29.990 MHz 0.16 μV (pre-amp 1 ON)
 - 50.000–54.000 MHz 0.13 μV (pre-amp 2 ON)
 - AM (BW=6 kHz, 10 dB S/N)
 - 0.100–1.799 MHz 6.3 μV (pre-amp 1 ON)
 - 1.800–29.990 MHz 2 μV (pre-amp 1 ON)
 - 50.000–54.000 MHz 1 μV (pre-amp 2 ON)
 - FM (BW=15 kHz, 12 dB SINAD)
 - 28.000–29.990 MHz 0.5 μV (pre-amp 1 ON)
 - 50.000–54.000 MHz 0.32 μV (pre-amp 2 ON)
- **Selectivity** :
 - SSB, RTTY (BW=2.4 kHz)
 - More than 2.4 kHz/–3 dB
 - Less than 3.6 kHz/–60 dB
 - CW (BW=500 Hz)
 - More than 500 Hz/–3 dB
 - Less than 700 Hz/–60 dB
 - AM (BW=6 kHz)
 - More than 6.0 kHz/–3 dB
 - Less than 15.0 kHz/–60 dB
 - FM (BW=15 kHz)
 - More than 12.0 kHz/–6 dB
 - Less than 20.0 kHz/–60 dB
- **Spurious and image rejection ratio** : More than 70 dB (except IF through on 50 MHz band)
- **Squelch sensitivity** :
 - SSB, CW, RTTY, PSK31 Less than 5.6 μV
 - FM Less than 1 μV
- **RIT variable range** : ±9.999 kHz
- **Audio output power** : More than 2.6 W at 10% distortion with an 8 Ω load
- **PHONES connector** : 3-conductor 6.35 (d) mm (1/4")
- **EXT-SP connectors** : 2-conductor 3.5 (d) mm (1/8")/8 Ω×2 (for main and sub)

◇ **Antenna tuner**

- **Matching impedance range** : 16.7 to 150 Ω unbalanced (HF bands; VSWR better than 3:1)
20 to 125 Ω unbalanced (50 MHz band; VSWR better than 2.5:1)
- **Minimum operating input** : 8 W (HF bands)
15 W (50 MHz band)
- **Tuning accuracy** : VSWR 1.5:1 or less
- **Insertion loss (after tuning)** : Less than 1.0 dB

*The LCD display may have cosmetic imperfections that appear as small or dark spots. This is not a malfunction or defect, but a normal characteristic of LCD displays.

Spurious signals may be received near the following frequencies. These are made in the internal circuit and does not indicate a transceiver malfunction.

- 0.150 MHz • 10.490 MHz

Spurious waveforms may be displayed on the spectrum scope screen regardless of the transceiver's condition (Tx or Rx). They are made in the scope circuit. This does not indicate a transceiver malfunction.

All stated specifications are typical and subject to change without notice or obligation.

Options

IC-PW1/EURO HF/50 MHz ALL BAND 1 kW LINEAR AMPLIFIER



Full-duty-cycle 1 kW linear amplifier including an automatic antenna tuner. Has automatic tuning and band selection capability when used with an Icom transceiver. Full break-in (QSK) operation. The amplifier/power supply unit and the remote control unit are separate.

SP-34 EXTERNAL SPEAKER



4 audio filters; headphone jack; can connect to 2 transceivers.
 • Input impedance : 8 Ω
 • Max. input power : 5 W

SM-50 DESKTOP MICROPHONE



Unidirectional, dynamic microphone for base station operation. Includes [UP]/[DOWN] switches, a low cut switch and mic gain control.

SM-30 DESKTOP MICROPHONE



Unidirectional, electret microphone for base station operation. Includes a low cut switch and mic gain control.

CT-17 CI-V LEVEL CONVERTER



For remote transceiver control using a PC. You can change frequencies, operating mode, memory channels, etc. (software is not included)

HM-36 HAND MICROPHONE



Hand microphone equipped with [UP]/[DOWN] switches.

SP-33 EXTERNAL SPEAKER

Designed for base station operation.

- Input impedance : 8 Ω
- Max. input power : 5 W

RS-BA1 IP REMOTE CONTROL SOFTWARE

☐ To remotely control radios using the RS-BA1, **BE SURE** ☐ that you comply with your local regulations.

Approved Icom optional equipment is designed for optimal performance when used with an Icom transceiver.

Icom is not responsible for the destruction or damage to an Icom transceiver in the event the Icom transceiver is used with equipment that is not manufactured or approved by Icom.

■ General	16-2
■ Caution	16-2
■ Preparation	16-3
◇ Firmware and firm utility	16-3
◇ File downloading	16-3
■ Firmware update— Memory device	16-4
■ Firmware update— PC	16-6
◇ Connections	16-6
◇ IP address setting	16-7
◇ Updating from the PC	16-8

■ General

A memory card reader is required to copy the downloaded firmware file to a CS memory card. An Ethernet card/board (10 BASE-T/100 BASE TX compatible) is required when updating the firmware from the PC. Both memory card reader and Ethernet card/board are not supplied from Icom. Ask your PC dealer about a memory card reader and an Ethernet card/board for details.

The IC-7800's firmware can be updated, if desired. By updating the firmware, new function(s) can be added and the improvement of performance parameters can be made.

2 ways of firmware update are available; one is using the memory device, and the other is using a PC. You can choose either way according to your PC condition.

- When only one PC that is connected to internet is available.
 - ➔ Refer to ■ Preparation (p. 16-3) and ■ Firmware update— Memory device (p. 16-4)
- When one or more PCs that are connected to internet are available and they are connected to the LAN (Local Area Network)
 - ➔ Refer to ■ Preparation (p. 16-3) and either ■ Firmware update— PC (p. 16-6) or ■ Firmware update— Memory device (p. 16-4)

Ask your dealer or distributor about how to update the firmware if you have no PC.

■ Caution

CAUTION: NEVER turn the transceiver power OFF while updating the firmware.

You can turn the transceiver power OFF only when the transceiver displays that rebooting is required.

If you turn the transceiver power OFF, or if a power failure occurs during updating, the transceiver firmware will be damaged and you have to send the transceiver back to the nearest Icom distributor for repair. This type of repair is out of warranty even if the warranty period is still valid.

Recommendation!

Backing up the settings and/or memory contents to the memory device before starting the firmware update is recommended.

Settings and/or memory contents will be lost when the firmware update is performed.

■ Preparation

◇ Firmware and firm utility

The latest firmware and the firm utility can be downloaded from the Icom home page via the internet. Access the following URL to download the firm utility and the latest firmware.

<http://www.icom.co.jp/world/index.html>

For updating from the memory device

When updating the firmware from the memory device, copy the downloaded firmware data (example: 7800_300.dat) to the memory device (in "IC-7800" folder). Usable memory device are CF memory card and USB flash drive. When using a CF memory card, a memory card reader is required. (Purchase separately from your PC dealer).

◇ File downloading

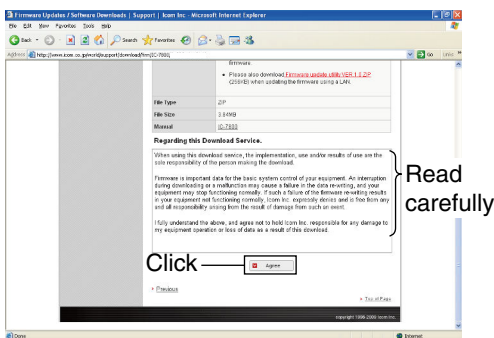

- ① Access the following URL.
<http://www.icom.co.jp/world/index.html>
- ② Click [Support] button.
- ③ Click "Firmware Updates/Software Downloads" link.
- ④ Click the desired firmware file link in IC-7800 group.
- ⑤ Read "Regarding this Download Service" carefully, then click [Agree].

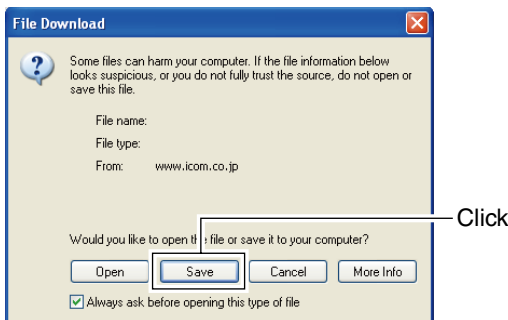

- ⑥ Click [Save] in the displayed File Download dialog.

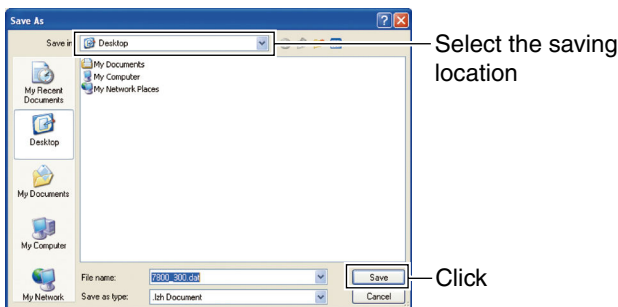

- ⑦ Select the desired location that you want to save the firmware to, then click [Save] in the displayed File Download dialog.
 - File download starts.
- ⑧ After download is completed, extract the file.
 - The firmware and the firm utility are compressed in "zip" format, respectively.
 - When updating the transceiver using with the memory device, copy the extracted firmware (example: 7800_300.dat) to the IC-7800 folder of the memory device.
 - The memory device must be formatted with the IC-7800.

Firmware update— Memory device

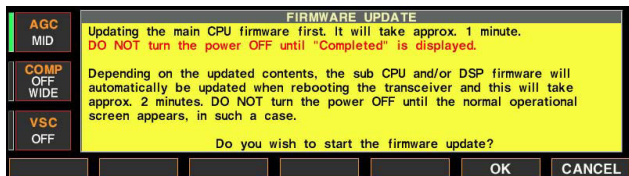
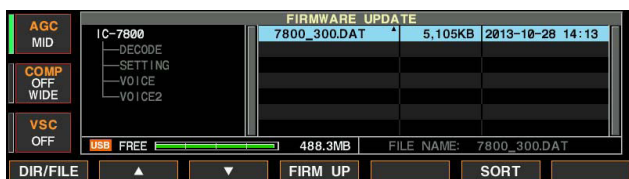
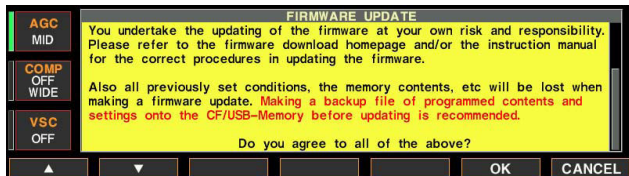
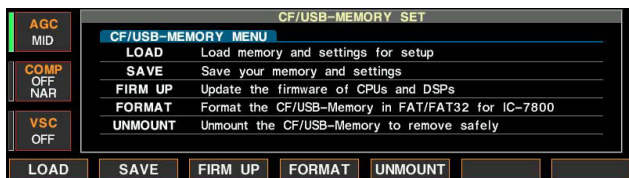
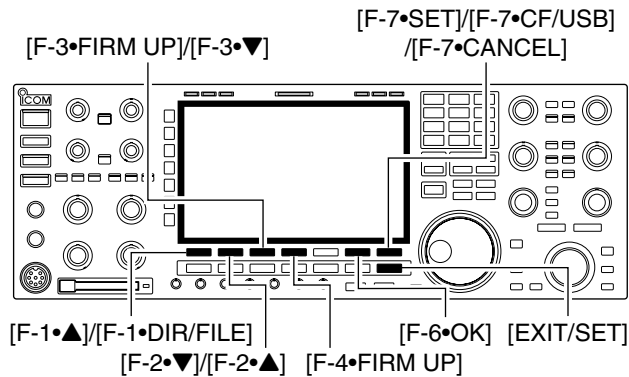

When updating the firmware using with the memory device, no IP address as well as subnet mask settings are necessary.

- Copy the downloaded firmware data into the memory device ("IC-7800" folder).
 - The memory device must be formatted by the IC-7800.
- Insert the CF memory card into the CF card slot or connect the USB flash drive to the [KEY BOARD].
- Push [EXIT/SET] several times to close a multi-function screen, if necessary.
- Push [F-7•SET] to select set mode menu screen.
- Push [F-7•CF/USB] to select the CF/USB-Memory set menu.

- Hold down [F-3•FIRM UP] for 1 second.

- Read the displayed precaution carefully.
 - Push [F-1•▲] or [F-2•▼] to scroll the indication.
 - Push [F-7•CANCEL] to cancel the firmware updating.

- After you read and agree to all of the precautions, push [F-6•OK].
 - [F-6•OK] appears only when the end of the precaution is displayed.
 - Push [F-7•CANCEL] to cancel the firmware updating.
- Hold down [F-3•DIR/FILE] to select the memory device.
- Push [F-2•▲] or [F-3•▼] to select the firmware file, then push [F-4•FIRM UP].

- Read the displayed precaution carefully.
- If you agree, hold down [F-6•OK] for 1 second to start the firmware update.
 - Push [F-7•CANCEL] to cancel the firmware updating.

- While loading the firmware from the memory device, the dialog as at left is displayed.

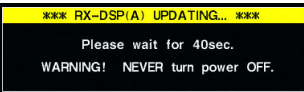
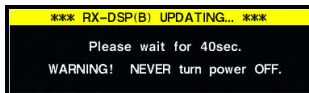
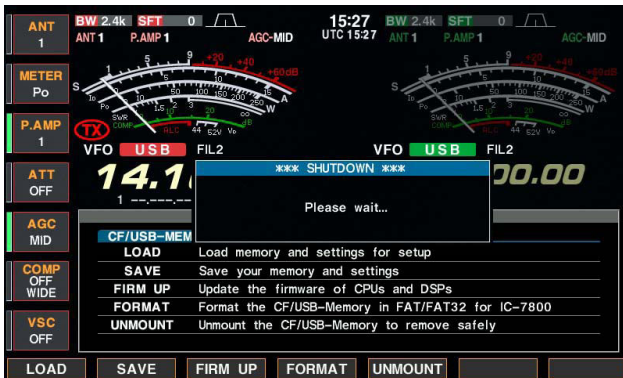
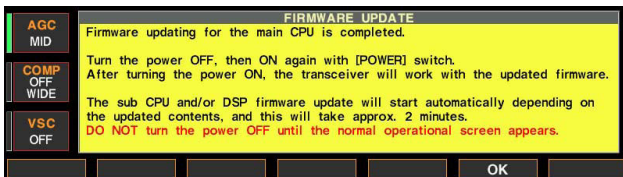
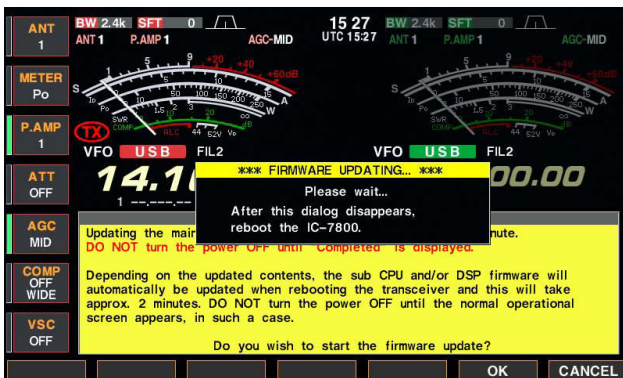

⑬ After the firmware loading is completed, the transceiver starts the update automatically and the dialog as at left is displayed.

⚠ **WARNING! NEVER** turn the IC-7800 power OFF at this stage.
 The transceiver firmware will be damaged.

⑭ When the dialog disappears, the precaution as at left is displayed.

⑮ Read the precaution carefully, and then push [F-6•OK].
 • Return to CF/USB-Memory set menu.

⑯ Push [POWER] to turn the IC-7800 power OFF, then ON again.

⑰ Depending on the updating, one to four dialog as at left appears in sequence.

⚠ **WARNING! NEVER** turn the IC-7800 power OFF at this stage.
 The transceiver firmware will be damaged.

⑱ After the dialog disappears, the firmware updating is completed and normal operation screen appears.

■ Firmware update— PC

◇ Connections

Connect the IC-7800 and the PC through a LAN (Local Area Network) as follows.

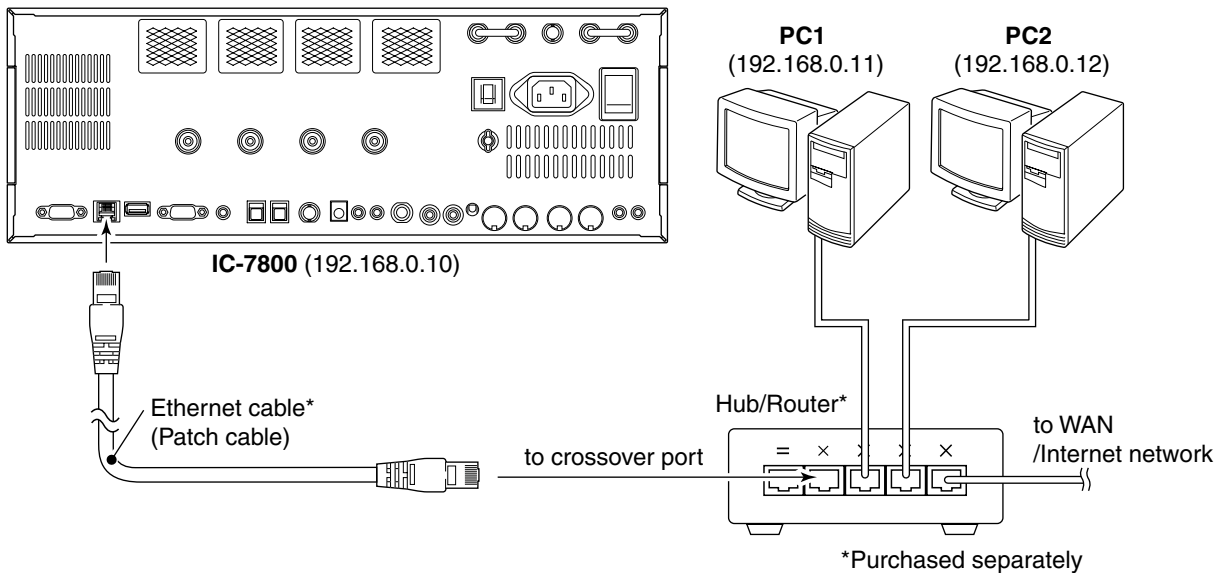

• IP address setting example

	PC1	PC2	IC-7800
IP address	192.168.0.11	192.168.0.12	192.168.0.10
Subnet mask	255.255.255.0	255.255.255.0	255.255.255.0

◇ IP address setting

When updating the firmware from the memory device, the following settings are not necessary.

IMPORTANT! A fixed (static) IP address is used for the IC-7800.
 When you connect the IC-7800 to a LAN, ask the network manager about a usable/assignable IP address and the subnet mask in advance.
NEVER set the IP address that has already been used with another device in the network. If the IP address is duplicated, the network will crash down.

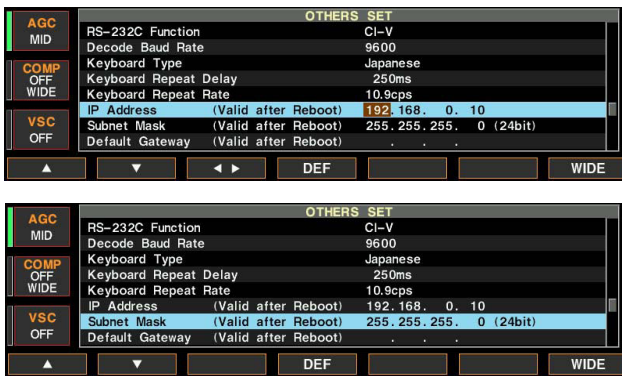
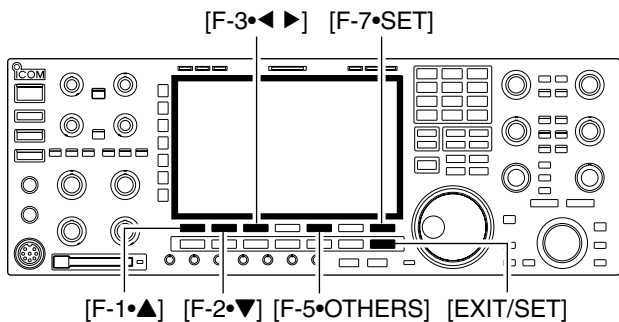

- ① Push [EXIT/SET] several times to close a multi-function screen, if necessary.
- ② Push [F-7•SET] to select set mode menu screen.
- ③ Push [F-5•OTHERS] to select the Others set mode.
- ④ Push [F-1•▲]/[F-2•▼] several times to select "IP Address" item.
- ⑤ Push [F-3•◀▶] to select the desired part then rotate main dial to set the desired or specified IP address.
 - "192.168.0.10" is the default setting.
- ⑥ Push [F-2•▼] to select "Subnet Mask" item.
- ⑦ Rotate main dial to set the desired or specified subnet mask.
 - "255.255.255.0" is the default setting.
- ⑧ Push [POWER] to turn the transceiver power OFF, then ON to effect the IP address and subnet mask settings.

◇ Updating from the PC



- ① Start up the IC-7800 Firm Utility.
 - The window as at left appears.
- ② Read the caution in the window carefully.
- ③ Click [Yes] if you agree and continue the firmware updating.

The IC-7800 Firm Utility corresponds to the following operating systems:

- Microsoft® Windows® 98/SE
- Microsoft® Windows® ME
- Microsoft® Windows® 2000
- Microsoft® Windows® XP
- Microsoft® Windows Vista®
- Microsoft® Windows® 7
- Microsoft® Windows® 8
- Microsoft® Windows® 8.1

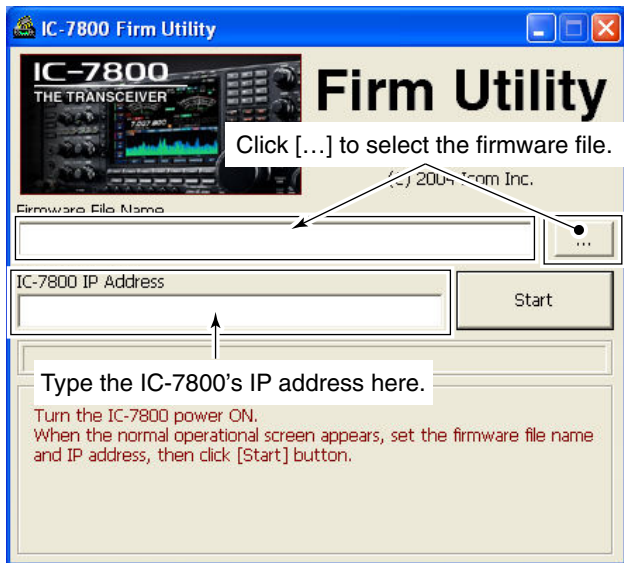

- ④ Select the firmware file, that has “dat” extension (example: 7800_300.dat).
 - Click [...], then select the file, as well as the location.
- ⑤ Type the IC-7800’s IP address into “IC-7800 IP Address” text box (example: 192.168.0.10).
- ⑥ Click [Start].

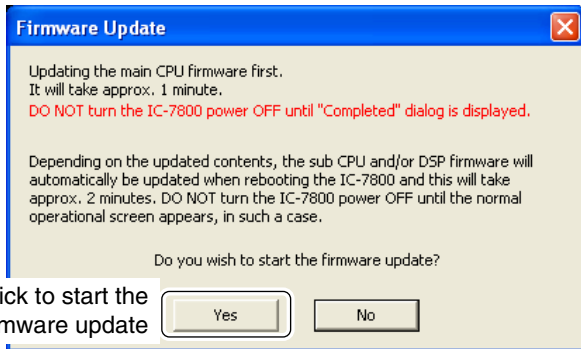

- ⑦ The window as at left appears.
 - Read the precaution in the window carefully.
- ⑧ Click [Yes] if you want to start the firmware update.



- ⑨ The screen as at left is displayed.
 - The following dialog appears in the IC-7800 display.



⚠ **WARNING! NEVER** turn the IC-7800 power OFF at this stage. The transceiver firmware will be damaged.

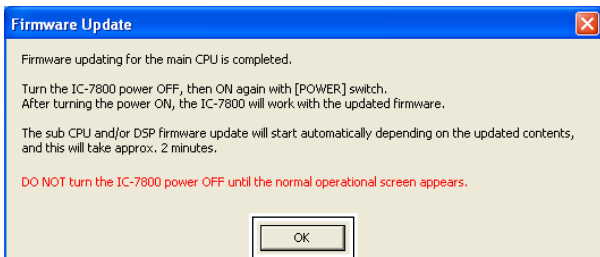

Click [OK] to finish the firmware update.

- ⑩ Click [OK] to finish the firmware update.
 - The “FIRMWARE UPDATING” dialog as above disappears.
- ⑪ Push [POWER] to turn the IC-7800 power OFF, then ON again.

*** SCOPE-DSP UPDATING... ***
 Please wait for 40sec.
 WARNING! NEVER turn power OFF.

*** RX-DSP(B) UPDATING... ***
 Please wait for 40sec.
 WARNING! NEVER turn power OFF.

*** RX-DSP(A) UPDATING... ***
 Please wait for 40sec.
 WARNING! NEVER turn power OFF.

*** TX-DSP UPDATING... ***
 Please wait for 40sec.
 WARNING! NEVER turn power OFF.

- ⑫ Depending on the updating, one to four dialogs as at left appears in the IC-7800 display in sequence.

⚠ **WARNING! NEVER** turn the IC-7800 power OFF at this stage.
 The transceiver firmware will be damaged.

- ⑬ After the dialog disappears, the firmware updating is completed and normal operation screen appears.

INSTALLATION NOTES

For amateur base station installations it is recommended that the forwards clearance in front of the antenna array is calculated relative to the EIRP (Effective Isotropic Radiated Power). The clearance height below the antenna array can be determined in most cases from the RF power at the antenna input terminals.

Different exposure limits have been recommended for different frequencies, a relative table shows a guideline for installation considerations.

Below 30 MHz, the recommended limits are specified in terms of V/m or A/m fields as they are likely to fall within the near-field region. Similarly, the antennas may be physically short in terms of electrical length and that the installation will require some antenna matching device which can create local, high intensity magnetic fields. Analysis of such installations is best considered in association with published guidance notes such as the FCC OET Bulletin 65 Edition 97-01 and its annexes relative to amateur transmitter installations. The EC recommended limits are almost identical to the FCC specified 'uncontrolled' limits and tables exist that show pre-calculated safe distances for different antenna types for different frequency bands. Further information can be found at <http://www.arrl.org/>.

• Typical amateur radio installation

Exposure distance assumes that the predominant radiation pattern is forward and that radiation vertically downward is at unity gain (sidelobe suppression is equal to main lobe gain). This is true of almost every gain antenna today. Exposed persons are assumed to be beneath the antenna array and have a typical height of 1.8 m.

The figures assume the worst-case emission of constant carrier.

For the bands 10 MHz and higher the following power density limits have been recommended:

10–144 MHz 2 W/sq m

EIRP clearance heights by frequency band

1 Watts	2.1 m
10 Watts	2.8 m
25 Watts	3.4 m
100 Watts	5 m
1000 Watts	12 m

Forward clearance, EIRP by frequency band

100 Watts	2 m
1000 Watts	6.5 m
10,000 Watts	20 m
100,000 Watts	65 m

In all cases any possible risk depends on the transmitter being activated for long periods. (actual recommendation limits are specified as an average during 6 minutes) Normally the transmitter is not active for long periods of time. Some radio licenses will require that a timer circuit automatically cuts the transmitter after 1–2 minutes etc.

Similarly some types of emission, i.e., SSB, CW, AM etc. have a lower 'average' output power and the assessed risk is even lower.



Versions of the IC-7800 which display the "CE" symbol on the serial number label, comply with the essential requirements of the Radio and Telecommunications Terminal Equipment Directive, 1999/5/EC, and the restriction of the use of certain hazardous substances in electrical and electronic equipment Directive, 2011/65/EU.





This warning symbol indicates that this equipment operates in non-harmonised frequency bands and/or may be subject to licensing conditions in the country of use. Be sure to check that you have the correct version of this radio or the correct programming of this radio, to comply with national licensing requirement.

• List of Country codes (ISO 3166-1)

	Country	Codes		Country	Codes
1	Austria	AT	18	Liechtenstein	LI
2	Belgium	BE	19	Lithuania	LT
3	Bulgaria	BG	20	Luxembourg	LU
4	Croatia	HR	21	Malta	MT
5	Czech Republic	CZ	22	Netherlands	NL
6	Cyprus	CY	23	Norway	NO
7	Denmark	DK	24	Poland	PL
8	Estonia	EE	25	Portugal	PT
9	Finland	FI	26	Romania	RO
10	France	FR	27	Slovakia	SK
11	Germany	DE	28	Slovenia	SI
12	Greece	GR	29	Spain	ES
13	Hungary	HU	30	Sweden	SE
14	Iceland	IS	31	Switzerland	CH
15	Ireland	IE	32	Turkey	TR
16	Italy	IT	33	United Kingdom	GB
17	Latvia	LV			

ABOUT CE

	DECLARATION OF CONFORMITY
<p>We Icom Inc. Japan 1-1-32, Kamiminami, Hirano-ku, Osaka 547-0003, Japan</p>	
Kind of equipment: HF/50 MHz ALL MODE TRANSCEIVER	RoHS Directive
Type-designation: IC-7800	Declare on our sole responsibility that this equipment complies with the restriction of the use of certain hazardous substances in electrical and electronic equipment Directive, 2011/65/EU.
R&TTE Directive	Bad Soden 19th June 2013
Declare on our sole responsibility that this equipment complies with the essential requirements of the Radio and Telecommunications Terminal Equipment Directive, 1999/5/EC, and that any applicable Essential Test Suite measurements have been performed.	Place and date of issue Icom (Europe) GmbH Communication Equipment Auf der Krautweide 24, 65812 Bad Soden am Taunus, Germany
Version (where applicable):	Authorized representative name Y. Furukawa General Manager
This compliance is based on conformity with the following harmonised standards, specifications or documents:	
i) EN 60950-1:2006/A1:2010	Signature
ii) EN 301 489-1 V1.9.2 (2011-09)	Icom Inc.
iii) EN 301 489-15 V1.2.1 (2002-08)	
iv) EN 301 783-2 V1.2.1 (2010-07)	
v) EN 62311:2008	
vi) _____	

DISPOSAL



The crossed-out wheeled-bin symbol on your product, literature, or packaging reminds you that in the European Union, all electrical and electronic products, batteries, and accumulators (rechargeable batteries) must be taken to designated collection locations at the end of their working life. Do not dispose of these products as unsorted municipal waste. Dispose of them according to the laws in your area.

Please record the serial number of your IC-7800 transceiver below for future servicing reference:

Serial Number : _____

Date of purchase : _____

Place where purchased : _____

Count on us!

IC-7800
#03 (Europe)

<Intended Country of Use>	
<input checked="" type="checkbox"/>	AT
<input checked="" type="checkbox"/>	BE
<input checked="" type="checkbox"/>	CY
<input checked="" type="checkbox"/>	CZ
<input checked="" type="checkbox"/>	DK
<input checked="" type="checkbox"/>	EE
<input checked="" type="checkbox"/>	FI
<input type="checkbox"/>	FR
<input checked="" type="checkbox"/>	DE
<input checked="" type="checkbox"/>	GR
<input checked="" type="checkbox"/>	HU
<input type="checkbox"/>	IE
<input type="checkbox"/>	IT
<input checked="" type="checkbox"/>	LV
<input checked="" type="checkbox"/>	LT
<input checked="" type="checkbox"/>	LU
<input checked="" type="checkbox"/>	MT
<input checked="" type="checkbox"/>	NL
<input checked="" type="checkbox"/>	PL
<input checked="" type="checkbox"/>	PT
<input checked="" type="checkbox"/>	SK
<input checked="" type="checkbox"/>	SI
<input type="checkbox"/>	ES
<input checked="" type="checkbox"/>	SE
<input type="checkbox"/>	GB
<input checked="" type="checkbox"/>	IS
<input checked="" type="checkbox"/>	LI
<input checked="" type="checkbox"/>	NO
<input checked="" type="checkbox"/>	CH
<input checked="" type="checkbox"/>	BG
<input checked="" type="checkbox"/>	RO
<input checked="" type="checkbox"/>	TR
<input checked="" type="checkbox"/>	HR

IC-7800
#04 (France)

<Intended Country of Use>	
<input type="checkbox"/>	AT
<input type="checkbox"/>	BE
<input type="checkbox"/>	CY
<input type="checkbox"/>	CZ
<input type="checkbox"/>	DK
<input type="checkbox"/>	EE
<input type="checkbox"/>	FI
<input checked="" type="checkbox"/>	FR
<input type="checkbox"/>	DE
<input type="checkbox"/>	GR
<input type="checkbox"/>	HU
<input type="checkbox"/>	IE
<input type="checkbox"/>	IT
<input type="checkbox"/>	LV
<input type="checkbox"/>	LT
<input type="checkbox"/>	LU
<input type="checkbox"/>	MT
<input type="checkbox"/>	NL
<input type="checkbox"/>	PL
<input type="checkbox"/>	PT
<input type="checkbox"/>	SK
<input type="checkbox"/>	SI
<input type="checkbox"/>	ES
<input type="checkbox"/>	SE
<input type="checkbox"/>	GB
<input type="checkbox"/>	IS
<input type="checkbox"/>	LI
<input type="checkbox"/>	NO
<input type="checkbox"/>	CH
<input type="checkbox"/>	BG
<input type="checkbox"/>	RO
<input type="checkbox"/>	TR
<input type="checkbox"/>	HR

IC-7800
#06 (Italy)

<Intended Country of Use>	
<input type="checkbox"/>	AT
<input type="checkbox"/>	BE
<input type="checkbox"/>	CY
<input type="checkbox"/>	CZ
<input type="checkbox"/>	DK
<input type="checkbox"/>	EE
<input type="checkbox"/>	FI
<input type="checkbox"/>	FR
<input type="checkbox"/>	DE
<input type="checkbox"/>	GR
<input type="checkbox"/>	HU
<input type="checkbox"/>	IE
<input checked="" type="checkbox"/>	IT
<input type="checkbox"/>	LV
<input type="checkbox"/>	LT
<input type="checkbox"/>	LU
<input type="checkbox"/>	MT
<input type="checkbox"/>	NL
<input type="checkbox"/>	PL
<input type="checkbox"/>	PT
<input type="checkbox"/>	SK
<input type="checkbox"/>	SI
<input type="checkbox"/>	ES
<input type="checkbox"/>	SE
<input type="checkbox"/>	GB
<input type="checkbox"/>	IS
<input type="checkbox"/>	LI
<input type="checkbox"/>	NO
<input type="checkbox"/>	CH
<input type="checkbox"/>	BG
<input type="checkbox"/>	RO
<input type="checkbox"/>	TR
<input type="checkbox"/>	HR

IC-7800
#08 (Spain)

<Intended Country of Use>	
<input type="checkbox"/>	AT
<input type="checkbox"/>	BE
<input type="checkbox"/>	CY
<input type="checkbox"/>	CZ
<input type="checkbox"/>	DK
<input type="checkbox"/>	EE
<input type="checkbox"/>	FI
<input type="checkbox"/>	FR
<input type="checkbox"/>	DE
<input type="checkbox"/>	GR
<input type="checkbox"/>	HU
<input type="checkbox"/>	IE
<input type="checkbox"/>	IT
<input type="checkbox"/>	LV
<input type="checkbox"/>	LT
<input type="checkbox"/>	LU
<input type="checkbox"/>	MT
<input type="checkbox"/>	NL
<input type="checkbox"/>	PL
<input type="checkbox"/>	PT
<input type="checkbox"/>	SK
<input type="checkbox"/>	SI
<input checked="" type="checkbox"/>	ES
<input type="checkbox"/>	SE
<input type="checkbox"/>	GB
<input type="checkbox"/>	IS
<input type="checkbox"/>	LI
<input type="checkbox"/>	NO
<input type="checkbox"/>	CH
<input type="checkbox"/>	BG
<input type="checkbox"/>	RO
<input type="checkbox"/>	TR
<input type="checkbox"/>	HR

IC-7800
#10 (United Kingdom)

<Intended Country of Use>	
<input type="checkbox"/>	AT
<input type="checkbox"/>	BE
<input type="checkbox"/>	CY
<input type="checkbox"/>	CZ
<input type="checkbox"/>	DK
<input type="checkbox"/>	EE
<input type="checkbox"/>	FI
<input type="checkbox"/>	FR
<input type="checkbox"/>	DE
<input type="checkbox"/>	GR
<input type="checkbox"/>	HU
<input checked="" type="checkbox"/>	IE
<input type="checkbox"/>	IT
<input type="checkbox"/>	LV
<input type="checkbox"/>	LT
<input type="checkbox"/>	LU
<input type="checkbox"/>	MT
<input type="checkbox"/>	NL
<input type="checkbox"/>	PL
<input type="checkbox"/>	PT
<input type="checkbox"/>	SK
<input type="checkbox"/>	SI
<input type="checkbox"/>	ES
<input type="checkbox"/>	SE
<input checked="" type="checkbox"/>	GB
<input type="checkbox"/>	IS
<input type="checkbox"/>	LI
<input type="checkbox"/>	NO
<input type="checkbox"/>	CH
<input type="checkbox"/>	BG
<input type="checkbox"/>	RO
<input type="checkbox"/>	TR
<input type="checkbox"/>	HR

Icom Inc.

1-1-32 Kamiminami, Hirano-ku, Osaka 547-0003, Japan