



SERVICE MANUAL

FM TRANSCEIVERS

IC-V85
IC-V85-T
IC-V85E

S-14315XZ-C1
Jan. 2007

Icom Inc.

INTRODUCTION

This service manual describes the latest service information for the **IC-V85**, **IC-V85E** and **IC-V85-T** FM TRANSCEIVERS at the time of publication.

MODEL	VERSION	SYMBOL
IC-V85	U.S.A.	[USA]
		[USA-2]
	Export	[EXP]
		[EXP-2]
		[EXP-3]
	Taiwan	[TPE]
[TPE-2]		
Korea	[KOR]	
IC-V85E	Europe	[EUR]
		[EUR-1]
	U.K.	[UK]
IC-V85-T	Thailand	[THA]

To upgrade quality, any electrical or mechanical parts and internal circuits are subject to change without notice or obligation.

CAUTION

NEVER connect the transceiver to an AC outlet or to a DC power supply that uses more than 8 V. This will ruin the transceiver.

DO NOT expose the transceiver to rain, snow or any liquids.

DO NOT reverse the polarities of the power supply when connecting the transceiver.

DO NOT apply an RF signal of more than 20 dBm (100 mW) to the antenna connector. This could damage the transceiver's front end.

ORDERING PARTS

Be sure to include the following four points when ordering replacement parts:

1. 10-digit Icom parts numbers
2. Component part number and name
3. Equipment model name and unit name
4. Quantity required

<SAMPLE ORDER>

1110003491	S.IC	TA31136FNG	IC-V85	RF UNIT	5 pieces
8820001210	Screw	2438 screw	IC-V85	Top cover	10 pieces

Addresses are provided on the inside back cover for your convenience.



REPAIR NOTES

1. Make sure a problem is internal before disassembling the transceiver.
2. **DO NOT** open the transceiver until the transceiver is disconnected from its power source.
3. **DO NOT** force any of the variable components. Turn them slowly and smoothly.
4. **DO NOT** short any circuits or electronic parts. An insulated tuning tool **MUST** be used for all adjustments.
5. **DO NOT** keep power ON for a long time when the transceiver is defective.
6. **DO NOT** transmit power into a signal generator or a sweep generator.
7. **ALWAYS** connect a 50 dB to 60 dB attenuator between the transceiver and a deviation meter or spectrum analyzer when using such test equipment.
8. **READ** the instructions of test equipment thoroughly before connecting equipment to the transceiver.

CONTENTS

SECTION 1	SPECIFICATIONS	
SECTION 2	INSIDE VIEWS	
SECTION 3	DISASSEMBLY INSTRUCTION	
SECTION 4	CIRCUIT DESCRIPITON	
4-1	RECEIVER CIRCUITS.....	4-1
4-2	TRANSMITTER CIRCUITS.....	4-2
4-3	FREQUENCY SYNTHESIZER CIRCUITS.....	4-3
4-4	POWER SUPPLY CIRCUITS.....	4-4
4-5	PORT ALLOCATIONS.....	4-4
SECTION 5	ADJUSTMENT PROCEDURES	
SECTION 6	PARTS LIST	
SECTION 7	MECHANICAL PARTS AND DISASSEMBLY	
SECTION 8	SEMICONDUCTOR INFORMATION	
SECTION 9	BOARD LAYOUTS	
SECTION 10	BLOCK DIAGRAM	
SECTION 11	VOLTAGE DIAGRAM	
11-1	LOGIC UNIT.....	11-1
11-2	RF UNIT.....	11-2
SECTION 12	UT-108 (Optional product)	

GENERAL

• Frequency coverage	: TX: 144–148 MHz/RX: 136–174 MHz* ¹ (USA) TX: 144–146 MHz/RX: 136–174 MHz* ² (Europe, UK) TX/RX: 144–146 MHz (Taiwan, Thailand, Korea) TX/RX: 136–174 MHz* (General; LM) * ¹ ; Guaranteed: 144–148 MHz range only * ² ; Guaranteed: 144–146 MHz range only
• Type of emission	: FM
• Number of memory channels	: 107 (incl. 6 scan edges and 1 call)
• Frequency resolution	: 5, 10, 12.5, 15, 20, 25, 30, 50 kHz
• Antenna connector	: BNC (50 Ω)
• Operating temperature range	: –10°C to +60°C; +14°F to +140°F
• Frequency stability	: ±2.5 ppm (–10°C to +60°C; +14°F to +140°F)
• Power supply requirement (negative ground)	: Specified Icom's battery pack or 11.0 V ±15% external DC power
• Current drain (at 7.2 V DC ; approx.)	: Receiving 80 mA (standby) 30 mA (power save) 250 mA (max. audio) Transmitting 2.6 A (at 7 W) 2.0 A (at 4 W) 1.0 A (at 0.5 W)
• Dimensions (Projections not included)	: 56(W)×110(H)×34.4(D) mm; 2 7/32(W)×4 11/32(H)×1 11/32(D) in. (with BP-227)
• Weight (approx.)	: 310 g; 12.5 oz. (with BP-227 and antenna) 165 g; 5.8 oz (without battery pack and antenna)

TRANSMITTER

• Output power (at 7.2 V DC)	: 5.5 W (High)/4 W (Middle)/0.5 W (Low) [Thailand] 7 W (High)/4 W (Middle)/0.5 W (Low) [Others]
• Modulation system	: Variable reactance frequency modulation
• Maximum frequency deviation	: ±5.0 kHz
• Spurious emissions	: Less than –60 dBc
• Microphone connector	: 3-conductor 2.5 (d) mm (1/10")/2.2 kΩ

RECEIVER

• Receive system	: Double conversion superheterodyne
• Intermediate frequencies	: 1st: 46.35 MHz, 2nd: 450 kHz
• Sensitivity	: Less than 0.2 μV (at 12 dB SINAD)
• Squelch sensitivity	: Less than 0.16 μV (at threshold)
• Selectivity	: More than 55 dB
• Spurious and image rejection	: More than 60 dB
• Intermodulation	: More than 55 dB
• Audio output power (at 7.2 V DC)	: More than 0.3 W at 10% distortion with an 8 Ω load
• External speaker connector	: 3-conductor 3.5 (d) mm (1/8")/8 Ω

All stated specifications are subject to change without notice or obligation.

• LOGIC UNIT

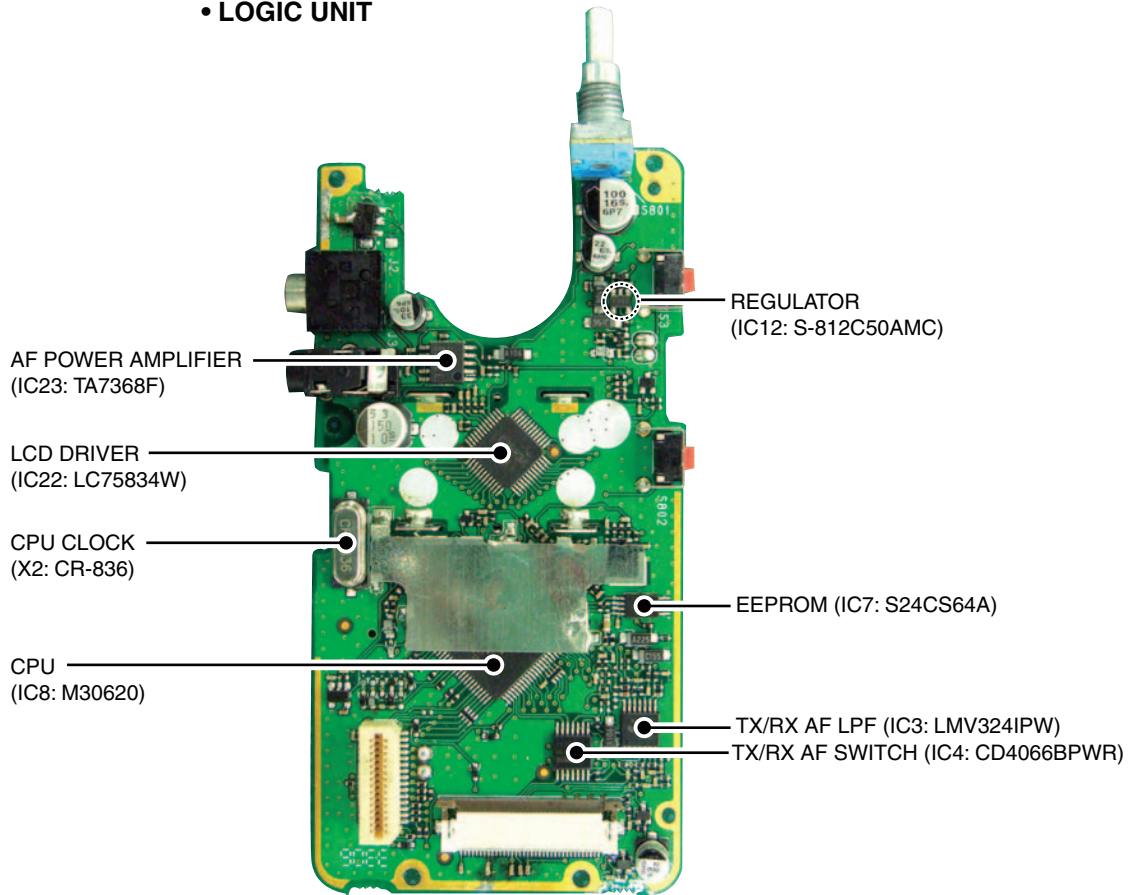

• RF UNIT (TOP VIEW)

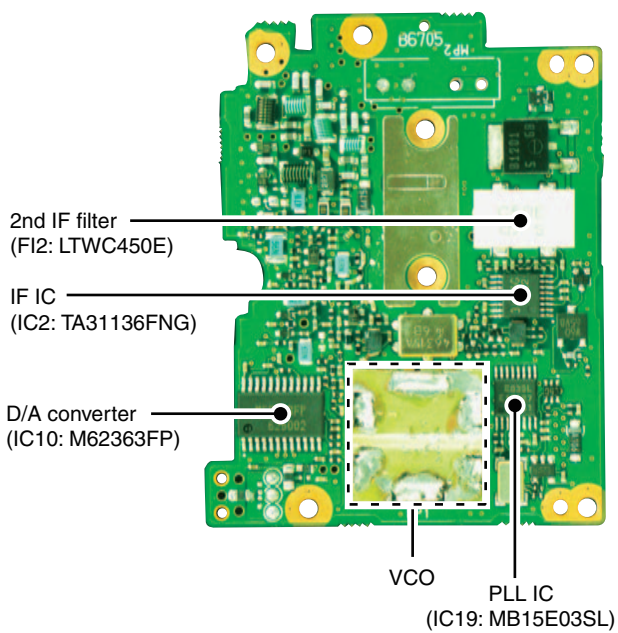

• RF UNIT (BOTTOM VIEW)

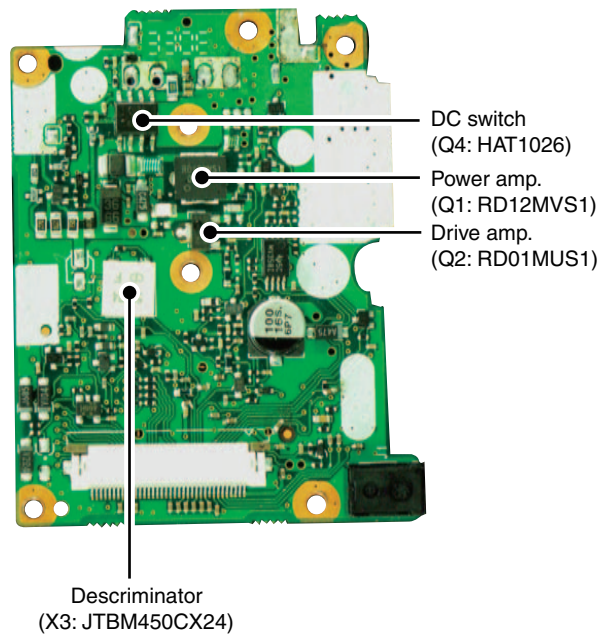

SECTION 3 DISASSEMBLY INSTRUCTION

1. Removing the front panel

- 1 Remove the knob (A) and jack cap (B).
- 2 Unscrew the Antenna nut and 4 screws (C) and (D).
- 3 Disconnect the speaker connector.
- 4 Take off the chassis in the direction of the arrow.

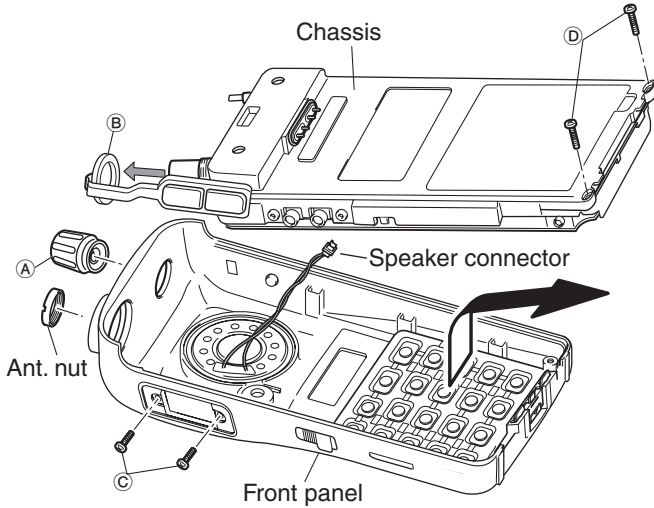

3. Removing shield plate

- 1 Unscrew 2 screws (A).
- 2 Unsolder 2 points (B), and remove the shield plate from the RF UNIT.

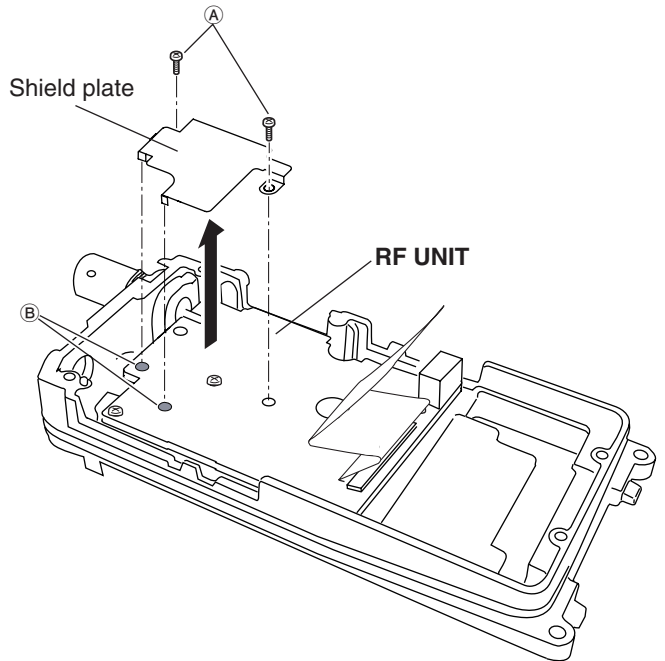

2. Removing the LOGIC UNIT

- 1 Remove the rubber seal and dial nut.
- 2 Unscrew 5 screws (A).
- 3 Disconnect the flat cable from J7.
- 4 Remove the LOGIC UNIT from the chassis in the direction of the arrow.

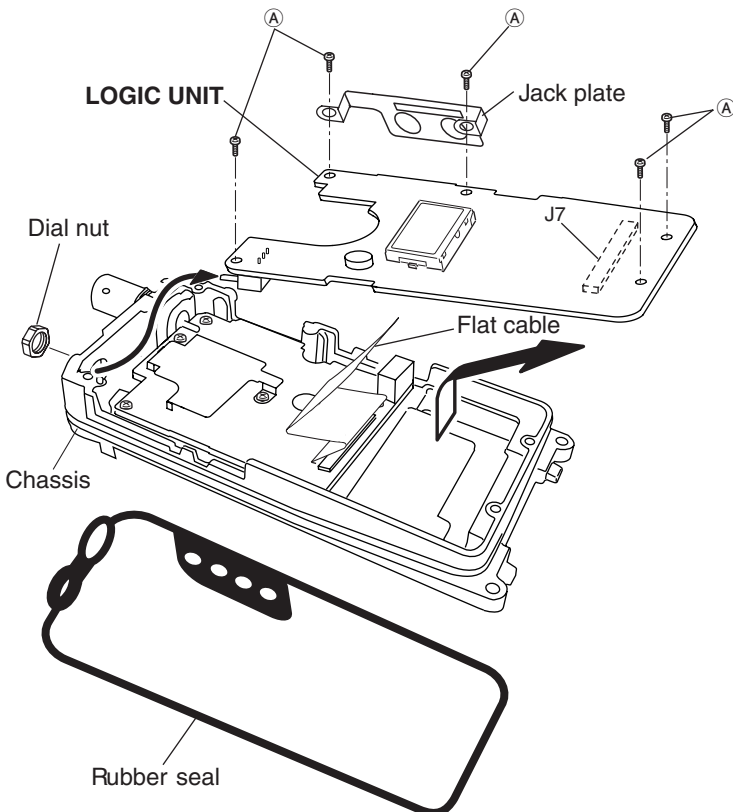

4. Removing the RF UNIT

- 1 Unscrew 5 screws (A).
- 2 Unsolder 4 points (B) (contact spring).
- 3 Unsolder 1 point (C) (antenna connector), and remove the RF UNIT from the chassis.

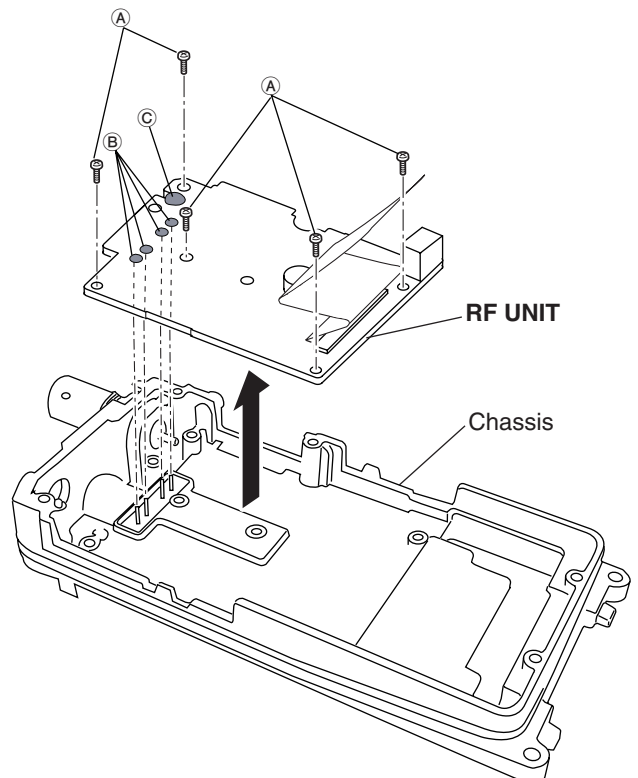

4-1 RECEIVER CIRCUITS

• ANTENNA SWITCHING

The antenna switching circuit toggles the receive (RX) line and transmit (TX) line.

The received signals from the antenna are passed through a two-staged Low-Loss Filter (LPF; L1, L2, C1–C5) and then applied to the antenna switch (D1, D2, D8, L15, L58, C52, C76, C516).

While transmitting, the voltage on the T5V line is applied to D1, D2 and D8, and these are ON. Thus the TX line is connected to the antenna. Simultaneously, the RX line is connected to the GND to prevent transmit signal entering.

While receiving, no voltage is applied to the D1, D2 and D8, and these are OFF. Thus the TX line and the antenna is disconnected to prevent received signals entering. Simultaneously, the RX line is disconnected from the GND and the received signals are passed through the LPF (L15, L58, C52, C76, C516).

The filtered signals are applied to the RF circuits.

• RF CIRCUITS (RF UNIT)

RF circuits filter and amplify the received signals within the frequency coverage.

The received signals from the antenna switch are passed through a tuned Bandpass filter (BPF; D9, L16, C81) and applied to the RF amplifier (Q12) that received signals are amplified in low NF rate.

The pass band frequency of the tuned BPF (D9, L16, C81) is adjusted by the tuning voltage “T1” from the D/A converter (IC10, pin 2), to suppress unwanted signals for high selectivity.

The amplified received signals are passed through the tuned BPF (D11, D12, L18, C92, C94, C96, C502), limiter (D72) and the tuned BPF (D65, L57, C505, C507), then applied to the 1st mixer (Q13).

• 1ST IF CIRCUITS (RF UNIT)

The received signals are converted into the 1st IF signal, filtered and amplified at the 1st IF circuits.

The signals from the RF circuits are applied to the 1st mixer

(Q13) and converted into the fixed frequency of 1st IF signal by mixing with the 1st Local Oscillator (LO) signals from the VCO (Q76, D59–D61). By changing the 1st LO frequency, only the desired frequency will pass through a pair of crystal filters at the next stage of the mixer. By changing LO frequency, the frequency of the 1st IF signal is fixed one for the receiving frequency.

The converted 1st IF signal is passed through the BPF (F11) and limiter (D63), then amplified by the 1st IF amplifier (Q14). The amplified 1st IF signal is applied to the IF IC (IC2, pin 16).

• 2ND IF CIRCUITS (RF UNIT)

The 1st IF signal is converted into the 2nd IF signal and demodulated.

The 1st IF signal from the 1st IF circuits are converted into the 2nd IF signal at the 2nd mixer section of the IF IC (IC2), by mixing with the 2nd LO signal which is generated at the reference frequency oscillator (X4) after being passed through the PLL IC (IC19, pins 1, 2) and the tripler (Q81).

The converted 2nd IF signal is output from pin 3 and passed through the BPF (F12) to remove the sideband noise, then applied to the 2nd IF amplifier section in IC2 (pin 5). The amplified 2nd IF signal is then applied to the FM-detector section. The demodulated AF signals are output from pin 9 and applied to the AF circuits.

• AF CIRCUITS (LOGIC UNIT)

The demodulated AF signals from the IF IC are amplified and filtered at the AF circuits.

AF signals from the 2nd IF circuits are passed through the the HPF (IC3, pins 6, 7), and LPF (IC3, pins 13, 14) via the TX/RX AF switches (IC4, pins 1, 2; 10, 11). The switched AF signals are passed through the D/A converter (RF UNIT; IC10, pins 11, 12) for audio level adjustment.

The D/A converter is a level controller IC which adjusts AF signal level according to the control signals (“DATA,” “STROBE,” “CLOCK”) from the CPU (IC8).

The level adjusted AF signals are then applied to the AF power amplifier (IC23, pin 4) to be amplified to obtain rated audio output power. The power-amplified AF signals are output from pin 10, and then drive internal or external speaker.

• 2nd IF AND DEMODULATOR CIRCUITS

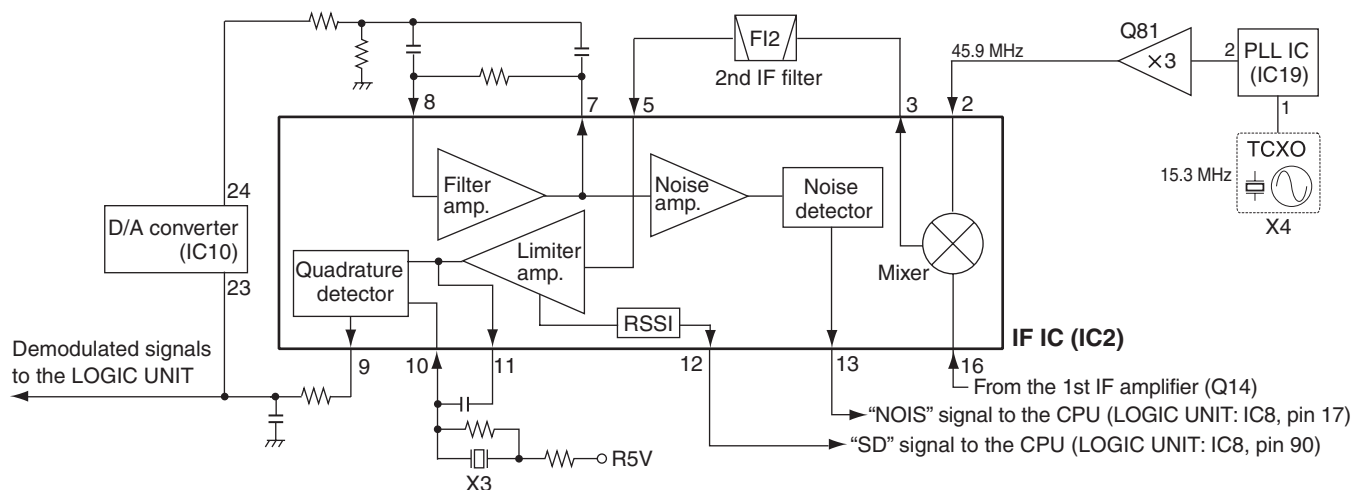

• SQUELCH CIRCUIT (RF AND LOGIC UNITS)

- NOISE SQUELCH -

The noise squelch mutes the AF output when no RF signals are received. By detecting noise components (around 30 kHz signals) in the demodulated AF signals, the squelch circuit toggles the mute switch and AF power amplifier ON and OFF.

A portion of the AF signals from the IF IC (RF UNIT; IC2, pin 9) are passed through the D/A converter (RF UNIT; IC10, pins 23, 24) for level adjustment. The level adjusted AF signals are applied to the noise filter section (RF UNIT; IC2, pins 7, 8; R86–R88, C121, C122) which allows only noise components to pass. The filtered noise components are amplified at the noise amplifier section, and rectified into the DC voltage which is proportional to the noise signal level, at the noise detector section, then output from pin 13 as the “NOIS” signal.

The “NOIS” signal is applied to the CPU (LOGIC UNIT; IC8, pin 17), and the CPU compares the “NOISE” signal and set reference level (squelch threshold level). When the input “NOIS” signal is higher than reference level, the CPU cuts off “AFON” signal (from pin 4) to the AF power amplifier control circuit (LOGIC UNIT; Q14–Q16) to deactivate the AF power amplifier (LOGIC UNIT; IC23).

- TONE SQUELCH -

The tone squelch circuit detects tone signals and opens the squelch only when receiving a signal containing a matched sub audible tone. When the tone squelch is in use, and a signal with a mismatched or no subaudible tone is received, the tone squelch circuit mutes the AF signals even when the noise squelch is open.

A portion of the demodulated AF signals is passed through the LPF (LOGIC UNIT; Q53) to filter CTCSS/DTCS signal. The filtered signal is applied to the CPU (LOGIC UNIT; IC8, pin 93). The CPU compares the applied signal and the set CTCSS/DTCS, then the CPU controls the status (“Low” or “High”) of “AFON” signal as “• NOISE SQUELCH.”

• AF and MIC amp. CIRCUITS

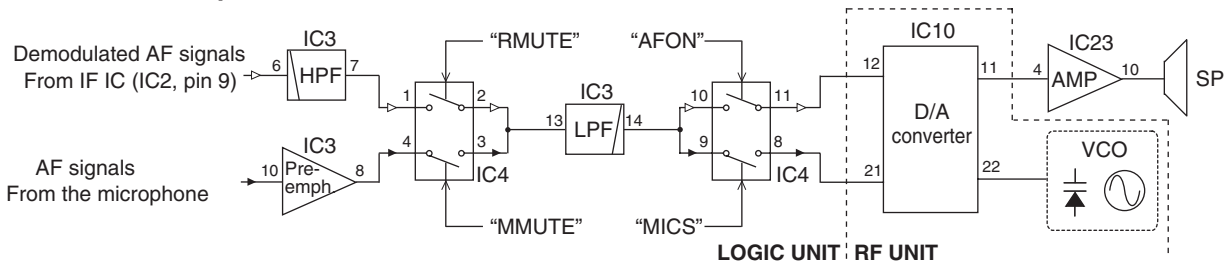

4-2 TRANSMITTER CIRCUITS

• MICROPHONE AMPLIFIER CIRCUITS (LOGIC UNIT)

The AF signals from the microphone (MIC signals) are filtered and level-adjusted at microphone amplifier circuits.

Audio signals from the microphone (MC1) are applied to IC3 (pin 10) which combines a microphone amplifier and pre-emphasis circuit. The MIC signals are amplified and filtered to obtain +6 dB/oct of frequency characteristic by IC3.

The amplified and emphasized MIC signals are output from the pin 8, and passed through the splatter filter (IC3, pins 13, 14) which suppresses 3 kHz and higher audio components, via the TX/RX switch (IC4, pins 3, 4; 8, 9). The filtered MIC signals are then applied to the modulation circuit.

• MODULATION CIRCUITS (RF UNIT)

- MIC SIGNALS -

The modulation circuits modulates the VCO oscillating signal using the modulation signals.

The MIC signals from AF circuits are passed through the D/A converter (IC10, pins 21, 22) for level (deviation) adjustment. The level adjusted MIC signals are applied to the variable capacitor (D61) in the VCO (Q76, D59–D61), and modulate the VCO oscillating signal by changing the reactance of D61. The modulated VCO output are buffer-amplified by Q75 and Q74, then applied to the transmit amplifier as a transmit signal.

- TONE SIGNALS -

CTCSS/DTCS signals are output from CPU (LOGIC UNIT; IC8, pin 2) and passed through the LPF (R224, R227, C219), then applied to the LPF (as the AF mixer RF UNIT; IC3, pin 13) to be mixed with MIC signals. The mixed CTCSS/DTCS signals are applied to modulation circuits as “• MIC SIGNALS.”

• TRANSMIT AMPLIFIERS (RF UNIT)

The transmit signal from the buffer amplifier (Q74) is amplified to the transmit output level by the transmit amplifiers.

The buffer-amplified VCO output signal is amplified by transmit amplifiers; pre-drive (Q3), drive (Q2) and power (Q1) amplifiers in sequence, after being passed through the TX/RX switch (D3).

The power-amplified transmit signal is passed through the power detector (D32, D33), antenna switch (D1) and LPF (as a harmonic filter ; L1, L2, C1–C5), before being emitted from the antenna.

• APC (Automatic Power Control) CIRCUIT (RF UNIT)

The APC (Automatic Power Control) circuit prevents the transition of the transmit output power level which is caused by load mismatching or heat effect, etc.

At the power detector (D32, D33), a portion of the transmit signal is rectified into DC voltage which is proportional to the transmit power level.

The rectified voltage is applied to the inverted input terminal of the operational amplifier (IC26, pin 2). The voltage “T3” from the D/A converter (IC10, pin 10) is applied to the non-inverted input terminal as the reference.

The operational amplifier compares the rectified voltage and reference voltage “T3,” and the difference of the voltage is output from the operational amplifier pin 1. The output voltage controls the bias of drive (Q2) and power (Q1) amplifiers for stable transmit output power.

The change of transmit power is carried out by changing the reference voltage “T3”, and transmit muting (deactivation of drive and power amplifiers) is carried out by TX switch (Q37) controlled by “TXC” signal from CPU (LOGIC UNIT; IC8, pin 59).

• APC CIRCUITS

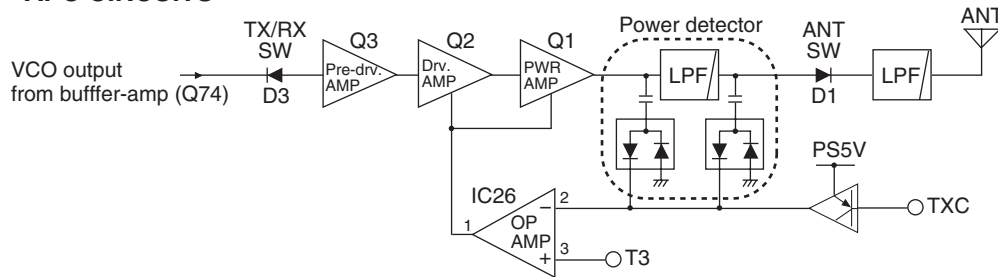

4-3 FREQUENCY SYNTHESIZER CIRCUITS

• VCO (RF UNIT)

VCO (Voltage Controlled Oscillator) is an oscillator whose oscillating frequency is controlled by adding voltage (lock voltage).

VCO oscillates the both of transmit and 1st LO signals. The VCO output signals are buffer-amplified by Q74 and Q75.

While receiving, the VCO output is passed through the TX/RX switch (D4) and the LPF (L29, L38, L59, C102, C435, C437, C539), then applied to the 1st mixer (Q13) to be mixed with the received signals to produce the 46.35 MHz 1st IF signal.

While transmitting, the buffer-amplified VCO output is passed through the TX/RX switch (D3) and applied to the transmit amplifiers.

A portion of VCO output is applied to the PLL IC (IC19, pin 8) via buffer amplifiers (Q5, Q75). The applied signal is divided at the pre-scalar and programmable counter according to the control signals “PLLSTB,” “PLLDATA” and “PLLCK” from the CPU (L; IC8, pins 63, 65 and 66). The divided signal is phase-compared with the reference frequency signal from the reference frequency oscillator (X4), at the phase detector.

The phase difference is output from pin 5 as a pulse type signal after being passed through the internal charge pump. The output signal is converted into the DC voltage (lock voltage) by passing through the loop filter (R445–R448, C472–C475, C519). The lock voltage is applied to the variable capacitors (D59 and D60) of VCO (Q76, D59–D61) and locked to keep the VCO oscillating frequency constant.

If the oscillated signal drifts, its phase changes from that of the reference frequency, causing a lock voltage change to compensate for the drift in the VCO oscillating frequency.

• PLL (Phase Locked Loop) CIRCUIT (RF UNIT)

The PLL circuit provides stable oscillation of the transmit frequency and receive 1st LO frequency. The PLL output frequency is controlled by the divided ratio (N-data) from the CPU.

• PLL CIRCUITS

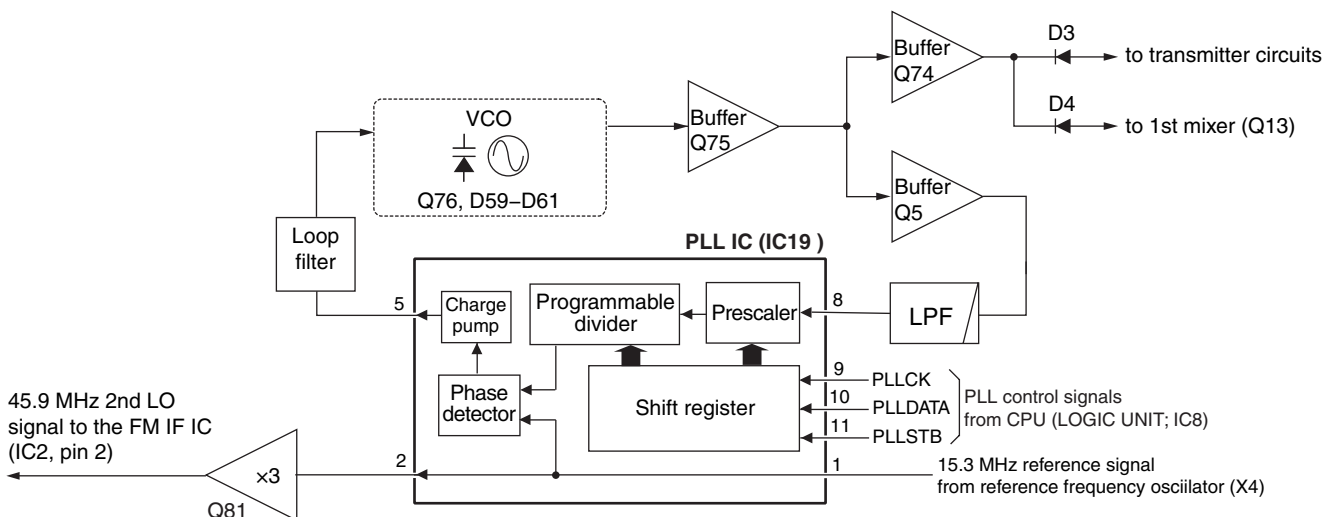

4-4 POWER SUPPLY CIRCUITS

DC voltage from the battery or external DC power supply is routed to whole circuit of the transceiver via regulators.

• POWER SUPPLY CIRCUITS

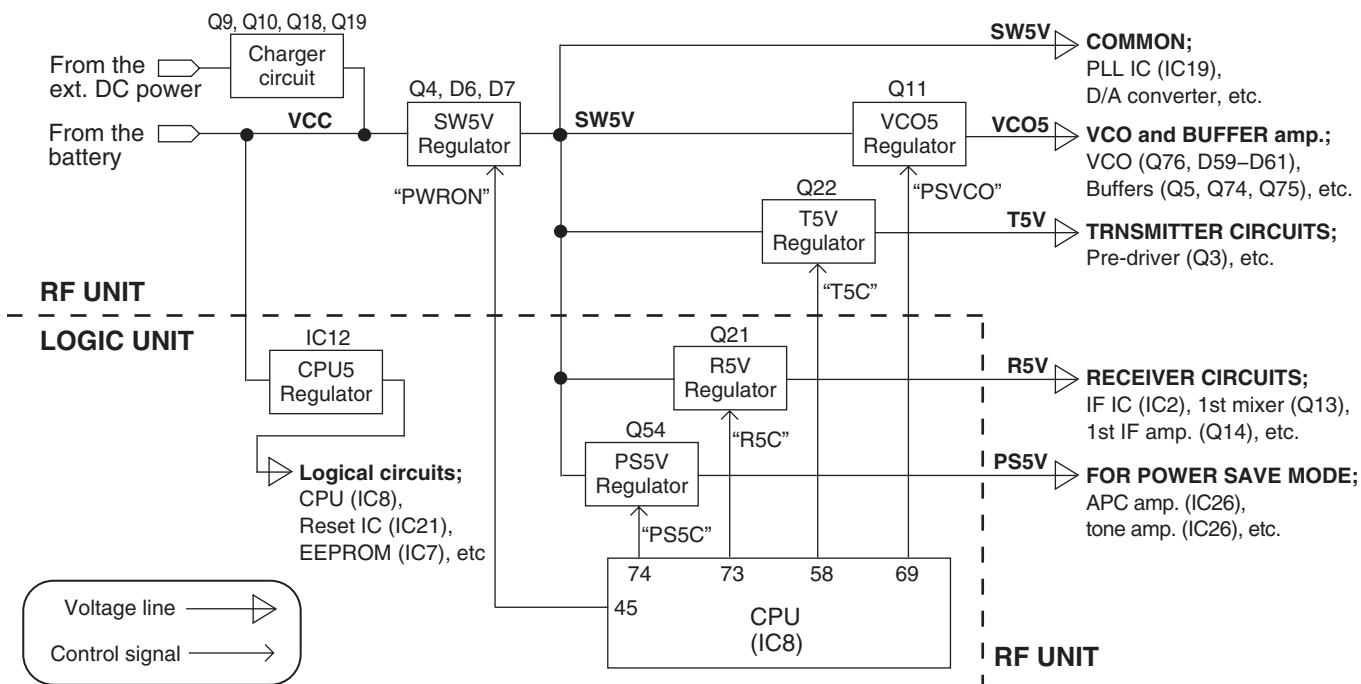

4-5 CPU PORT ALLOCATION

Pin No.	Pin Name	Description	I/O
1	TONE	Tone signals (DTMF/BEEP/1750Hz).	OUT
2	CTCSS	Tone signals (CTCSS/DTCSS).	OUT
4	AFON	AF power amplifier control signal. "High"=While the AF poer amp. is activated.	OUT
5	RMUTE	AF line mute signal to the AF switch. "Low"=While muting.	OUT
9	CSHIFT	Clock frequency shift control signal to the clock oscillator.	OUT
10	RESET	CPU reset signal. "Low"=CPU reset.	IN
16	PWRSW	[PWR] Key. "Low"=When the key is pushed.	IN
17	NOIS	"NOIS" signal.	IN
18	DCC	Eexternal power supply connection detect. "Low"=Powered by external DC.	IN
19	HOUT	Power supply detect. "Low"=Powered by battery.	IN
20	PTT	Input signal from [PTT] key. "High"=While the key is pushed.	IN
21-24	KR0-KR3	Input signal from Key pads. "Low"=When the key is pushed.	IN
25	LEDC	Backlight control signal to the LED driver.	OUT
33	DISDA	Serial data to the LCD driver.	IN
34	DISST	Chip-enable signal to the LCD driver.	IN
35	DISCK	Serial clock signal to the LCD driver.	IN
36	DISEN	Disable signal to the LCD driver.	IN
40	DICK	Pulse signal from [CONTROL DIAL].	IN
41	DIUD		IN
42	MONISW	[MONI] key. "Low"=When the key is pushed.	IN
45	PWRON	Control signal to the power regulator.	OUT
48-52	KS0-KS4	Input signal from Key pads. "Low"=When the key is pushed.	OUT
53	MICS	AF filter switching signal.	OUT
54	MMUTE	MIC line mute signal to the AF switch. "low"=While muting.	OUT
55	DADATA	Data signal to the D/A converter.	OUT
56	DACK	Clock signal to the D/A converter.	OUT

Pin No.	Pin Name	Description	I/O
57	DASTB	Strobe signal to the D/A converter.	OUT
58	T5C	T5 line control signal to the T5 regulator. "Low"=While transmitting.	OUT
59	TXC	Transmit mute signal to the TX switch. "Low"=While TX muting.	OUT
61	UNLK	PLL unlock signal. "Low"=PLL is unlocked.	IN
63	PLLSTB	Strobe signal to the PLL IC.	OUT
64	PLPS	PLL IC power save mode switching signal. "Low"=While in power save mode.	OUT
65	PLLDATA	Data signal to the PLL IC.	OUT
66	PLLCK	Clock signal to the PLL IC.	OUT
68	PLLSW	PLL loop filter characteristic toggle signal. "High"=While the PLL is kicked-up.	OUT
69	PSVCO	VCO regulator control signal. "Low"=While Vco is activated."	OUT
70	CHGIH	Charger circuit (High) control signal. "High"=While charging.	OUT
71	CHGC	Charger circuit control signal. "High"=While charging.	OUT
74	PS5C	Power save line control signal to the PS5V regulator. "Low"=While power save mode.	OUT
77	SI	External MIC key (A/D) input. "High"=While the key is pushed.	IN
78	OPSD	Data signal to the attached optional unit.	OUT
79	ESCK	Clock signal to the EEPROM.	OUT
81	OPV1	Scramble unit detection signal. "Low"=DTMF unit is attached.	IN
82	OPV2	Optional unit attachment detection signal. "Low"=DTMF unit is attached.	IN
83	OPV3	DTMF unit detection signal. "Low"=DTMF unit is attached.	IN
87	DCIN	External power supply's voltage detection.	IN
88	LVIN	Lock voltage.	IN
90	SD	"SD" signal (RSSI signal).	IN
91	VIN	Remining battery voltage detection.	IN
93	CTCIN	DTCS and CTCSS signals.	IN

SECTION 5 ADJUSTMENT PROCEDURE

REQUIRED TEST EQUIPMENTS

When adjusting IC-V85/V85E/V85-T, following test equipments and JIG cables (see the illust below) are required.

EQUIPMENT	GRADE AND RANGE	EQUIPMENT	GRADE AND RANGE
RF power meter (terminated type)	Measuring range : 0.1–10 W Frequency range : 100–300 MHz Impedance : 50 Ω SWR : Less than 1.2 : 1	Standard signal generator (SSG)	Frequency range : 0.1–300 MHz Output level : –20 to 90 dBμ (–127 to –17 dBm)
Frequency counter	Frequency range : 0.1–300 MHz Frequency accuracy : ±1 ppm or better Sensitivity : 100 mV or better	AC millivoltmeter	Measuring range : 10 mV to 10 V
Modulation analyzer	Frequency range : 30–300 MHz Measuring range : 0 to ±10 kHz	Oscilloscope	Frequency range : DC–20 MHz Measuring range : 0.01–20 MHz
Audio generator	Frequency range : 300–3000 Hz Output level : 1–500 mV	External speaker	Input impedance : 8 Ω Capacity : More than 1 W
		Attenuator	Power attenuation : 30 or 40 dB Capacity : More than 10 W

CAUTION!: BACK UP originally programmed contents (Memory channels, Common settings, etc.) in the transceiver using optional CS-V85 CLONING SOFTWARE before starting adjustment.
When all adjustments are completed, these contents in the transceiver may be cleared.

CONNECTION

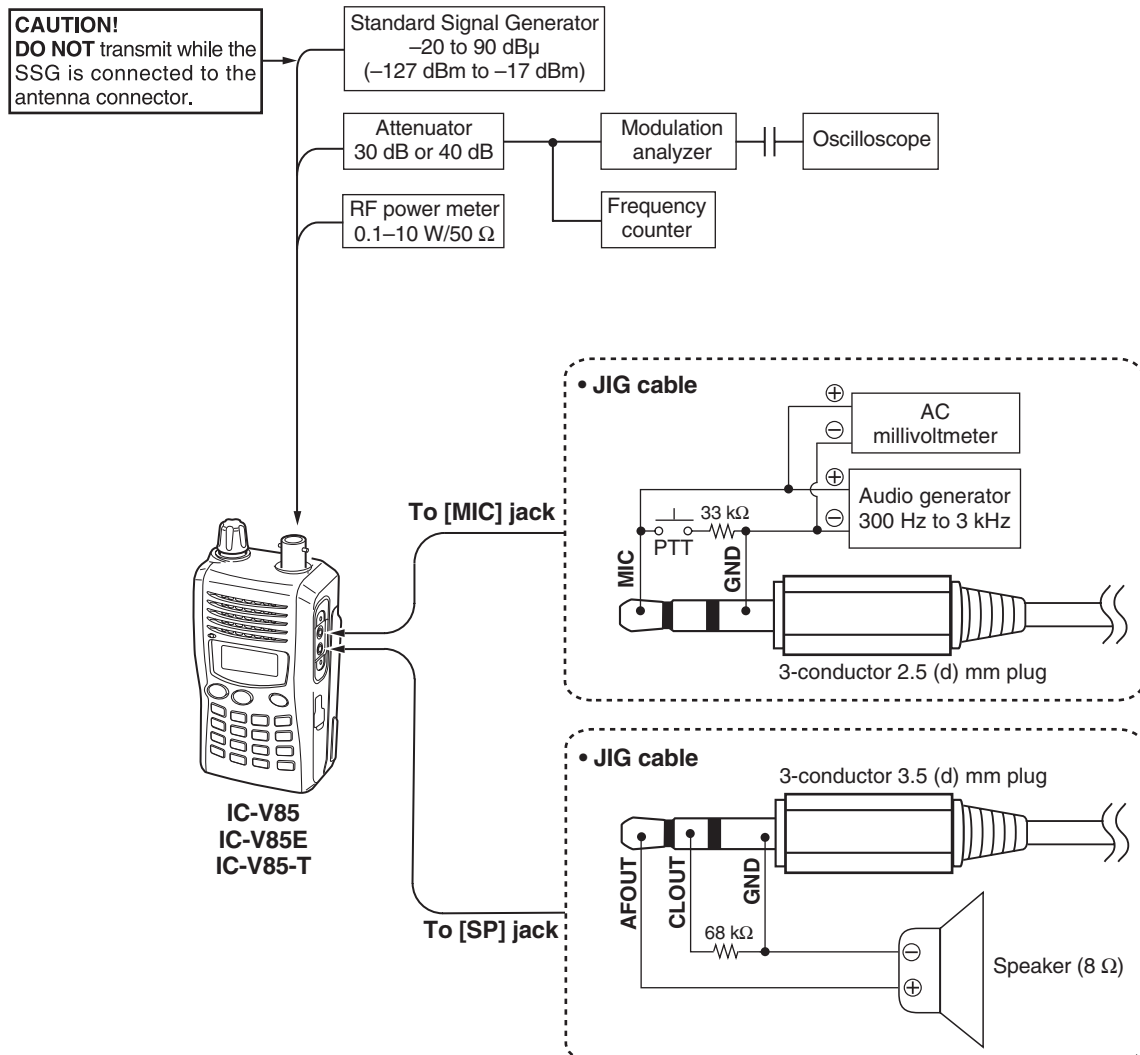

■ ENTERING ADJUSTMENT MODE

- ① Turn the power OFF.
- ② Connect the JIG cable to the [SP] jack (see page 5-1).
- ③ While pushing [▲], [▼] and [CLR] keys, turn the power ON.

During adjustment mode, the function display shows adjustment item and frequency as below.
(While rotating [CONTROL DIAL], adjustment value is displayed instead of adjustment item.)

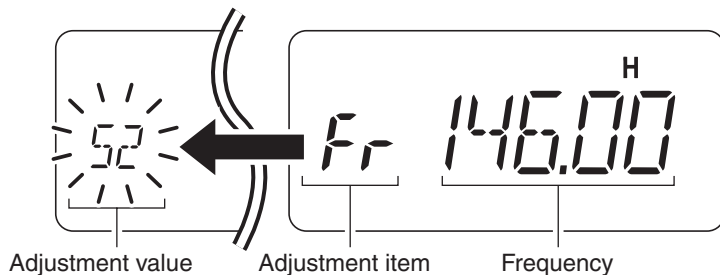

■ KEY ASSIGNMENTS FOR THE ADJUSTMENT MODE

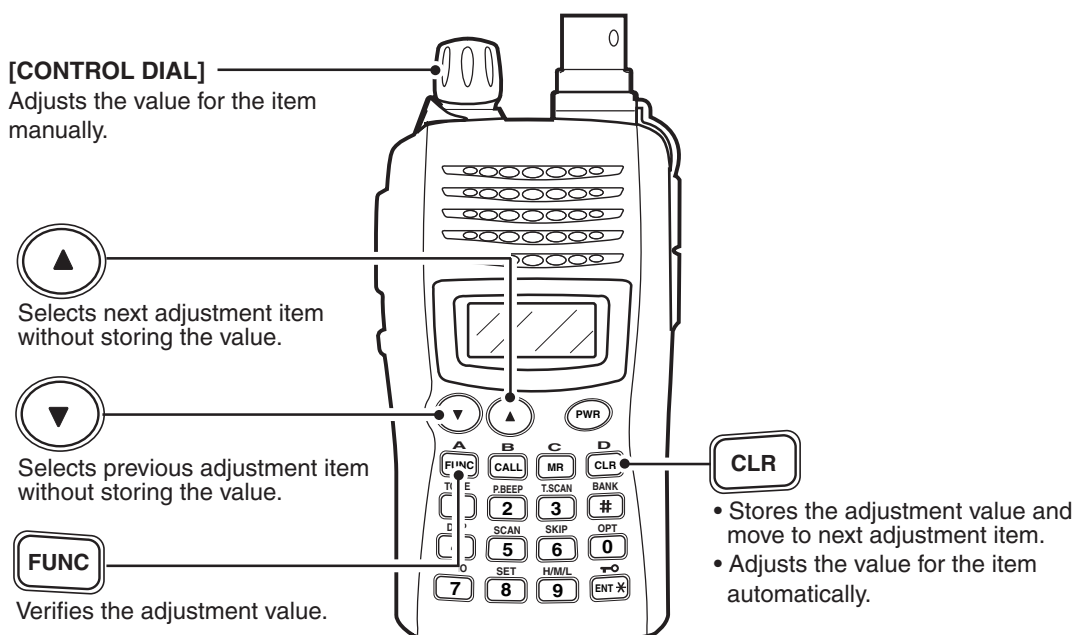

■ QUITTING ADJUSTMENT MODE

- Turn the power OFF.

ADJUSTMENT

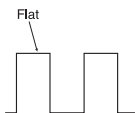
ADJUSTMENT	ADJUSTMENT CONDITION	OPERATION	VALUE
REFERENCE FREQUENCY [Fr]	1 <ul style="list-style-type: none"> • Connect a RF Power Meter or a dummy load to the antenna connector. • Loosely couple a Frequency Counter to the antenna connector. • Transmitting 	Rotate [CONTROL DIAL] during transmit to adjust the frequency, then release the [PTT] and push [CLR] key to store the adjustment value and select the next adjustment item.	146.00000 MHz
LOCK VOLTAGE [LU]	1 <ul style="list-style-type: none"> • Connect an RF Power Meter to the antenna connector. • Transmitting 	Push [CLR] key during transmit, then push [▲] to select the next adjustment item.	(automatic adjustment)
TRANSMIT OUTPUT POWER [Po] (H; High)	1 <ul style="list-style-type: none"> • Connect an RF Power Meter to the antenna connector. • Transmitting 	Rotate [CONTROL DIAL] during transmit to adjust the output power, then release the [PTT] and push [CLR] key during transmit to store the adjustment value and select the next adjustment item.	7.0 W except [THA] 5.5 W [THA]
(M; Middle)	2 <ul style="list-style-type: none"> • Transmitting 		4.0 W
(L; Low)	3 <ul style="list-style-type: none"> • Transmitting 		0.5 W
DEVIATION [dE]	NOTE: "REFERENCE FREQUENCY" should be adjusted before "DEVIATION." Otherwise, "DEVIATION" will not be adjusted properly.		
	1 <ul style="list-style-type: none"> • Connect an Audio Generator and AC millivoltmeter to the MIC line (see page 5-1) and set as; Frequency : 1 kHz Level : 90 mVrms • Connect a Modulation Analyzer to the antenna connector through an attenuator, and set as; HPF : OFF LPF : 20 kHz De-emphasis : OFF • Detector : (P-P)/2 Transmitting 	Rotate [CONTROL DIAL] during transmit to adjust the deviation, then release the [PTT] and push [CLR] key to store the adjustment value and select the next adjustment item.	±4.2 kHz
[dP]*	Push [▲] to skip this item.		—
DTCS MODULATION BALANCE [dt]	NOTE: "DEVIATION" should be adjusted before "DTCS MODULATION BALANCE." Otherwise, "DTCS MODULATION BALANCE" will not be adjusted properly.		
	1 <ul style="list-style-type: none"> • Set the Modulation Analyzer same as "DEVIATION." • Connect an Oscilloscope to the detector output terminal of the Modulation Analyzer. • No audio signal is applied to the MIC line. • Transmitting 	Rotate [CONTROL DIAL] during transmit to arrange the wave form, then release the [PTT] and push [CLR] key during transmit to store the adjustment value and select the next adjustment item.	Set to square wave form 
[bP]*	Push [▲] to skip this item.		—
RECEIVE SENSITIVITY [tr] (Band low)	NOTE: "REFERENCE FREQUENCY" should be adjusted before "RECEIVE SENSITIVITY." Otherwise, "RECEIVE SENSITIVITY" will not be adjusted properly.		
	1 <ul style="list-style-type: none"> • Connect an SSG to the antenna connector and set as; Frequency : Displayed frequency Level : 0 dBμ (-107 dBm) Modulation : 1 kHz Deviation : ±3.5 kHz • Receiving 	Push [CLR] key to store the adjustment value and select the next adjustment item.	(automatic adjustment)
(Band center)	2 <ul style="list-style-type: none"> • Set the SSG as; Frequency : Displayed frequency • Receiving 	Push [CLR] key to store the adjustment value and select the next adjustment item.	
(Band high)	3 <ul style="list-style-type: none"> • Set the SSG as; Frequency : Displayed frequency • Receiving 	Push [CLR] key to store the adjustment value and select the next adjustment item.	
SQUELCH [Sq]	1 <ul style="list-style-type: none"> • Connect an 8 Ω speaker to the AFOUT line (see page 5-1). • Set the SSG as; Level : -19 dBμ (-126 dBm) • Receiving 	Rotate [CONTROL DIAL] to close the squelch once, then rotate [CONTROL DIAL] to set the squelch level at the point where the audio signals just appear. Push [CLR] key to store the adjustment value and select the next adjustment item.	Squelch open

*; These items MUST NOT be modified. Otherwise, the transceiver will not perform properly.

■ ADJUSTMENT (continued)

ADJUSTMENT	ADJUSTMENT CONDITION	OPERATION	VALUE
S-meter [Sr]	NOTE: "RECEIVE SENSITIVITY" should be adjusted before "S-meter." Otherwise, "S-meter" will not be adjusted properly.		
	1 • Set the SSG as; Frequency : Displayed frequency Level : -6 dBu (-113 dBm) • Receiving	Push [CLR] key to store the adjustment value and select the next adjustment item.	(automatic adjustment)
[dF]*	Push [▲] to skip this item.		
[Et]*	Push [▲] to skip this item.		
CTCSS AMPLITUDE (f=5.00 kHz) [C5]	NOTE: "DTCS MODULATION BALANCE" (page 5-3) should be adjusted before "CTCSS AMPLITUDE." Otherwise, "CTCSS AMPLITUDE" will not be adjusted properly.		
	1 • Set the Modulation Analyzer same as "DEVIATION." 2 • No audio signal is applied to the MIC line. • Transmitting	Rotate [CONTROL DIAL] during transmit to adjust the deviation, then release the [PTT] and push [CLR] key to store the adjustment value.	±0.75 kHz
[dt]* to [D6]*	Skip these items. (The adjustment is completed. Turn the power OFF.)		

*; These items MUST NOT be modified. Otherwise, the transceiver will not perform properly.

SECTION 6

PARTS LIST

[LOGIC UNIT]

REF NO.	ORDER NO.	DESCRIPTION	M.	H/V LOCATION
IC3	1110006470	S.IC LMV3241PWR	B	5.6/21.2
IC4	1130011770	S.IC CD4066BPWR	B	14.1/18.2
IC7	1130012430	S.IC S-24CS64A01-T8T1G	B	5.5/36.7
IC8	1140014020	S.IC M30622MAP-412GP(FX2964B)	B	23.8/34.4
IC12	1180002251	S.IC S-812C50AMC-C3E-G	B	8.2/75
IC21	1110006260	S.IC BD5242G-TR	B	43.9/25.1
IC22	1130009090	S.IC LC75834W-TLM-E	B	22.4/55.9
IC23	1110001811	S.IC TA7368FG (5,ER)	B	30.2/67.1
Q1	1520000460	S.TR 2SB1132 T100 R	T	5/63
Q2	1530003281	S.TR 2SC4211-6-TL-E	B	4.7/64.7
Q6	1530003630	S.TR 2SC4617 TLS	B	35.8/39.1
Q14	1520000460	S.TR 2SB1132 T100 R	B	38.7/84
Q15	1520000460	S.TR 2SB1132 T100 R	T	40.8/72.1
Q16	1590001190	S.TR XP6501-(TX).AB	T	41.8/76.8
Q17	1590003420	S.TR UNR911FJ-(TX)	B	8.1/70.2
Q21	1510000510	S.TR 2SA1576A T106R	B	7.7/4.3
Q31	1590003270	S.TR UNR9210J-(TX)	T	41.8/62.2
Q38	1590003290	S.TR UNR9213J-(TX)	B	27.7/47.6
Q53	1590001650	S.TR XP4601 (TX)	B	8/44.2
Q54	1510000510	S.TR 2SA1576A T106R	B	5.2/10.4
Q55	1520000460	S.TR 2SB1132 T100 R	T	5.4/84.7
Q56	1590003290	S.TR UNR9213J-(TX)	T	10.5/77.6
Q57	1590001170	S.TR XP1501-(TX).AB	T	8.1/80.3
D8	1730002300	S.ZEN MA8082-M (TX)	B	37.4/33.9
D10	1790001250	S.DIO MA2S111-(TX)	B	37.3/31
D27	1790000980	S.DIO MA742 (TX)	T	42.3/65.5
D34	1790000950	S.ZEN MA8056-M (TX)	B	10.5/68.4
D39	1750000940	S.DIO ISS400 TE61	B	8.2/78.2
D40	1750000940	S.DIO ISS400 TE61	B	24.6/20.1
D41	1750000940	S.DIO ISS400 TE61	B	34.8/27
D42	1750000940	S.DIO ISS400 TE61	B	34.1/21.1
D43	1750000940	S.DIO ISS400 TE61	B	26.5/15.5
D44	1750000940	S.DIO ISS400 TE61	B	35.4/6.2
D46	1750000940	S.DIO ISS400 TE61 except [USA/-2], [KOR] only	B	39.6/27.5
D47	1750000940	S.DIO ISS400 TE61 [THA], [EXP/-2/-3] only	B	38.4/27.5
D48	1750000940	S.DIO ISS400 TE61 [EUR/-1], [EXP/-2/-3], [UK] only	B	37.2/27.5
D49	1750000940	S.DIO ISS400 TE61 [EXP/-2/-3], [KOR] only	B	36/27.5
D56	1750000771	S.VCP HVC376BTRF-E	B	37.2/45
D66	1750000940	S.DIO ISS400 TE61 except [USA], [USA-2], [EXP/-2/-3] only	B	36/24.5
D67	1750000940	S.DIO ISS400 TE61 [EUR/-1], [USA/-2], [UK], [KOR] only	B	37.2/24.5
D68	1750000940	S.DIO ISS400 TE61 [TPE], [THA], [KOR], [TPE-2] only	B	38.4/24.5
D69	1750000940	S.DIO ISS400 TE61 [THA], [EXP/-2/-3] only	B	39.6/24.5
D70	1750000940	S.DIO ISS400 TE61 except [EXP/-2/-3], [THA] only	B	40.8/24.5
X2	6050012470	S.XTL CR-836 (FTX9.8304M16SM)	B	42.4/44.3
R1	7030007270	S.RES ERJ2GEJ 151 X (150)	B	8/62.8
R2	7030009140	S.RES ERJ2GEJ 272 X (2.7 k)	B	8/63.7
R3	7030005090	S.RES ERJ2GEJ 104 X (100 k)	B	33.4/39.9
R4	7030009140	S.RES ERJ2GEJ 272 X (2.7 k)	B	8/64.6
R6	7030009140	S.RES ERJ2GEJ 272 X (2.7 k)	B	8.1/65.5
R7	7030009140	S.RES ERJ2GEJ 272 X (2.7 k)	B	5.3/62.5
R8	7030005040	S.RES ERJ2GEJ 472 X (4.7 k)	B	3.6/62.5
R9	7030004980	S.RES ERJ2GEJ 101 X (100)	B	11/15.2
R10	7030000110	S.RES MCR10EZHJ 5.6 (5R6)	T	34.2/74
R11	7030000110	S.RES MCR10EZHJ 5.6 (5R6)	T	34.2/72.2
R17	7030005090	S.RES ERJ2GEJ 104 X (100 k)	B	34.9/41.8
R19	7030005050	S.RES ERJ2GEJ 103 X (10 k)	B	37.9/36.4
R22	7030005050	S.RES ERJ2GEJ 103 X (10 k)	B	37/36.4
R44	7030005050	S.RES ERJ2GEJ 103 X (10 k)	B	4.6/34.2
R93	7030005600	S.RES ERJ2GEJ 273 X (27 k)	B	2.4/15
R94	7030005160	S.RES ERJ2GEJ 105 X (1 M)	B	5.7/16.6
R95	7030007310	S.RES ERJ2GEJ 155 X (1.5 M)	B	4.1/16.6
R97	7030005110	S.RES ERJ2GEJ 224 X (220 k)	B	10/28
R98	7030005100	S.RES ERJ2GEJ 154 X (150 k)	B	9.9/29.2
R99	7030008300	S.RES ERJ2GEJ 184 X (180 k)	B	7.5/29.8
R100	7030005090	S.RES ERJ2GEJ 104 X (100 k)	B	4.8/29
R101	7030005160	S.RES ERJ2GEJ 105 X (1 M)	B	39.3/42.1
R102	7030005530	S.RES ERJ2GEJ 100 X (10)	B	37.3/40.1
R103	7030008010	S.RES ERJ2GEJ 123 X (12 k)	B	38.4/43.7
R104	7030005090	S.RES ERJ2GEJ 104 X (100 k)	B	5.4/26
R107	7030005100	S.RES ERJ2GEJ 154 X (150 k)	B	8.7/28.4
R108	7030005110	S.RES ERJ2GEJ 224 X (220 k)	B	3.3/26.4
R109	7030005090	S.RES ERJ2GEJ 104 X (100 k)	B	10.1/24.4
R112	7030005160	S.RES ERJ2GEJ 105 X (1 M)	B	7.1/15.4
R113	7030005070	S.RES ERJ2GEJ 683 X (68 k)	B	10.8/29.2
R114	7030008290	S.RES ERJ2GEJ 183 X (18 k)	B	7.5/26.4
R115	7030005310	S.RES ERJ2GEJ 124 X (120 k)	B	8.7/26
R117	7030005030	S.RES ERJ2GEJ 152 X (1.5 k)	B	10/27.1
R120	7030005240	S.RES ERJ2GEJ 473 X (47 k)	T	43.5/75.2
R121	7030005030	S.RES ERJ2GEJ 152 X (1.5 k)	T	44/77.3
R122	7030009140	S.RES ERJ2GEJ 272 X (2.7 k)	T	40/76.7
R123	7030005210	S.RES ERJ2GEJ 822 X (8.2 k)	T	40.4/78.7

[LOGIC UNIT]

REF NO.	ORDER NO.	DESCRIPTION	M.	H/V LOCATION
R123	7030005290	S.RES ERJ2GEJ 682 X (6.8 k)	T	40.4/78.7
R126	7030005050	S.RES ERJ2GEJ 103 X (10 k)	B	22.7/66.6
R126	7030005310	S.RES ERJ2GEJ 124 X (120 k)	B	22.7/66.6
R127	7030005530	S.RES ERJ2GEJ 100 X (10)	B	25.3/67.9
R127	7030007260	S.RES ERJ2GEJ 330 X (33)	B	25.3/67.9
R128	7030005530	S.RES ERJ2GEJ 100 X (10)	B	34.9/67.9
R130	7030005090	S.RES ERJ2GEJ 104 X (100 k)	B	10.7/70.7
R131	7030008400	S.RES ERJ2GEJ 182 X (1.8 k)	B	7.4/71.9
R132	7030005000	S.RES ERJ2GEJ 471 X (470)	T	44.4/78.7
R136	7030004980	S.RES ERJ2GEJ 101 X (100)	B	42.5/14
R137	7030004980	S.RES ERJ2GEJ 101 X (100)	B	7.5/27.3
R139	7030005050	S.RES ERJ2GEJ 103 X (10 k)	B	9.4/5
R144	7030005220	S.RES ERJ2GEJ 223 X (22 k)	B	7.4/68.4
R145	7030005090	S.RES ERJ2GEJ 104 X (100 k)	B	28.2/44.5
R148	7030005090	S.RES ERJ2GEJ 104 X (100 k)	B	43.4/27.4
R159	7030005090	S.RES ERJ2GEJ 104 X (100 k)	B	6.3/26
R164	7030005090	S.RES ERJ2GEJ 104 X (100 k)	B	32.7/77.8
R168	7030005170	S.RES ERJ2GEJ 474 X (470 k)	B	9.1/32.3
R169	7030007350	S.RES ERJ2GEJ 393 X (39 k)	B	2.4/32.6
R170	7030005050	S.RES ERJ2GEJ 103 X (10 k)	B	10/32.3
R174	7030007340	S.RES ERJ2GEJ 153 X (15 k)	T	41.8/63.6
R176	7030008410	S.RES ERJ2GEJ 392 X (3.9 k)	B	2.4/14.1
R177	7030005120	S.RES ERJ2GEJ 102 X (1 k)	B	6.4/14.1
R178	7030005110	S.RES ERJ2GEJ 224 X (220 k)	B	7.5/28.9
R181	7030010080	S.RES ERJ2RHD 104 X (100 k)	B	12.5/44.3
R182	7510001661	S.TMR NTCG16 4LH 473J	B	11.5/44
R193	7030005720	S.RES ERJ2GEJ 563 X (56 k)	B	30.2/61.5
R194	7030005720	S.RES ERJ2GEJ 563 X (56 k)	B	28.4/61.5
R195	7030005720	S.RES ERJ2GEJ 563 X (56 k)	B	27.5/61.5
R196	7030005120	S.RES ERJ2GEJ 102 X (1 k)	B	26.6/61.5
R224	7030007350	S.RES ERJ2GEJ 393 X (39 k)	B	24.3/48
R225	7030005090	S.RES ERJ2GEJ 104 X (100 k)	B	9.7/36.5
R227	7030008410	S.RES ERJ2GEJ 392 X (3.9 k)	B	26.1/47.3
R228	7030005050	S.RES ERJ2GEJ 103 X (10 k)	B	10.6/36.5
R240	7030005120	S.RES ERJ2GEJ 102 X (1 k)	B	32.3/40
R245	7030005090	S.RES ERJ2GEJ 104 X (100 k)	B	34.3/30.5
R246	7030005050	S.RES ERJ2GEJ 103 X (10 k)	B	29.2/44.8
R257	7030005050	S.RES ERJ2GEJ 103 X (10 k)	B	11/21.9
R261	7030005240	S.RES ERJ2GEJ 473 X (47 k)	B	7.8/2.4
R266	7030007340	S.RES ERJ2GEJ 153 X (15 k)	B	4.5/27.8
R318	7030005070	S.RES ERJ2GEJ 683 X (68 k)	B	7.9/41.6
R319	7030005070	S.RES ERJ2GEJ 683 X (68 k)	B	6.1/43.8
R320	7030007340	S.RES ERJ2GEJ 153 X (15 k)	B	6.1/45.4
R321	7030005050	S.RES ERJ2GEJ 103 X (10 k)	B	8/46.4
R323	7030005050	S.RES ERJ2GEJ 103 X (10 k)	B	7.1/46.4
R324	7030007570	S.RES ERJ2GEJ 122 X (1.2 k)	B	8.9/46.4
R325	7030005070	S.RES ERJ2GEJ 683 X (68 k)	B	9.8/43.8
R326	7030005070	S.RES ERJ2GEJ 683 X (68 k)	B	11.1/41.6
R327	7030005090	S.RES ERJ2GEJ 104 X (100 k)	B	19/46.3
R328	7030005110	S.RES ERJ2GEJ 224 X (220 k)	B	5.4/8.5
R329	7030005240	S.RES ERJ2GEJ 473 X (47 k)	B	6.9/10.6
R330	7030005050	S.RES ERJ2GEJ 103 X (10 k)	B	8.7/77.1
R331	7030005050	S.RES ERJ2GEJ 103 X (10 k)	T	8.1/82.1
R332	7030005290	S.RES ERJ2GEJ 682 X (6.8 k)	T	8.1/78
R335	7030005160	S.RES ERJ2GEJ 105 X (1 M)	T	9/78
R336	7030005090	S.RES ERJ2GEJ 104 X (100 k)	B	7.9/42.5
R346	7030005090	S.RES ERJ2GEJ 104 X (100 k)	B	33.1/41.8
R362	7030005050	S.RES ERJ2GEJ 103 X (10 k)	B	34.1/9.5
R382	7030005240	S.RES ERJ2GEJ 473 X (47 k)	B	34.8/7.3
R397	7030005000	S.RES ERJ2GEJ 471 X (470)	B	3.6/27.8
R398	7030005090	S.RES ERJ2GEJ 104 X (100 k)	B	34.7/45
R413	7030004980	S.RES ERJ2GEJ 101 X (100)	B	6.2/15.4
R474	7030005240	S.RES ERJ2GEJ 473 X (47 k)	B	32.2/42.1
R476	7030005050	S.RES ERJ2GEJ 103 X (10 k)	B	34.1/10.4
R477	7030005050	S.RES ERJ2GEJ 103 X (10 k)	B	34.1/11.3
R478	7030005090	S.RES ERJ2GEJ 104 X (100 k)	B	33.6/7.8
R479	7030005090	S.RES ERJ2GEJ 104 X (100 k)	B	32.2/12.6
R482	7030005160	S.RES ERJ2GEJ 105 X (1 M)	B	33.4/14
R483	7030005160	S.RES ERJ2GEJ 105 X (1 M)	B	33.4/13.2
R484	7030005160	S.RES ERJ2GEJ 105 X (1 M)	B	33.4/12.2
R486	7030005160	S.RES ERJ2GEJ 105 X (1 M)	B	10.2/26.2
R491	7030005050	S.RES ERJ2GEJ 103 X (10 k)	B	25.7/61.5
R492	7030005120	S.RES ERJ2GEJ 102 X (1 k)	B	16.5/43.8
R493	7030005120	S.RES ERJ2GEJ 102 X (1 k)	B	14.6/41.9
R494	7030005120	S.RES ERJ2GEJ 102 X (1 k)	B	20.3/47.6
R495	7030005120	S.RES ERJ2GEJ 102 X (1 k)	B	17.1/44.4
R513	7030005110	S.RES ERJ2GEJ 224 X (220 k)	B	24.8/66.1
R521	7030005120	S.RES ERJ2GEJ 102 X (1 k)	B	29.9/25.5
R522	7030005120	S.RES ERJ2GEJ 102 X (1 k)	B	11.4/38.7
R523	7030005120	S.RES ERJ2GEJ 102 X (1 k)	B	12.7/40
R524	7030005120	S.RES ERJ2GEJ 102 X (1 k)	B	13.9/41.2
R525	7030005720	S.RES ERJ2GEJ 563 X (56 k)	B	27.5/59.2
R527	7030005240	S.RES ERJ2GEJ 473 X (47 k)	B	33.8/29.4
R530	7410001130	S.ARY EXB28V102JX	B	27.4/22.6
R532	7030005120	S.RES ERJ2GEJ 102 X (1 k)	B	23.8/21.2
R533	7030005090	S.RES ERJ2GEJ 104 X (100 k)	B	32.1/27.7
R534	7030005240	S.RES ERJ2GEJ 473 X (47 k)	B	30.9/26.5
R535	7030005240	S.RES ERJ2GEJ 473 X (47 k)	B	29.1/24.8
R536	7030005240	S.RES ERJ2GEJ 473 X (47 k)	B	33.1/28.7
R537	7030005040	S.RES ERJ2GEJ 472 X (4.7 k)	B	3.6/61.6
R538	7410001130	S.ARY EXB28V102JX	B	16.4/28.1
R543	7030010040	S.RES ERJ2GEJ-JPW	B	7.1/12.3
R545	7030010040	S.RES ERJ2GEJ-JPW	B	37.9/42.5
R546	7030010040	S.RES ERJ2GEJ-JPW	B	36.6/43.7
R547	7030010040	S.RES ERJ2GEJ-JPW	B	38.4/41.3
C1	4030016930	S.CER ECJ0EB1A104K	B	5.7/61.3

M.=Mounted side (T: Mounted on the Top side, B: Mounted on the Bottom side)
S.=Surface mount

[LOGIC UNIT]

REF NO.	ORDER NO.	DESCRIPTION	M.	H/V LOCATION
C7	4030017460	S.CER ECJ0EB1E102K	B	33.9/39
C12	4030017460	S.CER ECJ0EB1E102K	B	34.4/37.8
C28	4030017460	S.CER ECJ0EB1E102K	B	36.9/37.6
C124	4030016790	S.CER ECJ0EB1C103K	B	3.6/14.5
C125	4030017760	S.CER ECJ0EB1H222K	B	2.9/16.2
C126	4030018110	S.CER ECJ0EB1H272K	B	4.1/15.7
C128	4030016930	S.CER ECJ0EB1A104K	B	8.3/15
C129	4550002960	S.TAN TEESVA 1C 155M8R	B	4.2/30.5
C131	4030016790	S.CER ECJ0EB1C103K	B	10.9/17.8
C132	4030018240	S.CER ECJ0EB1E562K	B	4.5/26
C134	4030017710	S.CER ECJ0EC1H181J	B	3.3/25.5
C135	4030017450	S.CER ECJ0EB1E271K	B	7.5/25.5
C137	4030017040	S.CER ECJ0EB1A333K	B	10.1/25.3
C139	4030018860	S.CER ECJ0EB0J105K	T	44/76.4
C144	4030017460	S.CER ECJ0EB1E102K	B	43.4/28.3
C145	4510009000	S.ELE EEE1A330WVR	B	35/73.1
C147	4030016950	S.CER ECJ0EB1A473K	B	10.7/69.8
C148	4030017490	S.CER C1608 JB 1A 105K-T	B	42/84.8
C150	4550006250	S.TAN TEESVA 1A 106M8R	B	21.9/68.2
C152	4030016950	S.CER ECJ0EB1A473K	B	34.9/68.8
C153	4510009530	S.ELE 10 CE 150 BSS	B	37.9/58.8
C154	4550006220	S.TAN TEESVA 0J 156M8R	B	10.4/72.3
C161	4030016790	S.CER ECJ0EB1C103K	B	9.4/2.4
C163	4030017460	S.CER ECJ0EB1E102K	B	8.3/68.4
C164	4030017460	S.CER ECJ0EB1E102K	T	45/84.6
C165	4030017460	S.CER ECJ0EB1E102K	T	44.6/70.1
C166	4030017460	S.CER ECJ0EB1E102K	T	45.3/79.9
C167	4030017420	S.CER ECJ0EC1H470J	T	45.1/67.7
C168	4030017460	S.CER ECJ0EB1E102K	T	39/68.1
C169	4030017460	S.CER ECJ0EB1E102K	T	34.7/65.2
C171	4030016930	S.CER ECJ0EB1A104K	B	35.3/66.1
C173	4510008500	S.ELE EEE1CA101WP	B	9.9/86.6
C174	4510008660	S.ELE EEE0JA220SR	B	4/5.3
C179	4030016790	S.CER ECJ0EB1C103K	B	5.3/15.4
C193	4030017530	S.CER ECJ0EC1H0R5B	B	37.5/43.7
C194	4030017600	S.CER ECJ0EC1H080C	B	37/41.4
C195	4030017500	S.CER ECJ0EC1H560J	B	39.3/43.7
C197	4030016930	S.CER ECJ0EB1A104K	B	45/27.4
C199	4030016930	S.CER ECJ0EB1A104K	B	17.9/26.7
C209	4030016930	S.CER ECJ0EB1A104K	T	45.7/71.1
C212	4030016790	S.CER ECJ0EB1C103K	B	9/30.1
C213	4550002890	S.TAN TEESVA 1A 225M8R	B	5.8/32.6
C214	4030017040	S.CER ECJ0EB1A333K	B	10.4/30.4
C216	4030018920	S.CER ECJ0EB1H392K	B	25.7/48.5
C217	4030016930	S.CER ECJ0EB1A104K	B	4.8/14.1
C219	4030017040	S.CER ECJ0EB1A333K	B	25.2/47.3
C230	4030017030	S.CER ECJ0EB1A273K	B	43.4/23
C232	4030016930	S.CER ECJ0EB1A104K	B	13.4/44.3
C245	4030016790	S.CER ECJ0EB1C103K	B	8.4/34.4
C249	4030016790	S.CER ECJ0EB1C103K	B	9.8/47
C282	4030017460	S.CER ECJ0EB1E102K	B	7.1/77.1
C283	4030017760	S.CER ECJ0EB1H222K	T	10.1/81.2
C296	4030017730	S.CER ECJ0EB1E471K	B	33.6/43.7
C297	4030016790	S.CER ECJ0EB1C103K	B	34.6/43.7
C299	4030017730	S.CER ECJ0EB1E471K	T	41.1/60.4
C304	4030016950	S.CER ECJ0EB1A473K	B	5.9/27.3
C305	4030017730	S.CER ECJ0EB1E471K	T	9/86.2
C369	4030017040	S.CER ECJ0EB1A333K	B	6.7/42
C370	4030018080	S.CER ECJ0EB1H182K	B	4.9/44.2
C372	4030016970	S.CER ECJ0EB1C223K	B	7.5/47.6
C373	4030017790	S.CER ECJ0EB1E682K	B	9.9/42
C374	4030017760	S.CER ECJ0EB1H222K	B	18.4/45.7
C375	4030017460	S.CER ECJ0EB1E102K	B	6.9/9
C376	4030017460	S.CER ECJ0EB1E102K	B	12.5/76.9
C377	4550006350	S.TAN TEESVB2 1A 226M8R	T	4.8/77.4
C378	4030016930	S.CER ECJ0EB1A104K	T	6.9/75.2
C379	4030017460	S.CER ECJ0EB1E102K	T	10.1/80.2
C380	4510008660	S.ELE EEE0JA220SR	B	11.1/80.6
C381	4550006250	S.TAN TEESVA 1A 106M8R	B	10.9/75.8
C385	4030016930	S.CER ECJ0EB1A104K	B	26.6/63.6
C399	4030017770	S.CER ECJ0EB1E332K	B	21.5/66.1
C400	4030017760	S.CER ECJ0EB1H222K	T	9/83
C401	4030016790	S.CER ECJ0EB1C103K	B	42.1/20
C423	4030016930	S.CER ECJ0EB1A104K	B	2.4/28.2
C424	4030016790	S.CER ECJ0EB1C103K	B	35.7/43.7
C425	4030016790	S.CER ECJ0EB1C103K	B	30.9/41.8
C426	4030017460	S.CER ECJ0EB1E102K	B	30.3/41
C514	4030018520	S.CER C1608 JB 0J 225M-T	B	9.8/34.4
C515	4030016930	S.CER ECJ0EB1A104K	B	19.3/44.4
C524	4030017460	S.CER ECJ0EB1E102K	B	15.8/43.1
C525	4030017460	S.CER ECJ0EB1E102K	B	15.2/42.5
C526	4030017460	S.CER ECJ0EB1E102K	B	19.7/47
C527	4030017460	S.CER ECJ0EB1E102K	B	17.8/45.1
C540	4030017040	S.CER ECJ0EB1A333K	B	25.7/66.1
C541	4030018100	S.CER ECJ0EB1H681K	B	28.4/59.2
C542	4030017460	S.CER ECJ0EB1E102K	B	10.8/38.1
C543	4030017460	S.CER ECJ0EB1E102K	B	12/39.3
C544	4030017460	S.CER ECJ0EB1E102K	B	13.3/40.6
C545	4030016950	S.CER ECJ0EB1A473K	B	27.5/63.1
C546	4030016950	S.CER ECJ0EB1A473K	B	28.4/63.1
C547	4030016950	S.CER ECJ0EB1A473K	B	29.3/61.5
C548	4030017460	S.CER ECJ0EB1E102K	B	28.3/3.2
C549	4030017460	S.CER ECJ0EB1E102K	B	24.8/3.2
C550	4030017460	S.CER ECJ0EB1E102K	B	21.8/3.2
C551	4030017460	S.CER ECJ0EB1E102K	B	20.7/3.2
C552	4030017460	S.CER ECJ0EB1E102K	B	19.8/3.2
C553	4550006250	S.TAN TEESVA 1A 106M8R	B	9.4/20.3
C554	4030017420	S.CER ECJ0EC1H470J	B	30.7/70.5
C555	4030018240	S.CER ECJ0EB1E562K	B	11.2/27.4
J2	6450000131	CNR HSJ1102-018540		
J3	6510025880	CNR TC38-108-01		
J5	6510021970	S.CNR AXN330C130P	B	38.3/14.8

[LOGIC UNIT]

REF NO.	ORDER NO.	DESCRIPTION	M.	H/V LOCATION
J6	6510021901	S.CNR BM02B-ASRS-TF (LF) (SN)	T	41.8/84.6
J7	6510023521	S.CNR 54104-3696 (3692)	B	19.6/8.2
DS1	5010000160	S.LED LNJ310M6URA	T	7/55.3
DS2	5010000160	S.LED LNJ310M6URA	T	40.6/55.3
DS3	5040003280	S.LED RY-SP192UYG24-5M	T	13.7/41.4
DS4	5030002970	LCD S10996		
DS5	5040003280	S.LED RY-SP192UYG24-5M	T	31.1/41.3
DS8	5040003280	S.LED RY-SP192UYG24-5M	T	13.5/24.8
DS9	5040003280	S.LED RY-SP192UYG24-5M	T	34.1/24.8
DS10	5040003280	S.LED RY-SP192UYG24-5M	T	13.1/9.7
DS11	5040003280	S.LED RY-SP192UYG24-5M	T	34.4/9.7
MC1	7700002710	MIC EM6027P-46C33-G		
S3	2260002840	SW SKHLLFA010		
S801	7600000210	ECR TP70N00E20-15F-1903		
S802	2260002840	SW SKHLLFA010		
SP1	2510000840	SP CS028014-12		
W5	8900016000	CBL OPC-1129A		
W6	8900010901	CBL OPC-1121A (P0.5,N36,L60)		
EP1	8930071440	LCT SRCN-2964-SP-N-W		
EP5	6910012350	S.BEA MMZ1608Y 102BT	T	45.5/76.4
EP6	6910018460	S.BEA MMZ1005Y102C-T	T	45.7/72
EP7	6910014680	S.BEA MMZ1608Y 121BT	T	36.8/65.2
EP8	6910018460	S.BEA MMZ1005Y102C-T	T	44.9/68.6
EP9	6910014680	S.BEA MMZ1608Y 121BT	T	43.5/63.1

[RF UNIT]

REF NO.	ORDER NO.	DESCRIPTION	M.	H/V LOCATION
IC2	1110003491	S.IC TA31136FNG (D,EL)	B	9.6/26.5
IC10	1190000350	S.IC M62363FP-650C	B	37.8/13.1
IC19	1130011671	S.IC MB15E03SLPFV1-G-BND-E1	B	10.4/14.8
IC20	1130011801	S.IC SN74AHC1G66HDBV3	T	8.5/13.3
IC24	1180002690	S.REG S-812C36AMC-C2Q-T2G	B	7.3/6.5
IC25	1190001860	S.IC EW-460-FT	B	3.8/23
IC26	1110006740	S.IC LMV3581PWR	T	30.4/30.3
Q1	1560001371	S.FET RD12MVS1-T112	T	21.8/39.7
Q2	1560001241	S.FET RD01MUS1-T113	T	21.6/33.4
Q3	1530003231	S.TR 2SC5085-Y (TE85R,F)	T	25.5/24.5
Q4	1590003720	S.FET HAT1026R-EL-E	T	14.5/46.4
Q5	1530003260	S.TR 2SC5006-T1	B	22.9/15.7
Q9	1590003290	S.TR UNR9213J-(TX)	T	7.9/39.6
Q10	1530003630	S.TR 2SC4617 TLS	T	6.6/42.9
Q11	1590001650	S.TR XP4601 (TX)	B	6.2/15.5
Q12	1580000790	S.FET 3SK318YB-TL-E	B	33.8/31.2
Q13	1580000790	S.FET 3SK318YB-TL-E	B	29.2/24.2
Q14	1530003260	S.TR 2SC5006-T1	B	12.7/22.3
Q18	1510000671	S.TR 2SA1588-GR (TE85R, F)	T	5.3/37.9
Q19	1520000651	S.TR 2SB1201S-TL-E	B	7.3/43.7
Q22	1510000510	S.TR 2SA1576A T106R	T	40.5/23.1
Q34	1560000811	S.FET 2SK1069-4-TL-E	T	4.6/19.2
Q37	1590003230	S.TR UNR9113J-(TX)	T	30.4/38
Q74	1530003581	S.TR 2SC5231C8-TL-E	B	26.2/13.6
Q75	1530003581	S.TR 2SC5231C8-TL-E	B	27.1/6.8
Q76	1530003581	S.TR 2SC5231C8-TL-E	B	20.9/5.9
Q77	1590003300	S.TR UNR921N-(TX)	B	19.1/9.2
Q81	1530002851	S.TR 2SC4116-BL (TE85R,F)	T	10.4/18.6
Q82	1590000430	S.TR DTC144EUA T106	B	2.6/28.3
Q83	1530003630	S.TR 2SC4617 TLS	T	21.4/20.7
D1	1710000871	S.DIO HVU131TRF-E	B	34.6/43.4
D2	1790000620	S.DIO MA77 (TX)	B	39.5/44
D3	1750000531	S.DIO 1SV271 (TPH3,F)	T	25.9/15.8
D4	1790001260	S.DIO MA2S077-(TX)	T	28.9/15.1
D5	1750000940	S.DIO ISS400 TE61	T	35.3/8.3
D6	1750000540	S.DIO RB060L-40 TE-25	T	11.4/36.6
D7	1790001240	S.DIO MA2S728-(TX)	T	9.4/44.7
D8	1790000620	S.DIO MA77 (TX)	B	39.7/40.1
D9	1750000721	S.VCP HVC375BTRF-E	B	39.7/34.8
D11	1750000711	S.VCP HVC350BTRF-E	B	37.1/29.1
D12	1750000711	S.VCP HVC350BTRF-E	B	37.2/24.6
D13	1750000940	S.DIO ISS400 TE61	T	14.1/53.6
D14	1790000860	S.DIO MA133 (TX)	T	2.6/37.9
D15	1790001250	S.DIO MA2S111-(TX)	T	5.5/41.2
D16	1790000671	S.DIO SB07-03C-TB-E	B	7.2/49.2
D32	1790000980	S.DIO MA742 (TX)	T	29.5/40.6
D33	1790000980	S.DIO MA742 (TX)	T	30.8/47.6
D58	1790001260	S.DIO MA2S077-(TX)	B	21.9/9.6
D59	1720000730	S.VCP MA2S30400L	B	18.1/13.7
D60	1720000730	S.VCP MA2S30400L	B	20.6/13.7
D61	1720000651	S.VCP 1SV286 (TPH3,F)	B	16.6/7
D63	1750000370	S.DIO DA221 TL	B	15.3/20.4
D64	1750000940	S.DIO ISS400 TE61	T	14.3/18.2
D65	1750000711	S.VCP HVC350BTRF-E	B	37.3/22.4
D71	1750000940	S.DIO ISS400 TE61	T	16/19.7

M.=Mounted side (T: Mounted on the Top side, B: Mounted on the Bottom side) S.=Surface mount

[RF UNIT]

REF NO.	ORDER NO.	DESCRIPTION	M.	H/V LOCATION
D72	1750000940	S.DIO ISS400 TE61	B	32.7/26
D73	1790001250	S.DIO MA2S111-(TX)	B	3.8/19.6
F11	2010002670	S.XTL FL-393 (46.350 MHz)	B	20.6/22
F12	2020002450	S.CER LTWC450E <JJE>	B	9.2/35.3
X3	6070000300	S.DCR JTBM450CX24 <JJE>	T	13.5/26.9
X4	6050011940	S.XTL CR-783 (15.3 MHz)	B	11/5.1
L1	6200012910	S.COL 0.35-1.6-8TL 45.5N	B	39.1/48
L2	6200012470	S.COL 0.30-1.7-7TL 45.3N	B	35.7/48.6
L4	6200012470	S.COL 0.30-1.7-7TL 45.3N	B	32.3/46.1
L5	6200012880	S.COL 0.30-1.3-6TL 24.5N	T	16.1/41.1
L6	6200007710	S.COL LQW2BHN27NJ03L	T	17.6/36
L7	6200005451	S.COL LL1608-FSL68NJ	T	22.9/25.4
L15	6200012910	S.COL 0.35-1.6-8TL 45.5N	B	35.7/41.1
L16	6200010000	S.COL C2012C-56NG-A	B	38.2/32.4
L18	6200009930	S.COL C2012C-68NG-A	B	30.4/30.3
L19	6200009890	S.COL C2012C-82NG-A	B	35.9/26.4
L20	6200003271	S.COL NLV25T-R56J	B	26.9/21
L24	6200004870	S.COL ELJFC 2R7K-F	B	32.2/39.9
L26	6200003590	S.COL EXCLC3225U1	T	12.2/41.2
L29	6200009531	S.COL ELJRE R15GFA	B	29.9/21.7
L32	6200012570	S.COL 0.26-1.0-3TL 6.8N	T	25.6/43.7
L37	6200006991	S.COL ELJRE 56NGFA	T	24.8/18.4
L38	6200007871	S.COL ELJRF 39NJFB	B	31.8/18.1
L40	6200009351	S.COL ELJRE R22GFA	B	27.8/13.5
L41	6200011031	S.COL ELJRF R10JFB	B	27.1/15.3
L42	6200011001	S.COL ELJRF 56NJFB	B	24.7/16.5
L43	6200007001	S.COL ELJRE 82NGFA	T	19.6/15
L44	6200010100	S.COL C2012C-33NG-A	B	17/11.9
L45	6200010210	S.COL C2012C-22NG-A	B	21.6/11.9
L46	6200001981	S.COL NLV25T-1R0J	B	18.6/15.6
L47	6200012880	S.COL 0.30-1.3-6TL 24.5N	B	29.2/44.2
L48	6200005691	S.COL ELJRE 18NGFA	T	26.7/37.5
L49	6200005691	S.COL ELJRE 18NGFA	T	24.8/28.3
L50	6200003271	S.COL NLV25T-R56J	B	10.1/22.2
L51	6200004480	S.COL MLF1608D R82K-T	T	10.5/22.7
L55	6200003540	S.COL MLF1608D R22K-T	T	10.6/20.5
L57	6200009930	S.COL C2012C-68NG-A	B	34.9/20.3
L58	6200010540	S.COL C2012C-47NG-A	B	35.4/37.8
L59	6200007871	S.COL ELJRF 39NJFB	B	30.9/19.7
R1	7030003670	S.RES ERJ3GEYJ 823 V (82 k)	T	30.9/51.7
R4	7030005090	S.RES ERJ2GEJ 104 X (100 k)	T	8.8/46.9
R5	7030003240	S.RES ERJ3GEYJ 220 V (22)	T	26.6/39.7
R7	7030004990	S.RES ERJ2GEJ 221 X (220)	T	25.4/31.6
R8	7030010020	S.RES ERJ2RKF 154 X (150 k)	T	34.1/8.4
R9	7030010010	S.RES ERJ2RKF 334 X (330 k)	T	34.9/6.5
R10	7030007260	S.RES ERJ2GEJ 330 X (33)	T	26/21.7
R11	7030007300	S.RES ERJ2GEJ 332 X (3.3 k)	T	23.8/22.2
R12	7030007300	S.RES ERJ2GEJ 332 X (3.3 k)	T	22.4/23.4
R13	7030007260	S.RES ERJ2GEJ 330 X (33)	T	22.4/24.3
R14	7030005040	S.RES ERJ2GEJ 472 X (4.7 k)	T	23.6/18.5
R16	7030005300	S.RES ERJ2GEJ 150 X (15)	T	24.8/20.6
R20	7030005220	S.RES ERJ2GEJ 223 X (22 k)	B	24.7/14.7
R21	7030007290	S.RES ERJ2GEJ 222 X (2.2 k)	B	24.6/13.6
R25	7030005120	S.RES ERJ2GEJ 102 X (1 k)	T	6.8/46.8
R27	7030005000	S.RES ERJ2GEJ 471 X (470)	T	6.8/44.4
R28	7030005120	S.RES ERJ2GEJ 102 X (1 k)	T	7.4/37.9
R29	7030005580	S.RES ERJ2GEJ 560 X (56)	T	6.8/45.6
R30	7030008400	S.RES ERJ2GEJ 182 X (1.8 k)	B	4.1/13.4
R31	7030010010	S.RES ERJ2RKF 334 X (330 k)	T	12.2/51
R32	7030010020	S.RES ERJ2RKF 154 X (150 k)	T	11.2/53.2
R33	7030000170	S.RES MCR10EZJH 18 (180)	T	8.9/34.7
R34	7030005090	S.RES ERJ2GEJ 104 X (100 k)	T	8/36.5
R35	7030000160	S.RES MCR10EZJH 15 (150)	T	7/34.5
R36	7030003400	S.RES ERJ3GEYJ 471 V (470)	T	2.7/40.5
R37	7030008280	S.RES ERJ2GEJ 271 X (270)	T	5.6/39.8
R38	7030000190	S.RES MCR10EZJH 27 (270)	T	5.1/34.5
R39	7030000190	S.RES MCR10EZJH 27 (270)	T	3.3/34.5
R40	7030000010	S.RES MCR10EZJH JPW (000)	B	42.5/3.7
R48	7030005050	S.RES ERJ2GEJ 103 X (10 k)	B	31.6/10.4
R49	7030010040	S.RES ERJ2GEJ-JPW	B	31.6/7.7
R50	7030005700	S.RES ERJ2GEJ 274 X (270 k)	B	31.6/9.5
R52	7030005090	S.RES ERJ2GEJ 104 X (100 k)	T	31.6/34.6
R53	7030005050	S.RES ERJ2GEJ 103 X (10 k)	T	32.5/36.6
R54	7030008300	S.RES ERJ2GEJ 184 X (180 k)	T	32.8/31.4
R57	7030005110	S.RES ERJ2GEJ 224 X (220 k)	B	40.4/33.7
R59	7030004980	S.RES ERJ2GEJ 101 X (100)	B	31.6/34.2
R61	7030005530	S.RES ERJ2GEJ 100 X (10)	B	28.1/29.4
R64	7030005110	S.RES ERJ2GEJ 224 X (220 k)	B	36.6/28
R66	7030005110	S.RES ERJ2GEJ 224 X (220 k)	B	36.6/23.5
R68	7030005040	S.RES ERJ2GEJ 472 X (4.7 k)	B	32.6/16.8
R69	7030004980	S.RES ERJ2GEJ 101 X (100)	B	33/19.1
R70	7030008300	S.RES ERJ2GEJ 184 X (180 k)	B	31.9/22.1
R71	7030005000	S.RES ERJ2GEJ 471 X (470)	B	28.8/22.1
R72	7030005310	S.RES ERJ2GEJ 124 X (120 k)	B	31/26.2
R75	7030004990	S.RES ERJ2GEJ 221 X (220)	B	27.8/27.7
R77	7030004980	S.RES ERJ2GEJ 101 X (100)	B	28.8/20.5
R79	7030005000	S.RES ERJ2GEJ 471 X (470)	B	16.1/22
R80	7030005090	S.RES ERJ2GEJ 104 X (100 k)	B	14.5/22
R81	7030005000	S.RES ERJ2GEJ 471 X (470)	B	7.4/22.3
R82	7030005120	S.RES ERJ2GEJ 102 X (1 k)	B	12.5/31.7
R83	7030005000	S.RES ERJ2GEJ 471 X (470)	B	13.5/30.1
R84	7030009280	S.RES ERJ2GEJ 391 X	T	8.8/25.5
R85	7030005030	S.RES ERJ2GEJ 152 X (1.5 k)	T	7.1/25.4
R86	7030005240	S.RES ERJ2GEJ 473 X (47 k)	B	7/30.1
R87	7030007290	S.RES ERJ2GEJ 222 X (2.2 k)	B	8.8/30.1
R88	7030005060	S.RES ERJ2GEJ 333 X (33 k)	B	9.7/30.1

[RF UNIT]

REF NO.	ORDER NO.	DESCRIPTION	M.	H/V LOCATION
R141	7030007290	S.RES ERJ2GEJ 222 X (2.2 k)	T	35.9/15.5
R150	7030005000	S.RES ERJ2GEJ 471 X (470)	B	37.3/18.1
R160	7030000290	S.RES MCR10EZJH 181 (180)	B	30.1/36.5
R161	7030005220	S.RES ERJ2GEJ 223 X (22 k)	T	30/42.6
R162	7030005220	S.RES ERJ2GEJ 223 X (22 k)	T	30.6/44.7
R163	7030007290	S.RES ERJ2GEJ 222 X (2.2 k)	T	29/45.3
R184	7030005050	S.RES ERJ2GEJ 103 X (10 k)	T	6.4/18.9
R185	7030005120	S.RES ERJ2GEJ 102 X (1 k)	T	5.5/22.4
R186	7030005240	S.RES ERJ2GEJ 473 X (47 k)	T	7.3/20.5
R187	7030005090	S.RES ERJ2GEJ 104 X (100 k)	B	32.9/28.2
R210	7030008410	S.RES ERJ2GEJ 392 X (3.9 k)	T	30.9/36.4
R222	7030005240	S.RES ERJ2GEJ 473 X (47 k)	B	35.7/33.2
R244	7030005090	S.RES ERJ2GEJ 104 X (100 k)	B	14.9/24.8
R251	7030005230	S.RES ERJ2GEJ 334 X (330 k)	T	30/34.6
R252	7030005310	S.RES ERJ2GEJ 124 X (120 k)	B	36/32
R258	7030008300	S.RES ERJ2GEJ 184 X (180 k)	B	33.2/33.2
R259	7030005110	S.RES ERJ2GEJ 224 X (220 k)	B	36/30.2
R260	7030005220	S.RES ERJ2GEJ 223 X (22 k)	T	40.5/21.1
R262	7030008370	S.RES ERJ2GEJ 561 X (560)	B	26.3/23.5
R337	7030007310	S.RES ERJ2GEJ 155 X (1.5 M)	B	6.7/13.2
R340	7030005040	S.RES ERJ2GEJ 472 X (4.7 k)	T	27.8/39
R341	7030005240	S.RES ERJ2GEJ 473 X (47 k)	T	27.6/41.8
R357	7030007340	S.RES ERJ2GEJ 153 X (15 k)	T	27.4/33.1
R358	7030005600	S.RES ERJ2GEJ 273 X (27 k)	T	26/30.2
R377	7030008300	S.RES ERJ2GEJ 184 X (180 k)	T	27.8/30.1
R378	7030005240	S.RES ERJ2GEJ 473 X (47 k)	T	27.8/29.2
R379	7030005090	S.RES ERJ2GEJ 104 X (100 k)	T	28/26.4
R380	7030005170	S.RES ERJ2GEJ 474 X (470 k)	T	28/28
R402	7030010040	S.RES ERJ2GEJ-JPW	B	9.4/8.7
R417	7030010040	S.RES ERJ2GEJ-JPW	B	31.2/15.3
R418	7030010040	S.RES ERJ2GEJ-JPW	B	31.7/16.5
R419	7030005120	S.RES ERJ2GEJ 102 X (1 k)	B	31.7/14.1
R420	7030007290	S.RES ERJ2GEJ 222 X (2.2 k)	T	27.4/14
R421	7030010040	S.RES ERJ2GEJ-JPW	B	26.7/16.1
R422	7030005000	S.RES ERJ2GEJ 471 X (470)	B	27.8/11.4
R423	7030005050	S.RES ERJ2GEJ 103 X (10 k)	B	26.5/10.2
R424	7030005040	S.RES ERJ2GEJ 472 X (4.7 k)	B	26.3/12
R425	7030004980	S.RES ERJ2GEJ 101 X (100)	B	25.6/8.3
R426	7030005000	S.RES ERJ2GEJ 471 X (470)	B	25.5/4.8
R427	7030005050	S.RES ERJ2GEJ 103 X (10 k)	B	24.2/5.8
R428	7030008410	S.RES ERJ2GEJ 392 X (3.9 k)	B	24.6/7
R429	7030005710	S.RES ERJ2GEJ 121 X (120)	B	23.2/4.9
R430	7030007250	S.RES ERJ2GEJ 220 X (22)	B	24.2/11.3
R431	7030005050	S.RES ERJ2GEJ 103 X (10 k)	B	22.9/14.1
R432	7030007310	S.RES ERJ2GEJ 155 X (1.5 M)	T	17.7/17
R433	7030004970	S.RES ERJ2GEJ 470 X (47)	B	21.8/4.6
R434	7030005050	S.RES ERJ2GEJ 103 X (10 k)	B	19.4/6.1
R435	7030009270	S.RES ERJ2GEJ 821 X (820)	B	22.7/6.7
R436	7030007350	S.RES ERJ2GEJ 393 X (39 k)	B	17.7/7.2
R437	7030005040	S.RES ERJ2GEJ 472 X (4.7 k)	B	23.3/9.8
R438	7030005120	S.RES ERJ2GEJ 102 X (1 k)	B	19.3/10.8
R439	7030005240	S.RES ERJ2GEJ 473 X (47 k)	B	20.7/9.7
R440	7030005090	S.RES ERJ2GEJ 104 X (100 k)	B	16.5/5.3
R441	7030007320	S.RES ERJ2GEJ 225 X (2.2 M)	B	18.6/4.8
R442	7030005120	S.RES ERJ2GEJ 102 X (1 k)	B	17.7/4.8
R443	7030005220	S.RES ERJ2GEJ 223 X (22 k)	T	35.7/10.6
R444	7030005050	S.RES ERJ2GEJ 103 X (10 k)	T	36.6/12.9
R445	7030009290	S.RES ERJ2GEJ 562 X (5.6 k)	T	11.2/13.1
R446	7030005010	S.RES ERJ2GEJ 681 X (680)	T	7.3/18.9
R447	7030005010	S.RES ERJ2GEJ 681 X (680)	T	2.4/11.6
R448	7030007570	S.RES ERJ2GEJ 122 X (1.2 k)	T	2.4/10.7
R449	7030004980	S.RES ERJ2GEJ 101 X (100)	T	7.3/15.5
R455	7030005090	S.RES ERJ2GEJ 104 X (100 k)	B	13.8/20.3
R456	7030010040	S.RES ERJ2GEJ-JPW	B	12.8/20.3
R457	7030005050	S.RES ERJ2GEJ 103 X (10 k)	T	15.7/13.9
R458	7030005050	S.RES ERJ2GEJ 103 X (10 k)	T	15.7/14.8
R459	7030005050	S.RES ERJ2GEJ 103 X (10 k)	T	15.7/16.6
R460	7030008290	S.RES ERJ2GEJ 183 X (18 k)	T	16.4/18.6
R463	7030007060	S.RES ERJ2GEJ 684X (680 k)	T	12.4/18.6
R465	7030005120	S.RES ERJ2GEJ 102 X (1 k)	T	12.7/21.5
R466	7030005120	S.RES ERJ2GEJ 102 X (1 k)	B	28.8/30.9
R467	7030005110	S.RES ERJ2GEJ 224 X (220 k)	B	37.8/21.3
R469	7030005120			

[RF UNIT]

REF NO.	ORDER NO.	DESCRIPTION	M.	H/V LOCATION
C14	4030016790	S.CER ECJ0EB1C103K	T	17.1/37.9
C15	4030007090	S.CER C1608 CH 1H 470J-T	T	25.7/36.2
C16	4030017460	S.CER ECJ0EB1E102K	T	9.9/46.9
C17	4030017460	S.CER ECJ0EB1E102K	T	25.4/32.5
C18	4030017460	S.CER ECJ0EB1E102K	B	27.4/33.1
C19	4030016790	S.CER ECJ0EB1C103K	T	16.9/33.3
C20	4030017460	S.CER ECJ0EB1E102K	T	13.5/37
C21	4550006480	S.TAN TEESVA 1C 475M8R	T	15.1/37.2
C22	4030017430	S.CER ECJ0EC1H101J	T	26/26.8
C23	4030017460	S.CER ECJ0EB1E102K	T	26/22.6
C24	4030017460	S.CER ECJ0EB1E102K	T	21.1/23.9
C25	4030017460	S.CER ECJ0EB1E102K	T	24.8/22.2
C26	4030017460	S.CER ECJ0EB1E102K	T	23.9/20.6
C30	4030016970	S.CER ECJ0EB1C223K	T	20.6/50.4
C31	4030017420	S.CER ECJ0EC1H470J	B	33.3/7.8
C32	4030016970	S.CER ECJ0EB1C223K	T	10.9/47.9
C33	4030017460	S.CER ECJ0EB1E102K	B	33.2/5.5
C34	4030016930	S.CER ECJ0EB1A104K	T	12.2/53.2
C35	4030006900	S.CER C1608 JB 1H 103K-T	T	20.4/52.2
C36	4030017460	S.CER ECJ0EB1E102K	T	20.6/49.5
C37	4030017460	S.CER ECJ0EB1E102K	B	35.2/5.7
C38	4030017420	S.CER ECJ0EC1H470J	B	41.1/7
C39	4030017460	S.CER ECJ0EB1E102K	B	40.4/2.9
C41	4030017440	S.CER ECJ0EC1H221J	B	40.4/4.5
C50	4550006250	S.TAN TEESVA 1A 106M8R	B	3.5/9.8
C52	4030007080	S.CER C1608 CH 1H 390J-T	B	39.2/42.4
C54	4030017460	S.CER ECJ0EB1E102K	B	10/10.5
C70	4030017460	S.CER ECJ0EB1E102K	B	31.6/8.6
C73	4030016930	S.CER ECJ0EB1A104K	T	31.6/35.5
C75	4030016930	S.CER ECJ0EB1A104K	T	30/35.5
C76	4030007040	S.CER C1608 CH 1H 180J-T	B	36.4/45.1
C79	4030017590	S.CER ECJ0EC1H070C	B	37.2/36.1
C81	4030017440	S.CER ECJ0EC1H221J	B	37.6/34.8
C82	4030017460	S.CER ECJ0EB1E102K	B	42/33.9
C87	4030016790	S.CER ECJ0EB1C103K	B	31.6/32.4
C88	4030017460	S.CER ECJ0EB1E102K	B	31.6/33.3
C89	4030017460	S.CER ECJ0EB1E102K	B	33.4/29.4
C90	4030017460	S.CER ECJ0EB1E102K	B	29.4/33.8
C92	4030017690	S.CER ECJ0EC1H121J	B	35/28.9
C93	4030017460	S.CER ECJ0EB1E102K	B	38.6/28
C94	4030017340	S.CER ECJ0EC1H010B	B	33.8/26.6
C95	4030017460	S.CER ECJ0EB1E102K	B	38.8/23.5
C96	4030017680	S.CER ECJ0EC1H820J	B	35.1/24.8
C97	4030017340	S.CER ECJ0EC1H010B	B	35/28
C99	4030017460	S.CER ECJ0EB1E102K	B	33/18.2
C102	4030017600	S.CER ECJ0EC1H080C	B	31/22.1
C104	4030017460	S.CER ECJ0EB1E102K	B	28/25.9
C105	4030016790	S.CER ECJ0EB1C103K	B	28/26.8
C106	4030017390	S.CER ECJ0EC1H180J	B	25.1/22.2
C107	4030017460	S.CER ECJ0EB1E102K	B	30.2/27.8
C108	4030016790	S.CER ECJ0EB1C103K	B	31.1/27.8
C110	4030017380	S.CER ECJ0EC1H050B	B	15.8/24.2
C111	4030016790	S.CER ECJ0EB1C103K	B	7.7/20
C112	4030017460	S.CER ECJ0EB1E102K	B	14.5/30.1
C113	4030017460	S.CER ECJ0EB1E102K	B	12.5/30.1
C114	4030017040	S.CER ECJ0EB1A333K	B	14.3/26.9
C115	4030017460	S.CER ECJ0EB1E102K	B	13.9/23.7
C116	4030017680	S.CER ECJ0EC1H820J	B	13.9/28.1
C117	4030017460	S.CER ECJ0EB1E102K	B	4.6/27.1
C118	4030016790	S.CER ECJ0EB1C103K	B	11.5/30.1
C119	4030018860	S.CER ECJ0EB0J105K	B	4.6/26.2
C120	4030016930	S.CER ECJ0EB1A104K	B	4.6/28
C121	4030017440	S.CER ECJ0EC1H221J	B	6/30.1
C122	4030017440	S.CER ECJ0EC1H221J	B	7.9/30.1
C123	4030017460	S.CER ECJ0EB1E102K	B	42/18.5
C138	4030017460	S.CER ECJ0EB1E102K	B	36/31.1
C162	4030016790	S.CER ECJ0EB1C103K	T	41.4/20
C173	4510008500	S.ELE EEE1CA101WP	T	30.3/22
C204	4030017460	S.CER ECJ0EB1E102K	B	30.1/39.4
C205	4030006860	S.CER C1608 JB 1H 102K-T	B	32.2/42.9
C233	4030017460	S.CER ECJ0EB1E102K	T	6.4/20.5
C234	4030017460	S.CER ECJ0EB1E102K	T	6.4/22.4
C236	4030016790	S.CER ECJ0EB1C103K	B	38/19.5
C243	4030017460	S.CER ECJ0EB1E102K	T	32.5/38.4
C244	4030016790	S.CER ECJ0EB1C103K	B	39.3/18.7
C251	4030017460	S.CER ECJ0EB1E102K	T	30.6/45.7
C252	4030017460	S.CER ECJ0EB1E102K	T	31.4/40.5
C277	4030017510	S.CER ECJ0EC1H680J	B	34.2/33.2
C278	4030007040	S.CER C1608 CH 1H 180J-T	B	29.7/42.3
C281	4030010760	S.CER C1608 CH 1H 331J-T	B	30.2/46.7
C285	4030009650	S.CER C1608 CH 1H 240J-T	B	28.9/46.7
C287	4030007050	S.CER C1608 CH 1H 220J-T	B	33/50.5
C288	4030017460	S.CER ECJ0EB1E102K	B	30.1/38.5
C289	4030017460	S.CER ECJ0EB1E102K	T	13.5/38.6
C293	4030016930	S.CER ECJ0EB1A104K	T	16.4/17.7
C298	4550005980	S.TAN TEESVA 1A 475M8R	B	27.8/37.6
C300	4030017460	S.CER ECJ0EB1E102K	B	25.1/11.3
C301	4030017460	S.CER ECJ0EB1E102K	B	3.1/13.4
C303	4030017460	S.CER ECJ0EB1E102K	B	13.9/25.3
C351	4030017570	S.CER ECJ0EC1H040B	B	25.4/23.9
C386	4030017590	S.CER ECJ0EC1H070C	T	6.6/23.7
C387	4030017360	S.CER ECJ0EC1H030B	T	7.9/22.2
C398	4550005980	S.TAN TEESVA 1A 475M8R	T	36.4/21.7
C412	4030016790	S.CER ECJ0EB1C103K	T	32.5/27.1
C413	4030017460	S.CER ECJ0EB1E102K	B	4.9/5.7
C421	4030016930	S.CER ECJ0EB1A104K	B	4.8/30.1
C422	4030016930	S.CER ECJ0EB1A104K	B	10.6/30.1
C429	4030018860	S.CER ECJ0EB0J105K	B	7/11.9
C430	4030016790	S.CER ECJ0EB1C103K	B	7/10.1
C433	4030017390	S.CER ECJ0EC1H180J	T	23.7/16.7
C434	4030017390	S.CER ECJ0EC1H180J	T	26/20.8
C435	4030017640	S.CER ECJ0EC1H150J	B	31.5/20.9
C437	4030017640	S.CER ECJ0EC1H150J	B	30.8/16.5
C438	4030017460	S.CER ECJ0EB1E102K	B	30.8/13.4

[RF UNIT]

REF NO.	ORDER NO.	DESCRIPTION	M.	H/V LOCATION
C439	4030017340	S.CER ECJ0EC1H010B	T	24.4/14.1
C440	4030017600	S.CER ECJ0EC1H080C	B	27.8/16.1
C441	4030017460	S.CER ECJ0EB1E102K	T	23.1/12.3
C442	4030017460	S.CER ECJ0EB1E102K	B	26.4/11.1
C443	4030017420	S.CER ECJ0EC1H470J	B	27.3/9.2
C444	4030017570	S.CER ECJ0EC1H040B	B	24.9/10.1
C445	4030017530	S.CER ECJ0EC1H0R5B	B	24.9/9.2
C446	4030017400	S.CER ECJ0EC1H220J	B	27.3/8.3
C447	4030017340	S.CER ECJ0EC1H010B	B	27.1/4.4
C448	4030017340	S.CER ECJ0EC1H010B	B	22.6/5.8
C449	4030017460	S.CER ECJ0EB1E102K	B	24.6/4.6
C450	4030017460	S.CER ECJ0EB1E102K	B	25.5/6.4
C451	4030017360	S.CER ECJ0EC1H030B	B	23.7/12.9
C452	4030017570	S.CER ECJ0EC1H040B	B	21.4/15.3
C453	4030017420	S.CER ECJ0EC1H470J	B	21.1/16.5
C454	4030017360	S.CER ECJ0EC1H030B	T	19.8/16.5
C455	4030017360	S.CER ECJ0EC1H030B	T	18.6/17
C456	4030007040	S.CER C1608 CH 1H 180J-T	B	22.9/7.8
C457	4030007050	S.CER C1608 CH 1H 220J-T	B	20.3/7.6
C458	4030017460	S.CER ECJ0EB1E102K	B	20/4.6
C459	4030017460	S.CER ECJ0EB1E102K	T	30.6/8.7
C460	4030007020	S.CER C1608 CH 1H 120J-T	B	17.2/9.6
C461	4030017460	S.CER ECJ0EB1E102K	B	19.2/12
C462	4030017460	S.CER ECJ0EB1E102K	B	23.3/8.9
C463	4030017460	S.CER ECJ0EB1E102K	B	18.6/7.4
C464	4030006910	S.CER C1608 CH 1H 0R5C-T	B	15.9/9.6
C465	4030017460	S.CER ECJ0EB1E102K	B	16.5/4.4
C466	4030007110	S.CER C1608 CH 1H 680J-T	B	27.8/41.7
C467	4030007010	S.CER C1608 CH 1H 100J-T	T	26.3/46.5
C471	4030011600	S.CER C1608 JB 1E 104K-T	T	35.6/11.8
C472	4550004040	S.TAN TEESVA 0J 685M8R	T	1.3/14.7
C473	4550000550	S.TAN TEESVA 1V 224M8R	T	1.3/7.7
C474	4550000530	S.TAN TEESVA 1V 104M8R	T	3.4/14.6
C475	4030017460	S.CER ECJ0EB1E102K	T	2.8/18.1
C476	4030017460	S.CER ECJ0EB1E102K	T	11.2/12.2
C478	4030017460	S.CER ECJ0EB1E102K	B	27.2/23.5
C479	4030016790	S.CER ECJ0EB1C103K	B	15.1/22.9
C482	4030017460	S.CER ECJ0EB1E102K	B	10.4/19.9
C486	4030016930	S.CER ECJ0EB1A104K	B	9.4/9.6
C487	4030017420	S.CER ECJ0EC1H470J	T	13.9/19.3
C488	4030017730	S.CER ECJ0EB1E471K	T	14.3/20.5
C489	4030017460	S.CER ECJ0EB1E102K	B	7/11
C491	4030017500	S.CER ECJ0EC1H560J	T	10.3/21.6
C492	4030017570	S.CER ECJ0EC1H040B	T	8.8/22.2
C493	4030017460	S.CER ECJ0EB1E102K	T	15/22
C496	4030016790	S.CER ECJ0EB1C103K	T	12.7/20.5
C497	4030017380	S.CER ECJ0EC1H050B	T	10.4/16.3
C499	4030017360	S.CER ECJ0EC1H030B	B	32/30.4
C500	4030018860	S.CER ECJ0EB0J105K	B	27.9/31
C502	4030017350	S.CER ECJ0EC1H020B	B	33.8/28.2
C503	4030017340	S.CER ECJ0EC1H010B	B	33.8/25
C504	4030017340	S.CER ECJ0EC1H010B	B	33.8/23.4
C505	4030017430	S.CER ECJ0EC1H101J	B	35/22.4
C506	4030017460	S.CER ECJ0EB1E102K	B	40/21.3
C507	4030017350	S.CER ECJ0EC1H020B	B	36.6/21
C509	4030017460	S.CER ECJ0EB1E102K	B	12.4/8.7
C510	4030007120	S.CER C1608 CH 1H 820J-T	T	27.5/46.5
C511	4030017460	S.CER ECJ0EB1E102K	T	29.3/17.2
C512	4030017460	S.CER ECJ0EB1E102K	T	29/38.2
C516	4030007030	S.CER C1608 CH 1H 150J-T	B	39.2/36
C518	4030017460	S.CER ECJ0EB1E102K	T	19.7/12.8
C519	4340000260	S.MLR ECPU1C104MA5	B	16.1/15.2
C521	4030017460	S.CER ECJ0EB1E102K	B	8.2/10
C522	4030018860	S.CER ECJ0EB0J105K	B	31.6/12.2
C523	4030018860	S.CER ECJ0EB0J105K	B	31.6/11.3
C534	4030017650	S.CER ECJ0EC1H270J	B	30.9/18.1
C536	4030009510	S.CER C1608 CH 1H 010B-T	B	32.3/48.6
C537	4030009510	S.CER C1608 CH 1H 010B-T	B	29.7/40.5
C538	4030017460	S.CER ECJ0EB1E102K	B	32.4/23.4
C539	4030017460	S.CER ECJ0EB1E102K	B	31/23.7
C541	4030017420	S.CER ECJ0EC1H470J	B	3.1/30.2
C542	4030017460	S.CER ECJ0EB1E102K	B	24.8/15.6
C543	4030017420	S.CER ECJ0EC1H470J	T	36.4/9.4
C544	4030017420	S.CER ECJ0EC1H470J	T	37.4/9.4
C545	4030017420	S.CER ECJ0EC1H470J	T	39.6/8.6
C546	4030017420	S.CER ECJ0EC1H470J	T	23.2/1.6
C548	4030017420	S.CER ECJ0EC1H470J	T	22.3/2
C549	4030017420	S.CER ECJ0EC1H470J	T	21.4/2
C550	4030017420	S.CER ECJ0EC1H470J	T	20.5/2
C552	4030017420	S.CER ECJ0EC1H470J	T	19.6/2
C553	4030017420	S.CER ECJ0EC1H470J	T	18.7/2
C556	4030017420	S.CER ECJ0EC1H470J	T	17.8/2
C565	4030017420	S.CER ECJ0EC1H470J	T	13.8/2
C566	4030017420	S.CER ECJ0EC1H470J	T	12.9/2
C567	4030017420	S.CER ECJ0EC1H470J	T	12/2
C601	4030017460	S.CER ECJ0EB1E102K	B	32/28.1
C602	4030017460	S.CER ECJ0EB1E102K	B	29.3/27.8

SECTION 7 MECHANICAL PARTS AND DISASSEMBLY

[CHASSIS PARTS]

REF NO.	ORDER NO.	DESCRIPTION	QTY.
MP1	8010020620	2964 CHASSIS	1
MP2	8210023390	2964 T-FRONT PANEL (incl. MP4, 5, 6, 7, 12, 14, 24) Except [THA]	1
	8210023470	2964 T-FRONT PANEL (A) (incl. MP4, 5, 6, 7, 12, 14, 24) [THA]	1
MP3	8210023400	2964 REAR PANEL	1
MP4	8310068430	2964 WINDOW PLATE	1
MP5	8930071230	2964 WINDOW SHEET	1
MP6	8210023410	2964 PTT PANEL	1
MP7	8930071120	2964 PTT BUTTON	1
MP8	8930071130	2964 JACK CAP	1
MP9	8930071110	2964 DC CAP	1
MP10	8930071150	2964 T-KEY	1
MP11	8930071180	2964 MAIN SEAL	1
MP12	8930071190	2964 PTT RUBBER	1
MP13	8930071200	2964 JACK PLATE	1
MP14	8930050220	1903 SP NET	1
MP15	8830001340	1903 HEX NUT	1
MP16	8830001250	ANT CONNECTOR-101 nut	1
MP17	8610012170	KNOB N-326	1
MP18	8930051290	2251 OPT SHEET	1
MP19	8930059360	2600 RELEASE BUTTON	1
MP20	8930063030	2721 RELEASE PLATE	1
MP21	8930048840	2135 MIC SPONGE	1
MP22	8930056540	Push spring (AH)	2
MP23	8930055870	O-ring (AO)	1
MP24	8930046020	1123 SHEET (A)-1	1
MP25	8610009240	knob spring NO.7800P	1
MP26	8810008641	0 tap 1 flat washer B0 2X4 NI-ZC3 (BT)	5
MP27	8810010191	Screw BiH M2X4 SUS SSBC	2
MP28	8810009511	Screw BT B0 2X4 NI-ZC3 (BT)	7
MP29	8810009221	Screw BT B0 2X8 NI-ZK3 (BT)	2
MP30	8810009561	Screw BT B0 2X6 NI-ZK3 (BT)	3

[LOGIC UNIT]

REF NO.	ORDER NO.	DESCRIPTION	QTY.
DS4	5030002970	S10996	1
MC1	7700002710	EM6027P-46C33-G	1
S3	2260002840	SKHLLFA010	1
S801	7600000210	TP70N00E2015F-1903	1
S802	2260002840	SKHLLFA010	1
SP1	2510000840	CS028014-12	1
W5	8900016360	OPC-1190A	1
W6	8900016400	OPC-1715	1
EP1	8930071440	SRCN-2964-SP-N-W	1
MP1	8210023420	2964 REFLECTOR	1
MP2	8930071210	2964 LCD HOLDER	1
MP3	8510018220	2964 LOGIC SHIELD	1

[RF UNIT]

REF NO.	ORDER NO.	DESCRIPTION	QTY.
J1	6450000870	HEC2711-01-020	1
J2	6510023521	54104-3696	1
J3	6510025910	BNC-R169	1
MP1*	8510018120	2964 VCO CASE	1
MP2	8950005512	2403 CONTACT SPRING -2	1
MP5*	8410002650	2964 PA HEATSINK	1
MP6	8510016120	2721 VCO COVER	1
MP7	8930072060	Shield sponge (BU)	1
MP8	8510017480	2964 RF SHIELD	1
MP9	8930072250	2964 ANT SPRING	1

*: Refer to SECTION 9 BOARD LAYOUTS.

[ACCESSORIES]

REF NO.	ORDER NO.	DESCRIPTION	QTY.
EP1	OptionalProduct	BP-226 EXP [USA], [EUR], [TPE], [THA], [EXP]	1
	OptionalProduct	BP-227 [USA-2], [EUR-1], [UK], [KOR], [TPE-2], [EXP-2]	1
EP2	OptionalProduct	BC-167D [UK],[EXP-2]	1
	OptionalProduct	BC-167A [USA-2], [TPE-2]	1
EP3	OptionalProduct	FA-B2E	1
EP5	6910018620	BLACK HANDY STRAP	1
MP1	OptionalProduct	MB-98	1
MP2	8930051290	2251 OPTION SHEET	1

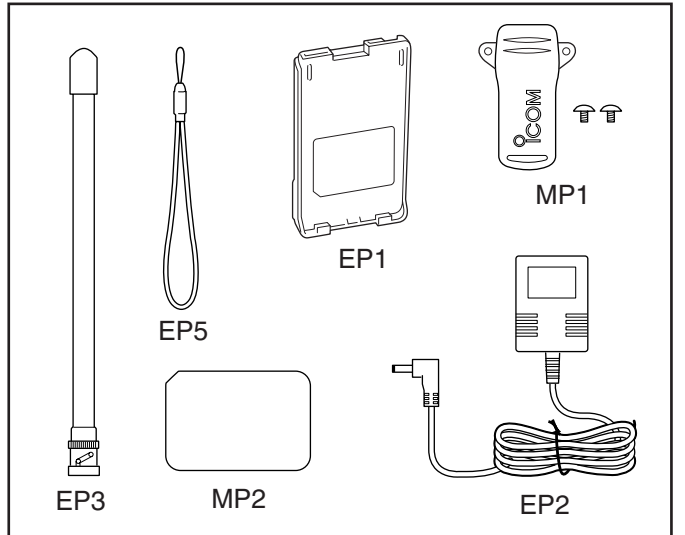

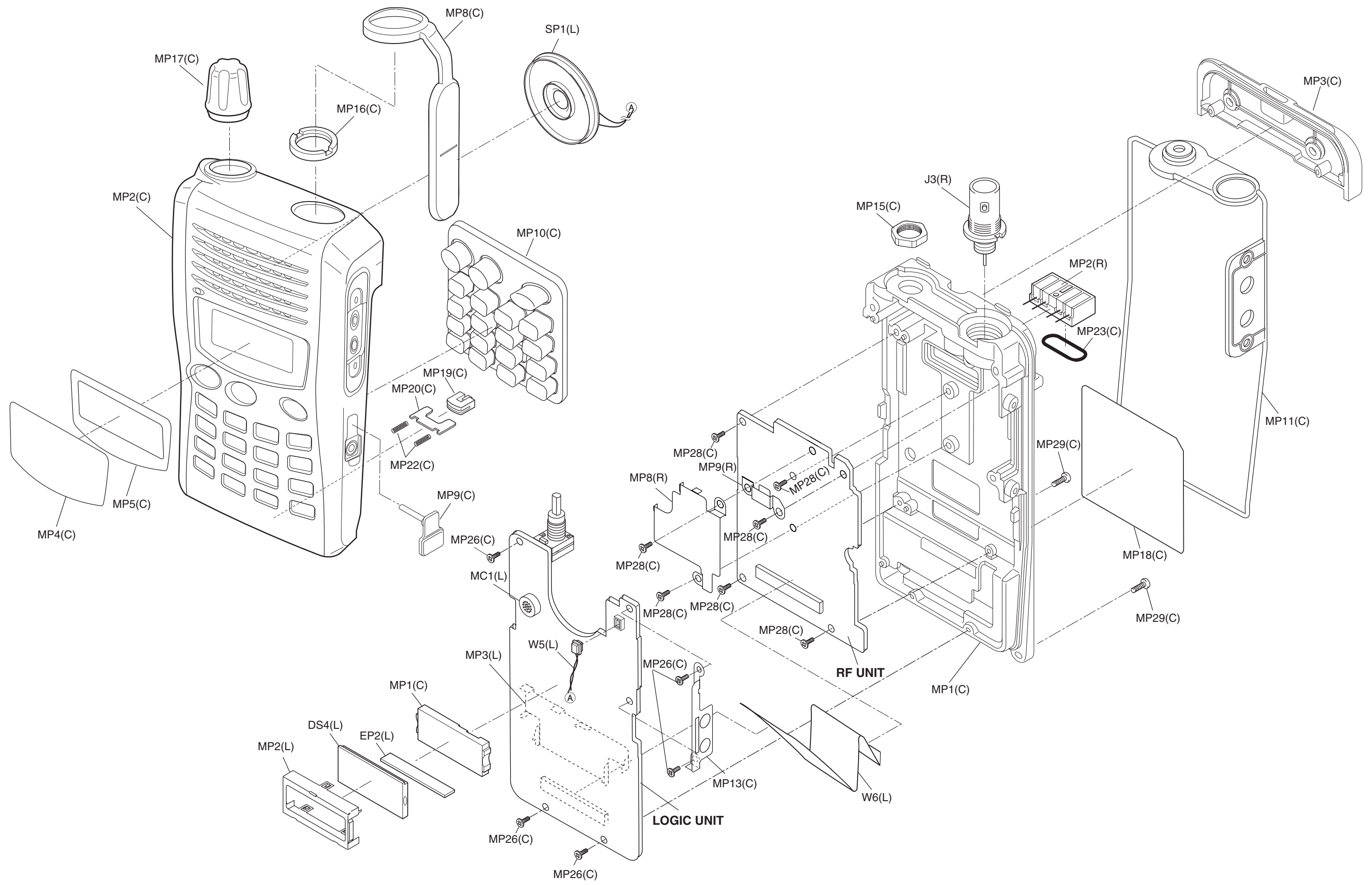





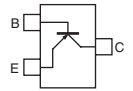
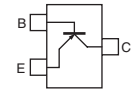
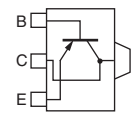
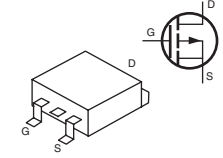
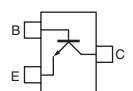
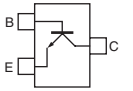
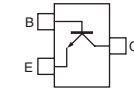
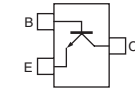
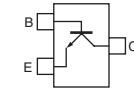
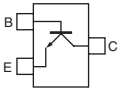
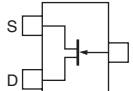
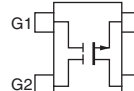
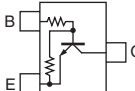
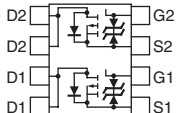
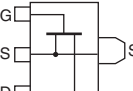
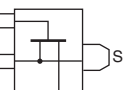
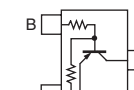
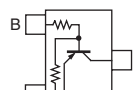
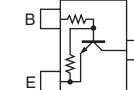
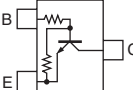
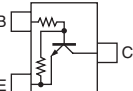
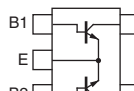
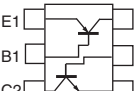
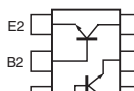



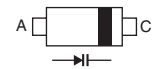
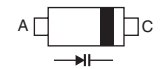
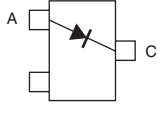
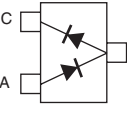

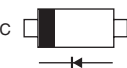
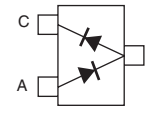

SECTION 8 SEMICONDUCTOR INFORMATION

• TRANSISTERS AND FETs

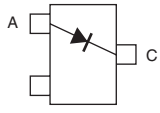
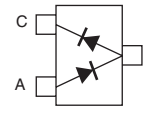
<p>• 2SA1576A (Marking: FQ)</p> 	<p>• 2SA1588 (Marking: ZY)</p> 	<p>• 2SB1132 (Marking: BA)</p> 	<p>• 2SB1201S (Marking: TP-FA)</p> 	<p>• 2SC4116 (Marking: LY)</p> 
<p>• 2SC4211 (Marking: LY)</p> 	<p>• 2SC4617 (Marking: BR)</p> 	<p>• 2SC5006 (Marking: 24)</p> 	<p>• 2SC5085 (Marking: MCY)</p> 	<p>• 2SC5231 (Marking: CY)</p> 
<p>• 2SK1069 (Marking: FJ)</p> 	<p>• 3SK318YB (Marking: YB)</p> 	<p>• DTC144EUA (Marking: 26)</p> 	<p>• HAT1026R (Marking: 1026)</p> 	<p>• RD01MUS1 (Marking: K2)</p> 
<p>• RD12MVS1 (Marking: RD12M)</p> 	<p>• UNR9113J (Marking: 6A)</p> 	<p>• UNR911FJ (Marking: 6A)</p> 	<p>• UNR9210J (Marking: 6A)</p> 	<p>• UNR9213J (Marking: 6A)</p> 
<p>• UNR921NJ (Marking: 6A)</p> 	<p>• XP1501 (Marking: 5R)</p> 	<p>• XP4601 (Marking: 5H)</p> 	<p>• XP6501 (Marking: 5H)</p> 	

• DIODES

<p>• 1SV271 (Marking: TG)</p> 	<p>• 1SV286 (Marking: T7)</p> 	<p>• SB07-03C-TB-E (Marking: J)</p> 	<p>• DA221 (Marking: K)</p> 	<p>• HVC350BTRF (Marking: B2)</p> 
<p>• HVC375BTRF (Marking: B8)</p> 	<p>• HVC376BTR (Marking: B9)</p> 	<p>• HVU131TRF (Marking: P1)</p> 	<p>• 1SS400 (Marking: A)</p> 	<p>• MA133 (Marking: MP)</p> 
<p>• MA2S077 (Marking: 5)</p> 	<p>• MA2S111 (Marking: A)</p> 	<p>• MA2S30400L (Marking: K)</p> 	<p>• MA2S728 (Marking: K)</p> 	<p>• MA728 (Marking: W1Z)</p> 
<p>• MA742 (Marking: M1U)</p> 	<p>• MA77 (Marking: 4B)</p> 	<p>• MA8056-M (Marking: 82)</p> 	<p>• MA8082-M (Marking: 56)</p> 	<p>• RB060L-40 (Marking: 36)</p> 

The combination of this side and the bottom side shows the board layout in the same configuration as the actual P.C.Board.

• RF UNIT (TOP VIEW)

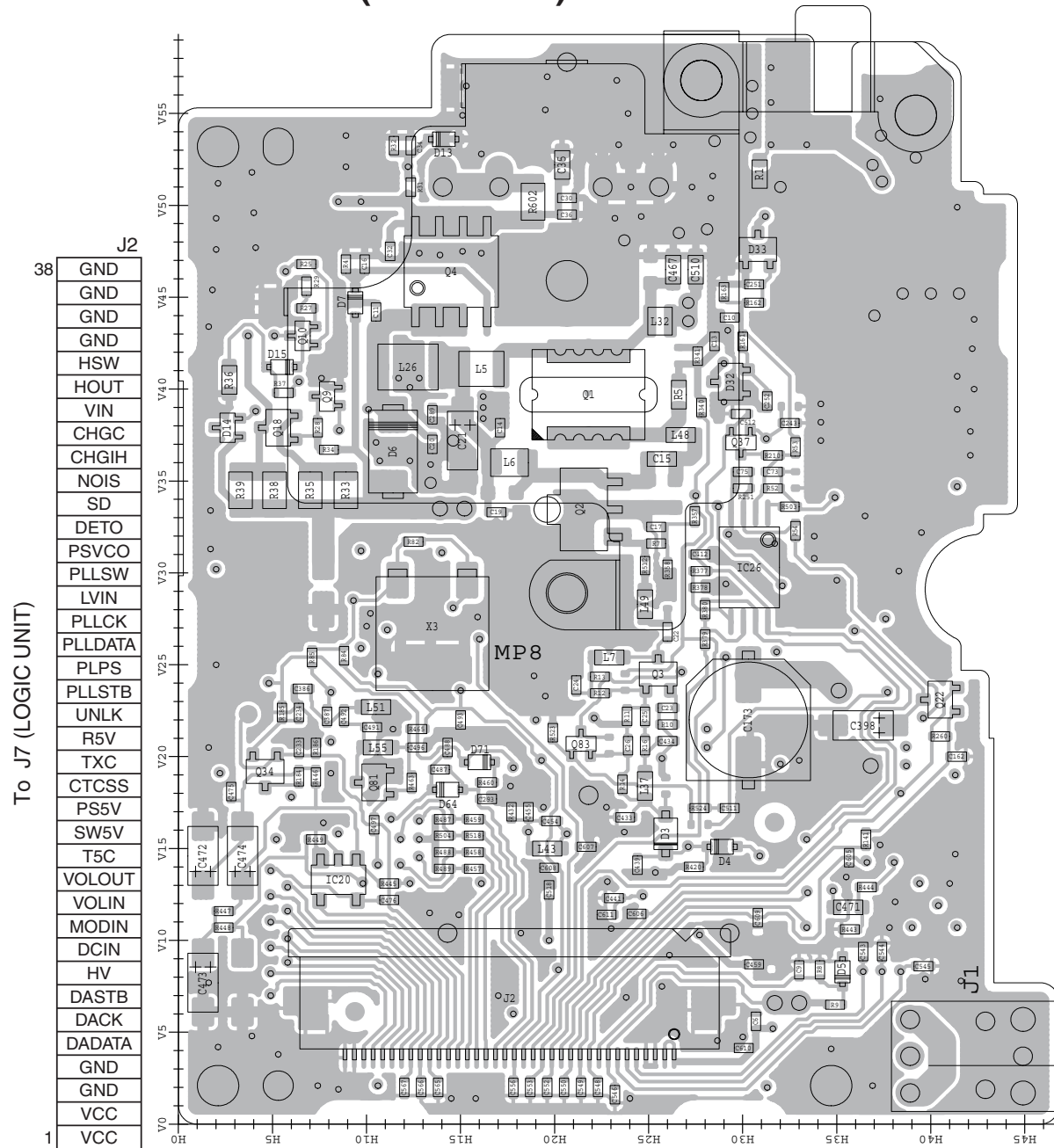

• LOGIC UNIT (TOP VIEW)

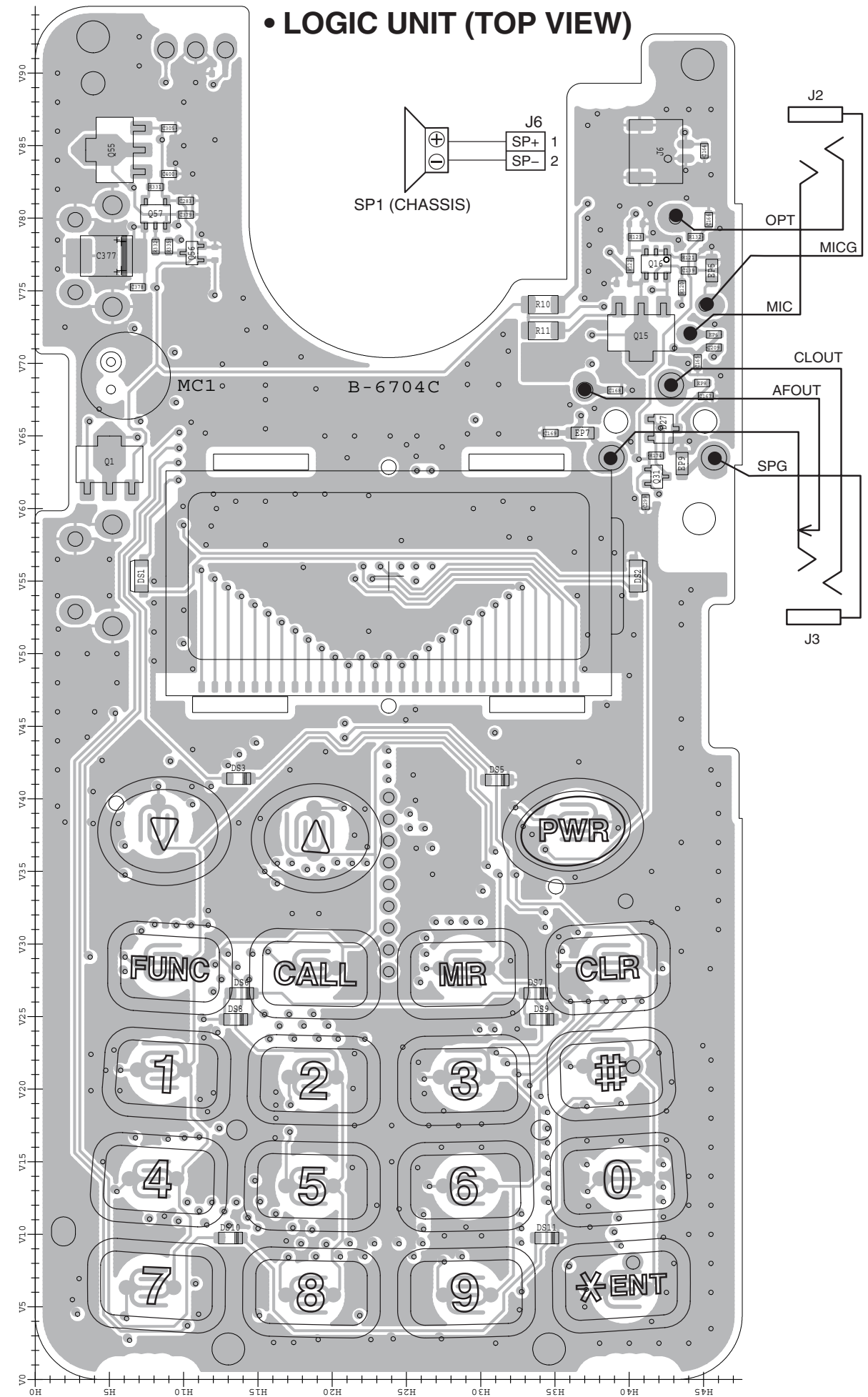

SECTION 11

VOLTAGE DIAGRAMS

11-1 LOGIC UNIT

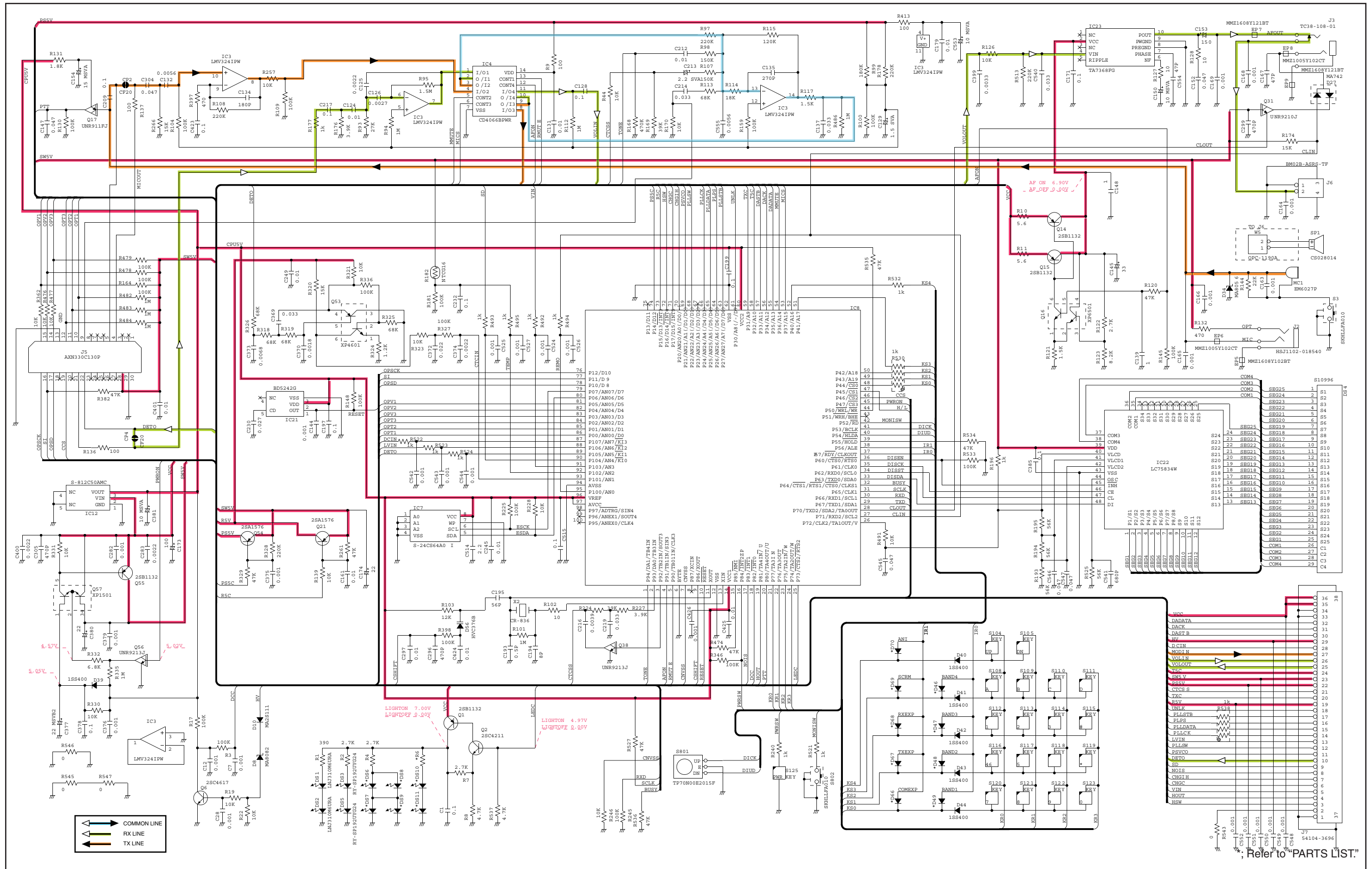

11-2 RF UNIT

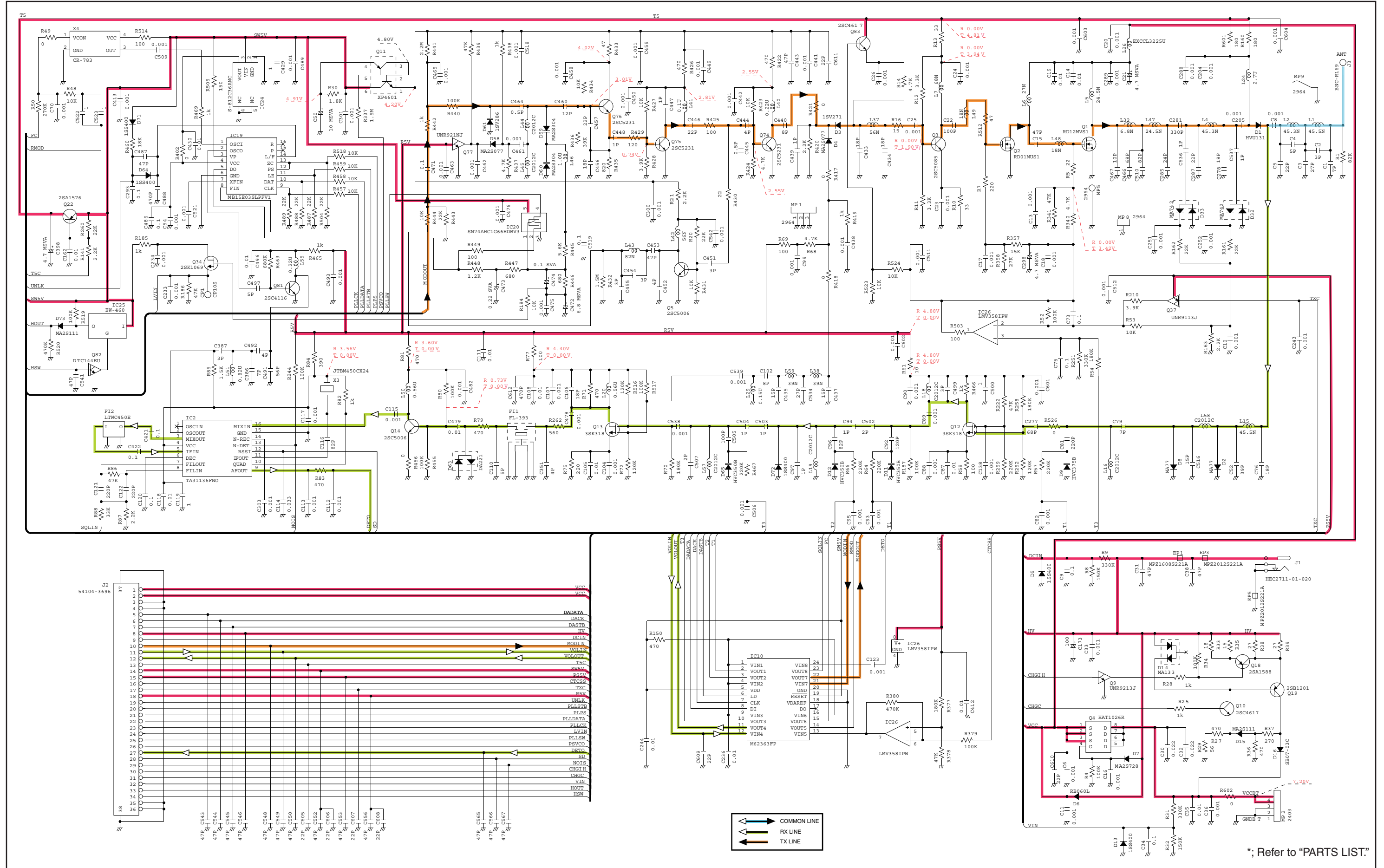

SECTION 12

UT-108 (Optional Product)

• PARTS LIST

[MAIN UNIT]

REF NO.	ORDER NO.	DESCRIPTION
IC1	1130007561	S.IC LC73881M-TLM-E
IC2	1130007301	S.IC TC4W66FU (TE12L,F)
X1	6050005090	XTL CR-245 (4.194304 MHz)
L1	6200001260	S.COL MLF2012A 1R8M-T
R1	7030005120	S.RES ERJ2GEJ 102 X (1 k)
R2	7030005120	S.RES ERJ2GEJ 102 X (1 k)
R3	7030005090	S.RES ERJ2GEJ 104 X (100 k)
R4	7030005120	S.RES ERJ2GEJ 102 X (1 k)
R5	7030005120	S.RES ERJ2GEJ 102 X (1 k)
R6	7030005120	S.RES ERJ2GEJ 102 X (1 k)
R7	7030005090	S.RES ERJ2GEJ 104 X (100 k)
R8	7030005090	S.RES ERJ2GEJ 104 X (100 k)
R9	7030007340	S.RES ERJ2GEJ 153 X (15 k)
R10	7030008410	S.RES ERJ2GEJ 392 X (3.9 k)
C1	4550006980	S.TAN TEESVA2 1A 475M8R
C2	4030017460	S.CER ECJ0EB1E102K
C3	4030017420	S.CER ECJ0EC1H470J
C4	4030016930	S.CER ECJ0EB1A104K
C5	4030016930	S.CER ECJ0EB1A104K
C6	4030016930	S.CER ECJ0EB1A104K
C7	4030016930	S.CER ECJ0EB1A104K
J1	6510025230	S.CNR AXK640345J

[ACCESSORY]

REF NO.	ORDER NO.	DESCRIPTION	QTY.
MP1	8930070290	SPONGE(JC)	1

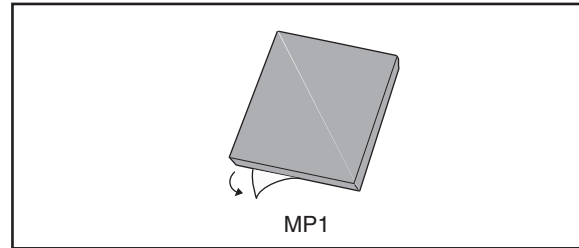

• SCHEMATIC DIAGRAM

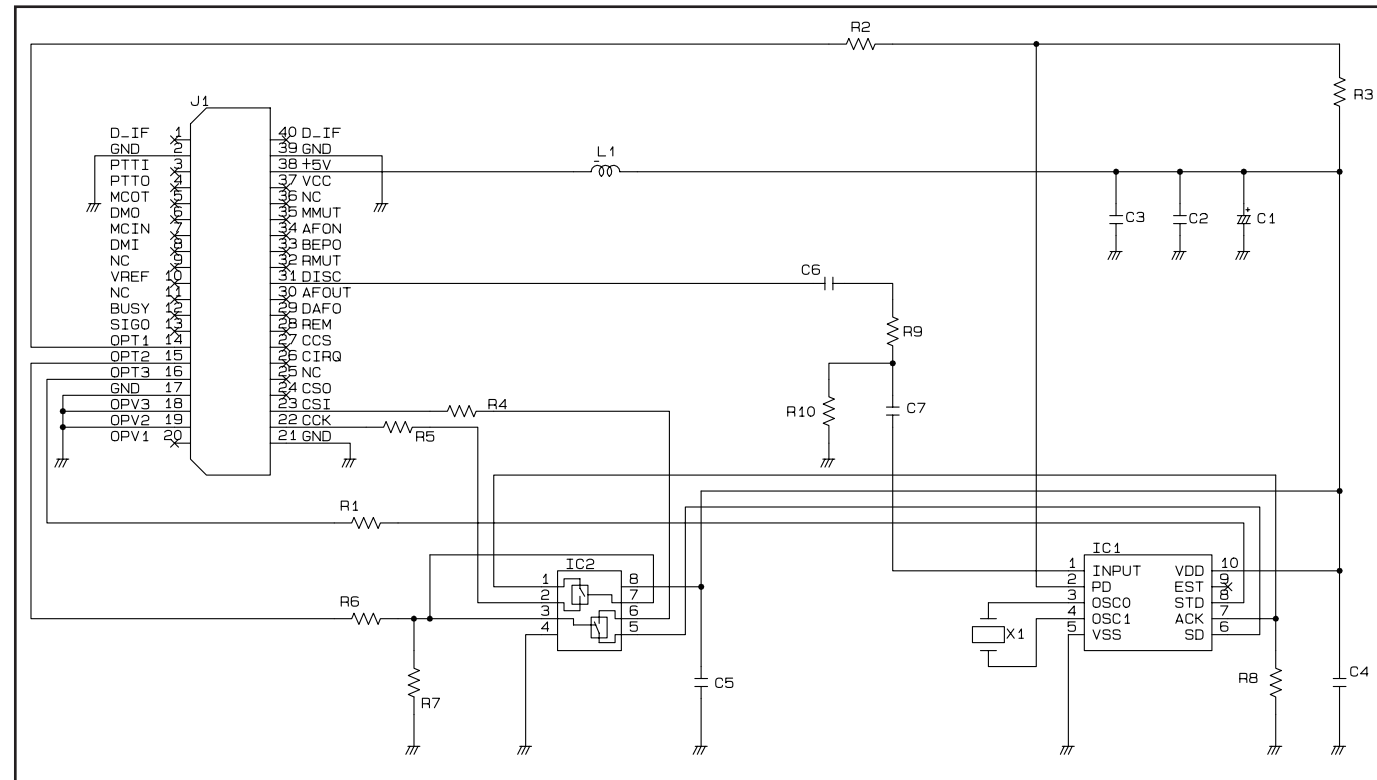

• BOARD LAYOUTS

[TOP VIEW]

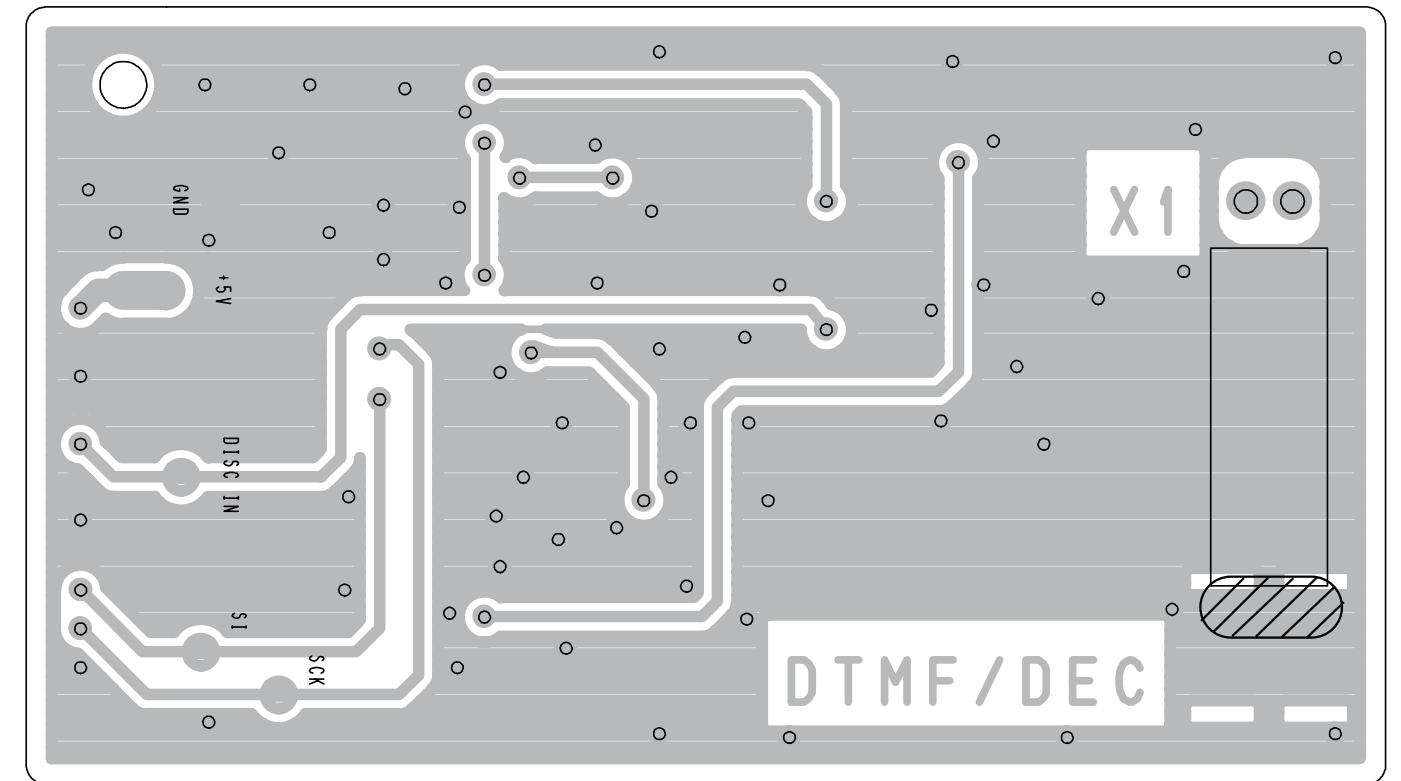

[BOTTOM VIEW]

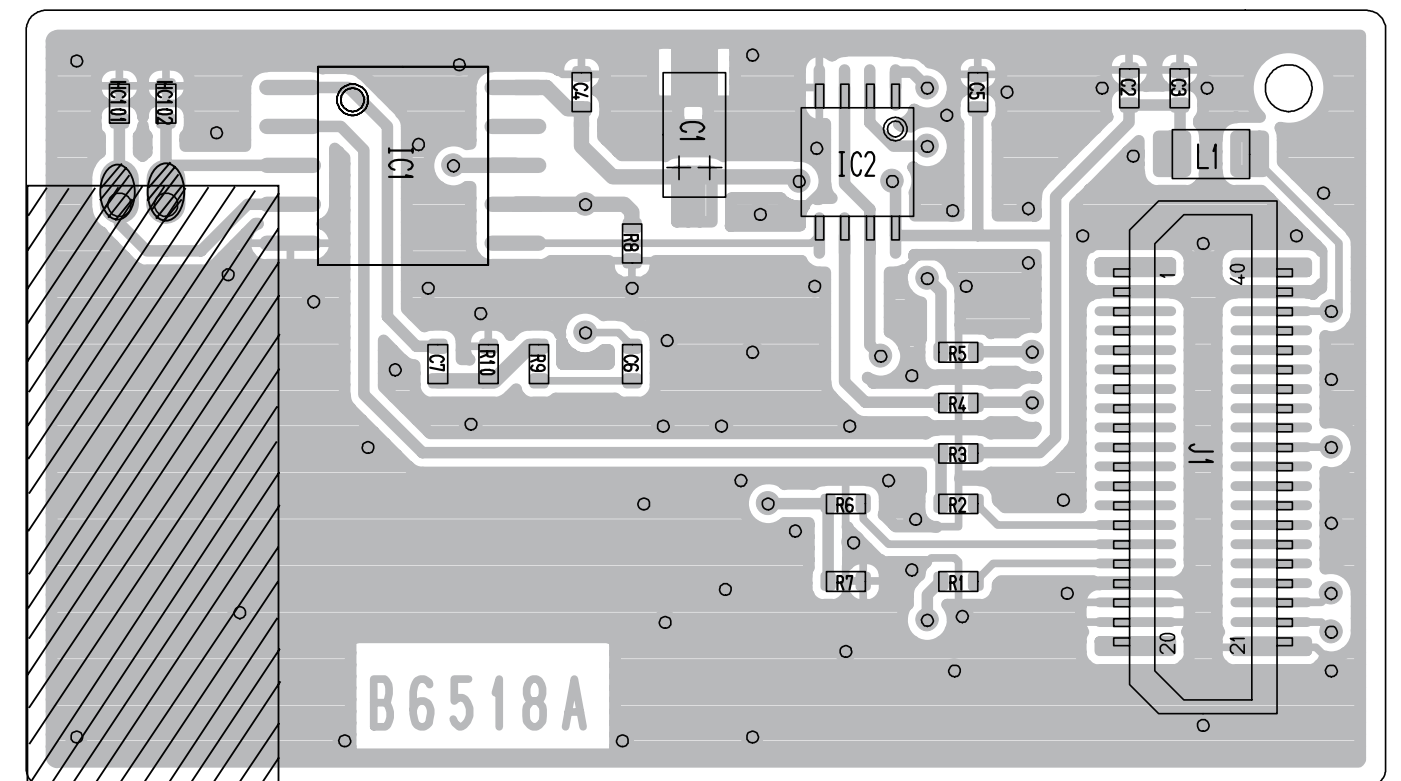

Icom Inc.

1-1-32, Kamiminami, Hirano-ku, Osaka 547-0003, Japan
Phone : +81 (06) 6793 5302
Fax : +81 (06) 6793 0013
URL : <http://www.icom.co.jp/world/index.html>

Icom America Inc.

<Corporate Headquarters>
2380 116th Avenue N.E., Bellevue, WA 98004, U.S.A.
Phone : +1 (425) 454-8155 Fax : +1 (425) 454-1509
URL : <http://www.icomamerica.com>
E-mail : sales@icomamerica.com
<Customer Service>
Phone : +1 (425) 454-7619

Icom Canada

Glenwood Centre #150-6165
Highway 17 Delta, B.C., V4K 5B8, Canada
Phone : +1 (604) 952-4266 Fax : +1 (604) 952-0090
URL : <http://www.icomcanada.com>
E-mail : info@icomcanada.com

Icom (Australia) Pty. Ltd.

Unit 1 / 103 Garden Road, Clayton VIC 3168 Australia
Phone : +61 (03) 9549-7500 Fax : +61 (03) 9549-7505
URL : <http://www.icom.net.au>
E-mail : sales@icom.net.au

Icom New Zealand

146A Harris Road, East Tamaki,
Auckland, New Zealand
Phone : +64 (09) 274 4062 Fax : +64 (09) 274 4708
URL : <http://www.icom.co.nz>
E-mail : inquiries@icom.co.nz

Beijing Icom Ltd.

Room C01, 10th Floor, Long Silver Mansion, No. 88,
Yong Ding Road, Haidian District, Beijing, 100039, China
Phone : +86 (010) 5889 4250 Fax : +86 (010) 5889 4250
URL : <http://www.bjicom.com>
E-mail : bjicom@bjicom.com

Icom (Europe) GmbH

Communication Equipment
Himmelgeister Str. 100, D-40225 Düsseldorf, Germany
Phone : +49 (0211) 346047 Fax : +49 (0211) 333639
URL : <http://www.icomeurope.com>
E-mail : info@icomeurope.com

Icom Spain S.L

Ctra. Rubi, 88, 08190, Sant Cugat del Valles, Barcelona, SPAIN
Phone : +34 (93) 590 26 70 Fax : +34 (93) 589 04 46
URL : <http://www.icomspain.com>
E-mail : icom@icomspain.com

Icom (UK) Ltd.

Unit 9, Sea St., Herne Bay, Kent, CT6 8LD, U.K.
Phone : +44 (01227) 741741 Fax : +44 (01227) 741742
URL : <http://www.icomuk.co.uk>
E-mail : info@icomuk.co.uk

Icom France s.a.s.

Zac de la Plaine
1 Rue Brindejonec des Moulinais BP 5804
31505 Toulouse Cedex, France
Phone : +33 (5) 61 36 03 03 Fax : +33 (5) 61 36 03 00
URL : <http://www.icom-france.com>
E-mail : icom@icom-france.com

Asia Icom Inc.

6F No.68, Sec. 1 Cheng-Teh Road, Taipei, Taiwan, R.O.C.
Phone : +886 (02) 2559 1899 Fax : +886 (02) 2559 1874
URL : <http://www.asia-icom.com>
E-mail : sales@asia-icom.com

Icom Polska

Sopot, 3 Maja 54 Poland
Phone : +48 (58) 550 7135 Fax : +48 (58) 551 0484
E-mail : icompolaska@icompolaska.com.pl

Count on us!

Icom Inc.

1-1-32, Kamiminami, Hirano-ku, Osaka 547-0003, Japan

S-14315XZ-C1
© 2007 Icom Inc.