

1	-	-	7	-	APPD	CHKD.	DWN. BY	DATE	2001.06.22	MODEL	IC-756PRO2
2	-	-	8	-							
3	-	-	9	-							
4	-	-	10	-							
5	-	-	11	-							
6	-	-	12	-							

ICOM

Icom Inc

Downloaded by RadioAmateur.EU

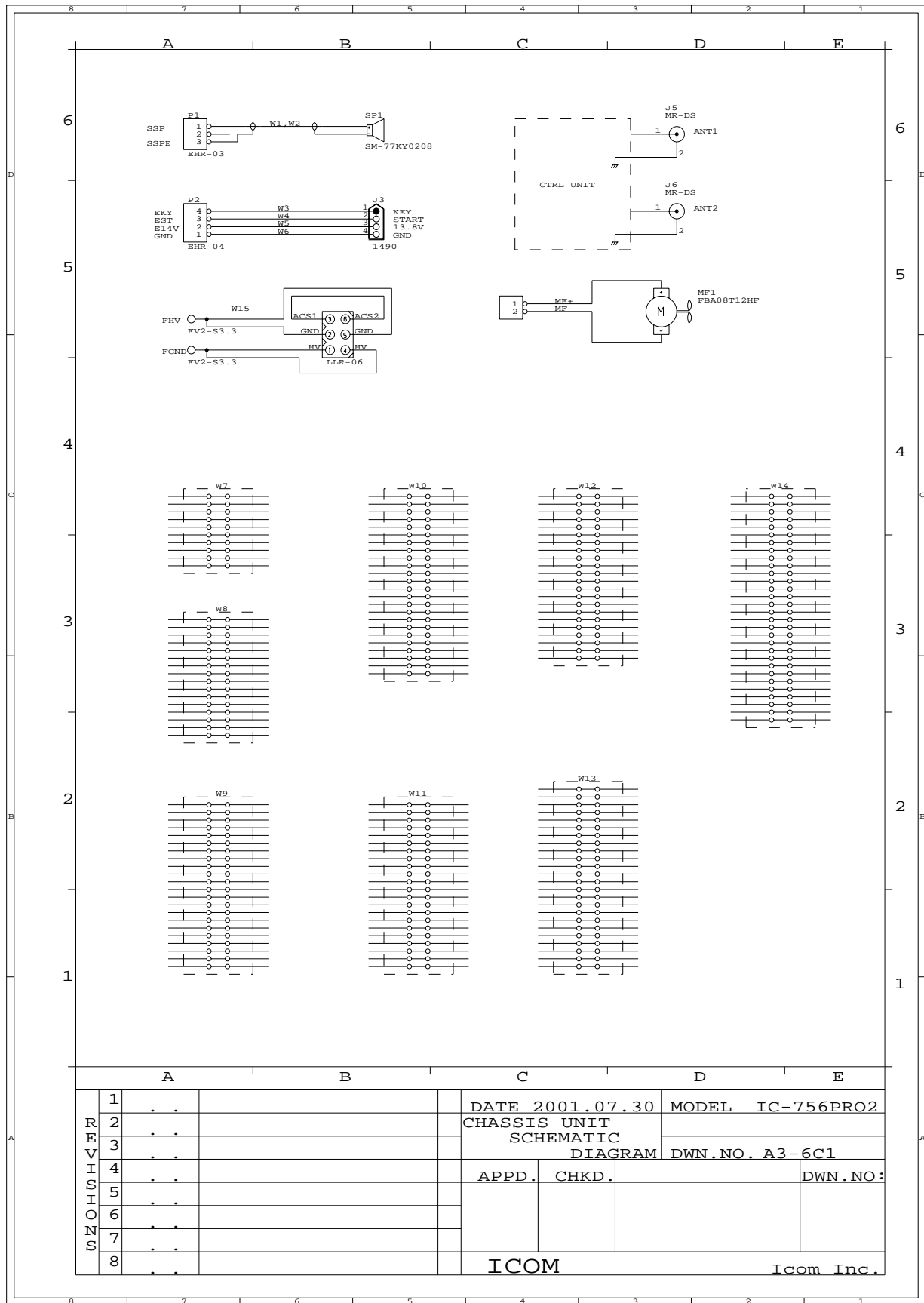

		A	B	C	D	E
REVISIONS	1	.	.	DATE 2001.07.30		MODEL IC-756PRO2
	2	.	.	CHASSIS UNIT		
	3	.	.	SCHEMATIC		
	4	.	.	DIAGRAM		DWN.NO. A3-6C1
	5	.	.	APPD.	CHKD.	DWN.NO.:
	6	.	.			
	7	.	.			
	8	.	.	ICOM		Icom Inc.

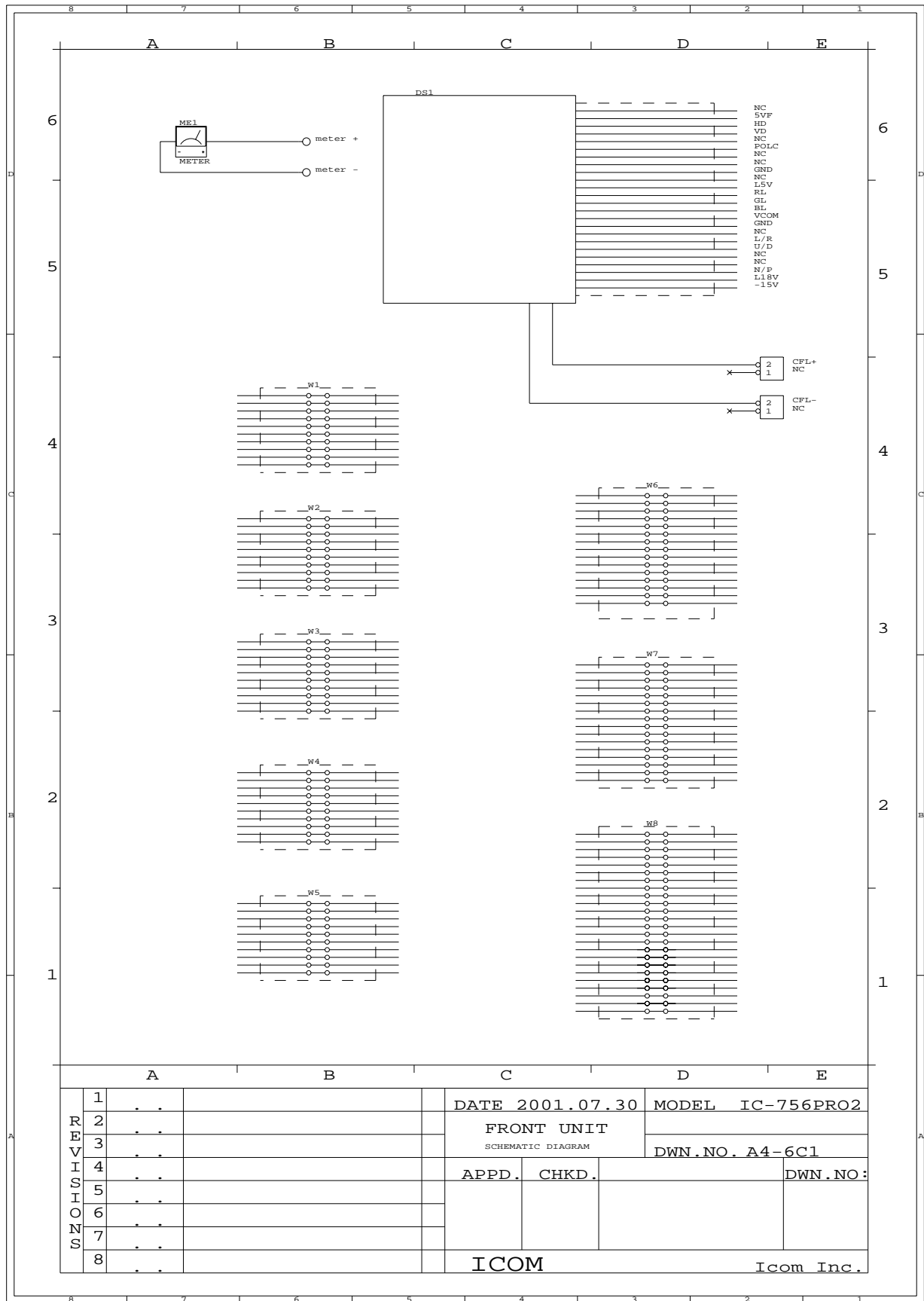

	A	B	C	D	E	
REVISIONS	1	.	.	DATE 2001.07.30	MODEL IC-756PRO2	
	2	.	.	FRONT UNIT SCHEMATIC DIAGRAM	DWN.NO. A4-6C1	
	3	.	.			
	4	.	.	APPD.	CHKD.	DWN.NO.:
	5	.	.			
	6	.	.			
	7	.	.			
	8	.	.	ICOM		Icom Inc.

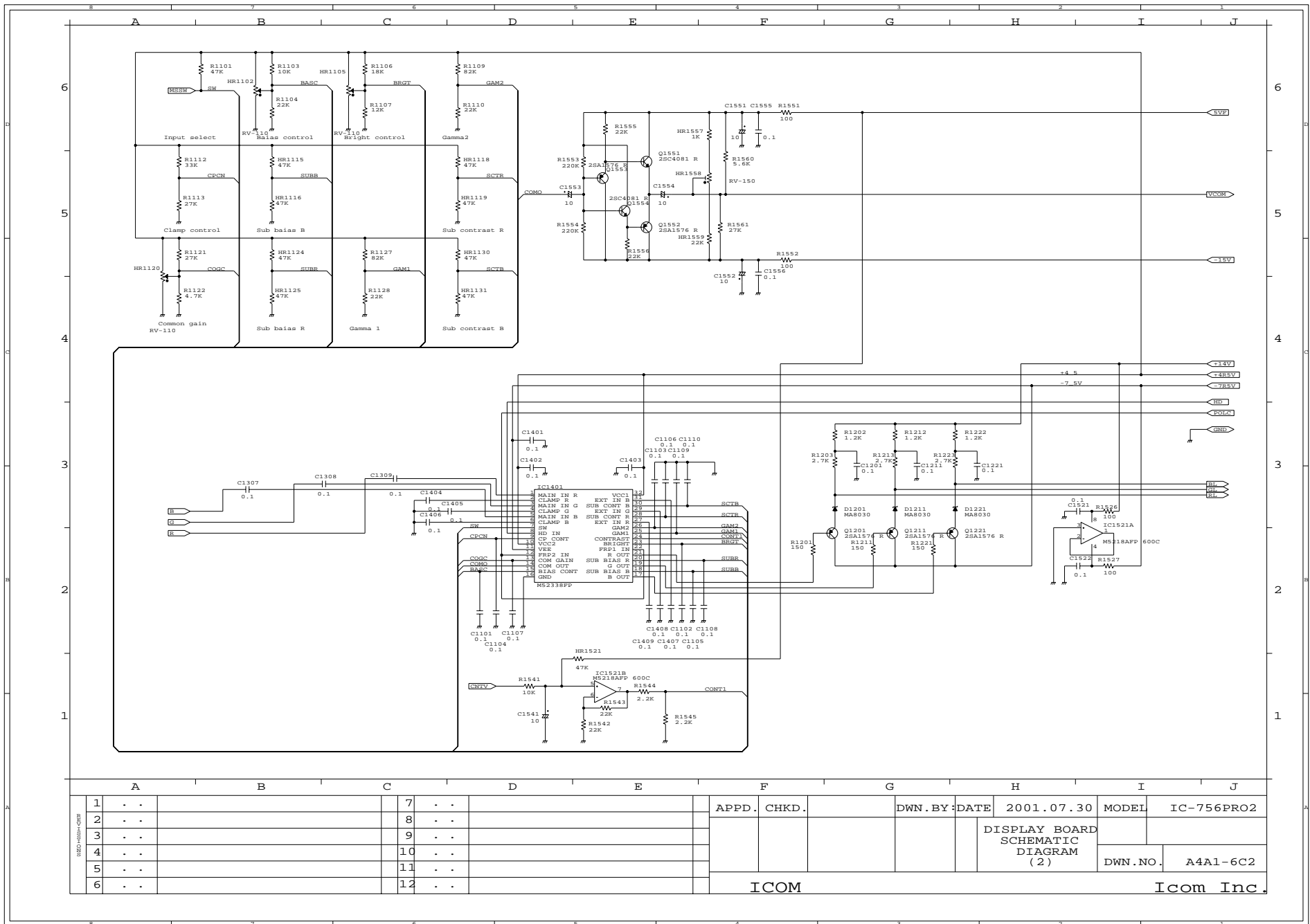

1	.	.	7	.	APPD.	CHKD.	DWN. BY:	DATE	2001.07.30	MODEL	IC-756PRO2
2	.	.	8	.							
3	.	.	9	.							
4	.	.	10	.						DISPLAY BOARD SCHEMATIC DIAGRAM (2)	
5	.	.	11	.						DWN.NO.	A4A1-6C2
6	.	.	12	.							

ICOM Icom Inc.

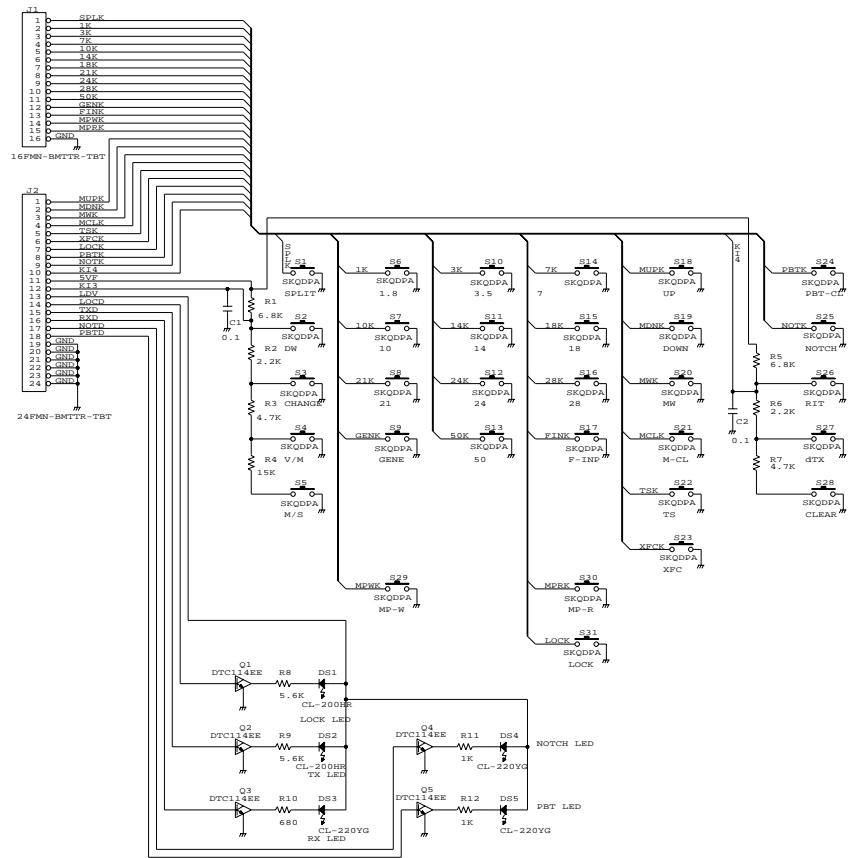

REV. HISTORY	1	.	.	7	.	.	APPD.	CHKD.	DWN.BY:	DATE	2001.07.30	MODEL	IC-756PRO2
	2	.	.	8	.	.							
	3	.	.	9	.	.					TEN-KEY BOARD		
	4	.	.	10	.	.					SCHEMATIC DIAGRAM		
	5	.	.	11	.	.						DWN.NO.	A4A2-6C1
	6	.	.	12	.	.	ICOM						Icom Inc.

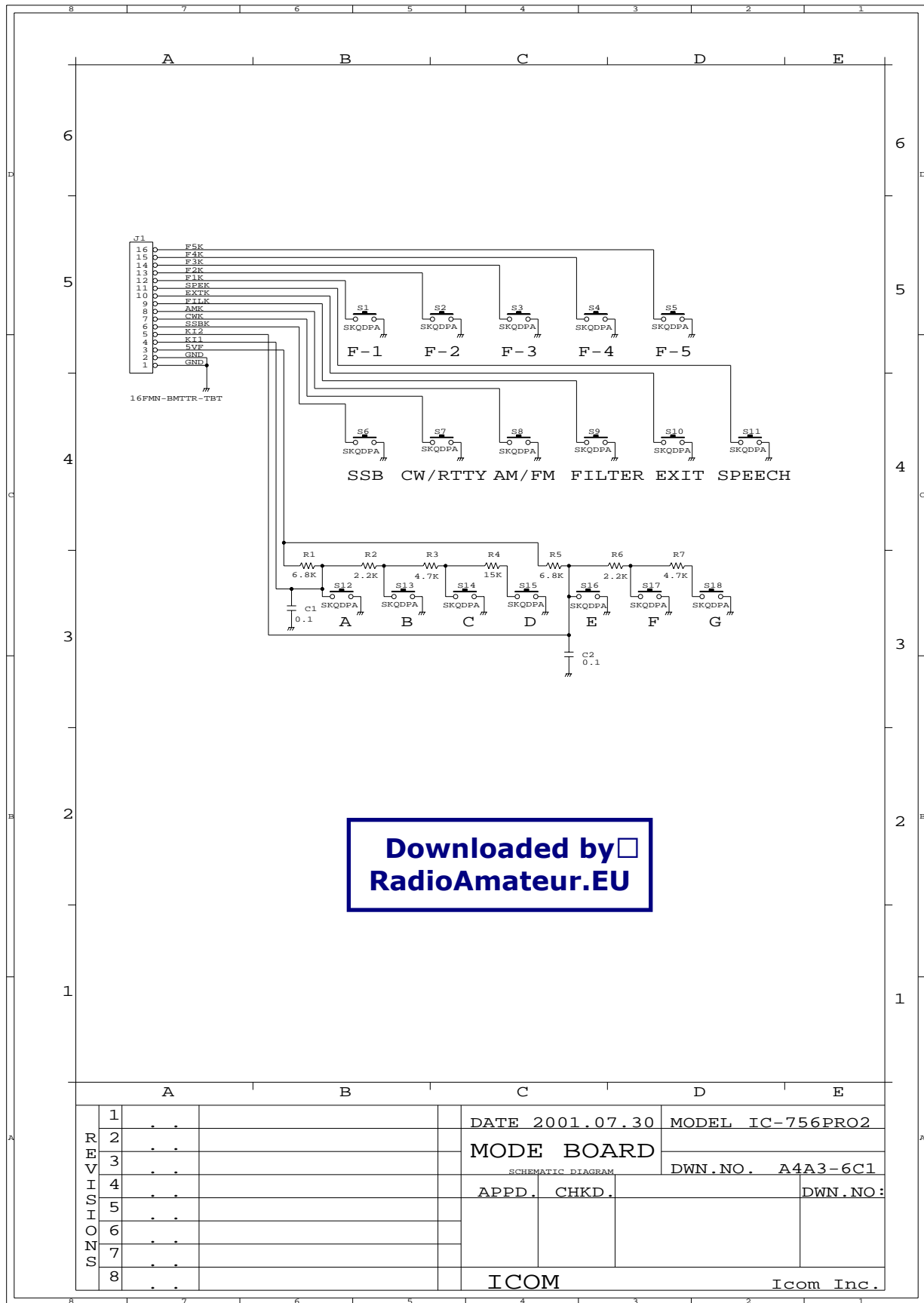

Downloaded by
RadioAmateur.EU

R E V I S I O N S	1	.	.		DATE 2001.07.30	MODEL IC-756PRO2
	2	.	.		MODE BOARD	
	3	.	.		DWN.NO. A4A3-6C1	
	4	.	.		APPD. CHKD.	DWN.NO.:
	5	.	.			
	6	.	.			
	7	.	.			
	8	.	.		ICOM	Icom Inc.

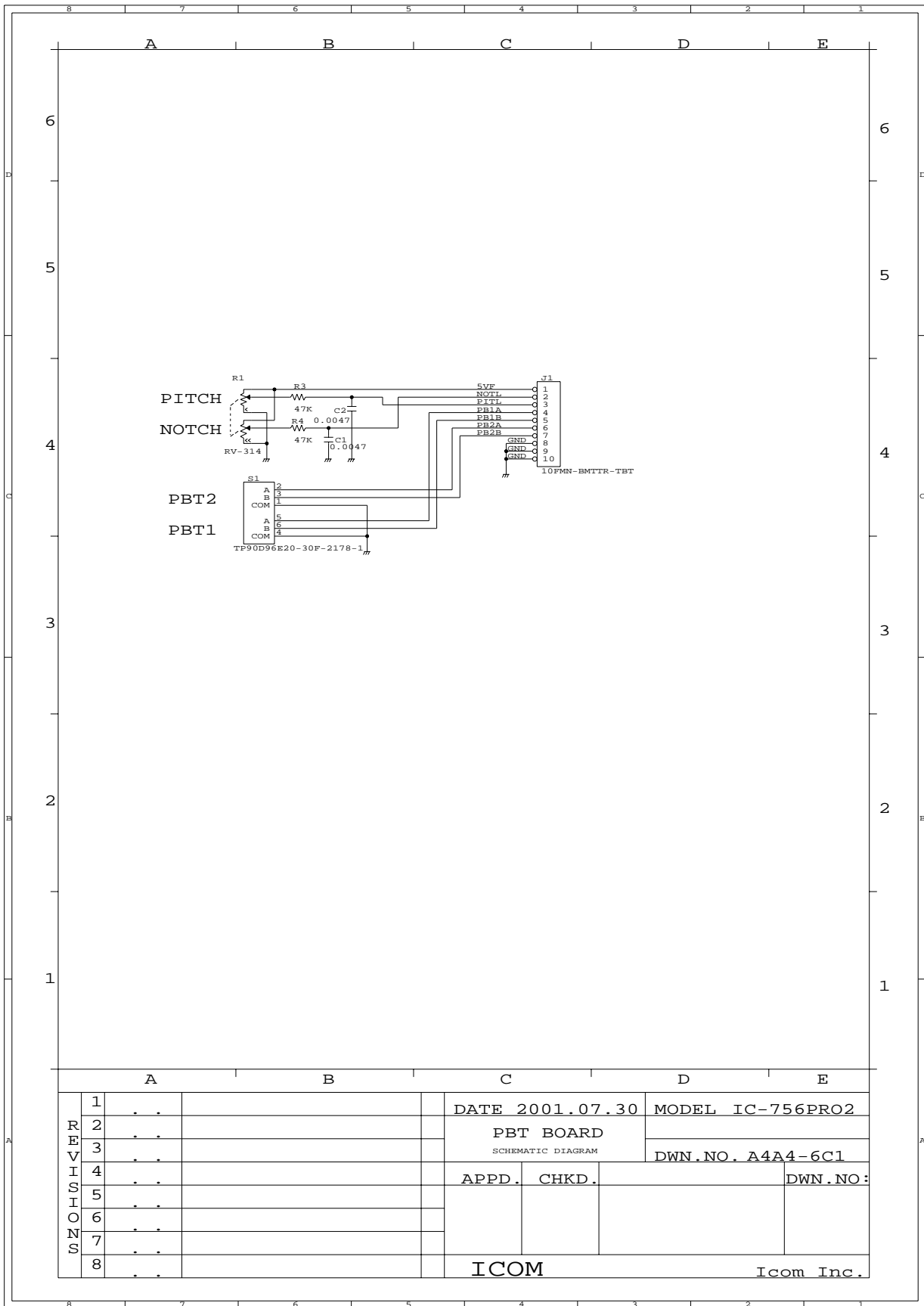

	A	B	C	D	E	
R E V I S I O N S	1	.	.	DATE 2001.07.30	MODEL IC-756PRO2	
	2	.	.	PBT BOARD		
	3	.	.	SCHEMATIC DIAGRAM		
	4	.	.	DWN.NO. A4A4-6C1		
	5	.	.	APPD.	CHKD.	DWN.NO.:
	6	.	.			
	7	.	.			
	8	.	.	ICOM		Icom Inc.

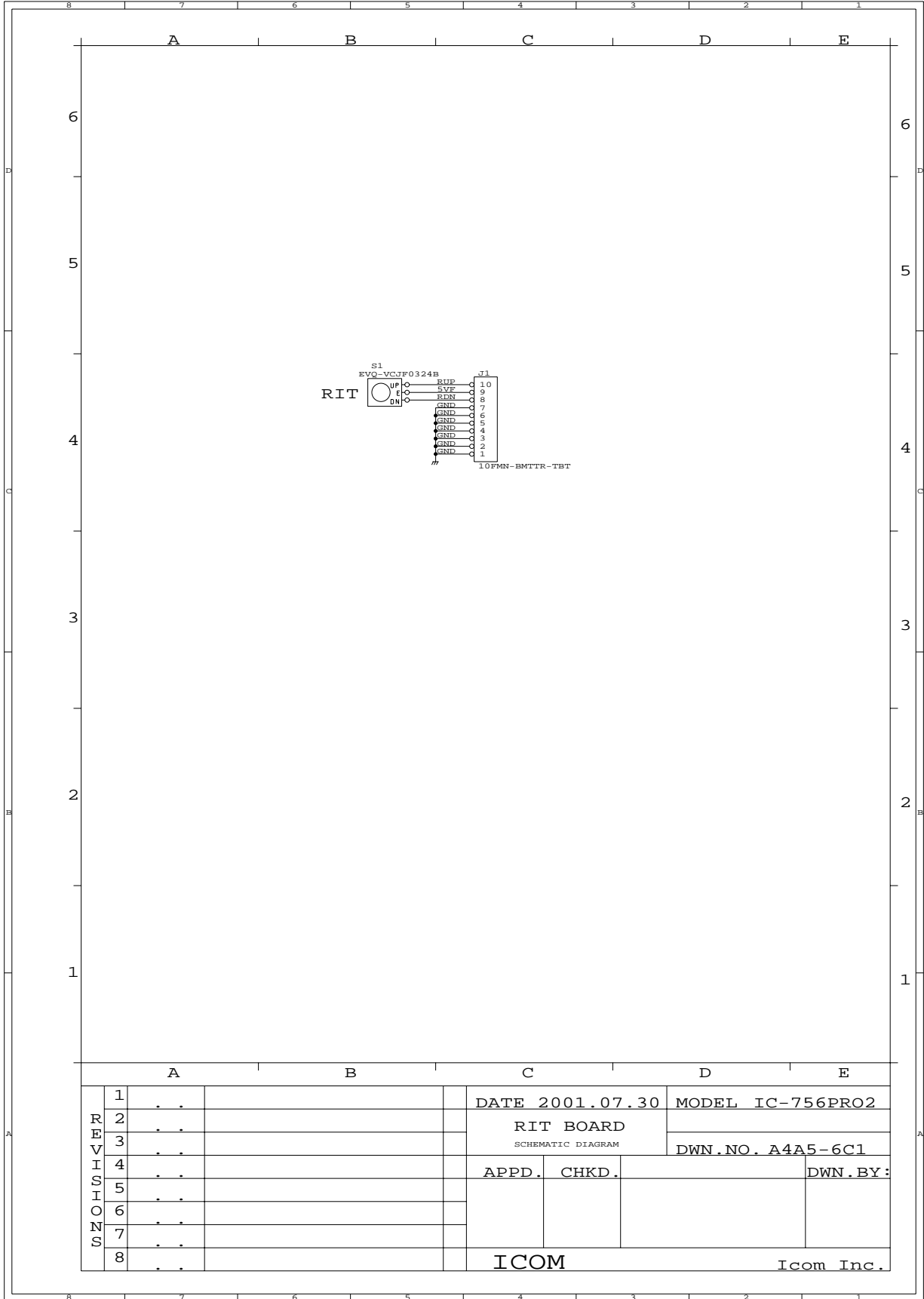

	A	B	C	D	E	
REVISIONS	1	.		DATE 2001.07.30 MODEL IC-756PRO2		
	2	.		RIT BOARD		
	3	.		SCHEMATIC DIAGRAM		
	4	.		DWN.NO. A4A5-6C1		
	5	.		APPD.	CHKD.	DWN.BY:
	6	.				
	7	.				
	8	.		ICOM		Icom Inc.

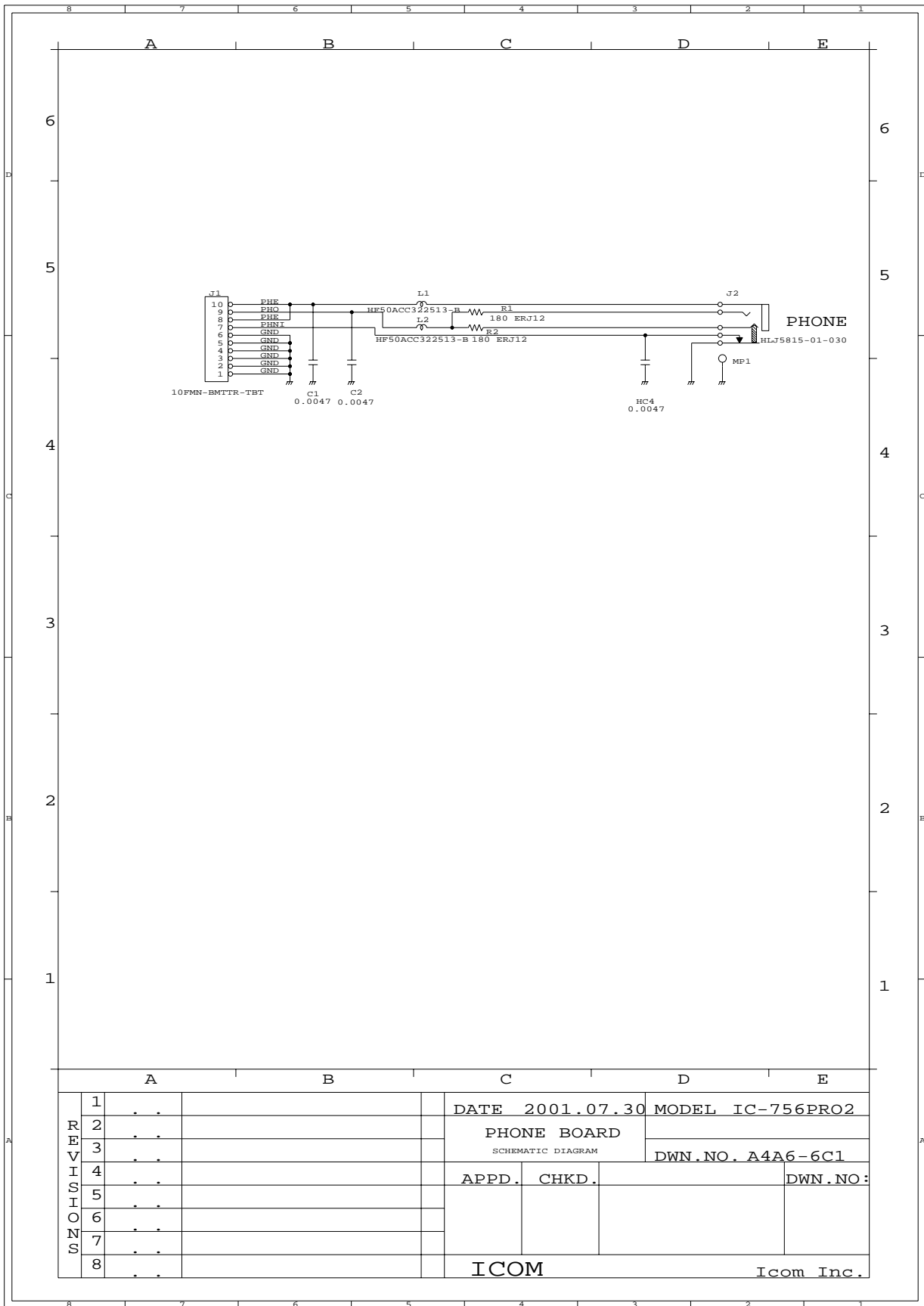

	A	B	C	D	E	
R E V I S I O N S	1	.	.	DATE 2001.07.30	MODEL IC-756PRO2	
	2	.	.	PHONE BOARD		
	3	.	.	SCHEMATIC DIAGRAM		
	4	.	.	DWN.NO. A4A6-6C1		
	5	.	.	APPD.	CHKD.	DWN.NO.:
	6	.	.			
	7	.	.			
	8	.	.	ICOM		Icom Inc.

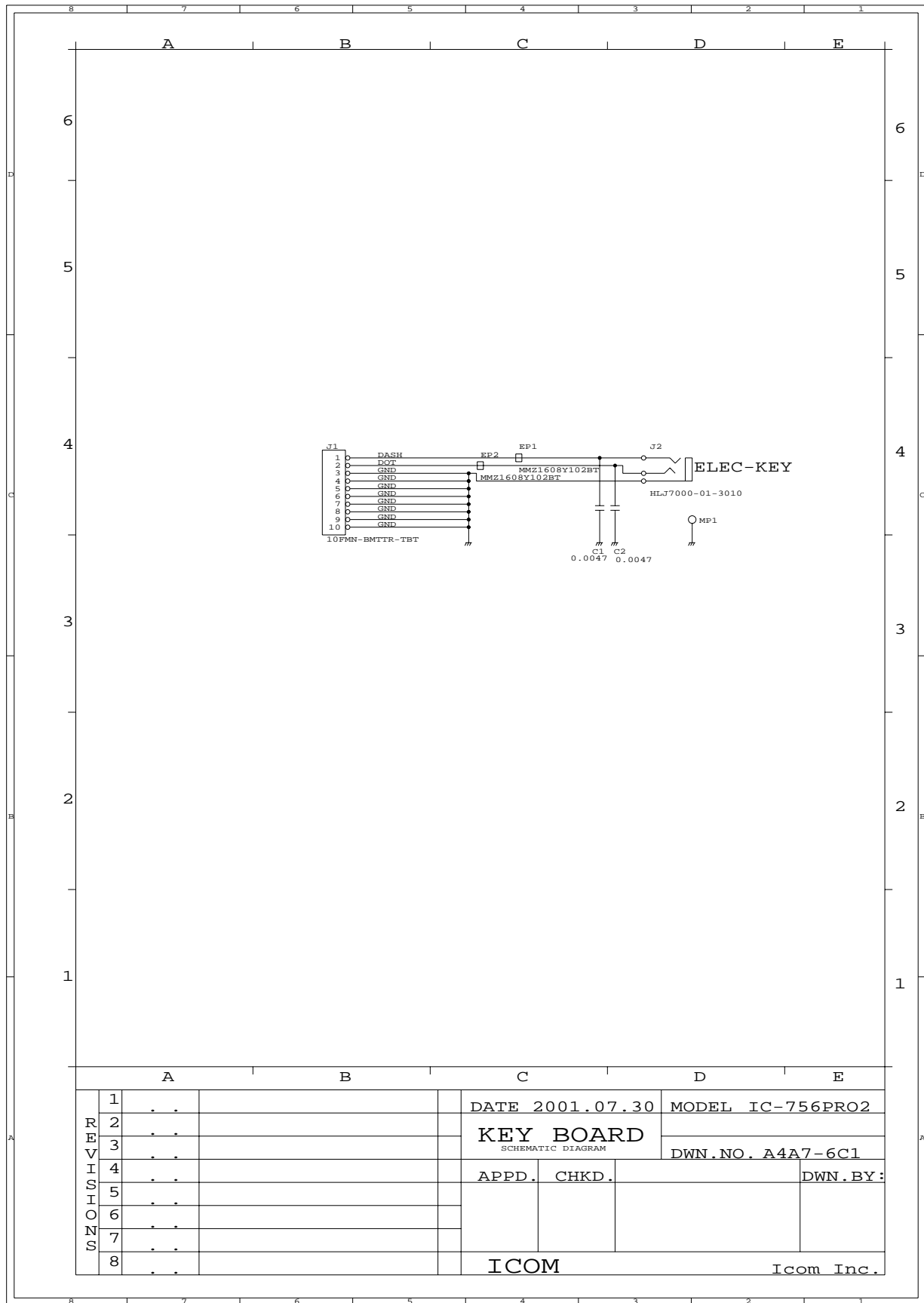

		A	B	C	D	E	
REVISIONS	1	.	.		DATE 2001.07.30	MODEL IC-756PRO2	
	2	.	.		KEY BOARD SCHEMATIC DIAGRAM	DWN.NO. A4A7-6C1	
	3	.	.				
	4	.	.		APPD.	CHKD.	DWN.BY:
	5	.	.				
	6	.	.				
	7	.	.				
	8	.	.		ICOM Icom Inc.		

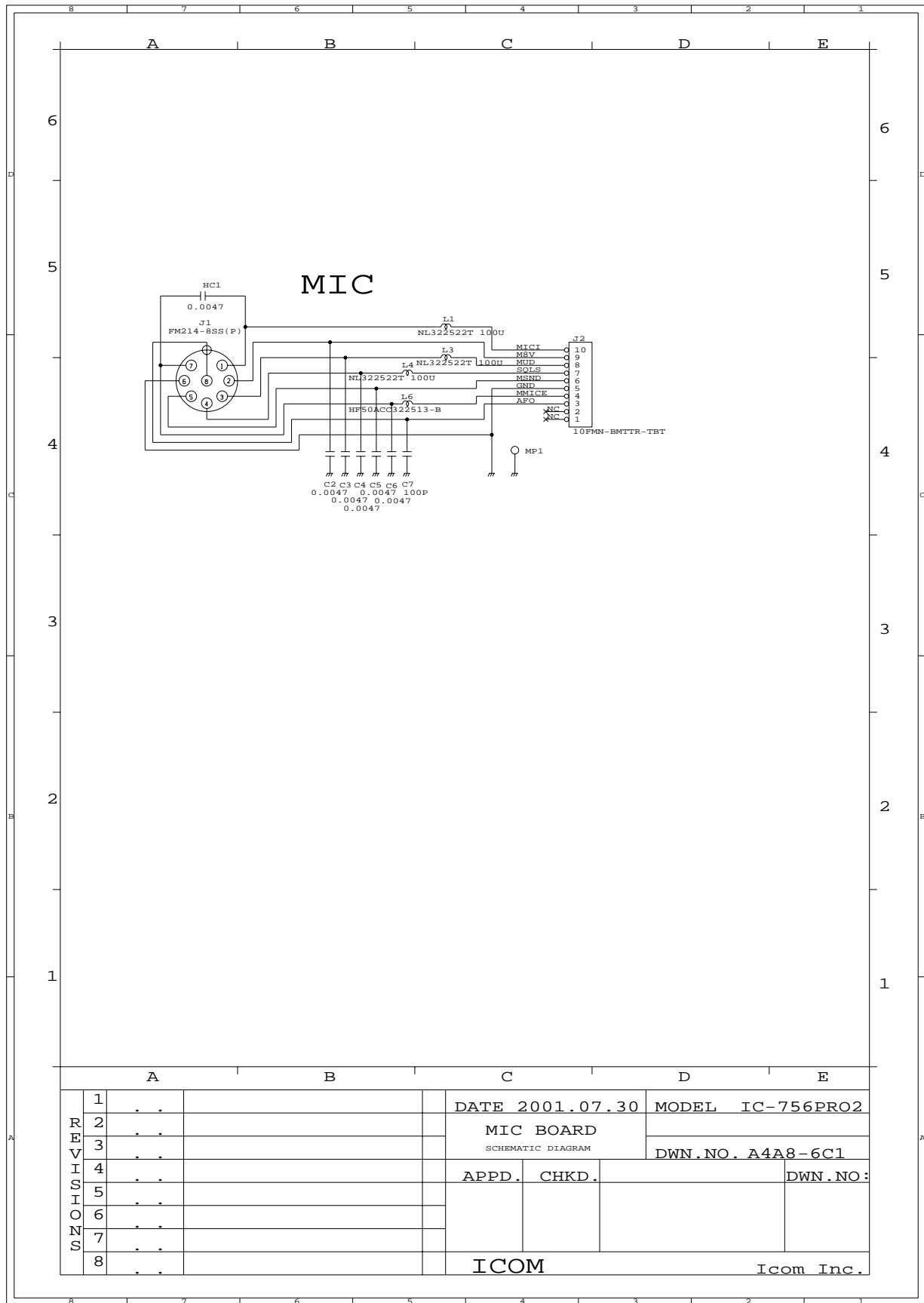

	A	B	C	D	E	
R E V I S I O N S	1	.	.	DATE 2001.07.30	MODEL IC-756PRO2	
	2	.	.	MIC BOARD SCHEMATIC DIAGRAM	DWN.NO. A4A8-6C1	
	3	.	.			
	4	.	.	APPD.	CHKD.	DWN.NO.:
	5	.	.			
	6	.	.			
	7	.	.			
	8	.	.	ICOM		Icom Inc.

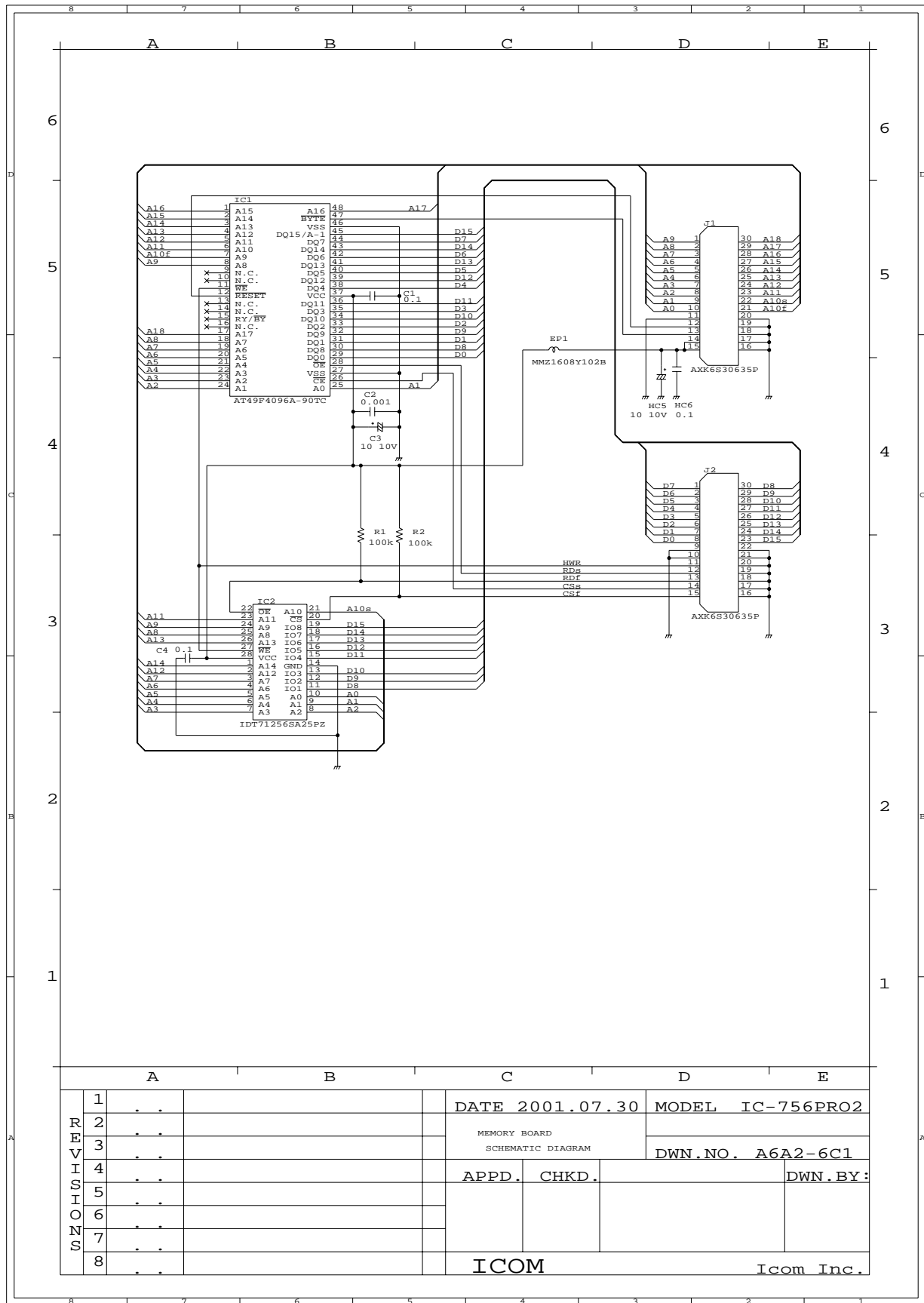

	A	B	C	D	E	
REVISIONS	1	.	.	DATE 2001.07.30	MODEL IC-756PRO2	
	2	.	.	MEMORY BOARD SCHEMATIC DIAGRAM	DWN.NO. A6A2-6C1	
	3	.	.			
	4	.	.	APPD.	CHKD.	DWN.BY:
	5	.	.			
	6	.	.			
	7	.	.			
	8	.	.	ICOM	Icom Inc.	

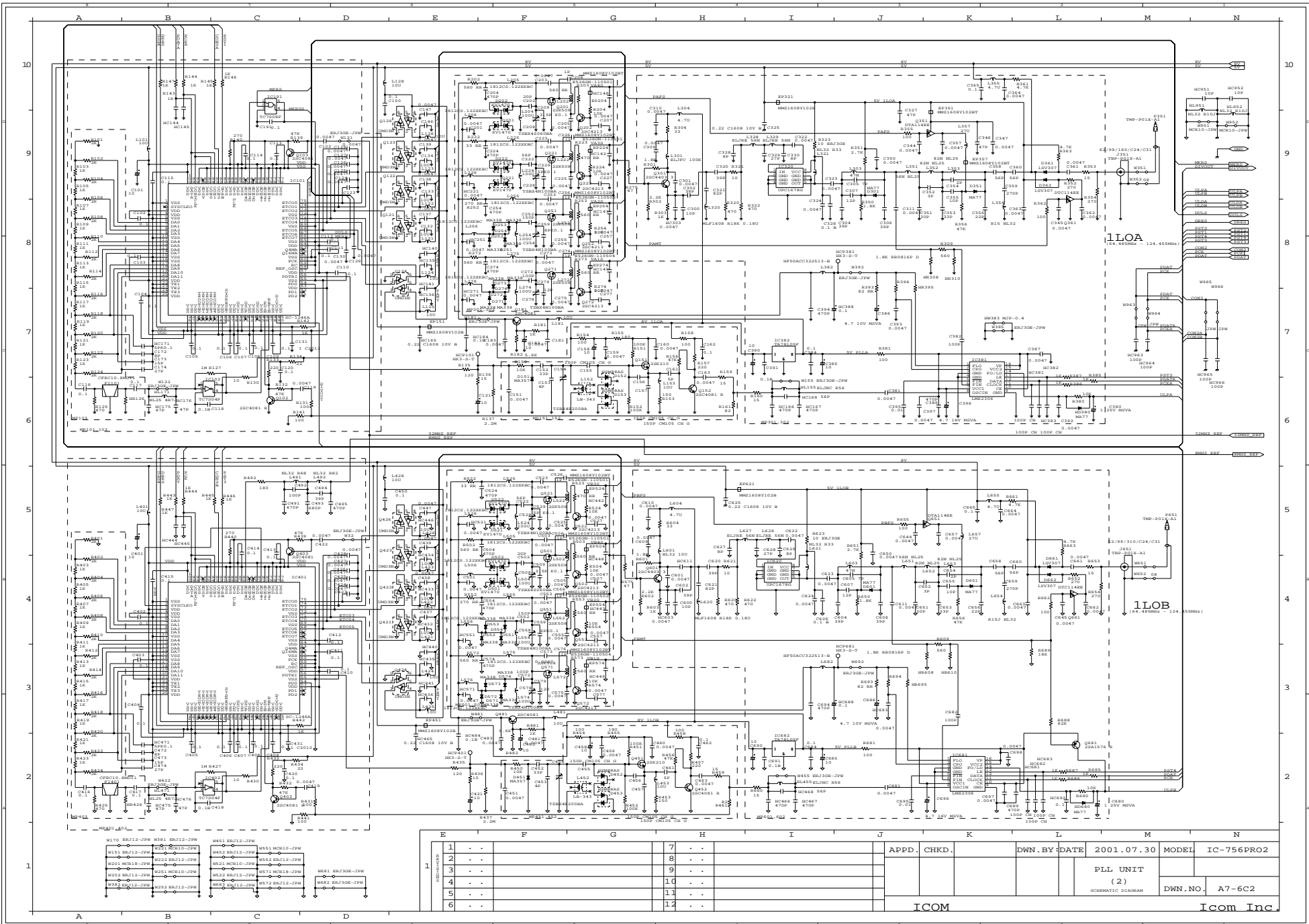

E		F		G		H		I		J		K		L		M		N	
1	-	-	-	-	-	-	-	-	-	-	-	-	-	-	-	-	-	-	-
2	-	-	-	-	-	-	-	-	-	-	-	-	-	-	-	-	-	-	-
3	-	-	-	-	-	-	-	-	-	-	-	-	-	-	-	-	-	-	-
4	-	-	-	-	-	-	-	-	-	-	-	-	-	-	-	-	-	-	-
5	-	-	-	-	-	-	-	-	-	-	-	-	-	-	-	-	-	-	-
6	-	-	-	-	-	-	-	-	-	-	-	-	-	-	-	-	-	-	-

APPD.	CHKD.	DWN. BY	DATE	MODEL	IC-756PRO2
			2001.07.30		
				PLL UNIT	
				(2)	
				SCHMATIC DIAGRAM	
		DWN. NO.			A7-6C2

ICOM Icom Inc

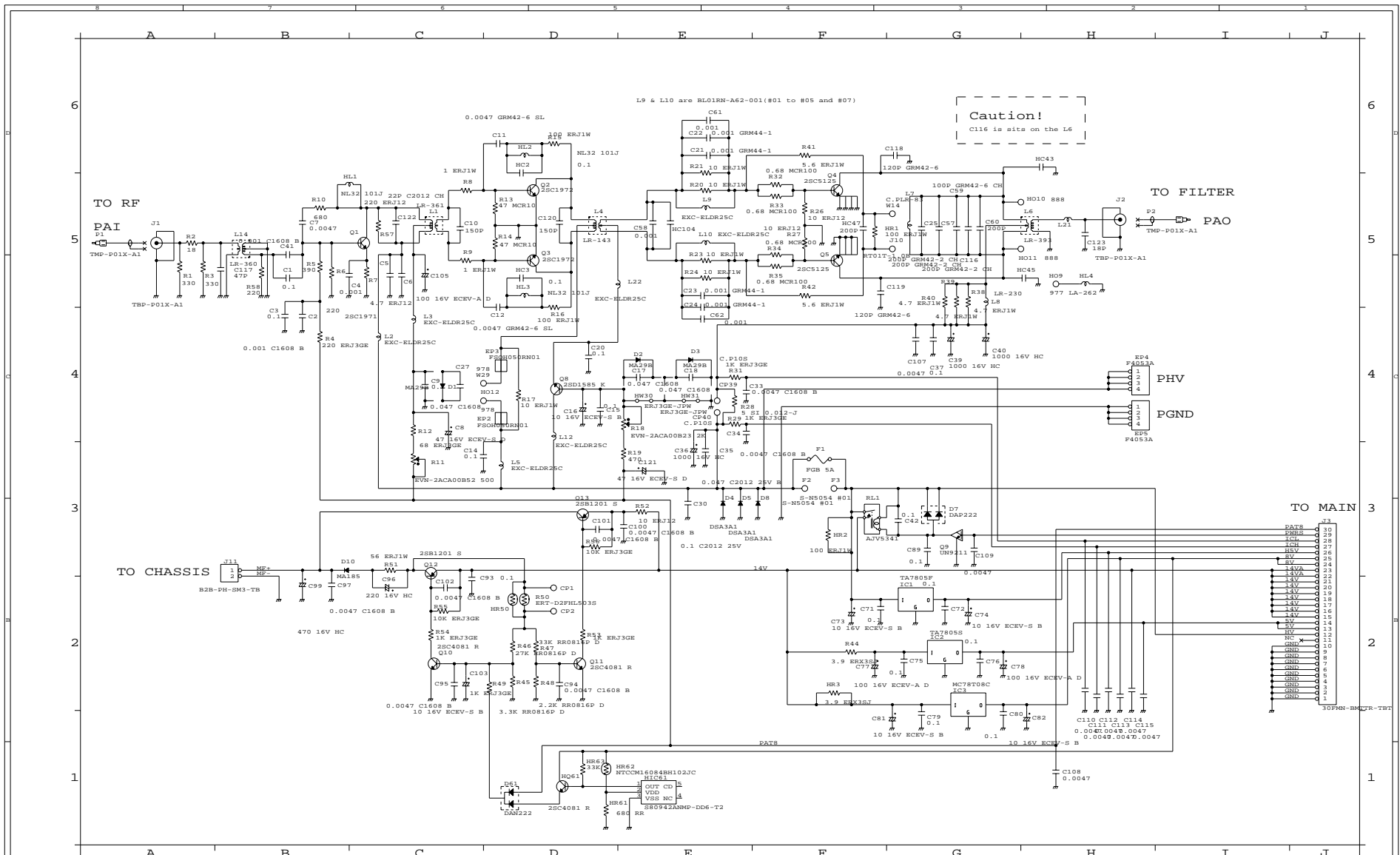

1	.	.	7	.	APPD.	CHKD.	DWN.BY	DATE	2001.07.30	MODEL	IC-756PRO2
2	.	.	8	.							
3	.	.	9	.							
4	.	.	10	.					PA UNIT		
5	.	.	11	.					SCHMATIC DIAGRAM		
6	.	.	12	.						DWN.NO.	A8-6C1
ICOM											Icom Inc.

Downloaded by RadioAmateur.EU

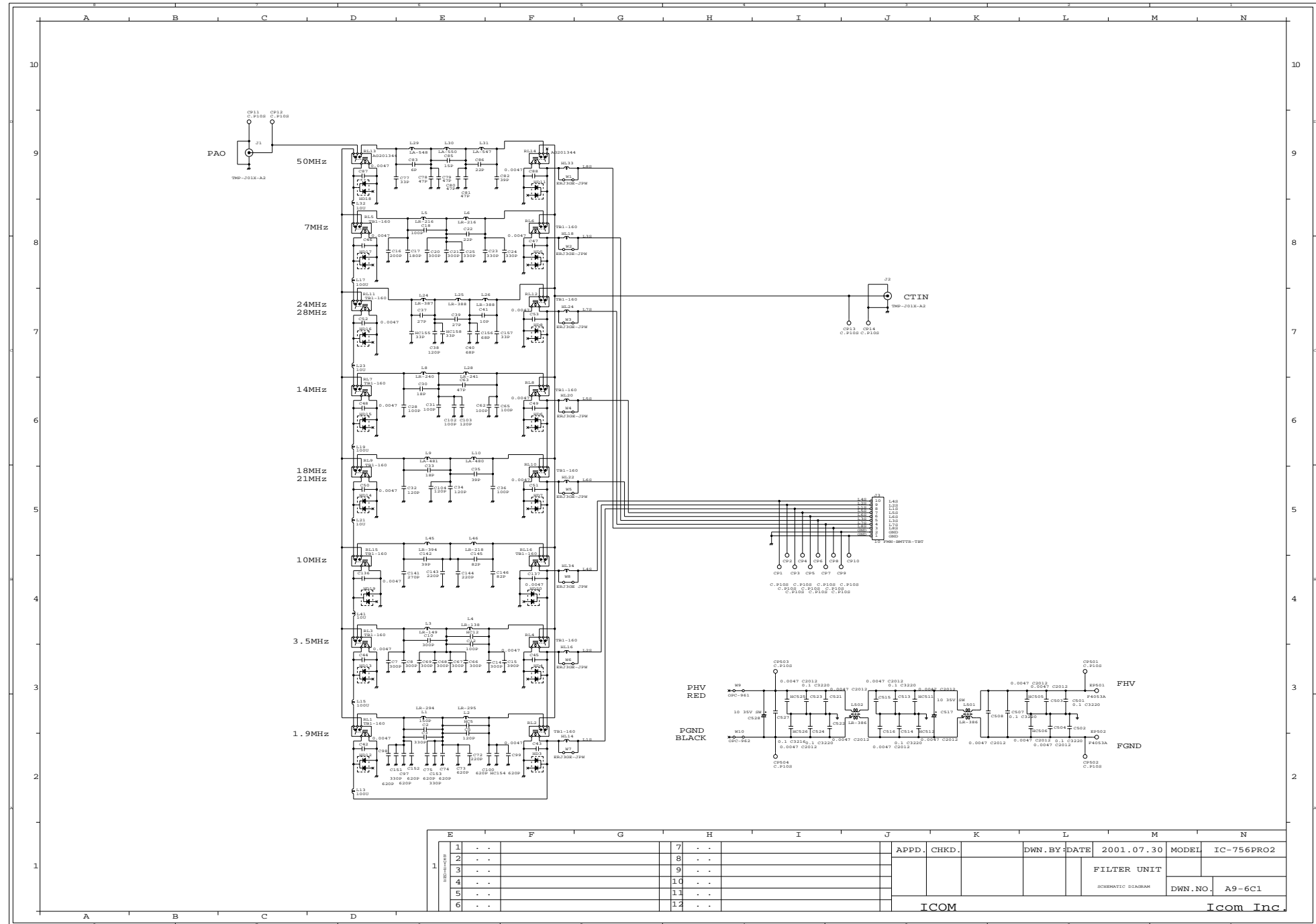

REVISION	DATE	BY	CHKD.	DWN. BY	DATE	MODEL	IC-756PRO2
1	7	-	-	APPD	2001.07.30		
2	8	-	-				
3	9	-	-				
4	10	-	-				
5	11	-	-				
6	12	-	-				

ICOM

Icom Inc.

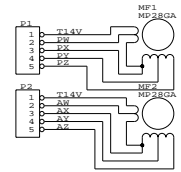
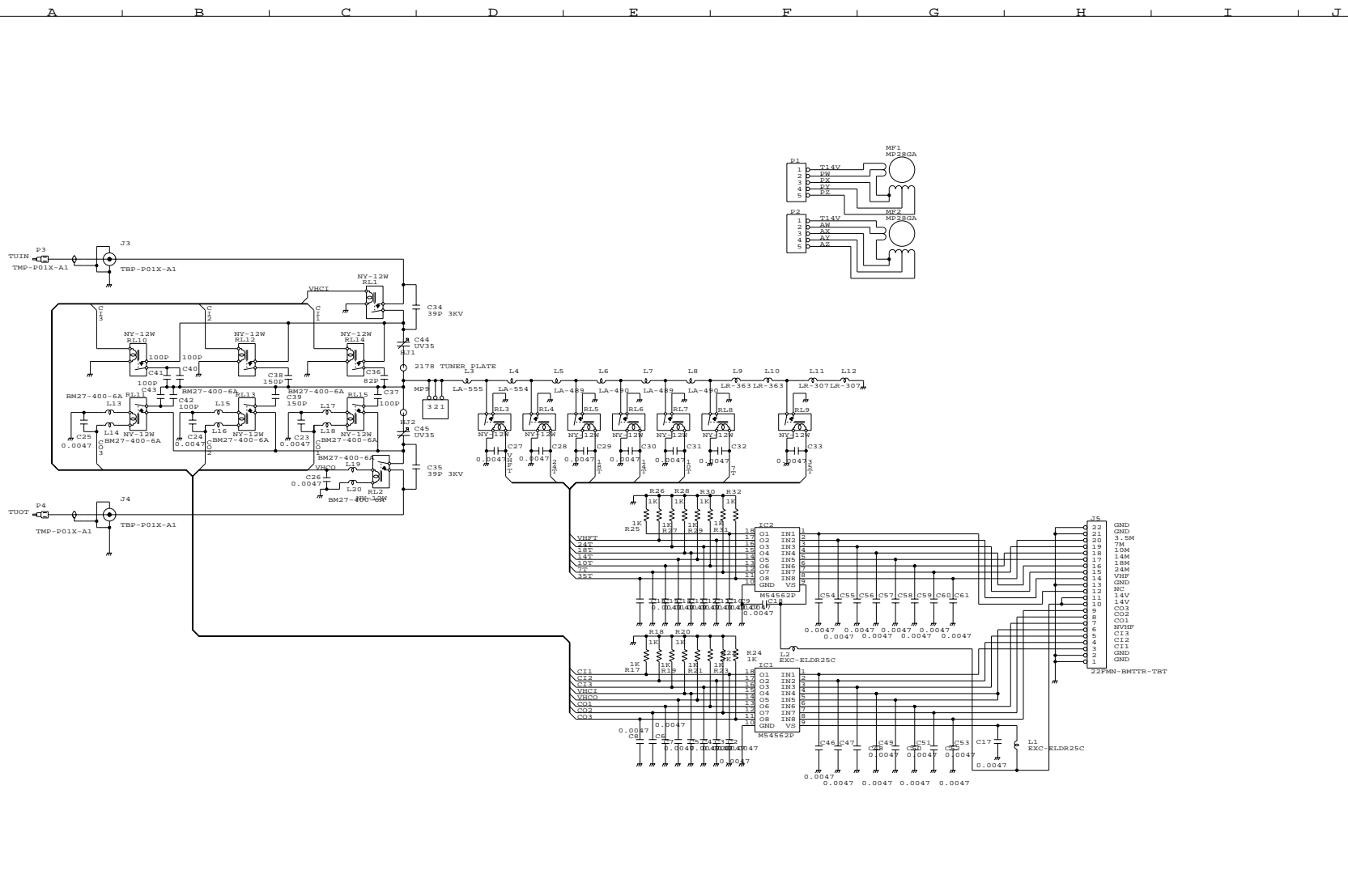

	A	B	C	D	E	F	G	H	I	J	
1	.	.	7	.	.	APPD.	CHKD.	DWN.BY:DATE	2001.07.30	MODEL	IC-756PRO2
2	.	.	8	.	.						
3	.	.	9	.	.						
4	.	.	10	.	.				TUNER UNIT		
5	.	.	11	.	.				SCHEMATIC		
6	.	.	12	.	.				DIAGRAM	DWN.NO.	A10-6C1
						ICOM					Icom Inc.

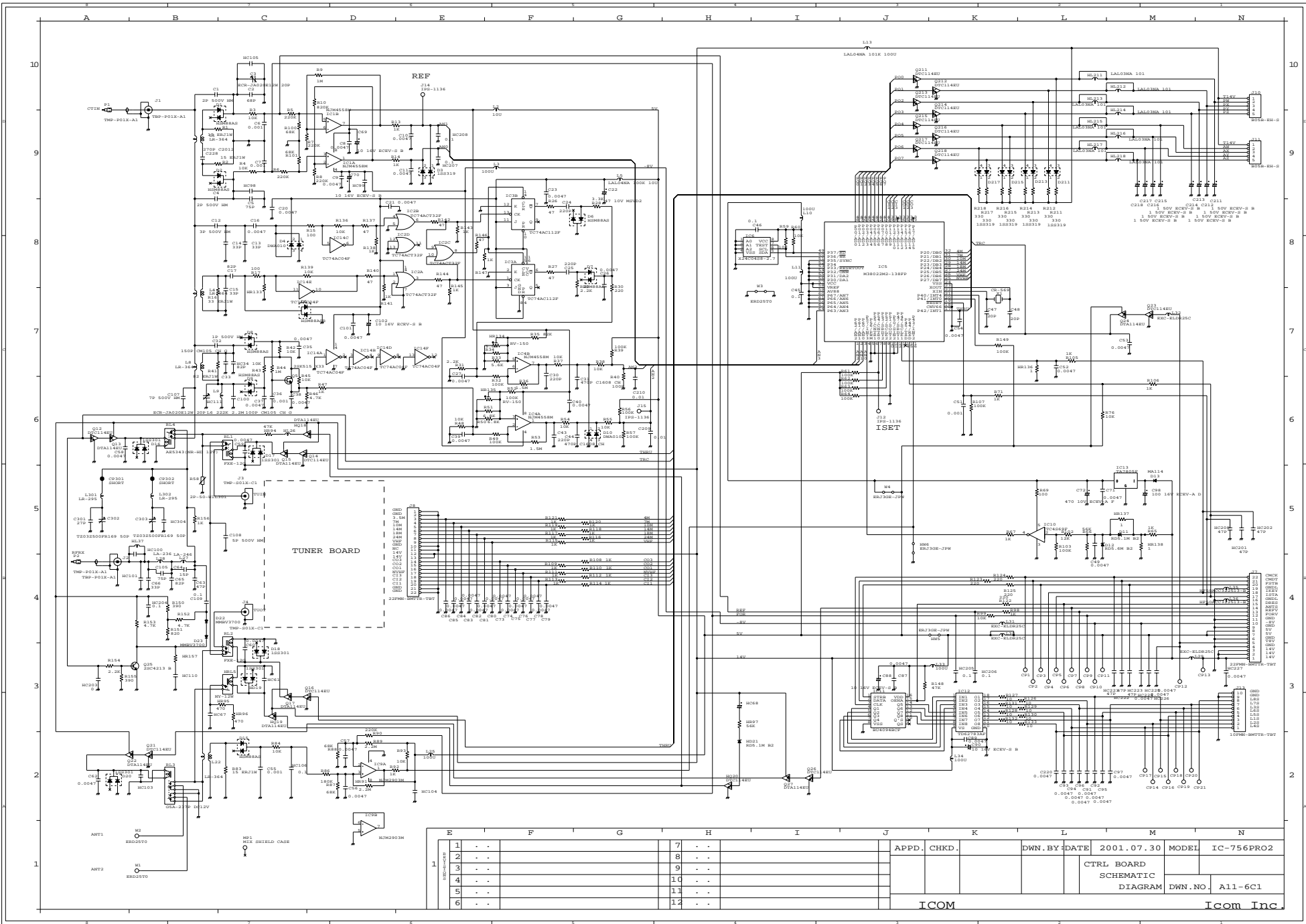

E		F		G		H		I		J		K		L		M		N				
1	-	-	-	-	-	-	7	-	-	APPD.	CHKD.	DWN.	BY	DATE	2001.07.30	MODEL	IC-756PRO2					
2	-	-	-	-	-	-	8	-	-	CTRL BOARD SCHEMATIC DIAGRAM										DWN.	NO.	A11-6C1
3	-	-	-	-	-	-	9	-	-											ICOM		
4	-	-	-	-	-	-	10	-	-													
5	-	-	-	-	-	-	11	-	-													
6	-	-	-	-	-	-	12	-	-													

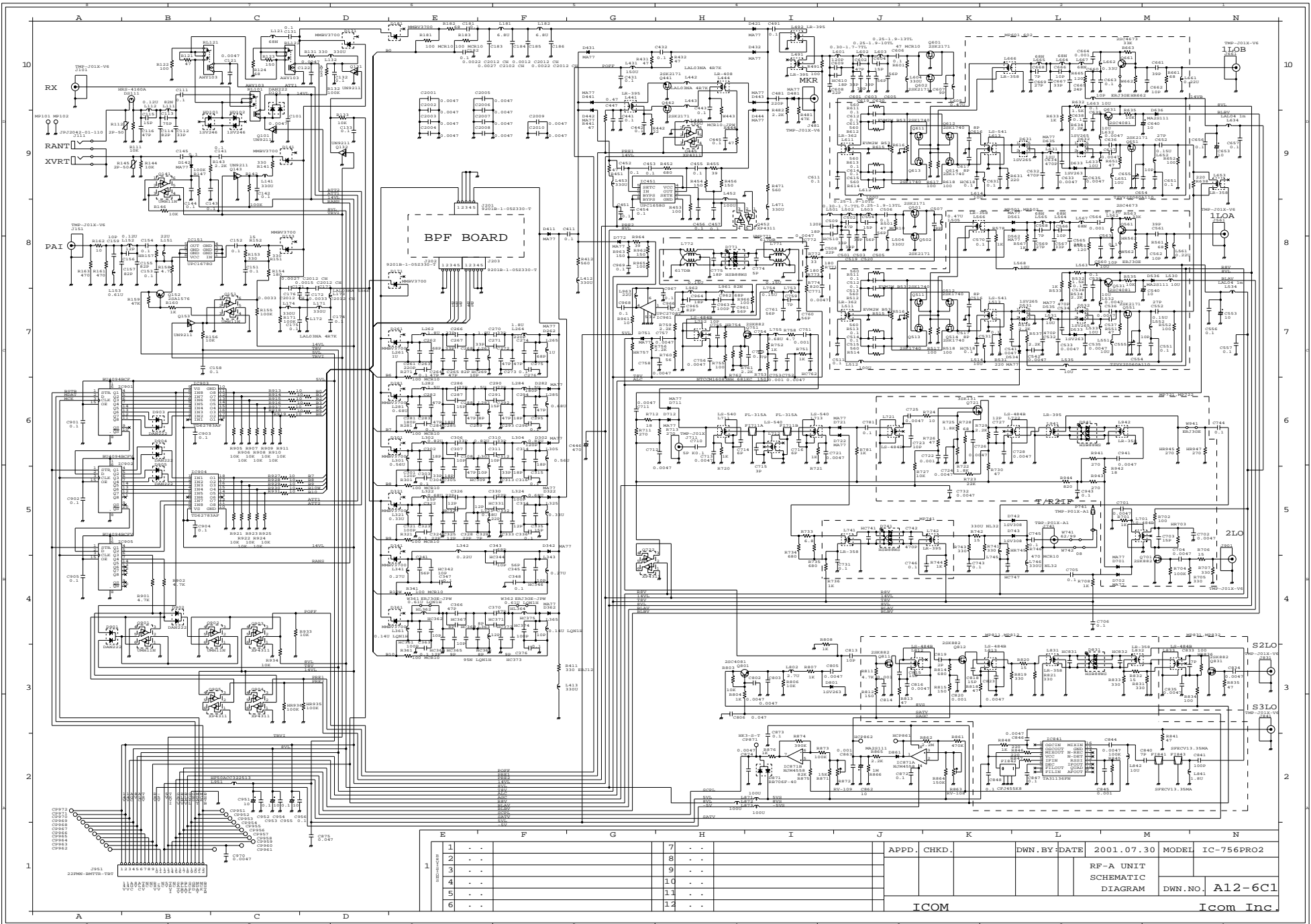

E		F		G		H		I		J		K		L		M		N	
1	APPD.	CHKD.	.	.	DWN. BY	DATE	2001.07.30	MODEL	IC-756PRO2	
2	RF-A UNIT	.	.	
3	SCHMATIC	.	.	.	
4	DIAGRAM	DWN. NO.	A12-6C1	.	
5	ICOM	.	.	.	
6	ICOM Inc	.	.	.	

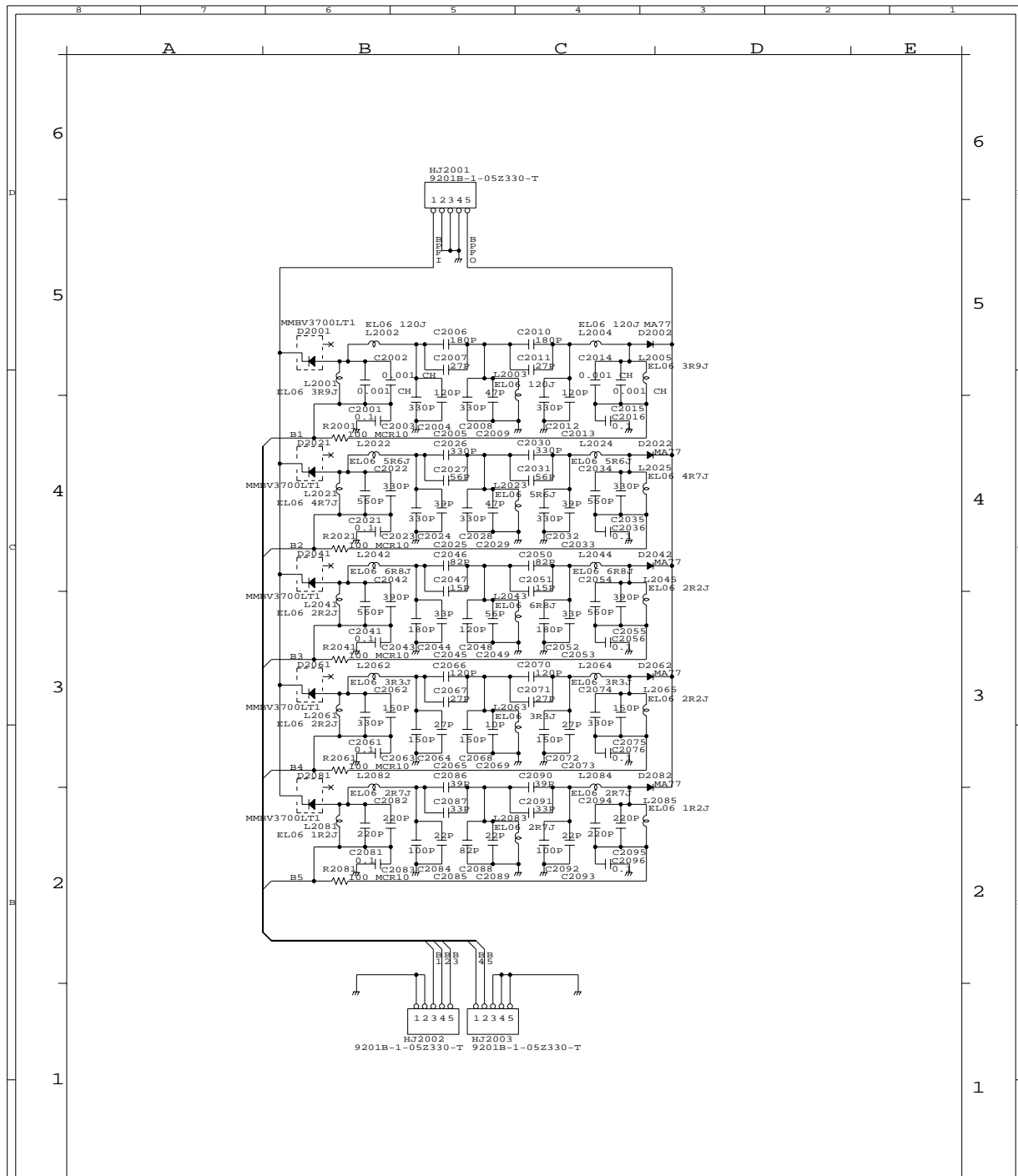

	A	B	C	D	E	
R E V I S I O N S	1	.	.	DATE 2001.07.30	MODEL IC-756PRO2	
	2	.	.	BPF BOARD		
	3	.	.	SCHEMATIC DIAGRAM		
	4	.	.	DWN.NO. A12A1-6C1		
	5	.	.	APPD.	CHKD.	DWN.BY
	6	.	.			
	7	.	.			
	8	.	.	ICOM	Icom Inc.	

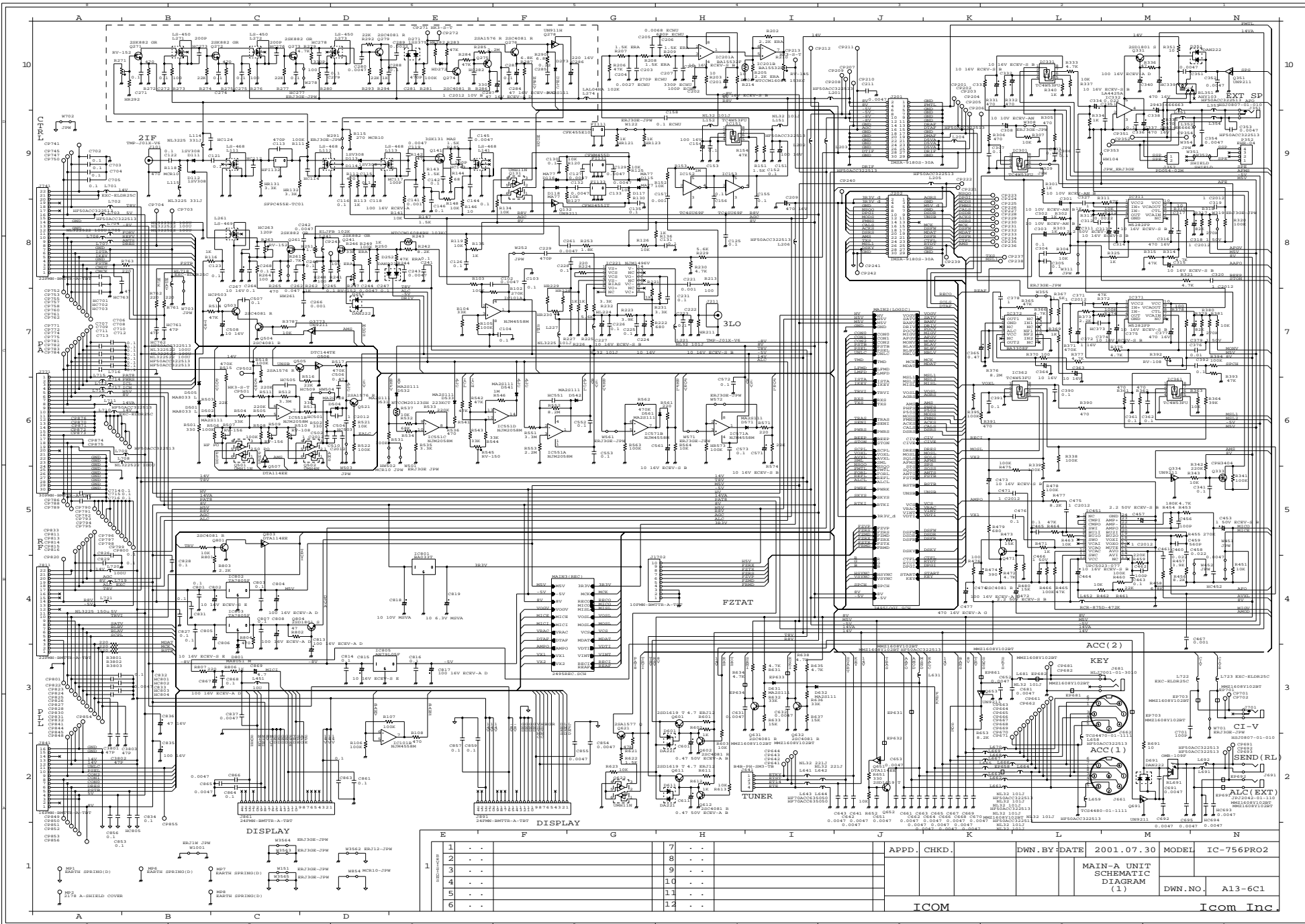

SECTION	E	F	G	H	I	J	K	L	M	N
1	-	-	-	-	-	-	-	-	-	-
2	-	-	-	-	-	-	-	-	-	-
3	-	-	-	-	-	-	-	-	-	-
4	-	-	-	-	-	-	-	-	-	-
5	-	-	-	-	-	-	-	-	-	-
6	-	-	-	-	-	-	-	-	-	-
7	-	-	-	-	-	-	-	-	-	-
8	-	-	-	-	-	-	-	-	-	-
9	-	-	-	-	-	-	-	-	-	-
10	-	-	-	-	-	-	-	-	-	-
11	-	-	-	-	-	-	-	-	-	-
12	-	-	-	-	-	-	-	-	-	-

APPD. CHKD. _____

DWN. BY DATE 2001.07.30

MODEL IC-756PRO2

MAIN-A UNIT SCHEMATIC DIAGRAM (1)

DWN. NO. A13-6C1

ICOM Icom Inc

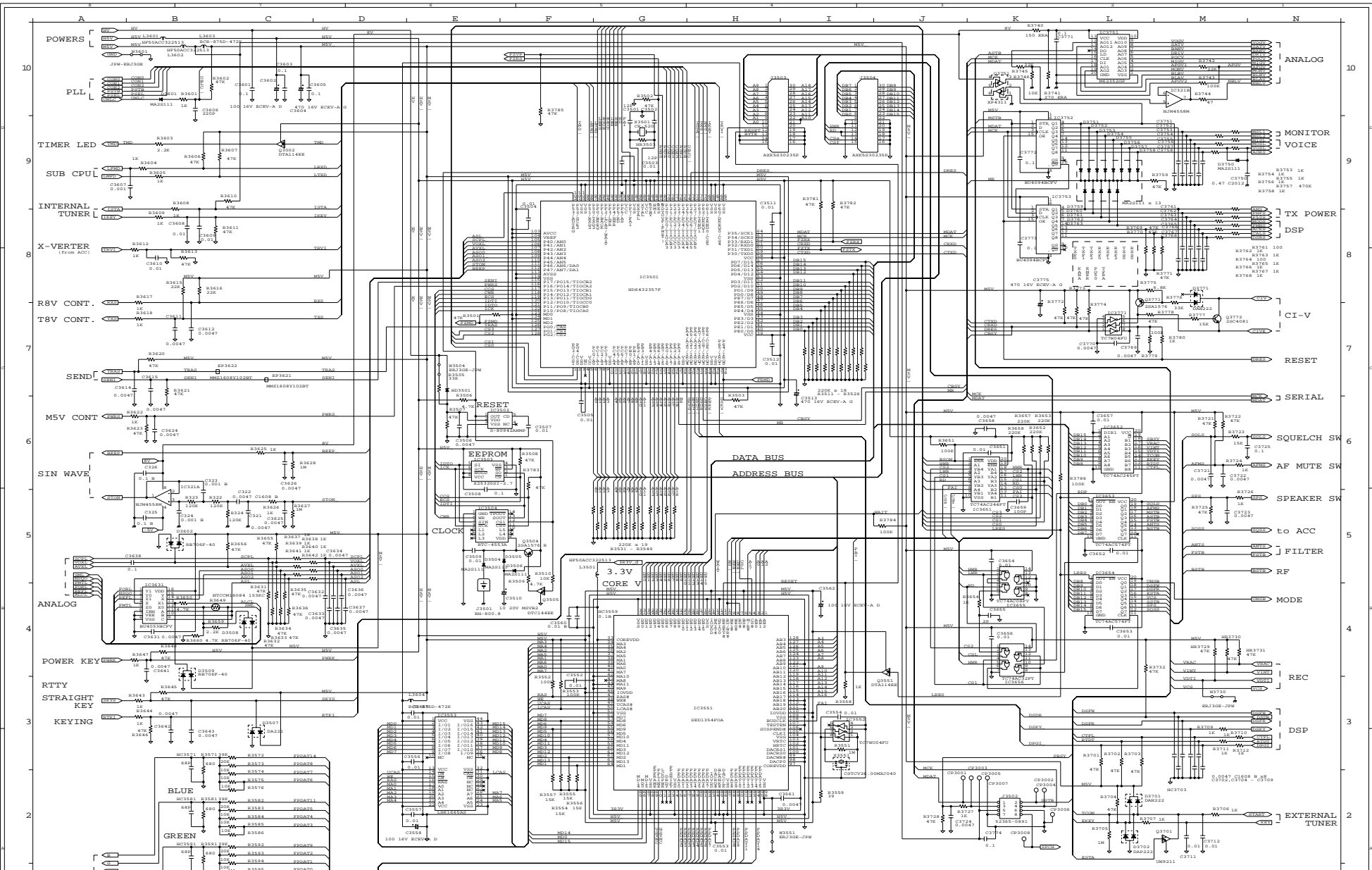

M5V_ : SWITCHED +5V
 H5V_ : CONSTANT +5V

REVISION NO.	DESCRIPTION	DATE	BY	CHKD.	APPD.	DWN. BY	DATE	MODEL	IC-756PRO2
1	2001.07.30	
2		
3		
4		
5		
6		

ICOM Icom Inc.

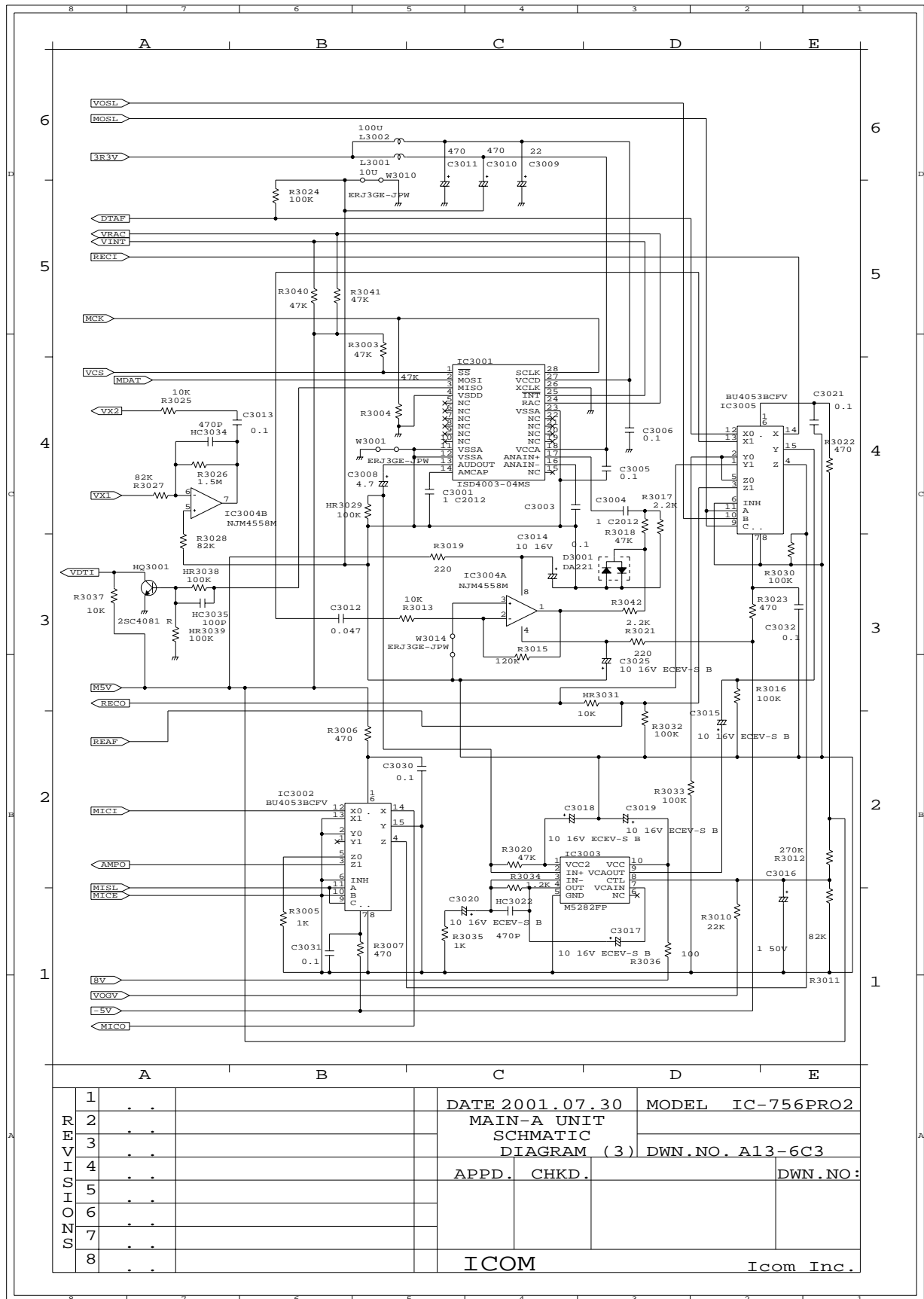

			DATE 2001.07.30	MODEL IC-756PRO2
			MAIN-A UNIT	
			SCHMATIC	
			DIAGRAM (3)	DWN.NO. A13-6C3
			APPD. CHKD.	DWN.NO.:
			ICOM	Icom Inc.

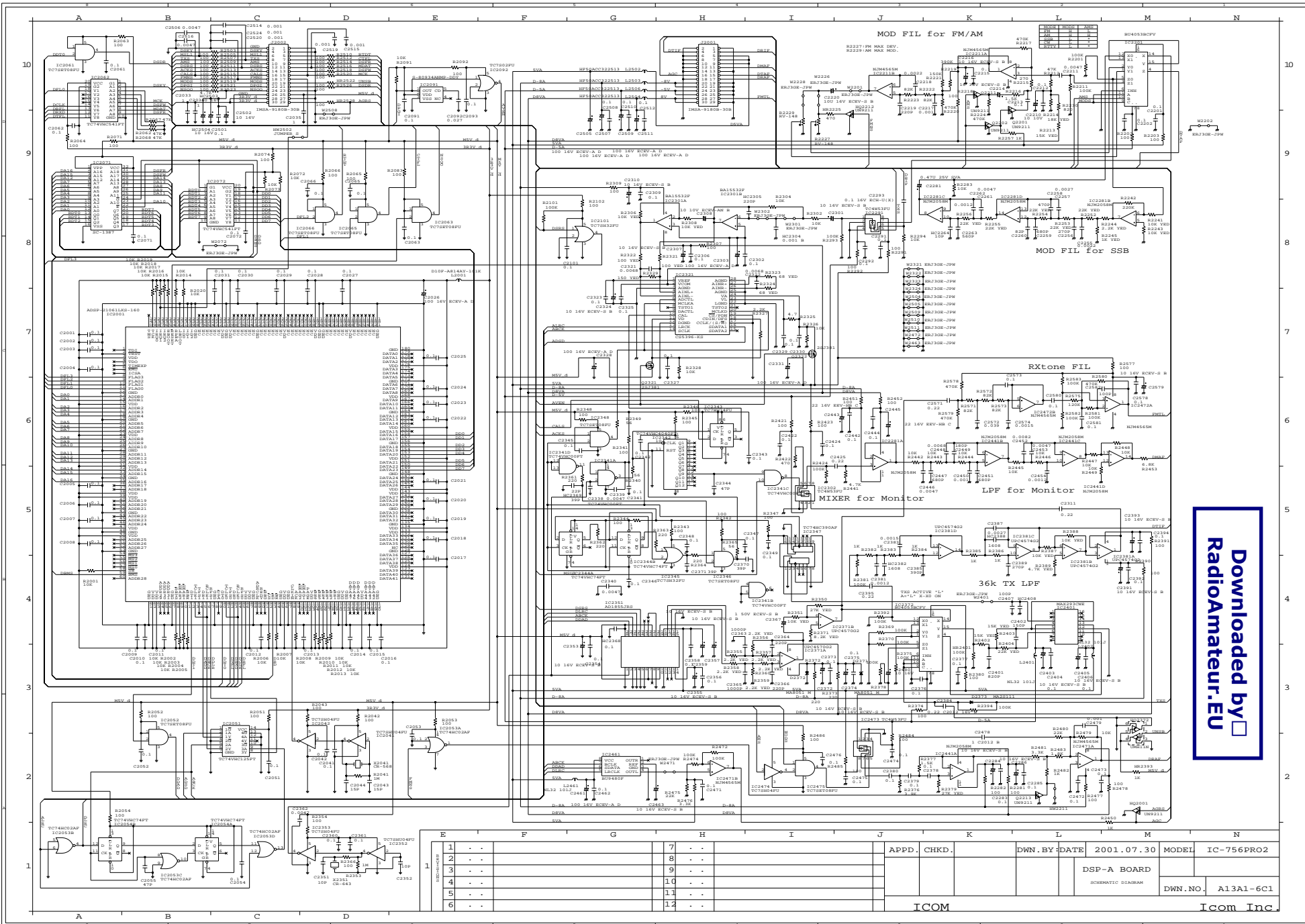

Downloaded by
 RadioAmateur.EU

1	-	-	-	-	-	APPD.	CHKD.	-	-	DWN. BY DATE	2001.07.30	MODEL	IC-756PRO2
2	-	-	-	-	-	-	-	-	-	DSP-A BOARD	-	-	-
3	-	-	-	-	-	-	-	-	-	SCHEMATIC DIAGRAM	-	DWN.NO.	A13A1-6C1
4	-	-	-	-	-	-	-	-	-	-	-	-	-
5	-	-	-	-	-	-	-	-	-	-	-	-	-
6	-	-	-	-	-	-	-	-	-	-	-	-	-

ICOM Icom Inc