

**ICOM**

**INSTRUCTION MANUAL**

COMMUNICATIONS RECEIVER  
**IC-R7000**

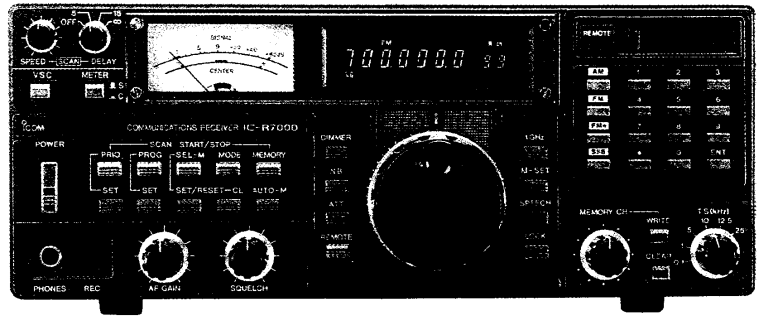

## FOREWORD

Thank you very much for selecting the new IC-R7000 from ICOM.

The most sophisticated, continuous coverage receiver on the market today, the IC-R7000 is the result of both advanced ICOM engineering and state-of-the-art computer interface technology from ICOM such as the new CI-V System: a feature that allows for easy and convenient computer control of your IC-R7000.

Equipped with 99 internal memories that are completely owner-programmable, the IC-R7000 is unmatched in scanning and coverage versatility within the 25 to 1300MHz range and may even cover frequencies up to 2000MHz. Low band, aircraft, marine, business, FM, amateur radio, emergency services, government, and television bands - all are conveniently available and immediately accessible with the IC-R7000.

To fully understand and appreciate the utility of your new IC-R7000, please study this instruction manual carefully prior to operation. If you have additional questions regarding operation of the IC-R7000, feel free to contact your nearest authorized ICOM dealer or Service Center.

## UNPACKING

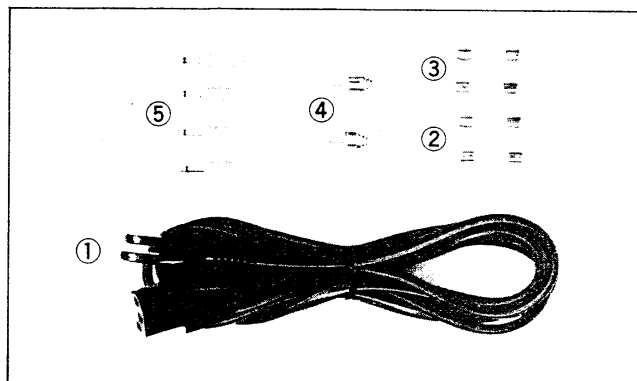

1. AC Power cable . . . . .	1
2. Fuses (2A) . . . . .	2
3. *Fuses . . . . .	2
4. RCA plugs . . . . .	2
5. Earphone plugs . . . . .	4
* USA version . . . . .	: 1A
Australia, Europe, France version . . . . .	: 0.5A

## TABLE OF CONTENTS

SECTION	1	DESCRIPTION .....	1
SECTION	2	SPECIFICATIONS .....	2
SECTION	3	CONTROL FUNCTIONS.....	3
	3-1	FRONT PANEL .....	3
	3-2	FREQUENCY DISPLAY .....	8
	3-3	REAR PANEL .....	9
SECTION	4	INSTALLATION AND CONNECTIONS .....	11
	4-1	INSTALLATION LOCATION .....	11
	4-2	AC POWER CONNECTION .....	11
	4-3	ANTENNA CONNECTION .....	11
	4-4	GROUND CONNECTION .....	12
	4-5	EXTERNAL SPEAKER CONNECTION .....	12
	4-6	CONNECTION TO TAPE RECORDER .....	13
	4-7	REMOTE JACK CONNECTION .....	13
SECTION	5	OPERATIONS .....	14
	5-1	SETTINGS .....	14
	5-2	BASIC OPERATION .....	14
	5-3	FREQUENCY SETTING .....	15
	5-4	MEMORY OPERATION .....	17
	5-5	SCANNING OPERATION .....	19
	5-6	AUTO STOP FUNCTION .....	28
	5-7	M-SET SWITCH .....	28
SECTION	6	PRECAUTIONS AND MAINTENANCE.....	29
	6-1	OPERATING WARNING .....	29
	6-2	MAINTENANCE .....	29
	6-3	AC POWER SUPPLY MODIFICATIONS .....	30
SECTION	7	TROUBLESHOOTING .....	31
SECTION	8	INSIDE VIEWS .....	32
	8-1	POWER SUPPLY/DC-DC CONVERTER UNIT .....	32
	8-2	LOGIC UNIT .....	32
	8-3	RF/IF UNIT .....	33
	8-4	MAIN UNIT .....	33
	8-5	PLL UNIT .....	33
SECTION	9	OPTION INSTALLATIONS.....	34
SECTION	10	BLOCK DIAGRAM .....	35
SECTION	11	OPTIONS .....	36

## SECTION 1 DESCRIPTION

### ■ WIDE RANGE COMMUNICATIONS RECEIVER

The IC-R7000 is a sophisticated communications receiver designed for a wide variety of users, covering HF, VHF, and UHF bands all in one single, compact unit. The IC-R7000 also comes installed with a crystal converter that makes Amateur radio reception possible in the entire 1240 to 1300MHz frequency range.

### ■ ALL MODES INCORPORATED

The IC-R7000 incorporates an AM mode, an FM mode using both wide and narrow filters, and an SSB mode that offers both LSB and USB selection, making a wide variety of reception possible.

### ■ BUILT-IN, 99-CHANNEL LARGE MEMORY CAPACITY

A total of 99 memory channels are available in the IC-R7000 for convenient storage of both received frequencies and the reception modes. VFO operations are possible when using any memory channel.

### ■ STATION SELECTION VERSATILITY

With the IC-R7000 you not only have normal tuning capability with the front panel tuning control: you can also shift quickly to a desired frequency by using the keyboard to program frequency data. In addition, tuning pitch can be selected between the following frequencies: 100Hz, 1kHz, 5kHz, 10kHz, 12.5kHz, and 25kHz.

### ■ VARIETY OF SCANNING FUNCTIONS

The IC-R7000 incorporates a total of six separate scanning functions for easy access to a wide range of frequencies.

- PRIORITY SCAN eliminates the need for channel searching by automatically monitoring programmed channels while you listen to your main operating channel.
- PROGRAMMED SCAN offers detailed coverage of a specific frequency range by repeatedly scanning it.
- SELECTED MEMORY SCAN allows you to continuously scan your favorite programmed memory channels.
- SELECTED MODE MEMORY SCAN automatically monitors all memories which contain programmed frequencies with a similar mode.
- MEMORY CHANNEL SCAN repeatedly scans the entire 99-Channel Memory in sequence.
- AUTO-WRITE MEMORY SCAN monitors the specified frequency range contained in PROGRAMMED SCAN and automatically writes any incoming signals within that frequency range to Memory Channels 80 through 99, the AUTO MEMORY WRITE AREA.

### ■ VSC FUNCTION FOR IMPROVED RECEPTION

The VSC (VOICE SCAN CONTROL) function in the IC-R7000 allows you to skip all frequencies with inaudible voice signals while concentrating on those that are clear.

### ■ S-METER SQUELCH

In addition to regular squelch capability, the IC-R7000 incorporates an S-Meter Squelch function which squelches all incoming signals stronger than the level indicated by the S-Meter. Incoming signals less than the S-Meter reading will not be squelched.

## SECTION 2 SPECIFICATIONS

- Receive frequency range

VERSION	FREQUENCY COVERAGE (MHz)
USA and EUROPE	25 ~ 999.999 * 1025 ~ 1999.999
AUSTRALIA and FRANCE	** 25 ~ 999.999 * 1025 ~ 1999.999

\* Specifications guaranteed from 1240 to 1300MHz.

\*\* Excluding 87.5 to 108MHz.

- Receive modes

: A3E (AM), F3E (FM), J3E (SSB)

- Sensitivity

: 25 ~ 999.999MHz

FM : Less than 0.5 $\mu$ V for 12dB SINAD

FM (wide) : Less than 1.0 $\mu$ V for 12dB SINAD

AM : Less than 1.0 $\mu$ V for 10dB S/N

SSB : Less than 0.3 $\mu$ V for 10dB S/N

1240 ~ 1300MHz

FM : Less than 0.5 $\mu$ V for 12dB SINAD

FM (wide) : Less than 2.0 $\mu$ V for 12dB SINAD

AM : Less than 2.0 $\mu$ V for 10dB S/N

SSB : Less than 0.3 $\mu$ V for 10dB S/N

- Squelch sensitivity

: FM (Threshold) Less than 0.2 $\mu$ V for noise squelch

FM (Tight) More than 32mV for meter squelch at S9+60dB

SSB (Threshold) More than 3.0 $\mu$ V for meter squelch

- Selectivity

: FM, AM  $\pm$ 7.5kHz minimum at -6dB

FM (narrow), AM (narrow)  $\pm$ 3.0kHz minimum at -6dB

FM (wide)  $\pm$ 75kHz minimum at -6dB

SSB  $\pm$ 1.4kHz minimum at -6dB

- Spurious and image response rejection

: More than 60dB

- Frequency stability

: 25 ~ 999.999MHz  $\pm$ 5ppm at 0°C ~ +50°C

1240 ~ 1300MHz  $\pm$ 10ppm at 0°C ~ +50°C

- Receive system

: 25 ~ 999.999MHz

FM, AM, SSB Triple-conversion superheterodyne

FM (wide) Double-conversion superheterodyne

1240 ~ 1300MHz:

FM, AM, SSB Quadruple-conversion superheterodyne

FM (wide) Triple-conversion superheterodyne

- Intermediate frequencies

: 25 ~ 512MHz:

1st 778.7MHz

2nd 10.7MHz

3rd 455kHz excluding FM (wide) mode

512 ~ 999.999MHz

1st 266.7MHz

2nd 10.7MHz

3rd 455kHz excluding FM (wide) mode

- Frequency control

: CPU based 100Hz step digital PLL synthesizer

- Number of memory channels

: 99 channels

- Supply voltage

: 117, 220 or 234V AC (50/60Hz)

- Current drain

: Receiving 1.7A at maximum audio output

Squelched 1.4A

- Antenna impedance

: 50 ohms

- Audio output

: More than 2.5W at 10% distortion with an 8 ohm load

- Audio output impedance

: 4 ~ 8 ohms

- Usable temperature

: -10°C ~ +60°C

- Dimensions

: 286(303)mm(W) x 110(127)mm(H) x 276(319)mm(D)

Bracketed values include projections.

- Weight

: Approximately 8.0kg (excluding options)

• All stated specifications are subject to change without notice or obligation.

**SECTION 3 CONTROL FUNCTIONS**

**3-1 FRONT PANEL**

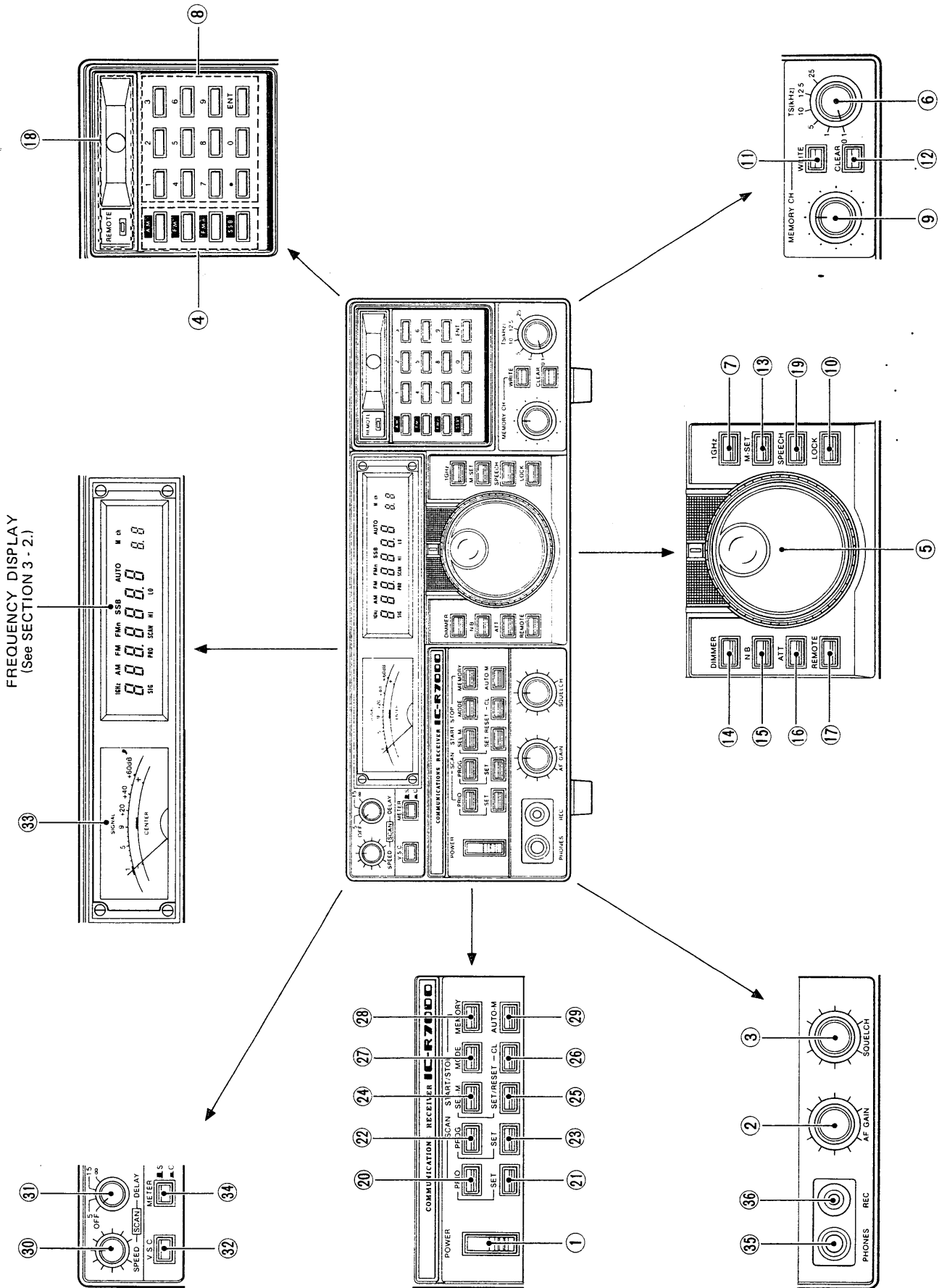

FREQUENCY DISPLAY  
(See SECTION 3 - 2.)

① POWER SWITCH

POWER



This is a push-lock switch which controls the input AC power to the IC-R7000.

② AF GAIN CONTROL

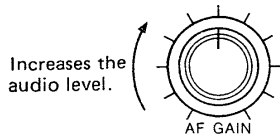

This control varies the audio output level of the IC-R7000. Clockwise rotation increases the level.

③ SQUELCH CONTROL

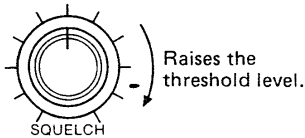

This control sets the squelch threshold level, muting incoming signals. To set the squelch threshold level, turn the control clockwise.

When a signal is completely muted the illuminated "SIG" indicator on the FREQUENCY DISPLAY will go out.

④ MODE SELECT SWITCHES



These switches select any of the four operating modes for the IC-R7000: AM, FM, FMn, or SSB. Press the appropriate switch for the desired mode.

⑤ TUNING CONTROL

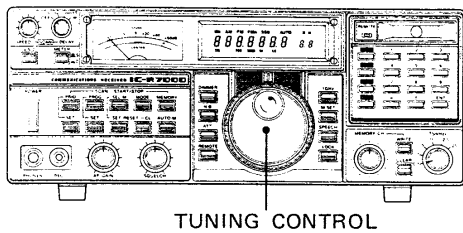

Rotate this control clockwise to increase frequency numbers and counterclockwise to decrease them.

⑥ TUNING STEP SELECTOR CONTROL [TS]

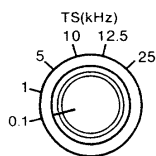

This control allows you to select frequency steps in six different increments for all four operating modes: 0.1kHz, 1kHz, 5kHz, 10kHz, 12.5kHz, and 25kHz.

⑦ 1GHz BAND SWITCH [1GHz]



This switch is for band setting when operating in the 1240 ~ 1300MHz frequency range and allows you to operate at a frequency 1GHz greater than that displayed on the FREQUENCY DISPLAY.

The "1GHz" indicator lights up on the FREQUENCY DISPLAY when the 1GHz band is being used.

⑧ KEYBOARD

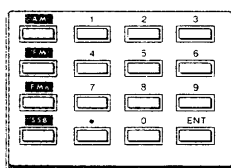

Both operating frequency and memory channel numbers can be set directly by using the KEYBOARD on the front panel. The KEYBOARD consists of number keys 0 through 9, a decimal point key [ . ], and an enter key [ ENT ].

For a detailed description of how to set frequencies and memory channels, see SECTIONS 5 - 3 FREQUENCY SETTING and 5 - 4 MEMORY OPERATION.

**⑨ MEMORY CHANNEL SELECTOR CONTROL [MEMORY CH]**

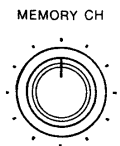

This control performs the dual function of selecting memory channels and entering specific memory channel numbers that are programmed using the KEYBOARD number keys.

For further details regarding operation of this control, see SECTION 5 - 4 (1) HOW TO CALL A MEMORY CHANNEL.

**⑩ DIAL LOCK SWITCH [LOCK]**



This switch functions as a lock for the TUNING CONTROL and MEMORY CHANNEL SELECTOR CONTROL, locking each electrically.

**⑪ MEMORY CHANNEL-WRITE SWITCH [MEMORY CH-WRITE]**

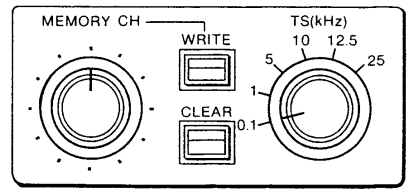

Use this switch to store display frequency and receive mode data in any of the memory channels. When pressed, the displayed contents will automatically be written into the specified memory channel.

When storing information while in the SSB mode, use the USB/LSB SELECTOR SWITCH on the back panel to specify which SSB mode you wish to use.

See SECTION 3 - 3 REAR PANEL for more information regarding the use of the USB/LSB SELECTOR SWITCH.

**⑫ CLEAR SWITCH [CLEAR]**



This switch clears unwanted information in any memory channel. When pressed, information in the displayed memory channel is erased and the memory channel reverts to blank status.

**⑬ MEMORY SET SWITCH [M-SET]**



This switch is used to temporarily transfer displayed frequency and mode information to new memory channels.

See SECTION 5 - 7 M-SET SWITCH for further details regarding operation.

**⑭ DIMMER SWITCH [DIMMER]**



This switch alters the luminescence of the front panel meter and display. Press the switch to lower the luminescence while operating the receiver in dark places or at night.

**⑮ NOISE BLANKER SWITCH [NB]**



This switch eliminates pulse-type noise from automobile ignition systems and turns the noise-blanker circuit ON and OFF. This clarifies incoming signals and is effective in eliminating noise in the AM and SSB modes.

**⑯ ATTENUATOR SWITCH [ATT]**



Use of the internal attenuator is recommended when receiving in areas where powerful radio waves exist, such as near broadcasting stations. Press the ATTENUATOR SWITCH to activate the attenuator.

Signals from the antenna will be attenuated by approximately 20dB in every receive mode.

**⑰ REMOTE SWITCH [REMOTE]**



The REMOTE SWITCH activates the receiver for use with an optional RC-12 WIRELESS REMOTE CONTROLLER unit.

When the switch is pressed, the remote control circuit opens and the LED indicator light near the remote-controlled light sensor on the front panel is illuminated.

See SECTION 9 OPTION INSTALLATIONS for RC-12 installation instructions.



**18 REMOTE CONTROL SENSOR AND LED INDICATOR**

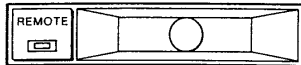

This sensor receives infra-red rays from the optional RC-12 WIRELESS REMOTE CONTROLLER unit. Press the REMOTE SWITCH on the RC-12 to activate the sensor. When the REMOTE SWITCH is pressed the REMOTE LED INDICATOR is illuminated.

**19 SPEECH SWITCH [SPEECH]**



This switch initiates voice reproduction of display frequencies when using an optional IC-EX310 VOICE SYNTHESIZER unit.

See SECTION 9 for IC-EX310 installation instructions.

**20 SCAN START/STOP SWITCHES**

**20 PRIORITY SCAN START/STOP SWITCH [PRIO]**



This SCAN START/STOP switch turns ON and OFF the PRIORITY SCAN function which contains programmed frequency and mode information.

See SECTION 5 - 5 (1) PRIORITY SCAN for further details.

**21 PRIORITY SCAN SET SWITCH [PRIO-SET]**

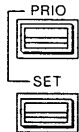

This switch is used to call the priority channel to write a desired frequency into it.

See SECTION 5 - 5 (1) for further details regarding operation.

**22 PROGRAMMED SCAN START/STOP SWITCH [PROG]**



This switch is used for starting and stopping the PROGRAMMED SCAN function which continuously scans frequencies programmed in a user-set HI-LO scan range.

See SECTION 5 - 5 (2) for further details regarding operation.

**23 PROGRAMMED SCAN SET SWITCH [PROG-SET]**

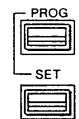

This switch is used for setting or checking the upper and lower frequency limits in the PROGRAMMED SCAN HI-LO scan range.

See SECTION 5 - 5 (2) for further details regarding operation.

**24 SELECTED MEMORY SCAN START/STOP SWITCH [SEL-M]**



This switch is used for starting and stopping the SELECTED MEMORY SCAN function which continuously scans specified memory channels.

See SECTION 5 - 5 (3) for further details regarding operation.

**25 SELECTED MEMORY SET/RESET SWITCH [SET/RESET]**



Use of this switch is for setting or cancelling the memory channel to be scanned by the SELECTED MEMORY SCAN function.

For additional operating information see SECTION 5 - 5 (3).

**26 SELECTED MEMORY CLEAR SWITCH [CL]**

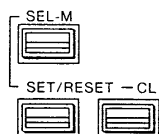

This switch clears ALL previously programmed selected memory channels that were entered using the [SET/RESET] SWITCH.

**27 SELECTED MODE MEMORY SCAN START/STOP SWITCH [MODE]**



This scan switch turns ON and OFF the SELECTED MODE MEMORY SCAN function which repeatedly scans all memory channels containing frequencies in the same mode as that illuminated on the FREQUENCY DISPLAY.

SECTION 5 - 5 (4) for additional operating information.

**28 MEMORY CHANNEL SCAN  
START/STOP SWITCH [MEMORY]**



This switch turns ON and OFF the MEMORY CHANNEL SCAN function which scans every memory channel except those in blank status.

See SECTION 5 - 5 (5) for further operating details.

**29 AUTO-WRITE MEMORY SCAN  
START/STOP SWITCH [AUTO-M]**



This switch turns ON and OFF the AUTO-WRITE MEMORY SCAN function which automatically writes received frequencies into memory channels 80 through 99 while repeatedly scanning the frequency range set in the HI-LO scan range.

For further details regarding operation see SECTION 5 - 5 (6).

**30 SCAN-SPEED CONTROL  
[SCAN-SPEED]**

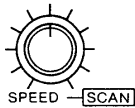

The scan speed of each scanning function can be set or altered by using this control. Turning the control clockwise increases scan speed while turning it counterclockwise decreases the speed.

For further details see SECTION 5 - 6 (3) SCAN SPEED.

**31 SCAN-DELAY CONTROL  
[SCAN-DELAY]**

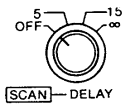

This control sets the delay times for restarting scanning after incoming signals are received and stopped.

SCAN DELAY has 4 separate delay time settings: OFF, 5 (seconds), 15 (seconds) and infinity ( $\infty$ ). These settings determine the amount of time a signal will be stopped.

For further details regarding operation see SECTION 5 - 6 (2).

**32 VOICE SCAN CONTROL SWITCH  
[VSC]**



This switch turns the VOICE SCAN CONTROL circuit ON and OFF. When scanning, the scan stops only at received signals carrying voices or audio signals.

VOICE SCAN CONTROL function operates in every scan function. For further details regarding operation see SECTION 5 - 6 (1).

**33 METER**

This meter functions as an S-Meter (Signal Strength Meter) when signals are being received, and also as a Center Frequency Meter if the METER SWITCH is pressed IN.

**34 METER SWITCH [METER]**



The METER SWITCH selects either of the following for display on the METER: signal strength of a received signal or the center frequency for a targeted signal.

**35 PHONES JACK [PHONES]**



PHONES

The PHONES JACK is used for connecting headphones to the receiver. For ideal audio clarity the headphones should be 4 to 16 ohms impedance. While the headphones are in use, the built-in speaker will emit no sound.

An optional HP-2 communication headphones set is also available, from ICOM.

**36 RECORDING JACK [REC]**



REC

The RECORDING JACK is used for connecting a tape recorder to the IC-R7000. Make the receiver connection from the RECORDING JACK to the AUX JACK on the tape recorder.

Recording will occur at a constant level of audio frequency output regardless of the setting of the AF GAIN control.

### 3 - 2 FREQUENCY DISPLAY

The IC-R7000 FREQUENCY DISPLAY gives an easy-to-read, comprehensive display of operating modes, functions, frequencies, and memory channels.

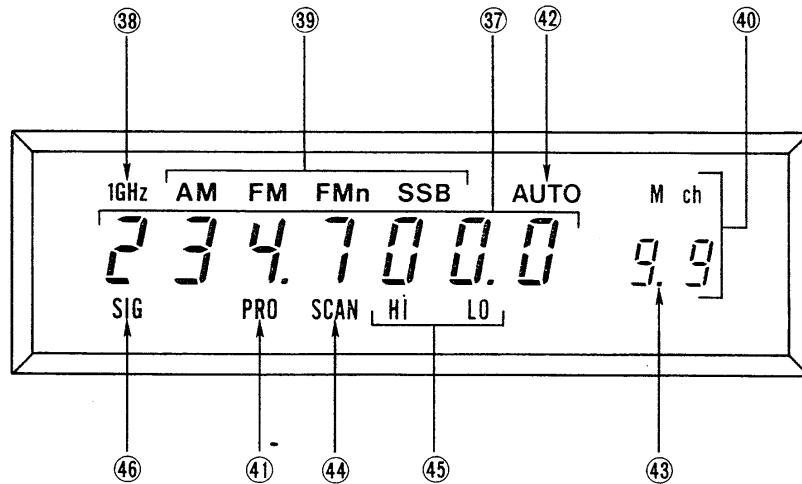

**37 FREQUENCY INDICATOR**

This indicator shows operating frequencies from resolutions of 100MHz to 100Hz in a seven-digit display readout.

**38 1GHz INDICATOR [1GHz]**

This indicator is lit by pressing the 1GHz SWITCH and is used for receiving at frequencies 1GHz greater than that shown on the display.

**39 MODE INDICATOR**

This indicator is lit by pressing any of the mode switches and shows the current operating mode.

**40 MEMORY CHANNEL INDICATOR [Mch]**

This indicator shows the channel number stored in the IC-R7000 memories. It also shows "P" when the PRIORITY SCAN function is being set or operating.

**41 PROGRAMMED SCAN INDICATOR [PRO]**

This indicator shows that all pre-programmed frequencies are being scanned.

**42 AUTO INDICATOR [AUTO]**

This indicator is illuminated together with "SCAN" by pressing the [AUTO-M] SWITCH, and shows that the IC-R7000 is in AUTO-WRITE MEMORY SCAN.

**43 SELECTED MEMORY INDICATOR [.]**

This indicator is illuminated by pressing [SEL-M-SET] and appears as a small dot in the memory channel displayed under the "Mch" indicator. [.] marks a selected memory channel.

**44 SCAN INDICATOR [SCAN]**

If any of the six scan START/STOP SWITCHES are pressed, this indicator will light up.

**45 HI-LO INDICATOR [HI] [LO]**

Alternately pressing the [PROG-SET] SWITCH illuminates "LO" and "HI", indicating the lower and upper frequency limits of the scan range set for PROGRAMMED SCAN.

**46 SIGNAL INDICATOR [SIG]**

This indicator shows that a signal is being received and remains illuminated unless the SQUELCH CONTROL is used to mute the signal.

### 3-3 REAR PANEL

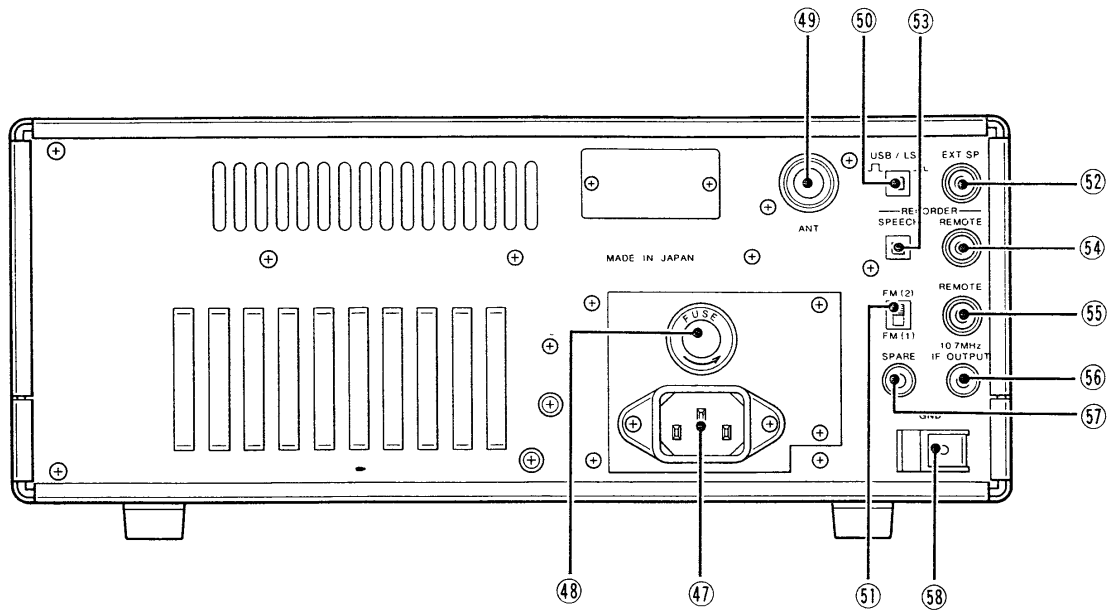

#### ④⑦ AC POWER SOCKET

The AC POWER SOCKET connects the IC-R7000 to AC outlets via the supplied AC cable.

#### ④⑧ FUSE HOLDER

This holder contains the fuses for AC power supply. Use the spare fuses provided to replace an old or damaged fuse.

#### ④⑨ ANTENNA CONNECTOR [ANT]

Connect an antenna with an impedance of 50 ohms into this antenna terminal. Connect with an Type-N connector.

A recommended option as a complement to your receiver system is the AH-7000 SUPER WIDEBAND OMNIDIRECTIONAL ANTENNA.

#### ⑤⑩ USB/LSB SELECTOR SWITCH [USB/LSB]



This switch controls selection of USB or LSB when operating in SSB mode. Press the switch alternately for USB or LSB operation.

#### ⑤⑪ FM(1)-FM(2) SELECTOR SWITCH [FM(1), FM(2)]

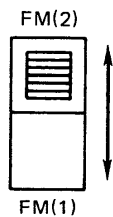

When operating in either FM mode or FMn mode, use the selector switch to select the passband widths that suit your operating needs.

The table below should be referred to when using the selector switch.

FRONT PANEL MODES	REAR PANEL SWITCH POSITIONS	
	FM(1)	FM(2)
FM	15kHz	150kHz
FMn	6kHz	15kHz

#### ⑤⑫ EXTERNAL SPEAKER JACK [EXT SP]

This jack provides connection for an external speaker. A speaker with an impedance of 4 ~ 8 ohms is recommended for optimum audio performance. Use the supplied speaker plug to connect the external speaker to the receiver. When using an external speaker, sound will not be emitted from the internal speaker.

**⑤③ RECORDER-SPEECH SWITCH  
[RECORDER-SPEECH]**

This switch is used when operating the IC-R7000 with a tape recorder. Press the switch once to activate this function and again to disengage it.

If your receiver is equipped with an optional IC-EX310 VOICE SYNTHESIZER unit, you can record signal contents of received signals and synthesized voice readouts of their frequency by using the RECORDER-SPEECH SWITCH.

See SECTION 9 OPTION INSTALLATIONS for more details regarding installation and connections.

**⑤④ RECORDER-REMOTE JACK  
[RECORDER-REMOTE]**

This jack is used for tape recorder remote control and is connected internally to the IC-R7000 squelch circuit.

It is designed so that received signal contents are recorded only when the squelch circuit is open. Run a connecting cable between this jack and the remote terminal on your tape recorder to complete the connection.

See SECTION 4 - 6 CONNECTION TO TAPE RECORDER for more details regarding installation and connections.

**⑤⑤ REMOTE JACK [REMOTE]**

This is a communications port designed for use with a personal computer for remote control of the receiver, utilizing the advanced ICOM CI-V Communication Interface System.

An optional CT-17 CI-V LEVEL CONVERTER is available to connect the IC-R7000 to an RS-232C serial port.

**⑤⑥ 10.7MHz IF OUTPUT JACK  
[10.7MHz IF OUTPUT]**

This jack outputs 10.7MHz 2nd IF signals which are superimposed on the 9V DC level.

Be careful when operating with this signal as this jack also outputs DC voltage.

**⑤⑦ SPARE JACK [SPARE]**

Not connected.

**⑤⑧ GROUND TERMINAL [GND]**

This terminal is used for grounding the receiver. Refer to SECTION 4 - 4 GROUND CONNECTION.

## SECTION 4 INSTALLATIONS AND CONNECTIONS

### 4-1 INSTALLATION LOCATION

Pay attention to the following points when installing the IC-R7000:

- Avoid placing the IC-R7000 in direct sunlight, and in places subject to high temperatures, humidity, dust, or excessive vibration.
- Also, be sure to allow ample space at the rear panel for installation of the power cable and coaxial cables.

### 4-2 AC POWER CONNECTION

When using the supplied AC power cable to connect the IC-R7000 to a AC outlet, refer to the diagram for instructions.

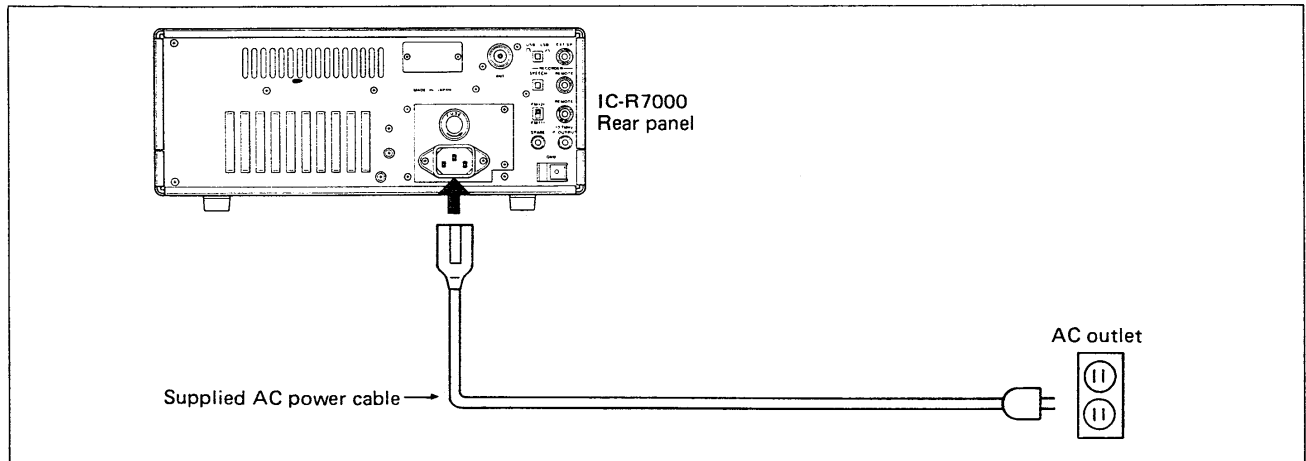

### 4-3 ANTENNA CONNECTION

Choose an appropriate antenna that meets your receiving requirements, making sure it matches the frequency band you wish to receive in.

An exceptional antenna with super wideband range capability is the AH-7000 SUPER WIDEBAND OMNIDIRECTIONAL ANTENNA. It completely matches the bandwidth of the IC-R7000, covering bands between 25 and 1300MHz.

When installing an antenna, make sure it is positioned in a high place away from TV antennas, electric light leads, telephone lines, and other buildings.

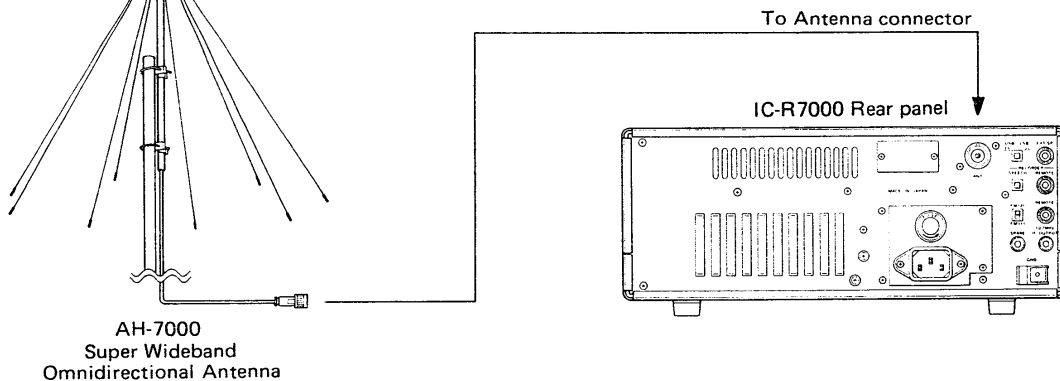

## ■ COAXIAL CABLE

Impedance for any antenna used with the IC-R7000 should be 50 ohms. If a coaxial feedline is used between the antenna and receiver, it should also have an impedance of 50 ohms.

To inhibit coaxial cable loss install a coaxial cable that is as thick as possible since coaxial cable loss increases as frequency increases. This is particularly important with the IC-R7000 because of its ability to receive high frequency signals at levels greater than 1200MHz.

## ■ TYPE-N CONNECTOR INSTALLATION

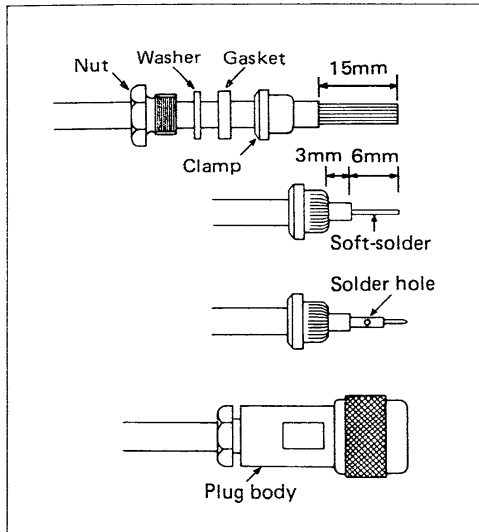

Follow the procedure below for connecting cables with a coaxial cable:

1) Slide the nut, washer, gasket and clamp over the coaxial cable and cut the end of the cable evenly.

2) Cut and remove 15mm of the outer vinyl jacket, and fold the braid back over the clamp. The clamp end should be flush with the end of the vinyl jacket. Trim the braid ends evenly.

Cut and remove 6mm of the dielectric (center conductor insulation).

3) Soft-solder the center conductor. Install center conductor pin and solder.

4) Carefully slide the plug body into place, aligning the center conductor pin on the cable with the hole in the insulator inside the plug body.

5) Complete the assembly by screwing the nut into the plug body.

## 4 - 4 GROUND CONNECTION

To prevent accidents involving electricity and interference from other machines, bury a commercially-available earthing rod or copper plate in the ground and connect it to the rear panel GROUND TERMINAL.

Make sure the thickest possible lead is used, and also be sure the lead is as short as possible, covering the shortest distance from the grounding rod to the GROUND TERMINAL.

**CAUTION:** It is extremely dangerous to use gas pipes or electrical wiring for earthing purposes. Never ground your receiver using these!

## 4 - 5 EXTERNAL SPEAKER CONNECTION

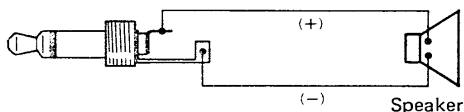

An external speaker can be connected to the IC-R7000 by using the EXTERNAL SPEAKER JACK. For ideal audio clarity use an external speaker with 8 ohms impedance. For your convenience a connector plug comes with the IC-R7000.

When connected to an external speaker, the IC-R7000's internal speaker will not operate.

Connect the external speaker to the supplied connector plug as shown in the diagram.

#### 4-6 CONNECTION TO TAPE RECORDER

Make connections for the IC-R7000 to a tape recorder as shown in the diagram.

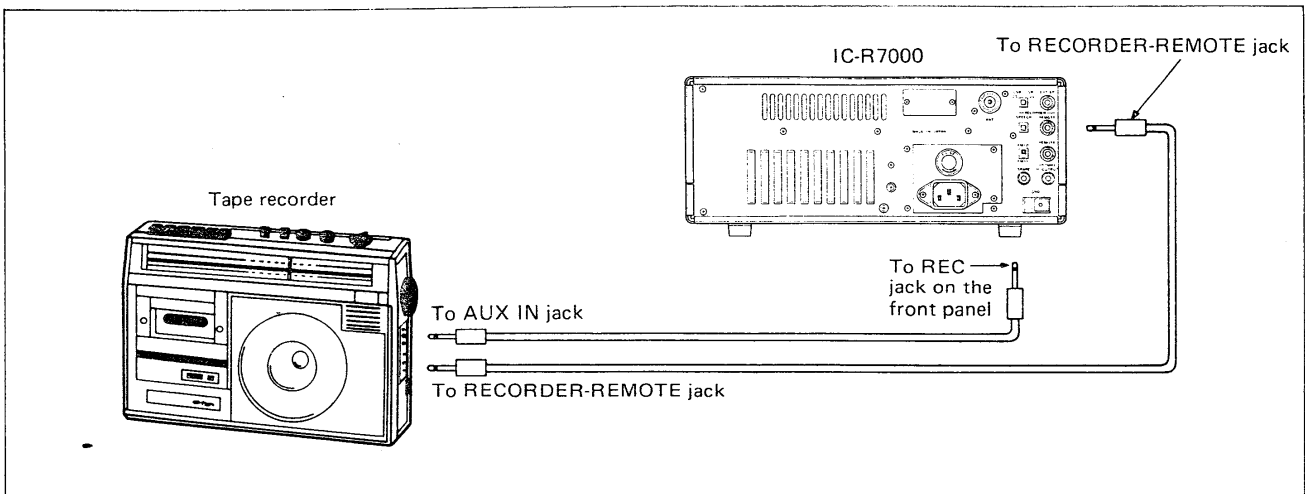

#### 4-7 REMOTE CONTROL JACK (CI-V) INFORMATION

ICOM has introduced a new remote control Local Area Network, the ICOM COMMUNICATION INTERFACE-V (CI-V) SYSTEM using the CSMA/CD (Carrier Sense Multiple Access with Collision Detection) standard.

- A serial data bus carries all control data. Operation is possible using an optional CT-17 LEVEL CONVERTER with a personal computer equipped with an RS-232C serial port.

#### •CT-17 CONNECTION

Up to four ICOM CI-V transceivers can be connected to a personal computer via the CT-17.

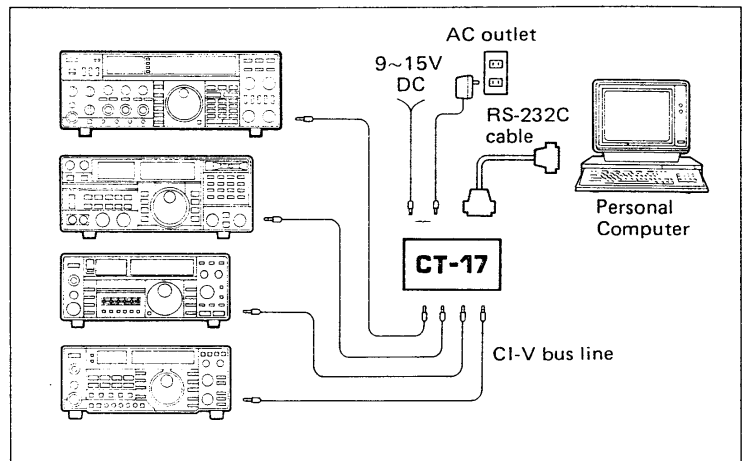

#### •REMOTE CONTROL DEFAULT CONNECTOR

Transmitters and receivers using the ICOM CI-V System exchange serial information in the packet format. The contents of a data packet can be changed by using connector pin J17 on the LOGIC UNIT.

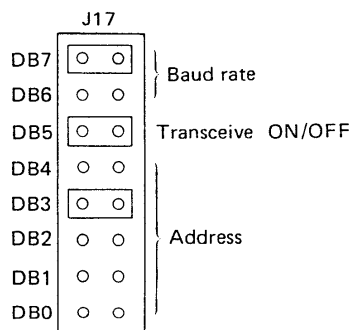

Standard data packet contents of the IC-R7000:

Address number : 08H  
 Transceive function : ON  
 Baud rate : 1200bps



## SECTION 5 OPERATIONS

### 5 - 1 SETTINGS

After connecting the power supply and antenna, set the switches and controls according to the settings shown in the table below.

SWITCH/CONTROL	POSITION
POWER	OFF (OUT)
AF GAIN	TURN FULLY *CCW
SQUELCH	TURN FULLY *CCW
DIMMER	OFF (OUT)
NB	OFF (OUT)
ATT	OFF (OUT)
REMOTE	OFF (OUT)
LOCK	OFF (OUT)
1GHz	OFF (OUT)
VSC	OFF (OUT)
METER	S-METER
TS	1kHz

\*CCW: counterclockwise

### 5 - 2 BASIC OPERATION

#### (1) POWER ON

Press the POWER SWITCH to supply power to the IC-R7000. When power is supplied the displays and meter lamps are illuminated and the receiver is fully operational.

#### ■ DISPLAY INFORMATION

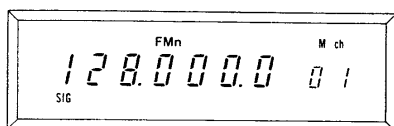

Blank status

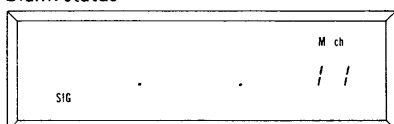

- The IC-R7000 has a backup memory function to ensure that no frequency, receive mode, or memory information will be lost from the FREQUENCY DISPLAY if power to the receiver is cut off accidentally or prematurely.
- When power to the IC-R7000 is turned OFF, information illuminated on the FREQUENCY DISPLAY at that time will automatically be preserved and stored.
- Prior to shipment from the factory, the IC-R7000 was programmed with unspecified frequencies and receive modes in memory channels 1 through 10. Memory channels 11 through 99 are in blank status.

#### (2) RECEIVE MODE SELECTION

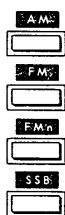

- 1) To select the appropriate mode you wish to receive in, press the corresponding MODE SWITCH on the front panel.
- 2) The selected mode will then be illuminated on the front panel display.

**NOTE:** When any MODE SWITCH is pressed while a displayed memory channel is in blank status, the FREQUENCY DISPLAY will automatically indicate the lower frequency limit (25MHz).

#### (3) AF GAIN ADJUSTMENT

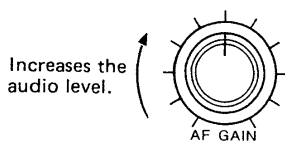

- 1) When the IC-R7000 is receiving, a hissing noise coming from the speaker can be heard.
- 2) To adjust the sound level of this noise, use the AF GAIN CONTROL, slowly turning the control clockwise until a comfortable listening level is reached.

#### (4) SQUELCH ADJUSTMENT

##### ● FMn, AM

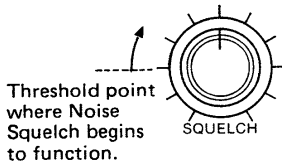

##### ● All modes

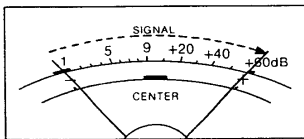
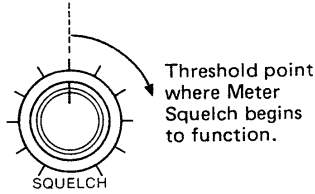

#### (5) TUNING

The IC-R7000 has two squelch functions, Noise Squelch and Meter Squelch.

##### Noise Squelch:

- 1) Turn the SQUELCH CONTROL clockwise until the "SIG" indicator on the FREQUENCY DISPLAY goes out.
- 2) Received signal is now muted. Noise Squelch is effective in the AM or FMn (6kHz, 15kHz) modes.

##### Meter Squelch:

- 1) The S-Meter can be set by continually turning the SQUELCH CONTROL clockwise after the "SIG" indicator on the FREQUENCY DISPLAY goes out.
- 2) Any received signals weaker than the level indicated by the S-Meter on the METER will be squelched.
- 3) When a received signal is squelched in this manner, the "SIG" indicator goes out.
- 4) As long as the signal is not squelched, the "SIG" indicator will remain illuminated.

- 1) Receive frequencies can be set by using the KEYBOARD or the TUNING CONTROL.

See SECTION 5 - 3 FREQUENCY SETTING for additional operating information.

- 2) Setting the frequency at 118.1000MHz by using the KEYBOARD:

Press [1] [1] [8] [.] [1] [0] [0] [0] [ENT]

- 3) Setting a frequency by using the TUNING CONTROL:

Rotate the TUNING CONTROL until a signal is audible.

#### (6) FREQUENCY STEP SETTING

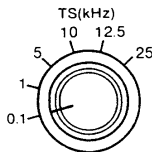

- 1) For setting step frequencies in increments of 0.1kHz, 1kHz, 5kHz, 12.5kHz, or 25kHz use the [TS] SELECTOR CONTROL.
- 2) By turning the [TS] SELECTOR CONTROL, the displayed frequency will then change in the selected frequency step.

#### 5 - 3 FREQUENCY SETTING

##### (1) USING KEYBOARD

- 1) Displayed frequency already visible will disappear when setting new frequency.
- 2) Numbers move toward the left edge.
- 3) Press [.]

Receive frequencies can be set by using the KEYBOARD or TUNING CONTROL.

- 1) When setting the desired frequency, the displayed frequency already visible will disappear.
- 2) The keyed-in figure for a new frequency will be displayed with numbers moving toward the left edge of the display from the right.
- 3) After keying in a frequency figure up to 3 digits, press the [.] key.

- 4) The numbers will then shift to the left edge.
  - 5) Press [ENT] if all "0"s to the right of the 1MHz digit follow.
  - 6) Press [1GHz] to receive in the 1GHz band.
  - 7) Press [ENT] and start again to enter if you make a mistake keying.
- 4) The numbers will then shift to the left edge of the display, filling in the three positions (1MHz, 10MHz, 100MHz) to the left of the 1MHz digit.
  - 5) All zeroes "0" to the right of the 1MHz digit can be keyed in by pressing the [ENT] key.
  - 6) To receive in the 1GHz frequency band, key in numbers for digits less than 100MHz and then press the [1GHz] BAND SWITCH.
  - 7) If you make a mistake keying in numbers, press the [ENT] key and start again from the beginning.

#### ■ FREQUENCY SETTING NOTES

- 1) When a blank status memory is called and a frequency is set, the receive mode will automatically revert to FM mode.
- 2) When a selected memory channel is in blank status, new receive frequency information will automatically be displayed in the FM mode when it is entered using the KEYBOARD.
- 3) When a selected memory channel is in blank status and a receive mode is selected via one of the MODE SWITCHES, the displayed frequency will automatically register at the lower frequency limit of 25MHz.

#### ■ KEYING EXAMPLES

(EXAMPLE 1) Setting frequency at 82.5MHz.

Press keys [8] [2] [.] [5] [ENT]

(EXAMPLE 2) Setting frequency at 145.0000MHz.

Press keys [1] [4] [5] [.] [0] [0] [0] [0] [ENT]

To enter zeroes at digits less than 1MHz (below the decimal point), the [ENT] key can be used.

Press keys [1] [4] [5] [ENT]

(EXAMPLE 3) Setting frequency at 443.1006MHz.

Press keys [4] [4] [3] [.] [1] [0] [0] [6] [ENT]

(EXAMPLE 4) Setting frequency at 443.1012MHz.

This keying operation can be done when you have already keyed in a previous number as in (EXAMPLE 3).

Press keys [.] [1] [0] [1] [2] [ENT]

(EXAMPLE 5) Setting frequency at 1250.1006MHz.

Press keys [2] [5] [0] [.] [1] [0] [0] [6] [ENT]

Press switch [1GHz]

## (2) USING TUNING CONTROL

Desired frequencies can be set by turning the TUNING CONTROL.

- 1) Turning the TUNING CONTROL clockwise increases the displayed frequency; turning the control counterclockwise decreases it.
- 2) Frequencies between 25MHz and 1000MHz can be changed using the TUNING CONTROL.

For quick control, however, the KEYBOARD is recommended.

- 3) Frequency steps can be controlled in six different increments using the TUNING STEP SELECTOR CONTROL.

## 5 - 4 MEMORY OPERATION

- The IC-R7000 is equipped with a total of 99 memories. Use any of the memory channels between 1 and 79 for storing display information. Memory channels 80 ~ 99 are used by the AUTO-WRITE MEMORY SCAN function.

- If power to the receiver is cut accidentally, information stored in the memories will not be lost since the IC-R7000 is equipped with a backup battery.

### (1) HOW TO CALL A MEMORY CHANNEL

Memory channels can be called in one of two ways: by using the KEYBOARD or the MEMORY CHANNEL SELECTOR CONTROL.

#### ■ KEYBOARD METHOD

When calling a memory channel far moved in number from the displayed memory channel, use KEYBOARD for quick access.

- 1) Press the number keys.
- 2) Press the [MEMORY CH] CONTROL.
- 3) The memory channel number lights up.

- 1) Press the number keys on the KEYBOARD which correspond to the desired memory channel number.
- 2) Press the MEMORY CHANNEL SELECTOR CONTROL to enter the figure.
- 3) The memory channel number you desire will light up on the FREQUENCY DISPLAY.

(EXAMPLE)	Calling Memory Channel 49.
Press keys	[4] [9]
Press control	[MEMORY CH]

#### ■ MEMORY CHANNEL SELECTOR CONTROL METHOD

When calling a memory channel nearer in number to the displayed memory channel, use the MEMORY CHANNEL SELECTOR CONTROL for equally fast results.

- 1) Simply turn the MEMORY CHANNEL SELECTOR CONTROL either clockwise or counterclockwise.
- 2) Turn the control clockwise for a display of memory channel numbers in ascending order, or counterclockwise for their display in descending order.

## (2) MEMORY WRITING

1) Call the memory channel.

2) Press the [MODE] SWITCH.

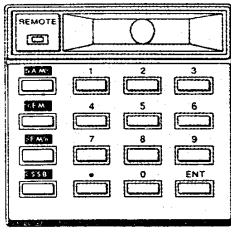

3) Set the frequency.

4) Press the [MEMORY CH-WRITE] SWITCH.

5) Write over information for updating.

Frequencies and receive modes can be simultaneously written into a memory channel by the following process:

1) Call the memory channel you wish to write information into.

See procedures in SECTION 5 - 4 (1) for calling the memory channel.

2) Press the MODE SWITCH to select the appropriate mode.

3) Use the KEYBOARD or TUNING CONTROL to set the frequency.

4) Press the MEMORY CHANNEL-WRITE SWITCH to transfer set mode and frequency information into the selected memory channel.

5) Updating memories can be easily accomplished by simply writing over information that is in storage.

(EXAMPLE) When memorizing frequency 145.1006MHz and FM mode into Memory Channel 49.

Press keys [4] [9]

Press control [MEMORY CH]

Press switch [FM]

Press keys [1] [4] [5] [.] [1] [0] [0] [6] [ENT]

Press switch [MEMORY CH-WRITE]

## ■ KEYING EXAMPLES

1) Press [5] [5] and then press [MEMORY CH].

2) Press [FM].

3) Press [1] [0] [1] [.] [1] [ENT].

4) Press [MEMORY CH-WRITE].

When writing FM mode and frequency 101.1MHz into Memory Channel 55, follow the pattern described below.

1) Using the KEYBOARD, Memory Channel 55 can be called by pressing [5] [5] and then pressing the MEMORY CHANNEL SELECTOR CONTROL one time.

2) Select FM mode by pressing the corresponding MODE SWITCH [FM].

If Memory Channel 55 is in blank status at this time, "25.0000MHz" will be displayed.

3) Set the frequency at 101.1MHz by using the KEYBOARD. Press [1] [0] [1] [.] [1] [ENT].

4) Transfer to memory by pressing the MEMORY CHANNEL-WRITE SWITCH.

## 5 - 5 SCANNING OPERATION

### ■ SIX SCAN FUNCTIONS

The IC-R7000 comes equipped with six scan functions, providing tremendous scanning versatility at the touch of just a few switches.

The various IC-R7000 scans and their operations are shown in the table below.

SCAN TYPE	OPERATION
PRIORITY SCAN	Alternately scans a separate frequency set in the PRIORITY channel while receiving a frequency displayed on the FREQUENCY DISPLAY.
PROGRAMMED SCAN	Repeatedly scans between two user-PROGRAMMED frequencies in the scan range using independent memories for storage of frequency data.
SELECTED MODE MEMORY SCAN	Repeatedly scans all memory channels containing frequencies in the same MODE as the displayed receive frequency.
SELECTED MEMORY SCAN	Scans all specified MEMORY channels while skipping unspecified channels and those in blank status.
MEMORY CHANNEL SCAN	Scans all MEMORY channels containing information while skipping memories in blank status.
AUTO-WRITE MEMORY SCAN	Automatically writes a specified frequency into the AUTO-WRITE MEMORY channels (80 ~ 99) while scanning frequencies in a programmed scan range.

#### (1) PRIORITY SCAN

- 1) Press the [PRIO-SET] SWITCH.

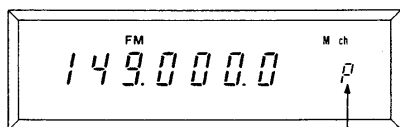
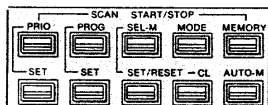

"P" will light up.

- 2) Press number keys and [ENT] key.

PRIORITY SCAN allows continuous scanning of a specified frequency while another frequency is being received and displayed, alternately switching between the two.

- 1) Press the PRIORITY SCAN SET SWITCH to set frequencies in the PRIORITY channel.

The "P" will light up on the FREQUENCY DISPLAY along with the frequency number stored in the PRIORITY memory channel.

- 2) Press the appropriate number keys and [ENT] key on the KEYBOARD to program the desired frequency into the PRIORITY channel.

Follow the same procedure as specified in SECTION 5 - 3 FREQUENCY SETTING.

**NOTE:** Frequencies cannot be entered into the PRIORITY channel via the TUNING CONTROL.

3) Press the [PRIO] SWITCH.

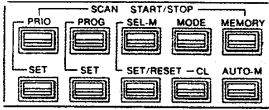

3) Press the PRIORITY SCAN START/STOP SWITCH to start the scan.

The "SCAN" indicator will light up on the FREQUENCY DISPLAY, and the PRIORITY SCAN function will begin.

PRIORITY SCAN will continue scanning even if the squelch is left open or if the memory channel being scanned is in blank status.

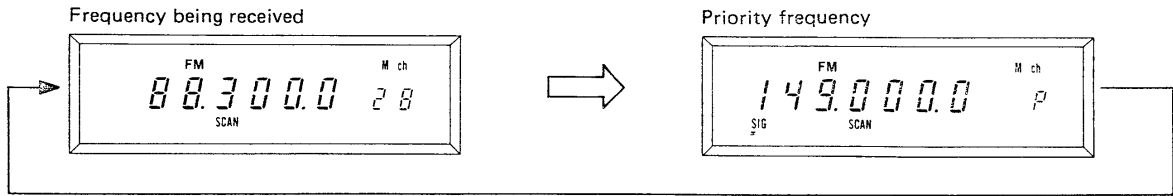

4) Scan speed can be changed by the SCAN SPEED CONTROL.

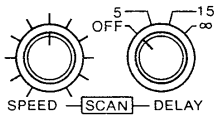

4) When the scan is operating, scanning speed can be changed by setting the SCAN SPEED CONTROL.

See SECTION 5 - 6 (3) SCAN SPEED for further details.

5) The scan will stop when a signal is received.

5) When a signal is received in the PRIORITY channel, the scan will stop once for the time period specified by the SCAN DELAY CONTROL and will then start again or be cancelled.

See SECTION 5 - 6 (2) DELAY TIME for further details.

6) Press the [PRIO] SWITCH or turn the TUNING CONTROL to cancel the scan.

6) Press the PRIORITY SCAN START/STOP SWITCH again or turn the TUNING CONTROL to cancel the scan.

7) Press the [PRIO-SET] SWITCH to check the PRIORITY frequency.

7) Press the PRIORITY SCAN SET SWITCH to check a frequency written into the PRIORITY channel.

(EXAMPLE)	Setting frequency 147.0000MHz in the PRIORITY channel and starting PRIORITY SCAN.
Press switch	[PRIO-SET]
Press keys	[1] [4] [7] [ENT]
Press switch to start scan	[PRIO]

## (2) PROGRAMMED SCAN

PROGRAMMED SCAN repeatedly scans frequencies set in a programmed scan range. These frequencies are stored in special memories in the IC-R7000 for instant accessibility.

1) Press the [PROG-SET] SWITCH.

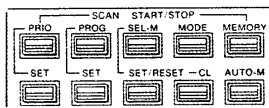

1) Press the PROGRAMMED SCAN SET SWITCH to set the lower frequency limit (LO).

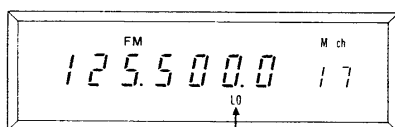

"LO" lights up.

The "LO" indicator will light up on the FREQUENCY DISPLAY.

- 2) Press number keys and [ENT] key to set the lower frequency limit.

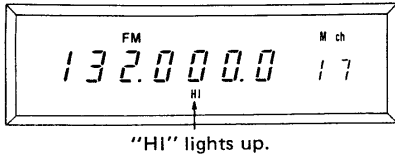

- 3) Press number keys and [ENT] key to set the upper frequency limit.
- 4) Press the [PROG] SWITCH to start the scan.

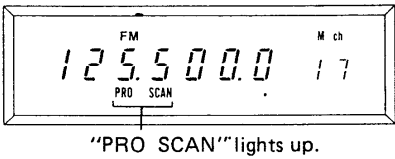
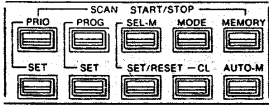

- 5) Turn the [TS] SELECTOR CONTROL.
- 6) Scan speed can be changed by the [SCAN SPEED] CONTROL.
- 7) Turn the [SCAN DELAY] CONTROL.
- 8) Press the [PROG] SWITCH or turn the TUNING CONTROL.

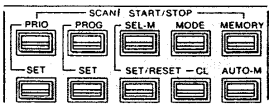

**PROGRAMMED SCAN NOTES**

- 2) Press the appropriate number keys on the KEYBOARD and press the [ENT] key to program the desired lower frequency limit.

The FREQUENCY DISPLAY will automatically shift to the "HI" indicator once the lower frequency number is entered.

See SECTION 5 - 3 FREQUENCY SETTING for more operation information.

- 3) Press the appropriate number keys on the KEYBOARD and press the [ENT] key to program the desired upper frequency limit.
- 4) Press the PROGRAMMED SCAN START/STOP SWITCH to begin scanning.

The "PRO SCAN" indicator will light up on the FREQUENCY DISPLAY.

- 5) Turn the TUNING STEP SELECTOR CONTROL to choose a frequency step you wish the scan to operate in.

See SECTION 3 - 1 for a description of the TUNING STEP SELECTOR CONTROL.

- 6) When the scan is operating, scanning speed can be changed by setting the SCAN SPEED CONTROL.

- 7) Turn the SCAN DELAY CONTROL to choose an appropriate delay time for stopping incoming signals.

The scan will stop at a receive frequency for the time specified by the SCAN DELAY CONTROL.

See page 28 for further details.

- 8) Press the PROG START/STOP SWITCH or turn the TUNING CONTROL to cancel the scan.

- If the scan is cancelled via the START/STOP SWITCH, it will start again at the point in the scan range where it last stopped.
- If the scan is cancelled via the TUNING CONTROL, it will start again at the lower frequency limit in the scan range.
- The TUNING CONTROL cannot be used to set a frequency in the scan range.
- It is not necessary to use the MEMORY CH-WRITE SWITCH while operating in PROGRAMMED SCAN as frequencies written into the scan range are automatically stored in special memories.



- Each time the [PROG-SET] SWITCH is consecutively pressed, the following will successively appear on the FREQUENCY DISPLAY: lower frequency limit, upper frequency limit, and blank status.
- Receive modes can be freely changed while operating in PROGRAMMED SCAN.
- When the [TS] SELECTOR CONTROL is changed during scanning operations, scanning will automatically resume at the lower frequency limit in the newly specified frequency step.
- If the KEYBOARD or [MEMORY CH] SELECTOR CONTROL are used while scanning is occurring, scanning will automatically restart from the lower specified frequency in the scan range.

(EXAMPLE) Setting lower frequency limit at 118.1000MHz, upper frequency limit at 149.0000MHz, and starting PROGRAMMED SCAN.

Press switch [PROG-SET]

Press keys [1] [1] [8] [.] [1] [ENT]

Press keys [1] [4] [9] [ENT]

Press switch to start scan [PROG]

### (3) SELECTED MEMORY SCAN

1) Press number keys and the [MEMORY CH] CONTROL or turn the [MEMORY CH] CONTROL.

2) Press number keys and [ENT] key.

3) Press the [SEL-M-SET] SWITCH.

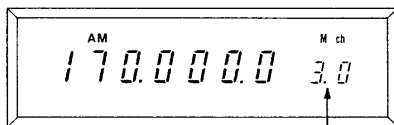
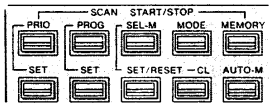

A small dot [.] will light up.

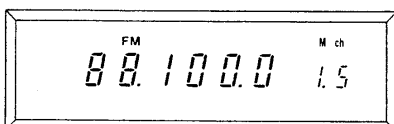

SELECTED MEMORY SCAN repeatedly scans specific memory channels chosen by the user.

1) Press the number keys on the KEYBOARD and press the [MEMORY CH] SELECTOR CONTROL to choose a memory channel for scanning or turn the [MEMORY CH] SELECTOR CONTROL.

2) Press the appropriate number keys and [ENT] key on the KEYBOARD to program the desired frequency into a memory channel.

See SECTION 5 - 3 FREQUENCY SETTING for more information regarding entering a frequency.

3) Press the [SEL-M-SET] SWITCH to enter a frequency into the memory channel. A small dot will light up in the memory channel indicator on the FREQUENCY DISPLAY, marking the selected channel.

**NOTE:** At least 2 channels must be set in order for SELECTED MEMORY SCAN to operate.

Follow the same procedures above to enter a second frequency into a memory channel.

See SECTION 5 - 3 FREQUENCY SETTING for more information regarding entering a frequency.

4) Press the [SEL-M] SCAN SWITCH.

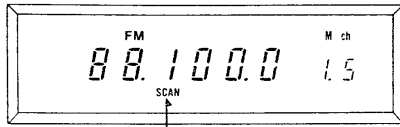
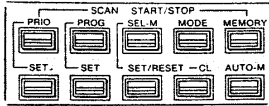

"SCAN" lights up.

4) Press the [SEL-M] SCAN START/STOP SWITCH to activate SELECTED MEMORY SCAN. When the scan is operating, "SCAN" lights up on the FREQUENCY DISPLAY.



5) Scan speed can be changed by the SCAN SPEED CONTROL.

5) When the scan is operating, scanning speed can be changed by setting the SCAN SPEED CONTROL.

6) Turn the [SCAN DELAY] CONTROL.

6) Turn the SCAN DELAY CONTROL to set the desired delay time for received signals.

See page 28 for more information regarding use of the SCAN DELAY CONTROL.

7) Press the [SEL-M] SCAN SWITCH or turn the TUNING CONTROL.

7) Press the [SEL-M] SCAN START/STOP SWITCH or turn the TUNING CONTROL to cancel the scan.

8) Set the memory channel for clearing.

8) Select the memory channel to be cleared using the [MEMORY CH] SELECTOR CONTROL or KEYBOARD.

9) Press the [SET-M-SET/RESET] SWITCH or the [SEL-M-CL] SWITCH.

9) Press the [SET-M-SET/RESET] SWITCH to clear the desired memory channel or press the [SEL-M-CL] SWITCH to clear ALL selected memory channels.

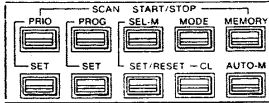

**NOTE:** SELECTED MEMORY SCAN is not available in channels set for PRIORITY SCAN and in a programmed scan range.

(EXAMPLE)

1) Setting memory channel 30:  
Setting frequency 170.0000MHz in memory channel 30.

1) Press keys [3] [0] [MEMORY CH] or  
Turn [MEMORY CH] CONTROL to [30]

Press keys [1] [7] [0] [ENT]

Press switch [SEL-M-SET]

2) Setting memory channel 52.  
Setting frequency 121.3300MHz in memory channel 52.

2) Press keys [5] [2] [MEMORY CH] or  
Turn [MEMORY CH] CONTROL to [52]

Press keys [1] [2] [1] [.] [3] [3] [ENT]

Press switch [SEL-M-SET]

3) Starting SELECTED MEMORY SCAN.

3) Press switch to start scan  
[SEL-M]

#### (4) SELECTED MODE MEMORY SCAN

- 1) Press the number keys and press [MEMORY CH] CONTROL or turn [MEMORY CH] CONTROL.

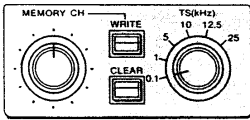

- 2) Press the number keys or turn the TUNING CONTROL.
- 3) Press a receive MODE SWITCH.

Specified receive mode

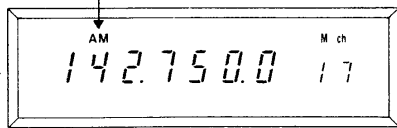

- 4) Press the [MEMORY CH-WRITE] SWITCH.

SELECTED MODE MEMORY SCAN repeatedly scans specified receive modes of frequencies stored in the memory channels.

- 1) Press the number keys on the KEYBOARD and press the [MEMORY CH] SELECTOR CONTROL or turn the [MEMORY CH] SELECTOR CONTROL to choose a memory channel.

See SECTION 5 - 4 for further details on selecting a memory channel.

- 2) Press the number keys or turn the TUNING CONTROL to set a frequency for storage.
- 3) Press one of the four receive MODE SWITCHES to select a receive mode.

- 4) Press the [MEMORY CH-WRITE] SWITCH to enter the desired frequency and mode information into the selected memory channel.

See page 5 for more information regarding use of the [MEMORY CH-WRITE] SWITCH.

**NOTE:** At least two memory channels must be set in order for SELECTED MODE MEMORY SCAN to operate.

Follow the same procedures above to enter a second frequency with the same receive mode into a memory channel.

- 5) Press the [MODE] SWITCH.

- 5) Press the MODE SCAN START/STOP SWITCH to activate the scan.

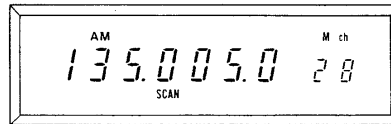
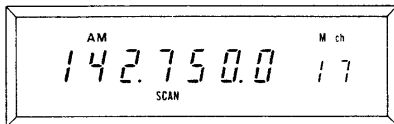

- 6) Scan speed can be changed by the [SCAN SPEED] CONTROL.

- 6) When the scan is operating, scanning speed can be changed by turning the SCAN SPEED CONTROL.

- 7) Turn the [SCAN DELAY] CONTROL.

- 7) Turn the SCAN DELAY CONTROL to the appropriate setting to stop and delay the received signal.

See page 28 regarding use of the SCAN DELAY CONTROL.

- 8) Press the [MODE] SWITCH or turn the TUNING CONTROL.

- 8) Press the MODE SCAN START/STOP SWITCH again, or turn the TUNING CONTROL to cancel the scan.

#### ■ SELECTED MODE MEMORY SCAN NOTES

- The scan should not be started in a blank status memory, as it will then scan only memories in blank status.
- Scanning will be cancelled if the newly selected mode is not contained in the memory channels.

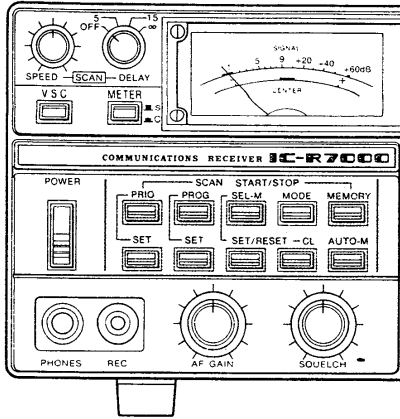

- (EXAMPLE)
- 1) Setting memory channel 17.  
Setting frequency 118.1000MHz.  
Setting AM mode for scanning.
  - 2) Setting memory channel 28.  
Setting frequency 147.0800MHz in memory channel 28.  
Setting AM mode for scanning.
  - 3) Starting SELECTED MODE SCAN.
- 1) Press keys [1] [7] [MEMORY CH] or  
Turn [MEMORY CH] CONTROL to [17]  
Press keys [1] [1] [8] [.] [1] [ENT]  
Press switch [AM]  
Press switch [MEMORY CH-WRITE]
  - 2) Press keys [2] [8] [MEMORY CH] or  
Turn [MEMORY CH] CONTROL to [28]  
Press keys [1] [4] [7] [.] [0] [8] [ENT]  
Press switch [AM]  
Press switch [MEMORY CH-WRITE]
  - 3) Press switch to start scan [MODE]

### (5) MEMORY CHANNEL SCAN

- 1) Press the number keys and [MEMORY CH] CONTROL or turn the [MEMORY CH] CONTROL.
- 2) Press the number keys and [ENT] key or turn the TUNING CONTROL.
- 3) Press a receive MODE SWITCH.

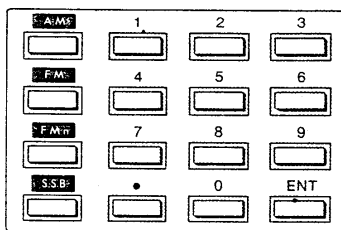

MEMORY CHANNEL SCAN repeatedly scans all memories except those in blank status.

- 1) Press the number keys on the KEYBOARD and press the MEMORY CHANNEL SELECTOR CONTROL or turn the MEMORY CHANNEL SELECTOR CONTROL to choose a memory channel for storage.  
  
See SECTION 5 - 4 for further details on selecting a memory channel.
- 2) Press the number keys and [ENT] key or turn the TUNING CONTROL to select the desired frequency.  
  
See SECTION 5 - 3 FREQUENCY SETTING for more information.
- 3) Press one of the four receive MODE SWITCHES to select the appropriate receive mode.

**NOTE:** The scan will not operate unless at least 2 selected frequencies have been stored in memory channels. Additionally, the scan is not designed to operate in channels set for PRIORITY SCAN or channels set in a programmed scan range.

4) Press the [MEMORY] SCAN SWITCH.

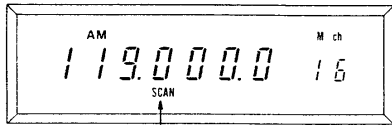
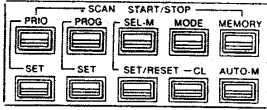

"SCAN" lights up.

5) Scan speed can be changed by turning the [SCAN-SPEED] CONTROL.

6) Turn the [SCAN DELAY] CONTROL.

7) Press the [MEMORY] SWITCH or turn the TUNING CONTROL.

4) Press the MEMORY SCAN START/STOP SWITCH to activate the scan.

The "SCAN" indicator will light up on the FREQUENCY DISPLAY.

5) When the scan is operating, scanning speed can be changed by setting the SCAN SPEED CONTROL.

6) Turn the SCAN DELAY CONTROL to the desired setting to delay the incoming signal.

See page 28 for more information regarding use of the SCAN DELAY CONTROL.

7) Press the MEMORY SCAN START/STOP SWITCH or turn the TUNING CONTROL to cancel the scan.

- While the scan is operating, all memory channels except those in blank status will be scanned.

(EXAMPLE) Choose memory channels and enter frequencies as in SELECTED MEMORY SCAN (pages 22 ~ 23).

After entering frequencies and receive modes into memory channels:

Press switch to start scan  
[MEMORY]

### (6) AUTO-WRITE MEMORY SCAN

1) Press the [PROG-SET] SWITCH.

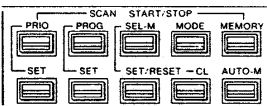

2) Press number keys and [ENT] key to set the lower frequency limit.

- Lower frequency limit

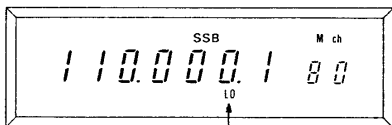

"LO" lights up.

AUTO-WRITE MEMORY SCAN repeatedly scans frequencies set in the PROGRAMMED scan range. Each time a signal is received its frequency is automatically written into memory channels 80 through 99.

1) Press the PROGRAMMED SCAN SET SWITCH to set the lower frequency limit in the programmed scan range (LO).

The "LO" indicator will light up on the FREQUENCY DISPLAY.

See SECTION 5 - 4 for programming frequencies into memory channels.

2) Press appropriate number keys and [ENT] key on the KEYBOARD to program the desired lower frequency limit.

The FREQUENCY DISPLAY will automatically shift to the "HI" indicator once the lower frequency number is entered.

Follow the same procedure as specified in SECTION 5 - 3 FREQUENCY SETTING.

- 3) Press number keys and [ENT] key to set the upper frequency limit.

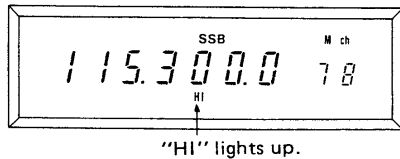

- 4) Press MODE SWITCH.
- 5) Press the [AUTO-M] SCAN SWITCH.

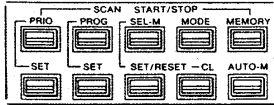

- 6) Turn the [TS] SELECTOR CONTROL.
- 7) Scan speed can be changed by the [SCAN-SPEED] CONTROL.
- 8) Turn the [SCAN-DELAY] CONTROL.
- 9) Press the [AUTO-M] SWITCH or turn the TUNING CONTROL.

### ■ AUTO-WRITE MEMORY NOTES

- 3) Press the appropriate number keys on the KEYBOARD and press the [ENT] key to program the desired upper frequency limit (HI).

- 4) Press one of the four receive MODE SWITCHES to select the appropriate receive mode.
- 5) Press the AUTO-WRITE MEMORY SCAN START/STOP SWITCH to activate the scan.
- 6) Turn the TUNING STEP SELECTOR CONTROL to choose an appropriate step frequency interval to operate in while scanning.
- 7) When the scan is operating, scanning speed can be changed by setting the SCAN SPEED CONTROL.
- 8) Turn the SCAN DELAY CONTROL to the desired setting to stop and delay an incoming signal.
- 9) Press the AUTO-WRITE MEMORY SCAN START/STOP SWITCH or turn the TUNING CONTROL to cancel the scan.

- If the AUTO-WRITE MEMORY SCAN START/STOP SWITCH [AUTO-M] is pressed again, scanning will begin from the last frequency scanned prior to stopping.
- If the TUNING CONTROL is used to cancel scanning operations, the scan will then resume at the lowest frequency in the scan range.
- Additionally, when the scan is reactivated, information contained in memory channels 80 through 99 will have been deleted.
- If all the AUTO-WRITE MEMORY channels are filled, scanning will automatically stop.

(EXAMPLE)	Setting lower frequency limit 118.0000MHz, upper frequency limit 149.0000MHz in FM, and starting AUTO-WRITE MEMORY SCAN.
Press switch	[PROG-SET]
Press keys	[1] [1] [8] [ENT]
Press keys	[1] [4] [9] [ENT]
Press mode switch	[FM]
Press switch to start scan	[AUTO-M]

## 5 - 6 AUTO STOP FUNCTION

### (1) VOICE CONTROL SCAN FUNCTION [VSC]

During operation of the various scan functions, scanning will stop automatically when the incoming signal is received and SQUELCH CONTROL is turned clockwise to a position where the hissing sound coming from the speaker stops.

If operating using the VSC, automatic stopping will occur only when voice signals are received.

**NOTE:** Automatic stopping may not occur if the signal is weak even if the signal contains a voice signal.

### (2) DELAY TIME

Receive signals can be stopped for controlled time periods by using the SCAN DELAY CONTROL. The control has 4 settings; OFF, 5 (seconds), 15 (seconds), and infinity ( $\infty$ ). These are described below.

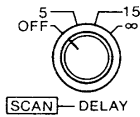

\* The AUTO STOP SCAN FUNCTION stops when a signal received and resumes scanning when the signal is no longer received.

SETTING	FUNCTION
*OFF	*Scan stops when signal is received.
5 (seconds)	The AUTO STOP SCAN function stops for approximately 5 seconds and then restarts when an incoming signal is received with the SQUELCH CONTROL open.
15 (seconds)	The AUTO STOP SCAN function stops for approximately 15 seconds and then restarts when an incoming signal is received with the SQUELCH CONTROL open.
$\infty$ (Infinity)	The AUTO STOP SCAN function stops and cancels the AUTO STOP SCAN function when an incoming signal is received.

### (3) SCAN SPEED

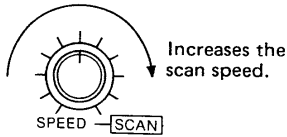

The scan speed can be regulated as desired by using the SCAN SPEED CONTROL. Turn the control clockwise to increase the scan speed and counterclockwise to decrease it.

**NOTE:** The scan speed in PRIORITY SCAN is fixed at approximately 0.4 seconds, and the receive time of the operating frequency is variable.

## 5 - 7 M-SET SWITCH

1) Press and hold the [M-SET] SWITCH.

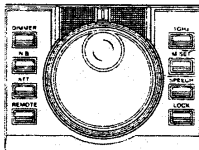

2) Choose a new memory channel.

3) Release the [M-SET] SWITCH.

4) Press the [MEMORY CH-WRITE] SWITCH.

Frequency and receive mode information currently displayed can be temporarily transferred to a new memory channel by pressing the [M-SET] SWITCH. Follow the procedure described below.

1) While the frequency and receive mode are displayed, press the MEMORY SET SWITCH [M-SET], holding it in continuously.

2) Choose a new memory channel using the KEYBOARD or [MEMORY CH] SELECTOR CONTROL.

3) Release the MEMORY SET SWITCH, transferring the display information into the new memory channel.

4) Press the MEMORY CHANNEL WRITE SWITCH and the information will be written into memory.

## SECTION 6 PRECAUTIONS AND MAINTENANCE

### 6-1 OPERATING WARNING

Laws in each country specifically forbid the tapping of any wireless communication made by another party, including the leaking of its existence or contents and the theft of such contents.

### 6-2 MAINTENANCE

#### (1) CLEANING

If the receiver becomes dusty or dirty, wipe it clean with a dry, soft cloth. Do not use organic solvents such as thinners, as these may make the paint peel on the receiver body.

#### (2) FUSE REPLACEMENT

If the fuse blows or the receiver stops functioning, track down the source of the problem if possible, and replace the damaged fuse with a new, rated fuse.

Rear panel fuse:

- U.S.A. version . . . . . 1A
- Australia, Europe, France version . . . . . 0.5A

\*DC line fuse:

- All versions . . . . . 2A

\*The DC line fuse is located on the AC POWER SUPPLY unit in the IC-R7000 transceiver.

#### ●POWER SUPPLY UNIT

\* The DC power plug shown on the rear panel of the pictured IC-R7000 is not equipped with your unit.

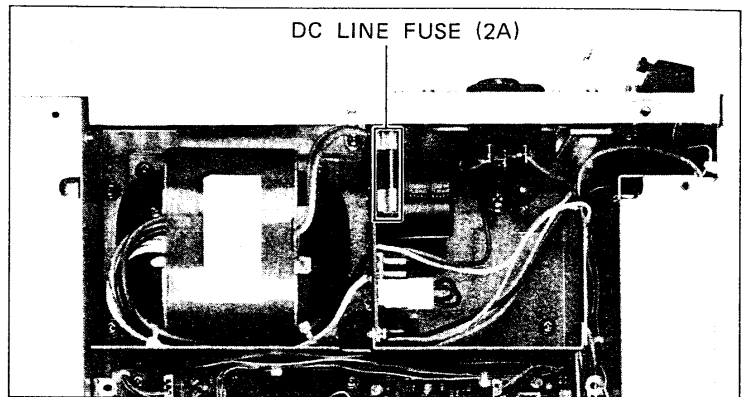

#### (3) BACKUP BATTERY

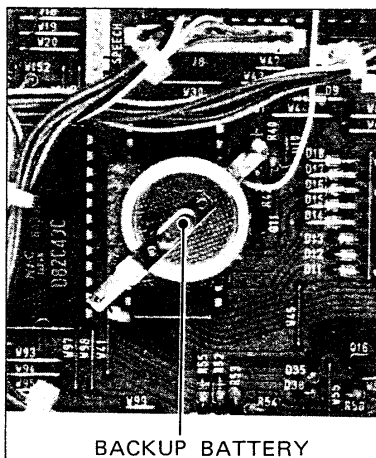

In the IC-R7000 an externally-installed RAM (Random Access Memory) is used, and the data stored in this RAM is backed by a lithium battery.

- The service life of a lithium battery is approximately 5 years.
- After a battery wears out, data disappear in all the memory channels and the memory channels revert to blank status.
- If there is any sign of lithium battery wear in the IC-R7000, contact the retail store where your purchase was made or contact your nearest ICOM Service Center.



### 6-3 AC POWER SUPPLY MODIFICATIONS

The receiver has a built-in AC power supply. Connect the supplied AC power cable to the AC power socket on the rear panel of the unit, and the opposite end of the power cable into any convenient AC power outlet.

When you wish to use the receiver with an alternative AC power supply voltage, you must make internal wiring modifications as per the following instructions.

**NOTE:** If you are not familiar with making modifications or do not understand the diagrams well, DO NOT attempt to make modifications. Instead, contact your authorized ICOM dealer or ICOM Service Center.

- 1) Turn the POWER SWITCH OFF on the front panel and remove the AC power cable.
- 2) Remove the top cover.
- 3) Change the connector connections on the POWER SUPPLY UNIT as shown in the diagrams.
- 4) Put the top cover back in place.

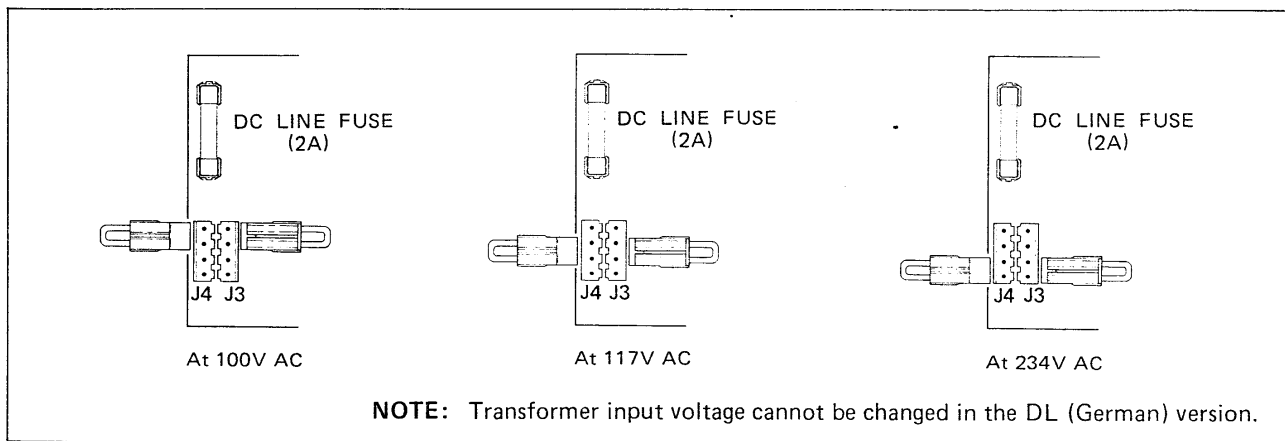

## SECTION 7 TROUBLESHOOTING

Your IC-R7000 has been carefully adjusted at the factory prior to shipping. The chart below is provided to help you correct problems that are not equipment malfunctions.

If you are unable to locate the trouble or correct the fault, please contact your dealer or the nearest ICOM Service Center.

PROBLEM	POSSIBLE CAUSE	SOLUTION
1. Power does not come on when the POWER SWITCH is pressed.	<ul style="list-style-type: none"> <li>• Power cable is improperly connected.</li> <li>• Power supply connection is impaired.</li> <li>• Power supply is not connected.</li> <li>• Blown fuse.</li> </ul>	<ul style="list-style-type: none"> <li>• Carefully reconnect power cable.</li> <li>• Inspect connection pins.</li> <li>• Reconnect.</li> <li>• Check for the cause, then replace the fuse with a spare one.</li> </ul>
2. No sound comes from the speaker.	<ul style="list-style-type: none"> <li>• AF GAIN CONTROL is turned completely counterclockwise.</li> <li>• SQUELCH CONTROL is operating.</li> <li>• Connection cable to the external speaker is broken.</li> <li>• Headphones are connected to the PHONES JACK.</li> </ul>	<ul style="list-style-type: none"> <li>• Rotate the control clockwise to a suitable level.</li> <li>• Turn the SQUELCH CONTROL completely counterclockwise.</li> <li>• Inspect and repair connection.</li> <li>• Unplug the headphones.</li> </ul>
3. Sensitivity is low and only strong signals are audible.	<ul style="list-style-type: none"> <li>• Attenuator is operating.</li> <li>• Antenna is defective or the coaxial cable has an electrical short or broken wire.</li> <li>• Receive frequency and the receivable frequency range of the antenna are not compatible.</li> </ul>	<ul style="list-style-type: none"> <li>• Turn the [ATT] SWITCH off.</li> <li>• Inspect and repair antenna and coaxial cable.</li> <li>• Change antennas.</li> </ul>
4. Only unintelligible voices can be heard during SSB reception.	<ul style="list-style-type: none"> <li>• Receiving the wrong sideband.</li> </ul>	<ul style="list-style-type: none"> <li>• Select the opposite sideband (USB or LSB).</li> </ul>
5. Voice distortion on FM stations and TV broadcasts.	<ul style="list-style-type: none"> <li>• Mode displayed is not "FM".</li> <li>• Selector switch for FM (2) - FM (1) on rear panel is in FM (1) position.</li> </ul>	<ul style="list-style-type: none"> <li>• Press the [FM] MODE SWITCH.</li> <li>• Set at FM (2).</li> </ul>
6. Frequency does not change by rotating the TUNING CONTROL.	<ul style="list-style-type: none"> <li>• LOCK SWITCH is engaged.</li> </ul>	<ul style="list-style-type: none"> <li>• Disengage lock by pressing LOCK SWITCH.</li> </ul>
7. Memory channel does not change when [MEMORY CH] CONTROL is turned.	<ul style="list-style-type: none"> <li>• LOCK SWITCH is engaged.</li> </ul>	<ul style="list-style-type: none"> <li>• Disengage lock by pressing LOCK SWITCH.</li> </ul>
8. Scanning does not operate when a SCAN START/STOP SWITCH is pressed.	<ul style="list-style-type: none"> <li>• Proper scan setting has not been programmed.</li> </ul>	<ul style="list-style-type: none"> <li>• See SECTION 5 - 5 for instructions.</li> </ul>
9. No voice output occurs when [SPEECH] SWITCH is pressed.	<ul style="list-style-type: none"> <li>• Voice synthesizer unit is not incorporated in the receiver.</li> </ul>	<ul style="list-style-type: none"> <li>• Install optional IC-EX310 Voice Synthesizer unit.</li> </ul>

## SECTION 8 INSIDE VIEWS

### 8 - 1 POWER SUPPLY/DC-DC CONVERTER UNIT

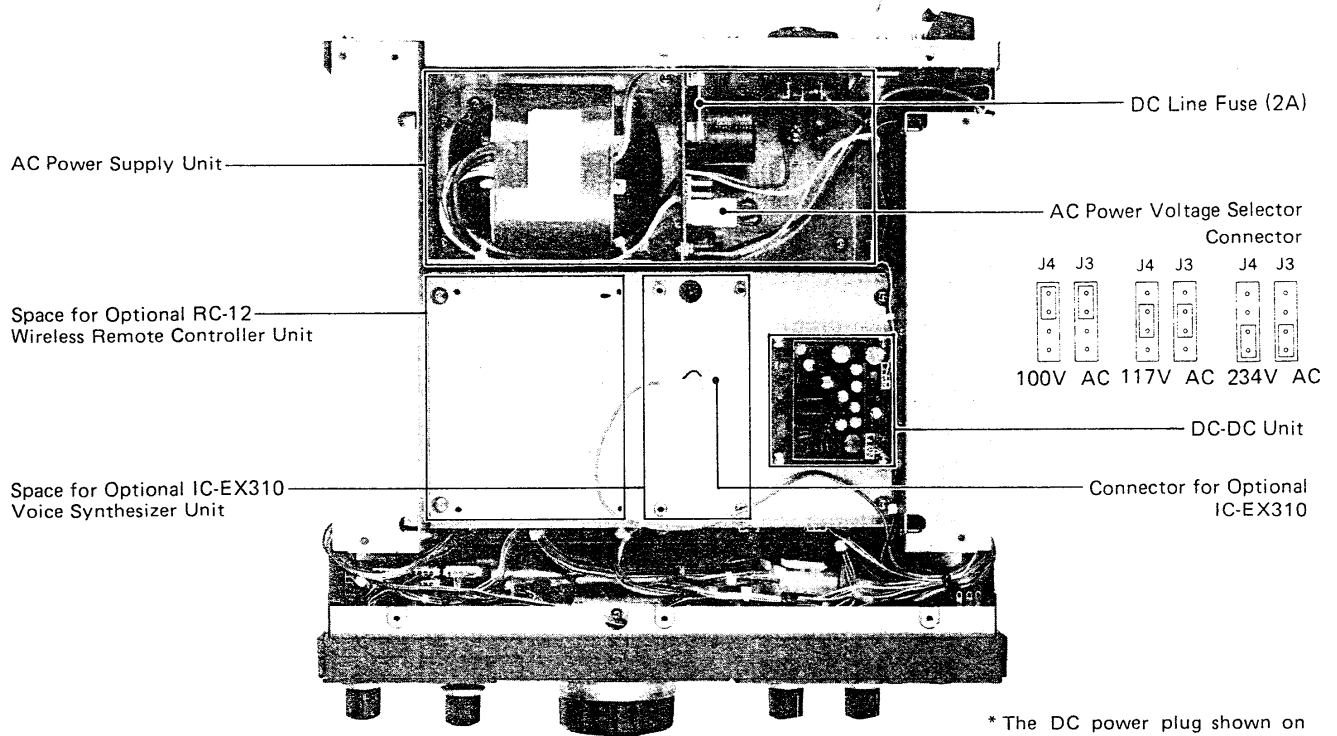

### 8 - 2 LOGIC UNIT

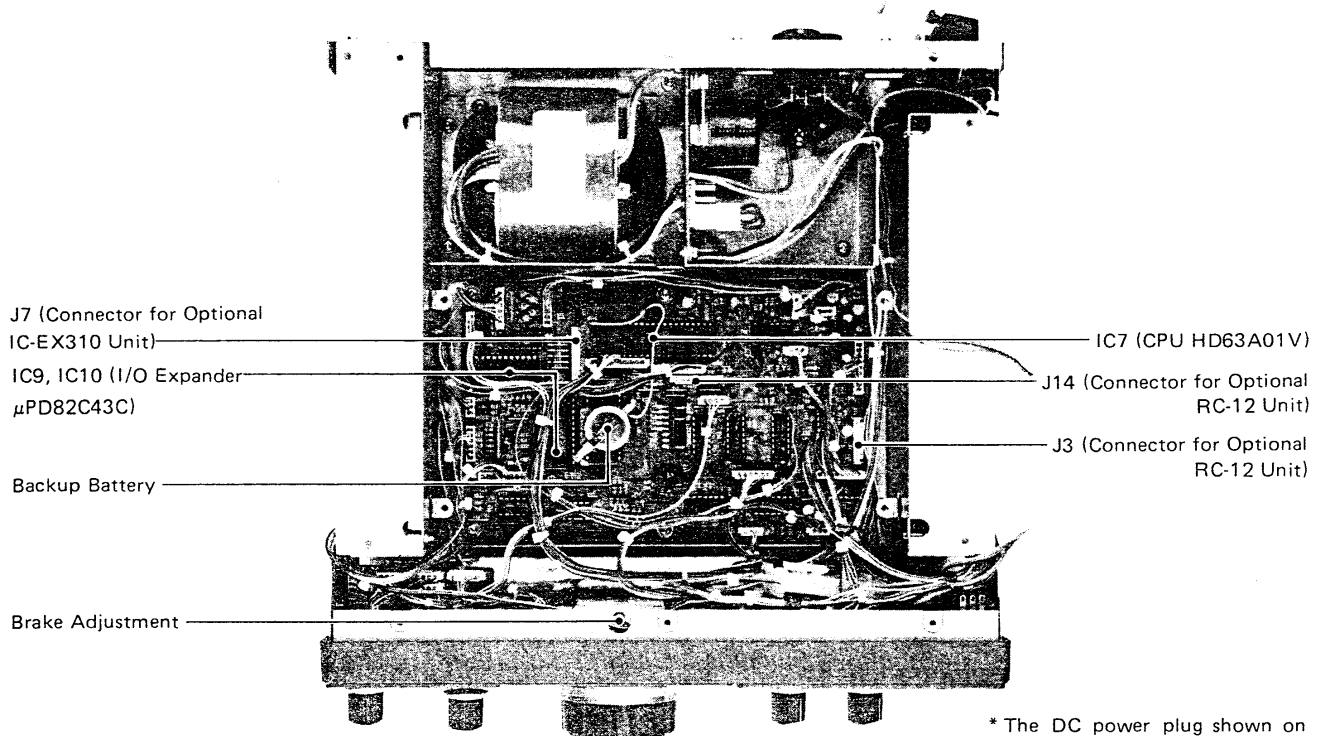

### 8-3 RF/IF UNITS

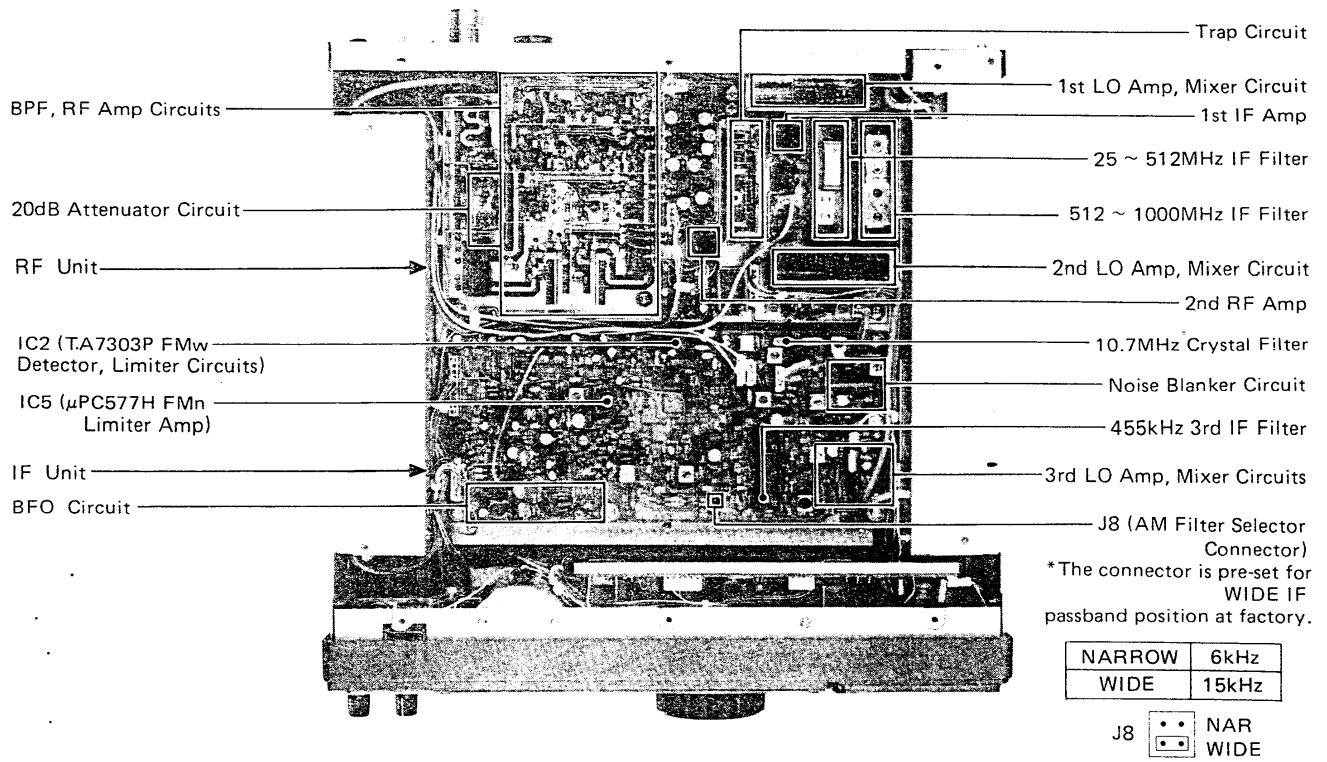

### 8-4 MAIN UNIT

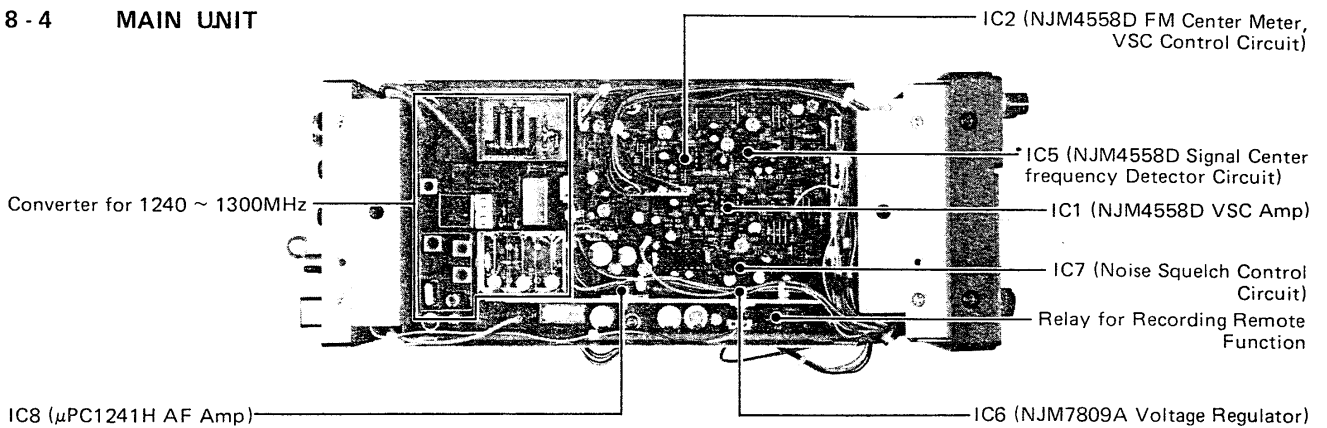

### 8-5 PLL UNIT

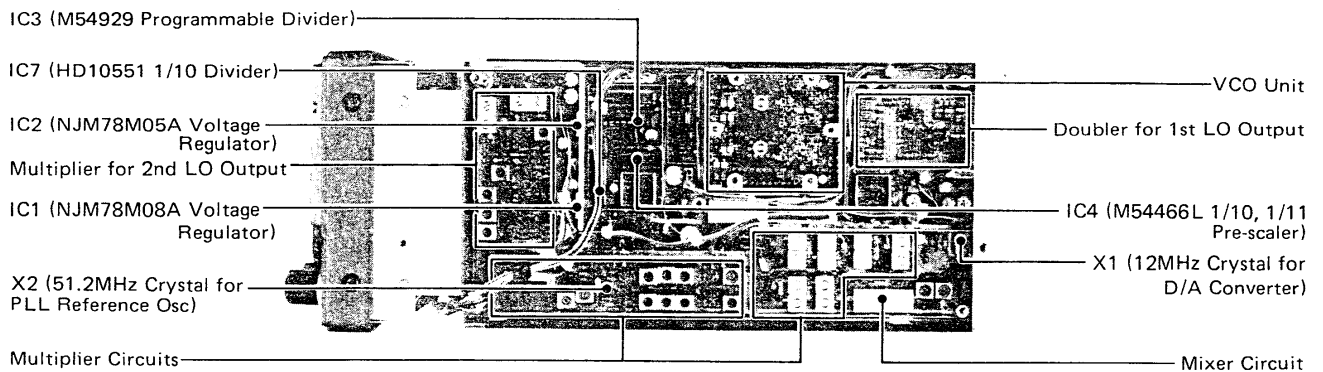

**WARNING:** Unplug the AC power cable before performing any work on the receiver.

## 9 - 1 RC-12 WIRELESS REMOTE CONTROLLER

### ●INSTALLATION

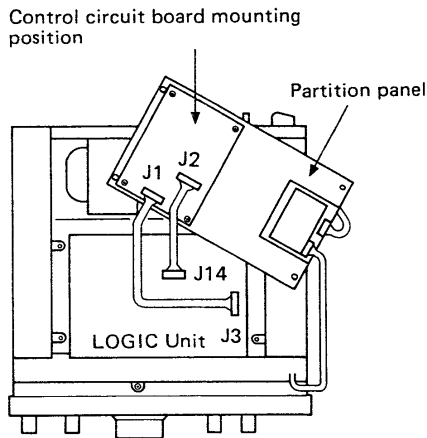

The RC-12 is a multi-function wireless remote controller for the IC-R7000 COMMUNICATIONS RECEIVER, and provides a Control Circuit Board and Remote Controller in a single unit.

- 1) Remove the top and bottom covers and turn the IC-R7000 over to remove the inside partition panel.
- 2) Mount the CONTROL CIRCUIT BOARD onto the inside partition panel.
- 3) Plug the 7-pin connector (J1) on the CONTROL CIRCUIT BOARD into connection point J3 on the LOGIC unit and plug the 8-pin connector (J2) into connection point J14 on the LOGIC unit.
- 4) Put the inside partition panel and the top and bottom covers back in place.

Now the installation procedure is complete.

## 9 - 2 IC-EX310 VOICE SYNTHESIZER UNIT

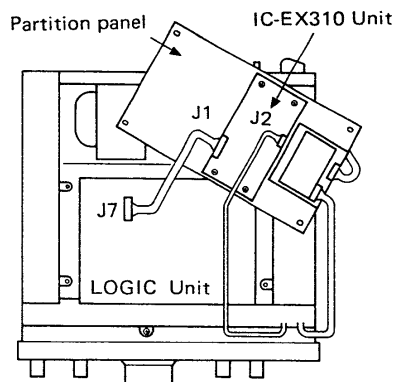

The IC-EX310 VOICE SYNTHESIZER unit reads the displayed frequency aloud when the [SPEECH] SWITCH on the front panel is pressed.

- 1) Remove the top and bottom covers and turn the IC-R7000 over to remove the inside partition panel.
- 2) Mount the IC-EX310 unit on the inside partition panel.
- 3) Plug the 8-pin connector (J1) on the IC-EX310 unit into connection point J7 on the LOGIC unit and plug the 2-pin connector from the MAIN unit into connection point J2 on the IC-EX310 unit.
- 4) Replace the inside partition panel.
- 5) Adjust the speech volume and speech speed, if necessary, before the top and bottom covers are replaced.

See following instructions for adjustment.

- 6) Put the top and bottom covers back in place.

### ●ADJUSTMENT

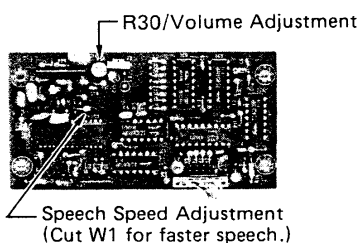

- 1) The volume of the voice-synthesized reading is adjustable by using the AF GAIN CONTROL on the front panel or by turning R30 on the unit with a small screwdriver.
- 2) The W1 jumper wire controls the speech speed. Cut J1 to increase the speech speed.

# SECTION 10 BLOCK DIAGRAM

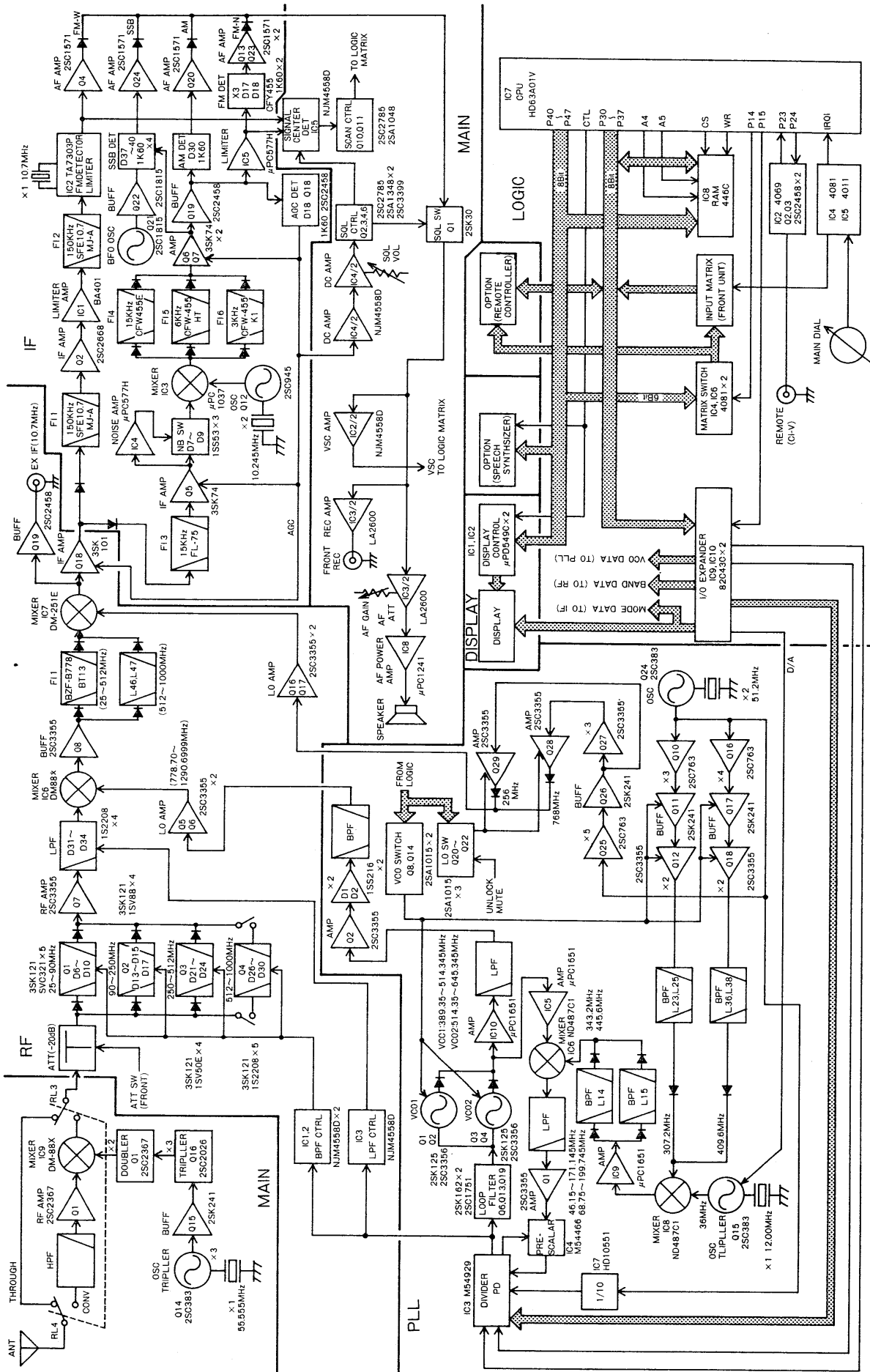

To upgrade quality, some components may be subject to change without notice.

## SECTION 11 OPTIONS

RC-12  
WIRELESS REMOTE CONTROLLER

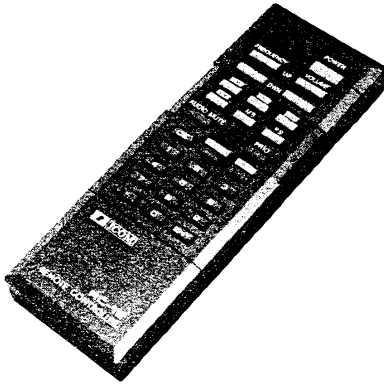

IC-EX310  
VOICE SYNTHESIZER UNIT

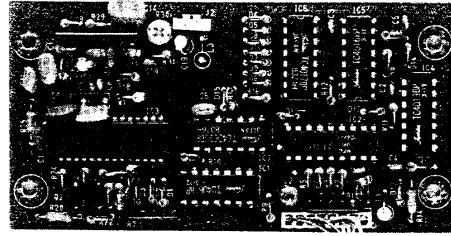

AH-7000  
SUPER WIDEBAND  
OMNIDIRECTIONAL ANTENNA

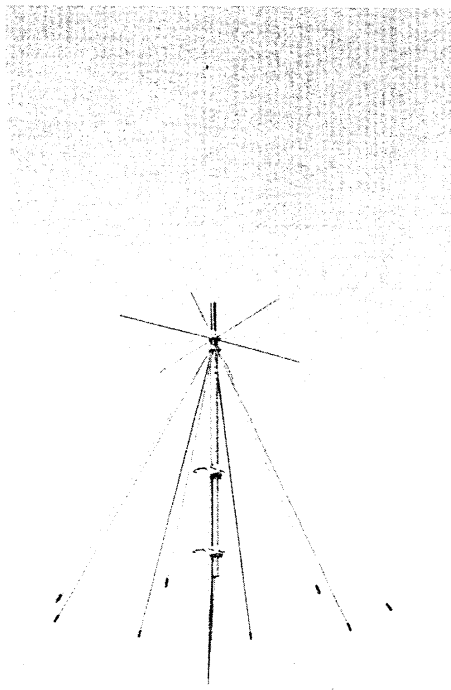

• SPECIFICATIONS

Frequency coverage : Receive 25 to 1300MHz  
 Transmit 50, 144, 430,  
 900, 1200MHz  
 bands

Type of antenna : Discone

Weight : 1kg

EXTERNAL SPEAKERS

\*IC-SP3

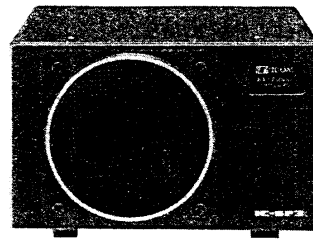

SP-7

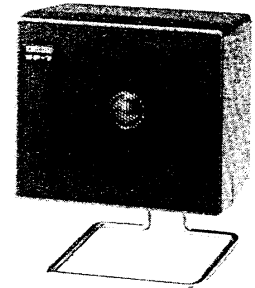

\* Matching style and size  
 with the IC-R7000.

HP-2  
COMMUNICATION  
HEADPHONES



CT-17  
CI-V LEVEL CONVERTER

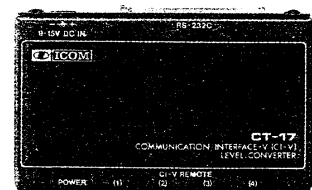

**Count on us!**

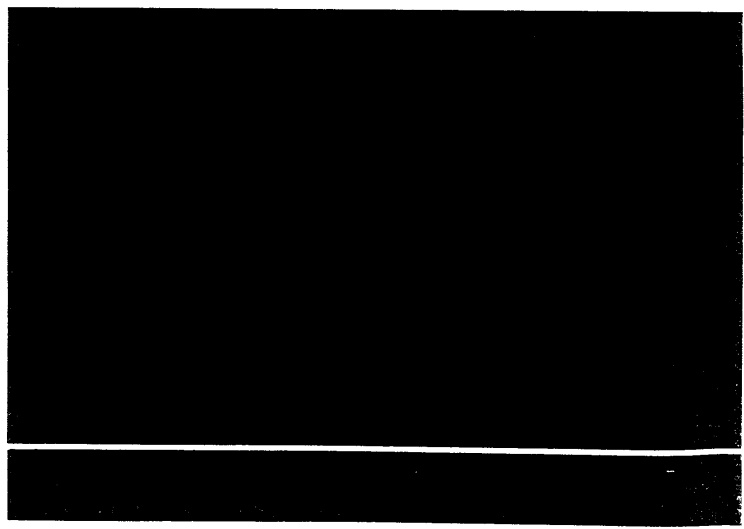

---

---

---

---

---

---

---

---

---

---