

IC-R70 SCHEMATIC DIAGRAM

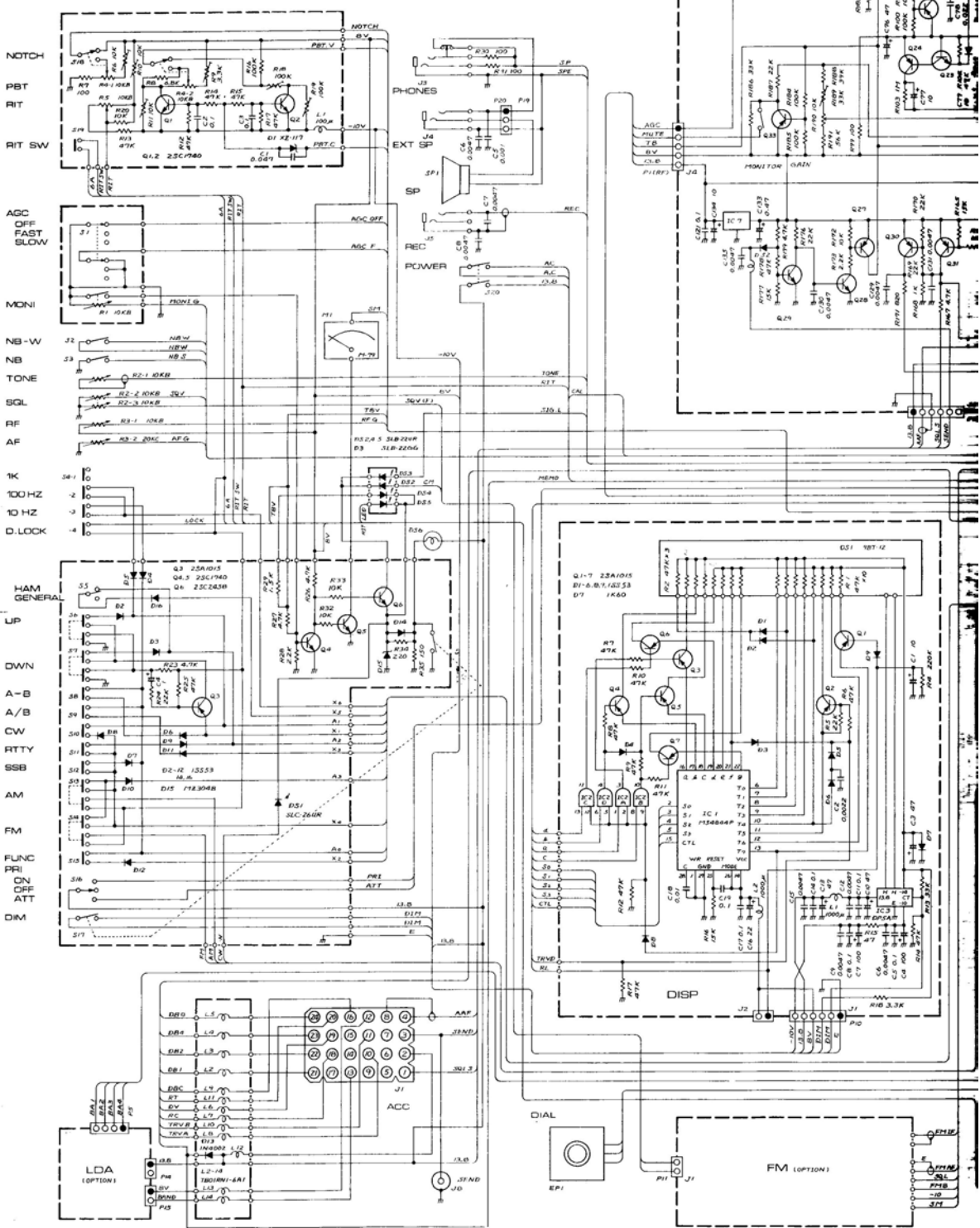

Downloaded by

 Amateur Radio Directory

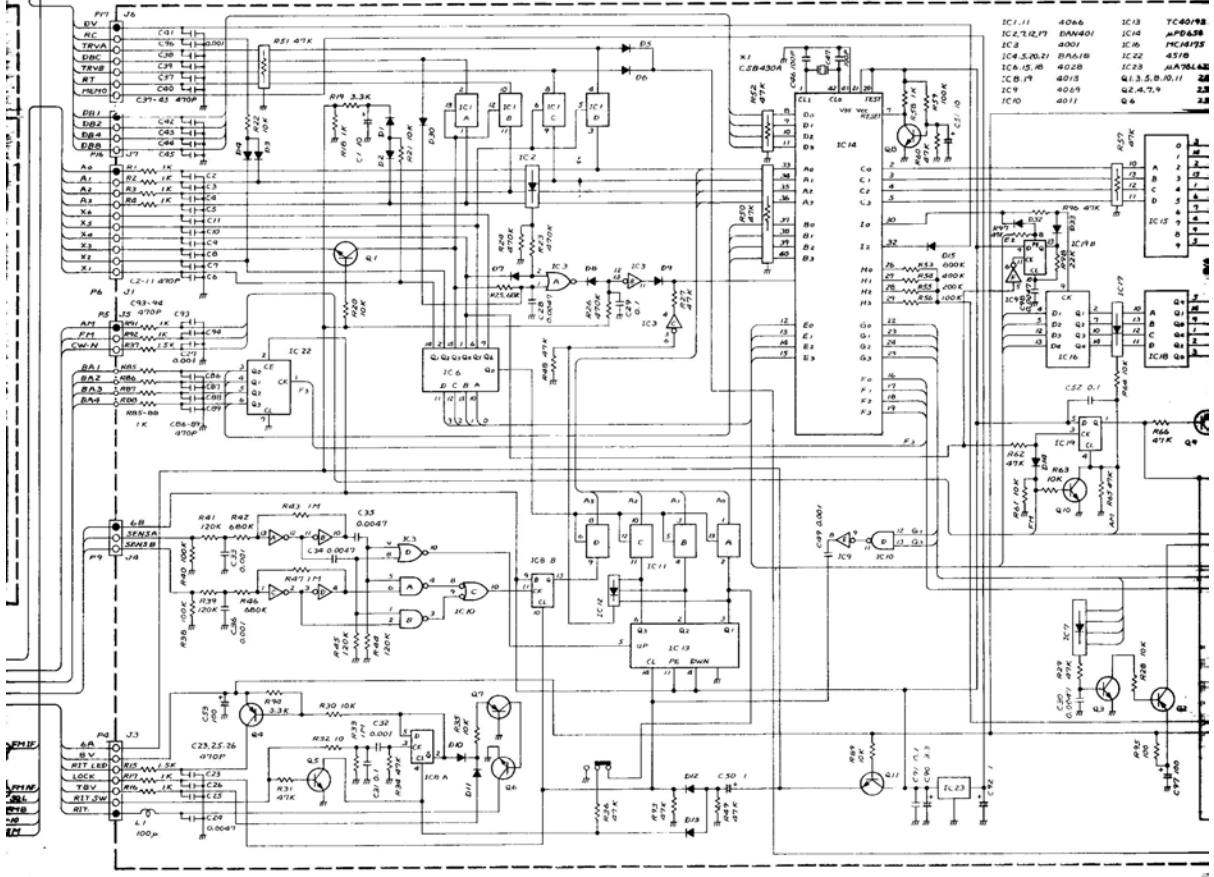
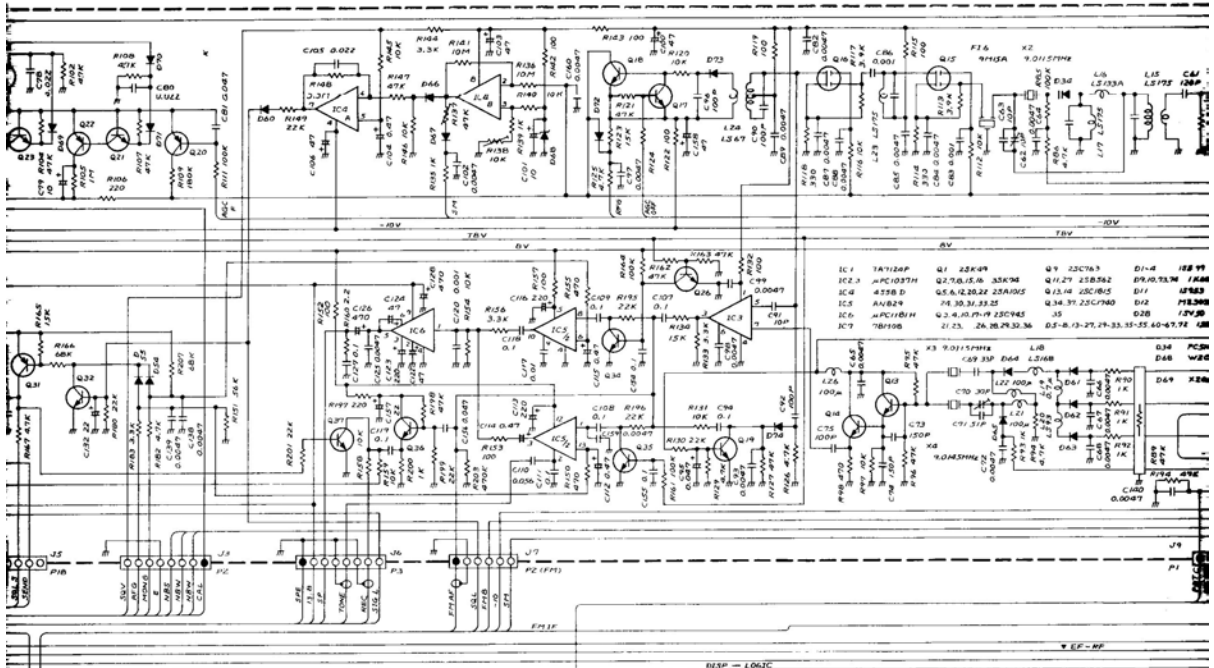

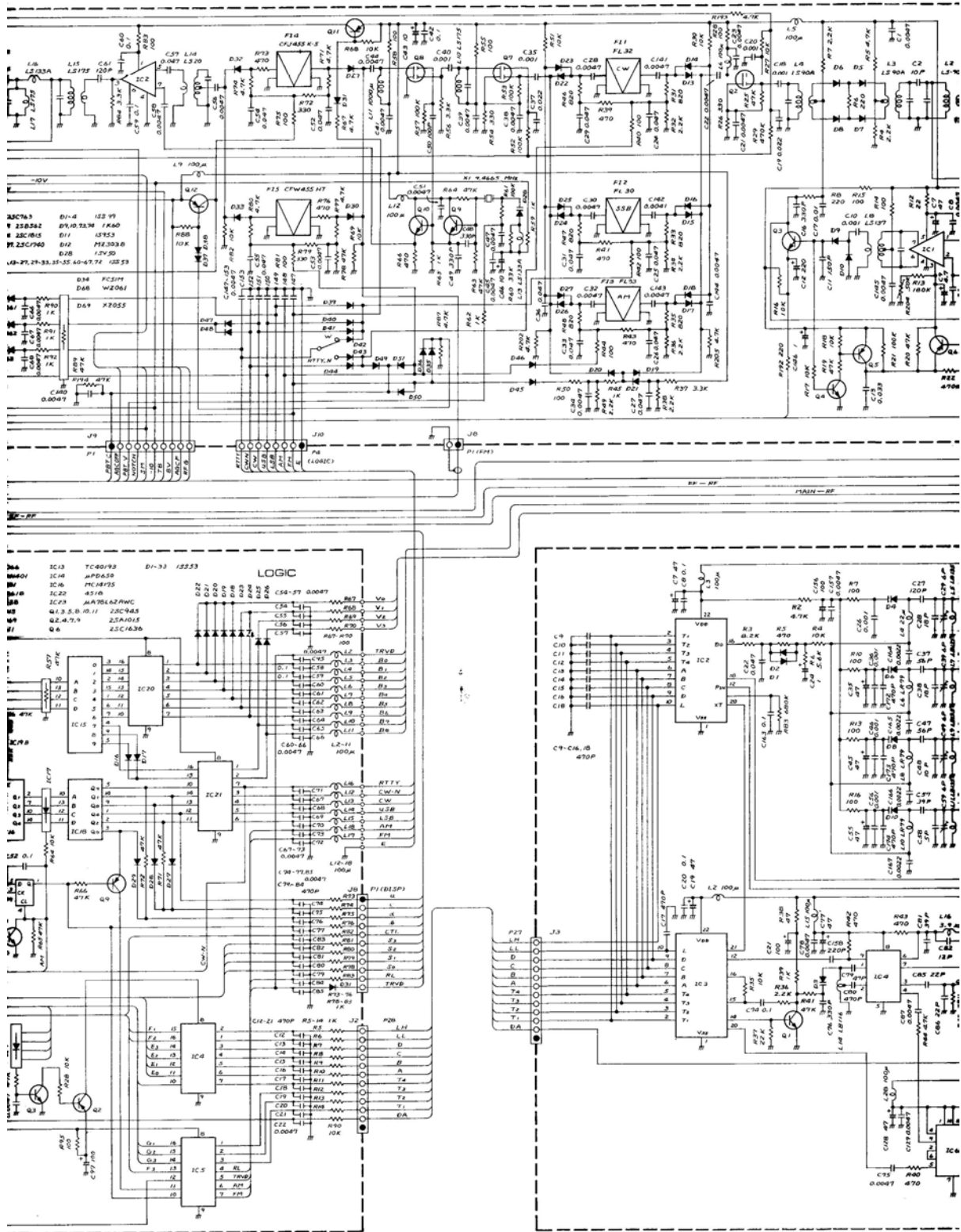

Downloaded by
 Amateur Radio Directory

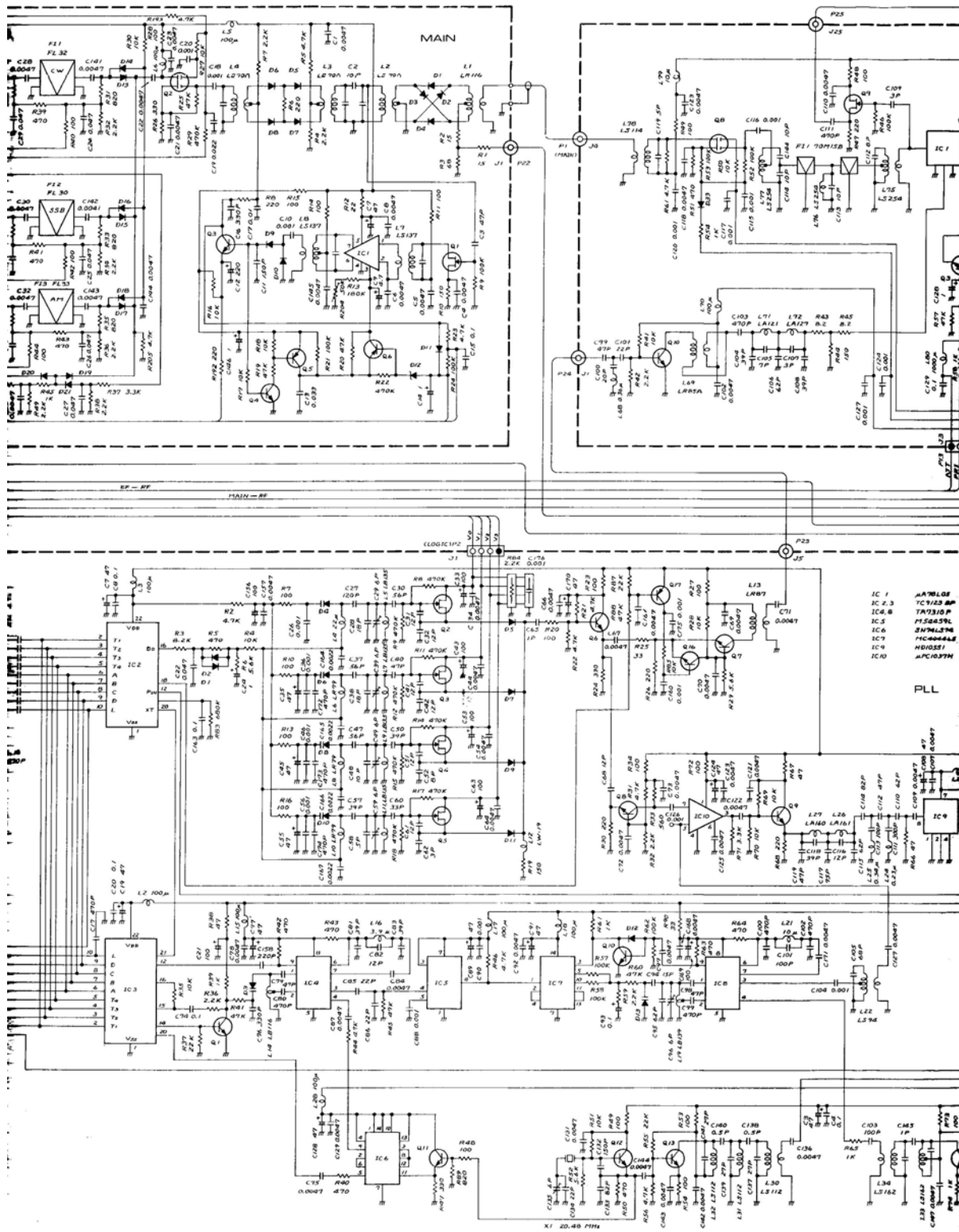

Downloaded by

 Amateur Radio Directory



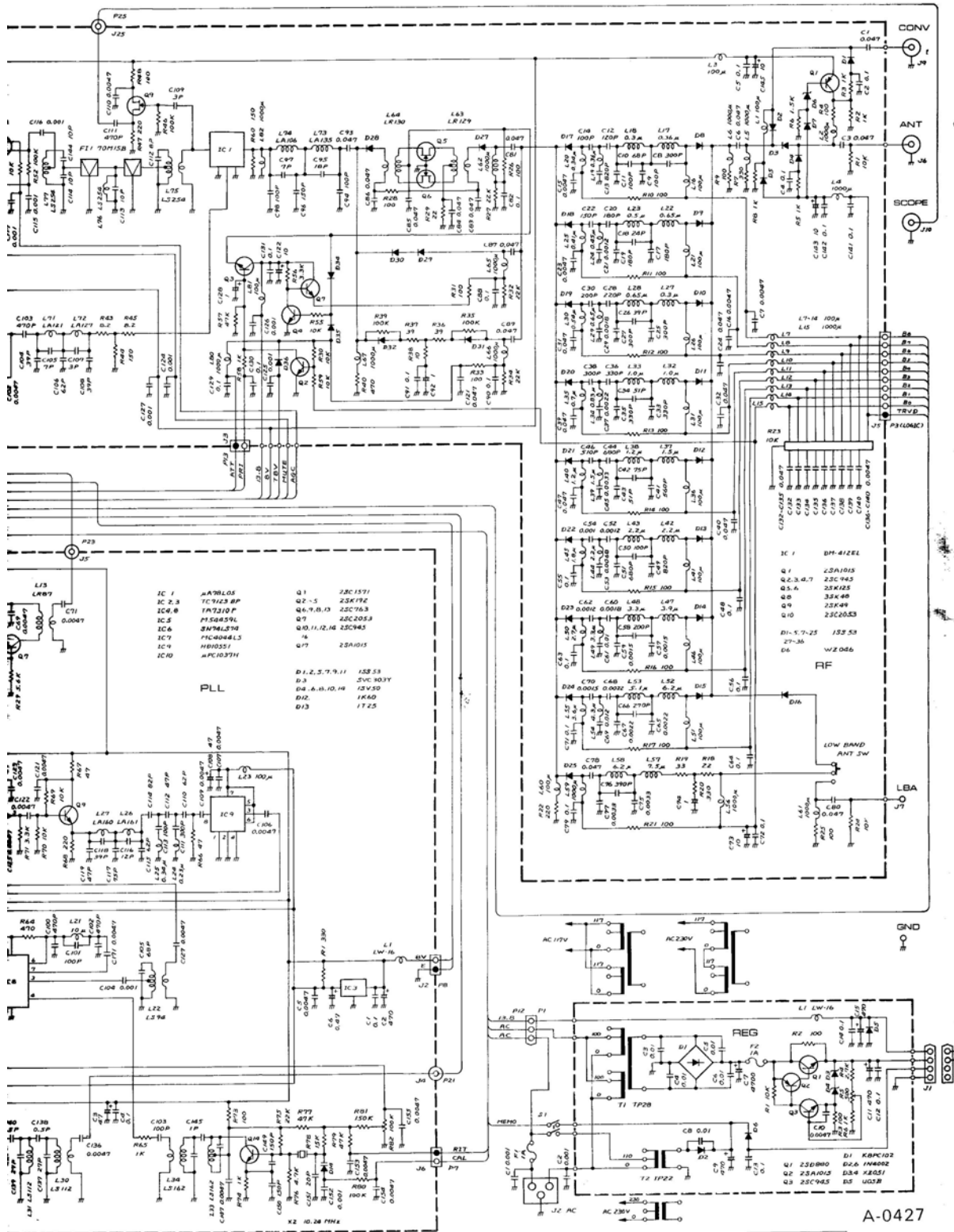

ICOM ICOM INCORPORATED

Some components subject to change for an improvement without notice.

A-0427

FRONT UNIT

P.B.T. BOARD

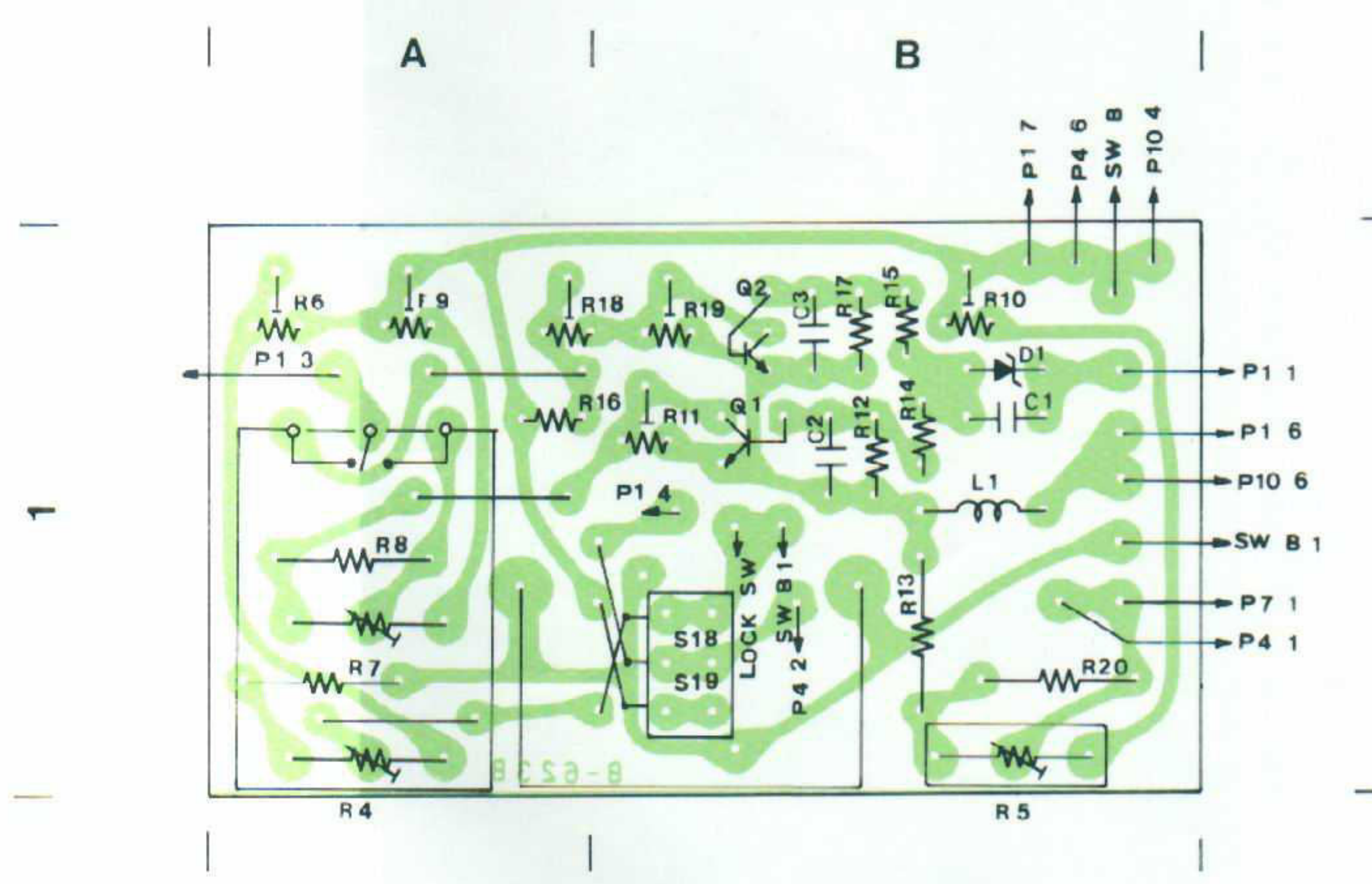

DISPLAY BOARD

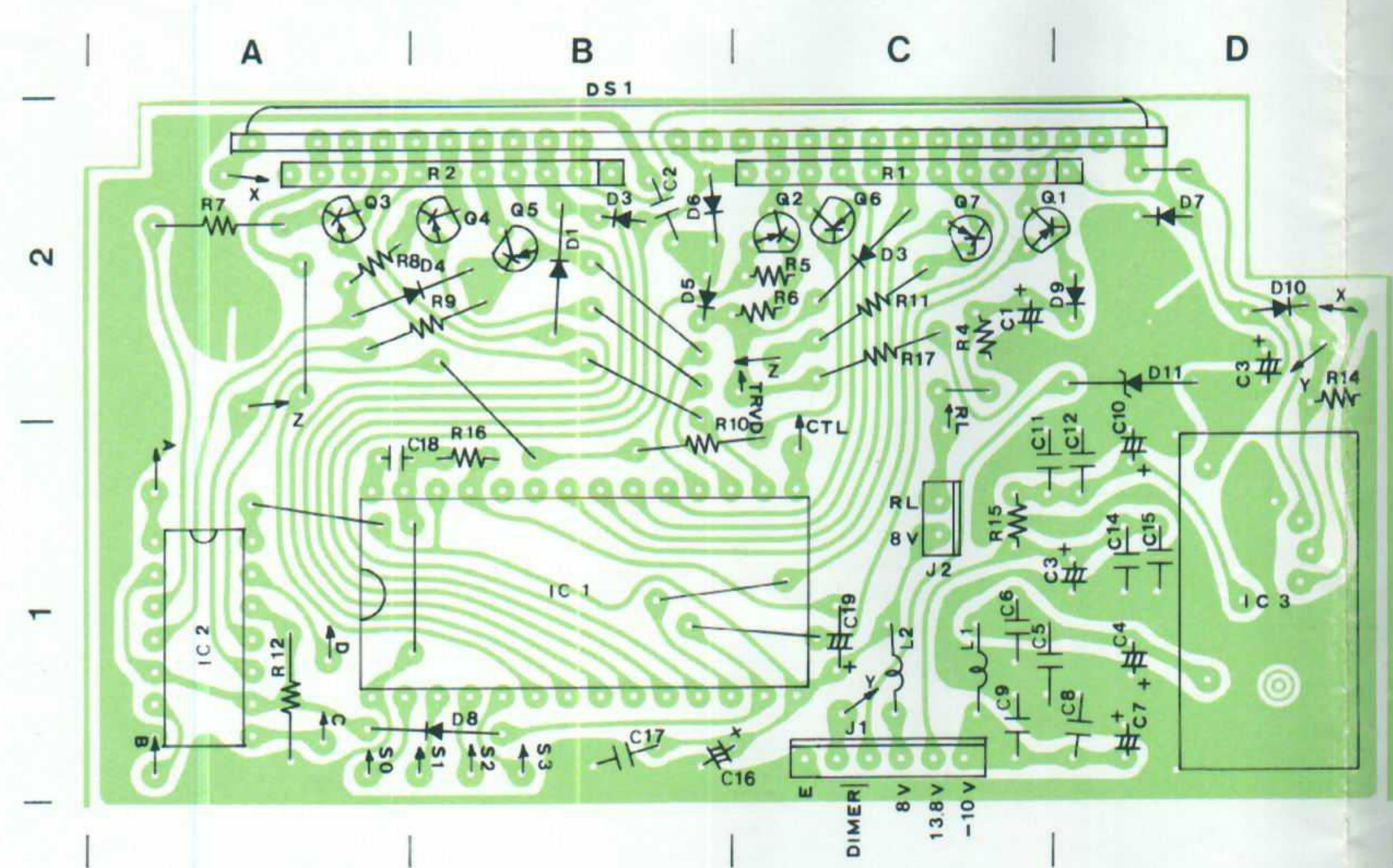

LOGIC UNIT

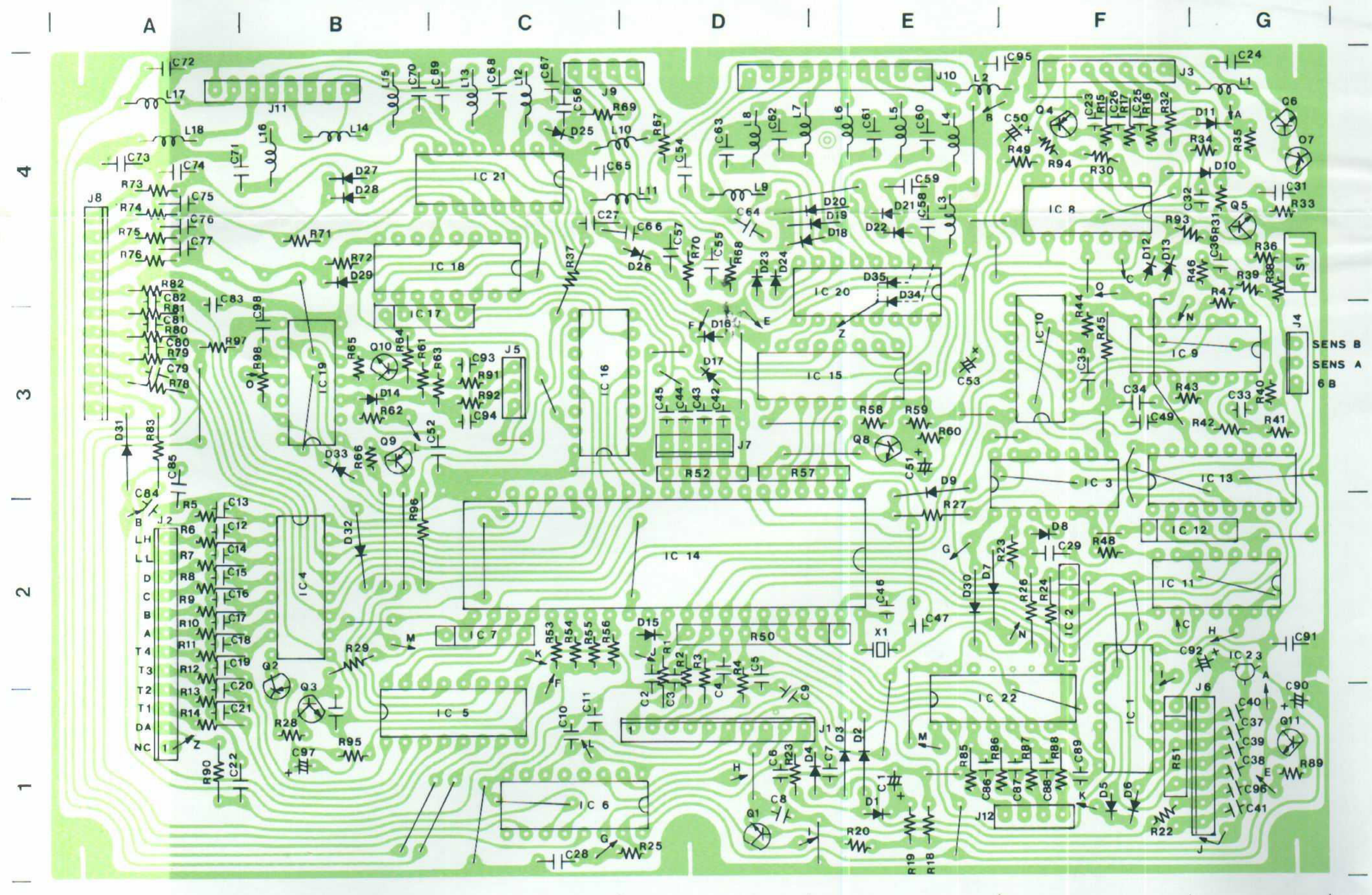

MAIN BOARD



REGULATOR UNIT

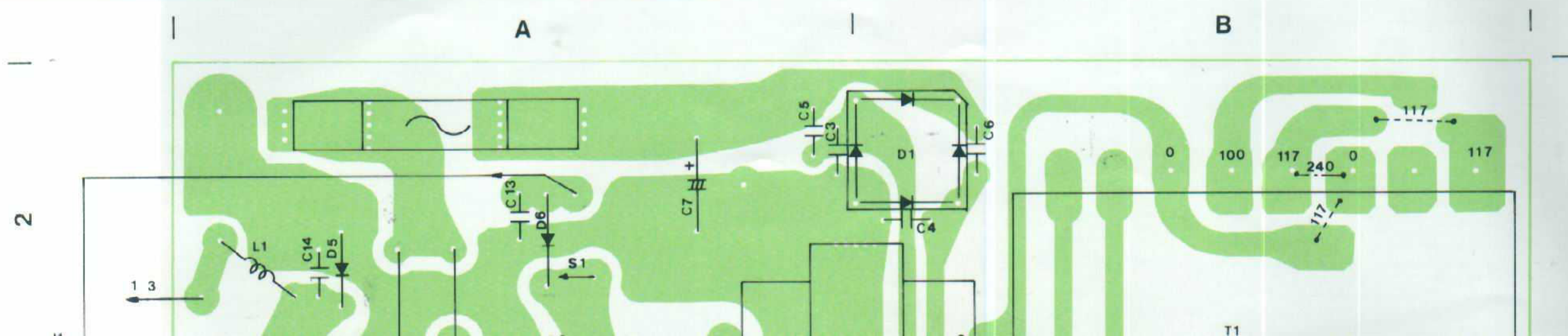

LAYOUT

LED BOARD

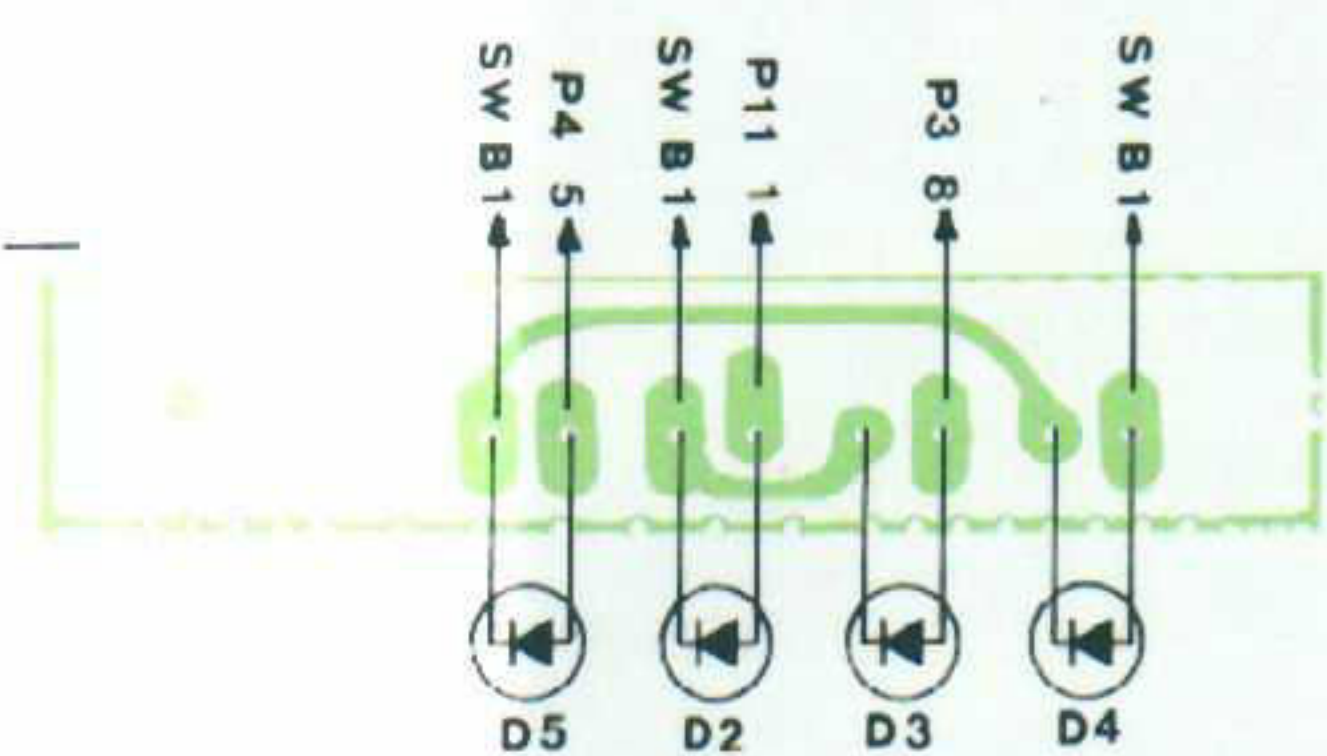

SWITCH BOARD (2)

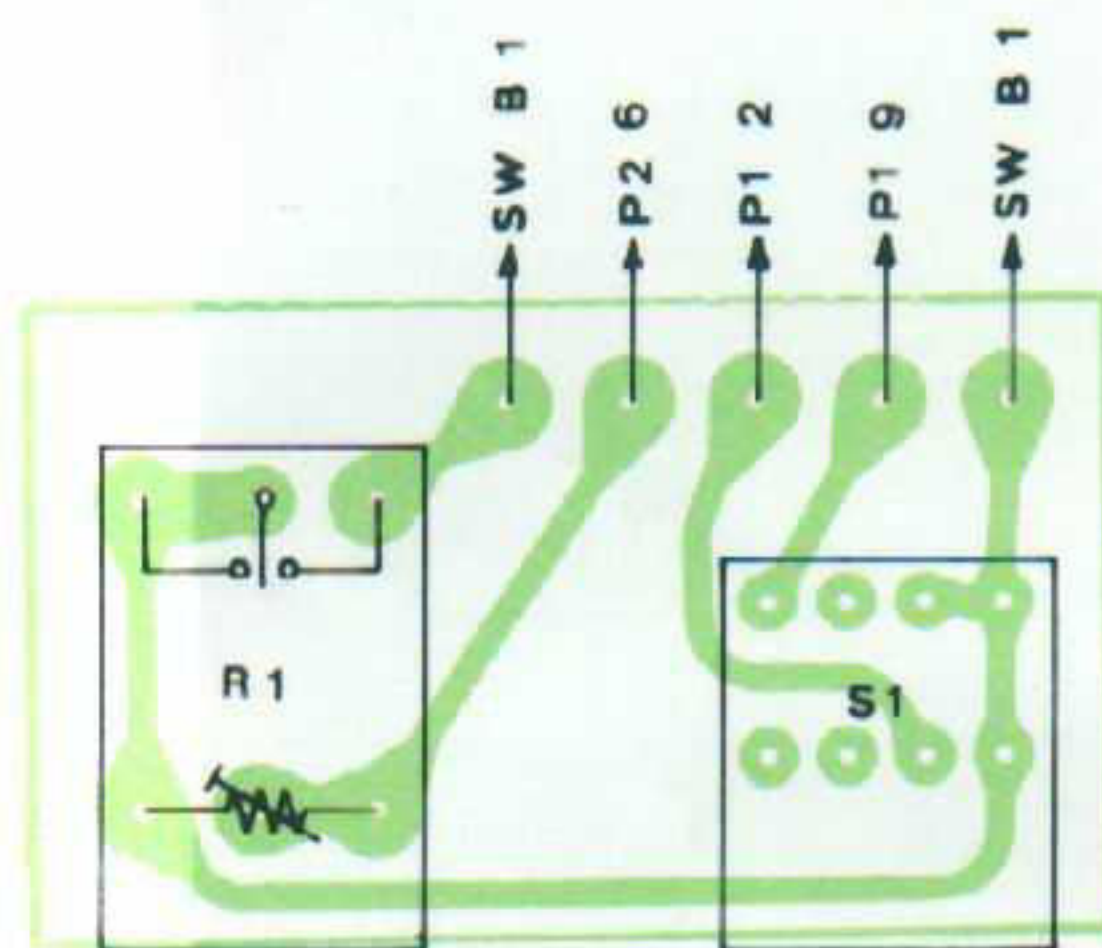

SWITCH BOARD (1)

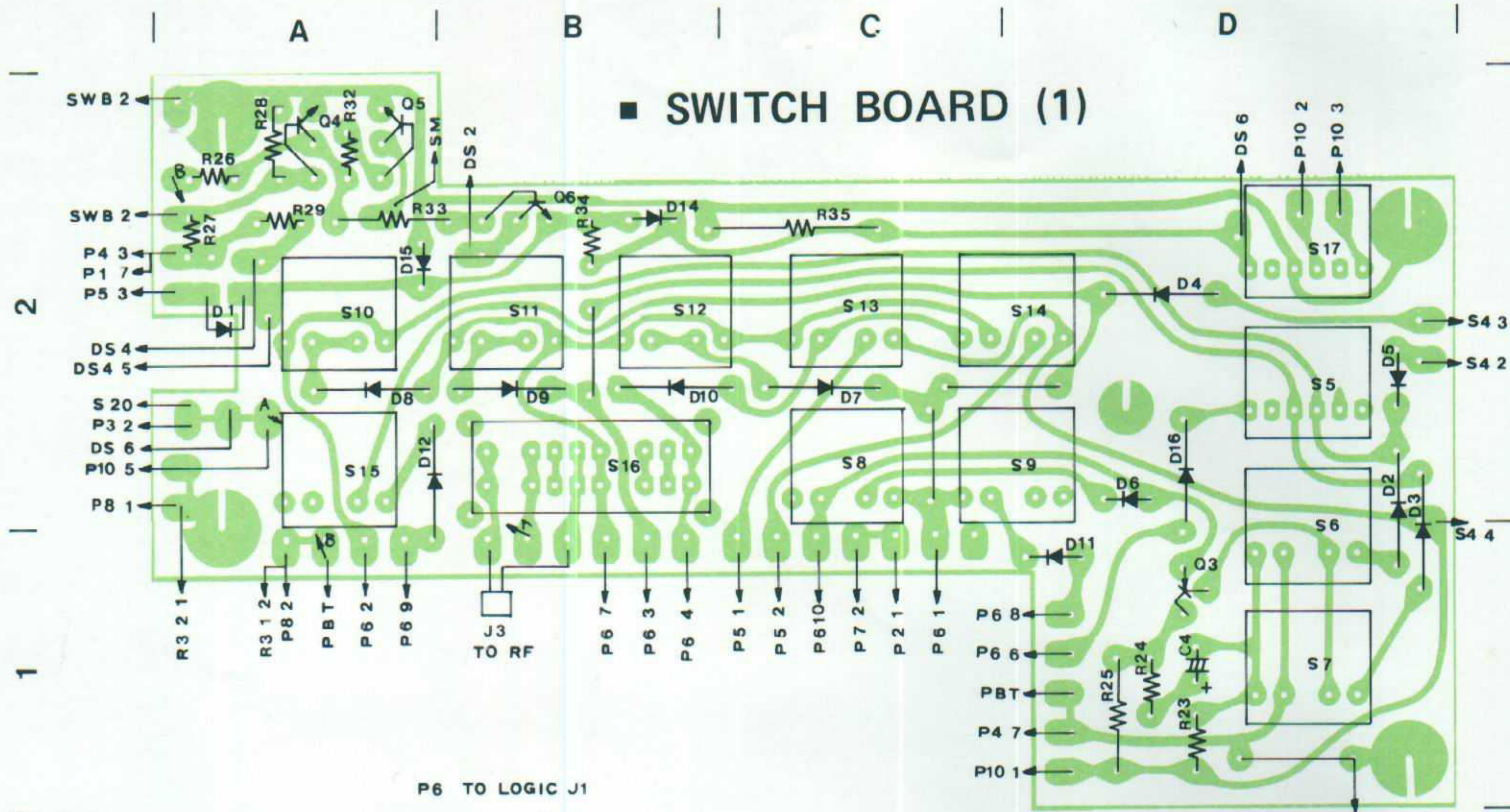

MAIN UNIT

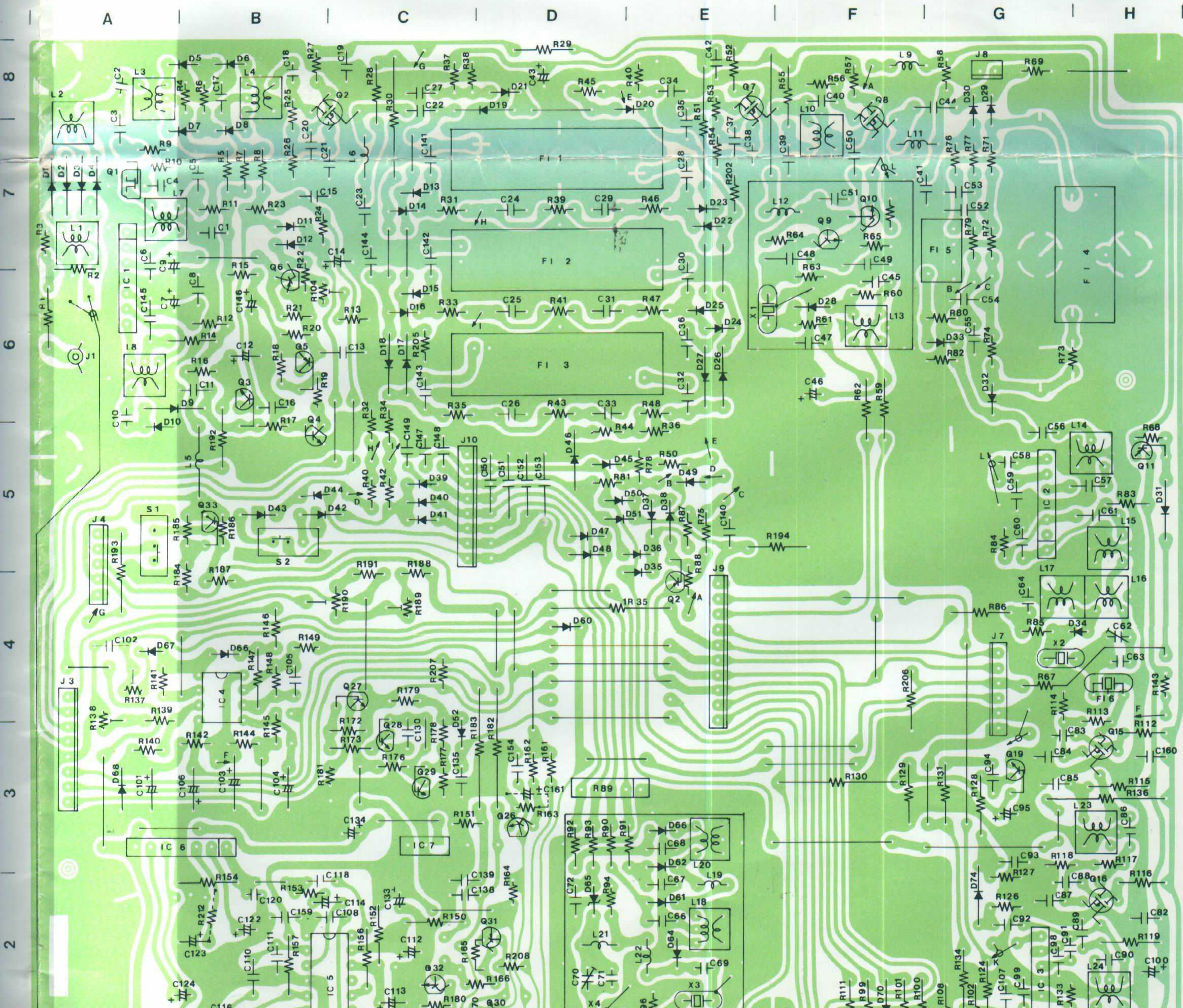

LOGIC UNIT

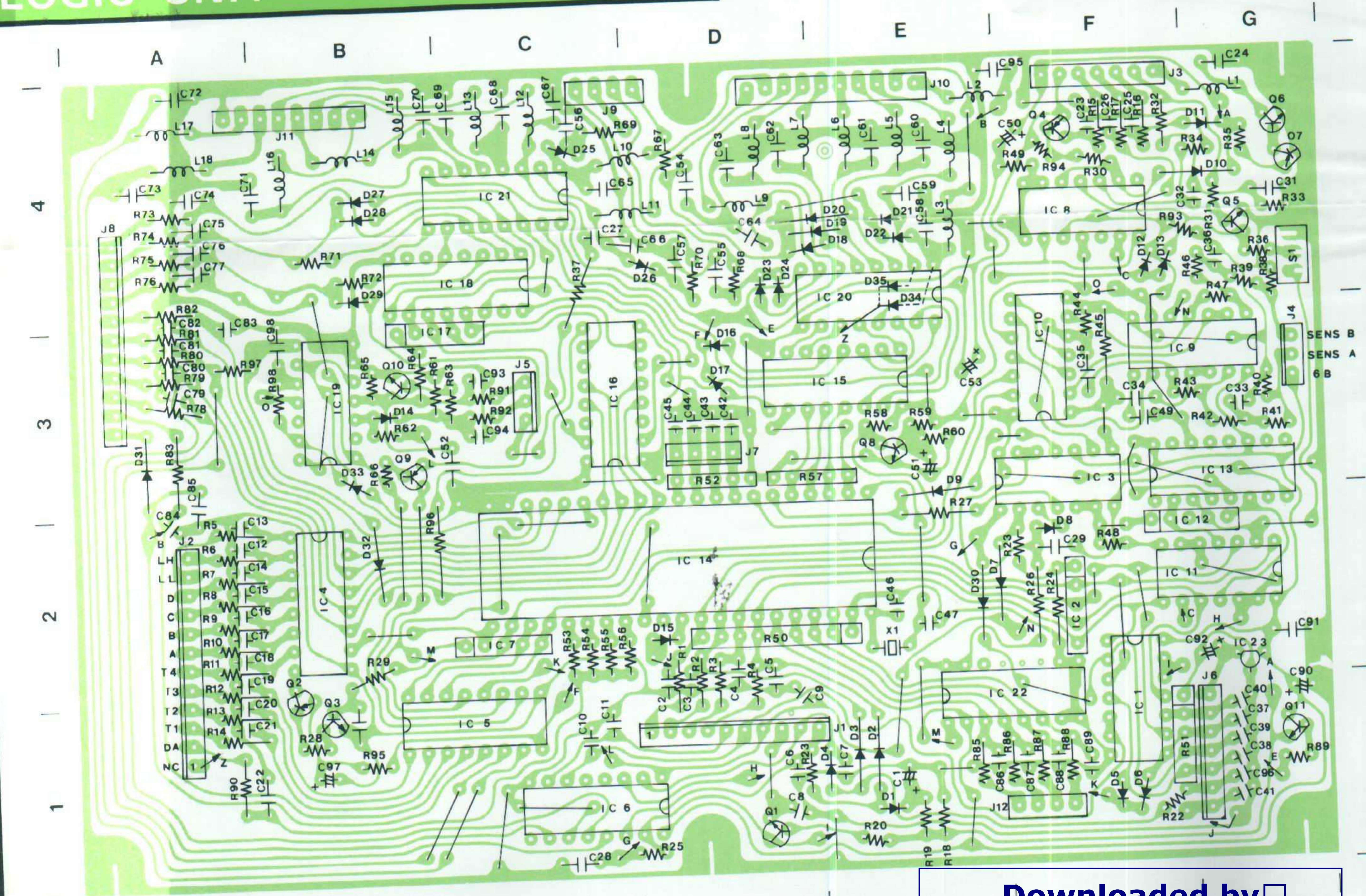

Downloaded by
Amateur Radio Directory

REGULATOR UNIT

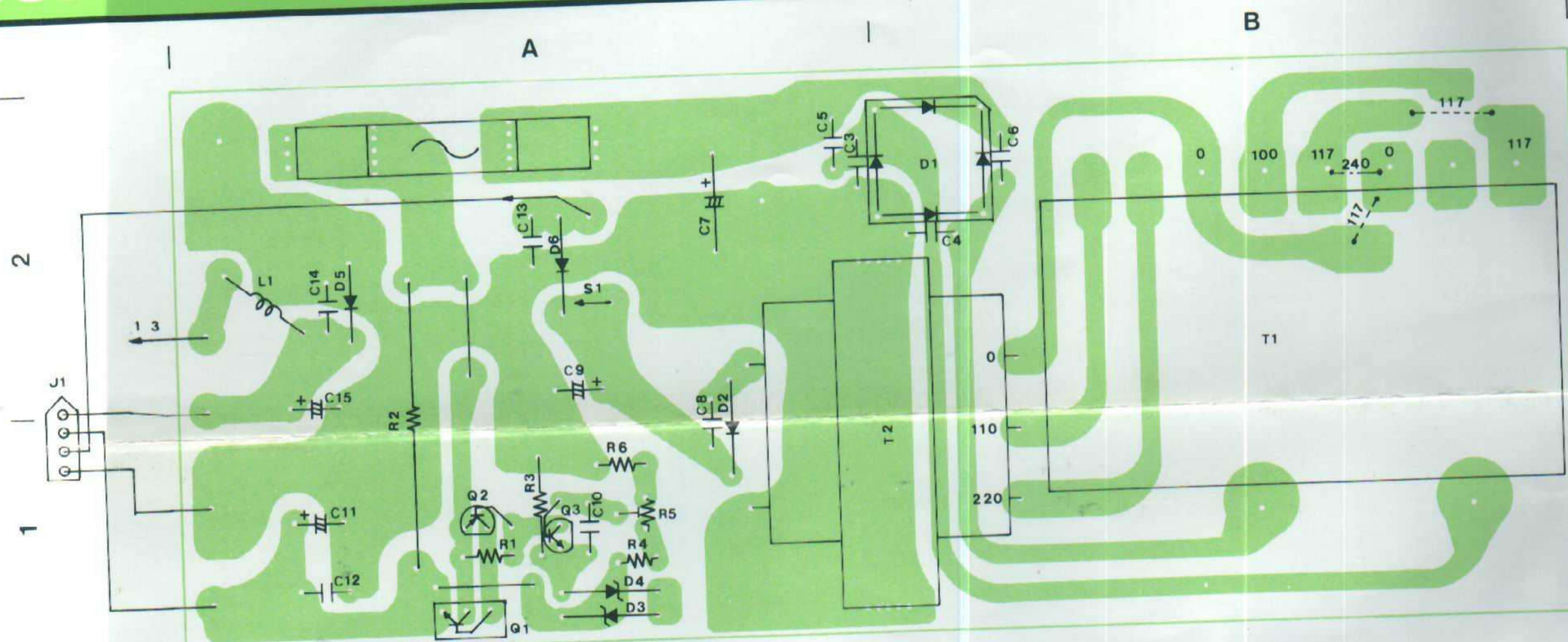

SWITCH BOARD (2)

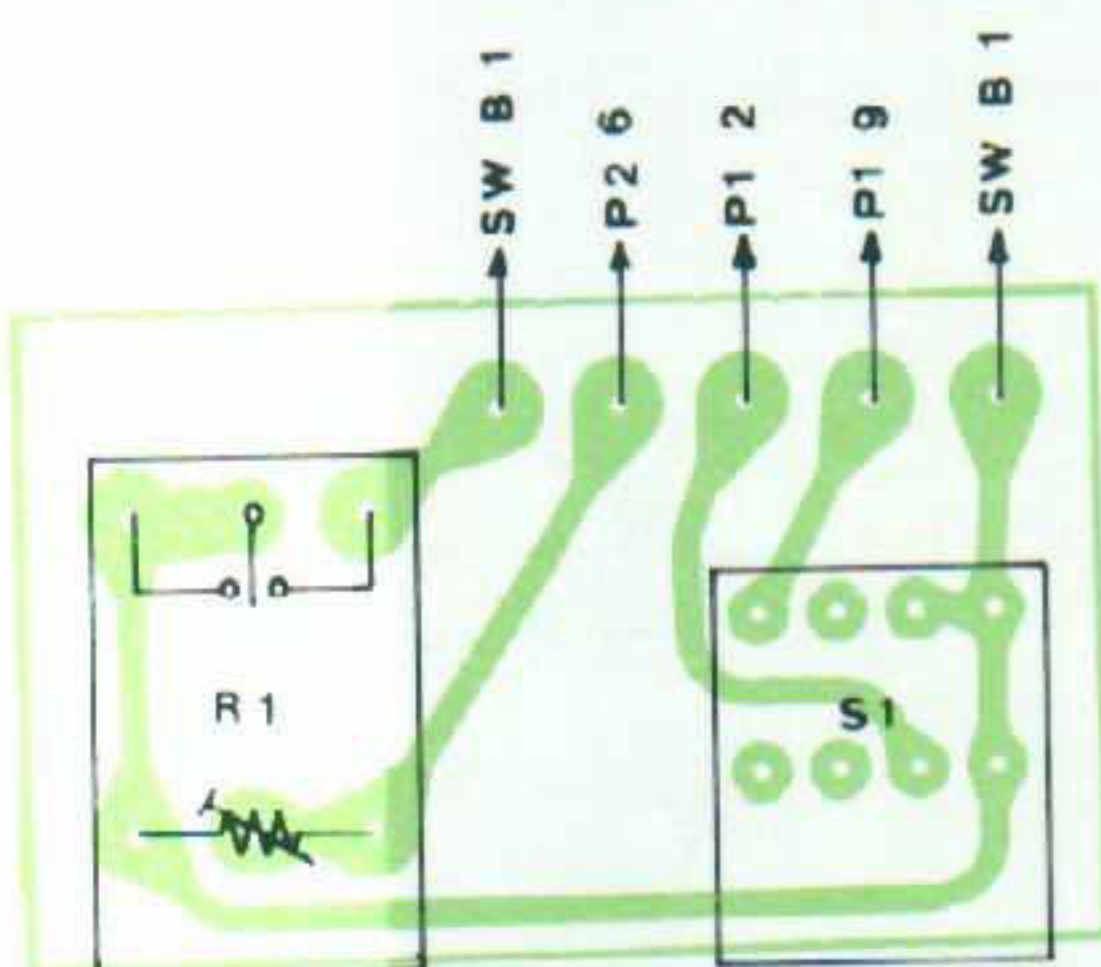

2
1

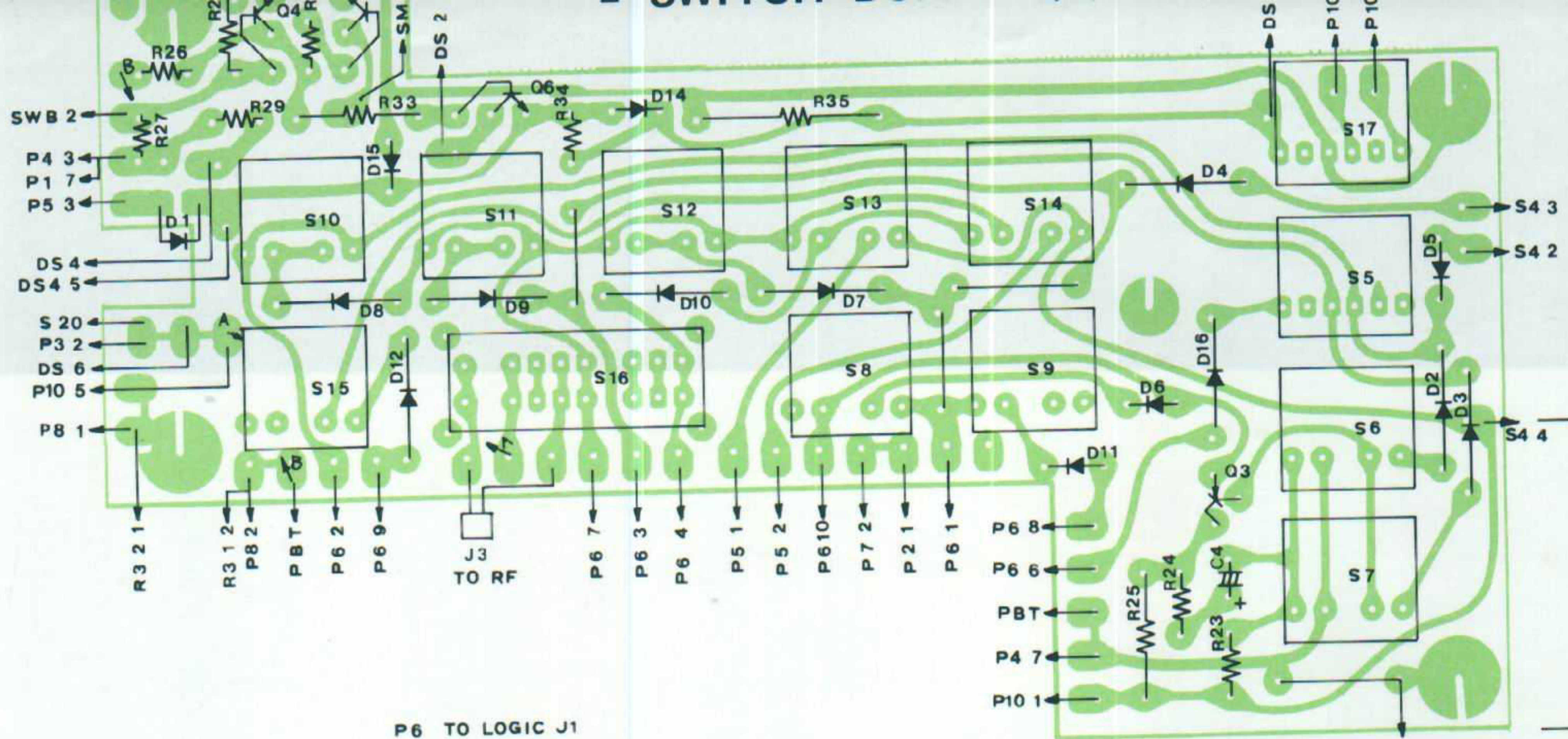

P6 TO LOGIC J1

Downloaded by

Amateur Radio Directory

AIN UNIT

