

IC-12A/AT/E

1200MHz FM TRANSCEIVER

INSTRUCTION MANUAL

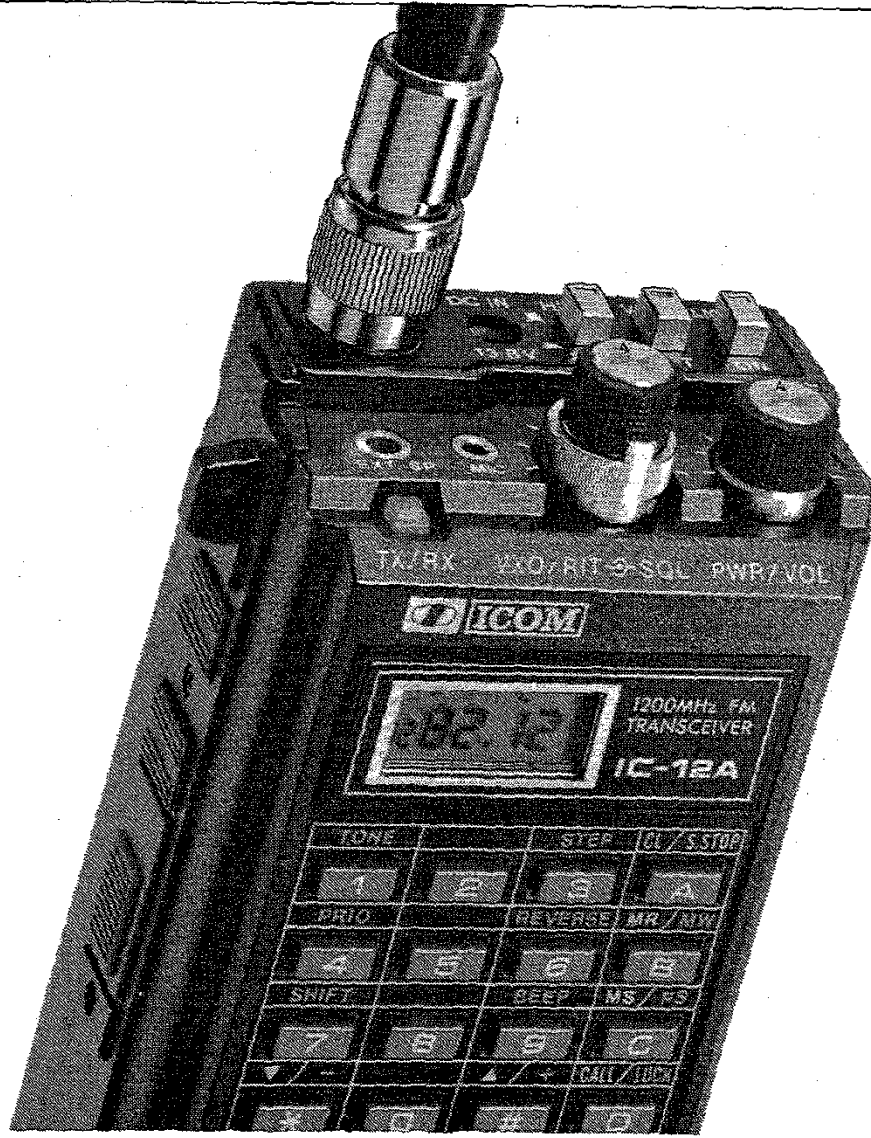

FOREWORD

ICOM announces the debut of the first 1.2GHz handheld transceiver to enter the Amateur radio field, the **IC-12A/AT/E**.

Exceptionally versatile yet surprisingly compact and easy to handle, the **IC-12A/AT/E** is a complete, high performance UHF handheld - the beneficiary of the very latest in ICOM technical know-how and state-of-the-art UHF engineering.

To fully enjoy the many features of your new **IC-12A/AT/E** handheld, please study the instruction manual thoroughly prior to operation. Also, feel free to contact your nearest authorized ICOM dealer if you have any questions relating to the operation of this transceiver.

UNPACKING

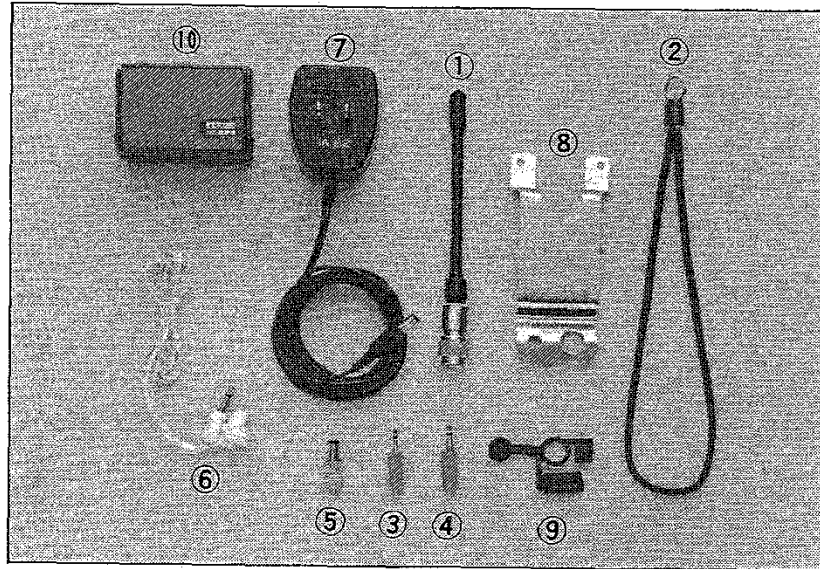

Accessories included with the IC-12A/AT/E.	QTY.
1. Flexible antenna	1
2. Hand strap	1
3. Microphone plug	1
4. Earphone plug.	1
5. DC power plug	1
6. Earphone.	1
7. Wall charger*	1
8. Belt clip	1
9. Rainproof cap.	1
10. IC-BP3 battery pack	1

*BC-25U for U.S.A. version
 BC-27 for Australia version
 BC-26E for Europe version

TABLE OF CONTENTS

SECTION 1	FEATURES	1		
SECTION 2	CONTROL FUNCTIONS	2		
	2- 1 TOP PANEL	2		
	2- 2 FRONT AND SIDE PANELS . . .	3		
	2- 3 REAR PANEL	4		
	2- 4 BOTTOM VIEW	4		
	2- 5 FREQUENCY DISPLAY	10		
SECTION 3	PRE-OPERATION	13		
	3- 1 BATTERY INSTALLATION . . .	13		
	3- 2 ANTENNA CONNECTION . . .	16		
	3- 3 FOR OUTDOOR USE	16		
SECTION 4	GENERAL OPERATION	17		
	4- 1 RECEIVING	17		
	4- 2 TRANSMITTING	18		
	4- 3 KEY FUNCTIONS	18		
SECTION 5	FUNCTIONS OPERATION	21		
	5- 1 DIAL MODE AND MEMORY MODE	21		
	5- 2 SETTING FREQUENCY	22		
	5- 3 SETTING FREQUENCY STEP RATE	25		
	5- 4 DUPLEX OPERATION	26		
	5- 5 MEMORY WRITING	29		
	5- 6 MEMORY READING	32		
	5- 7 CALL CHANNEL OPERATION	33		
	5- 8 PRIORITY FUNCTION	34		
	5- 9 SCANNING OPERATION	36		
	5-10 LOCK FUNCTION	38		
	5-11 BEEP TONE ON/OFF FUNCTION	39		
	5-12 DTMF OPERATION	39		
	5-13 SETTING SUBAUDIBLE TONE ENCODER FREQUENCY	39		
	5-14 TRANSMITTING TONE-BURST	41		
SECTION 6	MAINTENANCE	42		
	6-1 CLEANING	42		
	6-2 MALFUNCTIONS	42		
SECTION 7	INSIDE VIEWS	44		
	7-1 MAIN UNIT	44		
	7-2 PLL UNIT	45		
	7-3 TONE UNIT	46		
SECTION 8	TROUBLESHOOTING	47		
SECTION 9	BLOCK DIAGRAM	50		
SECTION 10	SPECIFICATIONS	51		
SECTION 11	SCHEMATIC DIAGRAM	SEPARATE		

SECTION 1 FEATURES

●MOISTURE PROOF

The IC-12A/AT/E is ruggedly constructed with rubber gaskets between the transceiver covers and chassis, ensuring that moisture will never be a problem when operating in practically any environment.

●SLIDE-ON BATTERY PACK

The supplied IC-BP3 BATTERY PACK easily slides off and on the transceiver body for quick removal or attachment. Once attached it will stay in place due to a quick-release lock button designed to prevent accidental removal.

●POWER MODULE OPERATION

Appearing for the first time in any 1.2GHz handheld from ICOM, the IC-12A/AT/E utilizes an internal power module designed to provide stable and continuous high power output.

●10 MEMORY CHANNELS

The IC-12A/AT/E has ten memory channels which store operating frequency as well as duplex/simplex, duplex offset frequency, and subaudible tone frequency (IC-12AT only) information for your operating convenience.

SECTION 2 CONTROL FUNCTIONS

2-1 TOP PANEL

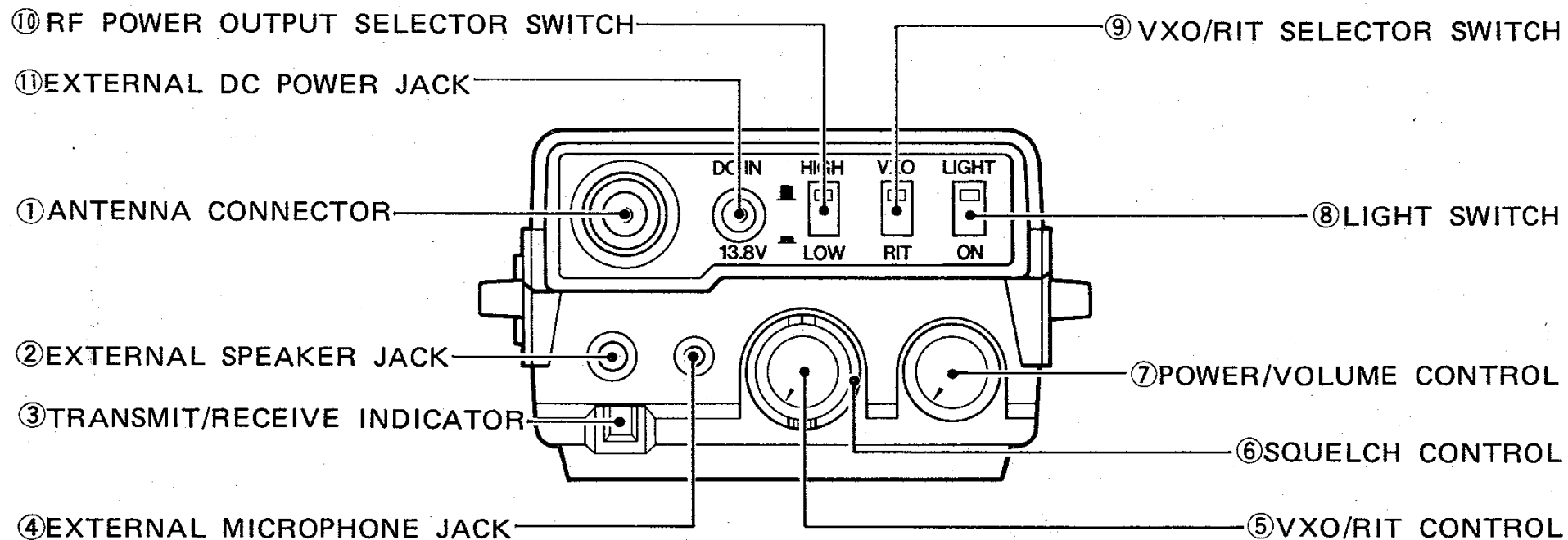

2-2 FRONT AND SIDE PANELS

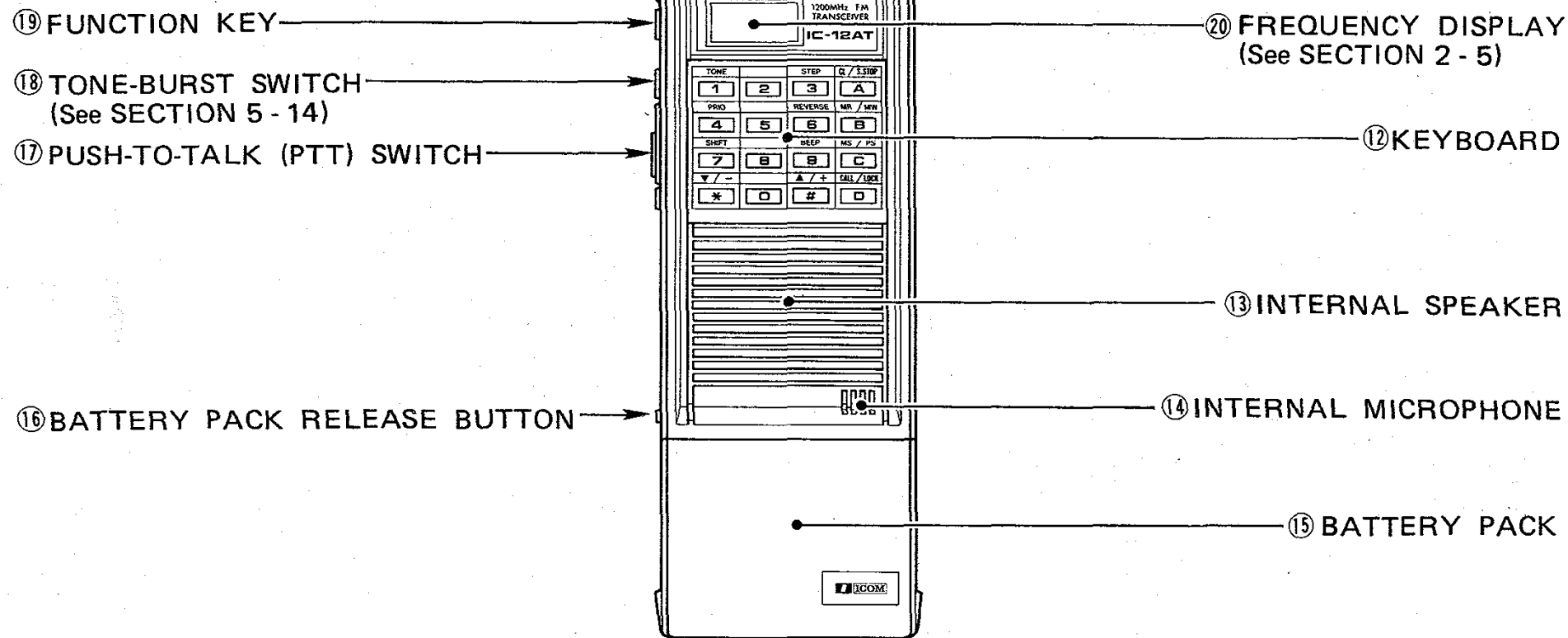

2-3 REAR PANEL (BATTERY PACK)

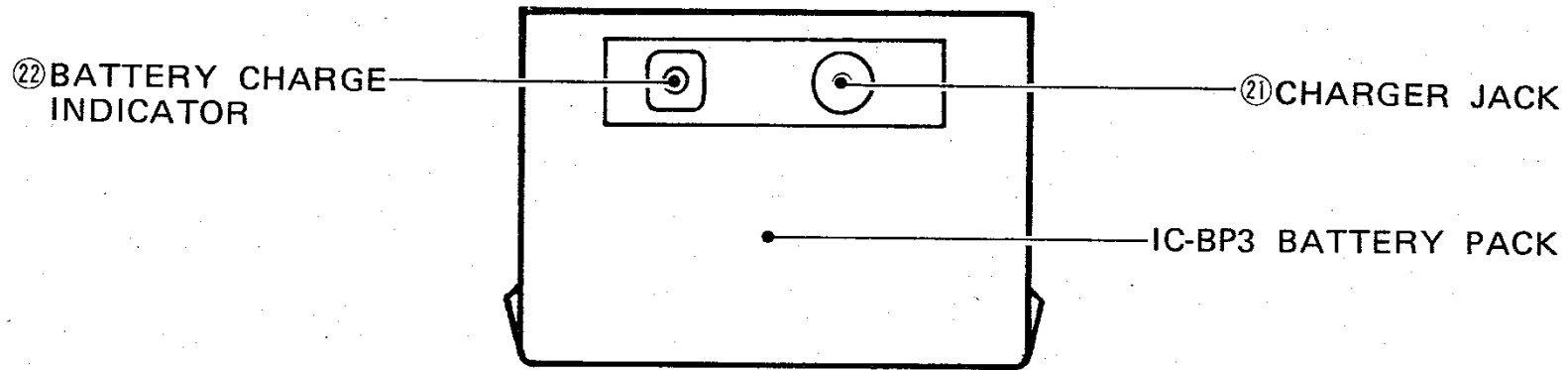

2-4 BOTTOM VIEW

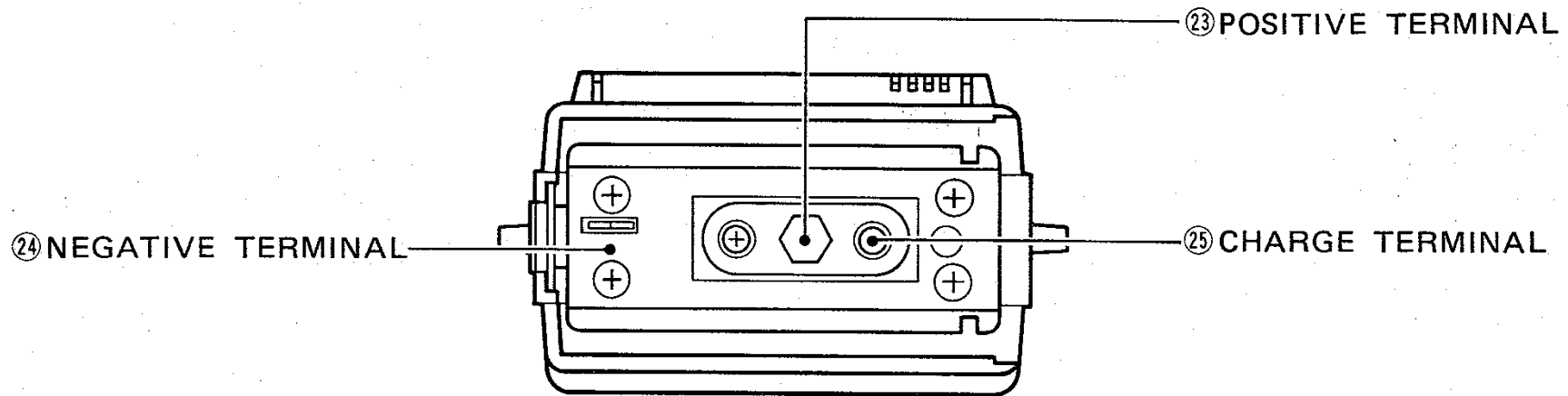

■ TOP PANEL

① ANTENNA CONNECTOR

Connect the supplied flexible antenna. All antennas connected to the transceiver must be 50 ohms and have a TNC connector.

CAUTION: Transmitting without an antenna may damage the transceiver.

② EXTERNAL SPEAKER JACK [EXT. SP]

Connect either an 8 ohm external speaker or the supplied earphone for private listening. The INTERNAL SPEAKER will not operate if an external speaker is connected to the EXTERNAL SPEAKER JACK.

③ TRANSMIT/RECEIVE INDICATOR [TX/RX]

This two-color LED indicates whether the IC-12A/AT/E is in the transmit or receive mode.

The LED is red while transmitting and green while receiving with the squelch circuit open. The indicator is OFF when the squelch circuit is closed and the received signal is muted.

④ EXTERNAL MICROPHONE JACK [MIC]

The optional IC-HM9 SPEAKER-MICROPHONE or optional HS-10 HEADSET can be connected for additional versatility to the EXTERNAL MICROPHONE JACK. The internal microphone does not function when an external microphone is connected.

• **Dynamic microphone**

MIC ELEMENT

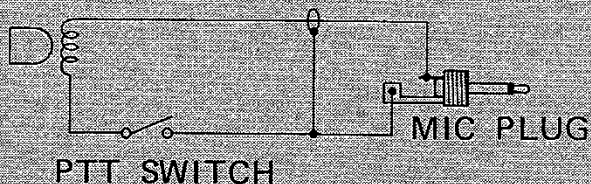

• **Electret condenser microphone**

MIC ELEMENT

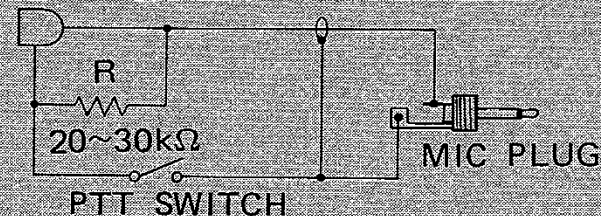

⑤ **VXO/RIT CONTROL**

[VXO/RIT]

Lowers the frequency. Raises the frequency.

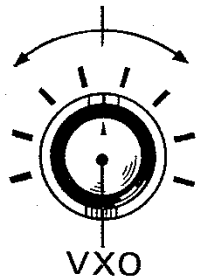

This control shifts the receive and transmit frequencies up and down to 5kHz on either side of the frequency indicated on the frequency display when the VXO function is selected.

This control shifts the receive frequency up to 5kHz on either side of the frequency indicated on the frequency display when the RIT function is selected.

⑥ **SQUELCH CONTROL [SQL]**

Raises the threshold level.

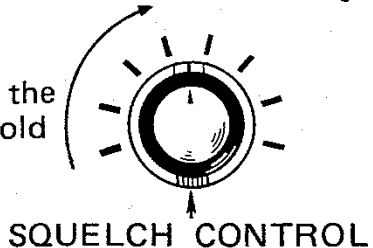

Sets the squelch threshold level. Rotate this control completely counterclockwise to turn OFF the squelch function, and clockwise to raise the threshold level.

⑦ **POWER/VOLUME CONTROL**

[PWR/VOL]

Increases the audio level.



Rotate clockwise to turn the transceiver ON and increase the audio level.

⑧ LIGHT SWITCH [LIGHT]

Press this switch down to turn on the backlight for the FREQUENCY DISPLAY.

⑨ VXO/RIT SELECTOR SWITCH
[VXO] [RIT]

This switch selects either the VXO or RIT function for fine tuning.

⑩ RF POWER OUTPUT
SELECTOR SWITCH
[HIGH] [LOW]

When this switch is set in the LOW position (IN), the output power is reduced to 0.1W which thus conserves battery life.

When greater coverage or longer distance transmissions are needed, place the switch in the HIGH position (OUT) and the transceiver will output one full watt of power.

⑪ EXTERNAL DC POWER JACK
[DC IN] [13.8V]

The [DC IN] [13.8V] jack accepts voltages between 12V and 15V. However, the transceiver does not work when supplying more than 16V.

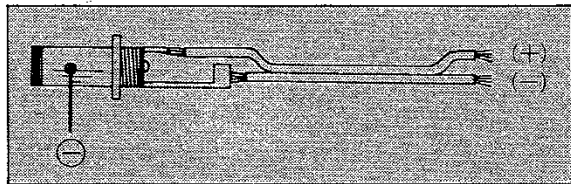

Connect the IC-CP1 CIGARETTE LIGHTER CABLE or external 13.8V DC power source to this jack for mobile operation. The battery pack does not need to be attached for the transceiver to operate. However, if the battery pack is attached, the battery pack will charge automatically.

NOTE: If the IC-12A/AT/E is used continuously for 15 hours or more with an external DC power source connected to the top panel EXTERNAL DC POWER JACK, be sure to remove the battery pack from the transceiver to prevent overcharging.

■ FRONT AND SIDE PANELS

⑫ KEYBOARD

This keyboard has 16 keys consisting of ten numerical keys and six code keys. Some keys have dual functions. See SECTION 4 - 3 KEY FUNCTIONS.

⑬ INTERNAL SPEAKER

The internal speaker operates when the transceiver is receiving. However, it will not operate if an external speaker is connected to the EXTERNAL SPEAKER JACK. Refer to item ②.

⑭ INTERNAL MICROPHONE

The internal microphone operates when the transceiver is transmitting. However, it will not operate if an external microphone is connected to the EXTERNAL MICROPHONE JACK. Refer to item ④.

⑮ BATTERY PACK

The IC-BP3 BATTERY PACK is a fully rechargeable NiCd battery pack that easily attaches to the IC-12A/AT/E.

⑯ BATTERY PACK RELEASE BUTTON [RELEASE]

Push the release button upwards, and slide the battery pack to the right to remove it from the IC-12A/AT/E.

⑰ PUSH-TO-TALK (PTT) SWITCH

Push this switch to begin transmitting.

⑱ TONE-BURST SWITCH (IC-12E version only)

Push this switch to transmit a 1750Hz tone-burst for initial access to a repeater.

⑱ FUNCTION KEY [FUNC]

Push this key to select the secondary function of each key. See SECTION 4 - 3 KEY FUNCTIONS.

⑳ FREQUENCY DISPLAY

Indicates not only the operating frequency but also several other functions. See SECTION 2 - 5 FREQUENCY DISPLAY.

■ REAR PANEL

㉑ CHARGER JACK

This jack accepts the output plug of the supplied BC-25U, BC-26E and BC-27 WALL CHARGERS or suitable power sources.

㉒ BATTERY CHARGE INDICATOR

Lights up during battery pack charging.

■ BOTTOM VIEW

㉓ POSITIVE TERMINAL

This terminal is connected to the positive contact of the battery pack.

㉔ NEGATIVE TERMINAL

This terminal is connected to the negative contact of the battery pack.

㉕ CHARGE TERMINAL

When an external DC power source is connected to the EXTERNAL DC POWER JACK on the top panel while the battery pack is attached, the battery pack will be charged automatically via this CHARGE TERMINAL.

2 - 5 FREQUENCY DISPLAY

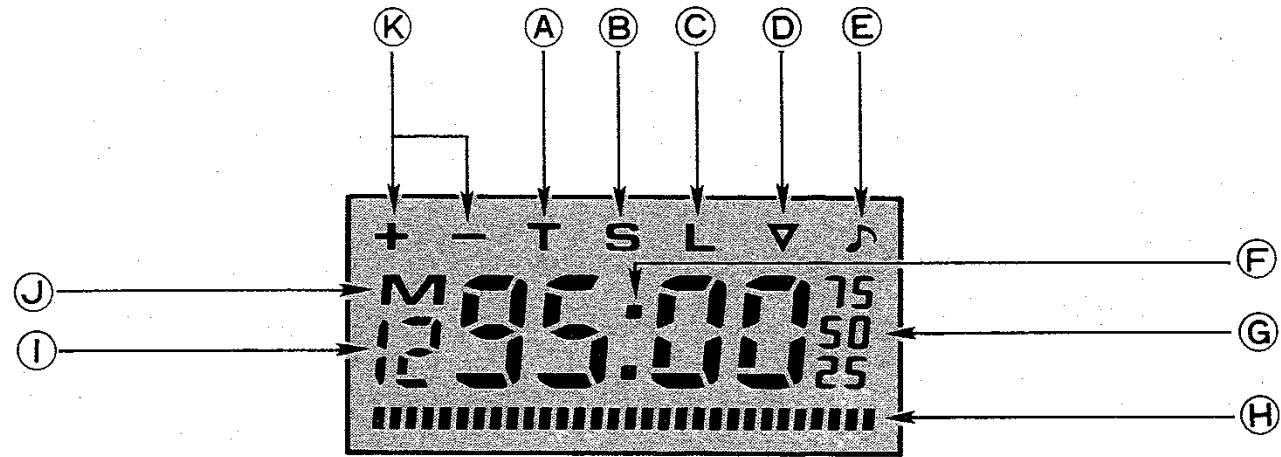

Ⓐ TRANSMIT INDICATOR "T"

"T" appears when the transceiver is in the transmit mode.

Ⓑ SCAN INDICATOR "S"

"S" appears when the transceiver is in a scan mode. Refer to SECTION 5 - 9 SCANNING OPERATION.

Ⓒ LOCK INDICATOR "L"

"L" appears when the operating frequency is locked.

At this time, any key entries will be canceled, except the [FUNC] and [D]/[LOCK] keys when they are used to clear the lock function. Refer to SECTION 5 - 10 LOCK FUNCTION.

Ⓓ BATTERY CONDITION INDICATOR "▽"

"▽" appears just before the battery is exhausted.

- Ⓔ **TONE ENCODER INDICATOR**
 "♪" appears when the subaudible tone encoder (IC-12AT only) is actuated. Refer to SECTION 5 - 13 SETTING SUBAUDIBLE TONE ENCODER FREQUENCY.
- Ⓕ **PRIORITY FUNCTION INDICATOR** "..."
 "... " appears when the transceiver is in the PRIORITY FUNCTION. Refer to SECTION 5 - 8 PRIORITY FUNCTION.
- Ⓖ **FREQUENCY DISPLAY**
 Illuminates the operating frequency from 1000MHz to 10kHz. The small numbers "25", "50" and "75" represent 2.5kHz, 5.0kHz and 7.5kHz respectively. The IC-12A version does not indicate the small numbers.
- Ⓗ **S/RF INDICATOR**
 "■■■■■■■■"
 Indicates signal strength and RF power output level with a dotted bar. The RF power output level meter functions only as a relative output meter and does not indicate the power.
- Ⓘ **MEMORY CHANNEL INDICATOR**
 * See SECTION 5 - 1 for DIAL MODE.
 ** See SECTION 5 - 1 for MEMORY MODE.
 *** See SECTION 5 - 7 for CALL CHANNEL OPERATION.
 These functions are switched automatically while changing between transmit and receive modes.
- Indicates 1000MHz and 100MHz digits of the operating frequency in the *DIAL MODE, and indicates a memory channel via the "M" indicator in the **MEMORY MODE.
- In addition, "C" appears when the ***CALL CHANNEL is being called.

ⓐ **MEMORY MODE INDICATOR**
"M"

"M" appears when the transceiver is in the MEMORY MODE. Refer to SECTION 5 - 6 MEMORY READING.

ⓑ **DUPLEX MODE INDICATORS**
"+ " -"

Appear while the IC-12A/AT/E is being operated in DUPLEX MODE (transmit frequency differs from receive frequency). Both indicators disappear while operating in SIMPLEX MODE. Refer to SECTION 5 - 4 DUPLEX OPERATION.

SECTION 3 PRE-OPERATION

3-1 BATTERY INSTALLATION

(1) Using the IC-BP3 BATTERY PACK

See (2) below for further information regarding battery charging.

The supplied IC-BP3 BATTERY PACK is rechargeable and can be slipped ON or OFF the transceiver very easily.

To recharge the battery pack use the supplied wall charger or the optional desk charger, or a 12V-type cigarette lighter socket with the IC-CP1 CIGARETTE LIGHTER CABLE.

TRANSCEIVER	SUITABLE BATTERY CHARGER
IC-12AT (U.S.A. version)	*BC-25U, BC-35 (117V), IC-CP1
IC-12A (Australia version)	*BC-27, BC-36 (240V), IC-CP1
IC-12E (Europe version)	*BC-26E, BC-36 (220V), IC-CP1

*Supplied with IC-12A/AT/E.

(2) BATTERY CHARGING

1) Use a suitable battery charger as shown in the chart above or use a stable power source with an output voltage of DC 13.8V, or a 12V-type cigarette lighter socket with the optional IC-CP1.

- 2) It is not necessary for the IC-BP3 BATTERY PACK to be attached to the transceiver for recharging, but if it is, be sure that the POWER SWITCH on the transceiver is turned completely OFF before starting the charge.
- 3) It takes about 15 hours to charge the battery pack completely.

● BATTERY PACK NOTE

The full charge capacity of NiCd rechargeable batteries may be reduced if repeatedly charged with only partial discharge periods. This is called the battery memory effect. If the battery capacity seems lower than when new, discharge the pack completely through normal use, then charge fully using the proper charger.

- (3) EXTERNAL POWER SOURCE For use at home or in a car, use an external power source which assures you of stable communication without concern for battery consumption.

NOTE: If the IC-12A/AT/E is used continuously for 15 hours or more with an external DC power source connected to the top panel EXTERNAL DC POWER JACK, be sure to remove the battery pack from the transceiver to prevent overcharging.

• CHARGER CONNECTIONS

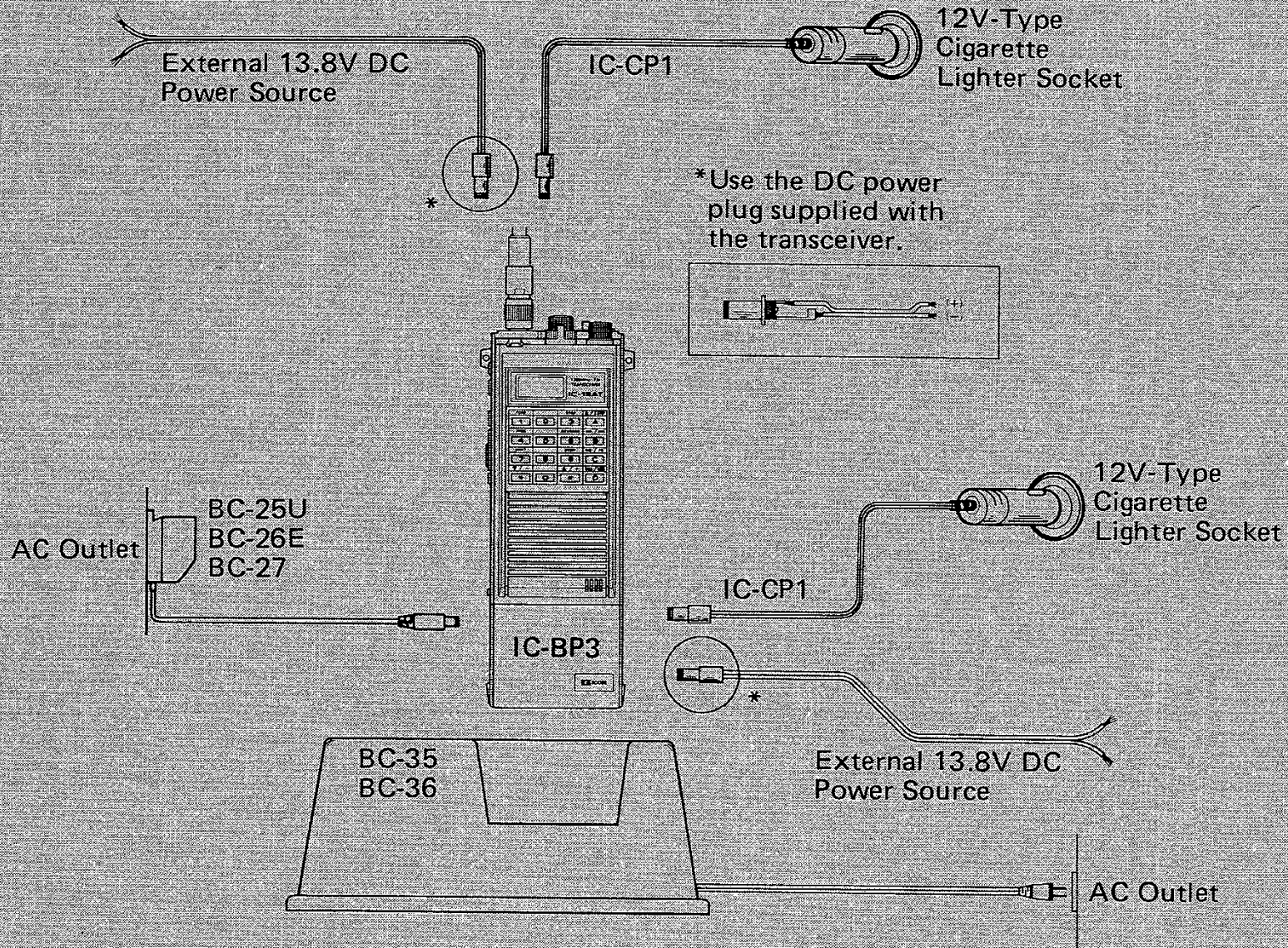

3-2 ANTENNA CONNECTION

Insert the connector on the flexible rubber antenna into the ANTENNA CONNECTOR on the top panel. Screw down securely.

FOR EXTERNAL ANTENNA CONNECTION:

- Select a high performance antenna and set it up in the highest position.
- Use a 50 ohm antenna and coaxial cable with TNC plug.

3-3 FOR OUTDOOR USE

- 1) Attach the belt clip to the rear panel using the two supplied screws and plastic washers.
- 2) Spread open and slide the ring of the hand strap over either of the projecting loops on the sides of the IC-12A/AT/E.

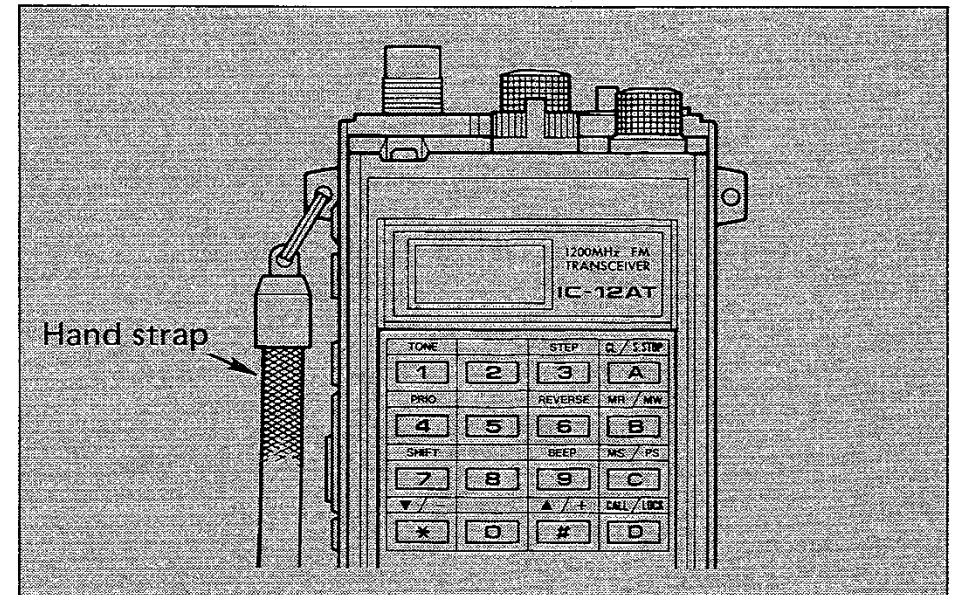
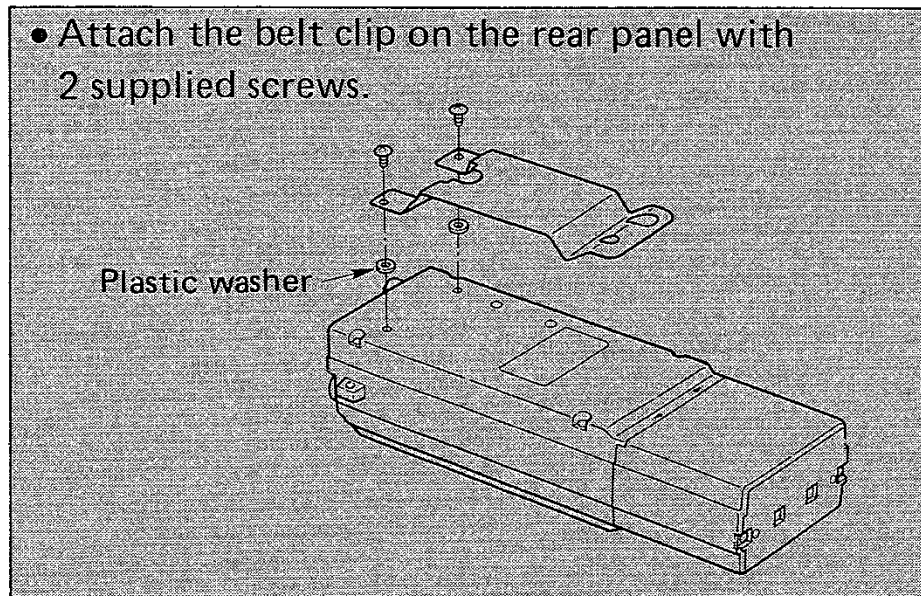

SECTION 4 GENERAL OPERATION

4 - 1 RECEIVING

Verify that the [PWR/VOL] CONTROL is in the OFF position before connecting power to the transceiver. Refer to SECTION 5 for further information.

- 1) Rotate the POWER/VOLUME CONTROL clockwise beyond the "click" to turn power ON.
- 2) Rotate the SQUELCH CONTROL fully counterclockwise. Rotate the POWER/VOLUME CONTROL clockwise to a comfortable listening level.
- 3) If only noise with no signal is heard from the speaker, rotate the SQUELCH CONTROL clockwise until the noise is quieted.

This is the threshold point. The transceiver remains silent after this adjustment until a signal is received which opens the receiver's squelch circuit.

- 4) To set an operating frequency, push four digit keys representing the frequency desired, beginning with the 10MHz and ending with the 10kHz digit. Refer to SECTION 5 - 2 SETTING FREQUENCY.

[EXAMPLE]

Setting frequency at 1275.60MHz.

Press keys	7	5	6	0
Display	127	1275	12756	1275.60

4 - 2 TRANSMITTING













Following are procedures for general transmitting. Refer to SECTION 5 FUNCTIONS OPERATION for further information.

- 1) Press the PTT SWITCH to begin transmitting. The letter "T" appears on the display to indicate a signal is being transmitted.
- 2) Speak into the microphone using your normal voice level.
- 3) Release the PTT SWITCH to return to the receive mode.

4 - 3 KEY FUNCTIONS

Some keys have dual functions. To select the secondary function, push the [FUNC] key located on the side of the transceiver, and then push the correct key for the function desired.

PRIMARY FUNCTIONS		SECONDARY FUNCTIONS	
KEY	FUNCTION	KEY	FUNCTION
[1]	Sets the digit of 1.	TONE [1]	Sets a desired subaudible tone or turns the tone ON/OFF. Push this key then desired tone number keys. To turn OFF the function, push this key again.
[2]	Sets the digit of 2.	-----	-----
[3]	Sets the digit of 3.	STEP [3]	Sets a desired frequency step. Push this key, then one of the step keys [1] to [5].
[4]	Sets the digit of 4.	PRIO [4]	Sets the PRIORITY FUNCTION. To turn OFF this function, push the [A] key.
[5]	Sets the digit of 5.	-----	-----
[6]	Sets the digit of 6.	REVERSE [6]	In DUPLEX MODE, the transmit and receive frequencies are exchanged with each other.
[7]	Sets the digit of 7.	SHIFT [7]	Sets a desired receive/transmit frequency separation. Push this key, then the desired separation frequency using four digits.
[8]	Sets the digit of 8.	-----	-----
[9]	Sets the digit of 9.	BEEP [9]	Turns ON and OFF the beep tone circuit which generates a tone when a key is pushed.
[0]	Sets the digit of 0.	-----	-----

PRIMARY FUNCTIONS		SECONDARY FUNCTIONS	
KEY	FUNCTION	KEY	FUNCTION
	Decreases the operating frequency with specified steps, or operating memory channel number.	▼ / - 	Sets the -duplex in DUPLEX MODE. Push the key again to change to SIMPLEX MODE.
	Increases the operating frequency with specified steps, or operating memory channel number.	▲ / + 	Sets the +duplex in DUPLEX MODE. Push the key again to change to SIMPLEX MODE.
	Clears the entered number, and recalls previous frequency. Clears MEMORY MODE and selects DIAL MODE. Clears the PRIORITY FUNCTION. Clears any scan function and the operating frequency or memory channel stops on the displayed frequency.	CL / S STOP 	Clears MEMORY MODE and the information in the memory channel is transferred to DIAL MODE.
	Sets the transceiver in MEMORY MODE. Push the key, then a desired channel number [0] to [9].	MR / MW 	Writes the displayed frequency into a memory channel. Push the key, then a desired channel number to store the displayed frequency.
	Sets the transceiver in MEMORY SCAN MODE. Scans all memory channels.	MS / PS 	Sets the transceiver in PROGRAMMED SCAN MODE. Scans between the frequencies memorized in channels 5 and 6 with specified steps.
	Selects the frequency memorized in the memory channel 3. At this time, any key entries are cancelled except the [A] key which clears this function.	CALL / LOCK 	Cancels any key entries to prevent accidental key operation. To clear this function, push this key again while pressing the [FUNC] key.

SECTION 5 FUNCTIONS OPERATION

5-1 DIAL MODE AND MEMORY MODE

The IC-12A/AT/E has two different operating modes, DIAL MODE and MEMORY MODE. Each mode has the following functions:

(1) FUNCTIONS IN DIAL MODE

FUNCTION	PAGE
① Setting frequency	22
② Frequency up or down	24
③ Setting frequency step rate	25
④ Setting the BEEP ON/OFF function	39
⑤ Setting the subaudible tone encoder frequency	39
⑥ Setting DUPLEX MODE	27
⑦ Setting duplex offset frequency	26
⑧ Reversing TX and RX frequencies in DUPLEX MODE	28
⑨ Memory writing	29
⑩ Setting scan start in PROGRAMMED SCAN MODE	37

(2) FUNCTIONS IN MEMORY MODE

FUNCTION	PAGE
① Recalling the frequency memorized in a memory channel	32
② Memory channel up or down	33

**(3) FUNCTIONS IN BOTH
DIAL AND MEMORY
MODES**

FUNCTION	PAGE
① Recalling the CALL CHANNEL	33
② Starting MEMORY SCAN	36
③ Starting the PRIORITY FUNCTION	34
④ Setting the LOCK ON/OFF FUNCTION	38

5-2 SETTING FREQUENCY

(1) USING DIGIT KEYS

1) To set an operating frequency, push the appropriate digit keys for the desired frequency, following the pattern below.

IC-12A/AT:

Press four digit keys beginning with the "10MHz" digit and ending with the "10kHz" digit.

IC-12E:

Press four digit keys beginning with the "10MHz" digit and ending with the 10kHz digit. The last digit key pushed enters the frequency as shown in the table below.

	[1]	[2]	[3]	[4]	[5]	[6]	[7]	[8]	[9]	[0]	UNIT
IC-12E	12.5	25.0	37.5	—	50.0	62.5	75.0	87.5	—	00.0	kHz

*A "—" indicates the key entry is cancelled, and the previous operating frequency is recalled.

(2) USING [▲] or [▼] KEY

1) With each push of the [#]/[▲] or [*]/[▼] key, the operating frequency will be changed one increment up or down with the specified frequency step rate respectively. See SECTION 5 - 3 SETTING FREQUENCY STEP RATE.

2) In the same way, holding the key down, shift the operating frequency up or down continuously.

[EXAMPLE 3] Setting the frequency with the frequency step rate pre-set at 20kHz (IC-12A/AT versions):

Press keys		▲ / + #	▲ / + #	▼ / - *	▼ / - *
Display	12 75.68	12 75.70	12 75.72	12 75.70	12 75.68

[EXAMPLE 4] Setting the frequency with the frequency step rate pre-set at 25kHz (IC-12E version):

Press keys		▲ / + #	▲ / + #	▼ / - *	▼ / - *
Display	12 75.68 ¹⁵	12 75.71 ₂₅	12 75.73 ¹⁵	12 75.71 ₂₅	12 75.68 ¹⁵

5 - 3 SETTING FREQUENCY STEP RATE

- 1) Push and hold the [FUNC] key, push the [3]/[STEP] key and then push a key to determine the step rate for setting the frequency step rate and release the [FUNC] key.
- 2) The frequency step rate allocated to each key is shown in the following table. If an illegal number has been entered, the number is cancelled and the previous rate number will be recalled.

	[1]	[2]	[3]	[4]	[5]	UNIT
IC-12A/AT	10.0	20.0	30.0	40.0	50.0	kHz
IC-12E	12.5	25.0	37.5	50.0	62.5	kHz

[EXAMPLE 5]

Setting the frequency step rate at 10kHz (IC-12A/AT version):

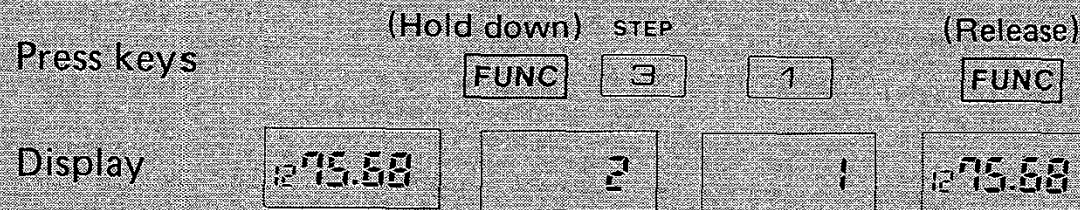

[EXAMPLE 6]

Setting the frequency step rate for 12.5kHz (IC-12E version):

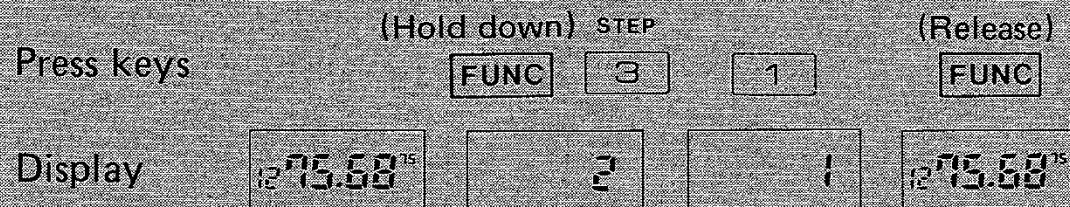

5 - 4 DUPLEX OPERATION

Transmit offset refers to the frequency difference between the receive and transmit frequencies when using DUPLEX MODE.

(1) SETTING THE OFFSET FREQUENCY

1) While pushing the [FUNC] key, push the [7]/[SHIFT] key, then the four digit keys of the desired offset frequency.

IC-12A/AT:

Offset frequency settings can be made in 10kHz steps.

IC-12E:

Offset frequency settings can be made in 12.5kHz steps. The last digit key pushed enters the frequencies shown in the table below.

2) If illegal digits have been entered, the digits are cancelled and the previous offset frequency will be recalled.





	[1]	[2]	[3]	[4]	[5]	[6]	[7]	[8]	[9]	[0]	UNIT
IC-12E	12.5	25.0	37.5	—	50.0	62.5	75.0	87.5	—	00.0	kHz

*A “—” indicates the key entry is cancelled, and the previous operating frequency is recalled.

[EXAMPLE 7] Setting the offset frequency at 10MHz:

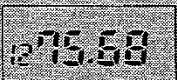
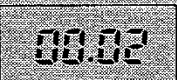
Press keys (Hold down) **SHIFT** (Release)

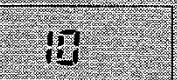
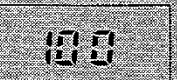
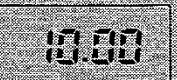
FUNC **7** **1** **0** **0** **0** **FUNC**

Display       

(2) SETTING DUPLEX MODE

- 1) While pushing the [FUNC] key, push either [*]/[-] for -duplex or [#]/[+] for +duplex to make a setting in DUPLEX MODE.
- 2) Either “—” or “+” indicator appears on the FREQUENCY DISPLAY.

[EXAMPLE 8] Setting the +duplex in DUPLEX MODE.

Press keys (Hold down) **▲ / +** (Release)

FUNC **#** **FUNC**

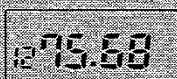
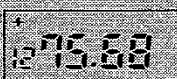
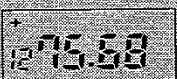
Display   

(3) CHANGING DUPLEX DIRECTION

- 1) To change the duplex direction (-duplex to +duplex or vice versa) with the previous frequency separation, push and hold the [FUNC] key and push the [*]/[-] or [#]/[+] keys with the same symbol that appears on the display.

To reverse the transmit and the receive frequencies in DUPLEX MODE, push and hold the [FUNC] key and push the [6]/[REVERSE] key. See [EXAMPLE 10].

[EXAMPLE 9] Changing the duplex direction:

	(Hold down)	▼ / -	(Release)	(Hold down)	▲ / +	(Release)
Press keys	[FUNC]	[*]	[FUNC]	[FUNC]	[#]	[FUNC]
Display						

[EXAMPLE 10] Reversing the transmit and receive frequencies in DUPLEX MODE with the offset frequency pre-set at 10MHz:

	(Hold down)	REVERSE	(Hold down)	REVERSE
Press keys	[FUNC]	[6]	[FUNC]	[6]
Display				

5 - 5 MEMORY WRITING

The IC-12A/AT/E can memorize a frequency, DUPLEX MODE, its offset frequency, and tone number into a memory channel.

- 1) Set the desired frequency, DUPLEX MODE, etc., with the procedures described previously.
- 2) While pushing the [FUNC] key, push the [B]/[MW] key, followed by a digit key which has the same number as the memory channel number.
- 3) The transceiver has 10 memory channels, memory channels 1 to 0. Some are special channels as described below.

●M1 (MEMORY CHANNEL 1)

The offset frequency for duplex operation in M1 is the offset frequency and subaudible tone frequency applied to memory channels M2 to M6. That is, M2 to M6 has the same offset and tone frequencies as those entered in M1.

●M2

No special function is available.

●M3

The frequency memorized in M3 can be recalled by pushing the [D]/[CALL] key.

●M4

The frequency memorized in M4 is the priority frequency in the PRIORITY FUNCTION. See SECTION 5 - 8 for further information.

●M5 and M6

The frequencies memorized in M5 and M6 are the limits of the PROGRAMMED SCAN range. Regardless of which channel the higher frequency is memorized in, the scan starts from the frequency memorized in M5.

●M7, M8, M9 and M0

The offset frequency and subaudible tone number can be memorized into each memory channel independently.

[EXAMPLE 11]

Memorizing the following information into memory channel 1 (M1):

- (1) Frequency 1272.02MHz
- * (2) Subaudible tone encoder frequency 88.5Hz
- (3) Offset frequency 10MHz
- (4) Operating mode –Duplex
- (5) Memory channel M1

*NOTE: IC-12AT version only

(1) Setting frequency at 1272.02MHz.

Press keys

7

2

0

2

Display

127

1272

12720

1272.02

Continued on the next page

(2) Setting the subaudible tone encoder frequency at 88.5Hz:

Press keys (Hold down) TONE
FUNC 1 0 8 (Release) FUNC

Display 12 72.02 01 0 08 12 72.02

(3) Setting the offset frequency at 10MHz:

Press keys (Hold down) SHIFT
FUNC 7 1 0 0 0 (Release) FUNC

Display 12 72.02 00.02 1 10 100 10.00 12 72.02

(4) Setting the DUPLEX MODE at -duplex:

Press keys ▼ / - (Release)
FUNC * FUNC

Display 12 72.02 12 72.02 12 72.02

(5) Memorizing the above information into M1:

Press keys (Hold down) MR/MW
FUNC B 1 (Release) FUNC

Display M 72.02 M 72.02 12 72.02



5 - 6 MEMORY READING

- 1) Push the [B]/[MR] key then a digit key corresponding to the same number as the memory channel that contains the desired frequency.

The DUPLEX MODE and the subaudible tone number (IC-12AT version only) also can be recalled at the same time if they have been memorized.



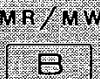

- 2) The "M" and the memory channel number appears on the FREQUENCY DISPLAY.

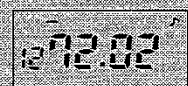
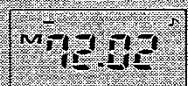
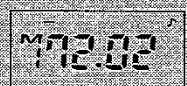
[EXAMPLE 12] Recalling the frequency memorized in M1:

Press keys  

Display   

[EXAMPLE 13] Changing memory channels:

Press keys    

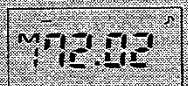
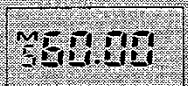
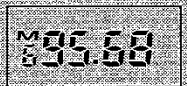
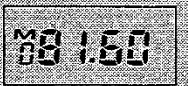
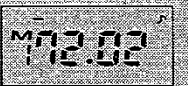
Display     

[EXAMPLE 14]

Changing memory channels using [▲] or [▼] key:

Press keys		▲ / + #	▲ / + #	▼ / - *	▼ / - *
Display	M72.02	M50.00	M88.06	M50.00	M72.02

● **[CL] KEY NOTES IN MEMORY MODE**

- 1) By pushing the [A]/[CL] key, MEMORY MODE is cleared and the transceiver returns to DIAL MODE.
- 2) While pushing the [FUNC] key, push the [A]/[CL] key. MEMORY MODE is then cleared and the information in the memory channel is transferred to DIAL MODE.

5 - 7 CALL CHANNEL OPERATION

When the transceiver is in either DIAL MODE or MEMORY MODE, push the [D]/[CALL] key to recall the CALL CHANNEL.

NOTE: At this time, all key functions except the [CL] and [LOCK] functions are disabled.

- 1) Push the [D]/[CALL] key. The letter "C" appears which indicates the CALL CHANNEL function is activated. The CALL CHANNEL recalls the frequency memorized in memory channel 3.
- 2) To clear the CALL CHANNEL function, push the [A]/[CL] key. The previously displayed frequency and memory channel numbers are recalled on the FREQUENCY DISPLAY.

[EXAMPLE 15]

Recalling the CALL CHANNEL memorized in M3:

Press keys

CALL/LOCK



Display

12 72.02

88.05

5 - 8 PRIORITY FUNCTION

While operating on a particular frequency you can use the PRIORITY FUNCTION to check another frequency such as a local repeater or calling frequency. This feature informs you whether the priority frequency is busy or not.

Observe the following steps to use the PRIORITY FUNCTION.

- 1) Memorize your favorite frequency into memory channel 4. Refer to SECTION 5 - 5 MEMORY WRITING.
- 2) Set the desired operating frequency by pushing keys or select a memory channel which has the desired operating frequency memorized.
- 3) Adjust the SQUELCH CONTROL to quiet the noise output from the speaker.

- 4) Push the [4]/[PRIO] key while pushing the [FUNC] key.
 - The transceiver receives on the operating frequency for a period of five seconds and on the priority channel for one second.
 - A dot appears above the decimal point to show the transceiver is in the PRIORITY FUNCTION.

NOTE: In the PRIORITY FUNCTION, all keys, except the [A]/[CL] key, are disabled.

- 5) If the transceiver is placed in the transmit mode during the PRIORITY FUNCTION, the transmit frequency will be the operating frequency. When returned to the receive mode, the PRIORITY FUNCTION will be continued.

- 6) To clear the PRIORITY FUNCTION, push the [A]/[CL] key.

[EXAMPLE 16]

Setting the PRIORITY FUNCTION at 1299.78MHz. The contents of M4 are as follows:

- Frequency 1296.70MHz
- Operating mode -Duplex

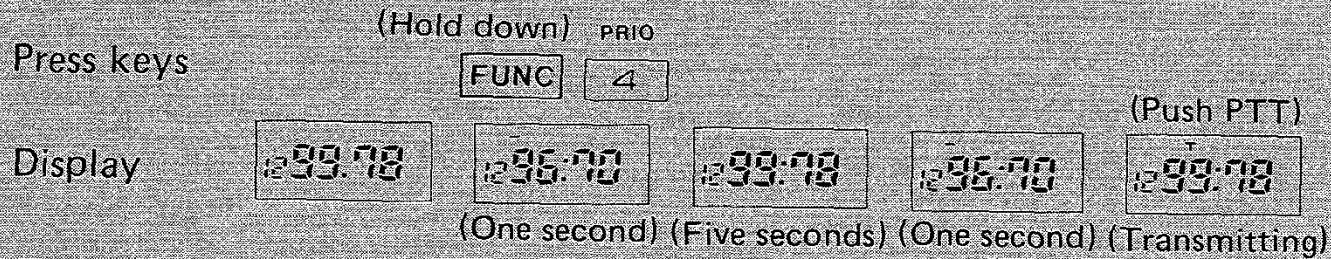

5 - 9 SCANNING OPERATION

The IC-12A/AT/E provides MEMORY SCAN and PROGRAMMED SCAN operations.

TYPE OF SCAN	FUNCTION
MEMORY SCAN	Continuously scans all ten memory channels in order.
PROGRAMMED SCAN	Scans between two desired frequencies that are memorized in M5 and M6.

(1) MEMORY SCAN

NOTE: When the transceiver is in MEMORY SCAN MODE, all keys except the [A]/[CL] key and the [C]/[MS] key are disabled.

- 1) Memorize ten desired frequencies into memory channels 1 to 0 (10).
- 2) Adjust the SQUELCH CONTROL to quiet the noise output from the speaker.
- 3) Push the [C]/[MS] key to start the scan.
 - The letter "S" appears on the FREQUENCY DISPLAY and the scan starts.
- 4) If the SQUELCH CONTROL is engaged, the scan stops when the squelch is opened and a signal is received. The scan will resume after the signal goes away.
- 5) To clear the scan function, push the [A]/[CL] key or PTT SWITCH, and the scan stops on the memory channel displayed.
 - The letter "S" on the FREQUENCY DISPLAY disappears.

[EXAMPLE 17]

Operating MEMORY SCAN:

Press keys

MS / PS

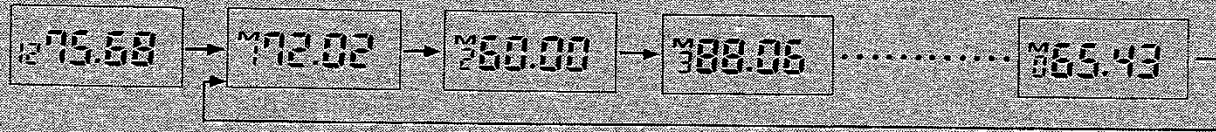

Display

**(2) PROGRAMMED SCAN**

NOTE: When the transceiver is in PROGRAMMED SCAN MODE, all keys except the [A]/[CL] key and the [C]/[PS] key are disabled.

- 1) Store the frequencies of the upper and lower limits of the desired scan range into either M5 or M6.
- 2) Set the IC-12A/AT/E in DIAL MODE by pushing the [A]/[CL] key if the transceiver is in MEMORY MODE.
- 3) Adjust the SQUELCH CONTROL to quiet the noise output from the speaker.
- 4) Push the [C]/[PS] key while pressing the [FUNC] key. The scan starts from the frequency memorized in M5 and moves towards the frequency memorized in M6.
 - The scanning frequency increments depend on the frequency step rate setting.
- 5) Any signal which opens the squelch when it is engaged stops the scan automatically and the transceiver locks onto the frequency.

- 6) To clear the scan function, push the [A]/[CL] or PTT SWITCH to revert to the transmit mode.
- The scan stops on the frequency displayed.
 - The letter "S" on the FREQUENCY DISPLAY disappears.

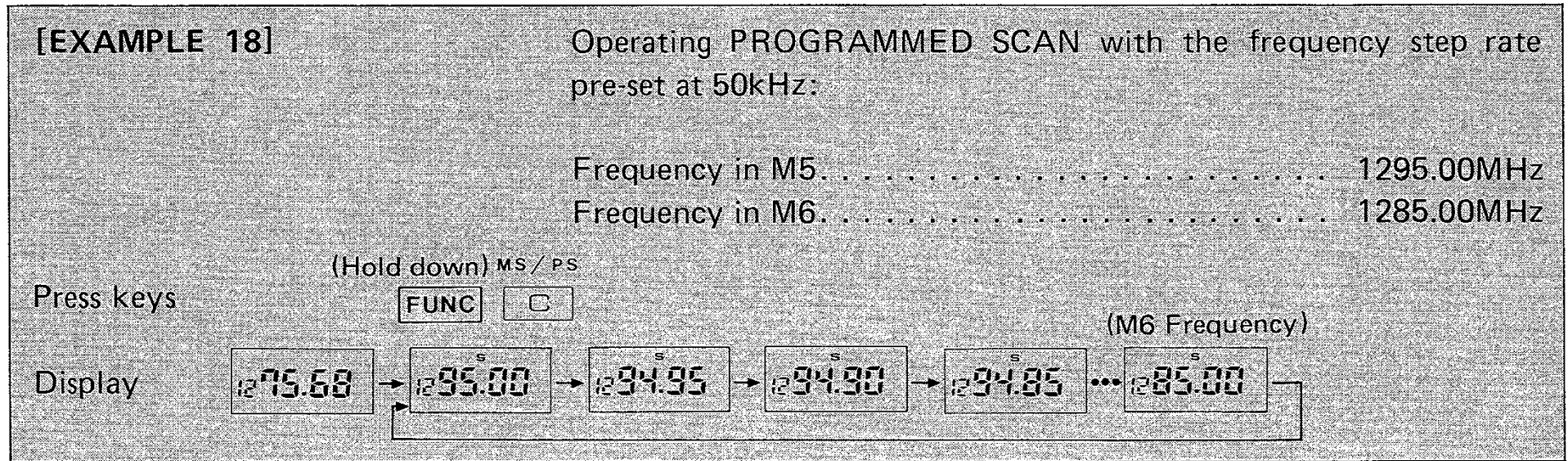

5 - 10 LOCK FUNCTION

This function prevents accidental frequency and function changes.

- 1) Push the [D]/[LOCK] key while pressing the [FUNC] key.
 - The letter "L" appears on the FREQUENCY DISPLAY.
 - At this time, all keys are disabled.
- 2) To clear the LOCK FUNCTION, push the [D]/[LOCK] key again while pressing the [FUNC] key.

5 - 11 BEEP TONE ON/OFF FUNCTION

- 1) Each push of the [9]/[BEEP] key while pressing the [FUNC] key turns the BEEP TONE FUNCTION ON and OFF alternately.
- 2) When the BEEP TONE FUNCTION is ON, the beep sounds each time a key is pushed. The volume of the beep tone can be adjusted by turning the VOLUME CONTROL.

5 - 12 DTMF OPERATION (IC-12AT only)

If you need DTMF tones to access a repeater or to make an auto phone-patch, follow the procedure below.

- 1) Push a key while pressing the PTT SWITCH, then continue to push keys without pressing the PTT SWITCH.
- 2) After pushing a key, the transmit mode is maintained for about one second.

5 - 13 SETTING SUBAUDIBLE TONE ENCODER FREQUENCY (IC-12AT only)

The supplied tone encoder allows access to repeaters which require a subaudible tone superimposed on the transmit signal in order to open the squelch circuit of the receiver at the repeater station.

- 1) While pushing the [FUNC] key, push the [1]/[TONE] key then the two digit keys for the tone number. Refer to the SUB-AUDIBLE TONE ENCODER FREQUENCY TABLE as shown on page 41.

The “♪” indicator appears on the FREQUENCY DISPLAY while the tone encoder is being activated.

- 2) If an illegal number has been entered, the number is cancelled and the previous number will be recalled.
- 3) To turn OFF the tone encoder, push the [1]/[TONE] key while the [FUNC] key is pushed. The "♪" indicator will disappear.

[EXAMPLE 19]

Setting the subaudible tone encoder frequency at 88.5Hz (IC-12AT version only):

See table below:

Press keys		FUNC	TONE 1	0	8	(Release) FUNC
Display	1275.68		01	0	08	1275.68

[EXAMPLE 20]

Turning the subaudible tone encoder ON/OFF (IC-12AT version only):

Press keys		(Hold down) FUNC	TONE 1	(Hold down) FUNC	TONE 1	(Release) FUNC
Display	1275.68	1275.68		08		1275.68

• SUBAUDIBLE TONE ENCODER FREQUENCY TABLE

TONE NUMBER	FREQUENCY (Hz)	TONE NUMBER	FREQUENCY (Hz)	TONE NUMBER	FREQUENCY (Hz)
01	67.0	14	107.2	27	167.9
02	71.9	15	110.9	28	173.8
03	74.4	16	114.8	29	179.9
04	77.0	17	118.8	30	186.2
05	79.7	18	123.0	31	192.8
06	82.5	19	127.3	32	203.5
07	85.4	20	131.8	33	210.7
08	88.5	21	136.5	34	218.1
09	91.5	22	141.3	35	225.7
10	94.8	23	146.2	36	233.6
11	97.4	24	151.4	37	241.8
12	100.0	25	156.7	38	250.3
13	103.5	26	162.3	---	---

**5 - 14 TRANSMITTING
TONE-BURST**

The IC-12E is equipped with a 1750Hz tone generator. Press the TONE-BURST SWITCH on the side of the transceiver if a tone-burst for initial access to a repeater is needed. Most repeaters need between 100 milliseconds and 2 seconds to be opened.

SECTION 6 MAINTENANCE

6 - 1 CLEANING

The IC-12A/AT/E will eventually require cleaning after sitting in your ham shack for a period of time. Use a soft cloth with a mild, soapy solution. DO NOT use strong chemicals or cleaning solvents.

6 - 2 MALFUNCTIONS

(1) UNLOCKED PLL



"U" appears

If a small "U" appears on the FREQUENCY DISPLAY as shown at the left, the PLL (Phase-Locked Loop) circuit in the transceiver is unlocked.

At this time, the transceiver is muted and no signals are transmitted. This unlocked condition may be caused by an exhausted battery pack, so check your battery pack first.

(2) RESETTING INTERNAL MICROCOMPUTER (CPU)

NOTE: After resetting the CPU, all information you have programmed into the memory channels will be cleared and memory channels must be re-programmed.

Occasionally, the FREQUENCY DISPLAY may display erroneous information either during operation or when first applying power. This may, for example, be due to an external cause such as static electricity.

When this sort of problem occurs, simply reset the internal CPU according to the following procedures:

- 1) Rotate the POWER/VOLUME CONTROL counterclockwise to the OFF position.
- 2) Hold down the [FUNC] key. Rotate the POWER/VOLUME CONTROL clockwise beyond the "click" to the ON position.
- 3) The CPU is now reset. All memory channel frequencies and the displayed frequency are reset at their initialized values.

(3) CPU BACKUP BATTERY

The IC-12A/AT/E uses an advanced, highly reliable CPU which is a complete, self-contained microprocessor. The purpose of the battery is to provide power to the CPU so it retains all memory information during power failures, or if the power pack is detached or turned OFF.

The usual life of the backup battery is approximately five years. Monitor the backup battery carefully and replace it if there are repeated cases of display malfunction.

NOTE: Battery replacement must be done by your nearest authorized ICOM Service Center.

SECTION 7 INSIDE VIEWS

7-1 MAIN UNIT

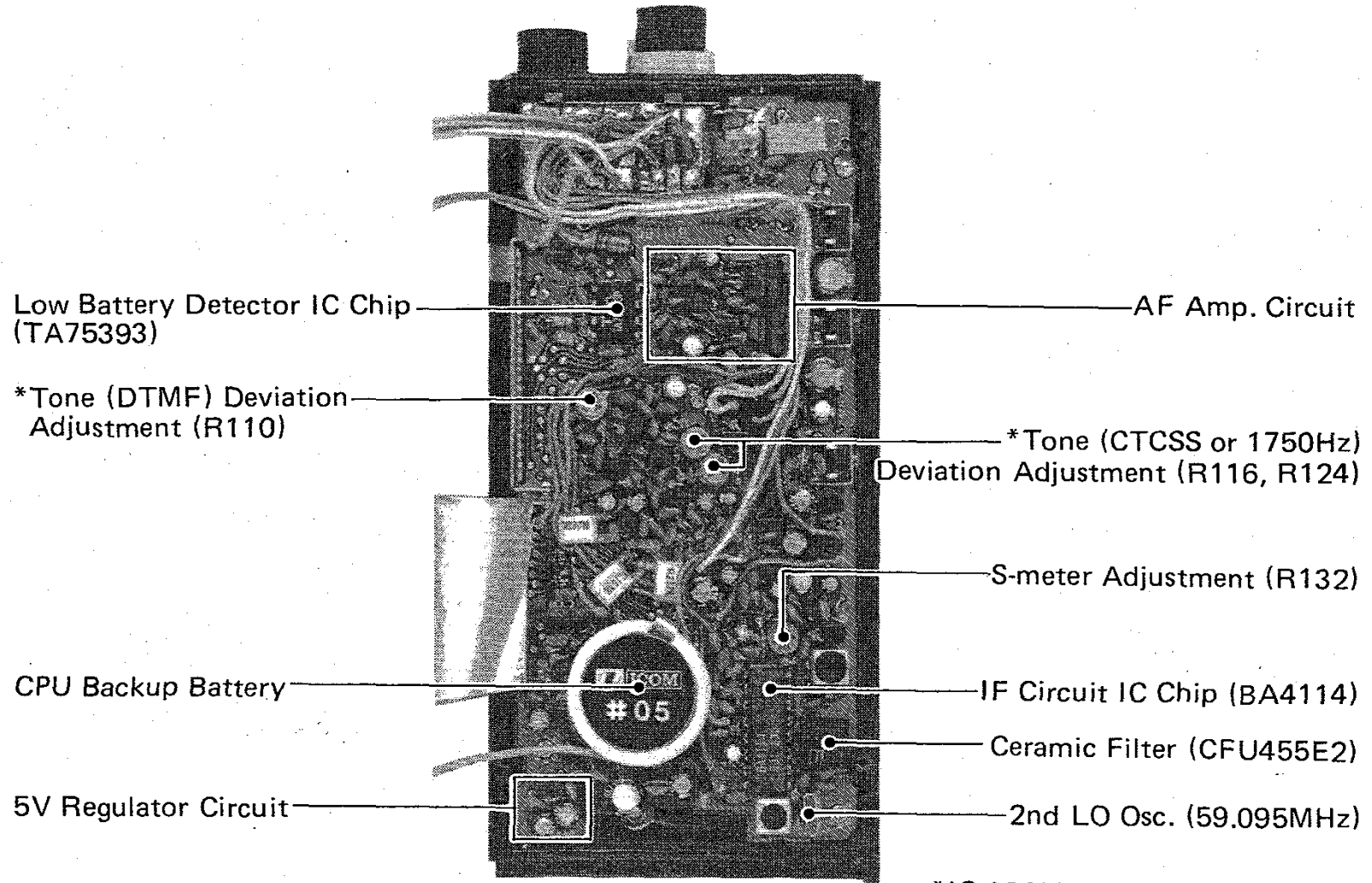

Low Battery Detector IC Chip (TA75393)

*Tone (DTMF) Deviation Adjustment (R110)

CPU Backup Battery

5V Regulator Circuit

AF Amp. Circuit

*Tone (CTCSS or 1750Hz) Deviation Adjustment (R116, R124)

S-meter Adjustment (R132)

IF Circuit IC Chip (BA4114)

Ceramic Filter (CFU455E2)

2nd LO Osc. (59.095MHz)

*IC-12AT version only

7 - 2 PLL UNIT

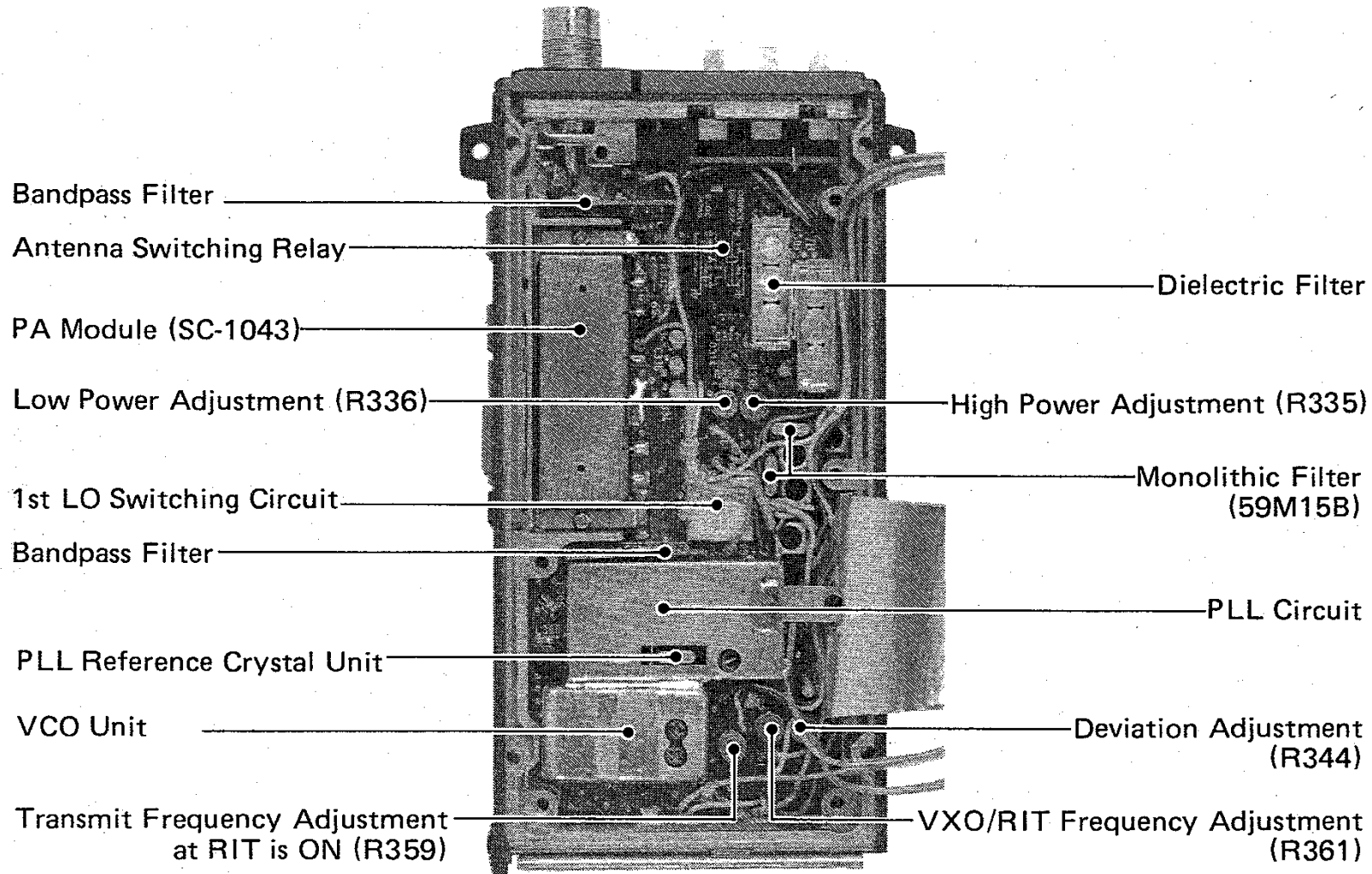

*Misadjusting certain components may damage the transceiver.

7-3 TONE UNIT (IC-12AT/E version only)

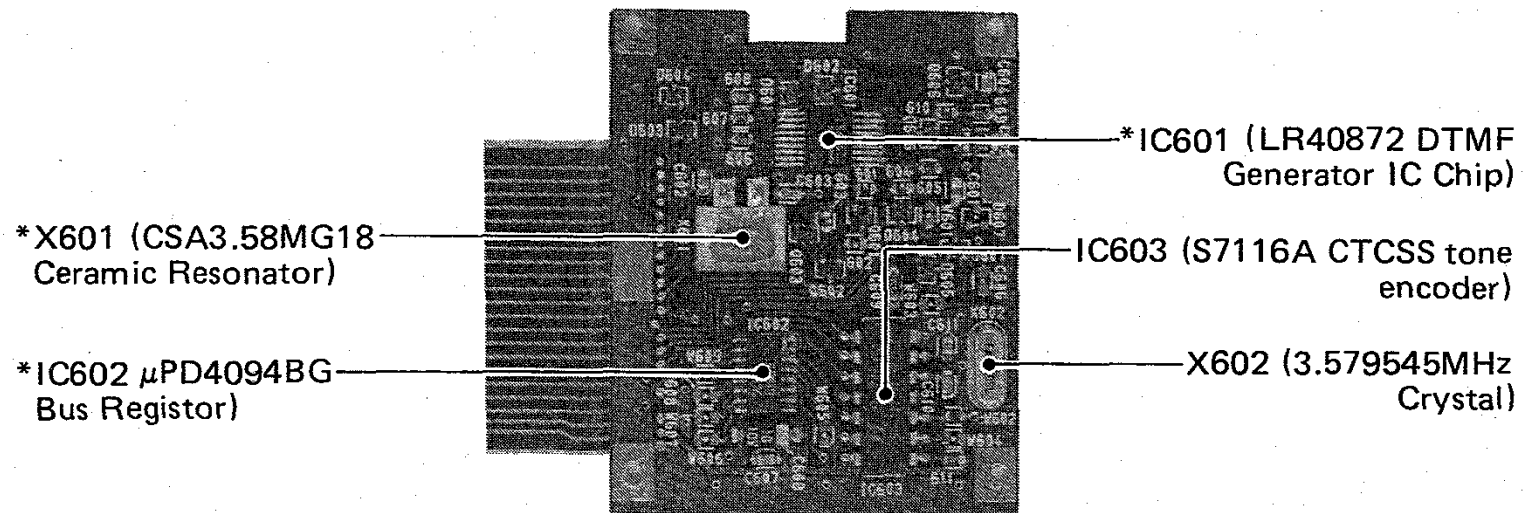

*IC-12AT version only

SECTION 8 TROUBLESHOOTING

Your IC-12A/AT/E has been tested very carefully at the factory before shipping. The chart below has been designed to help you correct any problems which are not equipment malfunctions. If you are not able to locate the problem and solve it by using this chart, please contact your dealer or the nearest authorized ICOM Service Center for assistance.

PROBLEM	POSSIBLE CAUSE	SOLUTION
1. Power does not come ON when the [PWR] switch is turned.	<ul style="list-style-type: none">• Bad connection of the battery pack to the transceiver.• The battery pack is exhausted.	<ul style="list-style-type: none">• Check the connection of the battery pack and correct any problems.• Replace the battery pack with a new one or recharge it.
2. No sound comes from the speaker.	<ul style="list-style-type: none">• [PWR/VOL] CONTROL is completely counterclockwise.• The transceiver is in the transmit mode, by the PTT SWITCH.• Squelch setting is turned too far clockwise.	<ul style="list-style-type: none">• Turn the [PWR/VOL] control clockwise to a suitable level.• Put the transceiver in the receive mode.• Turn the [SQL] control counterclockwise until noise can be heard. Turn clockwise so the noise just disappears.

PROBLEM	POSSIBLE CAUSE	SOLUTION
2. No sound comes from the speaker.	<ul style="list-style-type: none"> • External speaker or earphone is in use. • The battery pack is exhausted. 	<ul style="list-style-type: none"> • Check if the external speaker plug is inserted properly or if the external speaker cable is cut. • Replace the battery pack with a new one or recharge it.
3. Receive sensitivity is low and only strong signals are audible.	<ul style="list-style-type: none"> • Bad connection of the flexible antenna. • The antenna feedline is cut or shorted. (When using an external antenna.) 	<ul style="list-style-type: none"> • Check the connection of the antenna and correct any problems. • Check the feedline and correct any improper condition.
4. No or low power output.	<ul style="list-style-type: none"> • RF POWER OUTPUT SELECTOR SWITCH is at the [LOW] position. • The battery pack is exhausted. • The antenna feedline is cut or shorted. (When using an external antenna.) 	<ul style="list-style-type: none"> • Set the RF POWER OUTPUT SELECTOR SWITCH to [HIGH] position. • Replace the battery pack with a new one or recharge it. • Check the antenna feedline and correct any problems.
5. No modulation. (When using an external microphone.)	<ul style="list-style-type: none"> • Bad connection of the microphone plug. 	<ul style="list-style-type: none"> • Check the connection of the microphone plug and correct any problems.

PROBLEM	POSSIBLE CAUSE	SOLUTION
<p>6. The receive mode functions properly and your signals are transmitted, but you are unable to make contact with another station.</p>	<ul style="list-style-type: none"> • The transceiver is in DUPLEX MODE. (When desiring SIMPLEX MODE) • The transceiver is in SIMPLEX MODE. (When desiring DUPLEX MODE) • Improper offset frequency or input/output frequencies of the repeater. 	<ul style="list-style-type: none"> • Clear the DUPLEX MODE by pushing either [*]/[-] key or [#]/[+] key while pressing the [FUNC] key in DIAL MODE. • Set the proper offset frequency according to the repeater input/output frequencies. • Set the proper offset frequency according to the repeater input/output frequencies.
<p>7. PROGRAMMED SCAN does not function.</p>	<ul style="list-style-type: none"> • The transceiver is in MEMORY MODE. • The frequencies memorized in M5 and M6 are the same, or their difference is less than the frequency step rate. 	<ul style="list-style-type: none"> • Push the [A]/[CL] key to set in DIAL MODE. • Memorize frequencies with a larger step rate than those currently set in M5 and M6.
<p>8. All key functions are disabled.</p>	<ul style="list-style-type: none"> • The LOCK FUNCTION is engaged. • The CALL FUNCTION is engaged. 	<ul style="list-style-type: none"> • Clear the LOCK FUNCTION by pushing the [D]/[LOCK] key while pressing the [FUNC] key. • Clear the CALL FUNCTION by pushing the [A]/[CL] key.

SECTION 9 BLOCK DIAGRAM

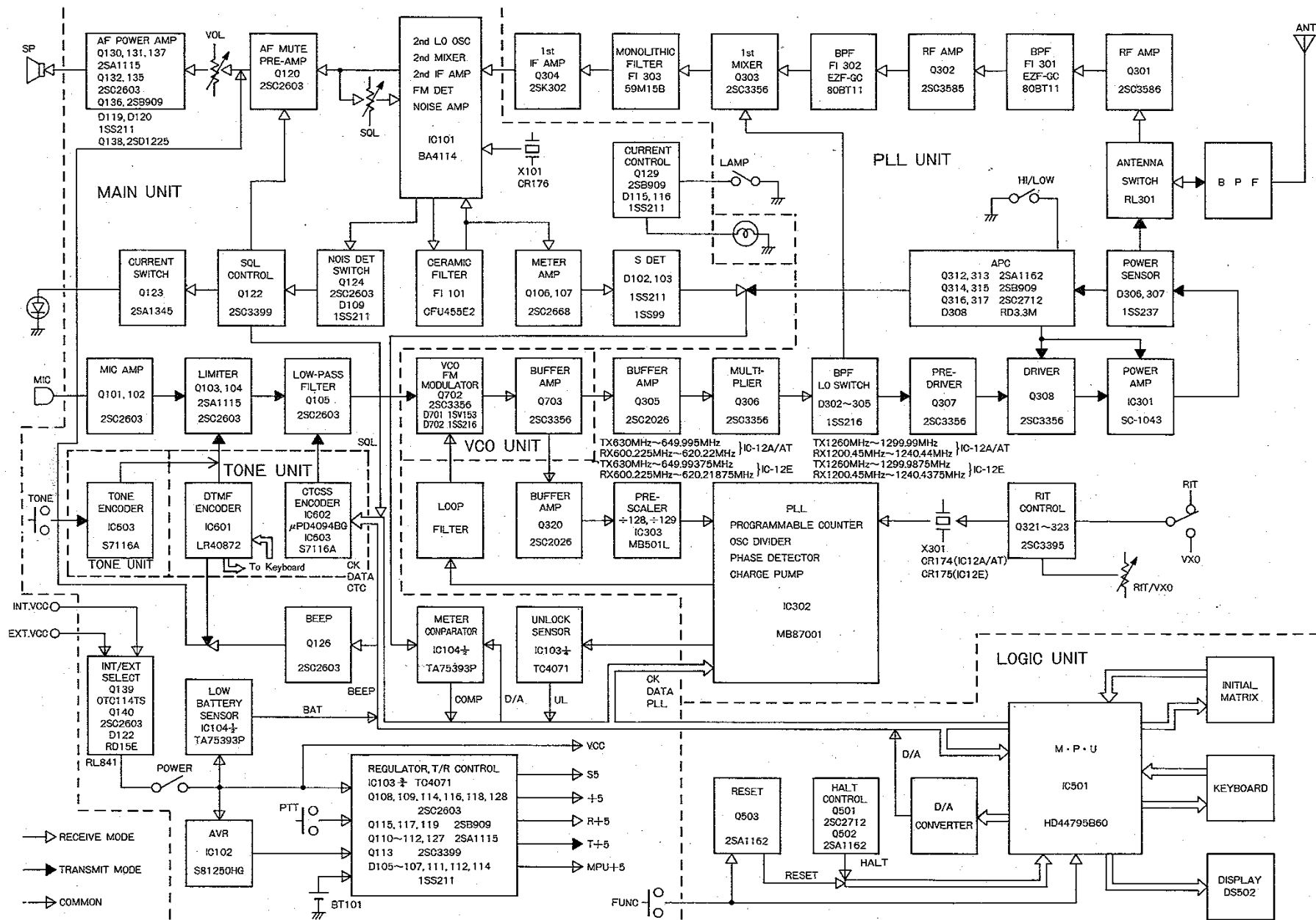

SECTION 10 SPECIFICATIONS

10 - 1 GENERAL

- Frequency coverage : IC-12A/AT 1260.00 ~ 1299.99MHz
IC-12E 1260.00 ~ 1299.9875MHz
- Antenna impedance : 50 ohms unbalanced
- Usable temperature : $-10^{\circ}\text{C} \sim +60^{\circ}\text{C}$
- Frequency stability : $\pm 5\text{ppm at } 0^{\circ}\text{C} \sim +50^{\circ}\text{C}$
- Current drain at 8.4V DC : Receiving Squelched Approx. 65mA
At max. audio output Approx. 250mA
Transmitting HIGH (1W) Approx. 900mA
LOW (0.1W) Approx. 400mA
- Dimensions (with IC-BP3) : 65(76)W x 171(182.5)H x 35.5(42.5)D mm
Bracketed values include projections.
- Weight : 610g

10 - 2 TRANSMITTER

- Output power : HIGH 1W LOW 0.1W
- Emission mode : F3E (16K0F3E)
- Modulation system : Variable reactance frequency modulation
- Max. frequency deviation : $\pm 5\text{kHz}$
- Spurious emission : More than 50dB below carrier

10 - 3 RECEIVER

- Modulation acceptance : F3E (16K0F3E)
- Sensitivity : Less than $0.32\mu\text{V}$ for 12dB SINAD
- Squelch sensitivity (Threshold) : Less than $0.1\mu\text{V}$
- Spurious response rejection ratio : More than 50dB
- Audio output power : More than 500mW at 10% distortion under 8 ohm load
- Audio output impedance : 8 ohms
- Receiving system : Double-conversion superheterodyne
- Intermediate frequencies : 1st 59.55MHz 2nd 455kHz

