



IC-215

TRANSCEIVER
PORTABLE
2 METER FM



INSTRUCTION
MANUAL



ICOM

TABLE OF CONTENTS

I. INTRODUCTION	1
II. SPECIFICATIONS	2
III. ACCESSORIES	3
IV. PRE-OPERATION	4
V. DESCRIPTION OF CONTROLS AND CONNECTIONS	7
VI. OPERATION	9
VII. CIRCUIT DESCRIPTION	10
VIII. INSIDE VIEW	12
IX. VOLTAGE CHARTS	13
X. BLOCK DIAGRAM	15
XI. PARTS LIST	16

SECTION I INTRODUCTION

FM Portable Transceiver

Small and light. Handy for use any time, whether outdoors, in a car or at home. With 3W output and a sensitive receiver, it can work as well as large transceivers when used in good locations or with high-performance antenna.

Aluminum Die-cast Frame

The IC-215 chassis and frame are integrated into an aluminum die-casting. It's light but resistant to vibration or shock when carried. High mechanical performance is insured.

15 Channels

The unit incorporates 15 channels to select from; 12 by channel selector and 3 by Function switch. Each channel (TX and RX) uses the standard ICOM crystal configuration.

Dual Power Level

Transmitter output can be switched easily in 2 steps; 3W output HI for long distances, and 0.5W LOW for short distances. Battery consumption is minimized in the Low Power Mode.

Dial Illumination

The dial can be illuminated to facilitate night operation. This is controlled by a selector switch.



Power Pilot Lamp

If the power source voltage drops under the required value, the pilot lamp goes out as an indication the batteries are almost exhausted or external power is inadequate.

External Power and Antenna Terminals

For fixed stations or car mounted use, terminals for both external power and antenna are provided.

IC-20L and IC-3PS

Our ten-watt linear amplifier IC-20L and AC power supply IC-3PS can be used in combination as a completed fixed station.

SECTION II SPECIFICATIONS

General:

Number of semi-Conductors	Transistors	36
	FET	3
	IC	3 (2)
	Diodes	51
Frequency Coverage	144~146 MHz (146~148 MHz)	
Antenna Impedance	50 ohms unbalanced	
Power Supply Requirements	DC 13.8V±15% Negative Ground 800mA max	
Current Drain	Transmitting:	HI: approx. 750mA LOW: approx. 350mA
	Receiving:	At max audio approx. 270mA Squelched approx. 55mA
	Dial Light:	Approx. 40mA increase
Dimensions	183mm(H) x 61mm(W) x 162mm(D)	
Net Weight	2.0KGs including batteries.	

TRANSMISSION:

Transmitting Frequency	15 channels in 144 MHz band	
Emission	F3	
Transmission Power	HI	: 3W
	LOW	: 0.5W
Max. Frequency Deviation	5 KHz	
Modulation System	Variable reactance phase modulation	
Multiplication	8 Times	
Spurious Emission	-60dB below carrier	
Microphone	Impedance:	600 ohms
	Input level:	10mV typical
	Dynamic or optional Electret condenser microphone	

RECEPTION:

Receiving Frequency	15 channels in the 144MHz band	
Modulation Acceptance	16 F3	
Receiving System	Double super heterodyne	
Intermediate Frequency	First IF	10.7 MHz
	Second IF	455 KHz
Sensitivity	Less than 0.5 μ V for 20dB Noise quieting Better than 30dB S+N+D/N+D at 1 μ V	
Squelch Sensitivity	Less than 0.3 μ V	
Spurious Response Rejection Ratio	More than 60dB	
Selectivity	± 7.5KHz	At the -6dB point
	± 15KHz	At the -60dB point
Audio Output	More than 1W	
Audio Output Impedance	8 ohms	

Note: () Values for USA version.

SECTION III ACCESSORIES

Various accessories are packed with your transceiver. Be sure not to overlook anything. Also it's a good idea to keep packing cartons in case of moving or if return for service is necessary.

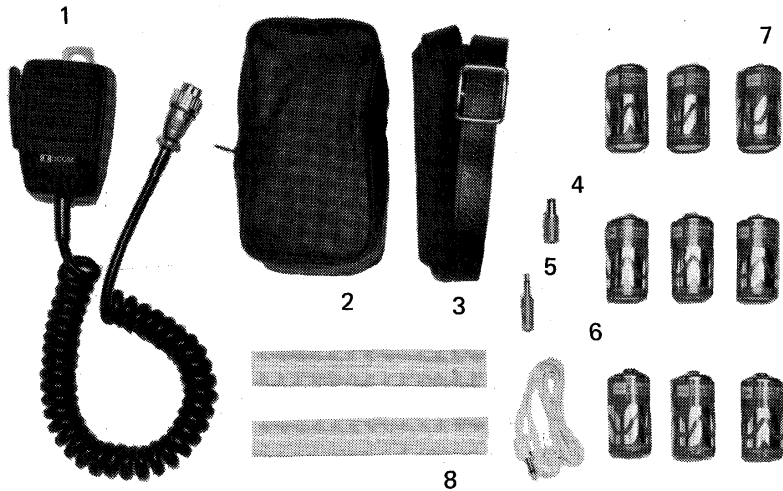

- | | | | |
|-----------------------|---|-----------------------|---|
| 1. Dynamic Microphone | 1 | 5. Ext. Speaker Plug | 1 |
| 2. Microphone Case | 1 | 6. Earphone | 1 |
| 3. Shoulder Strap | 1 | 7. Dry Cells Type "C" | 9 |
| 4. Power Supply Plug | 1 | 8. Battery Tubes | 2 |

How to fit the shoulder strap

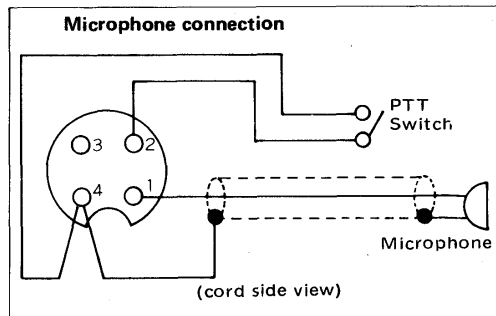
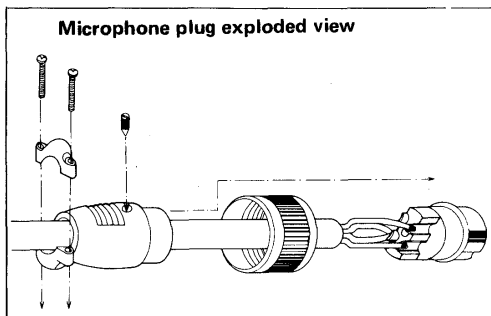
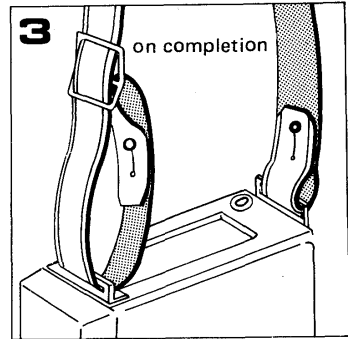
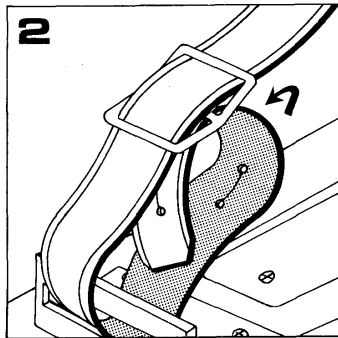
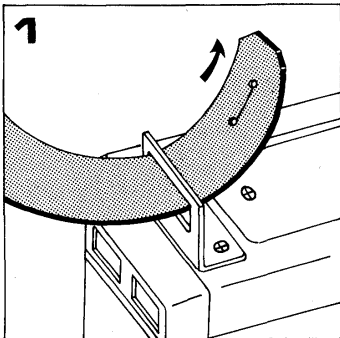

SECTION IV PRE-OPERATION

BATTERY INSTALLATION

Dry Battery:

Place the function switch in the OFF position. Remove the side that covers the battery case and speaker. Install the batteries into the battery tubes (three in each) taking care to observe the same direction (polarity).

Carefully install the battery tubes in the manner shown in photograph 1, placing the last three batteries in the inner column. Again take care to observe polarity, and place the battery tubes on top of the ribbon so when the batteries need to be removed, a simple pull on the ribbon will make removal easier. With the batteries properly in place, carefully replace the side cover.

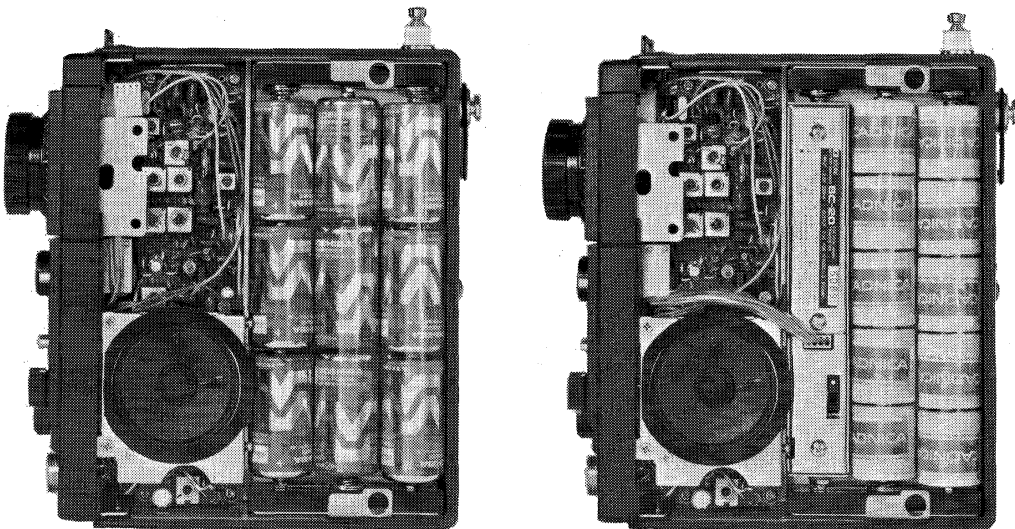
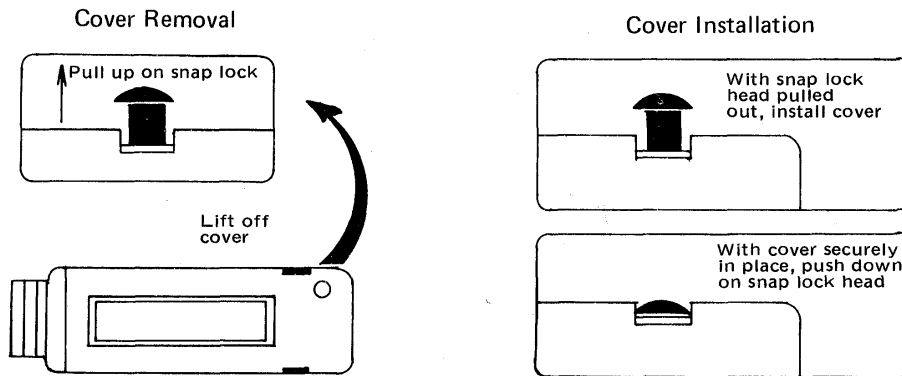

Nickel-Cadmium Batteries and Charger:

First, install the charger in the battery case (the speaker side) of the transceiver housing as shown in photograph 2. The polarity of the switch end of the charger must be positive and on the case side, negative. Accordingly the negative polarity must be connected to the spring side of the battery case.

Next, install five nickel-cadmium batteries in the battery tubes in the same direction. Make certain the (-) minus side is next to the spring. After installation of the charger and batteries in the case, connect the connector to the socket of the charger (i.e., the connector from the transceiver housing). Make sure the switch of the charger is on, then install the cover housing as before.

WHEN TO REPLACE BATTERIES

When the power pilot lamp does not light up with the power switch on, or when it lights up during reception and goes out during transmission, the batteries are exhausted. Use batteries of the same type, for mixed types might cause leakage. Replace worn batteries with a complete new set of nine. If used with old batteries, the life of new ones might be shortened more by transmitting than by receiving, since several times more current is drawn in transmit. To prolong battery life, therefore, practice as follows:

- * Try to minimize the transmit period.
- * Keep the transmission output on LOW as much as possible.
- * Reduce volume during reception.
- * Be sure to cut off power source when set is not used.

More working hours are available if high-performance batteries such as Alkaline type are employed.

EXTERNAL POWER PLUG CONNECTION

External Power Source

For use at home or in the car, please use the external power source which assures you of stable communication without concern about battery consumption.

1. Use either a regulated power supply or car battery of 13.8V DC and of over 1A current capability. (Though this transceiver may work at 11 to 15V DC, use it preferably at the rated voltage.)
2. Correctly connect the external supply plug, as shown in figure. If polarity is reversed, source power is cut off by the protection circuit and the unit will not operate.
3. When the transceiver is kept out of use for a prolonged period, the unit is operated for extended periods by external power only, or when the batteries are exhausted etc., remove the batteries to protect the unit from possible damage by battery leakage.
4. The outside electrode of the power plug is + (Positive). Be careful not to short the plug to the chassis frame, etc. When used in the car, don't short the plug to the car body or to the transceiver body itself, but connect it to the battery through its fuse (1A-2A).

External DC Plug Wiring Diagram



FOR OUTDOOR USE

1. Insert the supplied batteries. (Refer to "How to insert batteries").
2. Attach the supplied shoulder strap through the fixture of the body (as shown in the drawings on page 3).
3. Fully extend the whip antenna for operation, or install the flexible antenna. Keep the collapsible antenna depressed when the set is not in use so that it will not be damaged.

FOR USE IN THE CAR

1. Don't place the unit near the outlet of heaters, air-conditioners, etc.
2. Install the unit in a convenient place to avoid disrupting safe driving.
3. For the best power source, connect to the car battery through the fuse (1A-2A).
4. Firmly ground to the car body a mobile antenna (e.g. whip antenna) that requires grounding.

Mobile cable connection

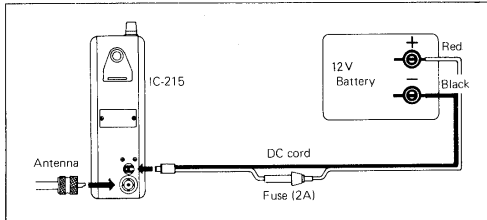

Connection using IC-20L

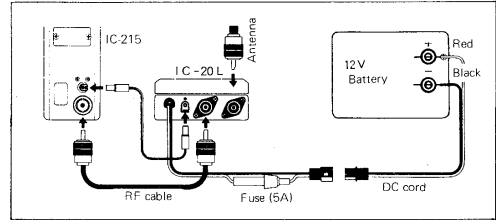

FOR FIXED USE

1. Don't install the unit in places exposed to rain, water splash, direct sunshine, dust, vibration, or heat.
2. Use a high performance external antenna as recommended. When doing this, be sure to depress the whip antenna into the body.
3. For fixed use, an external power supply is more economical than batteries.
4. Use of the linear amplifier IC-20L and AC power supply IC-3PS give excellent performance for fixed use.

HOW TO USE EXTERNAL ANTENNA

1. Select a high performance antenna (a multi-element beam or gain antenna) and set it up in the highest possible position. Tightly connect the antenna so that performance will not be affected by weather or vibration. The matching impedance is designed to be 50Ω.

SECTION V DESCRIPTION OF CONTROLS AND CONNECTIONS

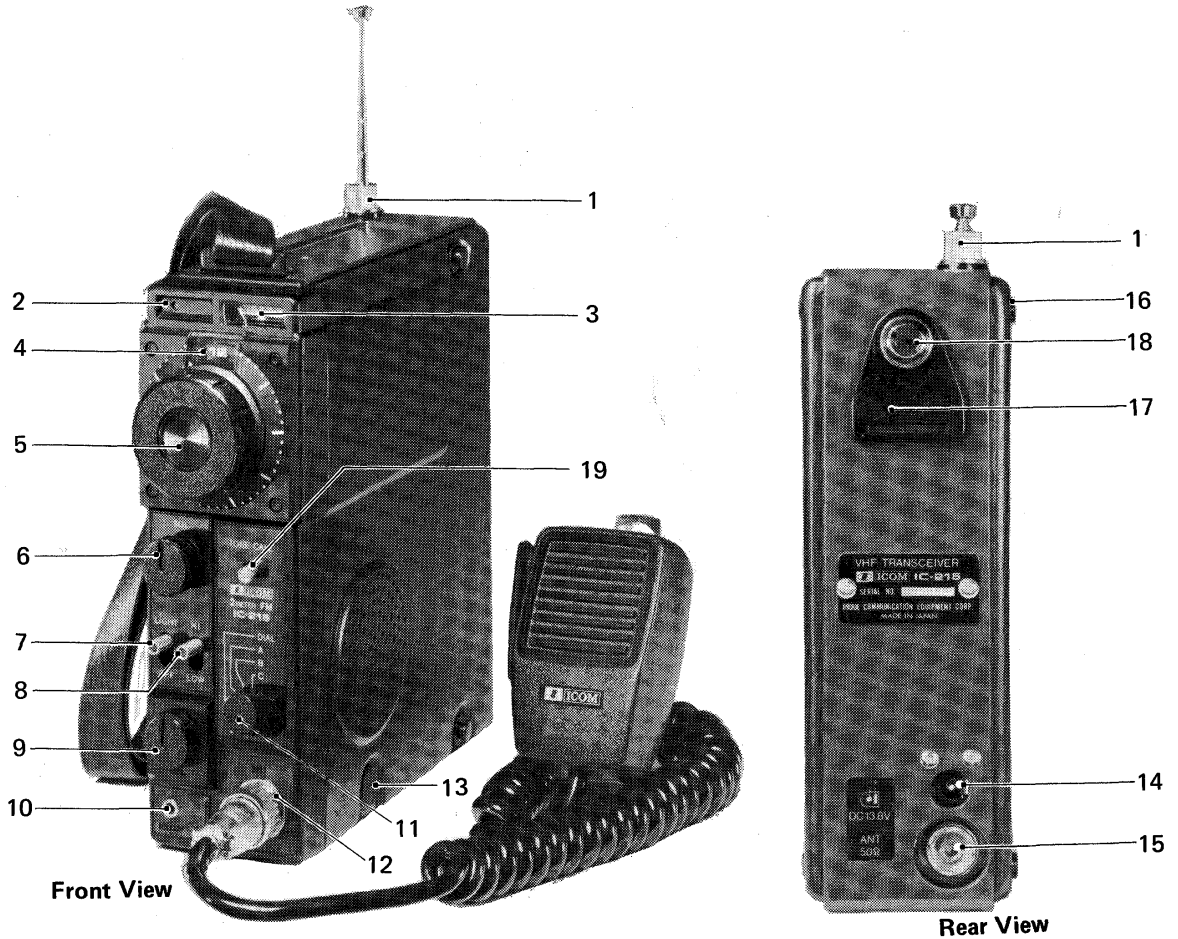

1. Whip Antenna

A fully collapsible antenna for transmission and reception is built-in. For outdoor operation, fully extend this antenna. A flexible helical antenna can also be installed.

2. Power Pilot Lamp

Lights up when power is on. Brightness varies according to source voltage to indicate battery condition.

3. Meter

Indicates received signal strength during reception, and output level during transmission.

4. Channel Indicator

Indicates operating channels by numbers 1 – 12.

5. Channel Selector

Selects frequencies for transmission and reception.

6. Squelch (SQL) Knob

Adjusts squelch threshold point. Turning clockwise tightens squelch. With squelch set at point just beyond where no noise is heard when no signal is present, the transceiver is at the most sensitive squelch point.

- 7. Light Switch**
With this switch turned on, the channel indicator and meter are illuminated for use at night.
- 8. Power Change-over Switch**
HI makes transmission output 3W and LOW makes it 0.5W.
- 9. Volume (VOL) Knob**
Regulates receiving volume. Turning it clockwise increases volume.
- 10. External Speaker Jack (EXT SP)**
External speaker (8 ohm), earphone, etc. may be connected to this jack. This connection disables the internal speaker.
- 11. Function Switch**
Turning it OFF cuts off the power. Turning it to DIAL enables operation at the frequency indicated by channel indicator. Turning to A B or C enables operation on your favorite frequencies not indicated by channel indicator.
- 12. Microphone Plug Socket (MIC)**
Connect attached microphone to this socket. A "PUSH TO TALK" switch is provided on the microphone.
- 13. Discriminator Meter Jack**
Remove rubber bushing and connect a zero center meter to this jack. Use a meter having about 1K ohm internal resistance and $\pm 50\mu A$ sensitivity.
- 14. External Power Jack**
Polarity is positive on outside of plug. Inserting plug into this jack enables a changeover to recommended external power even with batteries installed.
- 15. External Antenna Socket**
Connect on external antenna here. Impedance is 50 ohm. When external antenna is used, be sure to fully depress the built-in whip antenna.
- 16. Cover Snaps**
To remove the covers, pull out on the snap heads and withdraw cover from body. To replace cover, place it over body with the snap heads out, then lock the cover by pushing in the heads.
- 17. Shoulder Belt Fixture**
Attach the supplied shoulder belt to transceiver through this fixture.
- 18. Microphone Hook**
The hand-held microphone may be placed here during reception or when microphone is not used.
- 19. Tone Call Button (European Version Only)**
Actuates the tone burst circuit for repeater operation.

SECTION VI OPERATION

PREPARATIONS

Before turning on the power source, confirm as follows:

1. Make sure batteries are properly inserted.
When external power source is employed, make sure it is properly connected.
2. Make sure antenna is properly set.
When external antenna is employed, make sure whip antenna is depressed into the body and external antenna is firmly connected.
3. Make sure microphone is properly and tightly connected.

Set controls as follows:

- * Function switch OFF
- * Volume (VOL) knob Full counterclockwise
- * Squelch (SQL) knob Full counterclockwise
- * Light switch OFF
- * Power change-over switch LOW

Set the channel selector to any channel which has crystals installed.

RECEPTION

Turn the function switch clockwise to DIAL; the power source pilot lamp then lights up to show the power is on. If the light switch is set to LIGHT, the channel indicator and meter are illuminated to facilitate night operation.

VOLUME

If the volume (VOL) knob is slowly turned clockwise, noise or sound can be heard. Set where adequate volume is obtained. The meter shows deflection according to the strength of the signal.

SQUELCH

Turn Adjusts squelch (SQL) knob slowly clockwise. Noise becomes inaudible just past the threshold point. If the control is set at this point, audio can be heard only when signals are present. In cases when squelch is unstable (mobile operation, weak signal etc), adjust the squelch knob further until the proper threshold is obtained.

TRANSMISSION

The MIC controls transmission with the PTT switch. You may select high or low power to suit your needs and observe that the meter deflection gives a relative indication of output.

ADDING MORE CHANNELS AND FREQUENCY ADJUSTMENT

To add channel frequencies, refer to the crystal placement guide instructions below.

1. The crystal unit is HC-25/U type which oscillates in the fundamental mode.

$$\text{Receiving crystal oscillator frequency} = \frac{\text{receiving frequency} - 10.7}{9} \text{ (MHz)}$$

$$\text{Transmitting crystal oscillator frequency} = \frac{\text{transmitting frequency}}{8} \text{ (MHz)}$$

Note: CL is 20pF, with regard to the crystal load capacitance.

2. To adjust by a frequency counter (capable of measuring 130 to 150 MHz), do as follows:
 - a) Receiving frequency adjustment:
Connect the frequency counter to J8 and adjust the RX trimmer so that the frequency reading is receiving frequency minus 10.7MHz.
 - b) Transmitting frequency adjustment:
Short the frequency counter lead wire at the end and bring it close to the antenna connector to pick up the RF output. Adjust the TX trimmer to the desired frequency.

COMBINED USE OF LINEAR AMPLIFIER IC-20L AND AC POWER IC-3PS

IC-20L is a linear amplifier which amplifies the IC-215 output of 3W up to 10W. IC-3PS is an AC power supply which serves also as a stand with IC-20L mounted inside and is designed to fully attain functions as a fixed transceiver when used in combination with the IC-215.



SECTION VII CIRCUIT DESCRIPTION

GENERAL

The IC-215 employs a dual conversion Superheterodyne receiver. MOS, FET devices are used for RF amplification and First Mixer. The first IF is 10.7MHz with a monolithic crystal filter. The second IF is 455KHz with two cascaded ceramic filters. This system results in a very selective and sensitive receiver.

The transmitter section employs a quality audio amplifier using IDC (Instantaneous Deviation Control) technique and well-shaped pre-emphasis. The transmit frequency is derived from an 18MHz range crystal oscillator and phase modulation multiplied 8 times. Multiplier and amplifier circuits are designed and tuned for extremely low spurious and harmonic content.

RECEIVER

Antenna input or self contained antenna signals pass through switching diode D40, located in the PA section to the RF amplifier Q2 from which the amplified signal is injected into gate 1 of the first mixer Q3. Out of band signals are attenuated by the band pass filters. The multiplied LO frequency is also applied to Q3 where a resultant 10.7MHz IF signal is derived. This signal is passed through a filter which greatly attenuates other in band signals. The 10.7MHz signal is again mixed with second LO, Q8 operation at 10.245 (11.155)MHz at the second mixer Q4. The resulting mixer output is 455KHz. Two ceramic filters and Q5 and Q7 amplifiers drive IC1 limiter, and thence the signal is detected by the ceramic discriminator.

Lower frequency audio components are amplified by Q10 and passed Q11 active filter. These (desired) audio signals are adjusted to level by the volume control and amplified up to 1 watt power by IC2.

At point J5, discriminator noise is taken at a selected level by R-1 Squelch Control back via J4 and amplified by Q4 and Q5, rectified by D32 and D33 and applied to Q9 base. Under no signal conditions, when noise is high and this rectified voltage is high, Q9 turns off Q10. The reverse is true when a signal is of sufficient strength to reduce noise; the squelch opens permitting the audio signal path to operate normally.

During transmit, positive voltage is fed to the Q9 base, silencing the audio system.

After switching back to receive, a delay in Q9 base voltage change provided by C-56 allows a silent transition. The receiver first LO, Q1, operating near 15MHz is tripled by Q2 and again tripled by Q3 for first mixer injection.

Crystals are switched by diodes which, operating with DC bias, have no effect on the oscillator frequency when control wires are moved.

TRANSMITTER

An 18MHz crystal oscillator Q15 is buffered by Q16. The signals of the Q16 collector and emitter AC voltages (180° out of phase) are fed to the bridge of L5 and D37. Amplified audio from the microphone is applied to D37 also, resulting in a slight change which doubles Q17, Q18 and Q19. Each of these stages is double tuned to prevent spurious signals. Amplifiers Q20 and Q21 provide the last amplification to the 3 watt level. The microphone signal, divided by R72, is amplified by Q6 and Q7. The IDC circuit, Q8, Q9 and Q10 differentiate the level variations and via Q11 active filter limits higher frequency energy from coming through. R87 controls this deviation level. Q12 amplifier arrangement provides a Miller integrator by which the proper pre-emphasis is achieved. R96 sets maximum frequency deviation. Q13 is the output level control driver which is fed information from Q14 where a change in base voltage (via R109 for 3W and R110 for low power) provides Q13 control of driver Q20 and final Q21 collector voltage.

METER CIRCUIT

The S meter is provided a voltage by the sampling of the second IF Q7 collector which is rectified by D4. Calibration is effected by adjusting the gain of Q5 via R19. In the transmit mode, D39 is lightly coupled to L15 where a rectifier RF voltage is fed to the meter for a relative power indication. Adjustment is made via the degree of coupling of D39 with the L15.

T/R SWITCHING

In the receive mode, source voltage is applied to R155, D44, D41 (Zener) and LED indicator D1. A reference voltage of approximately 9.4 volts appears at the cathode of D41. This reference is fed to Q24 base where a regulated voltage of 9 volts is available at its emitter.

During transmission, Q24 base is grounded through D43 by the PTT (MIC) switch which reduces receiver section voltage to zero. From the transmit regulator, current is passed through Q23, R146 and D42 to D41 and Q1. The reference voltage at D41 cathode is applied to Q22 base. Then, a regulated 9 volts is available at Q22 emitter.

SECTION VII INSIDE VIEW

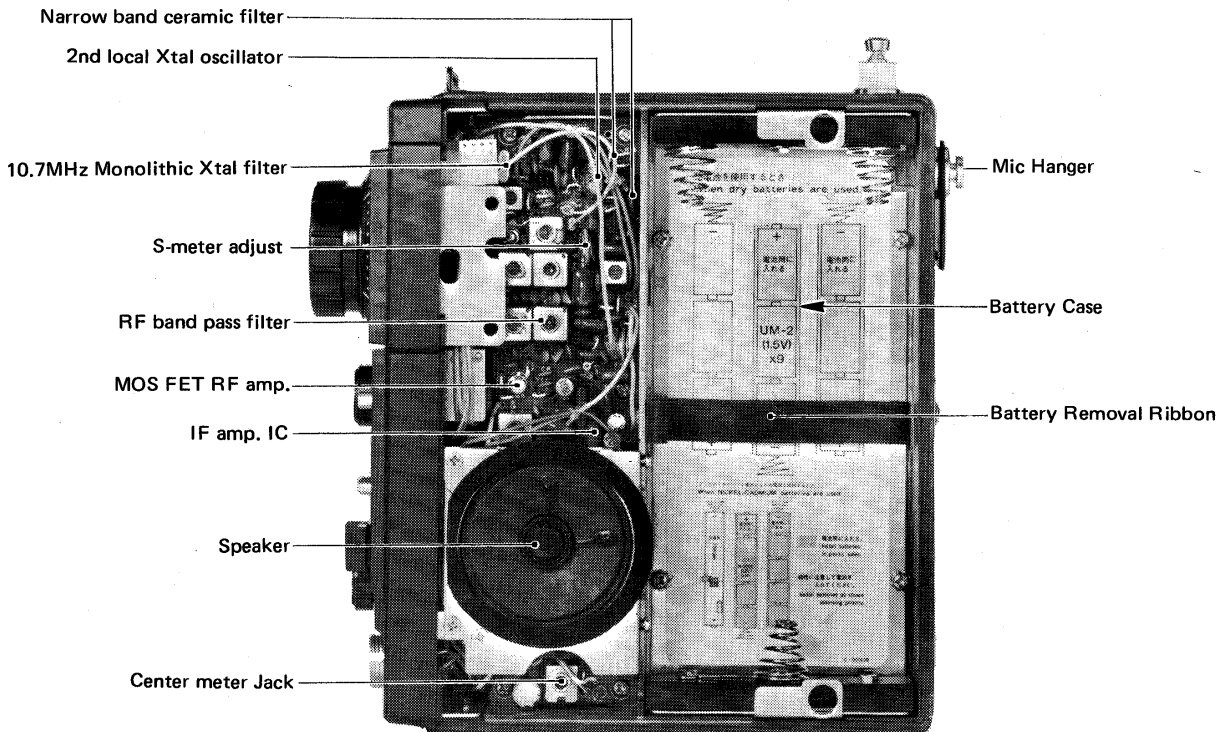
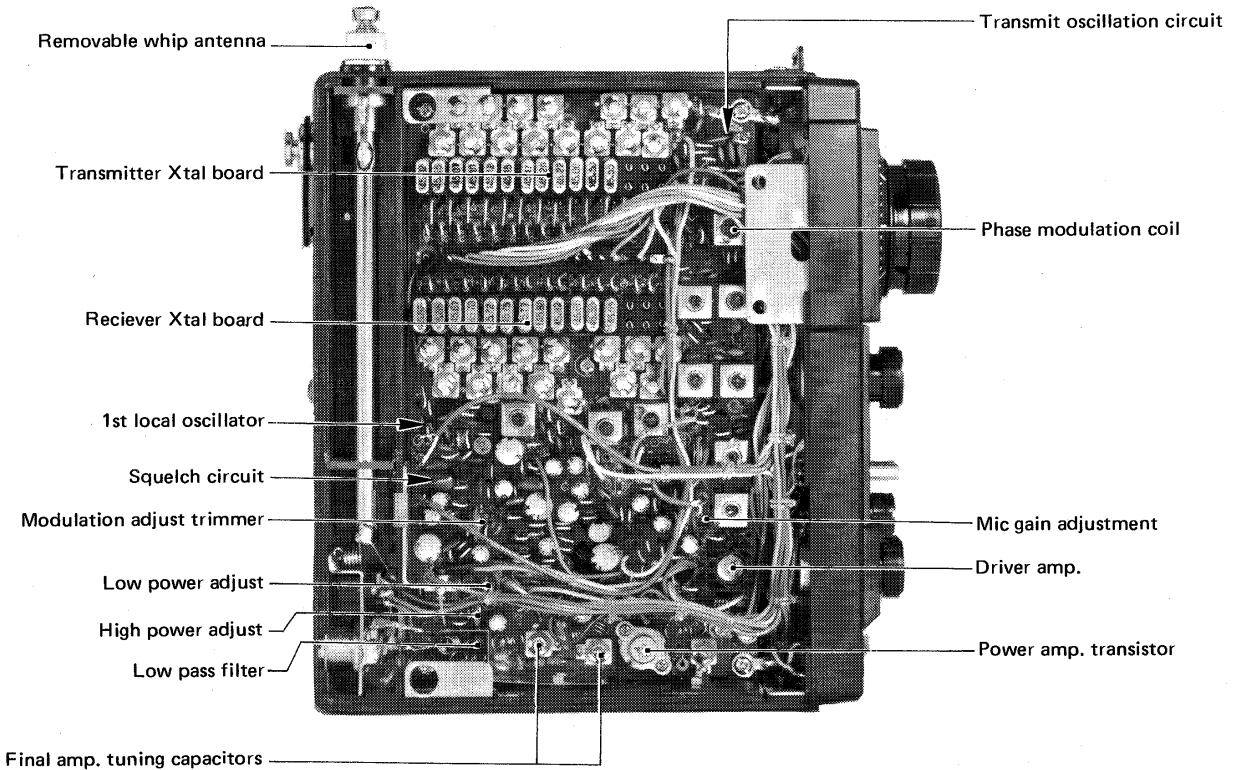

SECTION IX VOLTAGE CHARTS

MAIN UNIT

No.	Transmit				Receive				Notes
	Base or Gate 1	Gate 2	Collector or Drain	Emitter or Source	Base or Gate 1	Gate 2	Collector or Drain	Emitter or Source	
Q1					2.6V		7.4V	1.9V	
Q2					0.5V		7.7V	0.2V	
Q3					1.1V		6.4V	0.7V	
Q4					1.4V		8.7V	0.8V	
Q5					1.3V		5.4V	0.7V	
Q6	6.1V		7.4V	5.6V					
Q7	7.4V		4.2V	8.1V					
Q8	0.5V		0.6V	0V					
Q9	0.6V		0.7V	0V					
Q10	0.7V		1.5V	0V					
Q11	4.8V		7.6V	4.3V					
Q12	1.3V		5.0V	0.9V					
Q13	11.4V 11.7V		9.8V 4.4V	12.2V 12.5V	12.5V		12.5V	12.5V	TX:HI TX:LOW
Q14	7.8V 2.6V		11.2V 11.6V	7.2V 2.1V	12.5V		12.0V	12.5V	TX:HI TX:LOW
Q15	2.6V		8.4V	2.1V					
Q16	2.2V		7.1V	1.6V					
Q17	1.6V		8.3V	0.9V					
Q18	0.6V		8.3V	0.4V					
Q19	0.1V		8.3V	1.1V					
Q20	0.4V 0.4V		11.6V 8.9V	0V 0V	0V		12.5V	0V	TX:HI TX:LOW
Q21	0V 0V		11.6V 8.9V	0V 0V	0V		12.5V	0V	TX:HI TX:LOW
Q22	9.4V		11.1V	8.8V	0.2V		12.5V	0.2V	
Q23	11.5V		11.8V	12.2V	12.5V		0.2V	12.5V	
Q24	0.7V		12.2V	0.2V	9.3V		11.5V	9.8V	

No.	Pin No.													
	1	2	3	4	5	6	7	8	9	10	11	12	13	14
IC1	4.5V	9.0V	4.5V	4.5V	4.5V	4.5V	0V	9.0V	9.0V	0V	9.0V	0V	0V	9.0V

Note: When the tone call push-button is pressed during transmission.

RECEIVER UNIT

No.	Transmit				Receive				Notes
	Base or Gate 1	Gate 2	Collector or Drain	Emitter or Source	Base or Gate 1	Gate 2	Collector or Drain	Emitter or Source	
Q1	4.5V 4.5V		-23V -6.8V	0.3V 0.3V	8.0V		8.6V	8.8V	TX:HI TX:LOW
Q2					0V	3.6V	8.0V	0.1V	
Q3					0V	0V	8.5V	0.1V	
Q4					0V		6.5V	0.8V	
Q5					1.6V		8.6V	1.4V	
Q6					0.6V		2.1V	0V	
Q7					4.4V		6.0V	4.0V	
Q8					2.2V		8.1V	2.2V	
Q9					0.1V 0.5V		1.2V 0.03V	0V 0V	Squelch Opened Closed
Q10					1.2V 0.03V		4.8V 8.3V	1.1V 0V	Squelch opened Closed
Q11					5.6V		8.4V	5.3V	

Transmit

No.	Pin No.								Notes
	1	2	3	4	5	6	7	8	
IC2	1.5V	12.0V	12.0V	0V	0.5V	12.2V	0V	4.7V	

Receive

No.	Pin No.								Notes
	1	2	3	4	5	6	7	8	
IC1	5.2V	2.0V	2.0V	0V	8.6V	3.1V	8.6V	-	
IC2	1.4V	12.2V	11.8V	7.2V	6.0V	12.2V	0V	1.7V	

SECTION X BLOCK DIAGRAM

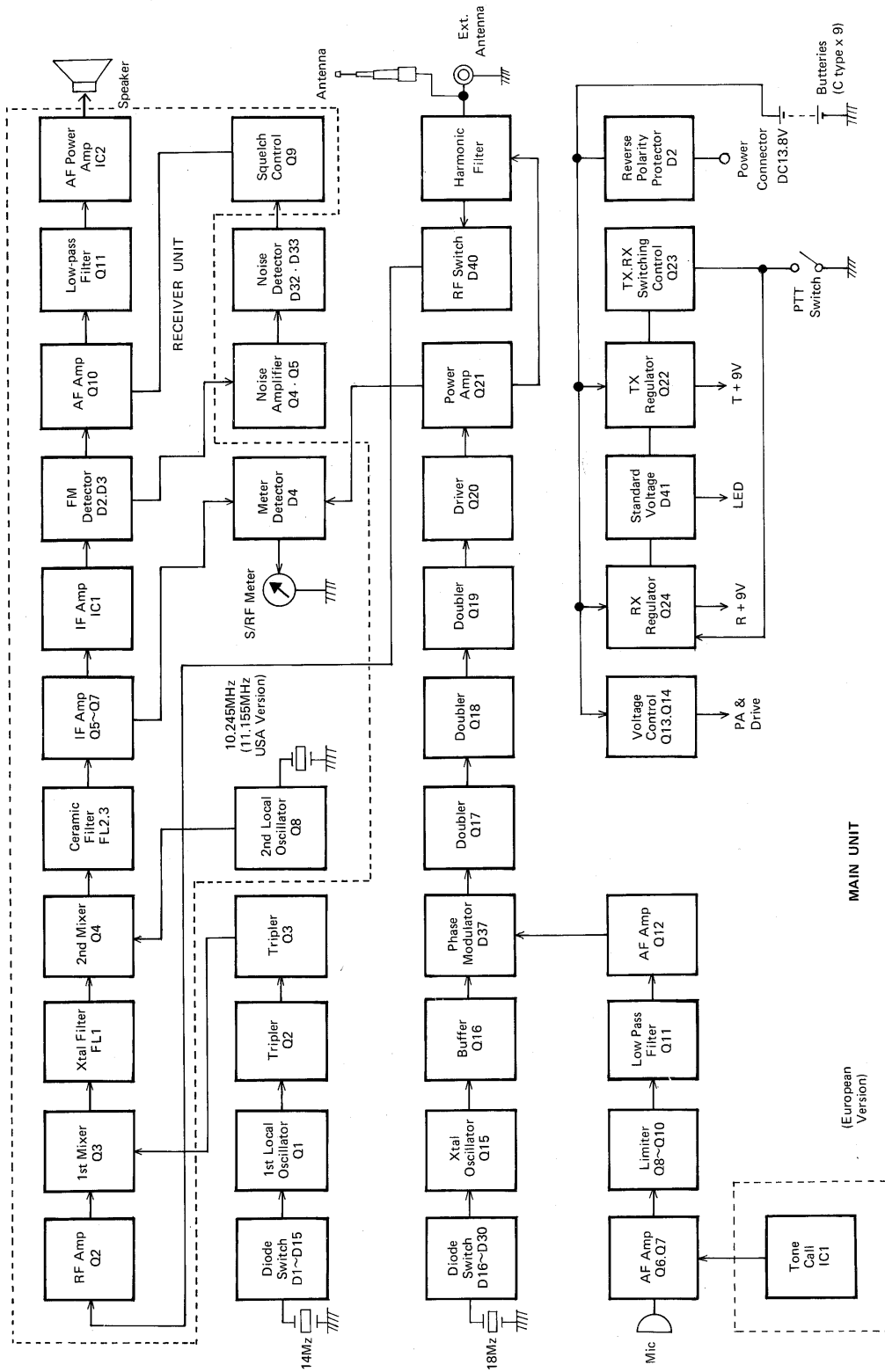

SECTION XI PARTS LIST

MAIN UNIT			
Ref.No.	Description	Part No.	Board Location
Q1	Transistor	2SC945-P	D1
Q2	Transistor	2SC373	D1
Q3	Transistor	2SC763-C	D2
Q4	Transistor	2SC945-P	D1
Q5	Transistor	2SC945-P	D1
Q6	Transistor	2SC1571-G	E3
Q7	Transistor	JA1050-G	E3
Q8	Transistor	2SC1571-G	E2
Q9	Transistor	2SC945-R	E2
Q10	Transistor	2SC945-R	E2
Q11	Transistor	2SC945-P	E1
Q12	Transistor	2SC945-P	E1
Q13	Transistor	2SB435-Y	E1
Q14	Transistor	2SC945-P	F1
Q15	Transistor	2SC945-P	A4
Q16	Transistor	2SC945-R	A4
Q17	Transistor	2SC763-C	B3
Q18	Transistor	2SC763-C	C4
Q19	Transistor	2SC773-E	D4
Q20	Transistor	2SC730	E4
Q21	Transistor	2SC1947	F3
Q22	Transistor	JA1600-G	E3
Q23	Transistor	JA1050-G	E3
Q24	Transistor	JA1600-G	E2
IC1	IC	TC4011P (MC14011CP)	D3
D1	Diode	1S553	B1
D2	Diode	1S553	B1
D3	Diode	1S553	B1
D4	Diode	1S553	B1
D5	Diode	1S553	B1
D6	Diode	1S553	B1
D7	Diode	1S553	B2
D8	Diode	1S553	B2
D9	Diode	1S553	B2
D10	Diode	1S553	B2
D11	Diode	1S553	B2
D12	Diode	1S553	B2
D13	Diode	1S553	B3
D14	Diode	1S553	B3
D15	Diode	1S553	B3
D16	Diode	1S553	B1
D17	Diode	1S553	B1
D18	Diode	1S553	B1
D19	Diode	1S553	B1
D20	Diode	1S553	B1
D21	Diode	1S553	B1
D22	Diode	1S553	B2
D23	Diode	1S553	B2
D24	Diode	1S553	B2
D25	Diode	1S553	B2
D26	Diode	1S553	B2
D27	Diode	1S553	B2
D28	Diode	1S553	B3
D29	Diode	1S553	B3
D30	Diode	1S553	B3
D31	Diode	1S1555	D2
D32	Diode	1N60	D2
D33	Diode	1N60	D2
D34	Diode	1N60	E2
D35	Diode	1N60	E2

MAIN UNIT			
Ref.No.	Description	Part No.	Board Location
D36	Zener	1S993	F1
D37	Varicap	1S2688-E	B4
D38	Diode	1N60	B3
D39	Diode	1N60	F2
D40	Diode	MI301	F2
D41	Zener	XZ072	E3
D42	Diode	1S1555	E3
D43	Diode	1S1555	E3
D43	Diode	1S1555	E3
D44	Diode	1S1555	E3
L1	Coil	LS-2	D2
L2	Coil	LS-3A	D2
L3	Coil	LS-3	D3
L4	Choke Coil	L102 1 mH	D1
L5	Coil	LS-88	B4
L6	Coil	LS-12	C3
L7	Coil	LS-12	C4
L8	Coil	LS-13	C3
L9	Coil	LS-13	C4
L10	Coil	LS-3A	D4
L11	Coil	LS-3	E4
L12	Coil	LS-2	E4
L13	Coil	LA-71	F3
L14	Coil	LA-9	F2
L15	Coil	LA-71	F2
L16	Coil	LA-71	F1
L17	Coil	LA-71	F1
R1	Resistor	47K ohm	ELR25 B1
R2	Resistor	47K ohm	ELR25 B1
R3	Resistor	47K ohm	ELR25 B1
R4	Resistor	47K ohm	ELR25 B1
R5	Resistor	47K ohm	ELR25 B1
R6	Resistor	47K ohm	ELR25 B2
R7	Resistor	47K ohm	ELR25 B2
R8	Resistor	47K ohm	ELR25 B2
R9	Resistor	47K ohm	ELR25 B2
R10	Resistor	47K ohm	ELR25 B2
R11	Resistor	47K ohm	ELR25 B2
R12	Resistor	47K ohm	ELR25 B3
R13	Resistor	47K ohm	ELR25 B3
R14	Resistor	47K ohm	ELR25 B3
R15	Resistor	47K ohm	ELR25 B3
R16	Resistor	4.7K ohm	ELR25 B1
R17	Resistor	4.7K ohm	ELR25 B1
R18	Resistor	4.7K ohm	ELR25 B1
R19	Resistor	4.7K ohm	ELR25 B1
R20	Resistor	4.7K ohm	ELR25 B1
R21	Resistor	4.7K ohm	ELR25 B2
R22	Resistor	4.7K ohm	ELR25 B2
R23	Resistor	4.7K ohm	ELR25 B2
R24	Resistor	4.7K ohm	ELR25 B2
R25	Resistor	4.7K ohm	ELR25 B2
R26	Resistor	4.7K ohm	ELR25 B2
R27	Resistor	4.7K ohm	ELR25 B3
R28	Resistor	4.7K ohm	ELR25 B3
R29	Resistor	4.7K ohm	ELR25 B3
R30	Resistor	4.7K ohm	ELR25 B3
R31	Resistor	4.7K ohm	ELR25 B1
R32	Resistor	4.7K ohm	ELR25 B1
R33	Resistor	4.7K ohm	ELR25 B1

MAIN UNIT			
Ref.No.	Description	Part No.	Board Location
R34	Resistor	4.7K ohm	ELR25 B1
R35	Resistor	4.7K ohm	ELR25 B1
R36	Resistor	4.7K ohm	ELR25 B1
R37	Resistor	4.7K ohm	ELR25 B2
R38	Resistor	4.7K ohm	ELR25 B2
R39	Resistor	4.7K ohm	ELR25 B2
R40	Resistor	4.7K ohm	ELR25 B2
R41	Resistor	4.7K ohm	ELR25 B2
R42	Resistor	4.7K ohm	ELR25 B2
R43	Resistor	4.7K ohm	ELR25 B3
R44	Resistor	4.7K ohm	ELR25 B3
R45	Resistor	4.7K ohm	ELR25 B3
R46	Resistor	4.7K ohm	ELR25 A3
R47	Resistor	4.7K ohm	ELR25 C1
R48	Resistor	4.7K ohm	ELR25 D1
R49	Resistor	10K ohm	ELR25 D1
R50	Resistor	1K ohm	ELR25 D1
R51	Resistor	100 ohm	ELR25 D1
R52	Resistor	2.2K ohm	ELR25 D1
R53	Resistor	33K ohm	ELR25 D1
R54	Resistor	330 ohm	ELR25 D1
R55	Resistor	2.7K ohm	ELR25 D2
R56	Resistor	15K ohm	ELR25 D2
R57	Resistor	100 ohm	ELR25 D2
R58	Resistor	330 ohm	R25 D2
R59	Resistor	100 ohm	ELR25 D2
R60	Thermistor	33D28	D1
R61	Resistor	2.7K ohm	ELR25 D1
R62	Resistor	27K ohm	ELR25 D1
R63	Resistor	1K ohm	ELR25 D1
R64	Resistor	4.7K ohm	ELR25 D1
R65	Resistor	27K ohm	ELR25 D1
R66	Resistor	1K ohm	ELR25 D2
R67	Resistor	4.7K ohm	ELR25 D2
R68	Resistor	10K ohm	ELR25 D2
R69	Resistor	15K ohm	ELR25 D2
R70	Resistor	27K ohm	ELR25 D2
R71	Resistor	4.7K ohm	ELR25 E3
R72	Trimmer	500 ohm	FR10B E3
R73	Resistor	2.2K ohm	ELR25 E3
R74	Resistor	27K ohm	ELR25 E3
R75	Resistor	10K ohm	ELR25 E3
R76	Resistor	100 ohm	ELR25 E3
R77	Resistor	15K ohm	ELR25 E3
R78	Resistor	2.2K ohm	ELR25 D2
R79	Resistor	12K ohm	ELR25 E3
R80	Resistor	220 ohm	ELR25 E3
R81	Resistor	2.2K ohm	ELR25 E2
R82	Resistor	22 ohm	ELR25 E2
R83	Resistor	1K ohm	ELR25 D2
R84	Resistor	22K ohm	ELR25 E2
R85	Resistor	2.2K ohm	ELR25 E2
R86	Resistor	470 ohm	ELR25 E2
R87	Trimmer	3K ohm	FR10B E2
R88	Resistor	4.7K ohm	ELR25 E2
R89	Resistor	33K ohm	ELR25 E2
R90	Resistor	220 ohm	ELR25 E2
R91	Resistor	22K ohm	ELR25 E2
R92	Resistor	5.6K ohm	ELR25 E2
R93	Resistor	5.6K ohm	ELR25 E2
R94	Resistor	5.6K ohm	ELR25 E2

MAIN UNIT			
Ref.No.	Description	Part No.	Board Location
R95	Thermistor	33D28	E1
R96	Trimmer	1K ohm	FR10B E1
R97	Resistor	100 ohm	ELR25 E1
R98	Resistor	4.7K ohm	ELR25 E1
R99	Resistor	22K ohm	ELR25 E1
R100	Resistor	22K ohm	ELR25 E1
R101	Resistor	560 ohm	ELR25 D1
R102	Resistor	330 ohm	ELR25 E1
R103	Resistor	3.9K ohm	ELR25 E1
R104	Resistor	1M ohm	R15 E1
R105	Resistor	100K ohm	ELR25 D1
R106	Resistor	47 ohm	ELR25 E1
R107	Resistor	1K ohm	ELR25 E1
R108	Resistor	470 ohm	ELR25 F1
R109	Trimmer	10K ohm	FR10B F1
R110	Trimmer	5K ohm	FR10B E1
R111	Resistor	4.7K ohm	ELR25 A3
R112	Resistor	4.7K ohm	ELR25 A3
R113	Resistor	1K ohm	ELR25 A4
R114	Resistor	10K ohm	ELR25 A4
R115	Resistor	3.3K ohm	ELR25 A4
R116	Resistor	82 ohm	ELR25 A4
R117	Resistor	100 ohm	ELR25 B4
R118	Resistor	8.2K ohm	ELR25 A4
R119	Resistor	100 ohm	ELR25 A3
R120	Resistor	100 ohm	ELR25 A3
R121	Resistor	100 ohm	ELR25 A3
R122	Resistor	47 ohm	ELR25 A3
R123	Resistor	56K ohm	ELR25 B3
R124	Resistor	100K ohm	ELR25 B4
R125	Resistor	4.7K ohm	R25 B3
R126	Resistor	2.7K ohm	ELR25 B3
R127	Resistor	10K ohm	ELR25 B3
R128	Resistor	100 ohm	ELR25 B4
R129	Resistor	2.2K ohm	ELR25 C3
R130	Resistor	47 ohm	R25 C4
R131	Resistor	22K ohm	ELR25 C3
R132	Resistor	22 ohm	ELR25 C3
R133	Resistor	2.2K ohm	ELR25 D3
R134	Resistor	15K ohm	ELR25 D3
R135	Resistor	22 ohm	ELR25 D3
R136	Resistor	22 ohm	ELR25 D4
R137	Resistor	47 ohm	R25 D4
R138	Resistor	47 ohm	R25 E4
R139	Resistor	1K ohm	ELR25 E3
R140	Resistor	10 ohm	R25 F3
R141	Resistor	470 ohm	R $\frac{1}{2}$ W F2
R142	Resistor	1K ohm	ELR25 E2
R143	Resistor	22 ohm	ELR25 E3
R144	Resistor	2.2K ohm	ELR25 E3
R145	Resistor	220 ohm	ELR25 E3
R146	Resistor	470 ohm	ELR25 E3
R147	Resistor	33K ohm	ELR25 E3
R148	Resistor	4.7K ohm	ELR25 E3
R149	Resistor	220 ohm	R $\frac{1}{2}$ W E1
R150	Resistor	1K ohm	ELR25 E3
R151	Resistor	22 ohm	ELR25 E3
R152	Resistor	150 ohm	ELR25 E3
R153	Resistor	1K ohm	ELR25 E2
R200	-	-	-

MAIN UNIT			
Ref.No.	Description	Part No.	Board Location
R201	—	—	—
R202	—	—	—
R203	—	—	—
R204	Resistor	82K ohm	ELR25 D3
R205	Resistor	22K ohm	ELR25 D3
R206	Trimmer	10K ohm	FR10B D3
R207	Resistor	1M ohm	ELR25 D3
C1	Trimmer	CVD30-13 (30pF)	C1
C2	Trimmer	CVD30-13 (30pF)	C1
C3	Trimmer	CVD30-13 (30pF)	C1
C4	Trimmer	CVD30-13 (30pF)	C1
C5	Trimmer	CVD30-13 (30pF)	C1
C6	Trimmer	CVD30-13 (30pF)	C1
C7	Trimmer	CVD30-13 (30pF)	C2
C8	Trimmer	CVD30-13 (30pF)	C2
C9	Trimmer	CVD30-13 (30pF)	C2
C10	Trimmer	CVD30-13 (30pF)	C2
C11	Trimmer	CVD30-13 (30pF)	C2
C12	Trimmer	CVD30-13 (30pF)	C3
C13	Trimmer	CVD30-13 (30pF)	C3
C14	Trimmer	CVD30-13 (30pF)	C3
C15	Trimmer	CVD30-13 (30pF)	C3
C16	Trimmer	CVD30-13 (30pF)	A1
C17	Trimmer	CVD30-13 (30pF)	A1
C18	Trimmer	CVD30-13 (30pF)	A1
C19	Trimmer	CVD30-13 (30pF)	A1
C20	Trimmer	CVD30-13 (30pF)	A1
C21	Trimmer	CVD30-13 (30pF)	A2
C22	Trimmer	CVD30-13 (30pF)	A2
C23	Trimmer	CVD30-13 (30pF)	A2
C24	Trimmer	CVD30-13 (30pF)	A2
C25	Trimmer	CVD30-13 (30pF)	A2
C26	Trimmer	CVD30-13 (30pF)	A3
C27	Trimmer	CVD30-13 (30pF)	A3
C28	Trimmer	CVD30-13 (30pF)	A3
C29	Trimmer	CVD30-13 (30pF)	A3
C30	Trimmer	CVD30-13 (30pF)	A3
C31	Ceramic	0.01 μ F 50V	A3
C32	Ceramic	0.01 μ F 50V	D1
C33	Ceramic	100pF 50V	D1
C34	Ceramic	0.01 μ F 50V	D1
C35	Ceramic	100pF 50V	D1
C36	Ceramic	50pF 50V	D1
C37	Ceramic	0.01 μ F 50V	D1
C38	Ceramic	40pF (PH) 50V	D1
C39	Ceramic	0.01 μ F 50V	D2
C40	Ceramic	30pF 50V	D2
C41	Ceramic	0.01 μ F 50V	D2
C42	Ceramic	0.01 μ F 50V	D2
C43	Ceramic	8pF 50V	D2
C44	Ceramic	100pF 50V	D3
C45	Ceramic	10pF 50V	D3
C46	Ceramic	10pF 50V	D3
C47	Electrolytic	100 μ F 10V	D1
C48	Mylar	0.01 μ F 50V	D1
C49	Mylar	0.1 μ F 50V	D1
C50	Mylar	0.022 μ F 50V	D1
C51	Mylar	0.001 μ F 50V	D1
C52	Electrolytic	4.7 μ F 25V	D1
C53	Mylar	0.039 μ F 50V	D2
C54	Electrolytic	10 μ F 16V	D2

MAIN UNIT			
Ref.No.	Description	Part No.	Board Location
C55	Electrolytic	3.3 μ F 25V	D2
C56	Electrolytic	3.3 μ F 25V	D2
C57	Electrolytic	100 μ F 10V	E2
C58	Electrolytic	3.3 μ F 25V	E3
C59	Ceramic	0.001 μ F 50V	E3
C60	Electrolytic	0.47 μ F 50V	E3
C61	Ceramic	0.001 μ F 50V	E3
C62	Electrolytic	10 μ F 16V	D3
C63	Electrolytic	33 μ F 10V	E2
C64	Mylar	0.01 μ F 50V	E2
C65	Electrolytic	22 μ F 16V	E2
C66	Ceramic	100pF 50V	E2
C67	Electrolytic	100 μ F 10V	E2
C68	Mylar	0.0047 μ F 50V	E2
C69	Electrolytic	3.3 μ F 25V	E2
C70	Mylar	0.01 μ F 50V	E2
C71	Ceramic	100pF 50V	E1
C72	Mylar	0.01 μ F 50V	E2
C73	Mylar	0.0033 μ F 50V	E2
C74	Electrolytic	100 μ F 10V	E1
C75	Electrolytic	0.47 μ F 50V	E1
C76	Electrolytic	10 μ F 16V	D1
C77	Mylar	0.01 μ F 50V	E1
C78	Electrolytic	0.47 μ F 50V	E1
C79	Ceramic	0.001 μ F 50V	F1
C80	Electrolytic	10 μ F 16V	F1
C81	Ceramic	0.001 μ F 50V	F1
C82	Ceramic	0.01 μ F 50V	A3
C83	Ceramic	200pF 50V	A4
C84	Ceramic	200pF 50V	A4
C85	Ceramic	200pF 50V	A4
C86	Ceramic	0.01 μ F 50V	A4
C87	Ceramic	0.01 μ F 50V	A4
C88	Ceramic	0.01 μ F 50V	A4
C89	Ceramic	0.001 μ F 50V	A3
C90	Mylar	0.001 μ F 50V	B4
C91	Ceramic	0.0022 μ F 50V	B3
C92	Ceramic	0.01 μ F 50V	B3
C93	Ceramic	0.01 μ F 50V	B3
C94	Ceramic	0.01 μ F 50V	B3
C95	Ceramic	0.01 μ F 50V	B4
C96	Dip Mica	39pF 50V	B3
C97	Ceramic	0.01 μ F 50V	B3
C98	Ceramic	2pF 50V	B3
C99	Dip Mica	51pF 50V	B4
C100	Styrene	200pF 50V	C4
C101	Ceramic	0.01 μ F 50V	C4
C102	Dip Mica	30pF 50V	C3
C103	Ceramic	0.01 μ F 50V	C4
C104	Dip Mica	39pF 50V	C4
C105	Ceramic	2pF 50V	C4
C106	Styrene	100pF 50V	D4
C107	Ceramic	0.01 μ F 50V	D4
C108	Ceramic	0.01 μ F 50V	D4
C109	Ceramic	6pF 50V	D4
C110	Ceramic	7pF 50V	D4
C111	Ceramic	68pF 50V	D4
C112	Ceramic	25pF 50V	E4
C113	Ceramic	0.01 μ F 50V	E3
C114	Ceramic	0.001 μ F 50V	F4
C115	Ceramic	0.01 μ F 50V	F4

C116	Electrolytic	22 μ F	16V	F4
C117	Trimmer	CVO5C120 (12pF)		F4
C118	Trimmer	CVC20-11 (20pF)		F3
C119	Ceramic	0.001 μ F	50V	F2
C120	Ceramic	0.01 μ F	50V	E2
C121	Electrolytic	22 μ F	16V	F2
C122	Trimmer	CVC20-11 (20pF)		F2
C123	Trimmer	CVC20-11 (20pF)		F2
C124	Ceramic	0.01 μ F	50V	F2
C125	Ceramic	15pF	50V	F2
C126	Ceramic	25pF	50V	F1
C127	Ceramic	6pF	50V	F1
C128	Ceramic	7pF	50V	F1
C129	Ceramic	35pF	50V	F1
C130	Ceramic	3pF	50V	F1
C131	Ceramic	0.001 μ F	50V	E3
C132	Ceramic	0.001 μ F	50V	F3
C133	Ceramic	0.001 μ F	50V	F3
C134	Ceramic	0.001 μ F	50V	F3
C135	Electrolytic	33 μ F	10V	E2
C136	Ceramic	0.001 μ F	50V	E3
C137	Ceramic	0.001 μ F	50V	F3
C138	Ceramic	0.001 μ F	50V	E1
C139	—	—	—	—
C201	—	—	—	—
C202	Mylar	0.01 μ F	50V	D3
C203	—	—	—	—
J1	Pin Connector	1281210281P		B2
J2	Pin Connector	1280310281P		B3
J3	Pin Contact	171255-1		D1
J4	Pin Contact	171255-1		D1
J5	Pin Contact	171255-1		D2
J6	Pin Contact	171255-1		D2
J7	Pin Contact	171255-1		D3
J8	Pin Contact	171255-1		D3
J9	Pin Contact	171255-1		D3
J10	Pin Contact	171255-1		D3
J11	Pin Contact	171255-1		E3
J12	Pin Contact	171255-1		E3
J13	Pin Contact	171255-1		E1
J14	Pin Contact	171255-1		E1
J15	Pin Contact	171255-1		E2
J16	Pin Contact	171255-1		F2
J17	Pin Contact	171255-1		E2
J18	Pin Contact	171255-1		E2
J19	Pin Contact	171255-1		F3
J20	Pin Contact	171255-1		F3
J21	Eyelet	2x3		F1
S01	Xtal Socket	12P		C1
S02	Xtal Socket	3P		C3
S03	Xtal Socket	12P		A1
S04	Xtal Socket	3P		A3
RECEIVER UNIT				
Ref.No.	Description	Part No.	Board Location	
Q1	Transistor	2SA750-1	D1	
Q2	FET	3SK40-M	C1	
Q3	FET	3SK40-M	B1	
Q4	FET	2SK49-H2	A1	
Q5	Transistor	2SC945-R	B2	
Q6	Transistor	2SC945-P	B2	
Q7	Transistor	2SC945-P	C1	

RECEIVER UNIT				
Ref.No.	Description	Part No.	Board Location	
Q8	Transistor	2SC945-P	A1	
Q9	Transistor	2SC945-P	E2	
Q10	Transistor	2SC945-P	E2	
Q11	Transistor	2SC945-P	E2	
IC1	IC	μ PC577H	C1	
IC2	IC	μ PC575C2	F1	
D1	Diode	1S1555	B2	
D2	Diode	1N60	D2	
D3	Diode	1N60	D2	
D4	Diode	1N60	C1	
C5	Diode	1S1555	E1	
D6	Diode	1SS53	C2	
D7	Diode	1N60	C1	
X1	Xtal	HC-18/u	10.245MHz (11.155MHz)	A1
FL1	Xtal Filter	10M20A	A1	
FL2	Ceramic Filter	CFU455E	A1	
FL3	Ceramic Filter	CFU455E	A2	
DS1	Ceramic Discriminator	455D	D2	
L1	Coil	LS-3A	D1	
L2	Coil	LS-3A	C1	
L3	Coil	LS-3	C1	
L4	Coil	LS-3	B1	
L5	Coil	LS-3A	B1	
L6	Coil	LS-3A	B1	
L7	Coil	LS-110	A1	
L8	Coil	LS-20	B2	
L9	Choke Coil	L102 1mH	C1	
L10	Choke Coil	L102 1mH	D2	
L11	Coil	LS-16	D1	
R1	Resistor	22K ohm	ELR25	D1
R2	Resistor	22K ohm	ELR25	D1
R3	Resistor	470 ohm	ELR25	D1
R4	Resistor	100K ohm	ELR25	C1
R5	Resistor	120K ohm	ELR25	C1
R6	Resistor	47 ohm	ELR25	C1
R7	Resistor	220 ohm	ELR25	C1
R8	Resistor	220 ohm	ELR25	A1
R9	Resistor	220 ohm	ELR25	A1
R10	Resistor	3.9K ohm	R25	A1
R11	Resistor	1K ohm	ELR25	A1
R12	Resistor	1K ohm	ELR25	A1
R13	Resistor	1.5K ohm	ELR25	A1
R14	Resistor	470 ohm	ELR25	A2
R15	Resistor	2.2K ohm	ELR25	A2
R16	Resistor	470 ohm	ELR25	A2
R17	Resistor	1.8K ohm	ELR25	A2
R18	Resistor	47K ohm	ELR25	A2
R19	Trimmer	3K ohm	FR10B	B1
R20	Resistor	330 ohm	ELR25	A2
R21	Resistor	4.7K ohm	ELR25	B2
R22	Resistor	150K ohm	ELR25	B2
R23	Resistor	220 ohm	ELR25	B2
R24	Resistor	100K ohm	ELR25	B2
R25	Resistor	470 ohm	ELR25	B2
R26	Resistor	100K ohm	ELR25	C1
R27	Resistor	220 ohm	ELR25	B2

RECEIVER UNIT				
Ref.No.	Description	Part No.	Board Location	
R28	Resistor	470 ohm	R25	C2
R29	Resistor	10K ohm	ELR25	D2
R30	Resistor	10K ohm	ELR25	D1
R31	Trimmer	5K ohm	FR10B	C2
R32	Resistor	47K ohm	ELR25	A1
R33	Resistor	100K ohm	ELR25	A1
R34	Resistor	2.2K ohm	ELR25	A1
R35	Resistor	470 ohm	ELR25	A1
R36	Resistor	1K ohm	ELR25	F1
R37	Resistor	10K ohm	ELR25	D2
R38	Resistor	22K ohm	ELR25	D1
R39	Resistor	470 ohm	ELR25	D1
R40	Resistor	3.3K ohm	ELR25	D1
R41	Resistor	150K ohm	ELR25	D1
R42	Resistor	39K ohm	ELR25	D2
R43	Resistor	150K ohm	ELR25	E2
R44	Resistor	33K ohm	ELR25	D2
R45	Resistor	2.2K ohm	ELR25	D2
R46	Resistor	390 ohm	ELR25	E2
R47	Resistor	8.2K ohm	ELR25	E2
R48	Resistor	33K ohm	ELR25	E2
R49	Resistor	82K ohm	ELR25	E2
R50	Resistor	10K ohm	ELR25	E2
R51	Resistor	10K ohm	ELR25	E2
R52	Resistor	10K ohm	ELR25	F2
R53	Resistor	4.7K ohm	ELR25	E2
R54	Resistor	470 ohm	ELR25	F1
R55	Resistor	47K ohm	ELR25	E1
R56	Resistor	150K ohm	ELR25	E1
R57	Resistor	120K ohm	ELR25	E1
C1	Ceramic	0.001 μ F	50V	D1
C2	Ceramic	0.001 μ F	50V	D1
C3	—	—	—	—
C4	Ceramic	0.001 μ F	50V	D1
C5	Ceramic	0.01 μ F	50V	E1
C6	Ceramic	0.01 μ F	50V	C1
C7	Ceramic	5pF	50V	C1
C8	Ceramic	0.01 μ F	50V	C1
C9	Ceramic	0.01 μ F	50V	C1
C10	Ceramic	2pF	50V	C1
C11	Ceramic	0.01 μ F	50V	C1
C12	Ceramic	4pF	50V	C1
C13	Ceramic	68pF	50V	C1
C14	Ceramic	4pF	50V	C1
C15	Ceramic	4pF	50V	B1
C16	Ceramic	68pF	50V	B1
C17	Ceramic	4pF	50V	B1
C18	Ceramic	4pF	50V	B1
C19	Ceramic	30pF	50V	B1
C20	Ceramic	4pF	50V	B1
C21	Ceramic	2pF	50V	B1
C22	Ceramic	8pF	50V	B1
C23	Ceramic	0.001 μ F	50V	B1
C24	Ceramic	10pF	50V	B1
C25	Ceramic	0.01 μ F	50V	A1
C26	Mylar	0.056 μ F	50V	A1
C27	Mylar	0.056 μ F	50V	A1
C28	Mylar	0.01 μ F	50V	A2
C29	Mylar	0.056 μ F	50V	A1
C30	Mylar	0.056 μ F	50V	B2
C31	Mylar	0.01 μ F	50V	B2
C32	Mylar	0.01 μ F	50V	B2

RECEIVER UNIT				
Ref.No.	Description	Part No.	Board Location	
C33	Mylar	0.001 μ F	50V	B2
C34	Mylar	0.1 μ F	50V	B1
C35	Mylar	0.056 μ F	50V	C2
C36	Mylar	0.01 μ F	50V	C1
C37	Mylar	0.001 μ F	50V	C1
C38	Mylar	0.056 μ F	50V	C1
C39	Mylar	0.056 μ F	50V	C2
C40	Mylar	0.056 μ F	50V	D1
C41	Electrolytic	10 μ F	16V	C2
C42	Mylar	0.056 μ F	50V	D2
C43	Mylar	0.0022 μ F	50V	D1
C44	Mylar	0.039 μ F	50V	C2
C45	Mylar	0.01 μ F	50V	C1
C46	Ceramic	0.01 μ F	50V	A1
C47	Dip Mica	30pF	50V	A1
C48	Ceramic	200pF	50V	A1
C49	Ceramic	100pF	50V	A1
C50	Ceramic	3pF	50V	A1
C51	Mylar	0.01 μ F	50V	D1
C52	Mylar	0.056 μ F	50V	D2
C53	Mylar	0.0022 μ F	50V	D2
C54	Mylar	0.039 μ F	50V	D1
C55	Ceramic	0.001 μ F	50V	E2
C56	Electrolytic	100 μ F	10V	F2
C57	Mylar	0.022 μ F	50V	E2
C58	Electrolytic	3.3 μ F	25V	D2
C59	Mylar	0.039 μ F	50V	E2
C60	Mylar	0.01 μ F	50V	E2
C61	Mylar	0.0033 μ F	50V	E2
C62	Ceramic	100pF	50V	F2
C63	Electrolytic	1 μ F	50V	F2
C64	Ceramic	0.001 μ F	50V	E1
C65	Electrolytic	47 μ F	16V	F1
C66	Electrolytic	33 μ F	10V	E1
C67	Electrolytic	100 μ F	10V	F1
C68	Semi Conductive	0.2 μ F	12V	F1
C69	Ceramic	0.001 F	50V	E1
C70	Electrolytic	0.001 μ F	50V	E1
C71	Electrolytic	0.47 μ F	50V	E1
C72	Electrolytic	47 μ F	16V	E1
C73	Ceramic	0.001 μ F	50V	E1
C74	Electrolytic	33 μ F	10V	E1
C75	Ceramic	0.01 μ F	50V	C2
J1	Pin Contact	171255-1		A1
J2	Pin Contact	171255-1		B1
J3	Pin Contact	171255-1		C2
J4	Pin Contact	171255-1		D1
J5	Pin Contact	171255-1		D1
J6	Pin Contact	171255-1		D1
J7	Pin Contact	171255-1		D1
J8	Pin Contact	171255-1		D1
J9	Pin Contact	171255-1		E1
J10	Pin Contact	171255-1		E1
J11	Pin Contact	171255-1		E2
J12	Pin Contact	171255-1		E2
J13	Pin Contact	171255-1		F1
J14	Pin Contact	171255-1		E1
J15	Pin Contact	171255-1		F1
J16	Pin Contact	171255-1		F2
J17	Pin Contact	171255-1		F2
J18	Phone Jack	SJ-314		F1

MAIN UNIT

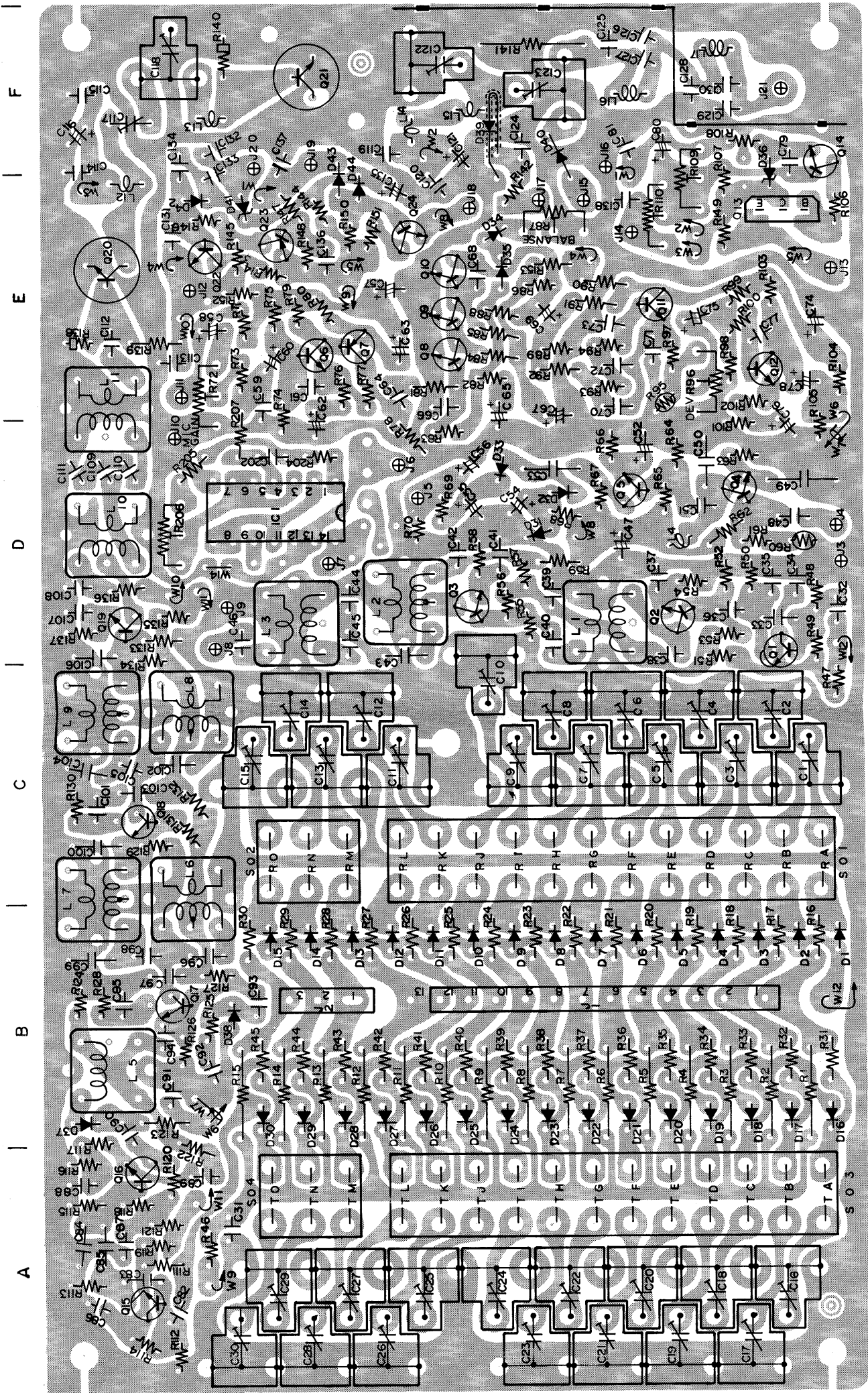

Part No.	Board Location
101μF	B2
50V	B1
50V	C2
50V	C1
50V	C1
50V	C1
50V	C2
50V	D1
16V	C2
50V	D2
50V	D1
50V	C2
50V	C1
50V	A1
50V	A1
50V	A1
50V	A1
50V	A1
50V	A1
50V	D1
50V	D2
50V	D1
50V	E2
10V	E2
50V	E2
25V	D2
50V	E2
50V	E2
50V	E2
50V	E2
50V	F2
50V	F2
50V	F1
16V	E1
10V	E1
10V	F1
12V	F1
50V	E1
50V	E1
50V	E1
16V	E1
50V	E1
10V	E1
50V	C2
1255-1	A1
1255-1	B1
1255-1	C2
1255-1	D1
1255-1	D1
1255-1	D1
1255-1	D1
1255-1	D1
1255-1	D1
1255-1	E1
1255-1	E1
1255-1	E2
1255-1	E2
1255-1	E2
1255-1	F1
1255-1	F1
1255-1	F1
1255-1	F2
1255-1	F2
1255-1	F1

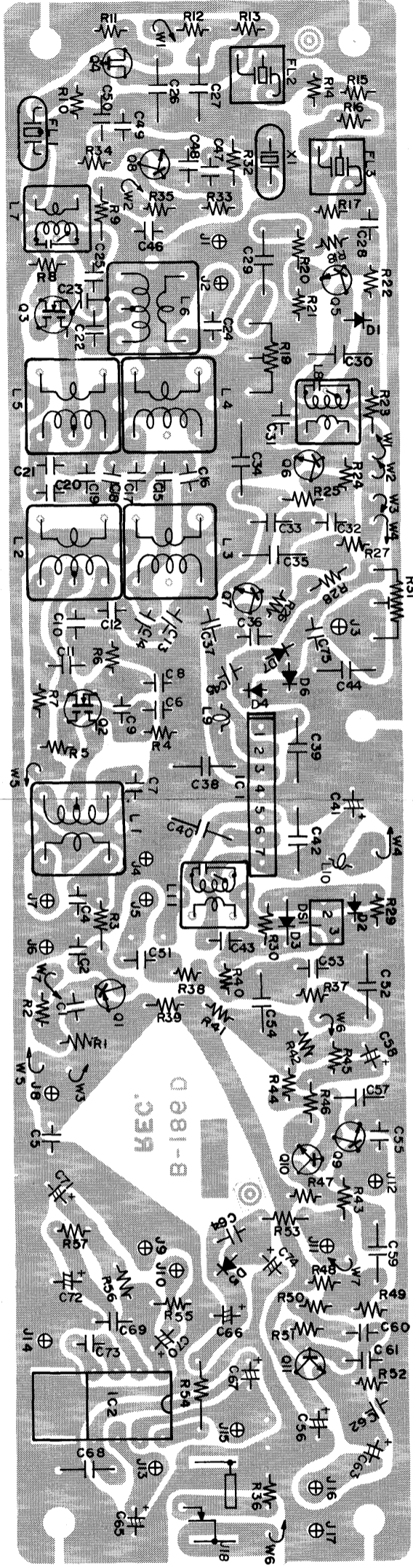

RECEIVER UNIT

CENTER METER

SECTION XII OPTIONS

We have prepared a variety of options for the portable transceiver IC-215 in order to enlarge its use as a portable, mobile and fixed set.

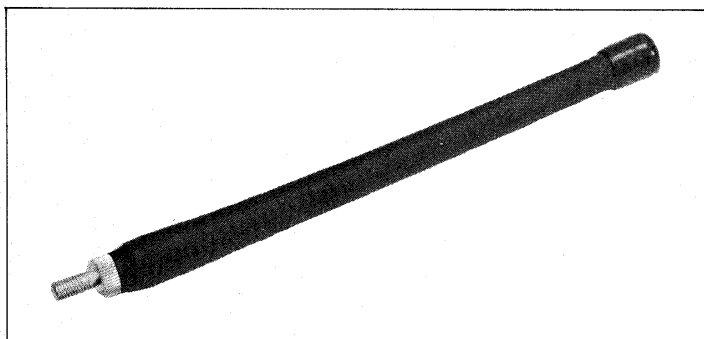

**IC-FA1
FLEXIBLE
ANTENNA**

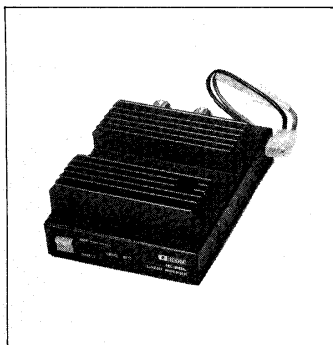

**IC-20L
LINEAR AMPLIFIER
144MHz 10W**

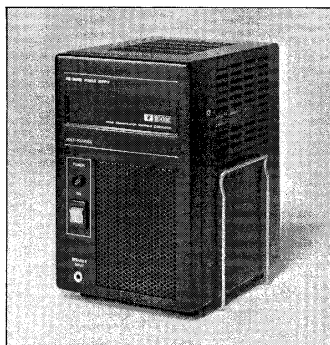

**IC-3PS
POWER SUPPLY
13.8V 3A**

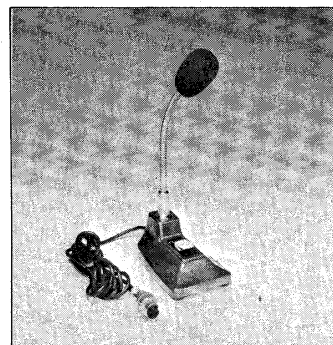

**IC-SM2
DESK MICROPHONE
ELECTRET CONDENSER
TYPE**

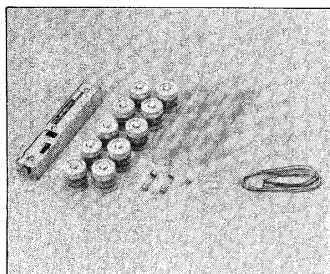

**RECHARGEABLE
BATTERY PACK
BATTERY CHARGER BC-20
BATTERY N-900 x 10
(900 mAh)**

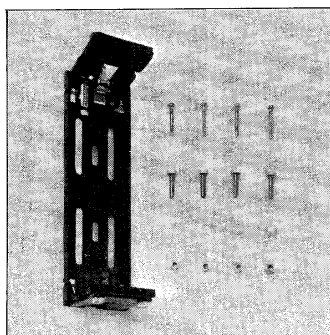

**MOBILE MOUNTING
BRACKET (B)
FOR IC-215**

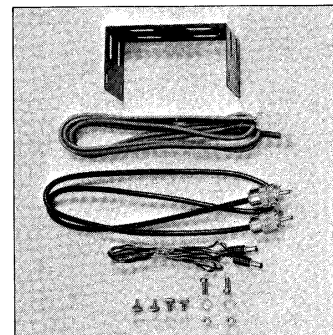

**MOBILE MOUNTING
KIT FOR IC-20L**



ICOM INCORPORATED

**1-6-19, KAMI KURATSUKURI, HIRANO-KU,
OSAKA JAPAN**

