

ICOM

INSTRUCTION MANUAL

DUAL BAND FM TRANSCEIVER

IC-24AT

IC-24ET

Downloaded by
RadioAmateur.EU

Icom Inc.

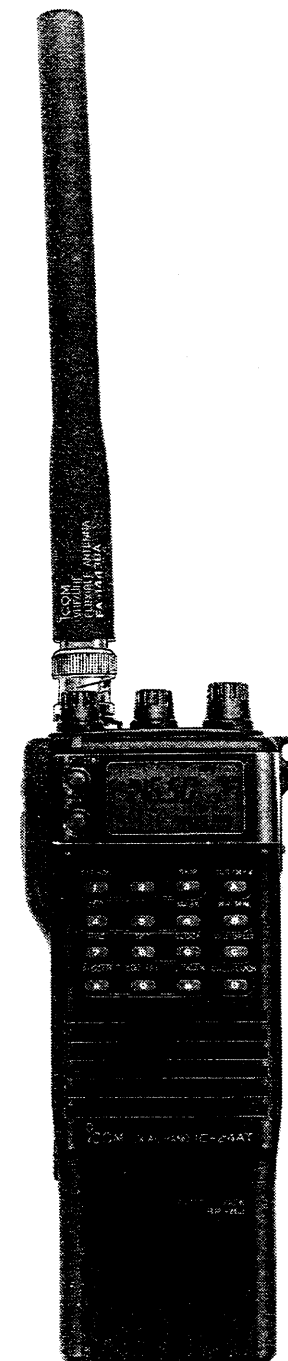

FIRST APPLYING POWER

The IC-24AT/ET includes an external BP-82* NiCd battery pack and a built-in rechargeable backup battery. At the time you purchase the IC-24AT/ET, the transceiver may not operate properly if the batteries are low.

Before operating, charge the battery pack and the backup battery fully, as follows:

- 1) Connect the supplied wall charger to the [DC 13.8V] jack on the top panel for charging. (See p. 5 for details.)
- 2) Wait until the external battery pack is fully charged. (See separate "LIST OF OPTIONS" for a charging period.)
- 3) Reset the CPU as mentioned at right.

*The Asia version is equipped with a BP-86 battery case. After putting batteries in the BP-86, reset the CPU.

RESETTING THE CPU

Be sure to reset the CPU in the transceiver when using the transceiver for the first time.

- 1) Rotate [VOL] counterclockwise fully to turn OFF power.
- 2) While pushing [FUNC] and [A](CLR), rotate [VOL] to turn ON power.
- 3) Release the switches.
 - The function display shows:

U.S.A. version	146.01, 440.00 MHz
Asia version	146.01, 430.00 MHz
Other versions	145.00, 430.00 MHz

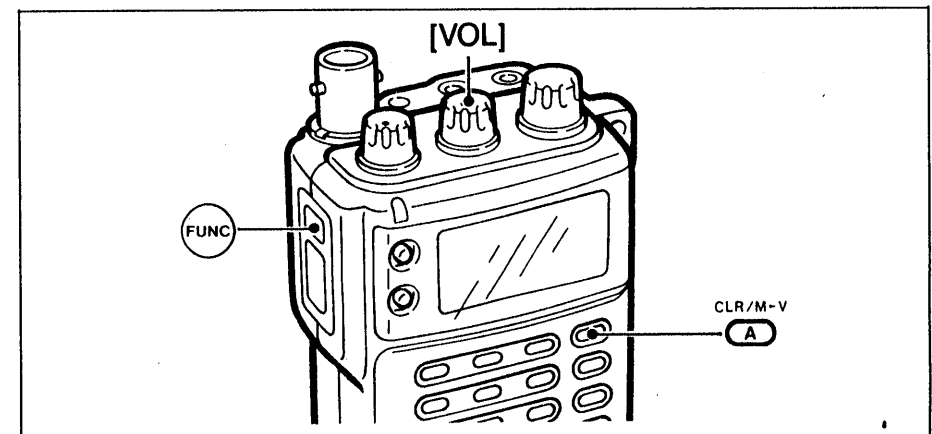

TABLE OF CONTENTS

FIRST APPLYING POWER	i
RESETTING THE CPU	i
TABLE OF CONTENTS	ii
IMPORTANT	1
OPERATING NOTES	1
CAUTIONS	1
FOREWORD	2
UNPACKING	2
1 FEATURES	3
2 PRE-OPERATION	4~6
2-1 Attaching accessories	4
2-2 Power Requirement	5
3 MODE CONSTRUCTION	7~8
3-1 Mode types	7
3-2 Mode construction chart	8
4 PANEL DESCRIPTION	9~14
4-1 Switches and controls	9
4-2 Keyboard	11
4-3 Function display	13
5 BASIC OPERATION	15~19
5-1 Setting a frequency	15
5-2 Receiving	17
5-3 Transmitting	17
5-4 Repeater operation	18
6 CROSSBAND FULL DUPLEX OPERATION	20
7 MEMORY OPERATION	21~24
7-1 Selecting a memory channel	21
7-2 Writing a memory	22
7-3 Dual band memory	22
7-4 Memory operation examples	23
7-5 Transferring a memory	24
7-6 Masking a memory	24
8 CALL CHANNEL OPERATION	25
8-1 Calling up a call channel	25
8-2 Transferring a call channel	25
8-3 Programming a call channel	25
9 DTMF MEMORY OPERATION	26
9-1 Programming a DTMF code	26
9-2 Transmitting a DTMF code	26
10 SCAN OPERATION	27~30
10-1 Scan types	27
10-2 Scan operation	28
10-3 Setting scan conditions	29
11 PRIORITY WATCH	31~32
11-1 Priority watch types	31
11-2 Priority watch operation	32
12 BEEP AND POWER SAVER	33
12-1 Beep tone ON/OFF	33
12-2 Power saver function	33
13 CLOCK AND TIMER OPERATION	34~36
13-1 Clock mode	34
13-2 Setting time	34
13-3 Power on timer	35
13-4 Auto power off	36
14 OPTIONAL UNIT OPERATION	37~38
14-1 Unit installations	37
14-2 Subaudible tone encoder	38
14-3 Tone squelch	38
15 TROUBLESHOOTING	39
16 SPECIFICATIONS	40
Schematic/block diagram	Separate

IMPORTANT

READ ALL INSTRUCTIONS carefully and completely before using the transceiver.

SAVE THIS INSTRUCTION MANUAL — This instruction manual contains important safety and operating instructions for the IC-24AT/ET.

OPERATING NOTES

BE CAREFUL! When transmitting for a long time with high output power, the rear panel may become hot.

When using the transceiver with the supplied BP-82 battery pack, we recommend operating with low output power. Battery power will be reduced quickly if the transceiver is operated continuously using high output power. Large-capacity battery packs with long operating times are available from Icom (see separate "LIST OF OPTIONS" for details).

CAUTIONS

NEVER connect the transceiver via the [DC 13.8V] jack to an AC outlet or to a power source of more than 16 V DC. These connections will ruin the transceiver.

NEVER connect the transceiver to a power source using reverse polarity. This connection will harm internal transceiver circuitry.

NEVER allow children to touch the transceiver.

NEVER use a non-recommended charger for battery charging. Suggested chargers are described on p. 5.

AVOID using or placing the transceiver in areas with temperatures below -10°C ($+14^{\circ}\text{F}$) or above $+60^{\circ}\text{C}$ ($+140^{\circ}\text{F}$).

AVOID placing the transceiver in direct sunlight.

AVOID the use of chemical agents such as benzine or alcohol when cleaning, as they can damage the transceiver surfaces.

FOREWORD

Thank you for purchasing the **IC-24AT/ET** 144/430 (440) MHz DUAL BAND FM TRANSCEIVER. The **IC-24AT/ET** is a state-of-the-art handheld that fits comfortably in the palm of your hand and combines ease of use with multi-operational capability.

Features include two bands in one body, keyboard selection, 5 W output power, power saver, auto power off, power on timer, built-in clock, crossband full duplex, 40 memory channels, 4 DTMF memory channels, priority watch, convenient scan functions, etc. In fact, the **IC-24AT/ET** has just about everything you could ask of a transceiver. And all these functions are placed into a small handheld designed for very easy operation.

To fully appreciate the capabilities of your new **IC-24AT/ET**, please read this instruction manual thoroughly before attempting operation. If you have any questions regarding the operation of the **IC-24AT/ET**, feel free to contact your nearest authorized Icom Dealer or Service Center.

UNPACKING

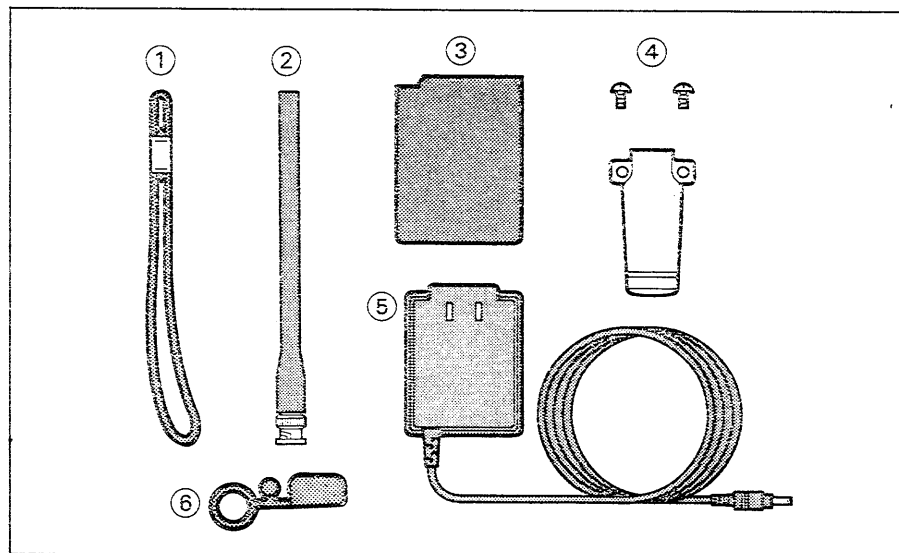

Accessories included with the IC-24AT/ET:	Qty.
① Handstrap	1
② Antenna (FA-1443BA)	1
③ Battery pack (BP-82) ^{*1}	1
④ Belt clip and screws	1 set
⑤ Wall charger ^{*2}	1
⑥ Rainproof cap	1

^{*1} BP-86 BATTERY CASE for IC-24AT Asia version.

^{*2} No charger included for IC-24AT Asia version.

SUPER COMPACT AND LIGHTWEIGHT

Transceiver dimensions are just 52 mm (2.0")W_x 136.5 mm (5.4")H × 34.5 mm (1.4")D*. And these dimensions include the BP-82 battery pack! What's more, the rounded body design gives you a feeling of even smaller transceiver dimensions.

*Asia version: 52 W × 156 H × 34.5 D mm

CROSSBAND FULL DUPLEX CAPABILITY

Icom's most advanced technology enables you to operate the transceiver with crossband full duplex. Simultaneously transmit on one band and receive on the other. It's just like talking on the telephone.

40 INDEPENDENT MEMORY CHANNELS AND 2 CALL CHANNELS

The IC-24AT/ET is equipped with 40 independent memory channels. Each memory channel memorizes repeater information such as offset and tone frequencies. 2 frequencies for VHF and UHF bands can be memorized on each memory. And a call channel is equipped for each band.

5 W OUTPUT POWER

It's hard to imagine 5 W of output power coming from such a small transceiver. Yet the IC-24AT/ET achieves this when connected to a 13.8 V DC power source. Also, 3 selectable low output power levels give you amazing versatility when transmitting.

BUILT-IN CLOCK WITH TIMER FUNCTION

The convenient built-in clock informs you of time. The timer function allows you to operate the timer on and auto power off functions. These functions conserve battery power for the times when you need it most.

4 DTMF MEMORY CHANNELS

The transceiver has 4 DTMF memory channels which memorize a DTMF code of up to 15 digits. Now there's no need for you to remember each DTMF code when accessing repeaters, using telephone lines, etc.

MORE CONVENIENT FEATURES

- 4 scan types: full, programmed, memory, selected band memory scans.
- Frequency skip and memory channel skip functions.
- Priority watch to check a particular frequency.
- Dial select function for quick tuning selection.
- External DC power jack with charging capability.
- Power saver function.

2-1 Attaching accessories

• ANTENNA AND RAINPROOF CAP

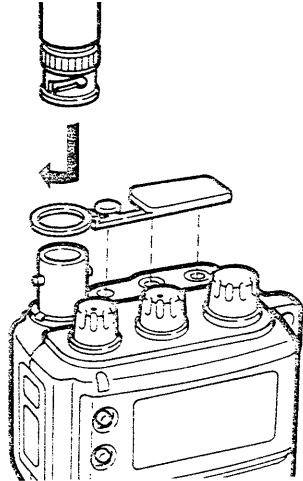

Attach the rainproof cap before connecting the antenna when desired.

Insert the supplied antenna onto the antenna connector and twist the connector on the antenna as shown in the diagram at left.

• HANDSTRAP ATTACHMENT

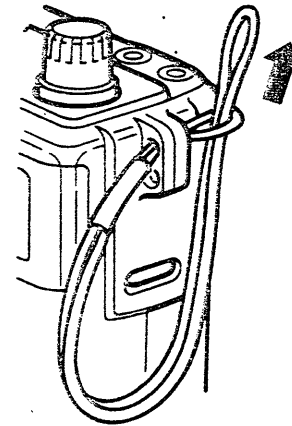

The handstrap allows you to easily carry the transceiver. Attach the handstrap as shown in the diagram at left.

• BELT CLIP

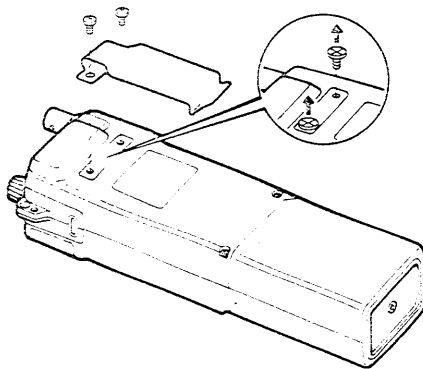

The belt clip allows you to attach the transceiver to your belt.

Remove the plastic screws when attaching the belt clip.

• BATTERY PACK REMOVAL

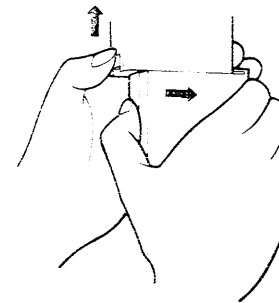

Push and hold the battery pack release button upwards, then slide the battery pack to the right with the transceiver facing you.

To attach the battery pack, mate the notched ends of the transceiver and the battery pack, and slide until a click sound is heard.

2 PRE-OPERATION

2-2 Power requirement

(1) POWER SOURCE

Use any of the following power sources when operating your IC-24AT/ET (except the Asia version):

- Supplied BP-82 battery pack.
- 6 ~ 16 V DC external power source through the [DC 13.8V] jack.
- Either optional battery packs BP-81 ~ BP-85 or six R6(AA) size dry batteries with an optional BP-86 BATTERY CASE.

IC-24AT Asia version:

- Six R6(AA) size dry batteries with the supplied BP-86 BATTERY CASE.
- 6 ~ 16 V DC external power source through the [DC 13.8V] jack.
- Optional battery packs BP-81 ~ BP-85.

(2) CHARGING BATTERY PACKS

To charge battery packs, connect a wall charger or optional CP-12 CIGARETTE LIGHTER CABLE WITH NOISE FILTER or OPC-254 MINI DC POWER CABLE to the [DC 13.8 V] jack on the transceiver, or use an optional BC-72 DESKTOP CHARGER. The BC-72 allows rapid charging, and also allows a battery to be charged alone.

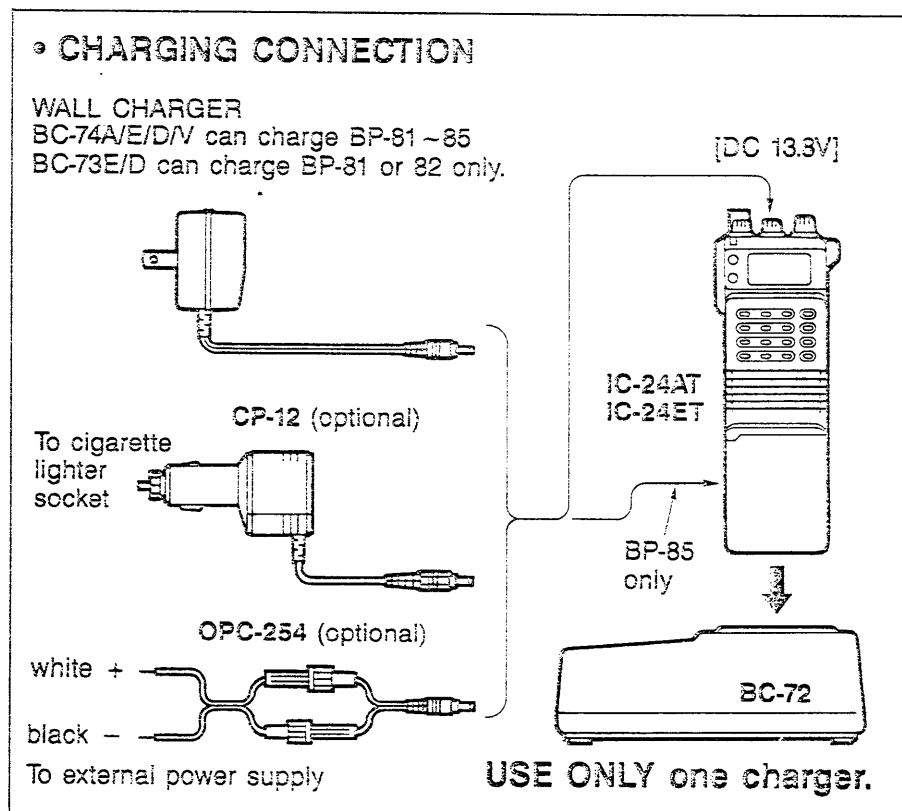

(3) CHARGING NOTES

NEVER attempt to charge dry batteries. Replace the batteries with new ones when the batteries become empty.

1. Icom rechargeable battery packs can be charged about 300 times. After 300 charges, a new battery pack should be purchased. The internal batteries of the battery pack are not replaceable.
2. Before charging, be sure the battery is nearly fully discharged. Many times charging a battery pack that is only partially discharged may not result in a full charge.
3. **DO NOT** turn ON power while charging as malfunctions may occur.
4. **AVOID** charging in extreme cold (under 0° C; +32° F) or extreme heat (over +40° C; +104° F).

(4) CHARGING PERIOD

- 1 ~ 1.5 hours when using the BC-72 DESKTOP CHARGER.
 - 15 hours when using other chargers.
- See separate "LIST OF OPTIONS" for details.

(5) BATTERY LIFE

The battery packs below have the following operating times when transmitting at high power for 1 min, receiving for 1 min, and standby for 8 min.

BATTERY PACK	OUTPUT VOLTAGE	APPROXIMATE OPERATING TIME*	
		144 MHz	430 MHz
BP-81	7.2 V	0.9 hrs.	0.8 hrs.
BP-82	7.2 V	2.5 hrs.	2.2 hrs.
BP-83	7.2 V	5.1 hrs.	4.5 hrs.
BP-84	7.2 V	8.5 hrs.	7.6 hrs.
BP-85	12 V	2.1 hrs.	1.9 hrs.

* Operating times may vary depending on operating conditions such as output power, temperature, etc.

(6) BACKUP BATTERY

The transceiver is equipped with a rechargeable built-in backup battery for retaining memory information.

NOTE: If the transceiver is not used within 1 week after the battery pack is exhausted, the capacity of the built-in backup battery may be exhausted and memory information is erased. At this time, charge the battery pack attached to the transceiver, then reset the CPU (see the inside front cover for reset information) and rewrite memories.

3-1 Mode types

The transceiver has 6 different modes for versatile, multi-function operations.

• VFO MODE

Used for normal operations over the entire bands, VHF and UHF.

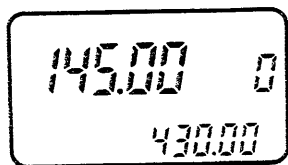

(VHF)

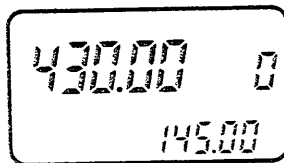

(UHF)

• MEMORY MODE

Used for operating the transceiver using memory channel contents. 40 memory channels are available for programming.

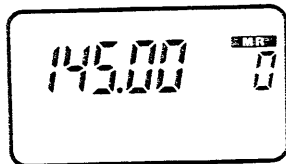

• CLOCK MODE

Used for setting the clock time, power on timer and auto power off time.

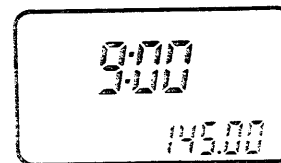

Sub display shows the main frequency.

• DTMF MEMORY MODE

Used for programming DTMF codes. 4 DTMF memory channels are available and each channel has up to 15 digits of programming capability.

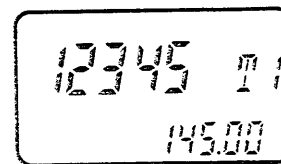

Sub display shows the main frequency.

• SET MODE

Used for initializing the transceiver conditions as described on p. 8.

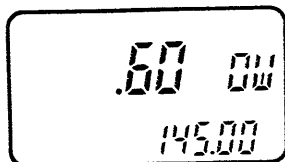

Each band has a SET mode separately.

Sub display shows the main frequency.

• CALL CHANNEL MODE

Used for operating the transceiver on a programmed CALL channel. The transceiver has 2 CALL channels for VHF and UHF bands separately.

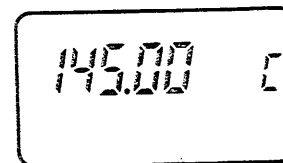

3-2 Mode construction chart

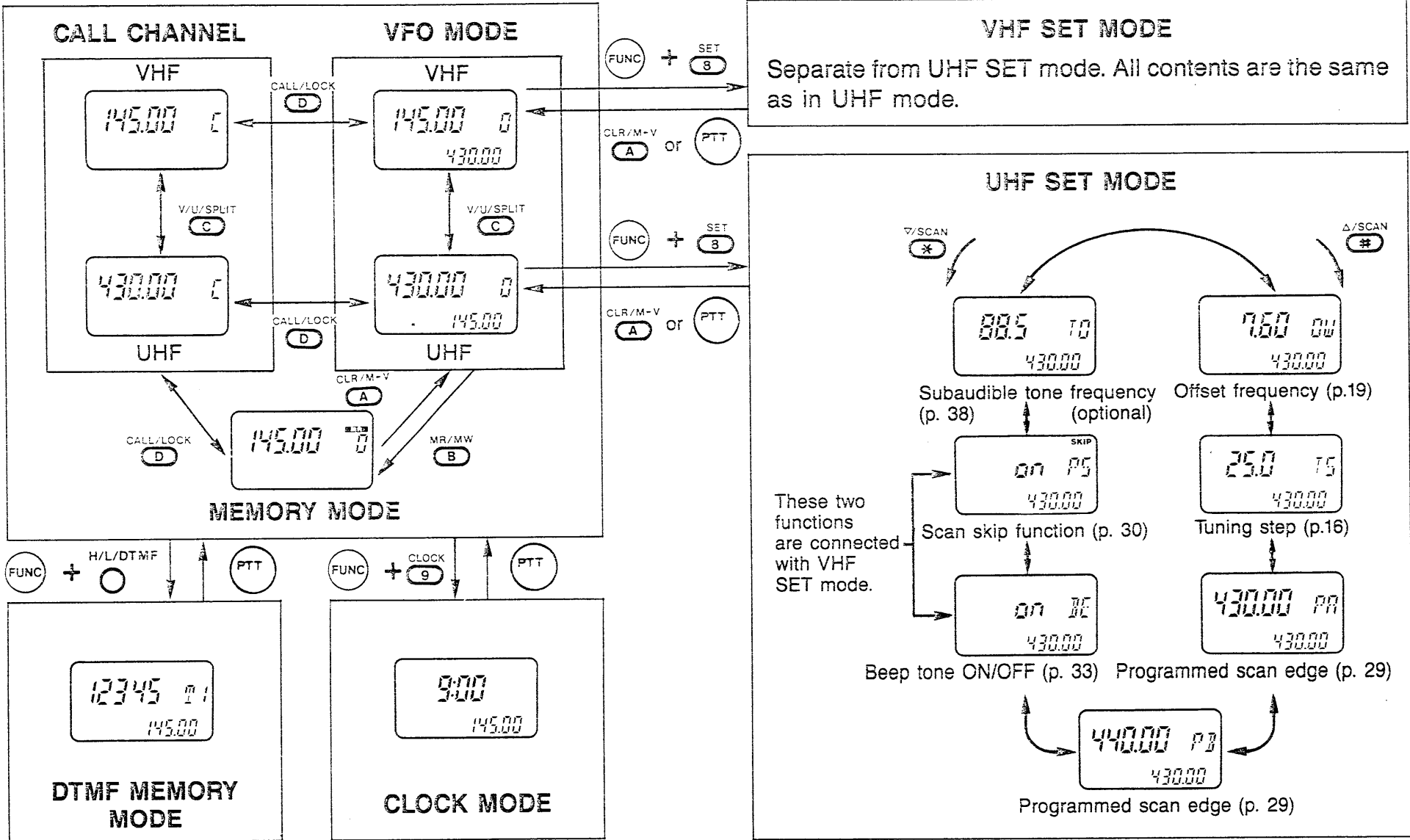

4-1 Switches and controls

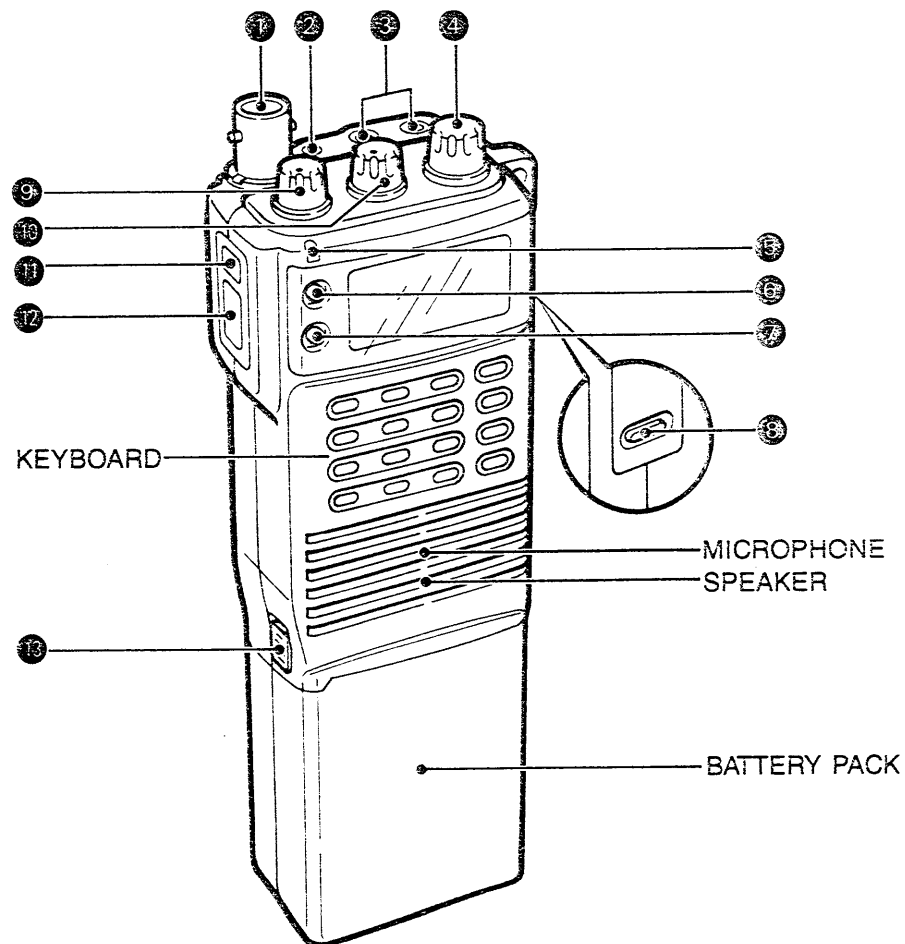

① ANTENNA CONNECTOR

Connects the supplied flexible antenna. (p. 4)

② EXTERNAL DC POWER JACK [DC 13.8 V]

Connects the supplied wall charger for charging the battery pack.

Allows operation with a 13.8 V DC power source using optional cables CP-12 or OPC-254 (see separate "LIST OF OPTIONS" for details).

The wall charger cannot be used to operate the transceiver.

③ EXTERNAL SPEAKER AND MICROPHONE JACKS [SP]/[MIC]

Connect an optional speaker-microphone or headset, if desired (see separate "LIST OF OPTIONS" for details).

The internal speaker and microphone will not function when either option is connected.

④ TUNING CONTROL

Sets an operating frequency or a memory channel.

⑤ TRANSMIT/RECEIVE INDICATOR

Lights up in green when squelch opens; lights up in red when transmitting.

Green lighting can be turned OFF for power saving, when required. (p. 17)

⑥ **TRANSMIT POWER SWITCH [H/L/DTMF]**

Selects high or low transmit output power. (p. 17)

- While pushing this switch and rotating the tuning control, the low output power level changes. (p. 18)

- While pushing [FUNC], push the switch to enter DTMF MEMORY mode. (p. 26)

⑦ **MONITOR SWITCH [MONI]**

Opens the squelch and optional tone squelch. (p. 17)

Checks the transmit frequency when duplex is operated (p. 18) or when crossband full duplex is operated. (p. 20)

While pushing [FUNC], push this switch to turn OFF the green receive indicator. This function conserves battery pack power. (p. 17)

⑧ **LIGHT SWITCH [LIGHT]**

Lights the display backlight for approx. 5 sec.

While pushing [FUNC], push this switch for continuous lighting. To turn OFF, push this switch again. The continuous lighting mode remains activated even if the power switch is turned OFF.

While pushing this switch together with some digit keys, turn power ON to initialize the scan resume condition (p. 29), power saver duty cycle (p. 33) or PTT switch function. (p. 18)

⑨ **SQUELCH CONTROL [SQL]**

Varies the squelch threshold point for audio mute.

⑩ **VOLUME CONTROL [VOL]**

Turns power ON and adjusts the audio level.

⑪ **FUNCTION SWITCH [FUNC]**

While pushing this switch, other switches function as secondary functions.

⑫ **PTT SWITCH [PTT]**

Push and hold to transmit; release to receive.

⑬ **BATTERY PACK RELEASE BUTTON**

Opens the latch for bottom cap removal when pushed upwards. (p. 4)

4 PANEL DESCRIPTION

4-2 Keyboard

KEY	FUNCTION	SECONDARY FUNCTION (While pushing [FUNC])
T/T SQL 1		Turns ON and OFF an optional subaudible tone encoder or tone squelch function. (p. 38)
2		No function.
SKIP 3		When selecting MEMORY mode: Programs the memory channel as the skip channel. (p. 30)
DUP 4		Selects in sequence: — duplex → + duplex → simplex. (p. 18)
5		No function.
MASK 6		When selecting MEMORY mode: Masks (makes blank) the memory channel. (p. 24)
PRIO 7		Starts and stops priority watch (p. 32).
SET 8		<ul style="list-style-type: none"> When selecting VFO mode: Enters SET mode. (p. 8) When selecting DTMF MEMORY mode: Programs DTMF code. (p. 26) When selecting CLOCK mode: Programs clock or timer time. (p. 34) When selecting MEMORY mode or a call channel: No function.
CLOCK 9		Enters CLOCK mode. (p. 34)
DIAL SEL 0		When selecting VFO mode: selects a dial select step. (p.16)

- When selecting VFO mode: Enter the digit for the operating frequency. (p. 15)
- When selecting MEMORY mode: Select the memory channel in the same tenth digit channels. (p. 21)
- When selecting DTMF MEMORY mode: Select the DTMF memory channel. (p. 26)
- When transmitting: Transmit DTMF tones.

KEY	FUNCTION	SECONDARY FUNCTION (While pushing [FUNC])
<p>V/SCAN * Δ/SCAN #</p>	<ul style="list-style-type: none"> ◦ When selecting VFO or MEMORY mode: Change the operating frequency or memory channel (pgs. 15, 21) To start full scan or memory scan, push and hold this key. (p. 28) ◦ When selecting SET or CLOCK mode: Change the display contents. (pgs. 8, 34) ◦ When selecting DTMF MEMORY mode: No function. 	<ul style="list-style-type: none"> ◦ When selecting VFO mode: Start and stop programmed scan. (p. 28) ◦ When selecting MEMORY mode: Start and stop selected band memory scan. (p. 28)
<p>CLR/M-V A</p>	<ul style="list-style-type: none"> ◦ When selecting VFO mode: Clears input digit before entry. (p. 15) ◦ When selecting MEMORY mode or a call channel: Returns to VFO mode. 	<p>When selecting MEMORY mode or a call channel: Transfers the contents into VFO mode by pushing and holding. (pgs. 24, 25)</p>
<p>MR/MW B</p>	<ul style="list-style-type: none"> ◦ When selecting VFO mode: Selects MEMORY mode. (p. 21) ◦ When selecting MEMORY mode: Changes the tenth digit of the memory channel number (p. 21) 	<ul style="list-style-type: none"> ◦ When selecting VFO mode: Writes the VFO contents into the memory channel by pushing and holding. (p. 22) ◦ When selecting the call channel: Writes the VFO contents into the call channel by pushing and holding. (p. 25)
<p>V/U/SPLIT C</p>	<ul style="list-style-type: none"> ◦ When selecting VFO mode: Changes a band. (p. 15) ◦ When selecting a dual band memory channel in MEMORY mode: Changes a band. (p. 22) ◦ When selecting CALL CHANNEL mode: Changes a call channel. (p. 25) 	<ul style="list-style-type: none"> ◦ When selecting VFO mode: Set a full duplex operation. (p. 20) ◦ When selecting a dual band memory channel in MEMORY mode: Return to simplex operation temporarily. (p. 22)
<p>CALL/LOCK D</p>	<p>Selects a call channel. (p. 25)</p>	<p>Turns ON the lock function. (p. 16)</p>

4 PANEL DESCRIPTION

4-3 . Function display

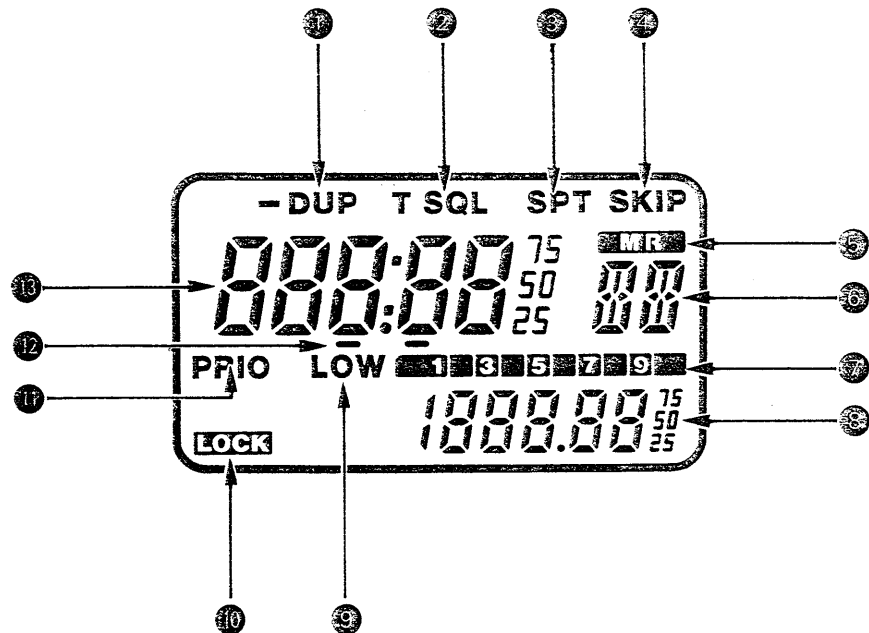

Downloaded by
RadioAmateur.EU

① DUPLEX INDICATORS

"DUP" or "-DUP" appears when duplex is selected. (p. 18) or when a memory channel or a call channel with duplex information is selected in MEMORY or CALL CHANNEL mode.

② TONE INDICATORS

"T" appears when operating the subaudible tone encoder. (an optional UT-50 or UT-51, see "LIST OF OPTIONS," is necessary.) (p. 38)

"T SQL" appears when operating the tone squelch function. (an optional UT-50 is necessary.) (p. 38)

③ SPLIT INDICATOR

Appears when setting the crossband full duplex function (p. 20) or when a dual band memory channel is selected in MEMORY mode. (p. 22)

④ SKIP INDICATOR

Appears when selecting the memory channel programmed as the skip channel. (p. 30)

Blinks during full scan or programmed scan when the frequency skip function is activated. (p. 28)

⑤ **MEMORY INDICATOR**

Appears when selecting MEMORY mode. (p. 21)

Blinks during memory scan. (p. 28)

⑥ **MEMORY CHANNEL READOUT**

Shows the selected memory channel number.

"C" appears when calling up a call channel. (p. 25)

⑦ **S/R/F INDICATOR**

Shows the relative signal strength when receiving, and output power selection when transmitting. (p. 18)

⑧ **SUB FREQUENCY DISPLAY**

Shows a sub frequency during normal operation.

Shows a transmitting frequency during crossband full duplex operation.

Shows a main frequency during SET mode, CLOCK mode or DTMF MEMORY mode.

The readout disappears when selecting a call channel or a memory channel not programmed in full duplex.

⑨ **LOW POWER INDICATOR**

Appears when selecting low output power. (p. 18)

⑩ **LOCK INDICATOR**

Appears when the lock function is activated. While the indicator appears, the keyboard and tuning control are electronically locked. (p. 16)

⑪ **PRIORITY INDICATOR**

Appears when the priority watch is activated. (p. 31)

⑫ **DIAL SELECT INDICATORS**

One indicator appears while pushing [FUNC]. It shows the digit to be changed with the tuning control. (p. 16)

When no indicator appears while pushing [FUNC], the memory channel can be selected by the tuning control.

⑬ **MAIN FREQUENCY DISPLAY**

Shows a receive and transmit frequency during normal operation.

Shows a receive frequency during duplex operation or crossband full duplex operation.

Functions as an information display in CLOCK mode, SET mode or DTMF MEMORY mode.

5-1 Setting a frequency

Before applying DC power, reset the CPU in the transceiver.
See the inside front cover for the instructions.

(1) USING THE TUNING CONTROL

- 1) Rotate [VOL] to turn power ON.
- 2) Push [A](CLR) to select VFO mode.
- 3) Push [C](V/U) to select the desired band, VHF or UHF.
- 4) Rotate the tuning control to set a desired operating frequency.
- 5) To change the frequency faster:
 - While pushing [FUNC], rotate the tuning control.
 - See p. 16 for changing the dial select step.

(2) USING THE KEYBOARD

- 1) Turn power ON. Proceed with steps 1, 2 and 3 at left.
- 2) Push the appropriate digit key to input the frequency.
 - When the wrong digit is input, push [A](CLR) to clear the input.
 - Push [5] or [0] for the final digit (4th pushing). ([2] or [7] is acceptable for the final digit according to selection circumstances when the 12.5 kHz step is selected.)
 - A decimal point appears when the input frequency is entered.
- 3) To change the frequency in the tuning step, push [*] (▽) or [#] (△).
 - Pushing [*] or [#] for more than 0.5 sec. starts full scan.

EXAMPLE: Setting frequency at 145.50 MHz using the keyboard.

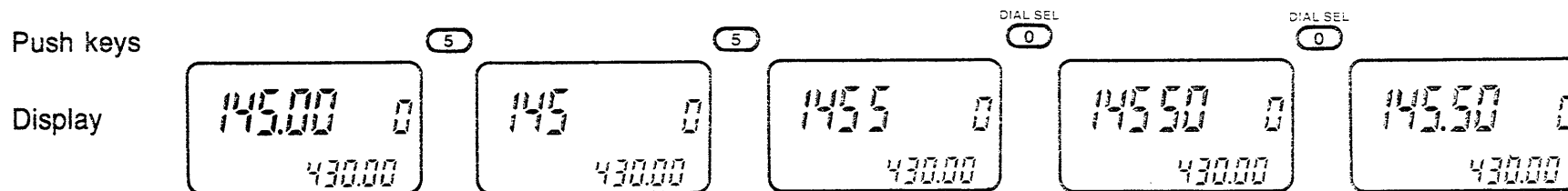

(3) SETTING A TUNING OR DIAL SELECT STEP

USING SET MODE

■ SETTING A TUNING STEP

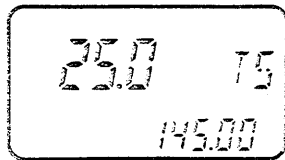

The display shows the tuning step for 25 kHz.

- 1) Push [A](CLR) to select VFO mode.
- 2) Push [C](V/U) to select the desired operating band, VHF or UHF.
- 3) While pushing [FUNC], push [8] (SET) to enter SET mode.
 - Refer to p. 8 for SET mode details.
- 4) Push [*] (▽) or [#] (△) several times until "TS" appears as shown above.
- 5) Rotate the tuning control to select the desired tuning step.
 - 5, 10, 12.5, 15, 20, 25 and 50 kHz steps are available.
- 6) Push [A] (CLR) or [PTT] to set the value and to exit SET mode.

■ SETTING A DIAL SELECT STEP

While pushing [FUNC], the tuning control changes the frequency in the following quick step.

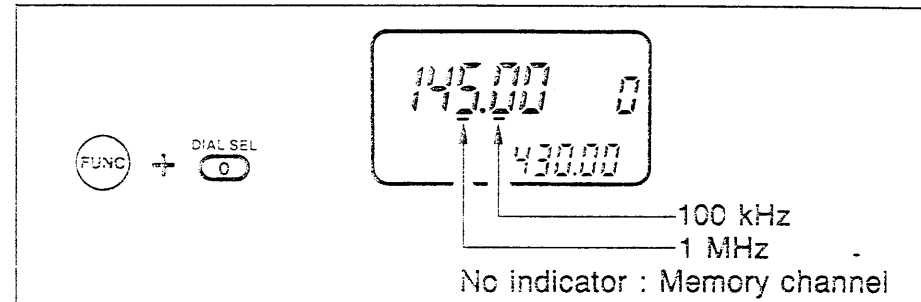

While pushing [FUNC], push [0] (DIAL SEL) to select the dial select step.

- Each push of [0] changes the steps.
(100 kHz → 1 MHz → Memory channel)
- In case no dial select indicators appear, memory channel numbers can be changed by the tuning control while pushing [FUNC].

(4) LOCK FUNCTION

The lock function electronically locks the tuning control and keyboard to prevent the frequency from changing accidentally.

- 1) While pushing [FUNC], push [D](CALL/LOCK) to turn ON the lock function.
 - "LOCK" appears.
- 2) To cancel the function, repeat step 1.

5 BASIC OPERATION

5-2 Receiving

- 1) Set [SQL] to maximum counterclockwise.
- 2) Rotate [VOL] to turn ON power and adjust the audio level.
- 3) Rotate [SQL] clockwise until the noise disappears.
- 4) Set the operating frequency using the tuning control or keyboard.
 - Refer to p. 15 for details.
- 5) When receiving a signal on the set frequency:
 - Squelch opens and the transceiver emits audio.
 - The S/RF indicator shows relative signal strength.
- 6) Push [MONI] when a weak signal cannot open the squelch completely.

■ RECEIVE INDICATOR ON/OFF

The receive indicator lights when the squelch opens. However, it can be turned OFF to conserve battery pack power.

- While pushing [FUNC], push [MONI] to turn the indicator OFF or ON.

5-3 Transmitting

CAUTION: Transmitting without an antenna may damage the transceiver.

NOTE: To prevent interference, listen on the frequency before transmitting using [MONI].

- 1) Set the operating frequency using the tuning control or keyboard.
 - Refer to p. 15 for details.
- 2) Push [H/L/DTMF] to select the output power.
 - "LOW" appears when selecting low power and disappears when selecting high power.
 - Low output power level can be changed. (p. 18)
- 3) Push and hold [PTT] to transmit.
 - The transmit/receive indicator lights up in red.
 - The S/RF indicator shows output power selection.
- 4) Speak into the microphone.
 - DO NOT hold the transceiver too closely to your mouth or speak too loudly. This may distort the signal.
- 5) Release [PTT] to receive.

■ SELECTING LOW OUTPUT POWER

Low output power can be selected in 3 levels to suit operating requirements such as communication distance, battery conservation, etc.

POWER SELECTION	S/RF INDICATOR	OUTPUT POWER (Approx.)	
		Using 13.8 V DC	Using 7.2 V DC
LOW 1	LOW	0.5 W	0.5 W
LOW 2	LOW	1.5 W	1.5 W
LOW 3	LOW	3.5 W	1.5 W
HIGH		5.0 W	1.5 W

Above values are typical.

While pushing [H/L/DTMF], rotate the tuning control.
 • The S/RF indicator shows output power selection as described above.

WITH POWER ON

■ PTT LOCK FUNCTION

Transmitting can be inhibited to prevent accidental transmission.

- While pushing the following switches, turn power ON:
 - [0] + [LIGHT]: [PTT] is electronically locked.
 - [*] + [LIGHT]: [PTT] is activated.

5-4 Repeater operation

When operating the transceiver with a station through a repeater, the repeater transmits your signal, allowing you to communicate with long distance stations even when low output power is used.

- 1) Set the operating frequency using the tuning control or keyboard.
 - Refer to p. 15 for details.
- 2) While pushing [FUNC], push [4](DUP) for – duplex and again for +duplex.
 - “– DUP” or “DUP” appears.
 - “– DUP” : Transmit freq. = Receive freq. – Offset freq.
 - “DUP” : Transmit freq. = Receive freq. + Offset freq.
- 3) Push and hold [PTT] to transmit.
 - The operating frequency on the main display automatically changes to the repeater input frequency.
 - See p. 19 when tones are necessary to operate a repeater.
- 4) Release [PTT] to receive.
- 5) Push [MONI] to check whether the repeater input frequency is busy or not.

5 BASIC OPERATION

• SUBAUDIBLE TONE

(An optional UT-50 or UT-51 is necessary.)

"T" appears

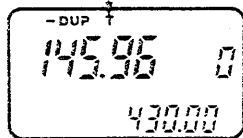

While pushing [FUNC], push [1] (T/T, SQL) until only "T" appears. To set a subaudible tone frequency, use SET mode. See p. 38 for details.

• DTMF TONES

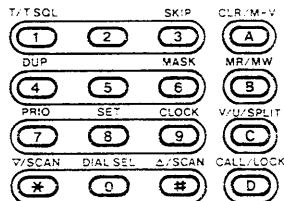

While pushing [PTT], push the desired digit key to transmit DTMF tones.

The transceiver has 4 DTMF memory channels. Each memory has the capability to memorize up to 15 DTMF digits. See p. 26 for details.

• 1750 Hz TONE CALL (IC-24ET)

- 1) Quickly push [PTT] 2 times and briefly hold [PTT] down (second push).
 - A 1750 Hz tone is transmitted.
- 2) Release and then push [PTT] again to transmit your voice signal.

USING SET MODE

■ OFFSET FREQUENCY SETTING

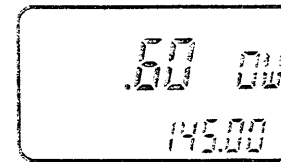

The display shows the offset frequency for 600 kHz (0.6 MHz).

- 1) Push [A] (CLR) to select VFO mode.
- 2) Push [C] (V/U) to select the desired operating band, VHF or UHF.
- 3) While pushing [FUNC], push [8] (SET) to enter SET mode.
 - Refer to p. 8 for SET mode details.
- 4) Push [*] (▽) or [#] (△) several times until "0W" appears as shown above.
- 5) Set the desired offset frequency in 25 kHz steps using the tuning control.
 - For quick setting, while pushing [FUNC], rotate the tuning control.
- 6) Push [A](CLR) or [PTT] to set the value and to exit SET mode.

Full duplex means simultaneously transmitting on one band and receiving on another band. In the receive condition the transceiver main display shows a receive frequency and the sub display shows a transmit frequency.

NOTE: To prevent howling, AVOID setting the UHF band frequency near the third multiple of the VHF band frequency.

We recommend using an earphone during full duplex operation.

When using an optional speaker-microphone, connect only the microphone plug to the [MIC] JACK on the top panel.

The optional HS-51 HEADSET can be used, however the HS-10 HEADSET cannot be used during full duplex operation.

- 1) Set the desired receive and transmit frequencies.
 - Receive frequency is set on the main display.
 - Transmit frequency is set on the sub display.
- 2) While pushing [FUNC], push [C] (V/U/SPLIT) to set the full duplex function.
 - "SPT" appears on the display.
- 3) Push [PTT] to transmit.
 - The transmit frequency appears on the main display.
 - The receive frequency appears on the sub display and can be received.
- 4) To cancel the function, repeat step 2.
 - "SPT" disappears.

NOTE: Full duplex can also be operated on a memory channel. See p. 22 for memory writing details.

■ MONITOR FUNCTION

- To monitor the transmit frequency while receiving, push and hold [MONI].
- To change the transmit frequency, rotate the tuning control while pushing [MONI].

7-1 Selecting a memory channel

The transceiver has 40 double-spaced memory channels for storing your most-often-used frequencies such as for use with repeaters, group calls, etc.

When first applying power or after resetting, memory channels 20 ~ 39 are blank.

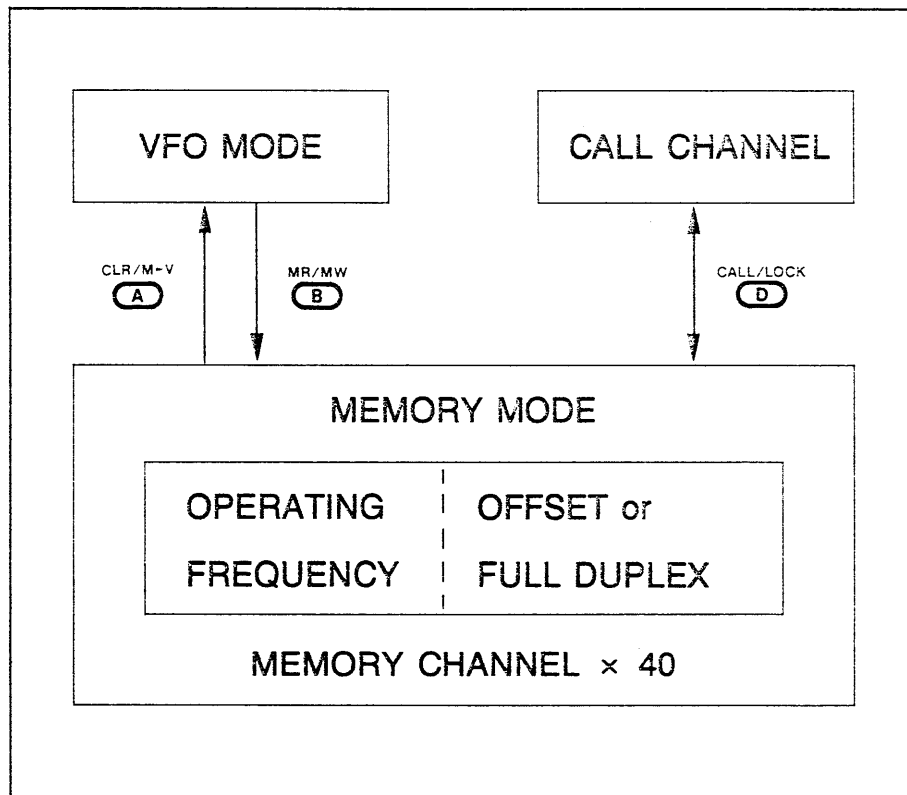

(1) USING THE TUNING CONTROL

- 1) Push [B](MR) to select MEMORY mode.
 - "MR" appears.
- 2) Rotate the tuning control to select the desired memory channel.

NOTE: Only programmed channels can be selected.

- 3) To select a blanked memory channel:
 - While pushing [FUNC], rotate the tuning control.
- 4) Push [A](CLR) to return to VFO mode.

The dial select function is helpful for selecting a memory channel number in VFO mode. See p. 16 for setting the dial select step for memory channel.

(2) USING THE KEYBOARD

- 1) Push [B](MR) several times to select the desired tenth digit of memory channels.
- 2) Push the appropriate digit key to select the desired unit digit of memory channels.
 - Pushing [*] (▽) and [#] (△) also allows you to select memory channels.
- 3) Push [A](CLR) to return to VFO mode.

7-2 Writing a memory

- 1) Select the memory channel to be programmed.
 - See Section 7-1 for details.
- 2) Push [A] (CLR) to select VFO mode.
- 3) Select the operating frequency on the main display.
- 4) If desired, program repeater or full duplex information.
 - For repeater information, see pgs. 8, 19, 38.
 - For full duplex information, see right (1).
- 5) While pushing [FUNC], push and hold [B] (MR/MW) until the transceiver emits 3 beeps.
- 6) After the frequency is written into the memory channel and you want to check the contents, push [B] (MR).

NOTE: Repeater information is automatically written into a memory except when full duplex information is written specially.

Each memory channel can separately store tone frequency, tone ON/OFF and *tone squelch ON/OFF, when the optional UT-50 or UT-51 are installed.

* UT-50 only

7-3 Dual band memory

Each of the 40 memory channels is double-spaced. When a frequency is programmed into each space, you can operate on 80 channels.

(1) WRITING

- 1) Select the memory channel to be programmed, then push [A] (CLR) to select VFO mode.
- 2) Set both VHF and UHF frequencies on the main and sub band displays.
- 3) While pushing [FUNC], push [C] (V/U/SPLIT).
 - "SPT" appears.
- 4) While pushing [FUNC], push [B] (MR/MW) until the transceiver emits 3 beeps to store the information.

(2) USING AS SIMPLEX

- 1) Select a memory channel programmed with dual band frequencies.
- 2) Push [C] (V/U) to move the desired frequency on the main display.
- 3) While pushing [FUNC], push [C] (V/U/SPLIT) to set simplex.
 - "SPT" disappears, but the crossband full duplex function still remains in the memory channel.

7 MEMORY OPERATION

7-4 Memory operation examples

- Selecting memory channel 35 using the keyboard.

Push keys

Display

- Writing 145.68 MHz into memory channel 30.

Push keys

Display

- Writing 145.50 and 436.80 into memory channel 25 as a dual band memory.

Push keys

Display

7-5 Transferring a memory

The function copies and transfers the displayed memory contents into the VFO. This function is useful for searching for signals around the memory frequency and for recalling the offset frequency which is independently programmed in each memory channel.

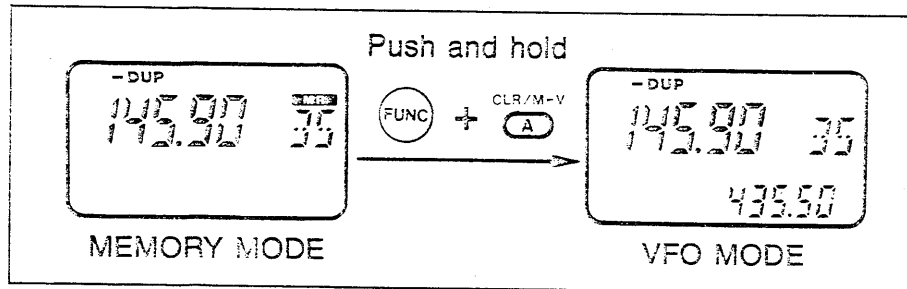

- 1) Push [B](MR) to select MEMORY mode.
- 2) Select the memory channel to be transferred:
 - Rotate the tuning control or push [B] several times, then push a digit key.
- 3) While pushing [FUNC], push and hold [A] (CLR/M►V) until the transceiver emits 3 beeps.
 - The memory contents are transferred into the VFO.
 - The transceiver returns to VFO mode.

7-6 Masking a memory

Unwanted memory channels can be masked (made blank). A masked memory channel cannot be selected for normal use. The contents of the masked memory can be recalled.

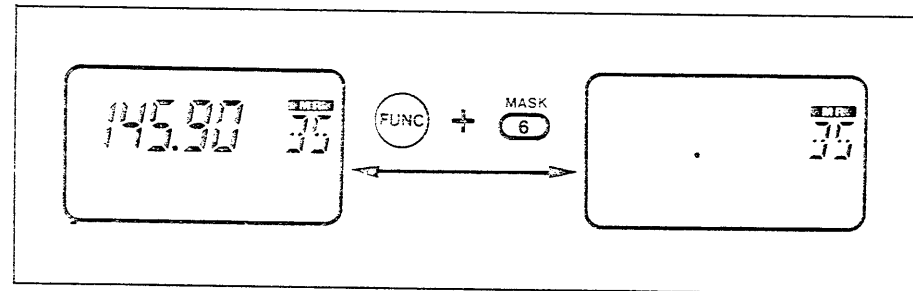

- 1) Push [B] (MR) to select MEMORY mode.
- 2) Select the memory channel in MEMORY mode to be masked:
 - Rotate the tuning control or push [B] several times, then push a digit key.
- 3) While pushing [FUNC], push [6] (MASK) to mask the displayed memory channel.
- 4) To recall the masked memory channel, repeat step 3.
- 5) Push [A] (CLR) to return to VFO mode.

8-1 Calling up a call channel

One-touch access call channels are provided for operation on your most-often-used frequencies. One call channel on each band can be set. The call channels are separate from the memory channels.

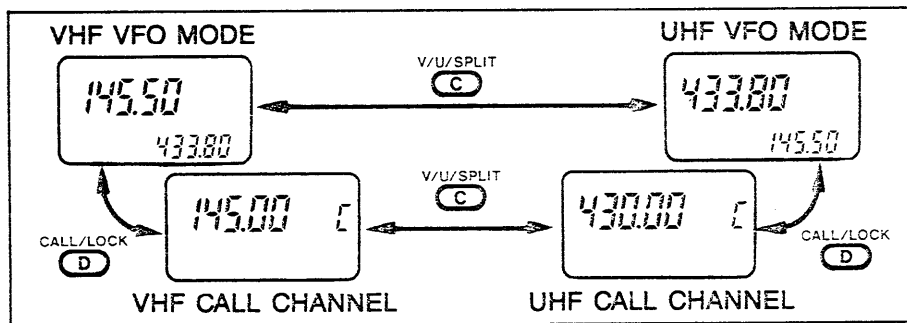

- 1) Push [D] (CALL) to call up a call channel.
- 2) Push [C] (V/U) to change the band when required.
- 3) To return to the previous mode, push [D] (CALL) again.

8-2 Transferring a call channel

- 1) Push [D] (CALL) to call up the call channel. Then push [C] (V/U) when required.
- 2) While pushing [FUNC], push and hold [A] (CLR/M \rightarrow V) until the transceiver emits 3 beeps to transfer the contents into the VFO.
 - VFO mode is automatically selected.

8-3 Programming a call channel

The call channel contents can be programmed in a similar way as the memory channels.

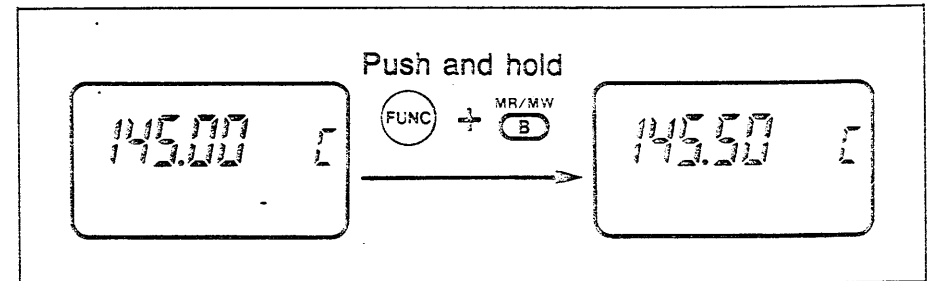

- 1) Push [A] (CLR) to select VFO mode.
- 2) Set the desired frequency (and duplex, when required) to be programmed into the call channel on the main or sub frequency display.
- 3) Push [D] (CALL) to call up the call channel, then select a band using [C] (V/U) when required.
- 4) While pushing [FUNC], push and hold [B] (MR/MW) until the transceiver emits 3 beeps.
 - The displayed frequency is changed to the same as the VFO frequency (same as the selected call channel).

9-1 Programming a DTMF code

The transceiver has 4 DTMF memory channels for storing your most-often-used DTMF codes of up to 15 digits.

- 1) While pushing [FUNC], push [H/L/DTMF]. Then push a digit key (1 ~ 4) or rotate the tuning control to select the desired DTMF memory channel.
 - Previous programmed digits are erased.
- 2) While pushing [FUNC], push [8] (SET) to prepare programming the DTMF memory.
 - Previous programmed digits are erased.
- 3) Push the appropriate digit keys to input the DTMF code.
 - When 15 digits are input, the transceiver stores the digits automatically.
 - When entering a wrong digit, push [H/L/DTMF] then repeat step 2 above to cancel the entered digits.

- 4) Push [H/L/DTMF] to store the input digits.
- 5) Push [H/L/DTMF] or [PTT] to exit DTMF MEMORY mode.
 - When [H/L/DTMF] is pushed, the transceiver emits the programmed code.

9-2 Transmitting a DTMF code

- 1) Select the desired DTMF memory channel:
 - See Section 9-1, step 1.
- 2) Push [PTT] to exit DTMF MEMORY mode.
- 3) To transmit the DTMF code in the selected channel:
 - While pushing [PTT], push [H/L/DTMF].

EXAMPLE: Programming digits of 1234567890 into DTMF memory channel T2.

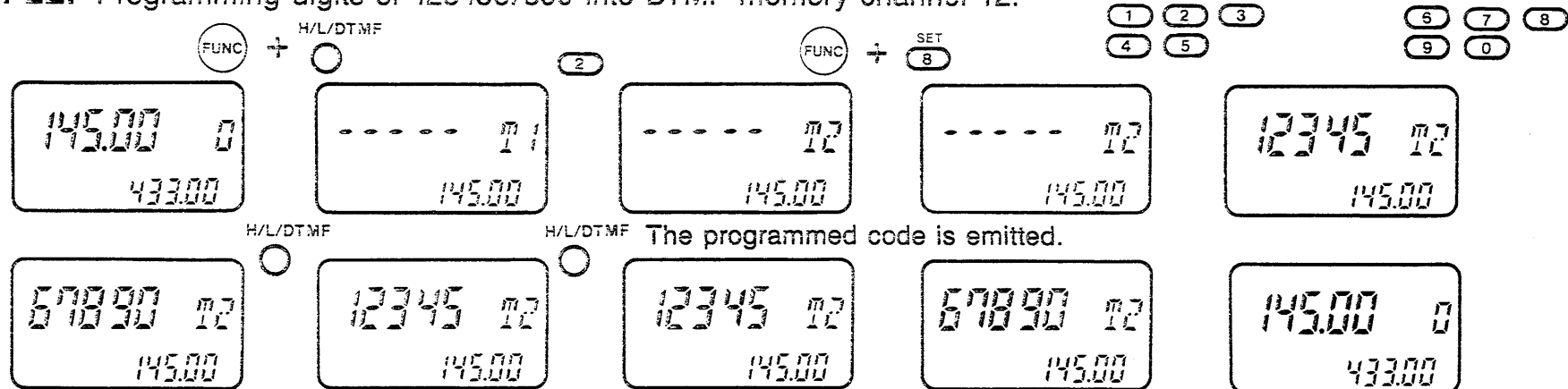

10 SCAN OPERATION

10-1 Scan types

The IC-24AT/ET has 4 scan types and 2 skip functions as described below. Perfect for hands-free operation.

• FULL SCAN

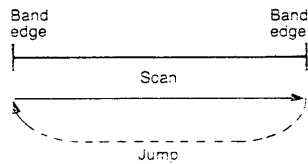

Repeatedly scans all frequencies in the entire 144 MHz or 430(440) MHz band. The frequency skip function can be used.

• PROGRAMMED SCAN

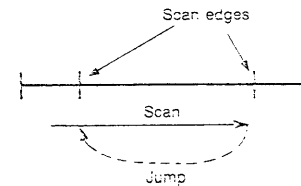

Repeatedly scans between two user-programmed frequencies. See p. 29 for scan edge programming. The frequency skip function can be used.

• MEMORY SCAN

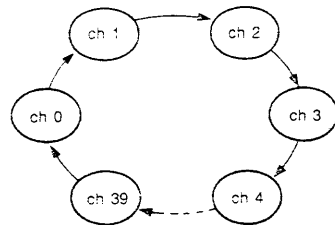

Repeatedly scans all memory channels in sequence. The memory skip function can be used during memory scan.

• SELECTED BAND MEMORY SCAN

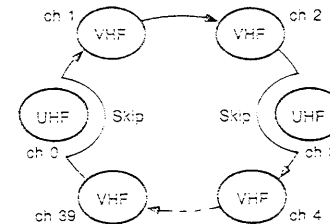

Repeatedly scans memory channels on only the same band as the start channel. Skips memory channels on a different band from the start channel.

• FREQUENCY SKIP FUNCTION

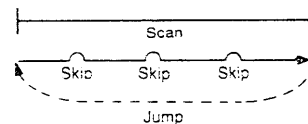

Skips unwanted signals that inconveniently stop scanning. See p. 29 for programming.



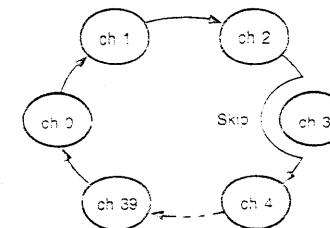

• MEMORY SKIP FUNCTION



Skips unnecessary memory channels, making shorter intervals for memory scanning. See p. 30 for programming.

10-2 Scan operation

Refer to the following table for any scan operation. However, before operating a scan, rotate the [SQL] control clockwise until audio is muted.

SCAN TYPE	① PRE-OPERATION	② SCAN START	③ SCAN RESUME CONDITION	④ SCAN STOP	WHILE SCANNING
FULL SCAN	Push [A] to select VFO mode.	Push and hold [*] or [#] for 0.5 sec.			During skip function 
PROGRAM-MED SCAN	Push [A] to select VFO mode.	While pushing [FUNC], push [*] or [#].	<ul style="list-style-type: none"> • Scan resumes 10 sec. after a signal is received or 2 sec. after a signal disappears. • Tuning control rotation restarts scan and changes scan direction. • Resume condition can be selected. See p. 29 for details. 	<ul style="list-style-type: none"> • Push [*] or [#]. • [A], [B], [C], [D] or [PTT] also stop the scan though the operating mode may be changed. 	During skip function  "PG" appears
MEMORY SCAN	Push [B] to select MEMORY mode.	Push and hold [*] or [#] for 0.5 sec.			
SELECTED BAND MEMORY SCAN	Push [B] to select MEMORY mode. Then select a memory channel stored a frequency on the disired scan band.	While pushing [FUNC], push [*] or [#].			

10 SCAN OPERATION

10-3 Setting scan conditions

(1) SETTING THE PROGRAMMED SCAN EDGES

USING SET MODE

Both VHF and UHF bands have two independent scan edges for each band.

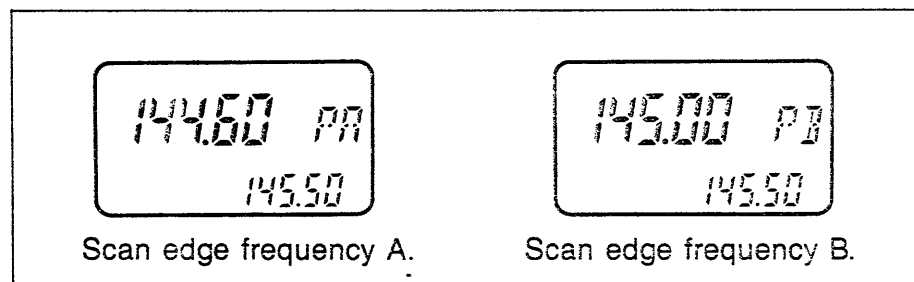

- 1) Push [A] (CLR) to select VFO mode.
- 2) Push [C] (V/U) to select the desired operating band, VHF or UHF.
- 3) While pushing [FUNC], push [8] (SET) to enter SET mode.
 - Refer to p. 8 for SET mode details.
- 4) Push [*](▽) or [#](△) several times until "PA" appears as shown above.
- 5) Set one scan edge frequency using the keyboard or tuning control.
- 6) Push [#](△) ("PB" appears), then set the other scan edge frequency.
- 7) Push [A] (CLR) or [PTT] to set values and to exit SET mode.

(2) SCAN RESUME CONDITION WITH POWER ON

2 resume conditions are available: pause and timer scan. When receiving a signal, pause scan pauses until the signal disappears; timer scan pauses for approx. 10 sec.

- While holding the following switches, turn ON power to change the condition.
 - [4] + [LIGHT] : Pause scan
(Scan pauses until signal disappears.)
 - [5] + [LIGHT] : Timer scan (Scan pauses for 10 sec.)

(3) FREQUENCY SKIP FUNCTION

- 1) Start full scan or programmed scan. See Section 10-2 (p. 28).
- 2) To program the received frequency as a skip frequency:
 - When scan pauses, push and hold [B] (MR/MW) while pushing [FUNC] until the transceiver emits 3 beeps.
 - Memory channel number 39 appears for a moment.
 - The channel number decreases when programming the next frequency. Memory channels 39 ~ 20 can be used for programming.

USING SET MODE

■ FREQUENCY SKIP FUNCTION ON/OFF

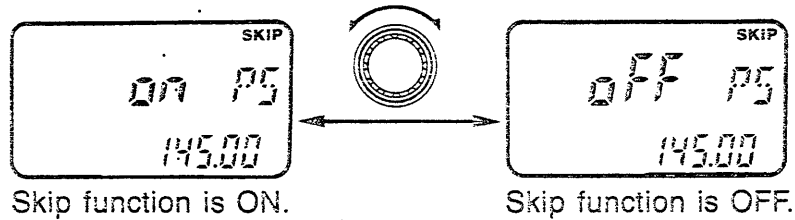

- 1) Push [A] (CLR) to select VFO mode.
- 2) While pushing [FUNC], push [8] (SET) to enter SET mode.
 - Refer to p. 8 for SET mode details.
- 3) Push [*](▽) or [#](△) several times until "PS" appears as shown above.
- 4) Rotate the tuning control to turn ON or OFF the frequency skip function.
- 5) Push [A] (CLR) or [PTT] to set the condition and to exit SET mode.

NOTE: Once the function is set on a band, the setting affects another band.

(4) PROGRAMMING A MEMORY SKIP CHANNEL

Undesirable memory channels can be skipped during memory scan. These skip channels are also skipped during priority watch (memory scan watch) and the frequencies of the channels are skipped during full or programmed scan.

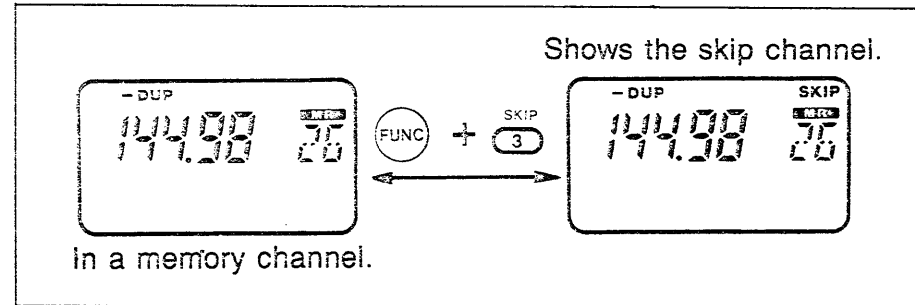

- 1) Push [B] (MR) to select MEMORY mode.
- 2) Select the memory channel to be programmed as the skip channel:
 - Rotate the tuning control or push [B] several times then push a digit key.
- 3) While pushing [FUNC], push [3] (SKIP) to program.
 - "SKIP" appears.
- 4) Repeat step 3 to delete the skip function from the memory channel.

11 PRIORITY WATCH

11-1 Priority watch types

• VFO ↔ ANOTHER VFO

While using a VFO frequency, priority watch checks another VFO in 5 sec. intervals.

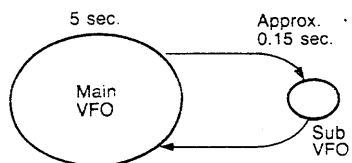

Start the watch from VFO mode.

• VFO ↔ MEMORY CHANNEL

While using a VFO frequency, priority watch checks the selected memory channel in 5 sec. intervals.

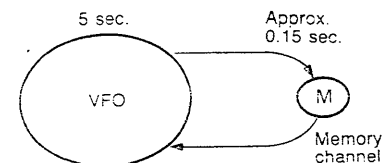

Start the watch from MEMORY mode.

• VFO ↔ CALL CHANNEL

While using a VFO frequency, priority watch checks the call channel on the band in 5 sec. intervals.

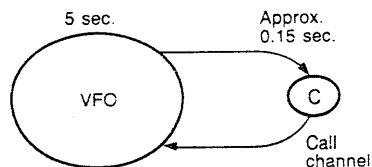

Start the watch from the call channel.

• VFO ↔ MEMORY SCAN

While using a VFO frequency, priority watch checks each memory channel. You can also program skip channels which will not be watched, making shorter scanning intervals.

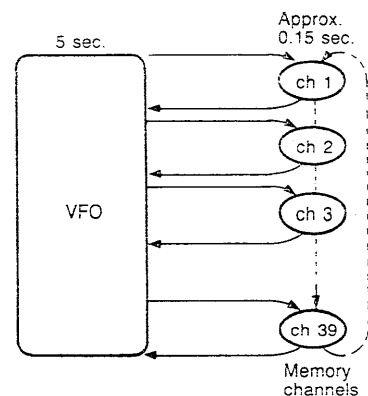

Start the watch during memory scan.

11-2 Priority watch operation

Refer to the following table for any priority watch operation. However, before operating the watch function, rotate [SQL] clockwise until audio is muted.

PRIORITY WATCH TYPE	① PRE-OPERATION	② START	③ RESUME CONDITION	④ STOP
VFO ↔ ANOTHER VFO	1) Push [A] to select VFO mode. 2) Set sub band frequency to be priority watched.	While pushing [FUNC], push [7].	<ul style="list-style-type: none"> • Priority watch pauses for 15 sec. when a signal is received on a watching channel and resumes 2 sec. after the signal disappears. • While the watch pauses, pushing [A] resumes watch manually. 	<ul style="list-style-type: none"> • While pushing [FUNC], push [7]. • [A], [B], [C] or [D] also stops the watch function. However, the mode may be changed.
VFO ↔ MEMORY CHANNEL	1) Push [B] to select MEMORY mode. 2) Set the memory channel to be priority watched.			
VFO ↔ CALL CHANNEL	Push [D] to call up a call channel.			
VFO ↔ MEMORY SCAN	1) Push [B] to select MEMORY mode. 2) Push and hold [*] or [#] to start memory scan.			

12 BEEP AND POWER SAVER

12-1 Beep tone ON/OFF

USING SET MODE

The transceiver emits a beep tone each time a switch is pushed. To turn ON and OFF the beep tone, use SET mode.

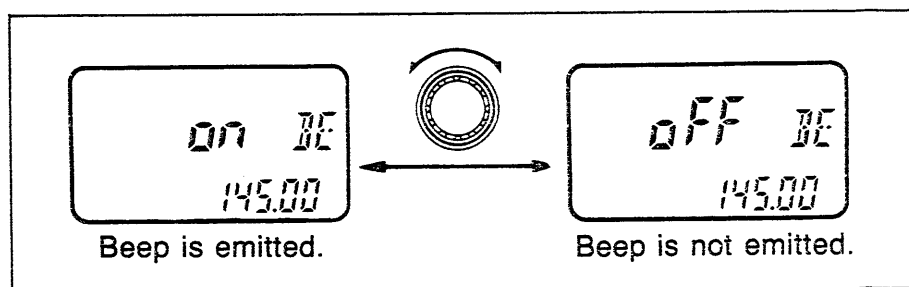

- 1) Push [A] (CLR) to set VFO mode.
- 2) While pushing [FUNC], push [8] (SET) to enter SET mode.
 - Refer to p. 8 for SET mode details.
- 3) Push [*](▽) or [#](△) several times until "BE" appears as shown above.
- 4) Rotate the tuning control to select beep "on" or "off."
- 5) Push [A] (CLR) or [PTT] to set the condition and to exit SET mode.

NOTE: Once the function is set on a band, the setting affects another band.

12-2 Power saver function

WITH POWER ON

The power saver function reduces the current drain to conserve battery power while receiving. The function is activated 5 sec. after the squelch closes or no switch is pushed.

A duty cycle of the power saver function (standby : circuit off) can be selected or turned OFF to suit your desired operation.

- 1) Turn power OFF.
- 2) While pushing the following switches, turn power ON.

SWITCHES	[7] + [LIGHT]	[8] + [LIGHT]	[9] + [LIGHT]
Standby	Power saver deactivates	125 msec.	125 msec.
Circuit off		500 msec.	approx. 2 sec.

Downloaded by
RadioAmateur.EU

13-1 Clock mode

The transceiver is equipped with a clock for operating the power on timer and auto power off timer.

- 1) While pushing [FUNC], push [9] (CLOCK) to enter CLOCK mode.
- 2) Push [PTT] to return to the previous mode.

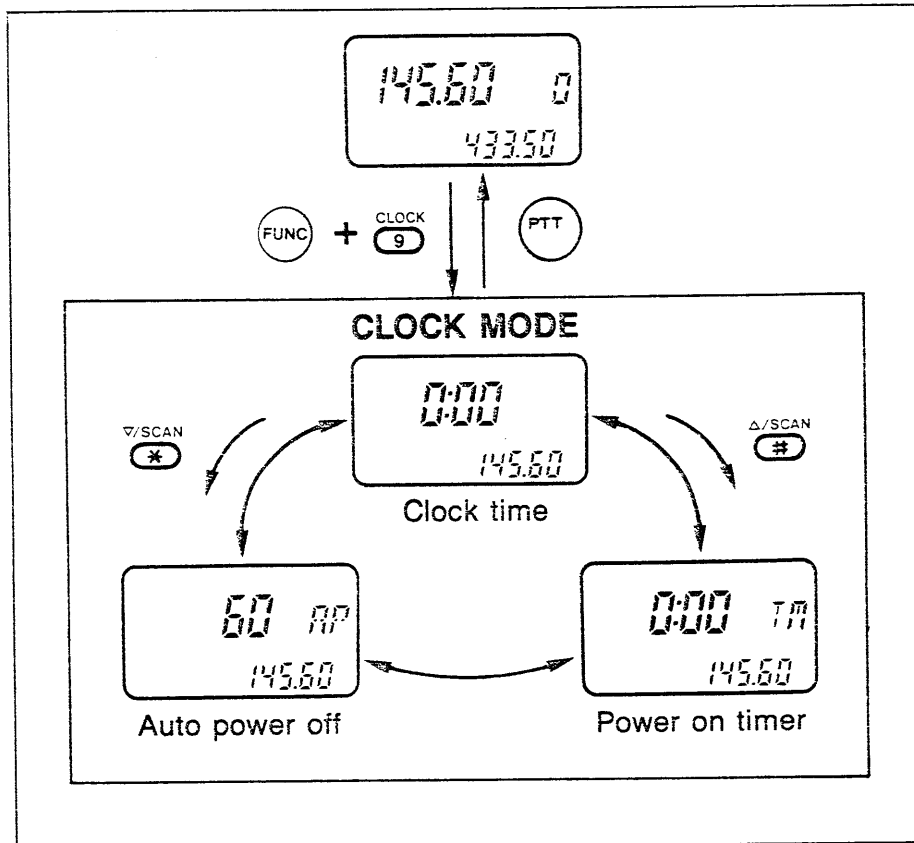

13-2 Setting time

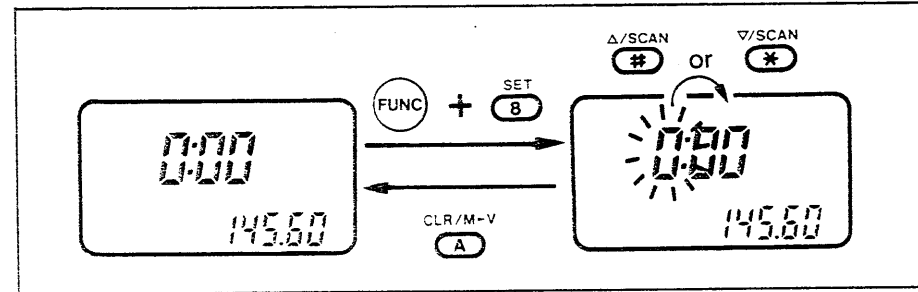

- 1) While pushing [FUNC], push [9] (CLOCK) to enter CLOCK mode.
- 2) Push [*](▽) or [#](△) to select the clock time display as shown above. See the chart in the lower left-hand corner.
- 3) While pushing [F], push [8] (SET). The displayed time blinks.
- 4) Rotate the tuning control to set the hours.
- 5) Push [*](▽) or [#](△), then rotate the tuning control to set the minutes.
- 6) Push [A] (CLR) to set the time.
- 7) Push [PTT] to exit CLOCK mode.

TIME ERROR: ± 1 min./week

NOTE: If the CPU is reset, the clock time returns to the initial condition. Be sure to set the time after resetting the CPU.

13 CLOCK AND TIMER OPERATION

13-3 Power on timer

The transceiver has a power on timer to fit your schedule and to save battery power. While the timer is activated, the transceiver is in the off condition, the function display shows the clock time and the transmitter and receiver circuits do not operate.

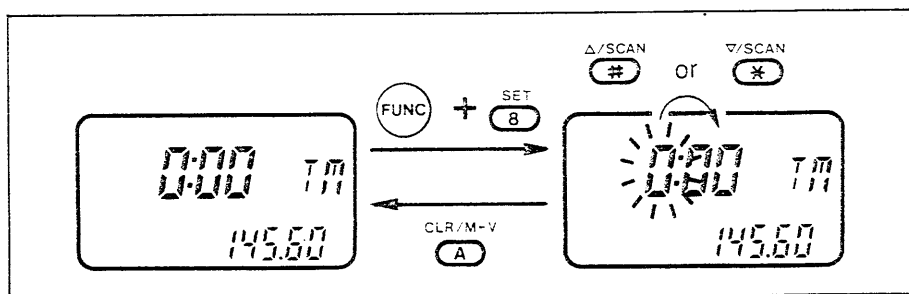

- 1) While pushing [FUNC], push [9] (CLOCK) to enter CLOCK mode.
- 2) Set the clock time. See Section 13-2 (p. 34) steps 2 ~ 6.
- 3) Push [*](▽) or [#](Δ) until "TM" appears as shown above.
- 4) While pushing [FUNC], push [8] (SET).
 - The displayed time blinks.

- 5) Rotate the tuning control to set the hours.
- 6) Push [*](▽) or [#](Δ), then rotate the tuning control to set the minutes.
- 7) Push [A] (CLR) to set the time.
- 8) To start the power on timer:
 - While pushing [FUNC], push [A] (CLR).
 - The decimal point appears, indicating the power on timer is activated.
 - DO NOT turn OFF the power with the [VOL] control.

To turn ON the transceiver while in the off condition, turn OFF then ON again using the [VOL] control.

[EXAMPLE]

Setting time at 9:30 and the power on time at 15:00.

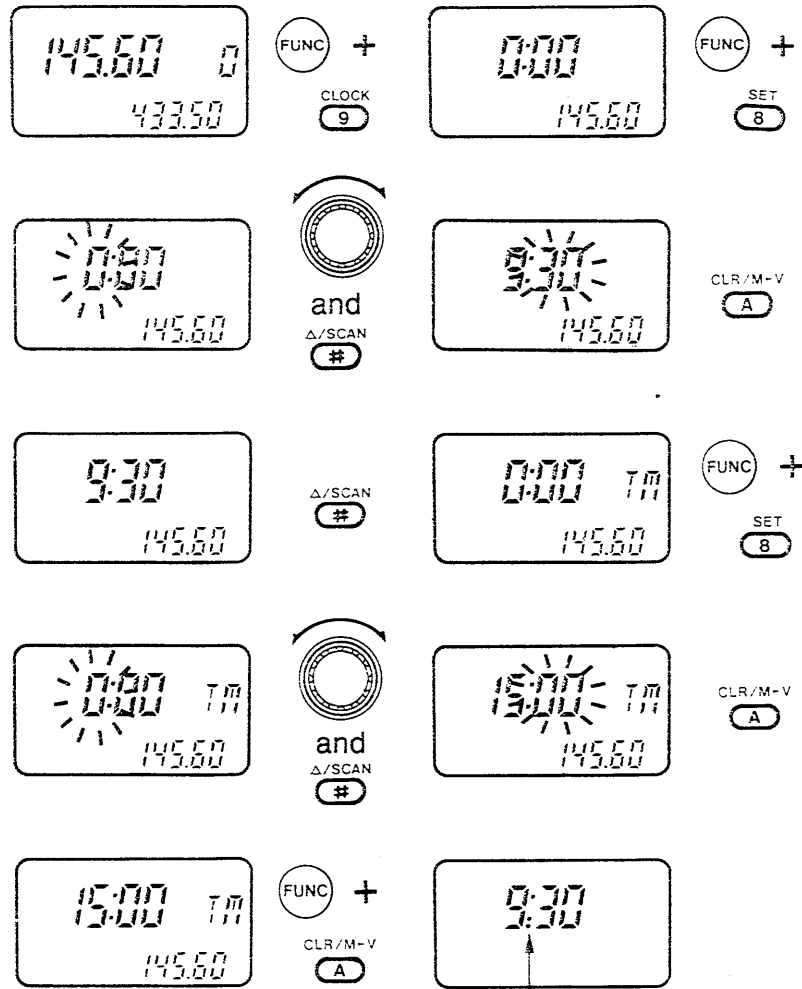

A dot appears when the power on timer is ON.

13-4 Auto power off

The transceiver automatically turns OFF after the selected time is reached when no switch is pushed or no signal is received. Time can be set in 20, 40 and 60 min. intervals. The function can also be deactivated using the "oFF" setting.

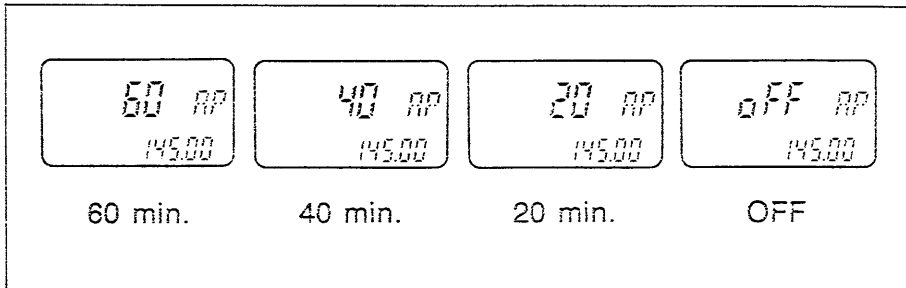

- 1) While pushing [FUNC], push [9] (CLOCK) to enter CLOCK mode.
- 2) Push [*](▽) or [#](△) several times until "AP" appears as shown above.
- 3) Rotate the tuning control to set the desired time or function OFF.
- 4) Push [PTT] to set the condition and to exit CLOCK mode.

To turn ON the transceiver while in the off condition, turn OFF then ON again using the [VOL] control.

14 OPTIONAL UNIT OPERATION

14-1 Unit installations

(1) DISASSEMBLING THE TRANSCEIVER

1) Turn power OFF, then remove the battery pack or case.

2) Unscrew the 5 screws.

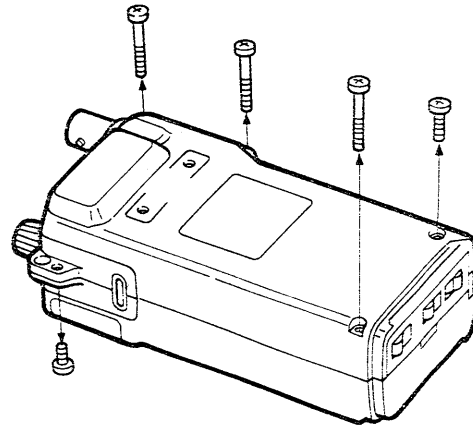

3) Open the transceiver.

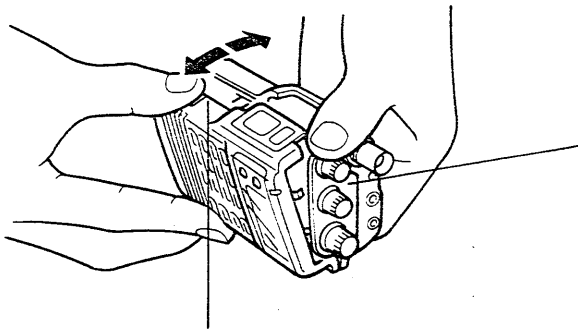

CAUTION:

DO NOT lose the small spring located here.

NOTE:

Keep attached to the rear panel.

CAUTION:

Flexible cables are fragile and can be damaged by mishandling.

(2) INSTALLATION LOCATIONS

- UT-50 TONE SQUELCH UNIT (ENCODER/DECODER)
- UT-51 PROGRAMMABLE TONE ENCODER

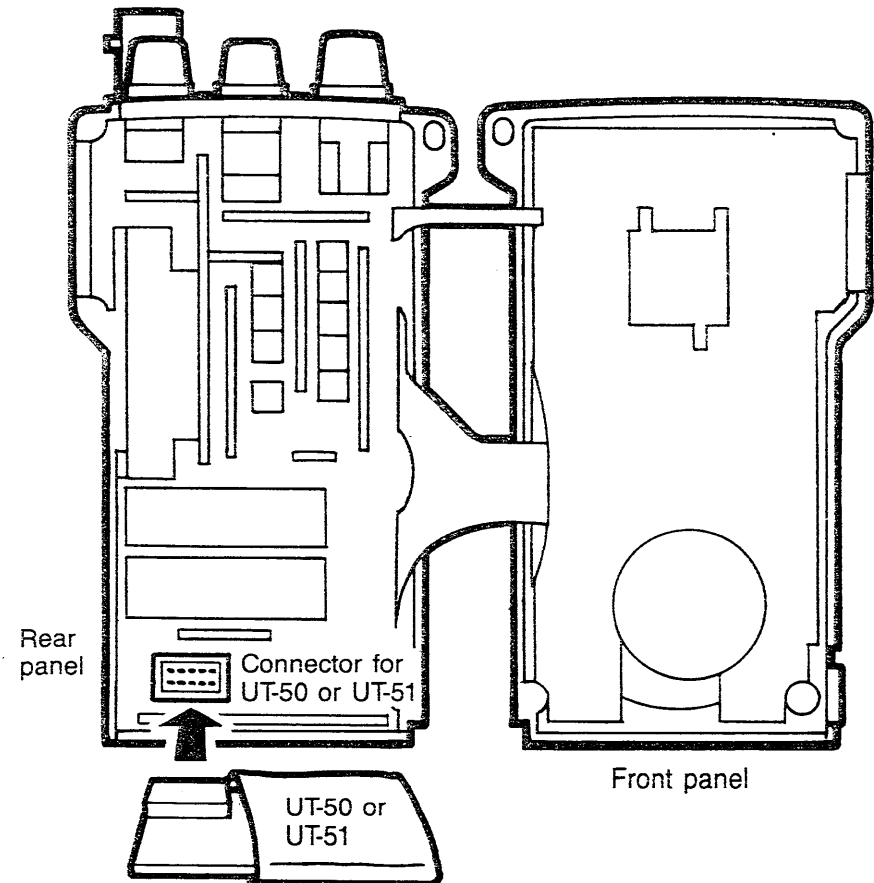

After installing the unit, reassemble the transceiver.

14-2 Subaudible tone encoder

When a repeater requires a subaudible tone, an optional UT-50 or UT-51 unit is necessary.

- 1) While pushing [FUNC], push [1] (T/T SQL).
 - “T” appears on the function display.
 - When the UT-50 is installed, push the switch until only “T” appears.
- 2) To set a subaudible tone frequency, see at right.
- 3) To turn OFF a subaudible tone, repeat step 1 until “T” or “T SQL” disappears.

14-3 Tone squelch (CTCSS)

The tone squelch function allows you to receive only signals with the same subaudible tone as that programmed in your transceiver.

An optional UT-50 TONE SQUELCH UNIT is necessary for operation.

- 1) While pushing [FUNC], push [1] (T/T SQL) until “T SQL” appears on the function display.
 - When only “T” appears, the subaudible tone encoder is activated.
- 2) To set a tone frequency, see at right.

- 3) To turn OFF a subaudible tone, repeat step 1 until “T” or “T SQL” disappears.

NOTE: The tone squelch cannot be used through a repeater equipped with a tone filter.

USING SET MODE

■ SETTING A TONE FREQUENCY

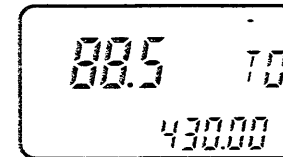

The display shows the tone frequency for 88.5 Hz.

- 1) Push [A] (CLR) to select VFO mode.
- 2) Push [C] (V/U) to select the desired operating band, VHF or UHF.
- 3) While pushing [FUNC], push [8] (SET) to enter SET mode.
 - Refer to p. 8 for SET mode details.
- 4) Push [*](▽) or [#](△) several times until “TO” appears as shown above.
- 5) Rotate the tuning control to set the desired frequency.
- 6) Push [A] (CLR) or [PTT] to set the value and to exit SET mode.

15 TROUBLESHOOTING

PROBLEM	POSSIBLE CAUSE	SOLUTION	REF.
<ul style="list-style-type: none"> • No power comes ON. 	<ul style="list-style-type: none"> • The battery pack is empty. • Poor plug connection when using an external DC power cable. 	<ul style="list-style-type: none"> • Charge the battery pack or replace dry batteries in the battery case. • Check the connection or remove the cable. 	p. 5
<ul style="list-style-type: none"> • No sound comes from the speaker. 	<ul style="list-style-type: none"> • [SQL] is turned too far clockwise. • The battery pack is empty. • An external speaker or earphone is connected. • The power off timer is activated. 	<ul style="list-style-type: none"> • Rotate [SQL] counterclockwise. • Charge the battery pack or replace dry batteries in the battery case. • Unplug the speaker or earphone. • Turn power OFF and ON again. 	p. 10 p. 5 p. 36
<ul style="list-style-type: none"> • No transmitting possible or only low power can be used. 	<ul style="list-style-type: none"> • The battery is empty. • Low power is selected. • The PTT lock function is activated. 	<ul style="list-style-type: none"> • Charge the battery pack or replace dry batteries in the battery case. • Select High output power. • While pushing [*] and [LIGHT], turn power ON. 	p. 5 p. 17 p. 18
<ul style="list-style-type: none"> • Frequency cannot be set. 	<ul style="list-style-type: none"> • The lock function is activated. • The call channel is selected. • The power off timer is activated. 	<ul style="list-style-type: none"> • Turn OFF the function. • Push [A] to select VFO mode. • Turn power OFF and ON again. 	p. 16 p. 25 p. 36
<ul style="list-style-type: none"> • The receive indicator does not light when squelch opens. 	<ul style="list-style-type: none"> • The receive indicator has been set in the off condition. 	<ul style="list-style-type: none"> • While pushing [FUNC], push [MONI]. 	p. 17
<ul style="list-style-type: none"> • The contents of the memories are erased. 	<ul style="list-style-type: none"> • The backup battery is exhausted because no charging has been performed for a long time. 	<ul style="list-style-type: none"> • Charge the battery pack attached to the transceiver for charging the backup battery. (Then reset the transceiver and rewrite memories.) 	p. 5

Downloaded by
RadioAmateur.EU

■ GENERAL

• Frequency coverage :

VERSION	FREQUENCY COVERAGE		
	TX/RX	VHF	UHF
IC-24AT (U.S.A.)	Transmit	140 ~ 150*	440 ~ 450
	Receive	138 ~ 174*	440 ~ 450
IC-24AT (Australia)	Transmit	144 ~ 148	430 ~ 440
	Receive	144 ~ 148	430 ~ 440
IC-24AT (Asia)	Transmit	140 ~ 150*	430 ~ 440
	Receive	138 ~ 174*	430 ~ 440
IC-24ET (Europe)	Transmit	144 ~ 146	430 ~ 440
	Receive	144 ~ 146	430 ~ 440
IC-24ET (Italy)	Transmit	140 ~ 150*	430 ~ 440
	Receive	138 ~ 174*	430 ~ 440

*Guaranteed frequency range is 144 ~ 148 MHz. Unit: MHz

- Mode : FM (F3)
- Tuning step increment : 5, 10, 12.5, 15, 20, 25, 50 kHz
- Antenna impedance : 50 Ω unbalanced
- Power supply requirement : Icom battery pack or battery case (BP-81 ~ BP-86)
External power jack 6 ~ 16 V DC
- Current drain (typical) (at 13.8 V DC) :

TX/RX	CONDITION	CURRENT DRAIN	
		VHF	UHF
Transmitting	High	1.3 A	1.6 A
	Low 1	0.5 A	0.7 A
Receiving	Rated output	150 mA	150 mA
	Power saved	16 mA	16 mA

- Usable temperature range : -10°C ~ +60°C (+14°F ~ +140°F)
- Dimensions* : 52(W) × 136.5(H) × 34.5(D) mm
(with the BP-82, and projections not included) 2.0(W) × 5.4(H) × 1.4(D) in.
- Weight* : 340 g (12 oz)
(with an antenna and the BP-82 battery pack)

*Differs from the Asia version equipped with a BP-86 battery case.

■ TRANSMITTER

- Output power : High 5 W
Low 3.5 W, 1.5 W, 500 mW (typical)
- Modulation system : Variable reactance frequency modulation
- Max. frequency deviation : ±5 kHz
- Spurious emissions : Less than -60 dB
- Microphone impedance : 2 kΩ

■ RECEIVER

- Receive system : Double-conversion superheterodyne
- Intermediate frequency : 1st 30.875 MHz
2nd 455 kHz
- Sensitivity : Less than 0.18 μV for 12 dB SINAD
- Spurious response rejection: More than 60 dB
- Audio output power : More than 200 mW at 10 % distortion with an 8 Ω load
- Audio output impedance : 8 Ω

All stated specifications are subject to change without notice or obligation.

Count on us!

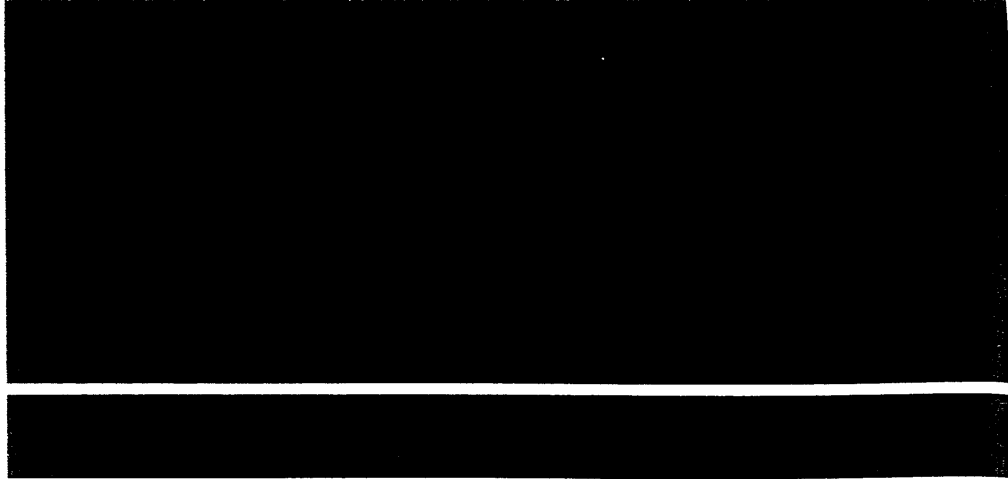

A-5082S-1EX
Printed in Japan
Copyright ©1989 by Icom Inc.

**Downloaded by
RadioAmateur.EU**

Icom Inc.
6-9-16, Kamihigashi, Hirano-ku, Osaka 547, Japan