

IC-275A/E

144MHz ALL MODE TRANSCEIVER

INSTRUCTION MANUAL

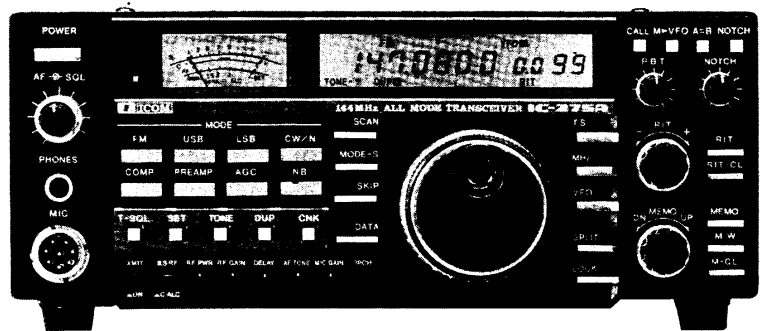

Downloaded by □



Amateur Radio Directory



FOREWORD

Thank you very much for choosing this ICOM product.

The most sophisticated, 144MHz all mode transceiver on the market today, the **IC-275A/E** is the result of both advanced ICOM engineering and state-of-art computer interface technology from ICOM such as the new CI-V System: a feature that allows for easy and convenient computer control of your **IC-275A/E**. In addition, the **IC-275A/E** is equipped with ICOM's pioneering new DDS (Direct Digital Synthesizer) System, an advanced, computer-developed innovation that eliminates the need for a PLL circuit in the **IC-275A/E**.

This recent engineering development is further evidence of ICOM's continuing commitment to meeting the increasingly sophisticated hi-tech needs of today's Amateur Radio operators by providing a product that operators require.

To fully understand and appreciate the uses of your new **IC-275A/E**, please study this instruction manual carefully prior to operation. Feel free to contact any authorized ICOM Dealer or Service Center if you have questions regarding the operation or capabilities of the **IC-275A/E**.

UNPACKING

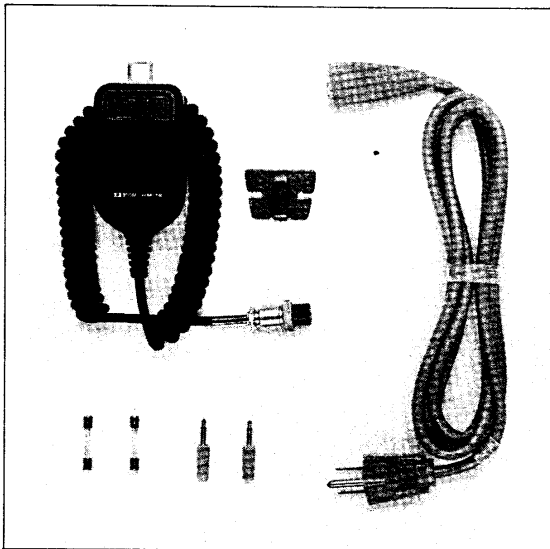

Accessories	Qty.
1. AC Power Cable	1
2. External Speaker Plug	1
3. Key Plug	1
4. Spare Fuses	2
5. Microphone	1
6. Microphone Hanger	1

- Please open the front and back covers of this instruction manual in the following way for reference assistance when using the IC-275A/E:

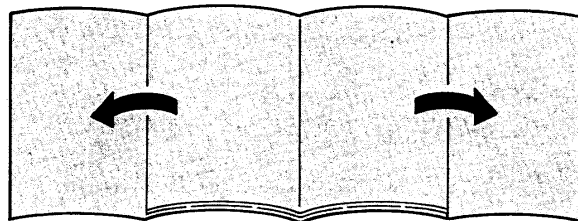

FRONT PANEL

See the back page for the FREQUENCY DISPLAY.

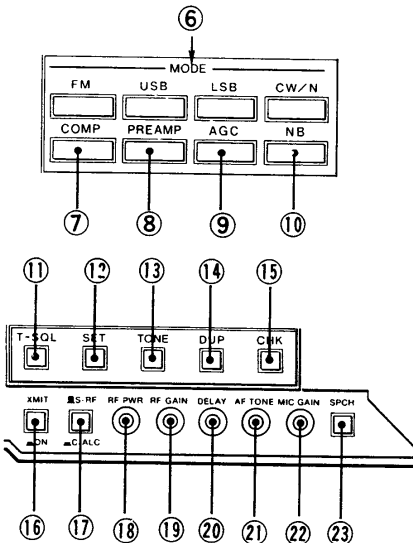
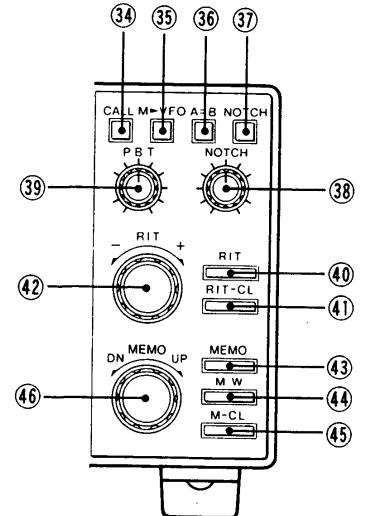
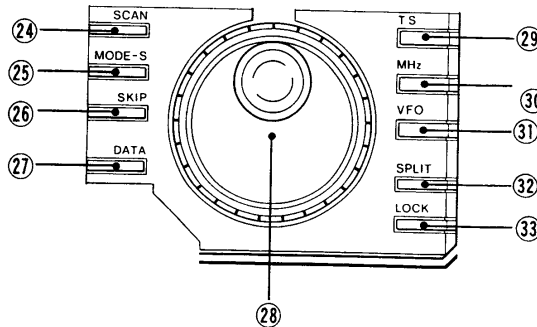
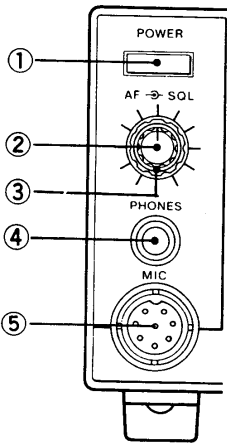
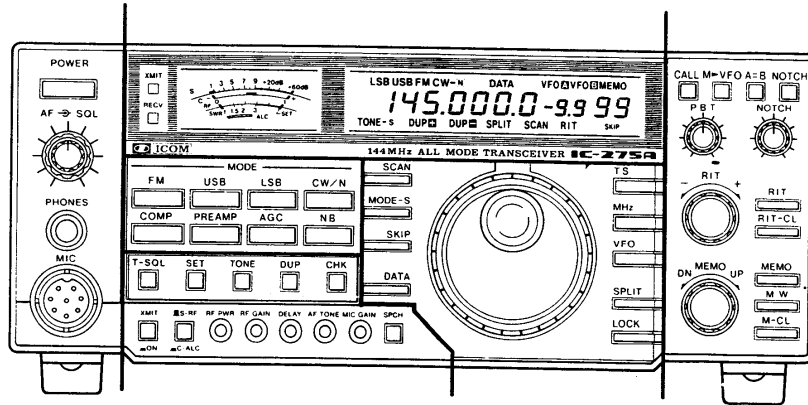
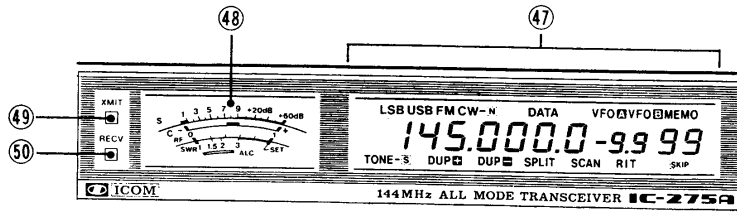

- ① POWER SWITCH
- ② AF GAIN CONTROL
- ③ SQUELCH CONTROL
- ④ PHONES JACK
- ⑤ MIC CONNECTOR
- ⑥ MODE SELECT SWITCHES
- ⑦ SPEECH COMPRESSOR SWITCH
- ⑧ PREAMP SWITCH
- ⑨ AGC SWITCH
- ⑩ NOISE BLANKER SWITCH
- ⑪ TONE SQUELCH SWITCH
- ⑫ TONE SET SWITCH
- ⑬ SUBAUDIBLE TONE FREQUENCY / TONE CALL (IC-275E) SWITCH
- ⑭ DUPLEX SWITCH
- ⑮ DUPLEX CHECK SWITCH
- ⑯ TRANSMIT/RECEIVE SWITCH
- ⑰ METER SWITCH
- ⑱ RF POWER CONTROL
- ⑲ RF GAIN CONTROL
- ⑳ CW DELAY CONTROL
- ㉑ AF TONE CONTROL
- ㉒ MIC GAIN CONTROL
- ㉓ SPEECH SWITCH
- ㉔ SCAN START/STOP SWITCH
- ㉕ SELECTED MODE MEMORY SCAN SWITCH
- ㉖ SKIP SCAN SWITCH
- ㉗ DATA SWITCH
- ㉘ TUNING CONTROL
- ㉙ TUNING STEP SELECTOR SWITCH
- ㉚ MHz TUNING STEP SWITCH
- ㉛ VFO SWITCH
- ㉜ SPLIT SWITCH
- ㉝ DIAL LOCK SWITCH
- ㉞ CALL CHANNEL SWITCH
- ㉟ FREQUENCY TRANSFER SWITCH
- ㊱ VFO EQUALIZING SWITCH
- ㊲ NOTCH FILTER SWITCH
- ㊳ NOTCH FILTER CONTROL
- ㊴ PASSBAND TUNING CONTROL
- ㊵ RIT SWITCH
- ㊶ RIT CONTROL
- ㊷ INCREMENTAL TUNING CONTROL
- ㊸ MEMORY READ SWITCH
- ㊹ MEMORY READ SWITCH
- ㊺ MEMORY WRITE SWITCH
- ㊻ MEMORY CLEAR SWITCH
- ㊼ MEMORY CHANNEL SELECTOR CONTROL
- ㊽ FREQUENCY DISPLAY
- ㊾ METER
- ㊿ TRANSMIT INDICATOR
- ⓪ RECEIVE INDICATOR

FREQUENCY DISPLAY

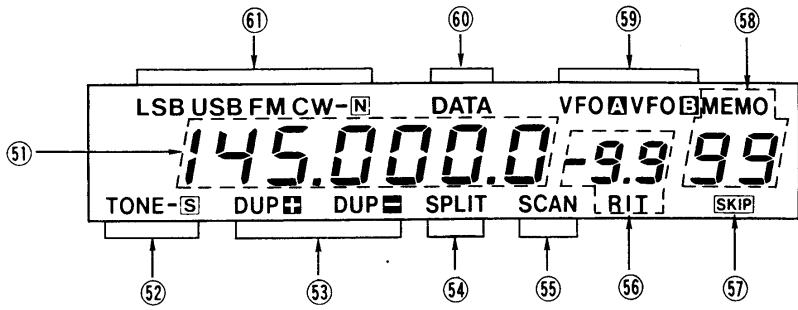

- ⑤① FREQUENCY READOUT
- ⑤② TONE SQUELCH INDICATOR
- ⑤③ DUPLEX INDICATOR
- ⑤④ SPLIT INDICATOR
- ⑤⑤ SCAN INDICATOR
- ⑤⑥ RIT/SHIFT FREQUENCY INDICATOR
- ⑤⑦ SKIP CHANNEL INDICATOR
- ⑤⑧ MEMORY MODE/MEMORY CHANNEL INDICATOR
- ⑤⑨ VFO INDICATOR
- ⑥① DATA INDICATOR
- ⑥① MODE INDICATOR

REAR PANEL

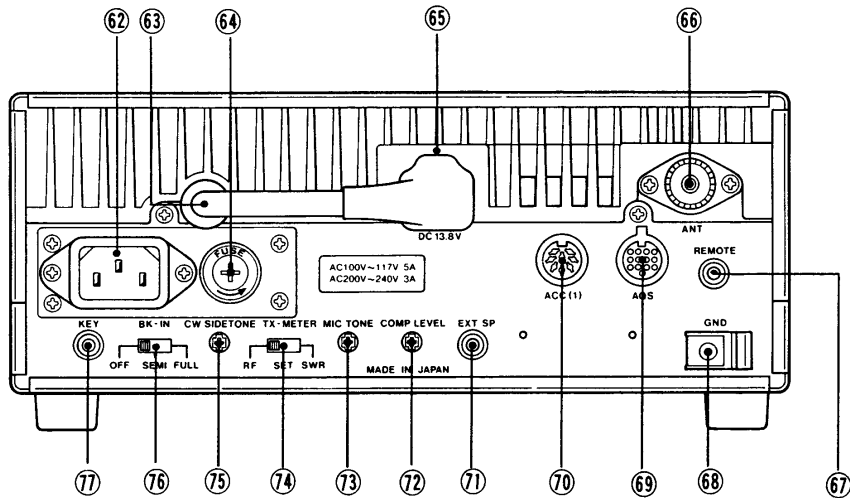

- ⑥② AC POWER SOCKET
- ⑥③ DC OUTPUT POWER CABLE
- ⑥④ FUSE HOLDER
- ⑥⑤ DC POWER SOCKET
- ⑥⑥ ANTENNA CONNECTOR
- ⑥⑦ REMOTE CONTROL JACK
- ⑥⑧ GROUND TERMINAL
- ⑥⑨ AQS SOCKET
- ⑦① ACC(1) SOCKET
- ⑦① EXTERNAL SPEAKER JACK
- ⑦② SPEECH COMPRESSOR LEVEL CONTROL
- ⑦③ MIC TONE CONTROL
- ⑦④ TX-METER SWITCH
- ⑦⑤ CW SIDETONE LEVEL CONTROL
- ⑦⑥ CW BREAK-IN SWITCH
- ⑦⑦ KEY JACK

SECTION 1 PRECAUTIONS AND PREPARATIONS

■ INSTALLATION LOCATIONS

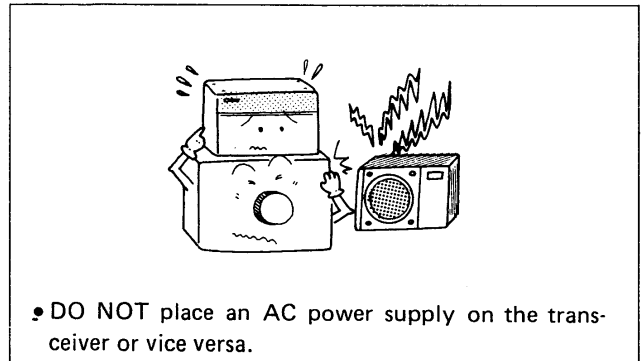
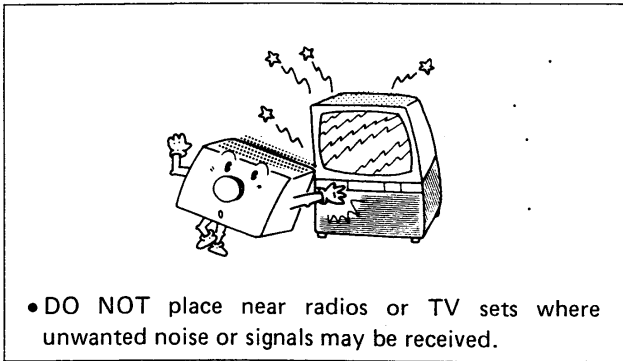
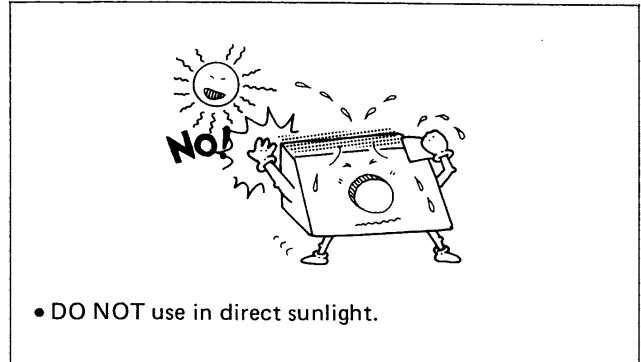
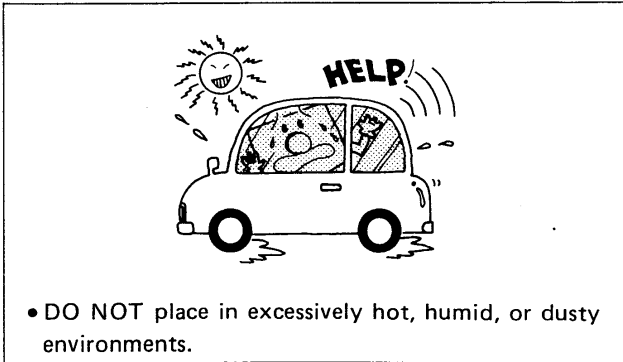

■ GROUNDING

To prevent electrical shocks, TVI, BCI and other problems, be sure to ground the transceiver through the GROUND TERMINAL. For best results, use the heaviest gauge wire or strap available and make the connection as short as possible.

ONLY use a city water pipe as a good earth point if the pipe is well grounded and made of metal. NEVER use a gas pipe or electrical conduit pipe for grounding.

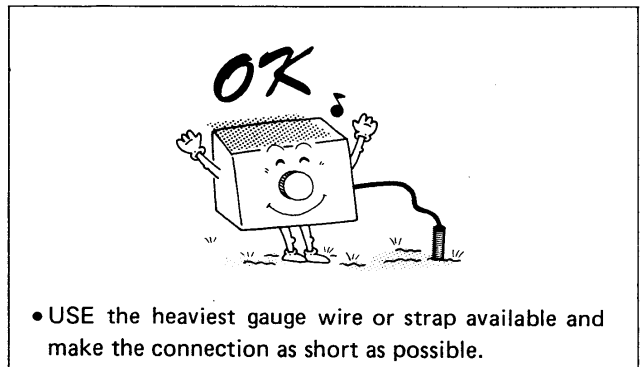
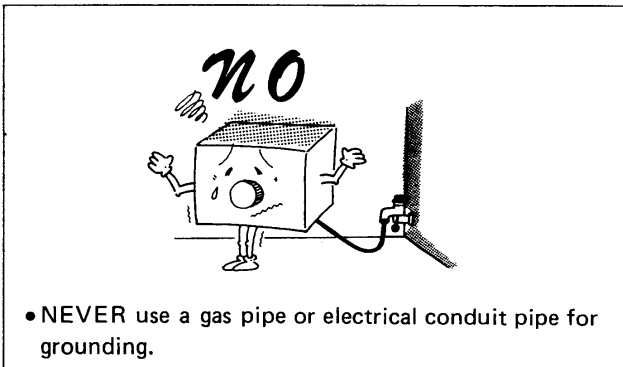

■ POWER SUPPLY

WARNING: Voltages greater than 15V DC may damage this transceiver. Check the source voltage before connecting the power cable when using this transceiver with non-ICOM AC power supplies.

SECTION 2 FEATURES

■ ICOM'S NEWLY DEVELOPED STATE-OF-THE-ART FREQUENCY SYNTHESIZER

- 5msec lockup time

ICOM proudly announces its recent technological breakthrough in developing a new frequency synthesizer system: the ICOM DDS (Direct Digital Synthesizer) unit. Operating in just 5 milliseconds, this new system provides one of the fastest transceiver lockup times available on the market today, and is ideal for use with the popular PACKET and AMTOR communications systems. ICOM engineering has achieved this through the design of a sophisticated PLL UNIT which mixes, in split second time, DDS generated source frequencies in an advanced double phase-locked loop system.

■ NEWLY DEVELOPED ICOM CPU INSTALLED

- Built-in, 99-channel large memory capacity.

Ninety-nine programmable memories are provided in the IC-275A/E to store frequency, mode, subaudible tone frequency, subaudible tone function ON/OFF, duplex direction, and offset frequency information. These memories are backed up by a lithium backup battery for up to five years.

- Advanced remote control system.

Full communications using a personal computer equipped with an RS-232C jack are possible by using the serial port mounted on the rear panel of the IC-275A/E. The computer controls frequency, mode, VFO A/B selection, and memories when an appropriate interface is used. The serial port uses a standard 1200 baud data rate.

- Easy-to-read display.

A newly designed LCD (Liquid Crystal Display) in the IC-275A/E uses a soft orange illumination for easy visibility when operating on bright days. This display indicates the VFO in use, operating mode, memory channel, split mode, scan mode and other information.

- Scanning versatility.

The IC-275A/E incorporates a total of four separate scanning functions for easy access to a wide range of frequencies.

- **MEMORY SCAN** repeatedly scans the entire 99-channel memory in sequence.
- **PROGRAMMED SCAN** offers detailed coverage of a specific frequency range through repeated scanning.
- **SELECTED MODE MEMORY SCAN** automatically monitors all memories which contain programmed frequencies with a similar mode.
- **SKIP SCAN** allows you to continuously scan your favorite programmed memory channels.

■ OUTSTANDING RECEIVER PERFORMANCE

- PBT and NOTCH control.

ICOM's Passband Tuning and Notch Filter systems have been incorporated in the past as standard high class features in ICOM HF transceivers, but now these convenient features can also be enjoyed in a VHF transceiver: the IC-275A/E. Passband Tuning allows continuous center frequency adjustment of the IF passband, while the IF Notch Filter provides clear operating reception even in the presence of strong interference.

- High sensitivity, high dynamic range.

■ COMPLETE VHF TRANSCEIVER

- Compact size.
- PACKET, AMTOR operations.
- Full break-in function.

The IC-275A/E RF amplifier uses a low noise figure, high gain, disk-type GaAs-FET (3SK121) for UHF applications. And since it also uses a balanced-type mixer incorporating Junction-FETs (2SK125) in the mixer stage, high sensitivity and a very high dynamic range are ensured.

The IC-275A/E's compact size - only 241mm(9.5'')(W) x 94mm (3.7'')(H) x 239mm(9.4'')(D) - simplifies installation in most mobile and portable situations: in automobiles, airplanes, boats or even in suitcases.

The rear panel of the IC-275A/E has an easy-to-access terminal socket for AFSK (Audio Frequency Shift Keying) operation. Use the [DATA] SWITCH to rapidly switch between receive and transmit operations. This convenient function is made possible in the IC-275A/E by ICOM's exclusive new DDS (Direct Digital Synthesizer) System.

For CW operators, both semi break-in and full break-in are provided for smooth, fast, and natural CW conversations.

■ OPTIONS AVAILABLE

- AG-25 PREAMPLIFIER UNIT
- UT-36 VOICE SYNTHESIZER UNIT
- UT-34 TONE SQUELCH UNIT
- CT-16 SATELLITE INTERFACE UNIT
- CT-15* AQS ADAPTER
- FL-83 CW NARROW FILTER
- CR-64 HIGH-STABILITY CRYSTAL UNIT

- Mast-mounted-type 144MHz preamplifier.
- Announces the displayed frequency and mode, etc.
- Provides you with interference-free communications.
- Satellite communication interface unit with IC-475A/E.
- See the functions listed below.
- ±250Hz at -6dB point.
- 0.5ppm (-30°C ~ +60°C).

*AQS refers to "Amateur Quinmatic System" which includes the five functions listed below. Digital communication is possible with the IC-275A/E by using the CT-15 AQS ADAPTER.

- (1) EMPTY CHANNEL ACCESSING:**
The transceiver searches an empty channel in the band, moving to the channel automatically.
- (2) CALL SIGN SQUELCH OPERATION:**
The squelch opens only when a received station's call sign is matched with the same programmed call sign.
- (3) DIGITAL CODE SQUELCH OPERATION:**
The squelch opens only when a received five digit code is matched with the same programmed code.
- (4) MESSAGE TRANSFERRING OPERATION:**
14 characters in a message can be transferred for visual communications. The messages are displayed by an optional message processor.
- (5) DIGITAL CODE STORAGE FUNCTION:**
Up to eight kinds of digital codes for access can be stored.

SECTION 3 CONTROL FUNCTIONS

3-1 FRONT PANEL

① POWER SWITCH [POWER] (P. 18)

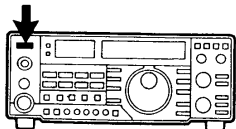

This is a push-lock switch which controls the input power to the IC-275A/E.

② AF GAIN CONTROL [AF] (P. 19)

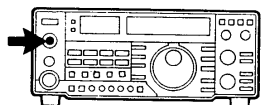

This control varies the audio output level. Clockwise rotation increases the level.

③ SQUELCH CONTROL [SQL] (P. 19)

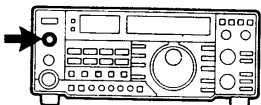

This control sets the squelch threshold level. To turn OFF the squelch function, rotate this control completely counterclockwise. To set the threshold level higher, rotate the control clockwise.

④ PHONES JACK [PHONES]

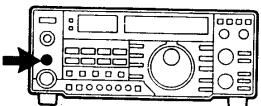

This jack accepts a standard 1/4 inch plug from headphones with an impedance of 4 ~ 16Ω. Stereo headphones may be used without modification.

⑤ MIC CONNECTOR [MIC] (P. 15)

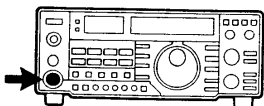

Connect a suitable microphone to this connector. The supplied HM-12 hand microphone or the optional microphones listed in SECTION 12 OPTIONS are ideal.

⑥ MODE SELECT SWITCHES [FM] [USB] [LSB] [CW/N] (P. 18)

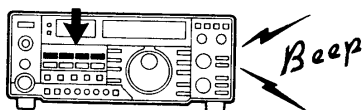

These switches select any of the four operating modes for the IC-275A/E: FM, USB, LSB, or CW. Press the appropriate switch for the desired mode.

⑦ SPEECH COMPRESSOR SWITCH [COMP] (P. 26)

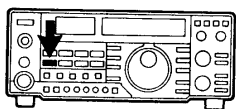

This switch turns the built-in speech compressor circuit ON and OFF.

⑧ PREAMP SWITCH [PREAMP] (P. 26)

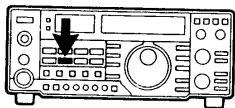

This switch turns the receiver preamplifier ON and OFF when the optional AG-25 preamplifier is installed.

The [PREAMP] SWITCH does not function when the [DATA] SWITCH described in item ⑦ is turned ON.

⑨ AUTOMATIC GAIN CONTROL SWITCH [AGC] (P. 27)

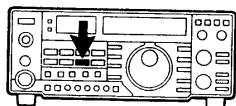

This switch changes the time constant of the AGC circuit. When the switch is OUT, a SLOW time constant is selected. When the switch is IN, a FAST time constant is selected.

⑩ NOISE BLANKER SWITCH [NB] (P. 27)

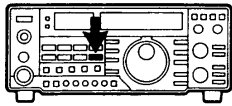

Push this switch IN to reduce pulse-type noise such as that generated by automobile ignition systems.

⑪ TONE SQUELCH SWITCH [T-SQL]

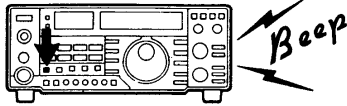

Push this switch to turn ON and OFF the Tone Squelch function alternately when the optional UT-34 TONE SQUELCH UNIT is installed.

⑫ TONE SET SWITCH [SET] (P. 27)

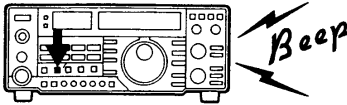

This switch is used with the [TONE] SWITCH described below in item ⑬ for setting the subaudible tone frequency of the tone encoder function.

⑬ SUBAUDIBLE TONE FREQUENCY/
TONE CALL SWITCH [TONE] (P. 27)

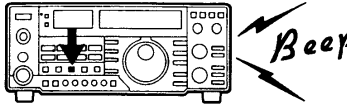

IC-275A (U.S.A. version):

Push to activate the built-in subaudible tone circuit.

IC-275E (Europe version):

Push to activate and transmit the 1750Hz tone call.

⑭ DUPLEX SWITCH [DUP] (P. 28)

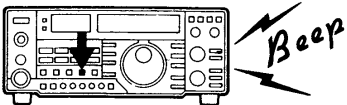

Push this switch to select simplex or duplex mode operation.

⑮ DUPLEX CHECK SWITCH [CHK] (P. 28)

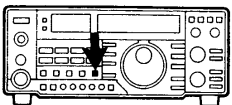

This switch allows the operator to monitor the transmit-frequency when duplex mode is selected.

⑯ TRANSMIT/RECEIVE SWITCH [XMIT]

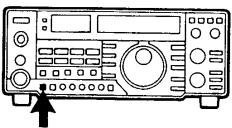

This switch is used to manually switch the transceiver from transmit to receive mode and vice versa.

IN position : Transmit

OUT position : Receive

⑰ METER SWITCH [S·RF] [C·ALC] (P. 19)

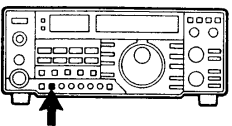

This switch selects the meter function and indicates the following:

SWITCH POSITION	RECEIVING	TRANSMITTING
S·RF (OUT)	Signal strength	*Relative RF output power
C·ALC (IN)	FM : Frequency center SSB, CW: Signal strength	ALC level

* The [TX-METER] SWITCH on the rear panel should be in the [RF] position for indicating relative RF output power.

⑱ RF POWER CONTROL [RF PWR] (P. 20)

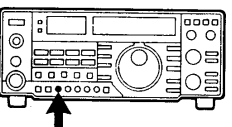

This control varies the RF output power from 2.5W to maximum continuously. Rotate clockwise to increase output power.

⑲ RF GAIN CONTROL [RF GAIN] (P. 19)

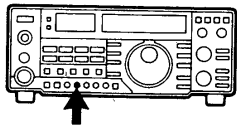

SSB, CW mode:

This control varies the gain of the RF stage when the transceiver is in receive mode. Rotate clockwise for maximum gain.

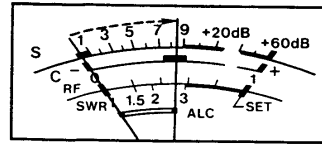

In the SSB and CW modes, the transceiver may receive signals that are stronger than the levels shown on the meter.

FM mode:

This control makes the variable attenuator function continuously from 0 to 20dB when the transceiver is in receive mode.

This control changes the transmit to receive switching time during CW operation. Adjustment depends on the keying speed used. Clockwise rotation increases the delay time.

⑳ CW DELAY CONTROL [DELAY]

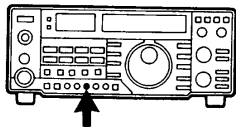

㉑ AF TONE CONTROL [AF TONE]

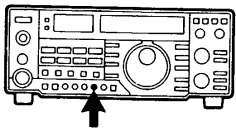

This control varies the receive audio tone. Adjust the control to receive the clearest, most pleasing audio tone.

㉒ MIC GAIN CONTROL [MIC GAIN]

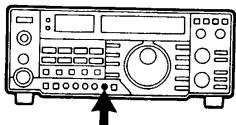

Adjust this control for a suitable modulation level while speaking into the microphone using your normal voice level. Rotate the control clockwise to increase the gain.

㉓ SPEECH SWITCH [SPEECH] (P. 42)

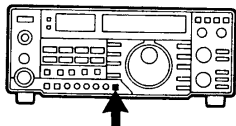

This switch activates the optional UT-36 Speech Synthesizer which announces the displayed frequency and mode, etc. in English.

㉔ SCAN START/STOP SWITCH [SCAN] (P. 35)

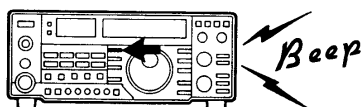

This switch starts and stops all the IC-275A/E scan functions.

㉕ SELECTED MODE MEMORY SCAN SWITCH [MODE-S] (P. 36)

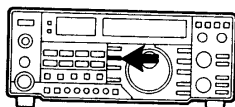

This switch turns ON and OFF the SELECTED MODE MEMORY SCAN function.

㉖ SKIP SCAN SWITCH [SKIP] (P. 37)

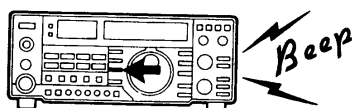

This switch is used for setting the skip channel to be skipped in MEMORY SCAN.

②⑦ DATA SWITCH [DATA] (P. 30)

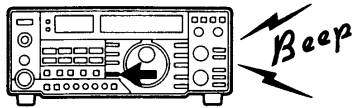

Push this switch to use operating modes such as PACKET or AMTOR communications which require rapid receive and transmit switching times.

②⑧ TUNING CONTROL

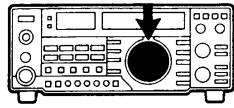

Rotate this control clockwise to increase frequency numbers and counterclockwise to decrease them.

- Quick, continuous rotation of the TUNING CONTROL changes the frequency up or down by 10kHz. Slow rotation changes it by 2.5kHz.

②⑨ TUNING STEP SELECTOR SWITCH [TS]

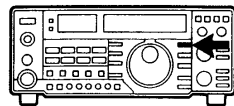

Push this switch to increase the tuning step by 1kHz while operating in any mode. Push and release the switch again to return to the previous tuning step.

POSITION	FM	USB/LSB/CW
OUT	5kHz	10Hz
IN	1kHz	1kHz

③⑩ MHz TUNING STEP SWITCH [MHz]

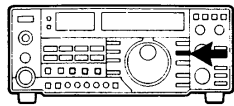

This switch sets the tuning step rate for 1MHz steps in any mode.

③① VFO SWITCH [VFO] (P. 33)

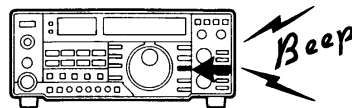

This switch selects VFO A or VFO B for tuning purposes. Each push of this switch selects one of the two VFOs alternately.

This switch also selects VFO A or VFO B mode from the MEMORY CHANNEL or CALL CHANNEL mode.

③② SPLIT SWITCH [SPLIT] (P. 28)

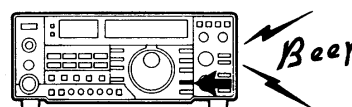

This switch selects the relationship of the two VFO frequencies. In the IN position, one VFO is for receive while the other VFO is for transmit. Each alternate push of this switch chooses the simplex and duplex modes.

③③ DIAL LOCK SWITCH [LOCK]

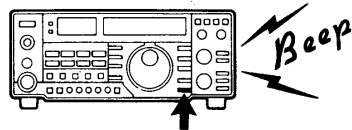

This switch electronically locks the display frequency and deactivates the TUNING CONTROL. Push the switch IN and a beep sound is emitted, indicating that the function has been activated.

③④ CALL CHANNEL SWITCH [CALL] (P. 34)

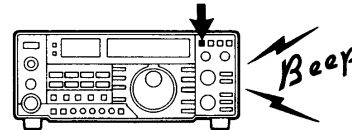

This switch selects the CALL CHANNEL which is most frequently used as a call frequency.

③⑤ FREQUENCY TRANSFER SWITCH [M ▶ VFO]

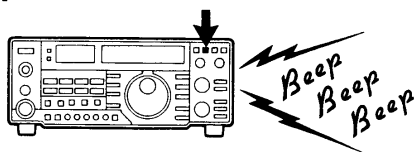

This switch operates differently depending on which mode the transceiver is in.

- In the VFO mode:
The frequency and modes stored in the memory channel displayed are transferred to the selected VFO.
- In the MEMORY CHANNEL mode:
The displayed frequency and mode are transferred to the VFO used immediately prior to changing to the MEMORY CHANNEL mode.

③⑥ VFO EQUALIZING SWITCH [A=B]

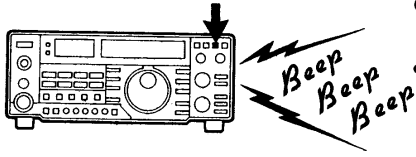

This switch instantly matches the frequency and mode of operation of the two VFOs.

• The display does not change when the [A=B] SWITCH is pushed. However, confirmation of the equalizing process is possible by pushing the [VFO] SWITCH which checks the frequency and mode of the opposite VFO.

③⑦ NOTCH FILTER SWITCH [NOTCH] (P. 30)

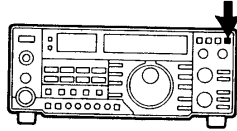

This switch turns the NOTCH FILTER circuit ON and OFF.

③⑧ NOTCH FILTER CONTROL [NOTCH] (P. 30)

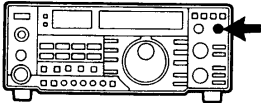

This control shifts the NOTCH FILTER frequency. Adjust the control to reduce or eliminate interfering signals.

③⑨ PASSBAND TUNING [PBT] (P. 30)

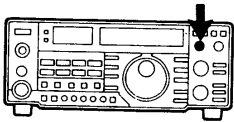

This control allows continuous tuning of passband selectivity by moving the filter center frequency to either side of the receive frequency in the SSB or CW mode.

④⑩ RIT SWITCH [RIT] (P. 31)

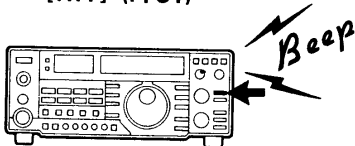

This switch turns the RIT circuit ON and OFF. The "RIT" INDICATOR appears on the FREQUENCY DISPLAY when the RIT function is active.

④⑪ RIT CLEAR SWITCH [RIT-CL] (P. 31)

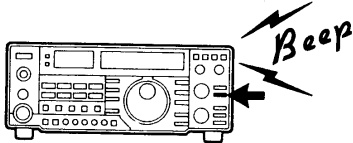

This switch clears the memory which contains the frequency shift information and resets the small incremental tuning display to "0.0".

④⑫ INCREMENTAL TUNING CONTROL [- RIT +] (P.31)

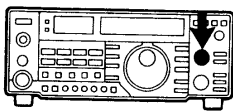

This control shifts the receive frequency by up to 9.9kHz to either side of the frequency indicated on the FREQUENCY DISPLAY.

④⑬ MEMORY READ SWITCH [MEMORY] (P. 33)

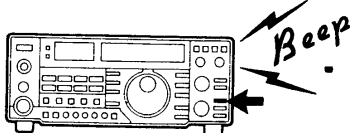

This switch selects the MEMORY CHANNEL mode. The "MEMO" INDICATOR appears on the FREQUENCY DISPLAY, and the "VFO A" or "VFO B" INDICATORS disappear.

④⑭ MEMORY WRITE SWITCH [MW] (P. 33)

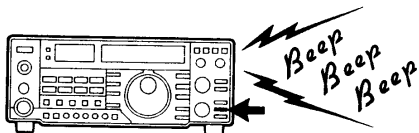

Push this switch to store displayed information in a memory channel.

④⑤ MEMORY CLEAR SWITCH [M-CL] (P. 34)

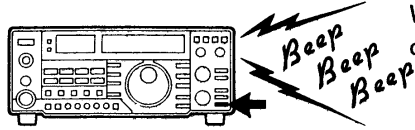

This switch clears unwanted information in any memory channel. When pushed, information in the displayed memory channel is cleared and the memory channel reverts to blank status.

④⑥ MEMORY CHANNEL SELECTOR CONTROL [MEMO] (P. 33)

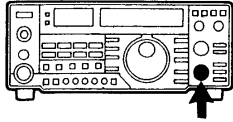

This control is used for selecting memory channels.

④⑦ FREQUENCY DISPLAY

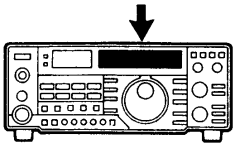

Refer to SECTION 3 - 2 FREQUENCY DISPLAY for more information.

④⑧ METER

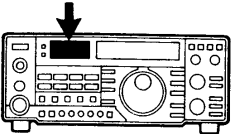

The meter functions as an S-meter or Center meter during receiving, and as an RF-meter or ALC-meter during transmitting. Refer to item ①⑦ METER SWITCH.

④⑨ TRANSMIT INDICATOR [XMIT]

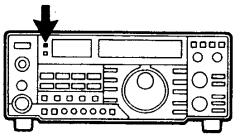

The indicator lights up when the transceiver is in the transmit mode.

④⑩ RECEIVE INDICATOR [RCV]

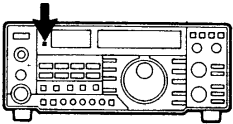

The indicator lights up when the transceiver is in the receive mode.

3 - 2 FREQUENCY DISPLAY

⑤① FREQUENCY READOUT

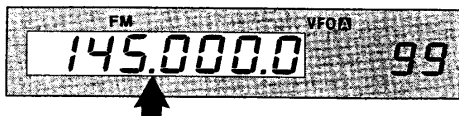

This readout shows the operating frequency using a 7-digit display with 100Hz resolution.

⑤② TONE SQUELCH INDICT "TONE-S" (P. 27)



"TONE-S" appears when the transceiver is activated using the Tone Squelch function with an optional UT-34 TONE SQUELCH UNIT.

"TONE" appears when the transceiver is activated using the subaudible tone function (IC-275A U.S.A. version) or tone call function (IC-275E).

⑤③ DUPLEX INDICATOR (P. 28)



Either "DUP+" or "DUP-" appears when duplex mode is selected using the [DUP] SWITCH.

⑤④ SPLIT INDICATOR (P. 29)



"SPLIT" appears when separate VFOs are used for the transmit and receive frequencies.

⑤⑤ SCAN INDICATOR (P. 35)



"SCAN" appears whenever a scan function is selected.

⑤⑥ RIT/SHIFT FREQUENCY INDICATOR (P. 31)



"RIT" and shift frequency appear when the RIT circuit is activated.

⑤⑦ SKIP CHANNEL INDICATOR (P. 37)



"SKIP" appears when the displayed memory channel is programmed for skip scan.

⑤⑧ MEMORY INDICATOR (P. 33)



"MEMO" and selected memory channel numbers (1 ~ 99, P1, P2 and "C") appear when the MEMORY CHANNEL mode or CALL CHANNEL mode is selected.

⑤⑨ VFO INDICATOR



"VFO A" or "VFO B" appear, indicating which VFO is currently selected when operating in VFO mode.

⑥① DATA INDICATOR

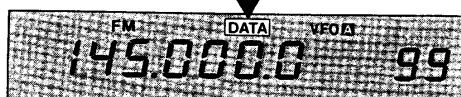

"DATA" appears when the [DATA] SWITCH is pushed.

⑥① MODE INDICATOR



This area of the display shows the operating mode currently selected. The modes available are LSB, USB, FM, CW or CW-Narrow.

3-3 REAR PANEL

⑥② AC POWER SOCKET

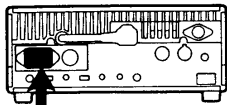

The AC POWER SOCKET connects the IC-275A/E to AC outlets via the supplied AC cable.

⑥③ DC OUTPUT POWER CABLE (P. 14)

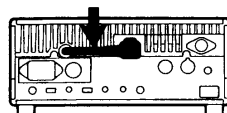

This cable outputs 13.8V DC and is connected to the DC POWER SOCKET as described in item ⑥② when operating with AC power.

⑥④ FUSE HOLDER [FUSE] (P. 38)

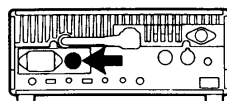

This holder contains the fuses for AC power supply. Use the spare fuses provided to replace an old or damaged fuse.

⑥⑤ DC POWER SOCKET [DC 13.8V]

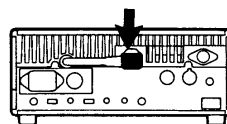

Connect the DC power cable from an external AC power supply. Refer to SECTION 12 for information regarding optional AC power supplies available from ICOM.

⑥⑥ ANTENNA CONNECTOR [ANT] (P. 13)

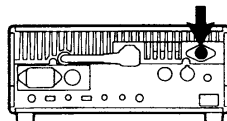

Connect a 50Ω impedance antenna to this connector. The connector should be matched with a PL-259 plug.

⑥⑦ REMOTE CONTROL JACK [REMOTE] (P. 17)

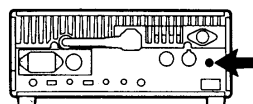

This is a communications port designed for use with a personal computer for remote operation of transceiver functions.

⑥⑧ GROUND TERMINAL [GND] (P. 13)

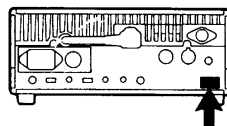

To prevent electrical shocks, TVI, BCI, and other problems, be sure to ground the transceiver through the GROUND TERMINAL.

⑥⑨ AQS SOCKET [AQS] (P. 16)

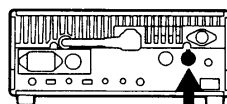

This socket provides signals for AQS (Amateur Quinmatic System).

⑦⑩ ACC(1) SOCKET [ACC(1)] (P. 16)

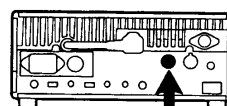

This connector provides signals such as T/R switching, receiver output, ALC input, etc.

⑦① EXTERNAL SPEAKER JACK [EXT SP]

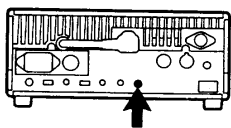

Connect an external speaker to this jack, if required. Use a speaker with an impedance of 4 ~ 16Ω. When using the EXTERNAL SPEAKER JACK, the built-in speaker does not function.

⑦② SPEECH COMPRESSOR LEVEL CONTROL [COMP LEVEL] (P. 26)

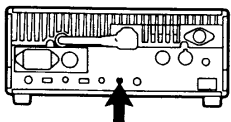

This control varies the compression level when the [COMP] SWITCH is pushed IN. The present circuit gain is approximately 10dB.

⑦③ MIC TONE CONTROL [MIC TONE]

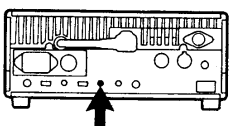

The bass and treble response of your transmitted signal may be altered with this control adjustment.

⑦④ TX-METER SWITCH [TX-METER] (P. 32)

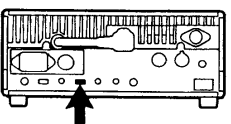

In the transmit mode, this switch selects one of three meter functions.

- **RF** : The meter indicates the relative RF output power activated by the METER SWITCH on the front panel when it is set in the [S·RF] (OUT) position.
- **SET** : Place the switch in the [SET] position to calibrate the front panel meter for measuring the SWR of the antenna system. Refer to SECTION 7 - 12 for measuring procedures.
- **SWR** : The front panel meter directly reads the antenna system SWR after calibration using the [SET] position. Refer to SECTION 7 - 12 for measuring procedures.

⑦⑤ CW SIDETONE LEVEL CONTROL [CW SIDETONE] (P. 22)

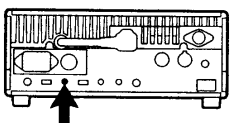

This control changes the audio level of the CW sidetone circuit. Adjust the control for the desired monitor volume.

⑦⑥ CW BREAK-IN SWITCH [BK-IN] (P. 24)

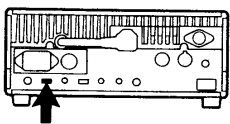

Place this switch in the [FULL] position for full break-in CW operation and in the [SEMI] position for semi break-in operation. Place this switch in the [OFF] position for non CW break-in operation.

⑦⑦ KEY JACK [KEY] (P. 23)

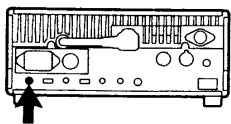

For CW operation, connect a CW key here using the supplied key plug.

SECTION 4 INSTALLATION

4 - 1 PLANNING

Select a location for your transceiver which allows free access to the front panel controls, good air circulation and rear clearance for access to the rear panel connections.

4 - 2 MOUNTING THE TRANSCEIVER

Mobile or marine installations:

An optional IC-MB5 MOBILE MOUNTING BRACKET is available for mobile installation of your IC-275A/E. Select a location which can support the weight of the unit, and which does not interfere with the normal operation of the vehicle or boat.

When mounting the transceiver aboard a boat, place the bracket in a location where the transceiver will be less subject to vibrations and wave shocks.

4 - 3 ANTENNA

Antennas play a very important role in radio communications. If the antenna is inferior, your transceiver cannot deliver optimum performance. A well-matched 50Ω antenna and feedline will provide the desired effect. The transmission line should be a coaxial cable. The antenna system should show a VSWR of less than 1.5:1 when using a 50Ω coaxial transmission line.

CAUTION: Protect your transceiver from LIGHTING by using a lightning arrestor.

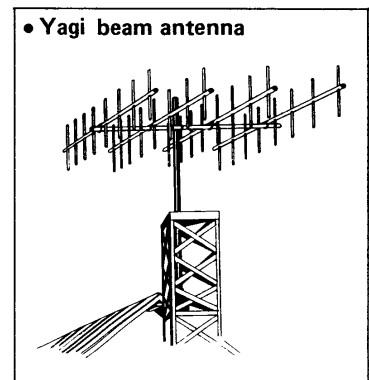
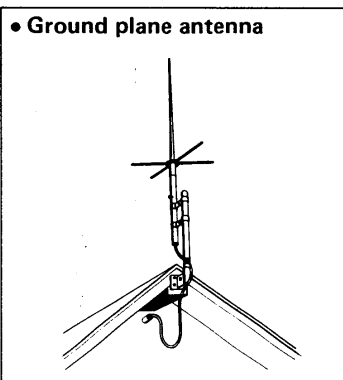

• PL-259 CONNECTOR INSTALLATION

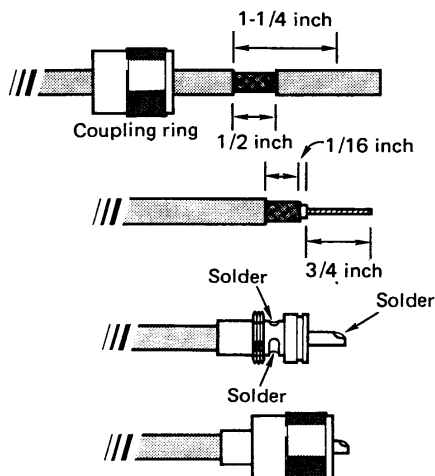

1 inch = 25.4mm

1) Slide the coupling ring over the coaxial cable.

2) Strip the cable as in the figure, and tin about 1/2" (13mm) of the shield conductor. Remove the outer plastic casing and strip the center conductor insulation as in the figure. Tin the center conductor.

3) Slide the connector body onto the cable and solder.

4) Screw the coupling ring onto the connector body.

4 - 4 GROUNDING

Refer to SECTION 1 PRECAUTIONS AND PREPARATIONS for detailed grounding information.

SECTION 5 INTERCONNECTIONS

5 - 1 POWER SUPPLY

Downloaded by

 Amateur Radio Directory

WARNING: When operating the IC-275E with AC power, be sure to connect the AC power plug into the AC power with the LIVE and NEUTRAL side of the plug in their proper position.

The IC-275A/E has a built-in switching regulator installed. To power the IC-275A/E from another external power supply or any other DC power source, be sure the output voltage is 12 ~ 15V and current capacity is at least 10A.

• For DC operation with a DC power source

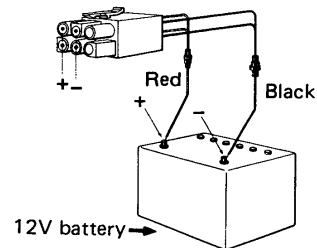
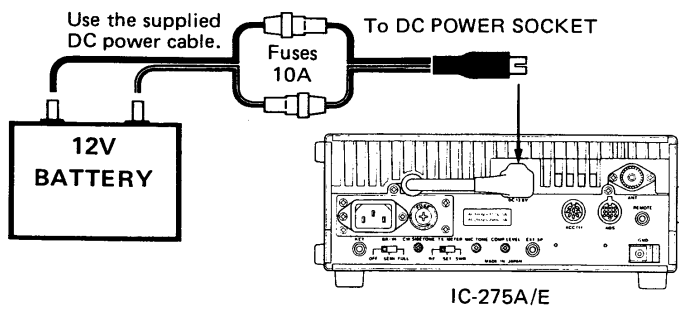

For safety purposes, remember to install FUSES in the DC cable if connecting the IC-275A/E to a vehicle battery. Locate the fuses as close to the car battery as possible.

• AC operation with the PS-55

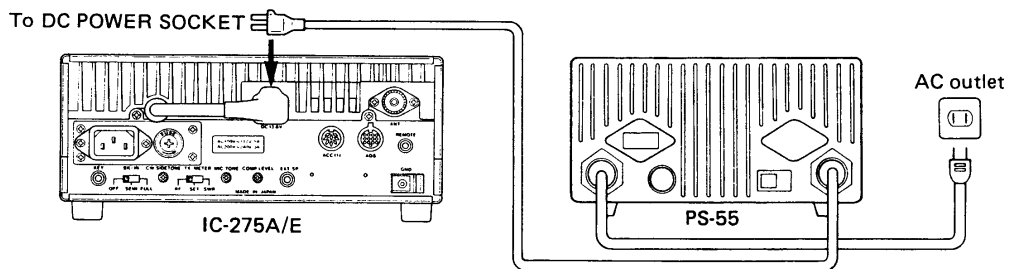

This POWER SWITCH synchronizes the PS-55 AC POWER SUPPLY with the IC-275A/E.

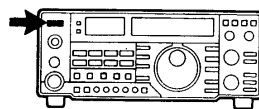

• AC operation with non-ICOM AC power supplies

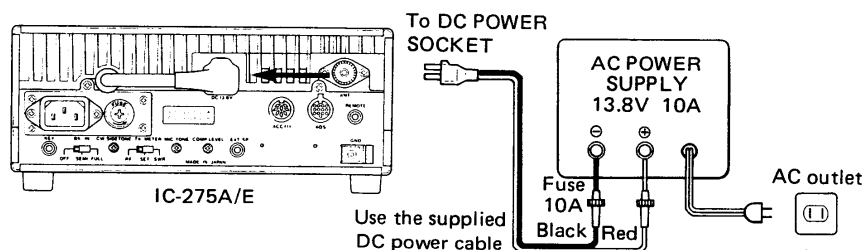

5 - 2 CONNECTING A LINEAR AMPLIFIER

The IC-275A/E is designed to operate into a load with a 50Ω impedance. Any amplifier used should have a 50Ω input impedance for best efficiency.

- 1) Pin 3 (SEND) is grounded when the transceiver is in transmit mode and opens when the transceiver returns to receive mode. The output condition of pin 3 controls either the transmit or receive function of the transceiver.

Specification for the keying rate is 50V DC maximum. DO NOT exceed this limit.

- 2) Pin 8 of the ACC(1) SOCKET is an ALC input for the Automatic Level Control signal from an external amplifier.

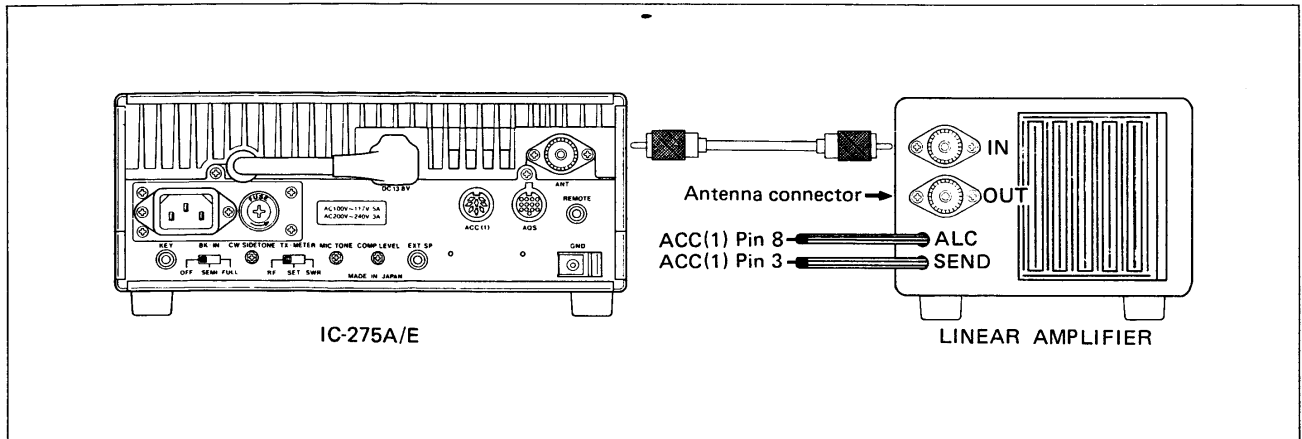

5 - 3 CONNECTING AN AFSK TERMINAL UNIT

When operating an AFSK such as RTTY, AMTOR or PACKET, connect the ACC(1) as in following diagram below:

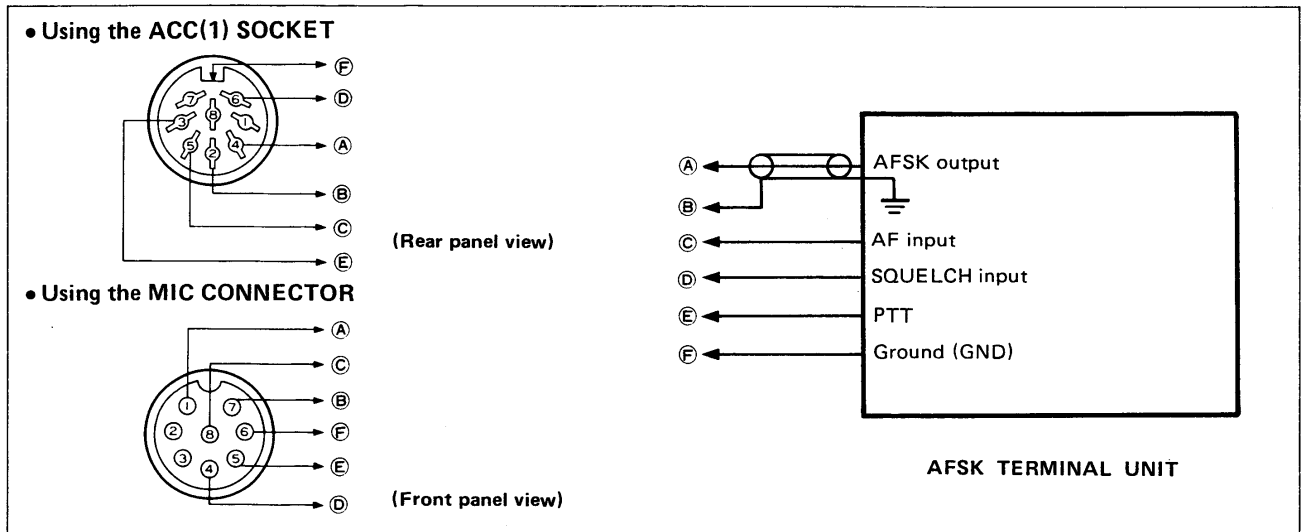

5 - 4 MIC CONNECTOR INFORMATION

Downloaded by
Amateur Radio Directory

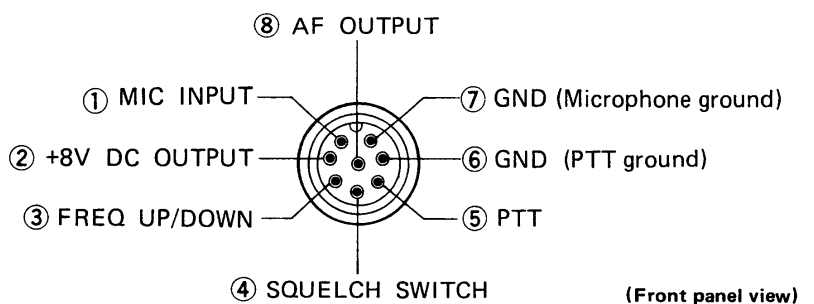

5 - 5 ACC(1) SOCKET INFORMATION

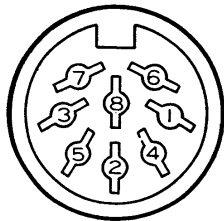

(Rear panel view)

Various signals are available from the ACC(1) SOCKET such as receiver output, modulator input, T/R changeover, etc.

PIN NO.	PIN NAME	DESCRIPTION
1	NC	No connection
2	GND	Ground
3	SEND	IC-275A/E switches to the transmit mode when this terminal is grounded via the TX SWITCH on the REAR PANEL. It can also be grounded by connecting the transceiver to an external computer.
4	MOD	Connected in the modulator stage. The modulator amplification level can be changed by using the S1 SWITCH. See SECTION 10 - 1 for the location of this switch.
5	AF	Output from the receive detector stage. The output level can be changed by using the S2 SWITCH on the MAIN UNIT. See SECTION 10 - 1 for the location of this switch.
6	SQLS	This terminal goes to ground level when the SQUELCH opens.
7	13.8V	13.8V DC output is switched by the [POWER] SWITCH on the front panel. Maximum current capacity is 1A.
8	ALC	Input for external ALC voltage.

5 - 6 AQS SOCKET INFORMATION

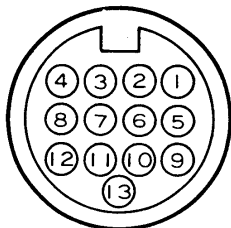

(Rear panel view)

The function of the AQS System is described in SECTION 2 FEATURES.

PIN NO.	PIN NAME	DESCRIPTION
1	TX E	Modulator ground.
2	TX MOD	Modulator input.
3	MUTE	MUTE line for audio output and microphone input. The terminal is "LOW" while muting.
4	CAC	Valid signal output for CAC (Channel Access) function. The terminal is "HIGH" when the CAC function is activated.
5	RX RF	Output from the receive detector stage.
6	PTT	Connected to the PTT circuit. The terminal is "LOW" when transmitting.
7	SEND	This is an input terminal that the transceiver switches to in transmit mode when the terminal is "LOW".
8	SEARCH	When searching the empty channel, the terminal is "LOW".
9	E	Demodulator ground.
10	CI-V	This is the CPU I/O terminal for setting the frequency and mode.
11	NC	No connection
12	RECV	When receiving a signal, this terminal is "LOW".
13	13.8	This terminal outputs 13.8V DC to an optional AQS adapter.

Downloaded by



Amateur Radio Directory

5 - 7 REMOTE CONTROL JACK (CI-V) INFORMATION

ICOM has introduced a new remote control Local Area Network, the ICOM CI-V COMMUNICATION INTERFACE SYSTEM using the CSMA (Carrier Sense Multiple Access with Collision Detection) standard.

- A serial data bus carries all control data. Operation is possible by installing a voltage level converter with a personal computer that has an RS-232C serial port.

• Interface between the IC-275A/E and RS-232C

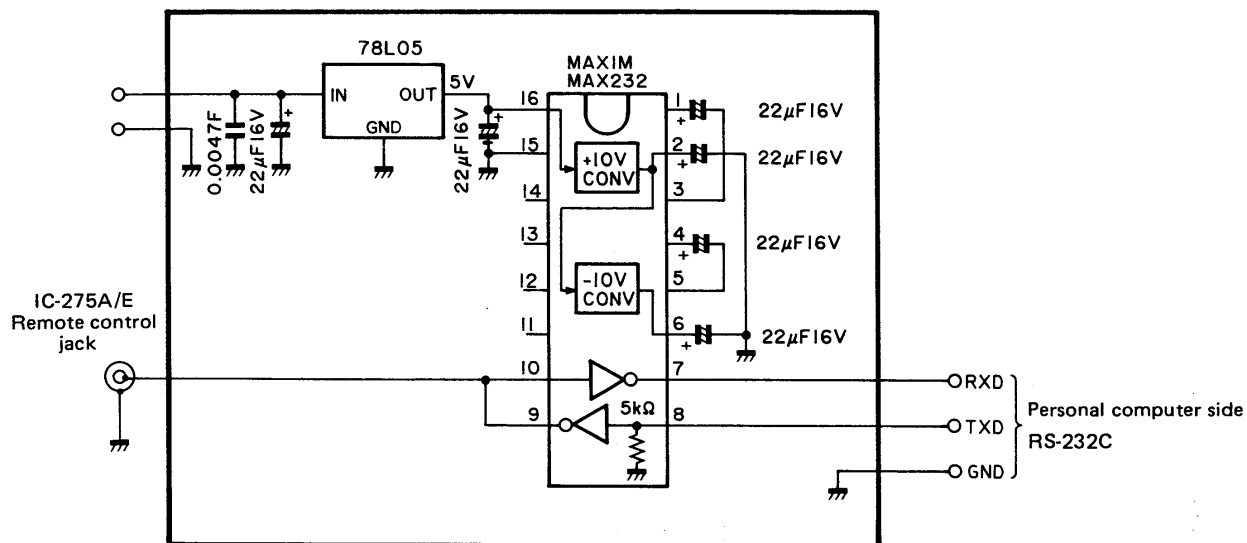

S3 SWITCHES (Switches 1 ~ 10)

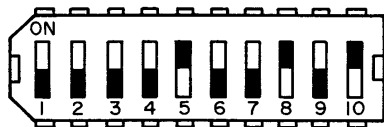

The S3 SWITCHES shown above are located on the LOGIC UNIT.

Transmitters and receivers using the ICOM CI-V System exchange serial information in the PACKET format. The contents of a data PACKET can be changed by using the S3 switches (Switches 1 to 10) on the LOGIC UNIT.

Switches 1 ~ 7 (For setting an address with your transceiver):

The ON position of one of the seven switches sets an independent address for your IC-275A/E.

Switch 8 (For setting a transceive flag):

The ON position sets a flag used for sending or receiving code data of transceive operations automatically when the frequency is changed or code data are received.

Switches 9 and 10 (For setting CI-V baud rate):

Baud rate	Switch 9	Switch 10
9600	OFF	OFF
4800	ON	OFF
1200	OFF	ON
300	ON	ON

NOTE:

The standard ICOM CI-V baud rate is 1200 baud.

Downloaded by



Amateur Radio Directory

SECTION 6 GENERAL OPERATION

6 - 1 INITIAL SETTINGS

After all INSTALLATION instructions have been followed in SECTION 4, including connecting an antenna system, set the controls and switches as indicated below:

- 1) Check the DC output voltage if using a non-ICOM AC power supply.
- 2) An antenna must be connected to the ANTENNA CONNECTOR.

CAUTION: Transmitting without an antenna may damage the transceiver.

- 3) A ground connection must be made through the GROUND TERMINAL.

(1) Front panel switch and control settings

	SWITCH/CONTROL	POSITION		SWITCH/CONTROL	POSITION
①	POWER	OFF (Out)	⑱	RF GAIN	Max. CW
②	AF	Max. CCW	⑳	DELAY	Center
③	SQUELCH	Max. CCW	㉑	AF TONE	Center
⑦	COMP	OFF (Out)	㉒	MIC GAIN	Center
⑧	PREAMP	OFF (Out)	㉓	TS	OFF (Out)
⑨	AGC	Slow (Out)	⑳	MHz	OFF (Out)
⑩	NB	OFF (Out)	㉔	LOCK	OFF (Out)
⑯	XMIT	Receive (Out)	㉕	NOTCH SWITCH	OFF (Out)
⑰	S·RF/C·ALC	S·RF (Out)	㉖	NOTCH CONTROL	Center
⑱	RF PWR	Max. CCW	㉗	PBT	Center

(2) Rear panel switch settings

	SWITCH/CONTROL	POSITION		SWITCH/CONTROL	POSITION
⑥⑥	GND	Connect ground	⑦④	BK-IN	OFF
⑦②	TX-METER	RF			

6 - 2 FM OPERATION

(1) FM receiving

- 1) Set the switches and controls as shown in SECTION 6 - 1.

- 1) Set the switches and controls as explained in SECTION 6 - 1.

- The [PBT] CONTROL, [NOTCH] SWITCH and CONTROL, [NB] SWITCH, and [AGC] CONTROL do not function in this mode.

- 2) Turn power ON.

- 2) Press the [POWER] SWITCH IN to turn ON power.

- The FREQUENCY DISPLAY and METER light up.

- 3) Push the [FM] SWITCH.

- 3) Push the [FM] MODE SWITCH to select this mode.

- The "FM" INDICATOR appears.

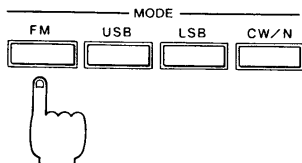

4) Adjust the [AF] CONTROL.

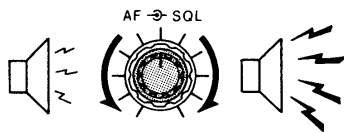

5) Adjust the [SQL] CONTROL.



6) Turn the TUNING CONTROL.

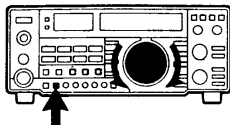

• S-meter

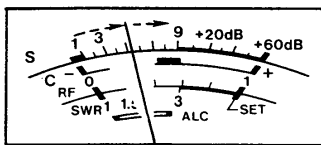

• Center meter

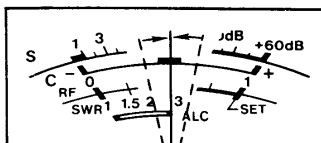

7) Adjust [RF GAIN] CONTROL.

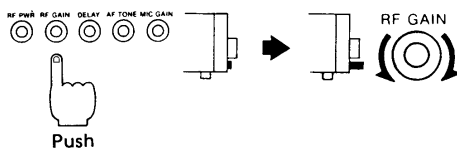

• Tone Squelch operation

(2) FM transmitting

1) Switch to transmit mode.

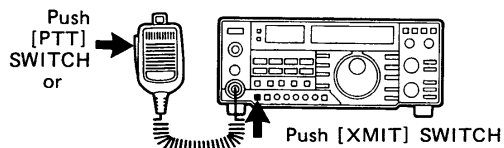

4) Turn the [AF] GAIN CONTROL to a suitable listening level.

5) Turn the [SQL] CONTROL clockwise until the noise is quieted.

SQUELCH: If closed, the squelch mutes all noise from the speaker when no signal is received. This is useful while waiting for another station to call.

6) Turn the TUNING CONTROL and receive an FM signal.

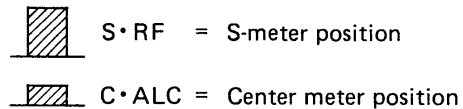

• When tuning an FM signal, tune for maximum signal strength as indicated on the meter in order to receive the clearest audio signal.

• The Center meter is useful for checking if the receive frequency is being received at maximum efficiency. Press the METER SWITCH OUT to the [S • RF] position to activate the Center meter.

7) The [RF GAIN] CONTROL functions as a variable attenuator in FM mode. Maximum counterclockwise rotation attenuates signals by 20dB.

This is a function created by an optional UT-34 TONE SQUELCH UNIT. It is designed for interference-free communications with other stations equipped with a similar system.

The following transmitting procedures should only be started after the steps in SECTION 6 - 2 (1) FM receiving have been completed.

1) Select transmit mode with either the [XMIT] on the front panel or [PTT] SWITCH on the microphone.

• The red TRANSMIT INDICATOR lights up whenever the IC-275A/E is placed in transmit mode.

2) Adjust the [RF PWR] SWITCH.

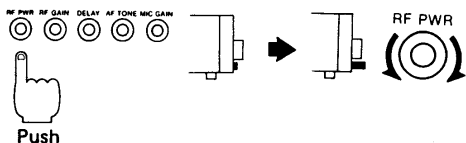

3) Speak into the mic.

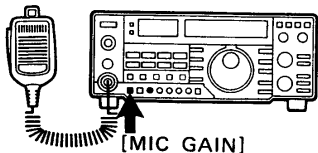

• FM REPEATER OPERATION

1) Push the [DUP] SWITCH.

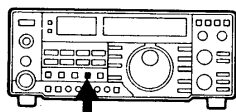

2) Switch to transmit.

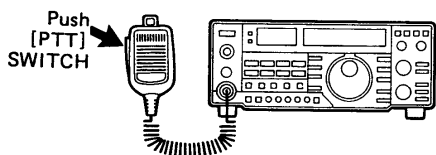

6 - 3 SSB OPERATION

(1) SSB receiving

- 1) Set the switches and controls as shown in SECTION 6 - 1.
- 2) Turn power ON.

3) Push either the [USB] or [LSB] SWITCH.

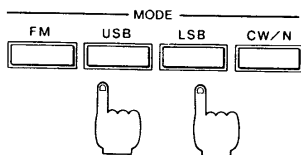

4) Push [AGC] SWITCH IN.

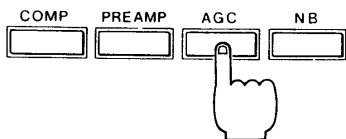

5) Adjust [AF] GAIN CONTROL.

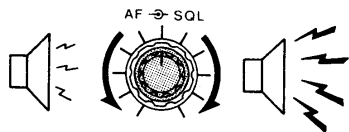

2) Adjust the [RF PWR] SWITCH to obtain a suitable output power level.

3) Speak into the microphone using your normal voice level. Mic gain can be adjusted by using the [MIC GAIN] CONTROL.

- The meter needle indicates the relative carrier power when the METER SWITCH is in the OUT [S•RF] position. However, the needle does not move in time with your voice modulation in FM mode.

Following are the basic procedures for duplex operation. Refer to SECTION 7 - 6 DUPLEX (SPLIT FREQUENCY) OPERATION for further information.

1) Push the [DUP] SWITCH alternately to select the desired duplex direction.

[DUP-] → [DUP+] → No indication (SIMPLEX)

2) Select the transmit mode.

- The displayed frequency will be 600kHz higher than the receive frequency now displayed in +duplex or 600kHz lower in -duplex.

1) Set the switches and controls as shown in SECTION 6 - 1.

2) Press the [POWER] SWITCH IN to turn ON power.

- The FREQUENCY DISPLAY and METER light up.

3) Push either the [USB] or [LSB] SWITCH to select the desired mode.

- The USB mode is commonly used in the 2-meter band.

- The "USB" or "LSB" INDICATORS appear.

4) Push the [AGC] SWITCH IN to select the AGC FAST position if the receive signals are fading rapidly.

5) Adjust the [AF] GAIN CONTROL to a suitable listening level.

6) Turn the [SQL] CONTROL.

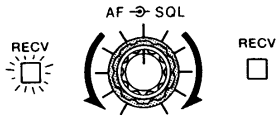

7) Turn the TUNING CONTROL.

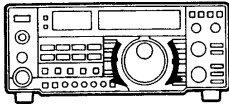

• NOISE BLANKER OPERATION

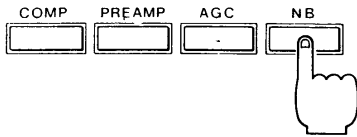

• PASSBAND TUNING OPERATION



• NOTCH FILTER OPERATION

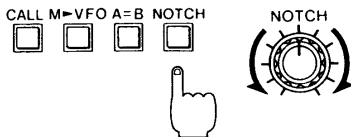

(2) SSB transmitting

1) Switch to transmit.

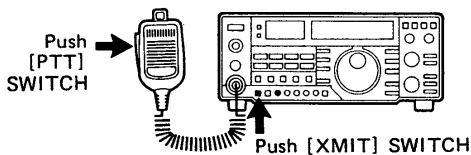

2) Set the METER SWITCH to the ALC position.

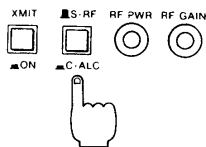

3) Adjust the [MIC GAIN] CONTROL.

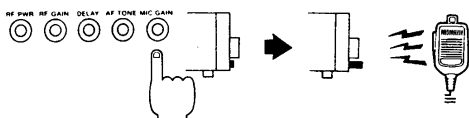

6) Turn the [SQL] CONTROL clockwise until the noise from the speaker is quieted.

SQUELCH: If closed, the squelch mutes all noise from the speaker when no signal is received. This is useful while waiting for another station to call.

7) Turn the TUNING CONTROL and search for a signal. Tune across the signal to its peak position to receive the clearest audio in the signal.

- The Passband Tuning, Notch Filter and Noise Blanker functions are very helpful in getting better readability when operating while receiving interference or pulse-type noise.

This is a useful function that reduces pulse-type noise such as that generated by automobile ignition systems. Refer to SECTION 7 - 4 for more detailed information.

This function reduces or eliminates interference. Refer to SECTION 7 - 8 for more detailed information.

This function can be used to reduce or eliminate interfering heterodyne signals that fall within the passband of the receiver. Refer to SECTION 7 - 9 for further information.

The following transmitting procedures should be followed only after completing the operation steps in 6 - 3 (1) SSB receiving.

1) Select the transmit mode with either the [XMIT] on the front panel or [PTT] SWITCH on the microphone.

- The red TRANSMIT INDICATOR lights up whenever the IC-275A/E is placed in transmit mode.

2) Set the METER SWITCH to the ALC position. Speak into the microphone using your normal voice level.

3) Adjust the [MIC GAIN] CONTROL for a meter reading within the ALC zone on voice peaks.

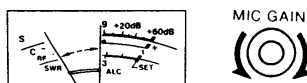

4) Adjust the [RF PWR] CONTROL.

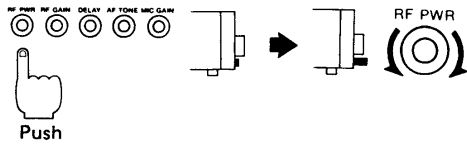

• **SPEECH COMPRESSOR OPERATION**

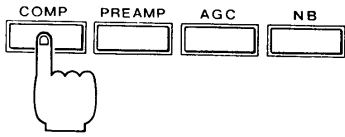

6 - 4 CW OPERATION

(1) CW receiving

- 1) Set the switches and controls as shown in SECTION 6 - 1.
- 2) Turn power ON.
- 3) Push the [CW/N] SWITCH.

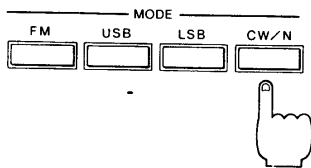

4) Push the [AGC] SWITCH IN.

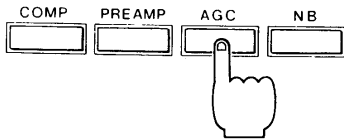

5) Adjust the [AF] GAIN CONTROL.

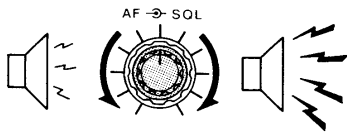

6) Turn the [SQL] CONTROL.

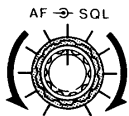

7) Turn the TUNING CONTROL.

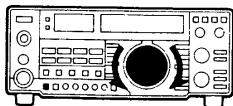

4) Adjust the [RF PWR] CONTROL to a suitable output power level.

The power level of speech can be increased over long distances by using this function. Refer to SECTION 7 - 1 for further information.

1) Set the switches and controls as shown in SECTION 6 - 1.

2) Press the [POWER] SWITCH IN to turn ON power.

- The FREQUENCY DISPLAY and METER light up.

3) Push the [CW/N] MODE SWITCH once or twice to alternately select CW or CW-Narrow mode.

- The "CW" INDICATOR appears for a normal bandwidth.
- The "CW-N" INDICATOR appears for a narrow bandwidth, and is valid when the optional FL-83 CW NARROW FILTER is installed.

NOTE: No sound is emitted unless an optional FL-83 CW NARROW FILTER is installed when CW-Narrow mode is selected.

4) Push the [AGC] SWITCH IN to select the AGC FAST position.

5) Adjust the [AF] GAIN CONTROL to a suitable listening level.

6) Turn the [SQL] CONTROL clockwise until noise is quieted and the squelch closes.

SQUELCH: If closed, the squelch mutes all noise from the speaker when no signal is received. This is useful while waiting for another station to call.

7) Turn the TUNING CONTROL and search for a signal. Tune across the signal until the needle peaks while listening for the clearest audio signal.

- When receiving CW signals with an 800Hz tone, the receive and transmit frequencies of the station making contact are the same.

• **NOISE BLANKER OPERATION**

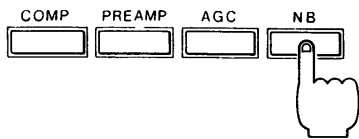

• **PASSBAND TUNING OPERATION**



• **NOTCH FILTER OPERATION**

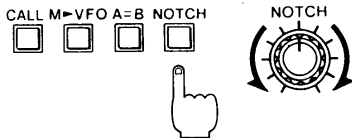

(2) **CW transmitting**

- 1) Connect CW key.

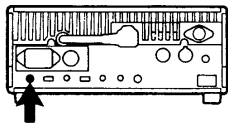

- 2) Select transmit mode.

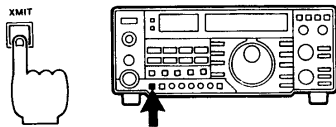

- 3) Operate CW key.

- 4) Adjust [RF PWR] CONTROL.

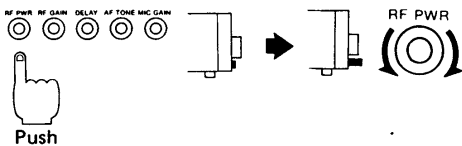

• **CW SIDETONE MONITOR**

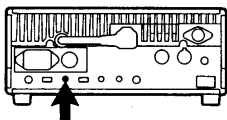

This is a useful function reduces pulse-type noise such as that generated by automobile ignition systems. Refer to SECTION 7 - 4 for detailed information.

This function is designed to reduce or eliminate interference. Refer to SECTION 7 - 8 for detailed information.

This function may be used to reduce or eliminate interfering heterodyne signals that fall within the passband of the receiver. Refer to SECTION 7 - 9 for detailed information.

The following transmitting procedures should be started after first beginning the steps in SECTION 6 - 4 (1) CW receiving.

- 1) Insert the CW key plug into the KEY JACK on the rear panel.

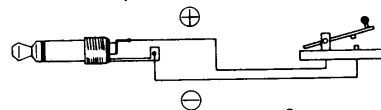

- 2) Select the transmit mode with the [XMIT] SWITCH or [BK-IN] SWITCH on the rear panel. Refer BREAK-IN OPERATION on the following page.

- The red TRANSMIT INDICATOR lights up whenever the IC-275A/E is placed in transmit mode.

- 3) Operate the CW key.

- The meter movement indicates that a signal is being transmitted.
- CW sidetone (described below) is emitted from the speaker.

- 4) Adjust the [RF PWR] CONTROL to obtain suitable output power.

An 800Hz sidetone oscillator is provided to monitor keying when operating in CW mode. This tone is also audible in receive mode and can be used for CW code practice or adjustment of the keyer.

- The [CW SIDETONE] CONTROL varies the volume of the oscillator tone. This control is located on the rear panel of the transceiver. The transceiver [AF] GAIN CONTROL also varies the volume.

• BREAK-IN OPERATION

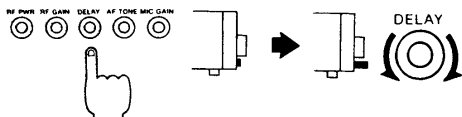
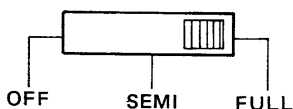
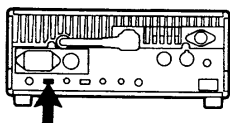

6 - 5 PACKET AND AMTOR OPERATIONS

The IC-275A/E has both semi break-in and full break-in capability. This means the transmit/receive switching is performed automatically by the transceiver whenever the keying starts or stops. The receive to transmit switching time is, practically speaking, instantaneous, whereas the transmit to receive switching time may be varied through adjustment to suit an individual's keying speed.

- 1) Slide the [BK-IN] SWITCH to set either the semi break-in or full break-in operation. This switch is located on the rear panel.

[SEMI] : Semi break-in operation
[FULL] : Full break-in operation

- 2) Place the [XMIT] SWITCH in the receive position (Out).
- 3) Begin sending with the CW key and the transceiver will switch between transmit and receive automatically.
- 4) Set the transmit release delay time to suit your keying speed by adjusting the [DELAY] CONTROL when operating with semi break-in.

PACKET and AMTOR operations require a rapid transmit and receive switching time since they are handshaking communications. The IC-275A/E requires only 3msec. for switching when the [DATA] SWITCH on the front panel is used.

- 1) Connect a terminal unit and any external equipment if required. Refer to SECTION 5 - 3 for proper interconnections.
- 2) Set the switches and controls as explained in SECTION 6 - 1.
- 3) Turn power ON.
- 4) Set mode either to [FM], [USB], or [LSB]. CW mode is not acceptable for data communications.
- 5) Push the [DATA] SWITCH ON. The "DATA" INDICATOR appears.
- 6) Enter commands or data to operate your terminal unit with the IC-275A/E.

6 - 6 RTTY OPERATION

With the IC-275A/E, RTTY contacts may be enjoyed by using AFSK (Audio Frequency Shift Keying). The demodulator used should have 2125/2295Hz or 1700/2125Hz filters for 170Hz or 425Hz shift operation.

- 1) Connect a terminal unit and any external equipment if required. Refer to SECTION 5 - 3 for information regarding interconnections.
- 2) Set the switches and controls as explained in SECTION 6 - 1.
- 3) Turn power ON.
- 4) Set the mode to [LSB].
- 5) Begin sending with your RTTY terminal unit.

• **FREQUENCY READOUT**

When operating in RTTY, there is a difference between the displayed frequency and the actual operating frequency.

Receiving:

Assuming the demodulator mark frequency is 2125Hz and the space frequency is 2295Hz:

$$\left[\begin{array}{l} \text{Transmit frequency of} \\ \text{contacted station} \end{array} \right] = \text{Displayed frequency} - 2125\text{Hz}$$

Transmitting:

Assuming the AFSK generator mark frequency is 2125Hz and the space frequency is 2295Hz:

$$\left[\begin{array}{l} \text{Transmit frequency of} \\ \text{your station} \end{array} \right] = \text{Displayed frequency} - 2125\text{Hz}$$

• **USING AN AFSK GENERATOR**

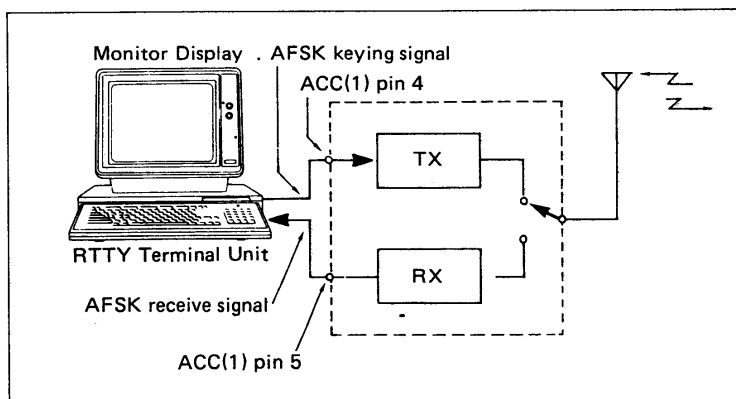

• An RTTY Terminal Unit for AFSK operation can also be connected easily.

6 - 7 SSTV OPERATION

Slow Scan Television operation is also possible with the IC-275A/E.

- Connect the CAMERA OUTPUT on your SSTV unit to the ACC(1) CONNECTOR pin 4 or MIC CONNECTOR pin 1.
- The audio output signal is available from pin 5 on the ACC(1) SOCKET. The output level can be changed by S2 on the MAIN UNIT.
- See SECTION 5 - 5 for ACC(1) SOCKET information.

SECTION 7 FUNCTIONS OPERATION

7 - 1 SPEECH COMPRESSOR OPERATION

The IC-275A/E has a low distortion, AF speech compressor circuit which provides greater talk power by improving the intelligibility of the transmitted signal over long distances.

1) Set the [COMP] SWITCH to ON position.

1) Set the switches and controls as shown in the table.

SWITCH/CONTROL	POSITION
MIC GAIN	Center (12 o'clock)
RF POWER	Max. CCW
COMP	ON (In)

2) Switch to transmit and speak into the mic.

2) Switch to transmit and speak into the microphone using normal voice level.

3) Adjust the [COMP LEVEL] CONTROL if needed.

3) The compressor gain can be adjusted by the [COMP LEVEL] SPEECH COMPRESSOR LEVEL CONTROL on the rear panel.

• To increase the gain, rotate the [COMP LEVEL] clockwise.

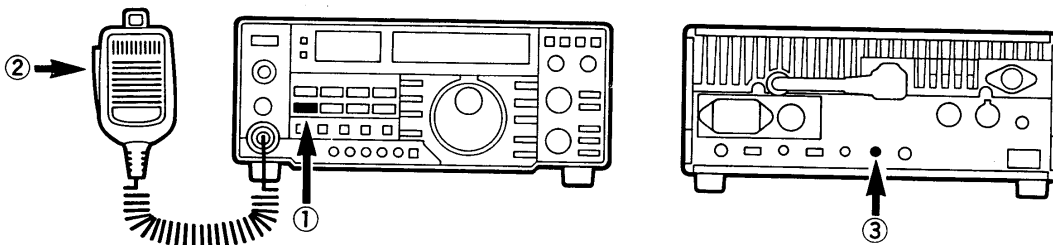

7 - 2 PREAMP SWITCH OPERATION

This switch is activated only when an optional AG-25 WEATHERPROOF 144MHz PREAMPLIFIER UNIT is installed. The [PREAMP] SWITCH turns the receiver preamplifier ON and OFF.

1) Push the [PREAMP] SWITCH.

1) Push the [PREAMP] SWITCH.

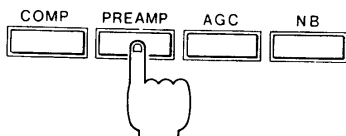

2) Switch to transmit.

2) Push either the microphone [PTT] SWITCH or [XMIT] SWITCH to automatically switch the AG-25 PREAMPLIFIER UNIT to be through.

NOTE: The optional AG-25 is designed to operate at normal transmit and receive switching speed so the [PREAMP] SWITCH, rather than the high speed [DATA] SWITCH, should be used during normal operation.

• The preamp function does not function when the [DATA] SWITCH is turned ON (IN position).

7 - 3 AGC OPERATION

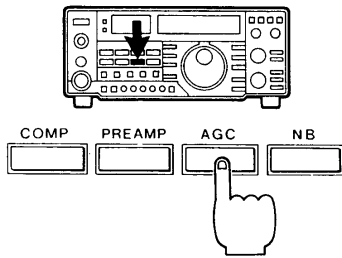

The IC-275A/E has a fast attack/slow release AGC system which maintains a peak voltage of a rectified IF signal from the IF amplifier circuit for a brief period of time.

This circuit prevents irritating background noise from being heard during the short pauses in speech. The damping effect of the AGC therefore allows accurate S-meter readings to be taken of peak IF signal strength.

1) For normal SSB reception:

Select the SLOW (OUT) position.

For CW reception or for SSB signals with short interval fading:

Select the FAST (IN) position.

2) The AGC function does not work in FM mode.

7 - 4 NOISE BLANKER (NB) OPERATION

1) Push [NB] SWITCH.

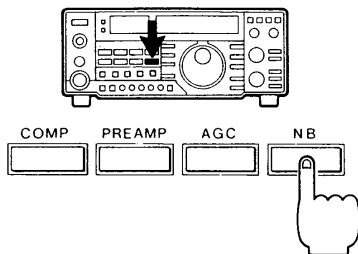

This operation effectively reduces unwanted pulse-type noise from outside sources such as ignition noise from vehicles.

1) Push the [NB] SWITCH.

2) The noise blanker may not work as well when strong signals are on nearby frequencies or when the noise is continuous rather than pulse-type.

7 - 5 SUBAUDIBLE TONE ENCODER AND 1750Hz TONE CALL OPERATIONS

(1) Subaudible tone encoder operation

The tone frequency can be programmed into each memory channel independently.

Subaudible Tone Encoder (IC-275A USA version only):

The built-in tone encoder allows access to repeaters which require a subaudible tone superimposed on the transmit signal.

1750Hz Tone Call (IC-275E Europe version only):

An audible 1750Hz tone signal may be generated for the purpose of accessing repeaters.

1) Select a memory channel you want to program the tone frequency in for the VFO modes or MEMORY CHANNEL mode.

2) Push the [TONE] SWITCH to turn ON the tone encoder function.

3) Push the [SET] SWITCH and rotate the TUNING CONTROL to select the desired tone frequency.

4) Push the [SET] SWITCH again to program the tone frequency. The [TONE] SWITCH alternately turns ON and OFF the tone encoder function.

(2) 1750Hz Tone Call operation

Push the [TONE] SWITCH, then release the [TONE] SWITCH. It is usually best to transmit the tone at the beginning of each transmission for a duration of approximately 1 ~ 3 seconds.

7 - 6 DUPLEX (SPLIT FREQUENCY) OPERATION

The purpose of the duplex function is to allow an operator the option of transmitting and receiving on two different frequencies.

The IC-275A/E provides duplex operation using either of the following two methods:

- (1) Operating on a fixed 600kHz frequency or user-programmed offset frequency.
- (2) Operating on VFO A and VFO B with the [SPLIT] SWITCH.

Following are examples for duplex operation using 145.000MHz for receiving and 144.400MHz for transmitting with a 600kHz fixed offset frequency on FM mode.

(1) Duplex operation using the fixed 600kHz offset frequency

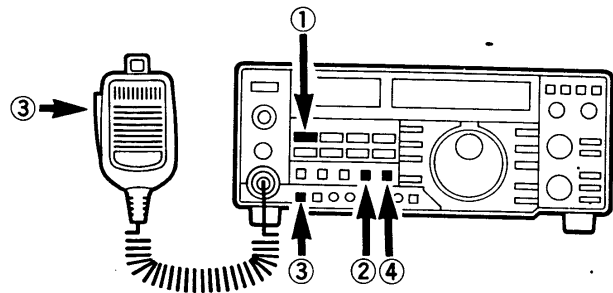

- 1) Select 145.000MHz and FM MODE.

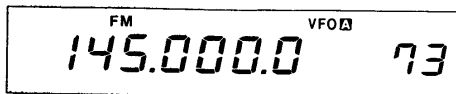

- 2) Push [DUP] SWITCH to set the -DUPLEX.



- 3) Transmit.

- Transmit frequency



- Receive frequency



- 4) Push [CHK] SWITCH.

- 5) Push [DUP] SWITCH to cancel the duplex mode.

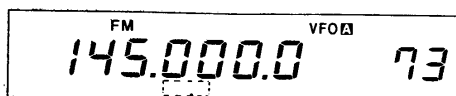

"DUP-" disappear

- 1) Select 145.000MHz with the TUNING CONTROL and push the [FM] SWITCH.

- 2) Push the [DUP] SWITCH to set the -DUPLEX mode.

- "DUP-" appears on the FREQUENCY DISPLAY.

- 3) Push either the [XMIT] or [PTT] SWITCH to transmit.

- The FREQUENCY DISPLAY should indicate 144.4000MHz for transmitting.

- You are now receiving on 145.000MHz and transmitting on 144.4000MHz.

- 4) Push the [CHK] SWITCH to check the repeater input frequency, if needed.

- 5) Push the [DUP] SWITCH until either "DUP-" or "DUP+" disappear from the FREQUENCY DISPLAY, cancelling the duplex mode.

(2) Resetting the offset frequency

- 1) Push [DUP] SWITCH.
- 2) Push [SET] SWITCH.



- 3) Set the offset frequency for 850kHz.



- 4) Return to normal operating mode.



(3) Duplex operation using contents of VFO A and VFO B (SPLIT operation)

- 1) Set VFO A mode and program 145.9500MHz.

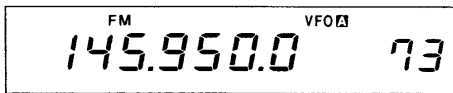

- 2) Set VFO B mode and program 144.0500MHz.

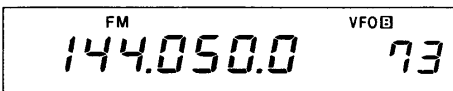
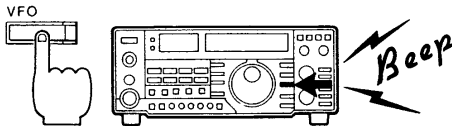

- 3) Return to VFO A mode.
- 4) Push [SPLIT] SWITCH.

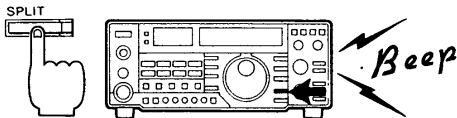

- 5) Transmit.
- 6) Receiving : 145.9500MHz
Transmitting: 144.0500MHz

The offset frequency can be reset for use in duplex operation.

Following is an example for resetting the offset frequency at 850kHz.

- 1) Push the [DUP] SWITCH to set the duplex mode.
- 2) Push the [SET] SWITCH. The subaudible tone function (U.S.A. version) or Tone Call function (Europe version) should be turned OFF when resetting the offset frequency.
- 3) Rotate the TUNING CONTROL to "0.850" for the desired offset frequency of 850kHz.
- 4) Push one of the following switches to return to the normal operating mode: [TONE], [DUP] or [CHK].

Duplex operation is possible using the contents of VFO A and VFO B.

Following is an example for 145.9500MHz for receiving and 144.0500MHz for transmitting on duplex (split frequency) operation.

- 1) Push the [VFO] SWITCH to set the transceiver in VFO A mode and set a receive frequency of 145.9500MHz with the TUNING CONTROL.
- 2) Push the [VFO] SWITCH to set the transceiver in VFO B mode and set a transmit frequency of 144.0500MHz with the TUNING CONTROL.
- 3) Push the [VFO] SWITCH again to return to VFO A mode.
- 4) Push the [SPLIT] SWITCH to enter the split frequency operation.
 - "SPLIT" appears on the FREQUENCY DISPLAY.
- 5) Push either the [XMIT] or [PTT] SWITCH to transmit.
- 6) You are now receiving on 145.9500MHz and transmitting on 144.0500MHz. Push the [VFO] SWITCH once again to receive on 144.0500MHz and transmit on 145.9500MHz.

Each VFO also stores the operating mode in addition to the operating frequency. This allows crossmode contacts to be easily made.

7-7 DATA SWITCH OPERATION

This switch allows you to freely operate digital communications such as AMTOR or PACKET with time delay.

- The lockup time is approximately 5 milliseconds when using the [DATA] SWITCH.

- The [DATA] SWITCH does not function in CW mode.

1) Connect the terminal unit to the IC-275A/E properly.

NOTE: Refer to SECTION 5-4 and your terminal unit instruction manual regarding terminal unit connections for digital communications.

2) Select a mode switch and push the [DATA] SWITCH.

- "DATA" appears on the FREQUENCY DISPLAY.

Passband Tuning is a system designed to electronically narrow the bandwidth (selectivity) of frequencies that will pass through the receive crystal filter.

NOTE: Passband tuning does not function when the transceiver is in FM mode.

7-8 PASSBAND TUNING (PBT) OPERATION

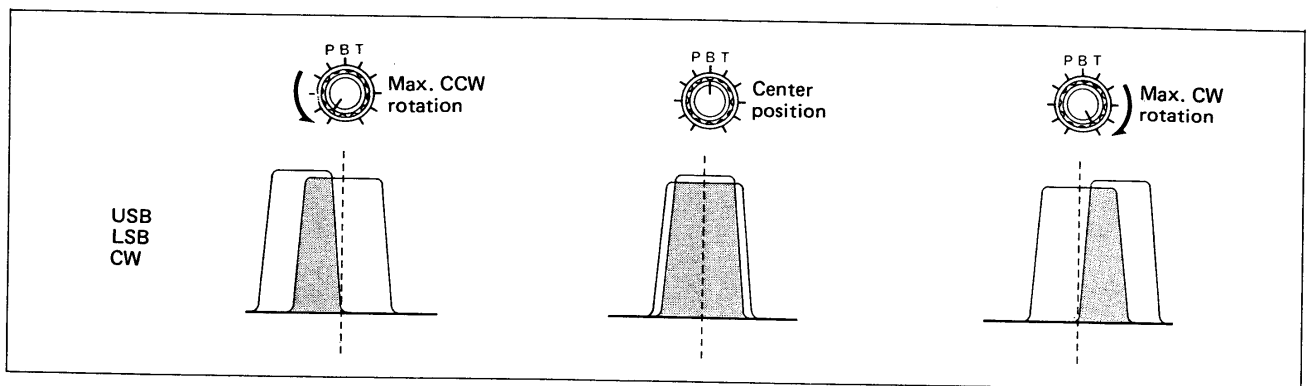

7-9 NOTCH FILTER OPERATION

This circuit provides high attenuation at one particular frequency in the IF passband. It may be used to reduce or eliminate interfering heterodyne signals that fall within the passband of the receiver.

1) Push [NOTCH] FILTER SWITCH.

1) Push the [NOTCH] FILTER SWITCH to the ON position (IN).

2) Adjust [NOTCH] FILTER CONTROL.

2) Adjust the [NOTCH] FILTER CONTROL to minimize interference.

• Notch filter characteristics

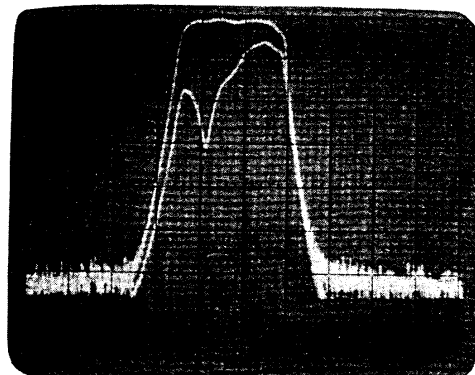

7 - 10 RIT OPERATION

- 1) Push [RIT] SWITCH to turn ON.

Receive : 145.0000MHz
 Transmit: 145.0000MHz

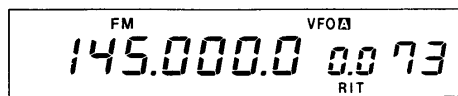
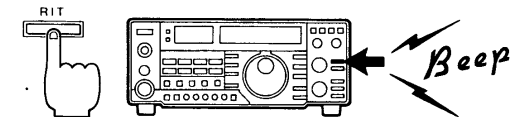

"RIT" appears.

- 2) Rotate INCREMENTAL TUNING CONTROL CW.

Receive : 145.0025MHz
 Transmit: 145.0000MHz

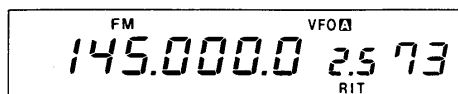
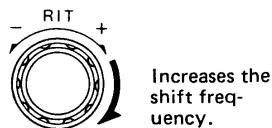

- 3) To clear the RIT shift, push the [RIT-CL] SWITCH.

Receive : 145.0000MHz
 Transmit: 145.0000MHz

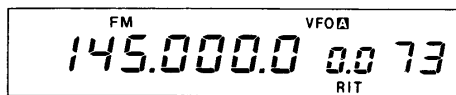

The shift value resets to "0.0".

- 4) To turn OFF the RIT, push the [RIT] SWITCH.

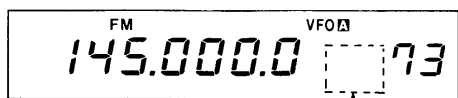

"RIT" disappear

By using the RIT circuit, it is possible to shift the receive frequency up to 9.9kHz to either side of the transmit frequency without moving the transmit frequency. This is useful for fine tuning stations which transmit using off frequency or for compensating for frequency drift.

- 1) Push the [RIT] SWITCH to activate the RIT circuit.

- The letters "RIT" and the amount of shift are displayed.

- 2) Rotate the [RIT] INCREMENTAL TUNING CONTROL in the (+) direction to raise the receive frequency, and in the (-) direction to lower the frequency.

- 3) To clear the RIT shift frequency, push the [RIT-CL] SWITCH.

- The shift value resets to "0.0" and the receive and transmit frequencies become the same whether the RIT circuit is ON or OFF.

- 4) To turn OFF the RIT function, push the [RIT] SWITCH again.

- "RIT" and the amount of shift disappear from the FREQUENCY DISPLAY.

- The transmit and receive frequencies are the same as indicated on the FREQUENCY DISPLAY.

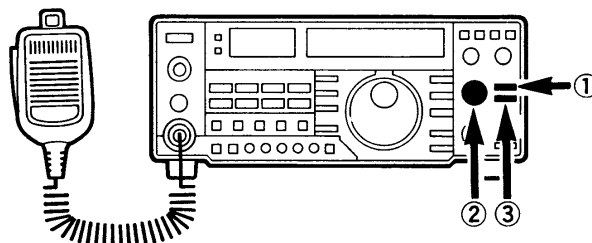

7 - 11 MICROPHONE UP/DOWN OPERATION

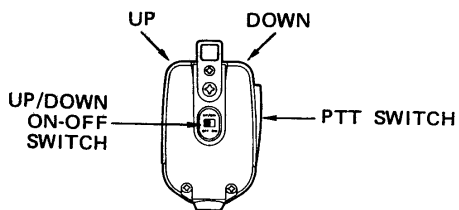

(1) Frequency control

(2) Memory channel selection

This up/down function is useful for changing the operating frequency when using the VFO mode or when using the MEMORY CHANNEL mode.

Microphone UP/DOWN ON-OFF SWITCHES:

- OFF: The [UP] SWITCH and [DN] SWITCH on the microphone are disabled to eliminate the chance of accidental frequency or memory channel changes.
- ON: The [UP] or [DN] SWITCH can be used to change operating frequencies.

1) Each push of the [UP] or [DN] (down) SWITCH on the supplied microphone changes the operating frequency one increment up or down, respectively.

2) Holding either switch down changes the operating frequency continuously in the same manner as the TUNING CONTROL.

1) When using the MEMORY CHANNEL mode, the memory channel may be changed with the microphone up/down switches.

2) The memory channel or the displayed memory channel number change continuously if the microphone switches are held down.

7 - 12 SWR READING OPERATION

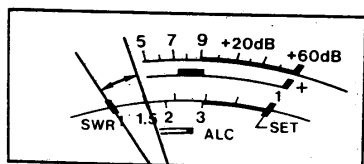
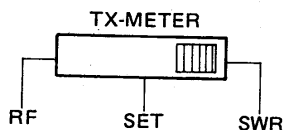

The SWR should be less than 1.5.

The IC-275A/E has a built-in SWR meter to check antenna matching as an aid to avoiding problems caused by high SWR.

1) Set the METER SWITCH on the front panel to the [S·RF] position.

2) Set the [TX-METER] SWITCH on the rear panel to the [SET] position.

3) Select FM mode.

4) Rotate the [MIC GAIN] CONTROL fully CCW.

5) Push the [XMIT] SWITCH to the TRANSMIT (IN) position.

6) Adjust the [RF PWR] CONTROL located on the front panel to move the meter needle to "SET" on the SWR scale.

7) Set the [TX-METER] SWITCH to "SWR". Read the SWR from the SWR scale.

8) If the SWR is less than 1.5, the matching condition between the IC-275A/E and your antenna is good.

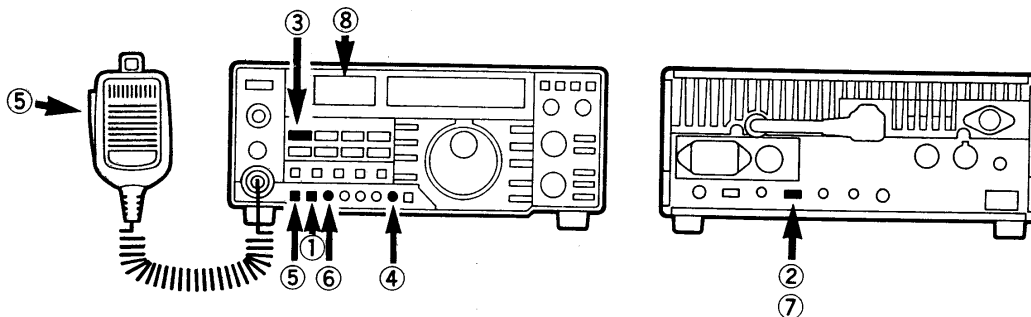

SECTION 8 MEMORY AND SCANNING OPERATION

8-1 MEMORY CHANNEL AND VFO SELECTION

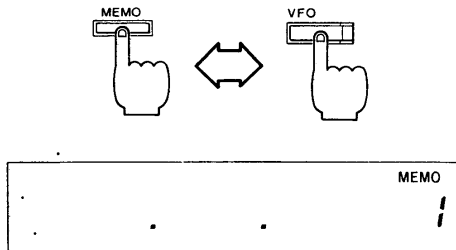

8-2 PROGRAMMING MEMORY CHANNELS

- 1) Select operating parameters.

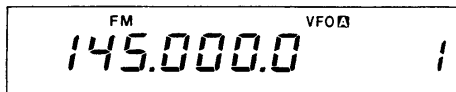

- 2) Select Memory Channel 88.

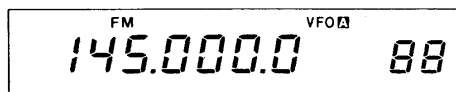

- 3) Push [MW] SWITCH.

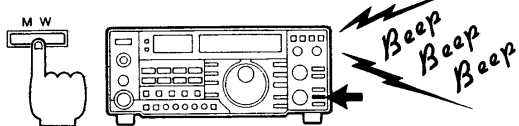

- 4) Push [MEMO] SWITCH to check contents.

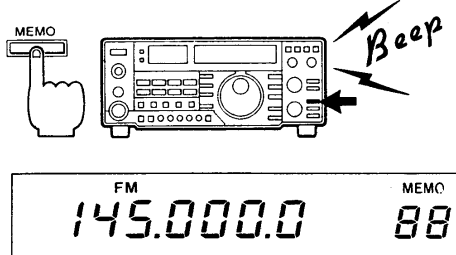

The IC-275A/E has ninety-nine memory channels. One frequency, the operating mode, the subaudible tone frequency, VFO A/B, and the duplex condition may be assigned to each memory channel whether the transceiver is in the VFO mode or the MEMORY CHANNEL mode.

- 1) Push the [MEMO] SWITCH to select the MEMORY CHANNEL mode.

- "MEMO" appears on the FREQUENCY DISPLAY.

- 2) Rotate the [MEMO] CHANNEL SELECTOR CONTROL to select any of the memory channels.

- When memory channels not yet programmed are selected, only the decimal points appear on the FREQUENCY DISPLAY.

- 3) Push the [VFO] SWITCH to return to VFO A or VFO B mode selection.

Any frequency, operating mode, subaudible tone frequency, VFO A/B, or duplex condition may be memorized in any memory channel.

Following are instructions for programming 145.0000MHz and FM mode into Memory Channel 88.

- 1) Set the frequency and mode for 145.0000MHz and FM using the TUNING CONTROL and [FM] MODE SWITCH respectively. VFO A or B may be used while selecting these parameters.

- 2) Select Memory Channel 88 by rotating the [MEMO] CHANNEL SELECTOR CONTROL.

- 3) Push the [MW] SWITCH to program these parameters into Memory Channel 88.

- If the programming is successful three short beep tones will be emitted.

- 4) To check the memory channel contents, push the [MEMO] SWITCH.

- The contents of the selected memory channel are displayed.

8 - 3 PROGRAMMING THE CALL CHANNEL

(1) Programming the CALL CHANNEL

- 1) Hold down [CALL] SWITCH and set the call frequency.

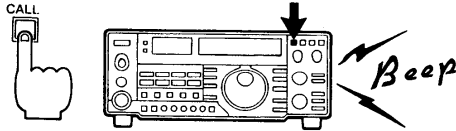

- 2) Set the parameters.

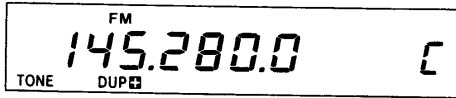

- 3) Push [MW] SWITCH.

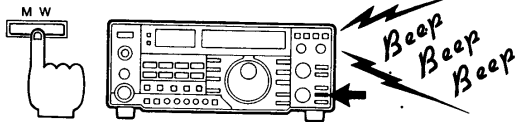

(2) Recalling CALL CHANNEL information

- 1) Push [CALL] SWITCH.

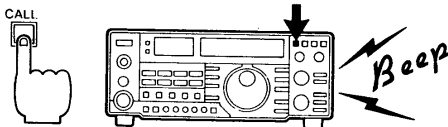

- 2) The "C" and call frequency appear.

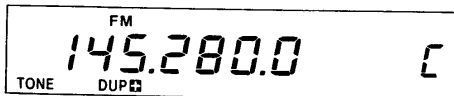

- 3) Push either [VFO] or [MEMO] SWITCH to return to VFO or MEMORY CHANNEL mode.

8 - 4 MEMORY CLEARING

- 1) Push [MEMO] SWITCH.

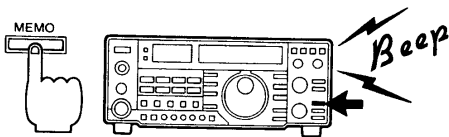

- 2) Select the memory channel to be cleared.

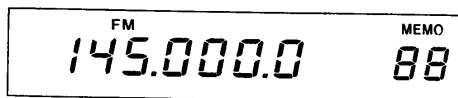

- 3) Push [M-CL] SWITCH.

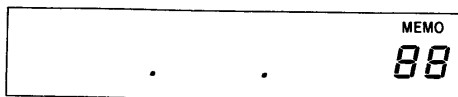

This CALL CHANNEL is useful for quickly recalling and changing frequently used frequencies from any operating mode.

- 1) Hold down the [CALL] SWITCH and set the desired call frequency by rotating the TUNING CONTROL, then release the [CALL] SWITCH.

- 2) Set the needed parameters such as operating mode, subaudible tone frequency, and duplex condition using each switch.

- 3) Push the [MW] SWITCH until three beep tones are emitted for storing these parameters.

CALL CHANNEL information can be recalled.

- 1) Push the [CALL] SWITCH.

- 2) "C" and the programmed call frequency appear on the FREQUENCY DISPLAY.

- 3) Push either the [VFO] or [MEMO] SWITCH to return to VFO or the MEMORY CHANNEL mode.

This function is used to clear the information in each memory channel.

- 1) Push the [MEMO] SWITCH to enter the MEMORY CHANNEL mode.

- 2) Select the memory channel to be cleared, by rotating the [MEMO] CHANNEL SELECTOR CONTROL.

- 3) Push the [M-CL] SWITCH until the three beep tones are emitted from the speaker.

- The memory channel is now vacant.

8 - 5 SCANNING OPERATION

The IC-275A/E comes equipped with four scan functions, providing tremendous scanning versatility at the touch of just a few switches.

SCAN TYPE	OPERATION
MEMORY CHANNEL SCAN	Scans all MEMORY CHANNELS containing information while skipping memories in blank status.
PROGRAMMED SCAN	Repeatedly scans between two user-PROGRAMMED frequencies in the scan range using independent memories P1 and P2 for storage of frequency data.
SELECTED MODE MEMORY SCAN	Repeatedly scans all memory channels containing frequencies in the same MODE as the displayed frequency.
SKIP SCAN	Scans all specified memory channels while skipping unspecified channels and those in blank status.

● Scan function notes

① SCAN SPEED SWITCH

Before starting scanning operations, please read the following additional information and preset the switches and controls. See SECTION 10 INSIDE VIEWS for switch locations.

Switches the scan speed in any scan mode. Slide the switch to the position for the desired speed.

② SCAN STOP INTERVAL SWITCH

Switches the scan auto-stop interval time. The scan restarts automatically after an either 3 or 10 second delay.

③ ADJUSTING SQUELCH CONTROL

Adjust the SQUELCH CONTROL to quiet the noise output from the speaker since the scan will not stop without setting the squelch.

(1) Memory scan

This function is used to automatically scan all programmed memory channels.

1) Program memory channels.

1) Program the desired frequencies into memory channels. Refer to SECTION 8 - 2 PROGRAMMING MEMORY CHANNELS.

2) Adjust [SQL] CONTROL.

2) Adjust the [SQL] CONTROL to quiet the noise output from the speaker.

3) Push [MEMO] SWITCH.

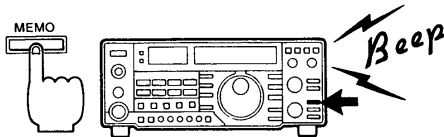

3) Push the [MEMO] SWITCH to select the MEMORY CHANNEL mode.

4) Push [SCAN] SWITCH.

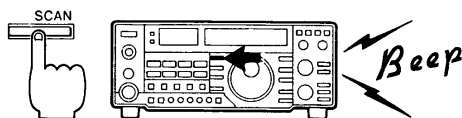

4) Push the [SCAN] SWITCH to start the scan.

- "SCAN" appears on the FREQUENCY DISPLAY.

- The IC-275A/E begins scanning the programmed channels from the lowest channel towards the highest channel.

5) The scan stops when a receive signal opens squelch.

5) The scan stops for approximately 3 or 10 seconds after a receive signal opens the squelch, then resumes scanning.

6) Use [SCAN] SWITCH to manually stop/start scan.

6) Push the [SCAN] SWITCH to stop the scanning function manually. Turning the TUNING CONTROL also stops the scan.

- "SCAN" disappears.

(2) Programmed scan

- 1) Store the scan limits in Memory Channels P1 and P2.

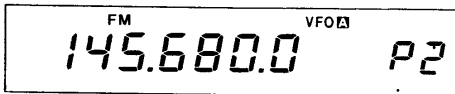
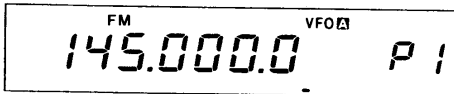

- 2) Select the desired mode.
- 3) Adjust [SQL] CONTROL.
- 4) Push [SCAN] SWITCH to start scan.

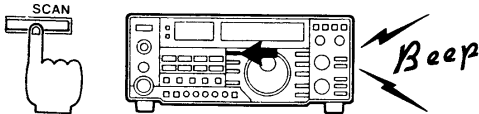

- 5) The squelch opens when a signal is received.
- 6) Push [SCAN] SWITCH to cancel scanning manually.

(3) Selected mode memory scan

- 1) Store desired frequencies.
- 2) Push [MEMO] SWITCH.

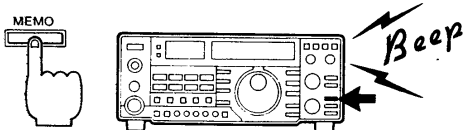

- 3) Adjust the SQUELCH CONTROL.
- 4) Push one of the four MODE SWITCHES.

The purpose of this scanning function is to monitor a particular section of the band.

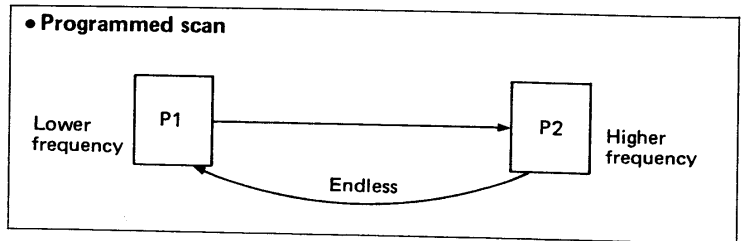

- 1) Store the frequencies of the HIGH and LOW limits of the desired scanning range in memory channels P1 and P2.

- Turn the [MEMO] SELECTOR CONTROL to select Memory Channels P1 and P2. Refer to SECTION 8 - 2 PROGRAMMING MEMORY CHANNELS.

- The scan begins from the LOW limit of the range regardless of which channel has the lower frequency stored.

- 2) Select the desired mode.
- 3) Adjust the [SQL] CONTROL to quiet the noise output from the speaker.

- 4) Push the [SCAN] SWITCH to start the scan. The scanning rate depends on the [TS] SWITCH position.

- "SCAN" appears on the FREQUENCY DISPLAY.

- 5) The squelch opens when a signal is received. After approximately 3 or 10 seconds the scan resumes scanning.

- 6) Push the [SCAN] SWITCH while the scan is operating or during the 3 or 10 second delay period to manually cancel the scan.

- Transmitting or rotating the TUNING CONTROL also cancels the scanning function.

The purpose of this scan is to selectively monitor memory channels which contain frequencies programmed with the same mode: FM, USB, LSB or CW.

- 1) Store the desired frequencies with mode into memory channels.
- 2) Push the [MEMO] SWITCH to select MEMORY CHANNEL mode.

- 3) Adjust the SQUELCH CONTROL to quiet the noise output from the speaker.

- 4) Push one of the four MODE SWITCHES to select a receive mode.

5) Push [MODE-S] SWITCH.

6) Push [SCAN] SWITCH.

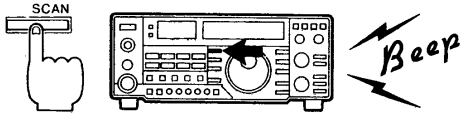

7) The squelch opens when a signal is received.

8) Push [SCAN] SWITCH to manually stop the scan.

(4) Skip scan

1) Store desired frequencies.

2) Push [MEMO] SWITCH.

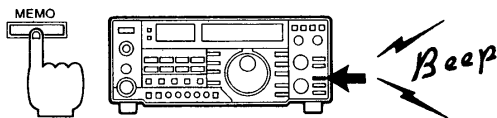

3) Select MEMORY CHANNELS you do not want to receive in.

4) Push [SKIP] SWITCH.



5) Adjust [SQL] CONTROL.

6) Push [SCAN] SWITCH.

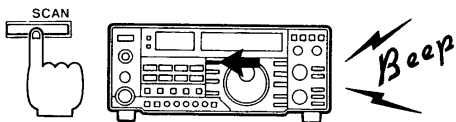

7) The squelch opens when a signal is received.

8) Use [SCAN] SWITCH to manually stop the scan.

5) Push the [MODE-S] SWITCH to set the SELECTED MODE MEMORY SCAN.

6) Push the [SCAN] SWITCH to start the scan.

- "SCAN" appears on the FREQUENCY DISPLAY.

- If a longer beep tone is emitted, no frequency with the desired mode is stored in the memory channels.

7) The squelch opens when a signal is received. After approximately 3 or 10 seconds the scan resumes.

8) Push the [SCAN] SWITCH to stop the scanning function manually. Turning the TUNING CONTROL also stops the scan.

SKIP SCAN repeatedly scans specific memory channels chosen by the user.

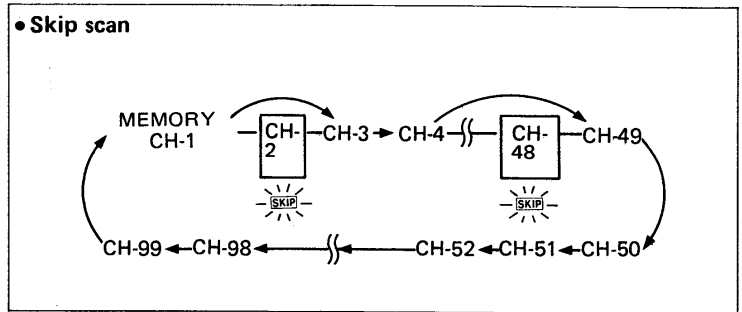

1) Store the desired frequencies with mode, etc., into a memory channel.

2) Push [MEMO] SWITCH to select the MEMORY CHANNEL mode.

3) Select MEMORY CHANNELS you do not want to receive in during scanning operations by using the [MEMO] SELECTOR CONTROL.

4) Push the [SKIP] SWITCH to program a frequency to be skipped into the memory channel.

- "SKIP" appears on the FREQUENCY DISPLAY.

5) Adjust the SQUELCH CONTROL to quiet the noise output from the speaker.

6) Push the [SCAN] SWITCH to start the scan.

- "SCAN" appears on the FREQUENCY DISPLAY.

7) The squelch opens when a signal is received. After approximately 3 or 10 seconds the scan resumes.

8) Push the [SCAN] SWITCH to stop the scanning function manually. Turning the TUNING CONTROL also stops the scan.

SECTION 9 MAINTENANCE AND ADJUSTMENTS

9 - 1 MAINTENANCE

(1) Cleaning



If the transceiver becomes dusty or dirty, wipe it clean with a dry, soft cloth. Avoid the use of strong cleaning agents such as benzine or alcohol as they may damage the surfaces.

(2) Fuse replacement

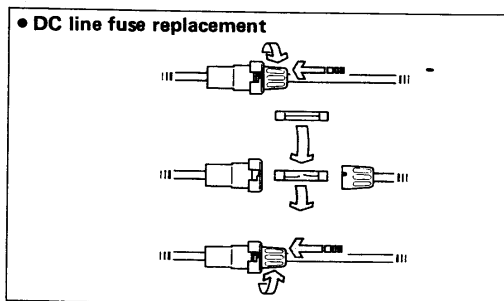

If the fuse blows or the transceiver stops functioning, track down the source of the problem if possible, and replace the damaged fuse with a new, rated fuse.

Rear panel fuse:

- U.S.A. version F.G.M.B 125V 5A
- Europe, Australia version F.G.M.B 250V 3A

DC line (DC cable) fuse (DC cable is an option):

- All versions 10A

(3) Backup battery

The IC-275A/E uses an advanced, highly reliable microprocessor chip. The purpose of the battery is to provide power to the microprocessor so it retains all memory information during power failures, or when the unit is unplugged or turned OFF.

- The usual life of the backup battery exceeds five years. It is advisable to monitor the battery carefully and replace it if there are repeated cases of display malfunction.
- The transceiver transmits and receives normally if the backup battery is exhausted but the transceiver cannot memorize frequencies.

NOTE: Battery replacement should be done by an Authorized ICOM Dealer or ICOM Service Center.

(4) Resetting the internal microprocessor

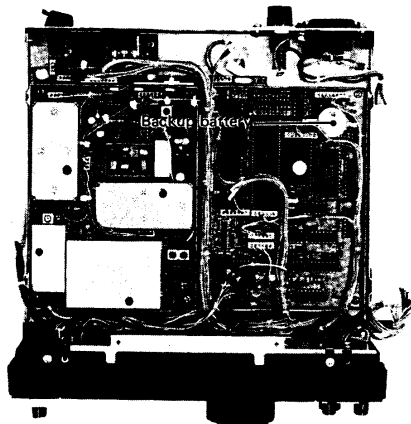

Occasionally, the FREQUENCY DISPLAY may display erroneous information either during operation or when first applying power. This may, for example, be due to an external cause such as static electricity.

When this sort of problem is encountered, turn OFF the power to the IC-275A/E, wait for a few seconds and turn ON the power again. If the problem persists, perform the following procedure.

NOTE: All information programmed in memory channels will be cleared if the transceiver is reset.

- 1) Turn power OFF.
- 2) Hold down the [M-CL] SWITCH and turn the power ON.
- 3) The IC-275A/E is now reset.

9 - 2 ADJUSTMENTS

(1) Brake adjustment

The TUNING CONTROL tension may be adjusted to the operator's preference. The screw adjustment is located on the bottom side of the transceiver cabinet below the TUNING CONTROL. The method for adjustment is as follows:

- 1) Rotate the TUNING CONTROL continuously and smoothly in one direction.
- 2) Adjust the brake adjustment screw either CW for tighter tension, or CCW for looser tension as desired.

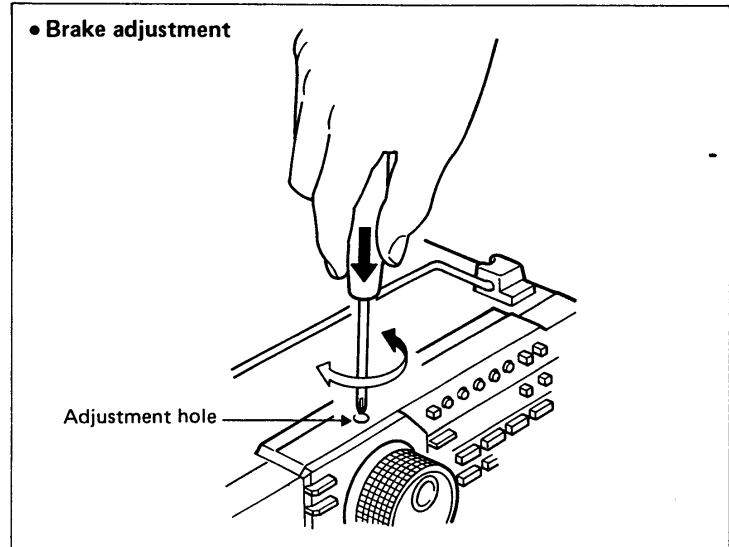

(2) Display light dimmer adjustment

The IC-275A/E has an illuminated FREQUENCY DISPLAY for easy reading in dim or no light situations. The light intensity may be varied to suit the ambient light conditions.

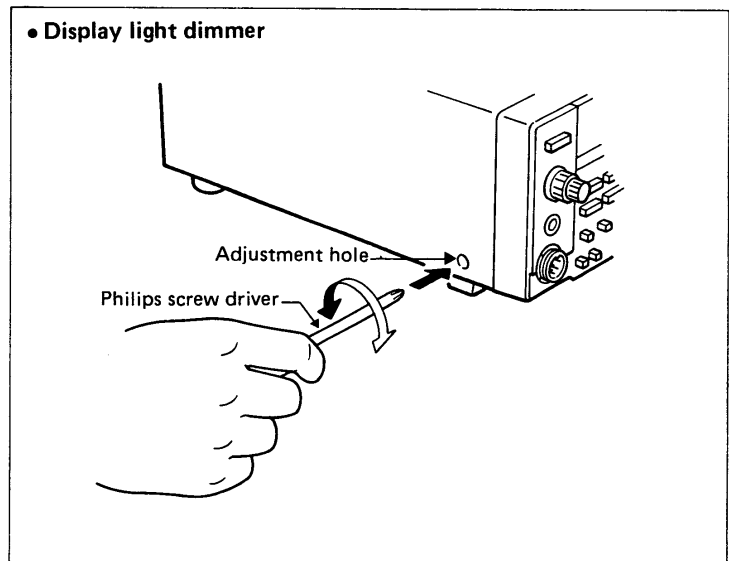

(3) Beep sound level adjustment

The level of the beep sound which is emitted when the specified switches are pushed can be adjusted by R348 on the MAIN UNIT.

- CCW rotation of R348 increases the sound level.
- See SECTION 10 INSIDE VIEWS for the location of R348.

SECTION 10 INSIDE VIEWS

10 - 1 MAIN AND RF-YGR UNITS

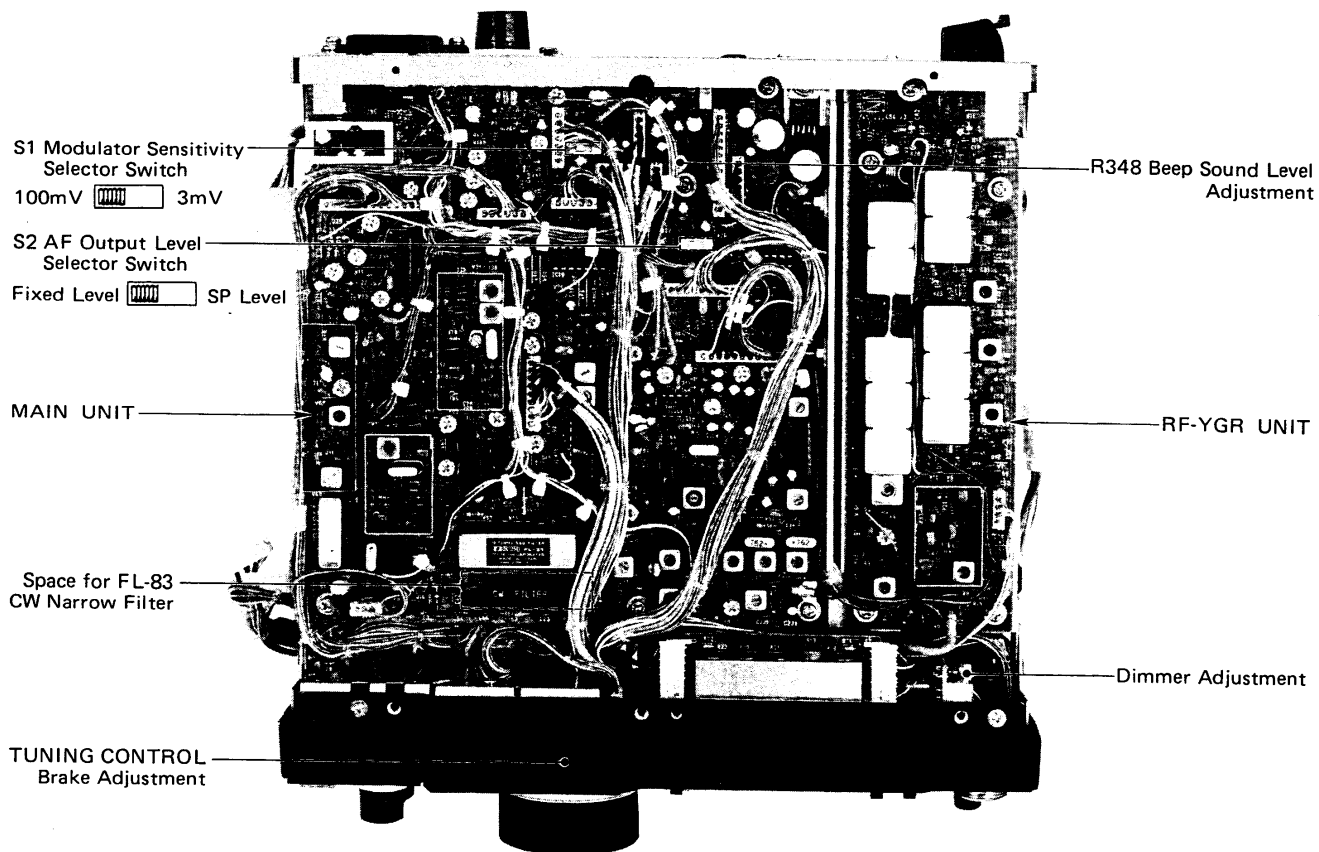

10 - 2 PLL AND LOGIC UNITS

* These pictures may differ from your IC-275A/E model.

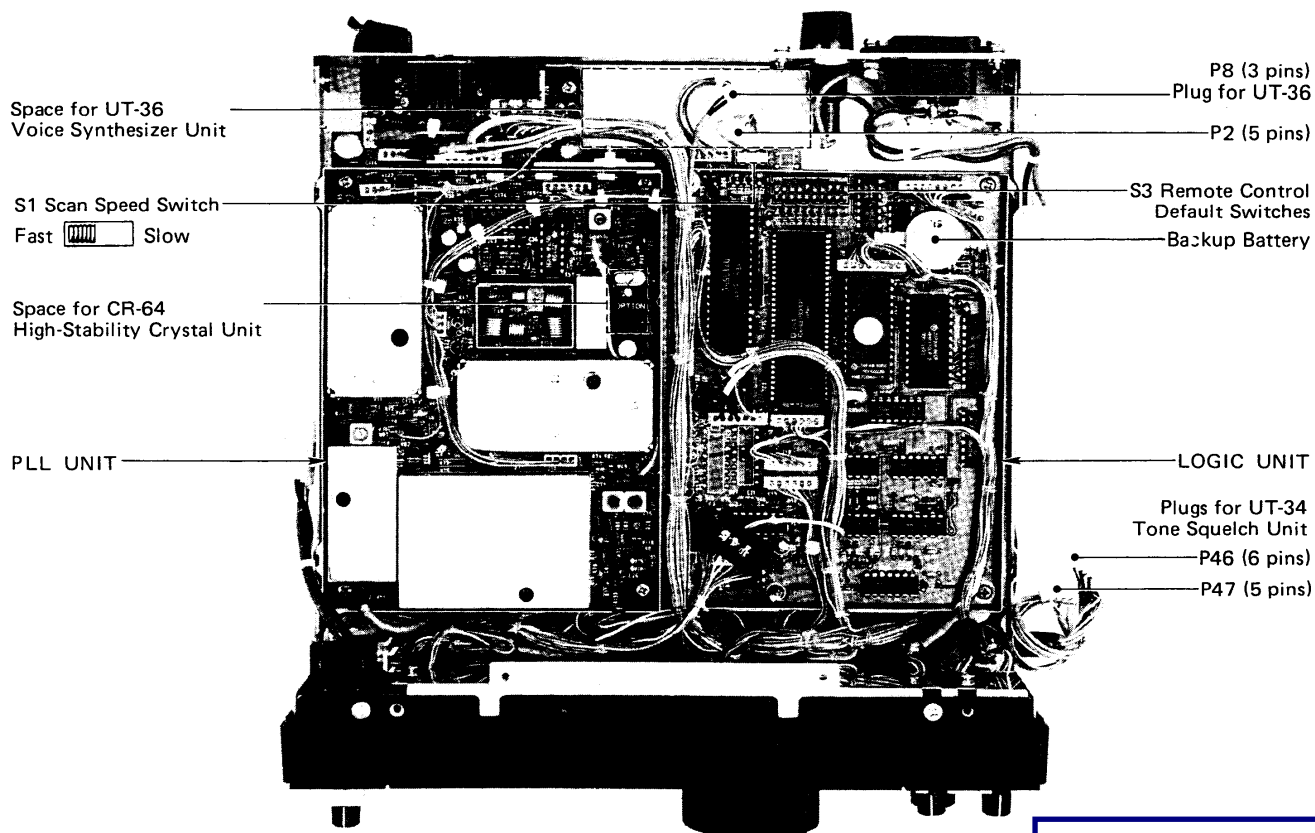

SECTION 11 OPTIONS INSTALLATIONS

11 - 1 DISASSEMBLE THE TRANSCEIVER

- 1) Remove the top cover. The PA UNIT is located here.
- 2) Remove the bottom cover. The MAIN and RF-YGR UNITS are located here.
- 3) Remove the PA UNIT. The PLL and LOGIC UNITS are located underneath the PA UNIT.

■ MAIN AND RF-YGR UNITS SIDE

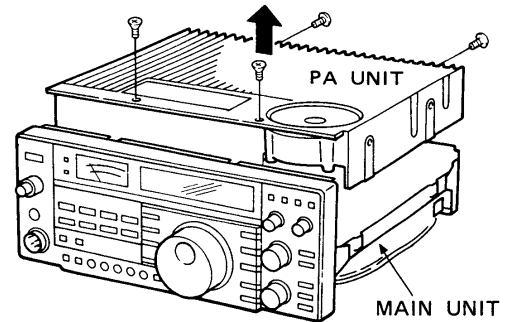
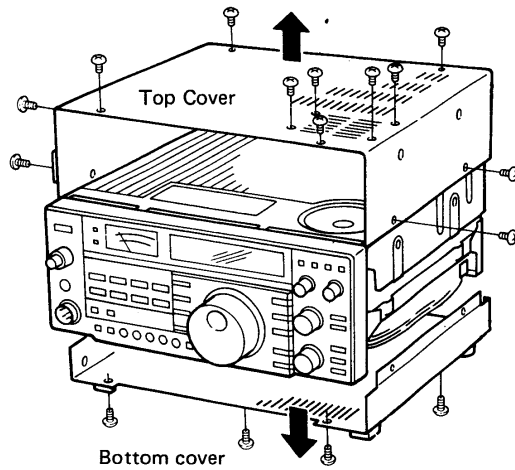
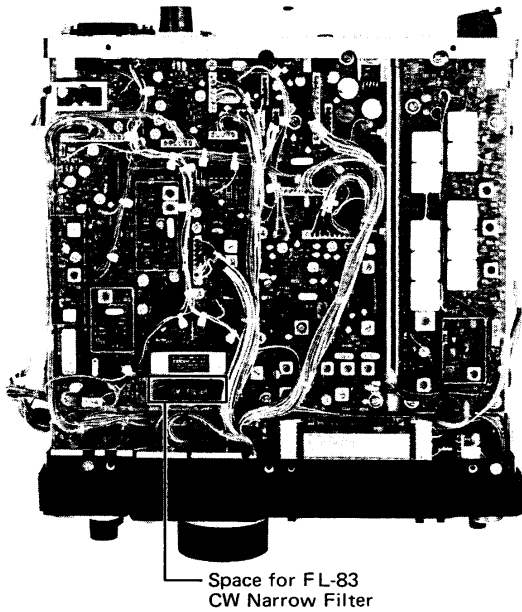

■ PLL AND LOGIC UNITS SIDE

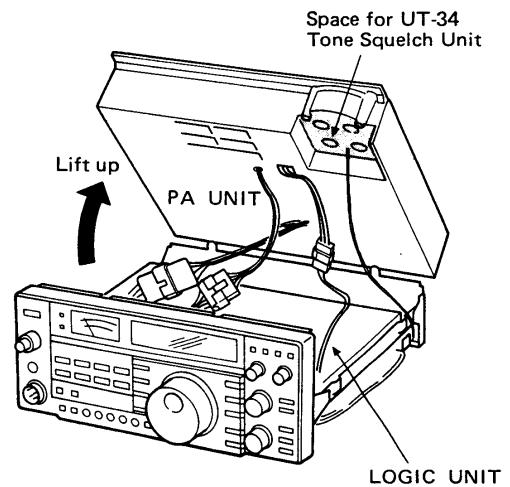
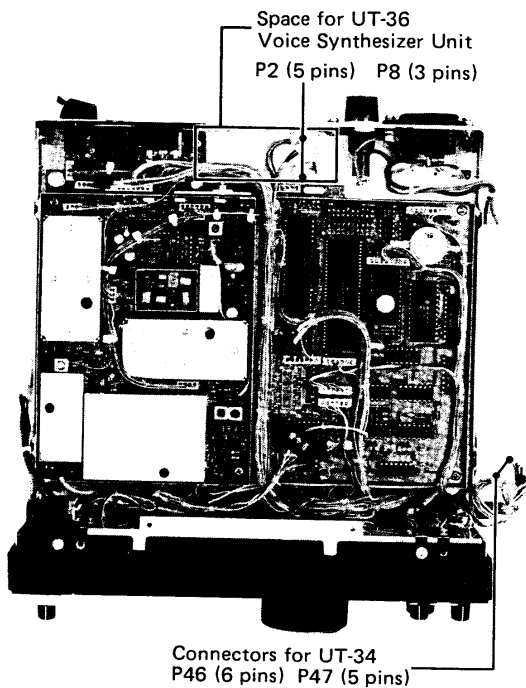

**11 - 2 UT-34
TONE SQUELCH UNIT**

The UT-34 TONE SQUELCH UNIT provides you with interference-free communication with other stations equipped with a Tone Squelch System.

- The unit should be installed in the designated spot behind the internal speaker on the PA UNIT.

- 1) Remove both the top and bottom covers.
- 2) Remove the PA UNIT.
- 3) Install the UT-34 and connect P46 (6 pins) from the LOGIC/FRONT UNITS to J1 on the UT-34.
- 4) Connect P47 (5 pins) from the LOGIC/FRONT UNITS to J2 on the UT-34. Replace the PA UNIT and covers.
- 5) Refer to the UT-34 instruction sheet for operating instructions.

The voice synthesizer announces the displayed frequency and mode, etc. when the [SPCH] SWITCH on the front panel is pushed.

- The UT-36 VOICE SYNTHESIZER UNIT should be installed on the bottom side as shown in the diagram.

- 1) Remove the top and bottom covers.
- 2) Remove the PA UNIT.
- 3) Remove the protective paper from the back of the UT-36 to expose the adhesive strip, and install the unit in the location shown in the bottom view of the transceiver.
- 4) Connect P8 (3 pins) from the MAIN UNIT to J2 on the UT-36.
- 5) Connect P2 (5 pins) from the LOGIC UNIT to J1 on the UT-36.
- 6) Replace the top and bottom covers.
- 7) Refer to the UT-36 instruction sheet for operating instructions.

**11 - 3 UT-36
VOICE SYNTHESIZER UNIT**

**11 - 4 FL-83
CW NARROW FILTER**

This FL-83 CW NARROW FILTER provides you with comfortable interference-free CW communications.

- The FL-83 should be installed on the MAIN UNIT. See SECTION 10 INSIDE VIEWS for the installation location.

FL-83 CW NARROW FILTER : $\pm 250\text{Hz}$

**11 - 5 CR-64
HIGH-STABILITY
CRYSTAL UNIT**

This high-stability crystal unit consists of a temperature-compensating oven heater and a crystal unit. By replacing the original crystal unit with this unit, the total frequency stability of the transceiver will be improved.

- The CR-64 should be installed on the MAIN UNIT. See SECTION 10 INSIDE VIEWS for the installation location.

CR-64 HIGH-STABILITY CRYSTAL UNIT : 0.5ppm
($-30^{\circ}\text{C} \sim +60^{\circ}\text{C}$)

SECTION 13 BLOCK DIAGRAM

Downloaded by
Amateur Radio Directory

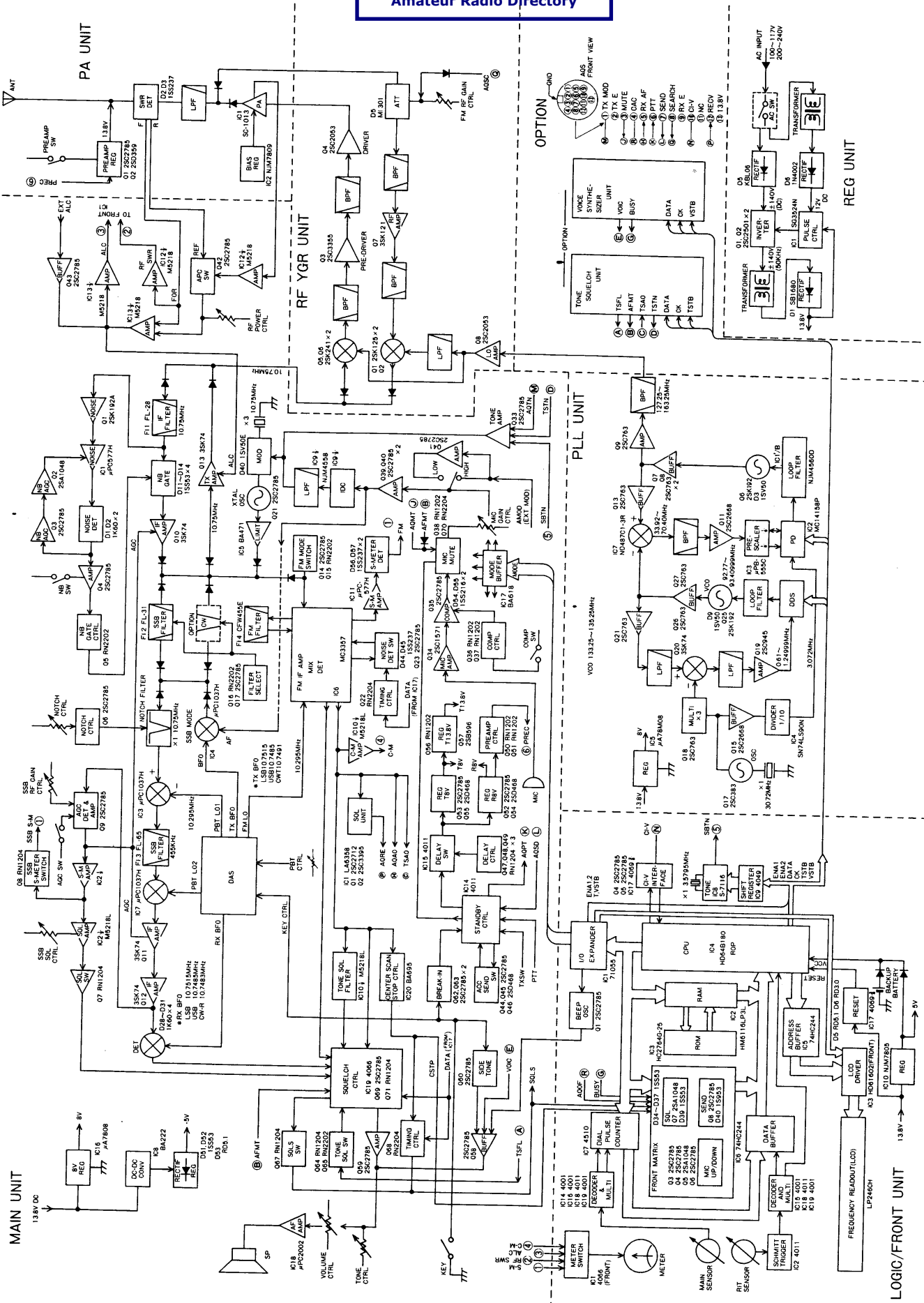

To upgrade quality, some components or frequency systems may be subject to change without notice.

SECTION 12 OPTIONS



IC-PS30
SYSTEM POWER SUPPLY
13.8V, 25A

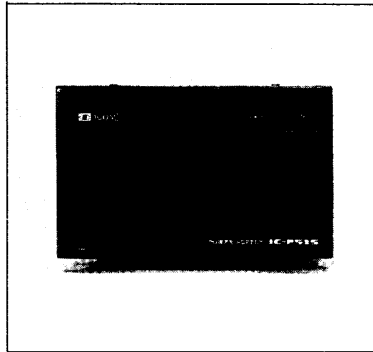

IC-PS15
AC POWER SUPPLY
13.8V, 20A

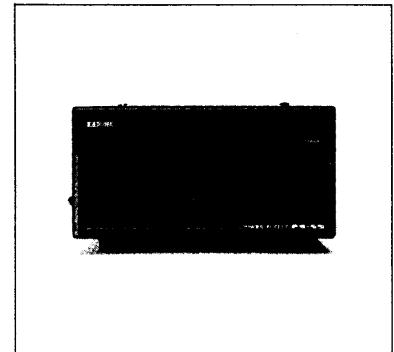

***PS-50 / *PS-55**
AC POWER SUPPLY
13.8V, 8A / 13.8V, 20A

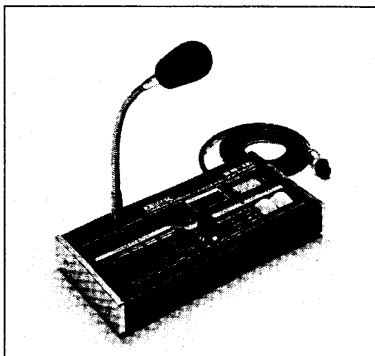

SM-10
COMPRESSOR/GRAPHIC
EQUALIZER DESK TOP
MICROPHONE

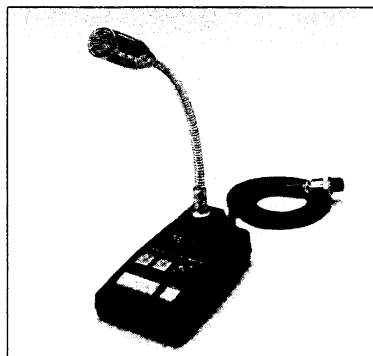

SM-8
DESK MICROPHONE

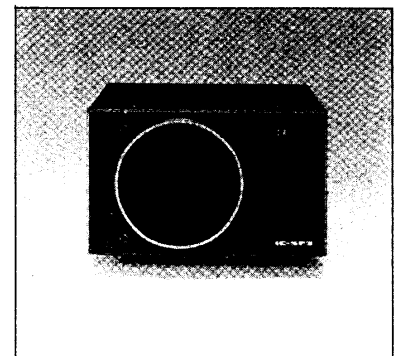

IC-SP3
EXTERNAL SPEAKER

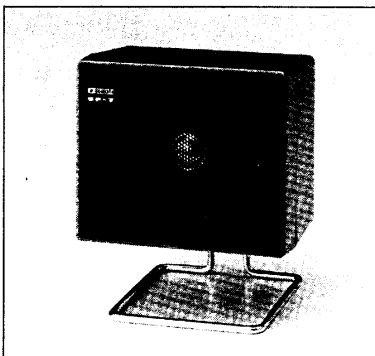

***SP-7**
EXTERNAL SPEAKER

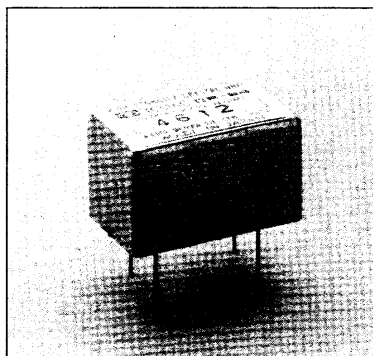

CR-64
HIGH-STABILITY
CRYSTAL UNIT

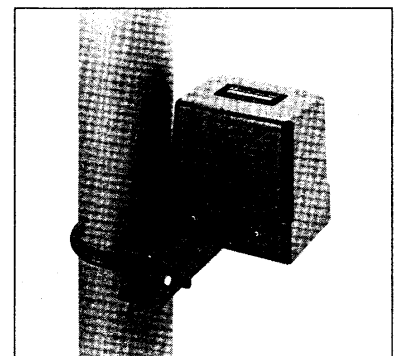

AG-25
WEATHERPROOF 144MHz
PREAMPLIFIER

UT-34	Tone Squelch Unit (Encoder/Decoder Unit)
UT-36	Voice Synthesizer Unit
CT-15	AQS Adapter
CT-16	Satellite Communication Interface Unit with IC-475A/E
FL-83	CW Narrow Filter ($\pm 250\text{Hz}$ at -6dB point)
IC-MB5	Mobile Mounting Bracket

* Matching style and size with IC-275A/E.



ICOM INCORPORATED

1-6-19, KAMIKURATSUKURI, HIRANO-KU,
OSAKA 547, JAPAN