

ICOM

INSTRUCTION MANUAL

VHF FM TRANSCEIVER

IC-2GAT

IC-2GA

IC-2GE

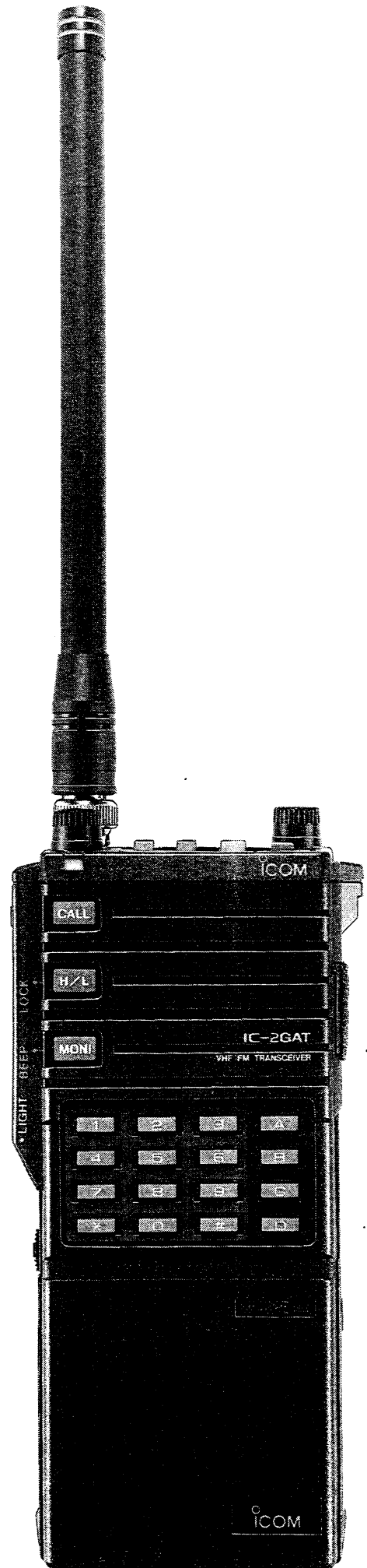

Downloaded by RadioAmateur.EU

Icom Inc.

TABLE OF CONTENTS

1. CAUTIONS	1
2. FEATURES	2
3. MODE CONSTRUCTION	3 ~ 4
4. CONTROL FUNCTIONS	5 ~ 9
4-1 FRONT AND SIDE PANELS	5
4-2 TOP PANEL	7
4-3 FUNCTION DISPLAY	9
5. PRE-OPERATION	10 ~ 11
5-1 CHARGING THE BATTERY PACK	10
5-2 HANDSTRAP AND BELT CLIP ATTACHMENT	11
6. BASIC OPERATION	12 ~ 14
6-1 SETTING A FREQUENCY	12
6-2 RECEIVING	12
6-3 TRANSMITTING	13
6-4 REPEATER OPERATION	14
7. FUNCTIONS OPERATION	15 ~ 20
7- 1 MEMORY READING	15
7- 2 MEMORY WRITING	15
7- 3 MEMORY TRANSFERRING	16
7- 4 PROGRAMMED SCAN	17
7- 5 MEMORY SCAN	18
7- 6 SKIP FUNCTION	18
7- 7 POCKET BEEP AND TONE SQUELCH FUNCTIONS	19
7- 8 CALL CHANNEL OPERATION	19
7- 9 BEEP TONE FUNCTION	20
7-10 LOCK FUNCTION	20
8. SET MODE	21 ~ 24
8-1 SET MODE CONSTRUCTION	21
8-2 SETTING A SUBAUDIBLE TONE	22
8-3 SETTING AN OFFSET FREQUENCY	22
8-4 SETTING A TUNING STEP	23
8-5 SETTING SCAN EDGES	23
8-6 SETTING THE POWER SAVER	24
9. MAINTENANCE	25 ~ 26
10. SPECIFICATIONS	27

FOREWORD

Icom has taken the multi-functional complexity of larger base station transceivers and put it into the new, compact, light, easy-to-use **IC-2GA/GAT/GE VHF FM TRANSCEIVER**.

High transmit power capability, a convenient power saver function, pocket beep function, moisture-proof body, and many more features are all standard with the transceiver.

To fully appreciate the capabilities of your new **IC-2GA/GAT/GE**, please read this instruction manual thoroughly. Also, visit your nearest authorized Icom Dealer or Service Center if you have questions relating to the operation of the transceiver.

UNPACKING

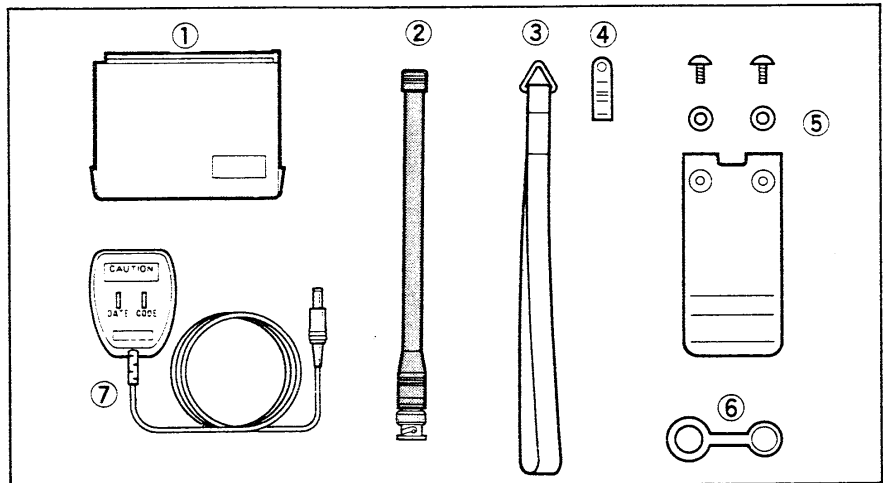

① Battery pack or case* ¹	1
② Flexible antenna	1
③ Handstrap	1
④ Handstrap clip	1
⑤ Belt clip, washers and screws	1set
⑥ Rainproof cap	1
⑦ Wall charger* ²	1

*1 BP-70 for IC-2GAT (U.S.A. version)
BP-3 for IC-2GA/GE (except Southeast Asia version)
BP-4 for IC-2GA/GAT (Southeast Asia version)

*2 BC-16U for IC-2GAT (U.S.A. version)
BC-25U for IC-2GA (U.S.A. version)
BC-27 for IC-2GA (Australia version)
BC-26E for IC-2GE (Europe version)
No charger included with IC-2GAT/GA (Southeast Asia version)

1. CAUTIONS



NEVER use strong cleaning agents such as benzine or thinner on the transceiver.

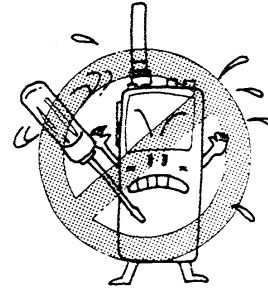

NEVER disassemble the transceiver as it may cause trouble.

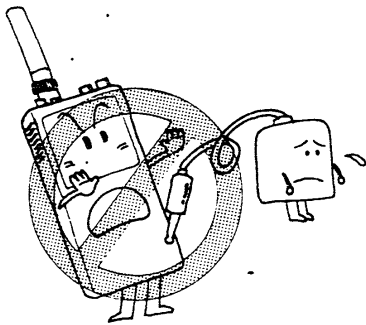

NEVER use chargers other than those suggested on p. 10.

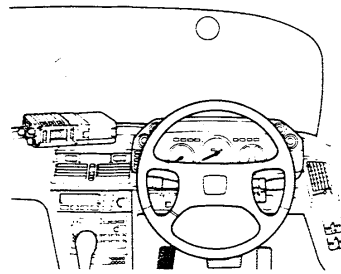

NEVER leave the transceiver on the dashboard in direct sunlight for long periods.

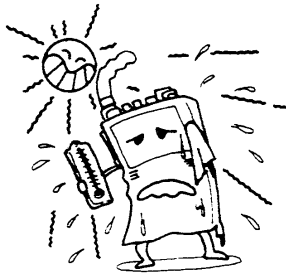

AVOID using the transceiver for long periods in direct sunlight.



AVOID using the transceiver in places subject to excessive cold.



AVOID using the transceiver in excessively dusty places.

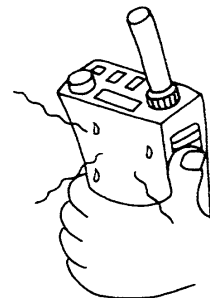

BE CAREFUL when transmitting for a long time. The rear panel may become hot.

■ HIGH OUTPUT POWER

Small, compact size is not a limiting factor when it comes to high output power. Full 7W are available with the BP-7 or BP-70 BATTERY PACK.

■ SPLASH RESISTANT

Rubber gaskets ensure that water splashed on the transceiver does not penetrate the casing.

■ 20 MEMORY CHANNELS PLUS CALL CHANNEL

The transceiver is equipped with a total of 20 memory channels and one CALL channel. Each memory channel can independently memorize operating frequencies and all information required to work a repeater.

Note that the IC-2GE is not equipped with a CALL channel.

■ POWER SAVER DESIGN

All circuits are designed using low power dissipation techniques to create a special power save circuit in the transceiver. The power saver circuit functions if no signal is received or no switch operation is performed for more than 30sec. and requires only 1/4 current flow during regular receiving conditions. In addition, the power saver circuit can be turned OFF for packet communications.

■ TWO DIFFERENT SCAN FUNCTIONS

Two different scans, programmed scan and memory scan, are provided with the transceiver. In addition, memory skip channels can be programmed to skip selected memory channels during memory scanning operation.

■ SQUELCH MONITOR FUNCTION

The squelch monitor function opens squelch for as long as it is pushed without having to adjust the SQUELCH CONTROL back and forth at the squelch threshold level. This is a fast and easy way to monitor weak signals.

■ POCKET BEEP FUNCTION

This convenient pocket beep function lets you know when subaudible tones identical to your own pre-programmed ones arrive at the transceiver. Just install an optional UT-40 TONE SQUELCH UNIT in the transceiver to activate the function.

Note that the UT-40 cannot be installed in the IC-2GE.

3. MODE CONSTRUCTION

The transceiver has 4 different modes for versatile, multi-function operations. The following is an explanation of each mode.

(1) VFO MODE

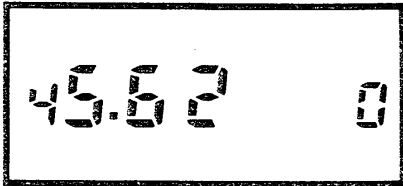

This mode is used for normal operations using all bandwidths. Frequency changes, programmed scanning, and other functions are possible in VFO mode.

(2) MEMORY MODE



This mode is used for operating the transceiver using memory channel contents. You can use 20 memory channels for programming repeater frequencies, your group frequency, and more.

(3) CALL CHANNEL MODE



This mode is used for operating the transceiver on a programmed priority channel. When the mode is selected, no switches on the top panel function (except while pushing the [FUNCTION] SWITCH).

Note that the IC-2GE is not equipped with a CALL channel since the [T. CALL] SWITCH is used to activate the 1750Hz tone call function.

(4) SET MODE

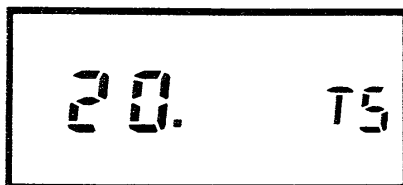

This mode is used for programming subaudible tone frequencies,* tuning steps, programmed scan edges and the power saver ON/OFF. The mode can be changed from VFO mode with the [FUNCTION] + [V/M] SWITCHES.

*IC-2GAT : Built-in

IC-2GA : When an optional UT-40 TONE SQUELCH UNIT is installed.

•Flow chart of modes

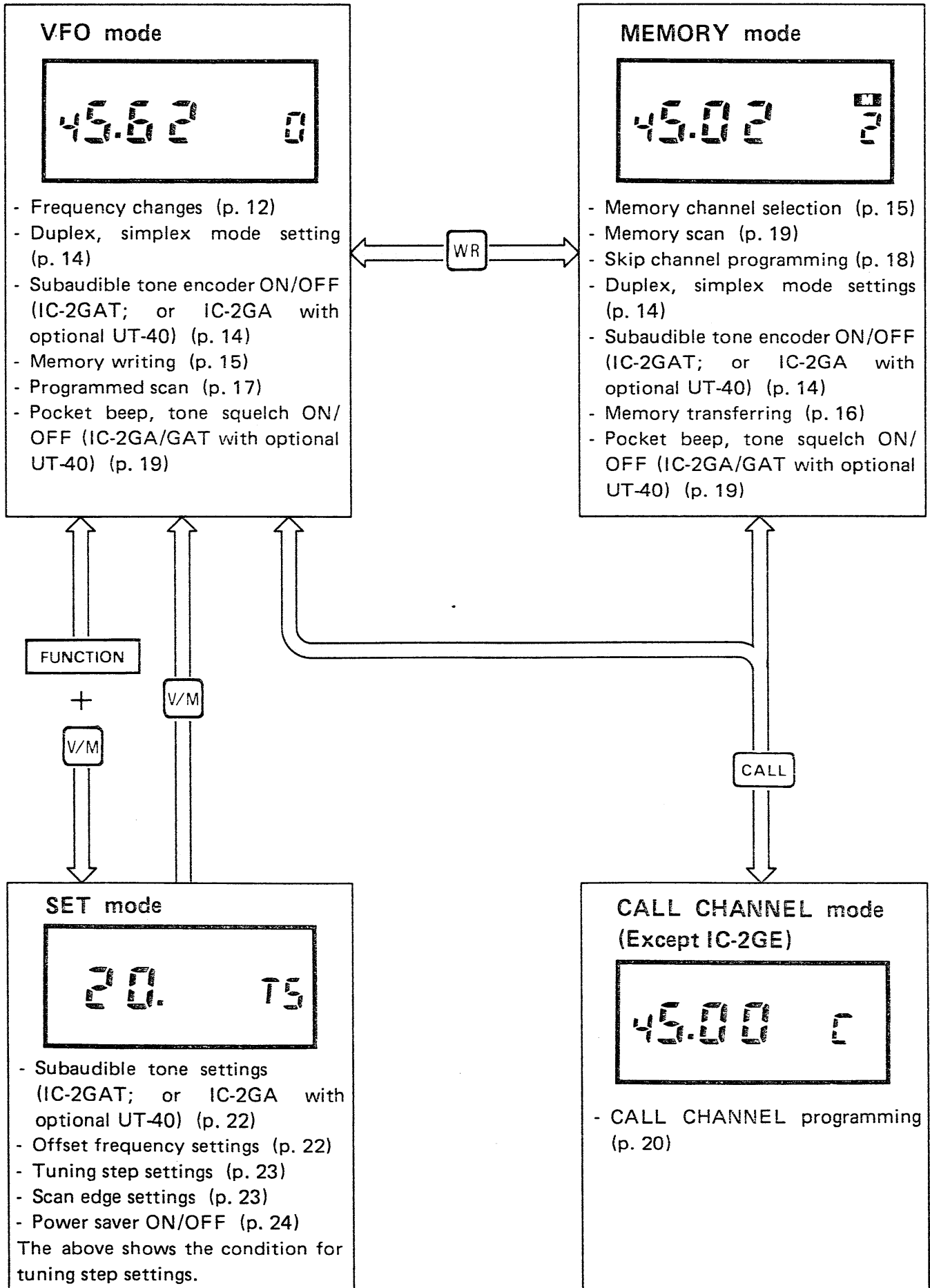

4. CONTROL FUNCTIONS

4-1 FRONT AND SIDE PANELS

VOLUME CONTROL/POWER SWITCH [OFF/VOL]
Turns ON the power and increases the audio level. (p. 12)

TRANSMIT INDICATOR
Lights up while transmitting. (p. 13)

SQUELCH CONTROL [SQL]
Sets the squelch threshold point. (p. 12)

ANTENNA CONNECTOR
Connect an antenna here.

FUNCTION SWITCH [FUNCTION]
Selects the secondary function of some switches when pushed and held.

PTT SWITCH
Selects transmitting. (p. 13)

LIGHT SWITCH [LIGHT]
Lights up the FUNCTION DISPLAY. The backlight goes out after 5sec. if other switches are not pushed.

BATTERY PACK RELEASE BUTTON [RELEASE]
Removes the battery pack from the transceiver while pushed upwards. (p. 10)

SPEAKER

DTMF KEYBOARD (IC-2GAT only)
Keys on this keyboard are used for accessing a repeater and making an auto phonepatch. (p. 14)

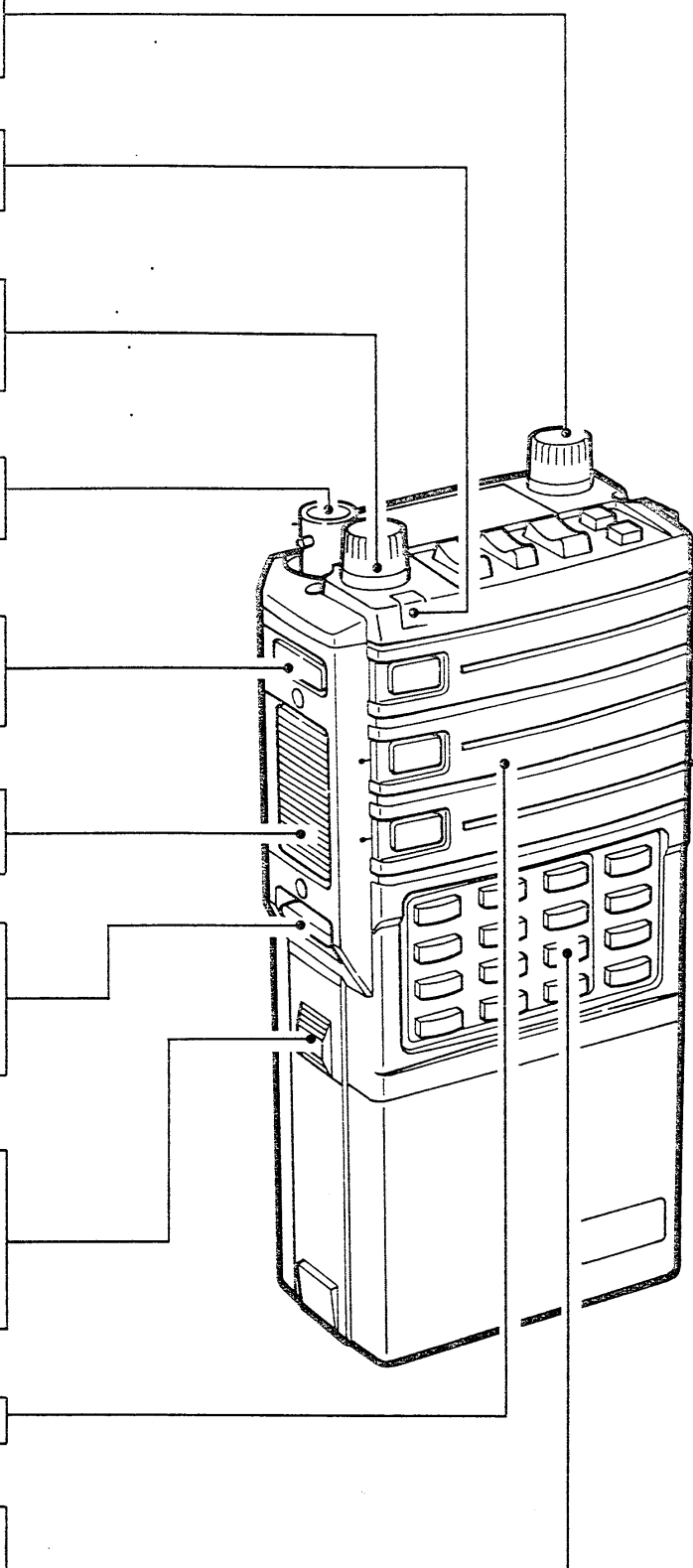

CONTROL FUNCTIONS 4.

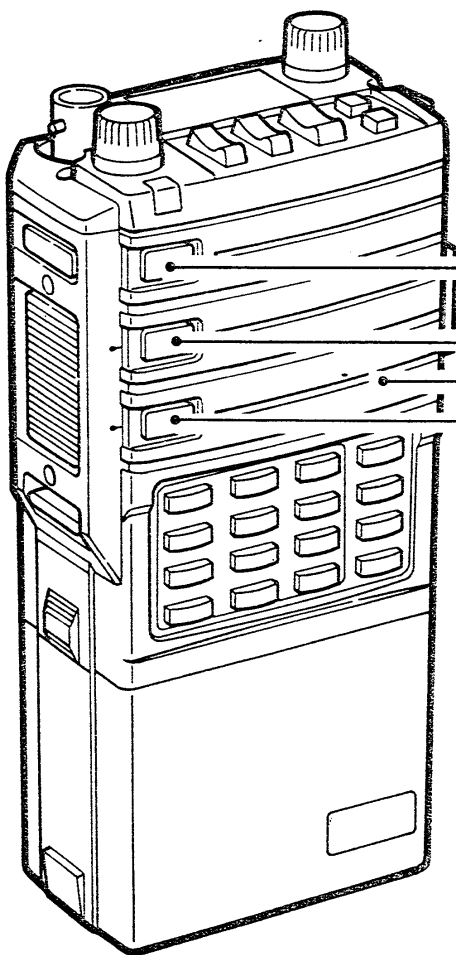

CALL SWITCH [CALL] (IC-2GA/GAT)

Selects the CALL channel. (p. 19)

TONE CALL SWITCH [T. CALL] (IC-2GE)

Transmits a 1750Hz tone for repeater operation. (p. 14)

EXTERNAL MIC AND SPEAKER JACKS [EXT SP MIC]

Accepts an optional HM-46L SPEAKER-MICROPHONE or earphone plug.

RF OUTPUT POWER SWITCH [H/L]

Selects RF output power.

HIGH: Approx. 7W (IC-2GAT U.S.A. version with supplied BP-70)

Approx. 3.5W (IC-2GA/GE with supplied BP-3)

LOW: 1W (p. 13)

- When pushing [FUNCTION]:
Turns ON and OFF the LOCK function. (p. 20)

MICROPHONE

MONITOR SWITCH [MONI]

Opens the squelch. Opens the tone squelch even when a pre-programmed tone is not received. (p. 12)

The transmit frequency is simultaneously monitored if duplex mode is selected. (p. 14)

- When pushing [FUNCTION]:
Turns ON and OFF beep tones. (p. 20)

These diagrams show the IC-2GAT. The IC-2GA and IC-2GE do not include a DTMF KEYBOARD.

4. CONTROL FUNCTIONS

4-2 TOP PANEL

■ OPERATING IN VFO MODE

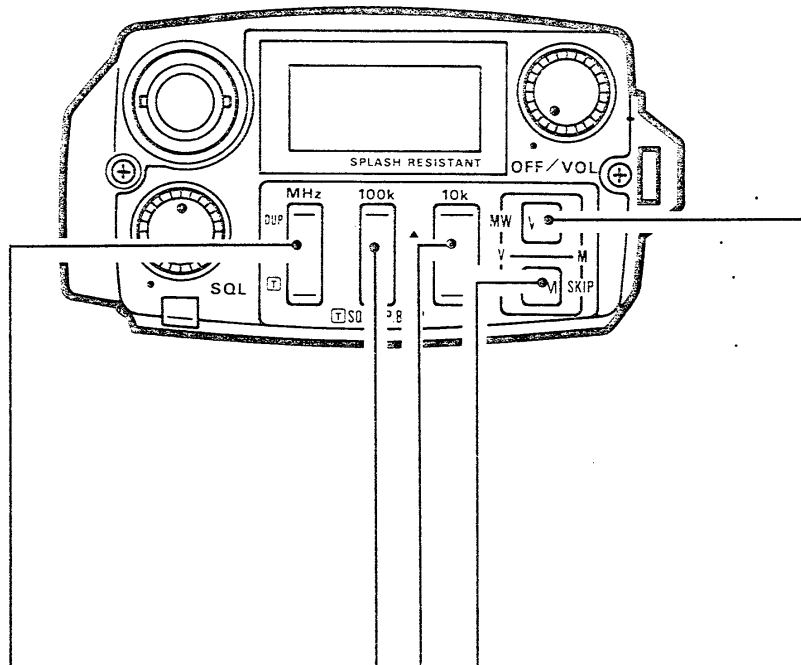

MHz DIGIT UP/DOWN SWITCH [MHz]

Selects 1MHz digits upwards or downwards. (p. 12)

- While pushing [FUNCTION] :
Selects -duplex and +duplex modes in sequence when pushed upwards. (pgs, 13, 14)

Turns ON and OFF the subaudible tone encoder when pushed downwards (IC-2GAT; or IC-2GA with optional UT-40). (p. 14)

100kHz DIGIT UP/DOWN SWITCH [100k]

Selects the 100kHz digit. (p. 12)

- While pushing [FUNCTION] :
Selects functions below in sequence (IC-2GA/GAT with an optional UT-40):

Pocket been → Tone squelch → OFF (p. 19)

WRITE SWITCH [WR]

Writes the displayed contents in a memory channel when pushed and held. (p. 15)

VFO/MEMORY SWITCH [V/M]

Selects MEMORY mode. (p. 15)

- While pushing [FUNCTION] :
Selects SET mode. (p. 21)

10kHz DIGIT UP/DOWN SWITCH [10k]

Selects the last digit in the minimum frequency step. (p. 12)

- While pushing [FUNCTION] :
Starts the programmed scan when pushed upwards or downwards. (p. 17)

OPERATING IN MEMORY MODE

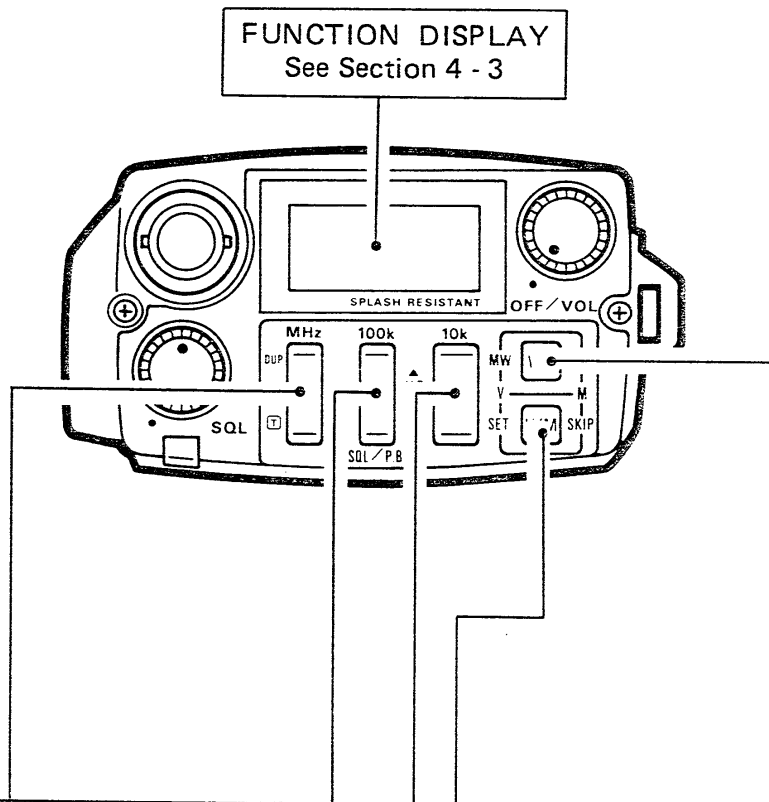

MHz DIGIT UP/DOWN SWITCH [MHz]

- While pushing [FUNCTION]:
Selects -duplex and +duplex modes in sequence when pushed upwards. (pgs. 13, 14)

Turns ON and OFF the subaudible tone encoder when pushed downwards (IC-2GAT; or IC-2GA with optional UT-40). (p. 14)

WRITE SWITCH [WR]

Transfers memory channel contents to VFO when pushed and held. (p. 16)

VFO/MEMORY SWITCH [V/M]

Selects VFO mode. (p. 12)

- While pushing [FUNCTION]:
Programs a memory skip channel. (p. 18)

100kHz DIGIT UP/DOWN SWITCH [100k]

Selects 10 digit numbers in the memory channel. (p. 15)

- While pushing [FUNCTION]:
Selects functions below in sequence (IC-2GA/GAT with an optional UT-40):

Pocket beep → Tone squelch → OFF (p. 19)

10kHz DIGIT UP/DOWN SWITCH [10k]

Selects the memory channel. (p. 15)

- While pushing [FUNCTION]:
Starts the memory scan when pushed upwards or downwards. (p. 18)

4. CONTROL FUNCTIONS

4-3 FUNCTION DISPLAY

DUPLEX INDICATORS

"DUP" or "-DUP" appears when duplex mode is selected. (p. 14)

STONE AND SQUELCH INDICATORS

"T" appears when the subaudible tone encoder is turned ON (IC-2GAT; or IC-2GA with UT-40). (p. 41)

- "SQL" appears when an optional pocket beep function is turned ON (IC-2GA/GAT with an optional UT-40). (p. 19)

- "T SQL" appears when an optional tone squelch function is turned ON (IC-2GA/GAT with an optional UT-40). (p. 19)

LOCK INDICATOR

"L" appears when the lock function is activated. (p. 20)

MEMORY SKIP INDICATOR

"SKIP" appears when the displayed memory channel is programmed as a skip channel. (p. 18)

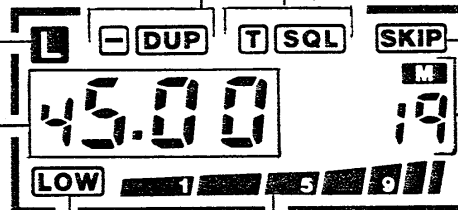

FREQUENCY DISPLAY

The operating frequency is shown in VFO or MEMORY mode. (p. 12)

Programmed contents are also shown in SET mode. (p. 21)

MEMORY CHANNEL INDICATOR

Memory channel is shown in MEMORY mode. (p. 15)

"C" appears in CALL CHANNEL mode (except IC-2GE). (p. 19)

LOW POWER INDICATOR

"LOW" appears when LOW power is selected. (p. 13)

S/R/F INDICATOR

Shows signal strength when receiving and selection of HIGH or LOW output power when transmitting. (p. 12, 13)

5 - 1 CHARGING THE BATTERY PACK

(1) REMOVING THE BATTERY PACK

Push the BATTERY PACK RELEASE BUTTON upwards, and slide the battery pack to the right to remove it from the transceiver.

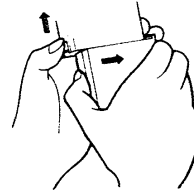

(2) CHARGING CONNECTION

To charge the battery pack, use the supplied wall charger or an optional BC-35U/E, BC-36 AC BATTERY CHARGER, or other power source as shown below.

• Charging the BP-70 BATTERY PACK

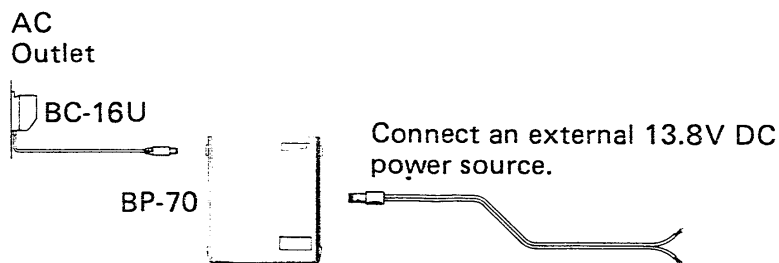

• Charging the BP-3 BATTERY PACK

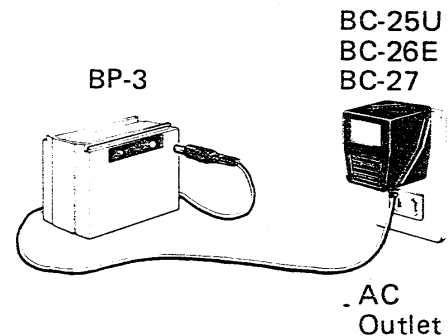

(3) BATTERY PACK CAUTIONS

- **NEVER** throw the battery pack into a fire since battery gas could cause an explosion.
- **NEVER** put the battery pack in water. If the battery pack is wet, be sure to wipe it dry.
- **NEVER** short the terminals on the top panel of the battery pack. Use the plastic insulator strip provided to prevent this.
- Note that the TRANSMIT INDICATOR [TX] may go out during HIGH output power operation with the BP-4, because current drawn on the battery's internal resistance causes a voltage drop. In this state, the transceiver operates normally for a time. However, when the batteries are exhausted, exchange all old batteries for new ones. **DO NOT** use old batteries with new ones.

5. PRE-OPERATION

(4) BATTERY PACK LIFE

Stated operation times are approximate, and conform to the following ratio:

Transmit : Receive : Standby
1 min. : 1 min. : 8 min.

	BP-2	BP-3	BP-5 BP-5A	BP-7	BP-8	BP-70
Capacity	450mAh	270mAh	450mAh	450mAh	800mAh	270mAh
Voltage	7.2V	8.4V	10.8V	13.2V	8.4V	13.2V
Operation times	3.8hrs.	2.0hrs.	2.4hrs.	2.5hrs.	5.9hrs.	1.5hrs.

(5) BATTERY PACK NOTE

The full charge capacity of NiCd batteries may be reduced if repeatedly charged with only partial discharge periods. This is called the Battery Memory Effect. If the battery capacity seems lower than when new, discharge the battery pack completely through normal use, then charge fully using the proper charger.

5 - 2 HANDSTRAP AND BELT CLIP ATTACHMENT

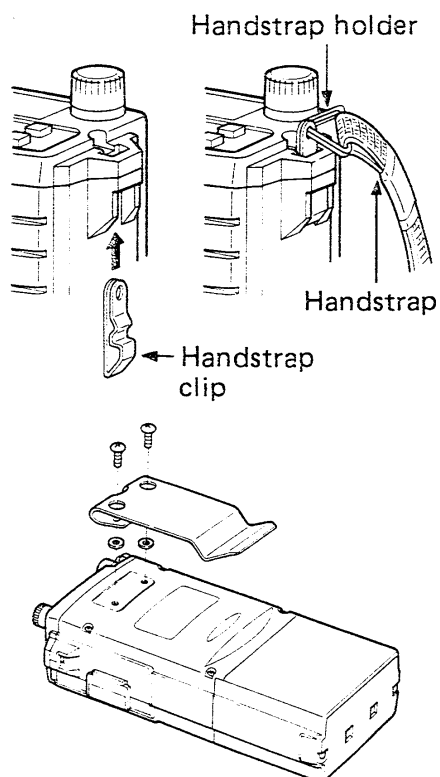

1) Insert the handstrap clip as shown below.

2) Slide the handstrap holder through the hole in the handstrap clip.

3) Remove the bushing from the two holes on the rear panel.

4) Attach the belt clip to the rear panel using the supplied screws and washers. Screws and washers are pre-attached to the transceiver rear panel.

BASIC OPERATION 6.

6 - 1 SETTING A FREQUENCY

- 1) Turn power ON.



- 2) Select VFO mode.



- 3) Set frequency.

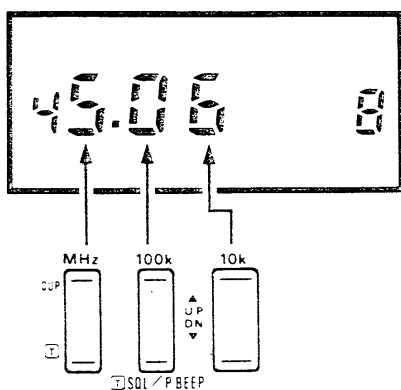

The operating frequency can be set using the convenient top panel Digital Touchstep Switches.

- 1) Rotate the [OFF/VOL] CONTROL to turn the power ON.

- 2) If "M" appears on the FUNCTION DISPLAY (in MEMORY mode), push the [V/M] SWITCH to select VFO mode.

- 3) Push either DIGIT UP/DOWN SWITCH upwards or downwards to set the frequency.

- The [10k] SWITCH changes the frequency in the programmed tuning step. See p. 23 for tuning step programming.

6 - 2 RECEIVING

- 1) Turn power ON and adjust [OFF/VOL] CONTROL.

- 2) Adjust [SQL] CONTROL.

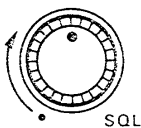

- 3) Set the desired frequency.

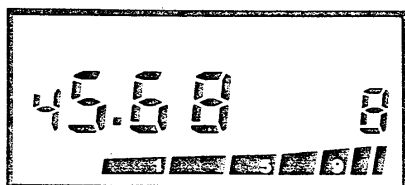

- 1) Rotate the [OFF/VOL] CONTROL to turn the power ON and adjust to a suitable audio level.

- 2) Adjust the [SQL] CONTROL until the noise is quieted.

- 3) Set the desired frequency using the DIGIT UP/DOWN SWITCHES. See p. 7 for setting a frequency.

- When receiving a signal, the S/R F INDICATOR displays the signal strength and audio is emitted from the speaker.

- 4) Push and hold [MONI] SWITCH.

- 4) Push and hold the [MONI] SWITCH to open the squelch and optional tone squelch functions.

6. BASIC OPERATION

6 - 3 TRANSMITTING

CAUTION: DO NOT transmit without an antenna or the transceiver may be damaged.

1) Turn power ON.

1) Rotate the [OFF/VOL] CONTROL to turn the power ON.

2) Select output power.

2) Push the [H/L] SWITCH to select the desired output power.

H/L

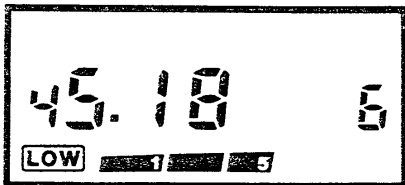

- "LOW" appears when LOW power is selected.

HIGH: Approx. 3.5W (with BP-3)
 Approx. 7W (with BP-7 or BP-70)
 LOW: 1W

3) Select simplex mode.

3) Select simplex mode if "DUP" or "-DUP" appears on the FUNCTION DISPLAY. Push and hold the [FUNCTION] SWITCH and then push the [MHz] SWITCH upwards.

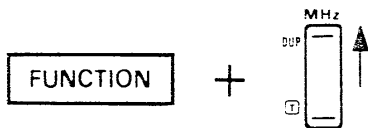

4) Push PTT SWITCH.

4) Push the PTT SWITCH to begin transmitting, and speak into the microphone (located under the right side of the speaker).



- The red TRANSMIT INDICATOR lights up and the bars indicate relative output power selection.

- When the battery is exhausted, the red TRANSMIT INDICATOR does not light up.

NOTE: DO NOT hold the transceiver too closely to your mouth or speak too loudly. This may distort the signal.

(LOW output power)

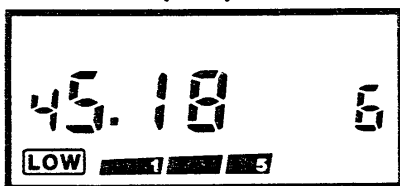

3 bars appear.

(HIGH output power)

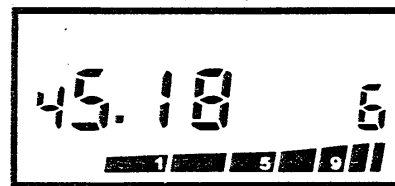

All bars appear.

6 - 4 REPEATER OPERATION

1) Set frequency.

2) Select duplex mode.

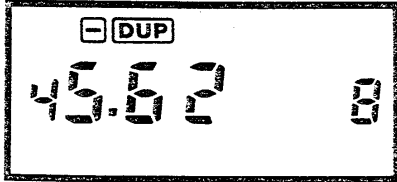

3) Push PTT SWITCH.

4) Push [MONI] SWITCH.



■ SOME CONTROLLED REPEATERS

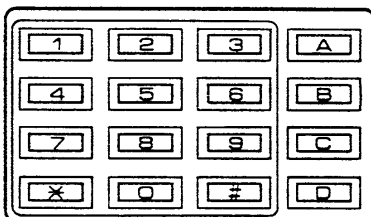
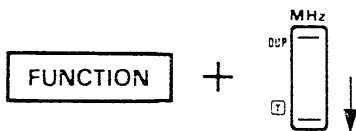

1) Set the desired frequency to the repeater output frequency.

2) Push and hold the [FUNCTION] SWITCH and then push the [MHz] SWITCH upwards to select +duplex or -duplex mode.

- See p. 22 for setting an offset frequency for duplex operation.

3) Push the PTT SWITCH to begin transmitting, and speak into the microphone.

- The transmit frequency automatically shifts with the programmed offset frequency.

4) Push the [MONI] SWITCH to monitor the transmit frequency (repeater input frequency).

- The squelch and optional tone squelch functions open.

- A repeater controlled by a subaudible tone. (with IC-2GAT)

Push and hold the [FUNCTION] SWITCH and then push the [MHz] SWITCH downwards to turn the subaudible tone encoder ON.

- A repeater controlled by DTMF signals. (with IC-2GAT)

Push and hold the PTT SWITCH and then push the required number keys on the DTMF KEYBOARD.

- A repeater controlled by a 1750Hz tone call. (with IC-2GE)

Push the [T. CALL] SWITCH for approximately 1 ~ 3 sec.

7. FUNCTIONS OPERATION

7 - 1 MEMORY READING

The transceiver has 20 memory channels. An operating frequency, duplex condition, subaudible tone frequency and channel skip function may be assigned to each memory channel.

- 1) Push [V/M] SWITCH.

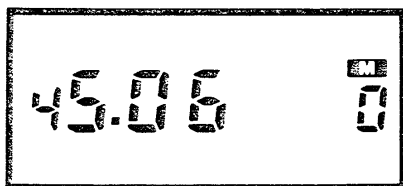

- 1) Push the [V/M] SWITCH to select MEMORY mode.

- "M" appears on the FUNCTION DISPLAY.

- 2) Select memory channel.

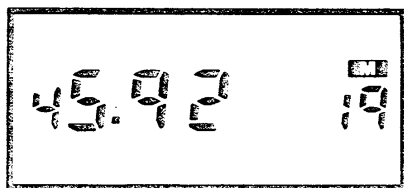

- 2) Select the required memory channel using the [100k] and [10k] SWITCHES.

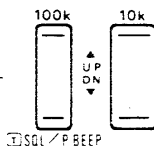

7 - 2 MEMORY WRITING

The [WR] SWITCH has a built-in safety function to prevent accidental erasure of memory contents.



Push the [WR] SWITCH until 3 beep tones are emitted from the transceiver. Now you are able to use the memory write function.

- 1) Select required memory channel.

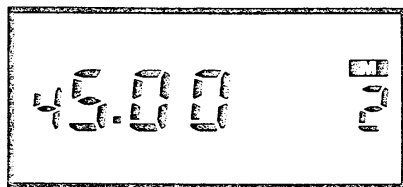

- 1) Select the required memory channel. See Section 7 - 1 MEMORY READING.

- 2) Push [V/M] SWITCH.

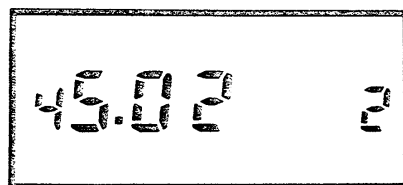

- 2) Push the [V/M] SWITCH to select VFO mode.

- "M" disappears from the FUNCTION DISPLAY.

FUNCTIONS OPERATION 7.

3) Select programming condition.

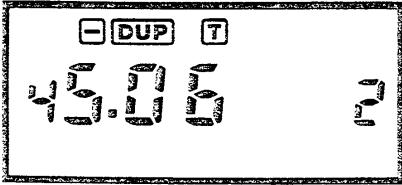

3) Select a frequency, duplex/simplex condition, offset frequency, subaudible tone frequency, etc.

4) Push and hold [WR] SWITCH.

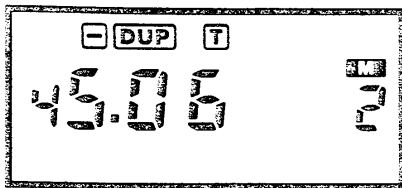

4) Push and hold the [WR] SWITCH until 3 beep tones are emitted during VFO mode.

- Displayed contents are memorized.

- Memory contents appear when the [V/M] SWITCH is pushed.

7 - 3 MEMORY TRANSFERRING

This function allows you to use a memory channel in VFO mode. For example, a nearby frequency of any programmed frequency in a memory channel can be easily searched using this function.

1) Select required memory channel.



1) Select the required memory channel. See Section 7 - 1 MEMORY READING.

2) Push and hold [WR] SWITCH.



2) Push and hold the [WR] SWITCH until 3 beep tones are emitted during MEMORY mode.

- Displayed memory contents are transferred to VFO mode and the transceiver is changed to VFO mode.

7. FUNCTIONS OPERATION

7 - 4 PROGRAMMED SCAN

Programmed scan repeatedly scans between user-programmed independent frequency edges to monitor a particular section of the band. See p. 23 for setting scan edges.

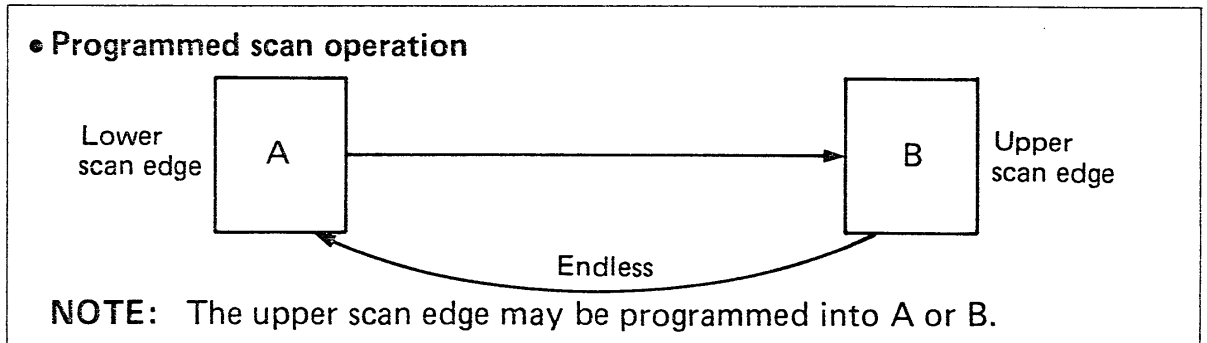

1) Select VFO mode.



1) Select VFO mode using the [V/M] SWITCH.

2) Adjust [SQL] CONTROL.

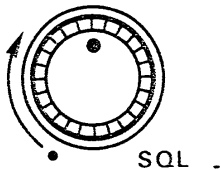

2) Adjust the [SQL] CONTROL to the squelch threshold point.

3) Push [FUNCTION] and [10k] SWITCHES.

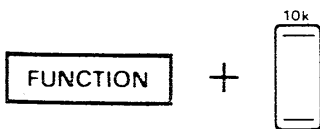

3) Push and hold the [FUNCTION] SWITCH and then push the [10k] SWITCH upwards or downwards to start programmed scan.

- The decimal point blinks while the scan is operating.

- The scan stops when the transceiver receives a signal.

- The scan then resumes after 15sec. while on a signal or after 2sec. when the signal disappears.

Downloaded by RadioAmateur.EU

4) Push any switch on the top panel.

4) Push any switch on the top panel to stop the scan.

7 - 5 MEMORY SCAN

Memory scan automatically scans all programmed memory channels except the skip channels described in Section 7 - 6 SKIP FUNCTION.

- 1) Select MEMORY mode.
- 2) Adjust [SQL] CONTROL.
- 3) Push [FUNCTION] and [10k] SWITCHES.

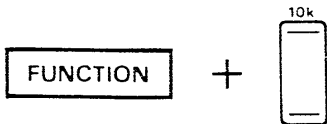

- 4) Push any switch.

- 1) Select MEMORY mode using the [V/M] SWITCH.
- 2) Adjust the [SQL] CONTROL to the squelch threshold point.

- 3) Push and hold the [FUNCTION] SWITCH and then push the [10k] SWITCH upwards or downwards to start the memory scan.

- Same status as programmed scan (i.e., decimal point and scan resumption).

- 4) Push any switch on the top panel to stop the scan.

7 - 6 SKIP FUNCTION



An unrequired memory channel can be skipped during memory scan. This section explains how to program a memory channel to be skipped during memory scan. See Section 7 - 5 MEMORY SCAN for memory scan operating procedures.

- 1) Select required memory channel.
- 2) Push [FUNCTION] and [V/M] SWITCHES.



- 1) Select your required memory channel. See Section 7 - 1 MEMORY READING.
- 2) Push and hold the [FUNCTION] SWITCH and then push the [V/M] SWITCH to alternately program and cancel the skip function.

7. FUNCTIONS OPERATION

7 - 7 POCKET BEEP AND TONE SQUELCH FUNCTIONS

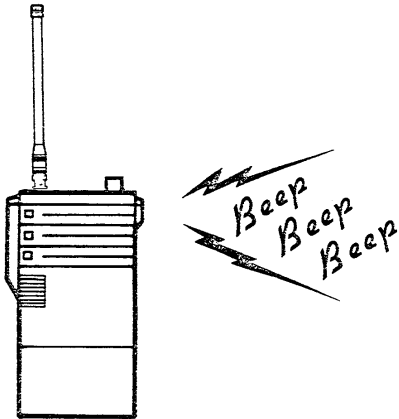

- 1) Push [FUNCTION] and [100k] SWITCHES.

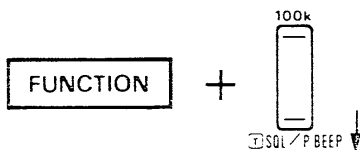

- 2) Push any switch.

These functions require an optional UT-40 TONE SQUELCH UNIT. Note that they cannot be used with the IC-2GE.

The **pocket beep** function alerts you using 30sec. beep tones and "SQL" flashing when a call is received with the same subaudible tone as programmed in your transceiver. This is very convenient for times when you are temporarily away from the transceiver.

The **tone squelch** function allows you to receive only specific stations using a subaudible tone.

- 1) Push and hold the [FUNCTION] SWITCH and then push the [100k] SWITCH downwards to sequentially turn the tone squelch and pocket beep functions ON and OFF.

- "T SQL" : Tone squelch function
- "SQL" : Pocket beep function

- 2) Push any switch on the top panel to stop beep tones. The transceiver automatically changes to the tone squelch function.

7 - 8 CALL CHANNEL OPERATION

Your highest priority channel can be easily called from a programmed call channel.

Note that the IC-2GE is not equipped with a CALL channel.

(1) CALL CHANNEL READING

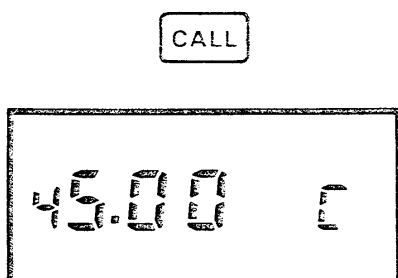

Push the [CALL] SWITCH to select or cancel the CALL channel.

- "C" appears in place of the memory channel number when the CALL channel is selected.

(2) CALL CHANNEL PROGRAMMING

1) Select VFO mode.



2) Select contents.

3) Push [CALL] SWITCH.



4) Push and hold [WR] SWITCH.



1) Select VFO mode using the [V/M] or [CALL] SWITCH.

2) Select contents such as frequency, repeater information, etc., you wish to write into the CALL channel.

3) Push the [CALL] SWITCH to select the CALL channel.

4) Push and hold the [WR] SWITCH until 3 beep tones are emitted from the transceiver.

• The desired contents are now memorized.

7 - 9 BEEP TONE FUNCTION

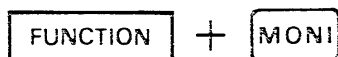

A beep tone is emitted each time a switch is pushed. If you do not require beep tones, they can be eliminated in the following way:

Push and hold the [FUNCTION] SWITCH and then push the [MONI] SWITCH to alternately turn the beep tone function ON and OFF.

• The pocket beep function is activated even if the beep tone function is turned OFF.

7 - 10 LOCK FUNCTION

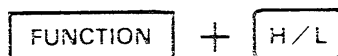

This feature prevents accidental changes of the operating frequency and VFO/MEMORY modes.

Push and hold the [FUNCTION] SWITCH and then push the [H/L] SWITCH to turn the lock function ON and OFF.

• "L" appears when the lock function is activated.

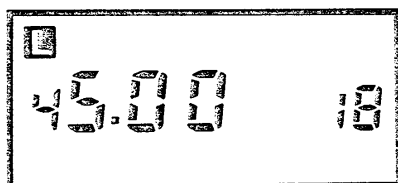

8. SET MODE

8 - 1 SET MODE CONSTRUCTION

The transceiver has a convenient SET mode for programming:

- Subaudible tone frequencies
- Offset frequencies
- Tuning steps
- Scan edges
- Power saver ON/OFF

Push and hold the [FUNCTION] SWITCH and then push the [V/M] SWITCH while in VFO mode. The transceiver begins again in the place in the cycle where it last stopped.

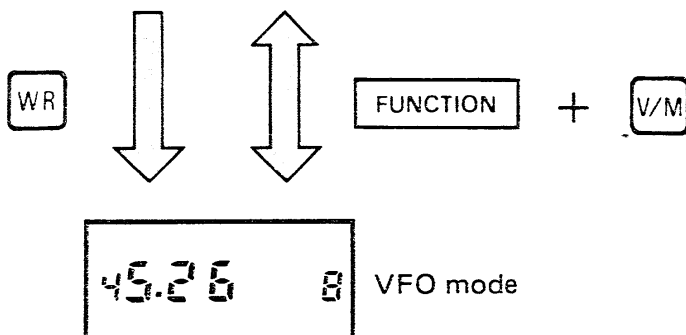
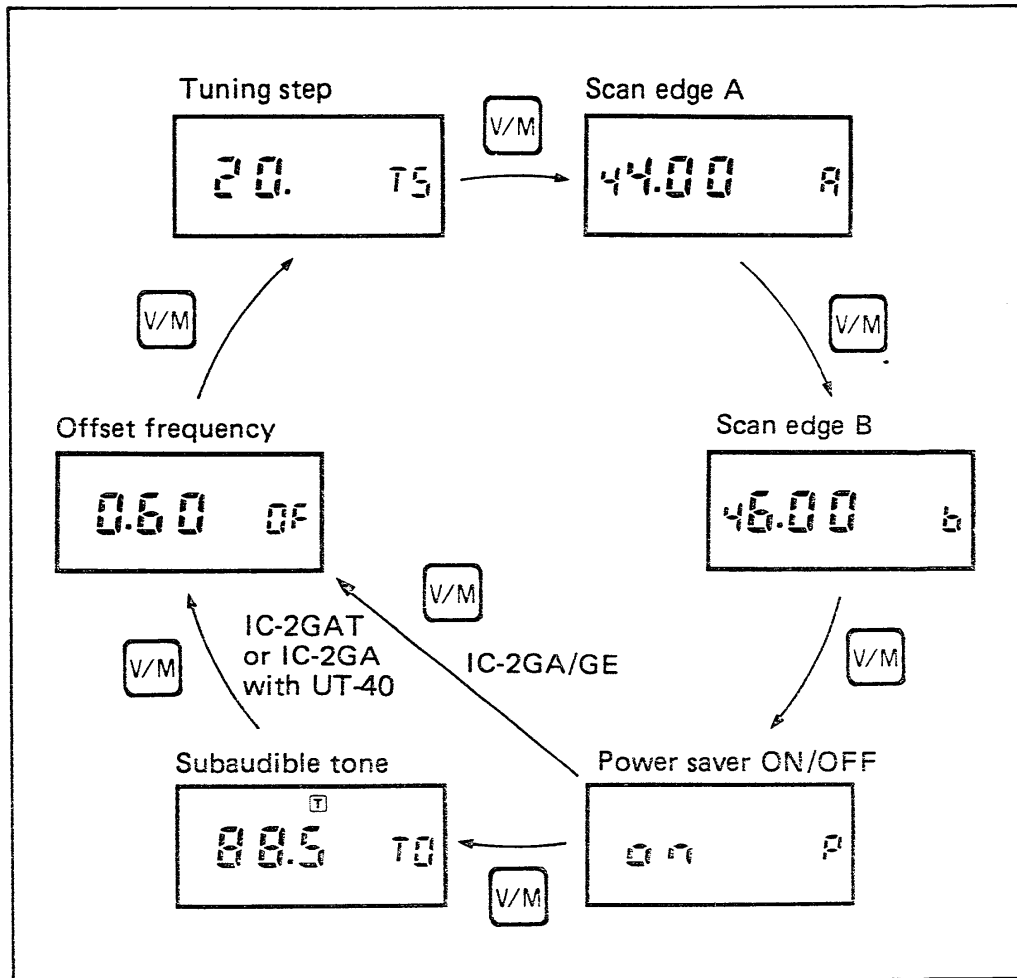

8 - 2 SETTING A SUBAUDIBLE TONE

One of 38 different subaudible tone encoder frequencies can be programmed to access a repeater or 37 different tone encoder/decoder frequencies (when an optional UT-40 TONE SQUELCH UNIT is installed).

The IC-2GE cannot have subaudible tones programmed. The IC-2GA can be programmed only if the UT-40 is installed.

- 1) Select VFO mode using the [V/M] SWITCH.
- 2) Push and hold the [FUNCTION] SWITCH and then push the [V/M] SWITCH to select SET mode.
- 3) Push the [V/M] SWITCH several times until "TO" appears in place of the memory channel number.
- 4) Push the [10k] SWITCH to select a required tone frequency.
- 5) Push the [WR] SWITCH to return to VFO mode or push the [V/M] SWITCH to program the next parameter.

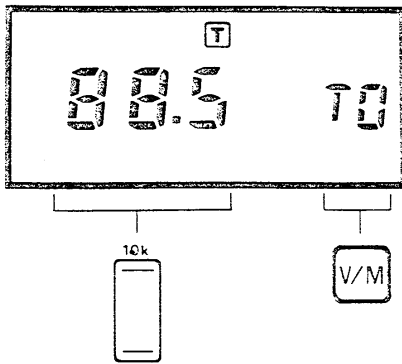

8 - 3 SETTING AN OFFSET FREQUENCY

When duplex mode is selected the transmit frequency is lower or higher than the receive frequency with this offset.

- 1) Select VFO mode using the [V/M] SWITCH.
- 2) Push and hold the [FUNCTION] SWITCH and then push the [V/M] SWITCH to select SET mode.
- 3) Push the [V/M] SWITCH several times until "OF" appears in place of the memory channel number.
- 4) Select the offset frequency using the DIGIT UP/DOWN SWITCHES.
- 5) Push the [WR] SWITCH to return to VFO mode or push the [V/M] SWITCH to program the next parameter.

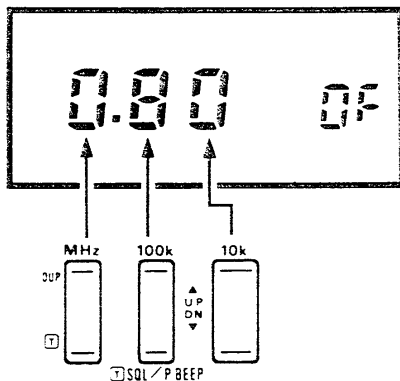

8. SET MODE

8 - 4 SETTING A TUNING STEP

When the [10k] SWITCH is pushed in VFO mode, the transceiver changes in one of following tuning steps:

IC-2GA/GAT : 5, 10, 15, 20, 25kHz

IC-2GE : 12.5, 25kHz

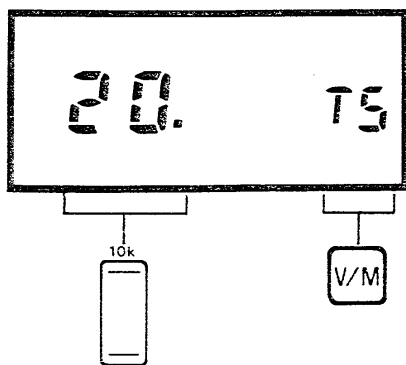

- 1) Select VFO mode using the [V/M] SWITCH.
- 2) Push and hold the [FUNCTION] SWITCH and then push the [V/M] SWITCH to select SET mode.
- 3) Push the [V/M] SWITCH several times until "TS" appears in place of the memory channel number.
- 4) Push the [10k] SWITCH to select a desired tuning step.
- 5) Push the [WR] SWITCH to return to VFO mode, or push the [V/M] SWITCH to program the next parameter.

NOTE: The above 2 types of tuning steps (minimum step 5kHz and 12.5kHz) can be changed by one of the CPU resetting methods. See p. 26 for CPU resetting.

8 - 5 SETTING SCAN EDGES

The purpose of programmed scan is to monitor a particular section of the band. Programmed scan edges, A and B are programmed in the following way:

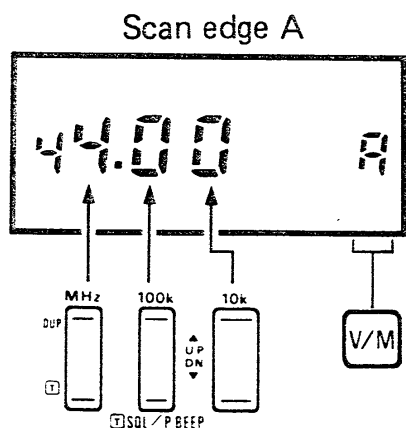

- 1) Select VFO mode using the [V/M] SWITCH.
- 2) Push and hold the [FUNCTION] SWITCH and then push the [V/M] SWITCH to select SET mode.
- 3) Push the [V/M] SWITCH several times until "A" appears in place of the memory channel number.

- 4) Select the upper or lower scan edge using the DIGIT UP/DOWN SWITCHES in the same manner as selecting an operating frequency.

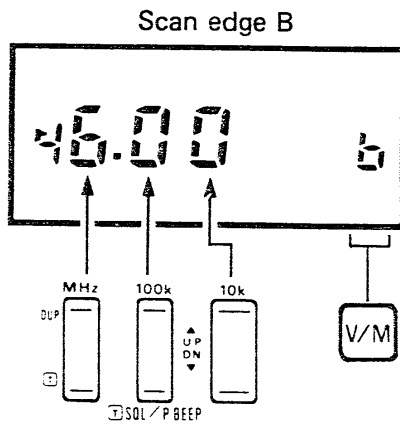

- 5) Push the [V/M] SWITCH once to select the other side of the scan edge.

- "b" appears on the FUNCTION DISPLAY.

- 6) Select the other side band edge using DIGIT UP/DOWN SWITCHES in the same manner as selecting an operating frequency.

- 7) Push the [WR] SWITCH to return to VFO mode, or push the [V/M] SWITCH to program the next parameter.

8 - 6 SETTING THE POWER SAVER

The convenient power saver can be turned ON and OFF for data communications such as packet or AMTOR.

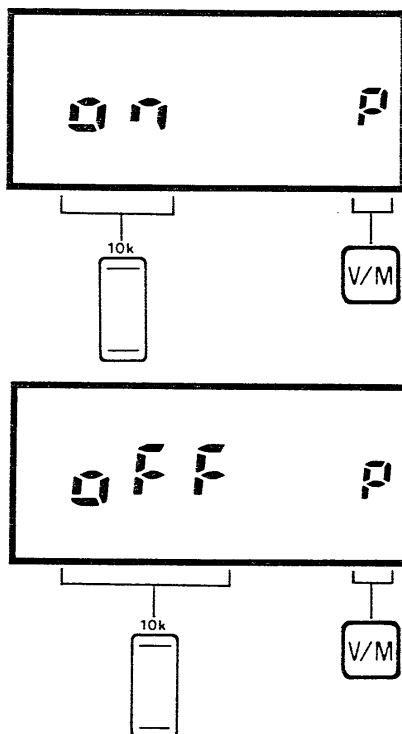

- 1) Select VFO mode using the [V/M] SWITCH.
- 2) Push and hold the [FUNCTION] SWITCH and then push the [V/M] SWITCH to select SET mode.

- 3) Push the [V/M] SWITCH several times until "P" appears in place of the memory channel number.

- 4) Push the [10k] SWITCH to turn the power saver ON and OFF.

- "on" or "oFF" appears in place of the memory channel number.

- 5) Push the [WR] SWITCH to return to VFO mode, or push the [V/M] SWITCH to program the next parameter.

9. MAINTENANCE

■ TROUBLESHOOTING

PROBLEM	SOLUTION
Power does not come ON.	<ul style="list-style-type: none">• Be sure the connection between the battery pack and transceiver is correct and the terminal is not dirty.• Be sure the battery pack is not exhausted.
No sound comes from the speaker.	<ul style="list-style-type: none">• Be sure the [SQL] CONTROL is not turned too far clockwise.• Be sure the optional UT-40 TONE SQUELCH UNIT is turned OFF.
The TRANSMIT INDICATOR does not light up during transmission.	<ul style="list-style-type: none">• Be sure the battery pack is not exhausted.
No contact possible with another station.	<ul style="list-style-type: none">• Be sure the transceiver is not set in duplex mode.• Be sure another station is not using the tone squelch function or your tone frequency is not the same as another station's.
Repeater cannot be accessed.	<ul style="list-style-type: none">• Be sure the subaudible tone frequency is correct.• Be sure the offset frequency is correct.• Be sure HIGH output power is selected with the [H/L] SWITCH.
Frequency is not set.	<ul style="list-style-type: none">• Be sure the lock function is turned OFF.• Be sure the transceiver is not in CALL CHANNEL mode.• Be sure the transceiver is not in MEMORY mode.
Scan does not operate.	<ul style="list-style-type: none">• Be sure the squelch is closed.• Be sure scan edge A frequency does not equal scan edge B frequency (for programmed scan).• Be sure all memory channels are not programmed as skip channels (for memory scan).

■ BACKUP BATTERY

The usual life of the backup battery is more than 5 years. If the backup battery is exhausted, the transceiver operates normally but frequencies cannot remain memorized when the battery pack is detached.

■ RESETTING THE CPU

NOTE: After resetting the CPU, all information you have programmed into memory channels will be erased.

When the FUNCTION DISPLAY displays erroneous information, the CPU should be reset before taking the transceiver to an Icom Service Center.

Minimum tuning steps of 5kHz or 12.5kHz can also be changed by resetting the CPU. The CPU can be reset using either of the 2 methods shown below.

(1) IC-2GA/GAT (Minimum tuning step: 5kHz)

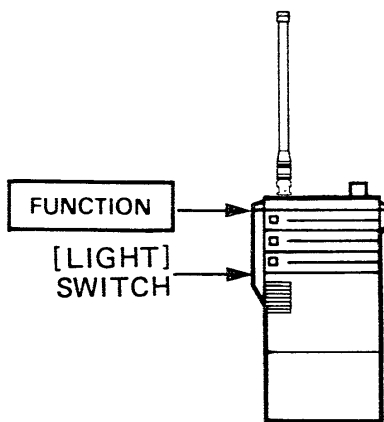

(2) IC-2GE (Minimum tuning step: 12.5kHz)

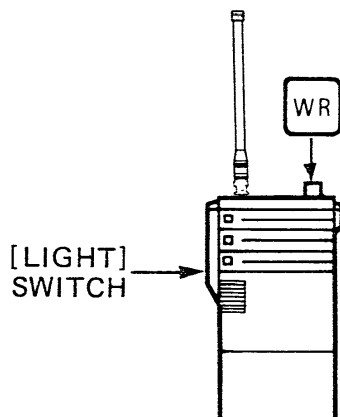

- 1) Turn the power ON.
- 2) Push and hold the [LIGHT] and [FUNCTION] SWITCHES continuously until reaching item 4), then turn power OFF.

- 3) Turn the power ON again.

- All segments on the FUNCTION DISPLAY light up.

- 4) After the FUNCTION DISPLAY returns to its normal condition, release the [LIGHT] and [FUNCTION] SWITCHES.

- 1) Turn the power ON.

- 2) Push and hold the [LIGHT] and [WR] SWITCHES continuously until reaching item 4), then turn power OFF.

- 3) Turn the power ON again.

- All segments in the FUNCTION DISPLAY light up.

- 4) After the FUNCTION DISPLAY returns to its normal condition, release the [LIGHT] and [WR] SWITCHES.

10. SPECIFICATIONS

■ GENERAL

- Frequency coverage

Downloaded by RadioAmateur.EU

MODEL	GUARANTEED RANGE		OPERATIONAL RANGE	
	TRANSCEIVER	RECEIVER	RECEIVER	TRANSMITTER
IC-2GA/GAT (U.S.A. version) IC-2GE (Italy version)	144.00 ~ 148.00	138.00 ~ 174.00	138.00 ~ 174.00	140.00 ~ 150.00
IC-2GA (Australia version)	144.00 ~ 148.00	144.00 ~ 148.00	144.00 ~ 148.00	144.00 ~ 148.00
IC-2GE (except Italy version)	144.00 ~ 146.00	144.00 ~ 146.00	144.00 ~ 146.00	144.00 ~ 146.00

Unit : MHz

- Mode
- Tuning step increment (initial)

: F3 (FM)

IC-2GA/GAT	5, 10, 15, 20 or 25kHz
IC-2GE	12.5 or 25kHz

- Memory channels

IC-2GA/GAT	20 plus a CALL channel
IC-2GE	20

- Antenna impedance
- Power supply requirement
- Current drain (at 13.2V DC)

: 50Ω unbalanced

: 5.5 ~ 16.0V DC (Negative ground)

: Receive Power saved typical 10mA
Max. audio output 250mA

: Transmit HIGH 1.8A
LOW 900mA

- Usable temperature range
- Dimensions

: -10°C ~ +60°C

IC-2GAT (U.S.A. version)	65(W) x 151(H) x 35(D)mm (with BP-70)
IC-2GA/GE	65(W) x 130(H) x 35(D)mm (with BP-3)

- Weight

IC-2GAT (U.S.A. version)	500g (with BP-70)
IC-2GA/GE	430g (with BP-3)

■ TRANSMITTER

- Output power (at 13.2V DC)
- Modulation system
- Max. frequency deviation
- Spurious emissions
- Microphone impedance

: HIGH 7W

: LOW 1W

: Variable reactance frequency modulation

: ±5kHz

: Less than -60dB

: 2kΩ

■ RECEIVER

- Receiver system
- Intermediate frequencies
- Sensitivity
- Spurious rejection
- Audio output power
- Audio output impedance

: Double-conversion superheterodyne

: 1st 16.9MHz

: 2nd 455kHz

: Less than 0.25μV for 12dB SINAD

: Less than -60dB

: More than 400mW at 10% distortion with an 8Ω load

: 8Ω

All stated specifications are approximate and subject to change without notice or obligation.

Count on us!

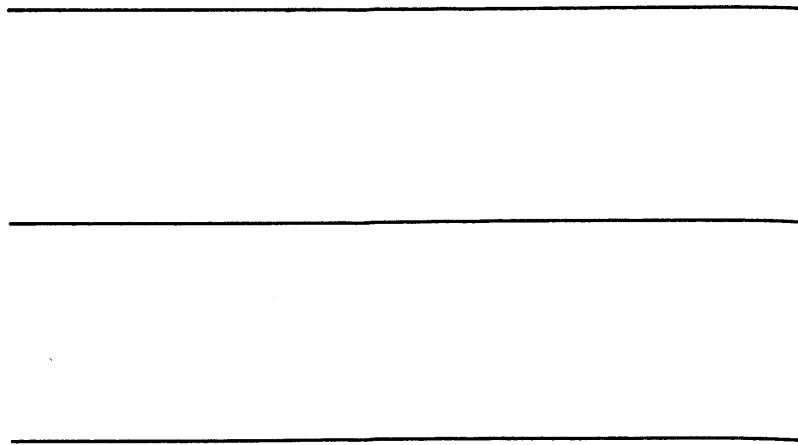
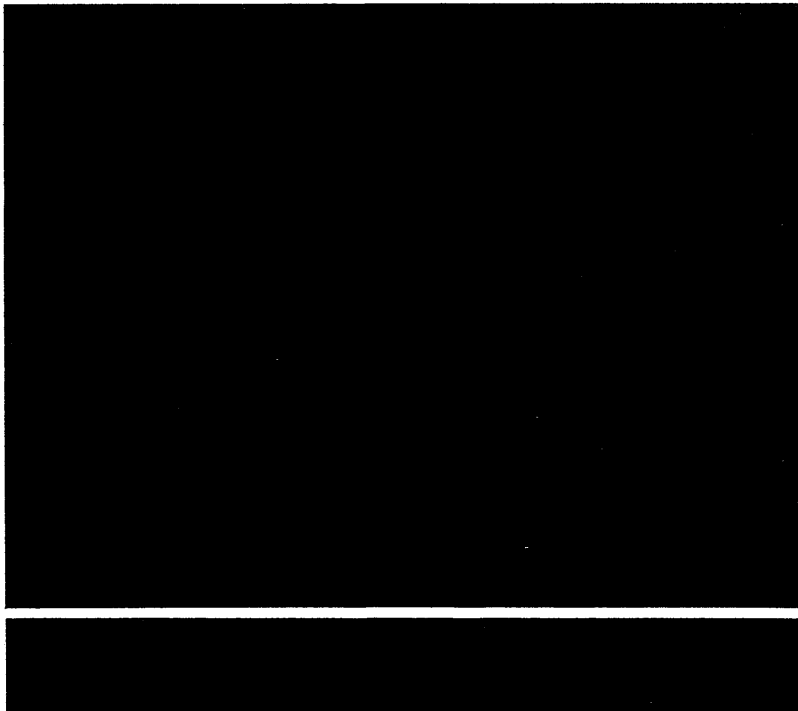

Downloaded by
RadioAmateur.EU