

AGENTE ESCLUSIVO: MARCUCCI S.p.A. Via Rivoltana 4 VIGNATE (Mi)

SERVICE MANUAL

Downloaded by



Amateur Radio Directory

DUAL BAND FM TRANSCEIVER

IC-3210A

IC-3210E

MANUAL SERVICE ICOM
0470

05900710



2 005900 710002

marcucci[®] s.p.a.

4, VIA RIVOLTANA Km. 8,5
20060 VIGNATE (MI) ITALY
PHONE (02) 9560221
TELEX 320519 MARCU-I

37, VIA BRONZETTI
20129 MILANO (ITALY)
PHONE (02) 7386051 (5 linee)
FAX (02) 9560248

TABLE OF CONTENTS

SECTION	1	SPECIFICATIONS	1-1
SECTION	2	OUTSIDE AND INSIDE VIEWS.....	2-1~2
	2-1	FREQUENCY DISPLAY	2-1
	2-2	FRONT PANEL	2-1
	2-3	REAR PANEL.....	2-1
	2-4	TOP VIEW (MAIN AND VHF PA UNITS)	2-2
	2-5	BOTTOM VIEW (RX AND UHF PA UNITS).....	2-2
SECTION	3	BLOCK DIAGRAM	3-1
SECTION	4	CIRCUIT DESCRIPTION.....	4-1~7
	4-1	RECEIVER CIRCUITS	4-1
	4-2	TRANSMITTER CIRCUITS	4-2
	4-3	VHF PLL CIRCUITS	4-3
	4-4	UHF PLL CIRCUITS	4-4
	4-5	LOGIC CIRCUITS (LOGIC UNIT)	4-4
	4-6	OTHER CIRCUITS	4-6
SECTION	5	DISASSEMBLY AND ASSEMBLY DIAGRAMS.....	5-1~3
	5-1	MECHANICAL PARTS DISASSEMBLY	5-1
	5-2	CONNECTOR ASSEMBLY.....	5-3
SECTION	6	MAINTENANCE AND ADJUSTMENT	6-1~5
	6-1	PLL ADJUSTMENT	6-1
	6-2	RECEIVER ADJUSTMENT	6-2
	6-3	TRANSMITTER ADJUSTMENT	6-4
SECTION	7	BOARD LAYOUTS	7-1~8
	7-1	LOGIC UNIT.....	7-1
	7-2	MAIN UNIT.....	7-3
	7-3	RX UNIT	7-5
	7-4	VCO UNITS	7-7
	7-5	PA UNITS.....	7-8
SECTION	8	PARTS LIST	8-1~9
SECTION	9	OPTIONAL UNITS	9-1~4
	9-1	UT-40 TONE SQUELCH UNIT CIRCUIT DESCRIPTION	9-1
	9-2	UT-40 VOLTAGE/CIRCUIT DIAGRAM.....	9-2
	9-3	UT-40 BOARD LAYOUTS	9-3
	9-4	UT-40 BLOCK DIAGRAM	9-4
	9-5	UT-40 PARTS LIST	9-4
SECTION	10	VOLTAGE DIAGRAM	10-1~2

INTRODUCTION

This service manual describes the latest service information for the IC-3210A/E DUAL BAND FM TRANSCEIVER at the time of going to press.

Three versions of the IC-3210A/E have been designed. This service manual covers following versions.

MODEL	VERSION NUMBER	AREA
IC-3210E	#02	Europe
IC-3210A	#05	U.S.A.
	#07	Australia

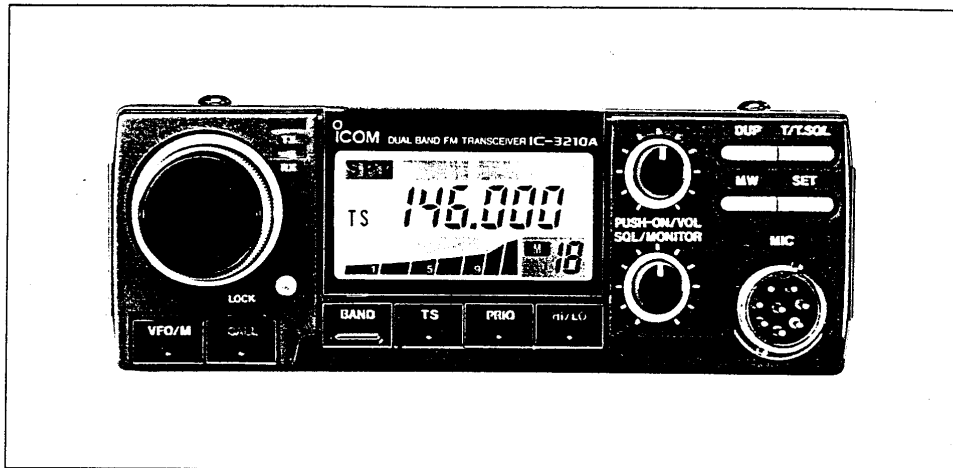

ORDERING PARTS

Be sure to include the following four points when ordering replacement parts:

1. Component part number and name
2. Equipment model name and unit name
3. 10-digit order numbers for mechanical parts
4. Quantity required

<SAMPLE ORDER>

IC PLL2001S IC-3210A MAIN UNIT 5 pieces
Screw FH M2.6×4 IC-3210A Front panel 8810002100 10 pieces

Addresses are provided on the inside back cover for your convenience.

DANGER

NEVER connect the transceiver to an AC outlet or to a DC power supply that uses more than 16 V. This will ruin the transceiver.

DO NOT expose the transceiver to rain, snow or any liquids.

DO NOT reverse the polarities of the power supply when connecting the transceiver.

DO NOT apply an RF signal of more than 20 dBm (100 mW) to the antenna connector. This could damage the transceiver's front end.

REPAIR NOTE

1. Make sure a problem is internal before disassembling the transceiver.
2. **DO NOT** open the transceiver until the transceiver is disconnected from a power source.
3. **DO NOT** force any of the variable components. Turn them slowly and smoothly.
4. **DO NOT** short any circuits or electronic parts. An insulated tuning tool **MUST** be used for all adjustments.
5. **DO NOT** keep power ON for a long time when the transceiver is defective.
6. **DO NOT** transmit power into a signal generator or a sweep generator.
7. **ALWAYS** connect a 30 dB~40 dB attenuator between the transceiver and a deviation meter or spectrum analyzer when using such test equipment.
8. **READ** the instructions of test equipment thoroughly before connecting equipment to the transceiver.

SECTION 1 SPECIFICATIONS

■ GENERAL

- Frequency coverage :

MODEL	VERSION	VHF	UHF
IC-3210A	U.S.A.	138.00 ~ 174.00 MHz* (Rx) 140.00 ~ 150.00 MHz* (Tx)	440.00 ~ 450.00 MHz
IC-3210A	Australia	144.00 ~ 148.00 MHz	430.00 ~ 440.00 MHz
IC-3210E	Europe	144.00 ~ 146.00 MHz	430.00 ~ 440.00 MHz

*Specifications apply to only 144.00 ~ 148.00 MHz.

- Mode : F3 (FM)
- Selectable tuning step : 5, 10, 15, 20 and 25 kHz (IC-3210A)
12.5 and 25 kHz (IC-3210E)
- Memory channels : 20 (double-spaced) memory channels plus two call channels
- Antenna impedance : 50 Ω
- Power supply requirement : 13.8 V DC \pm 15 % (negative ground)
- Current drain : Receive standby 550 mA
max. audio 900 mA (except full duplex operation)
Transmit high 7.6 A
low 3.6 A
- Usable temperature range : $-10^{\circ}\text{C} \sim +60^{\circ}\text{C}$ ($+14^{\circ}\text{F} \sim +140^{\circ}\text{F}$)
- Frequency stability : ± 10 ppm ($-10^{\circ}\text{C} \sim +60^{\circ}\text{C}$)
- Dimensions : 140(W) \times 50(H) \times 180(D) mm
5.5(W) \times 2.0(H) \times 7.1(D) inches
(Projections not included)
- Weight : 1.2 kg (2.6 lbs.)

■ TRANSMITTER

- Output power : 25 W (high), 5 W (low)
- Modulation system : Variable reactance frequency modulation
- Max. frequency deviation : ± 5 kHz
- Spurious emissions : Less than -60 dB
- Microphone impedance : 600 Ω

■ RECEIVER

- Receive system : Double-conversion superheterodyne
- Intermediate frequency : 1st 30.875 MHz
2nd 455 kHz
- Sensitivity : 0.18 μV for 12 dB SINAD
- Selectivity : More than 12.5 kHz/ -6 dB
Less than 30.0 kHz/ -60 dB
- Audio output power : More than 2.4 W at 10 % distortion with an 8 Ω load
- Audio output impedance : 8 Ω

All stated specifications are subject to change without notice or obligation.

Downloaded by



Amateur Radio Directory

SECTION 2 OUTSIDE AND INSIDE VIEWS

2-1 FREQUENCY DISPLAY

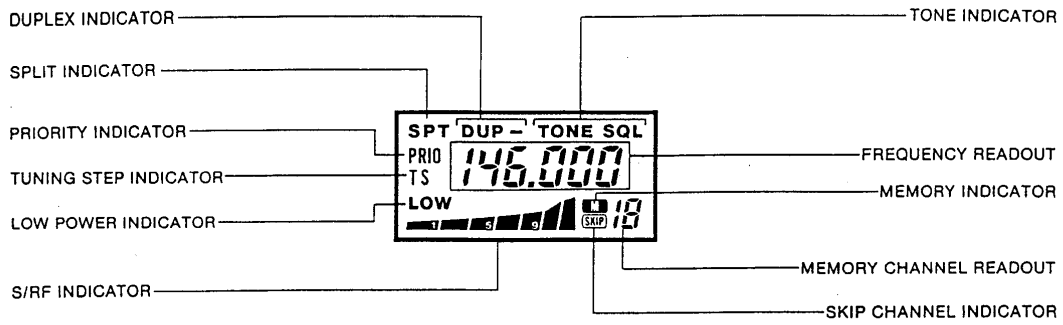

2-2 FRONT PANEL

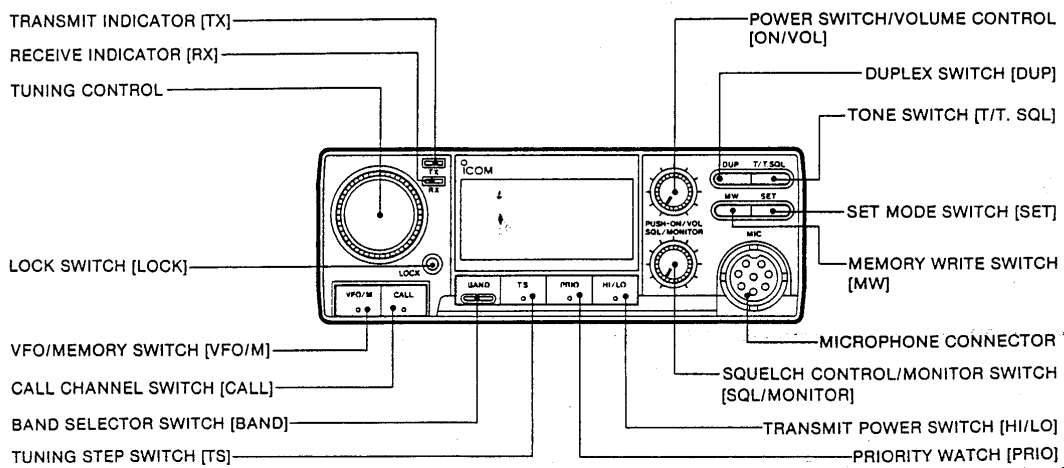

2-3 REAR PANEL

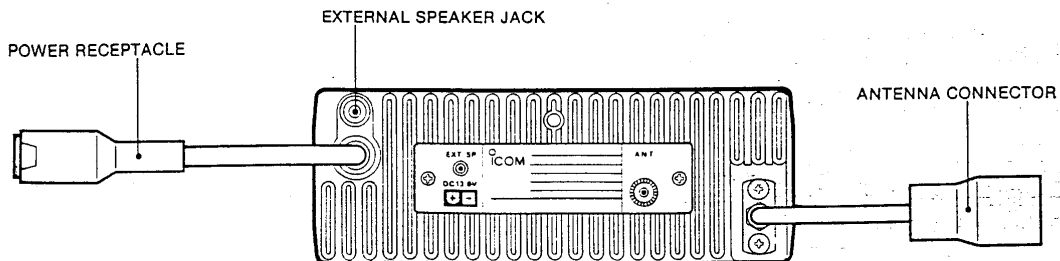

2-4 TOP VIEW (MAIN AND VHF PA UNITS)

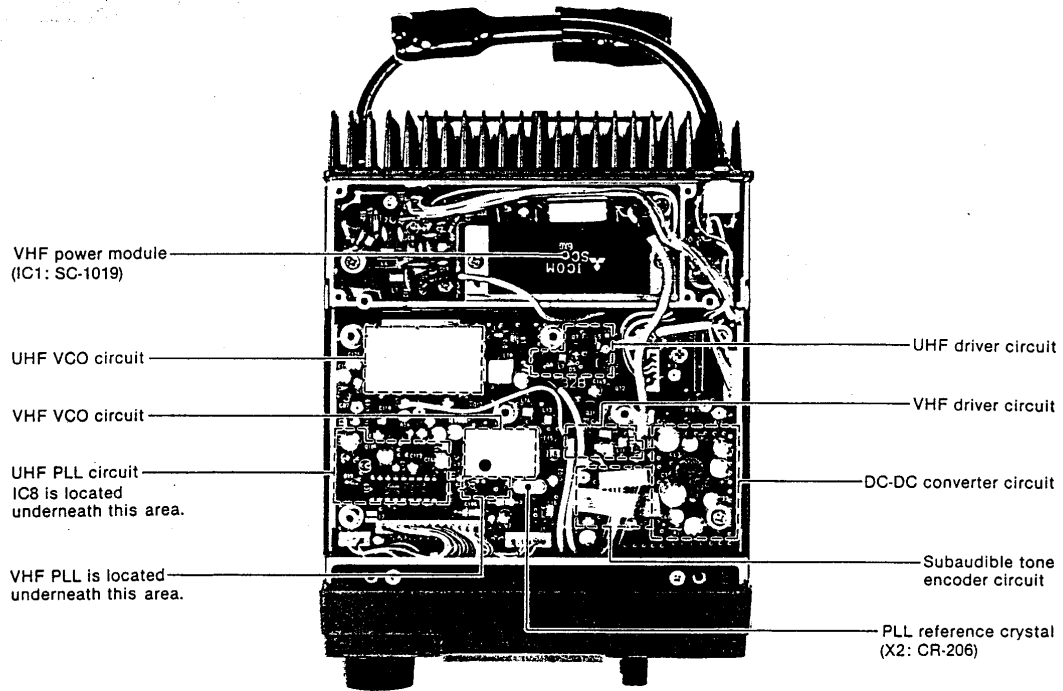

2-5 BOTTOM VIEW (RX AND UHF PA UNITS)

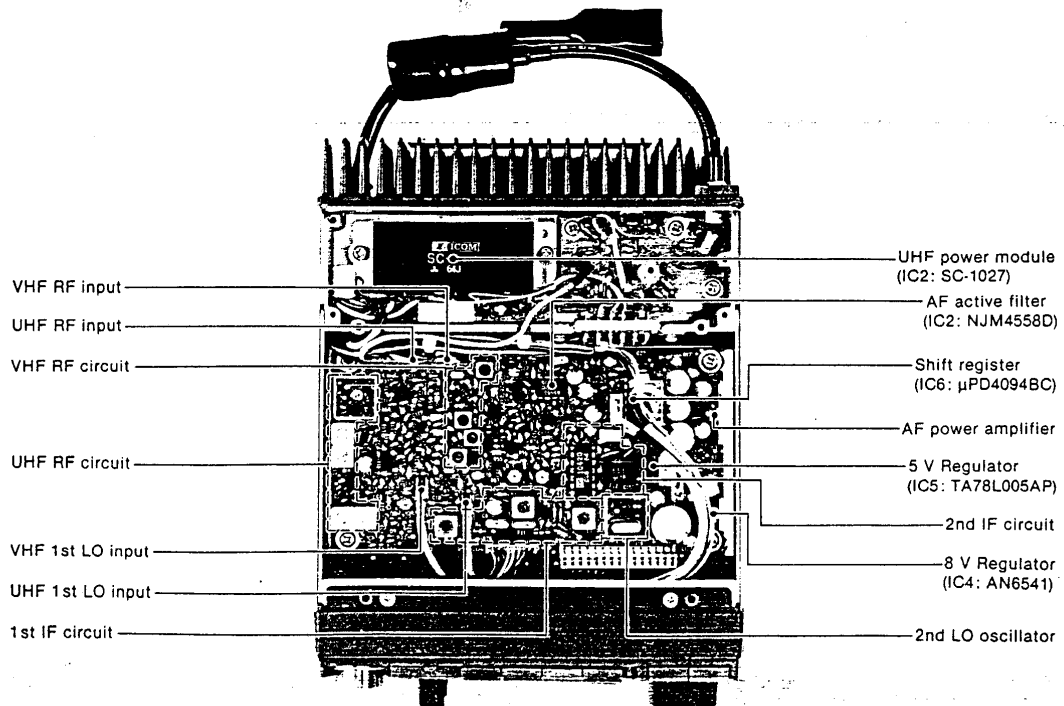

SECTION 3 BLOCK DIAGRAM

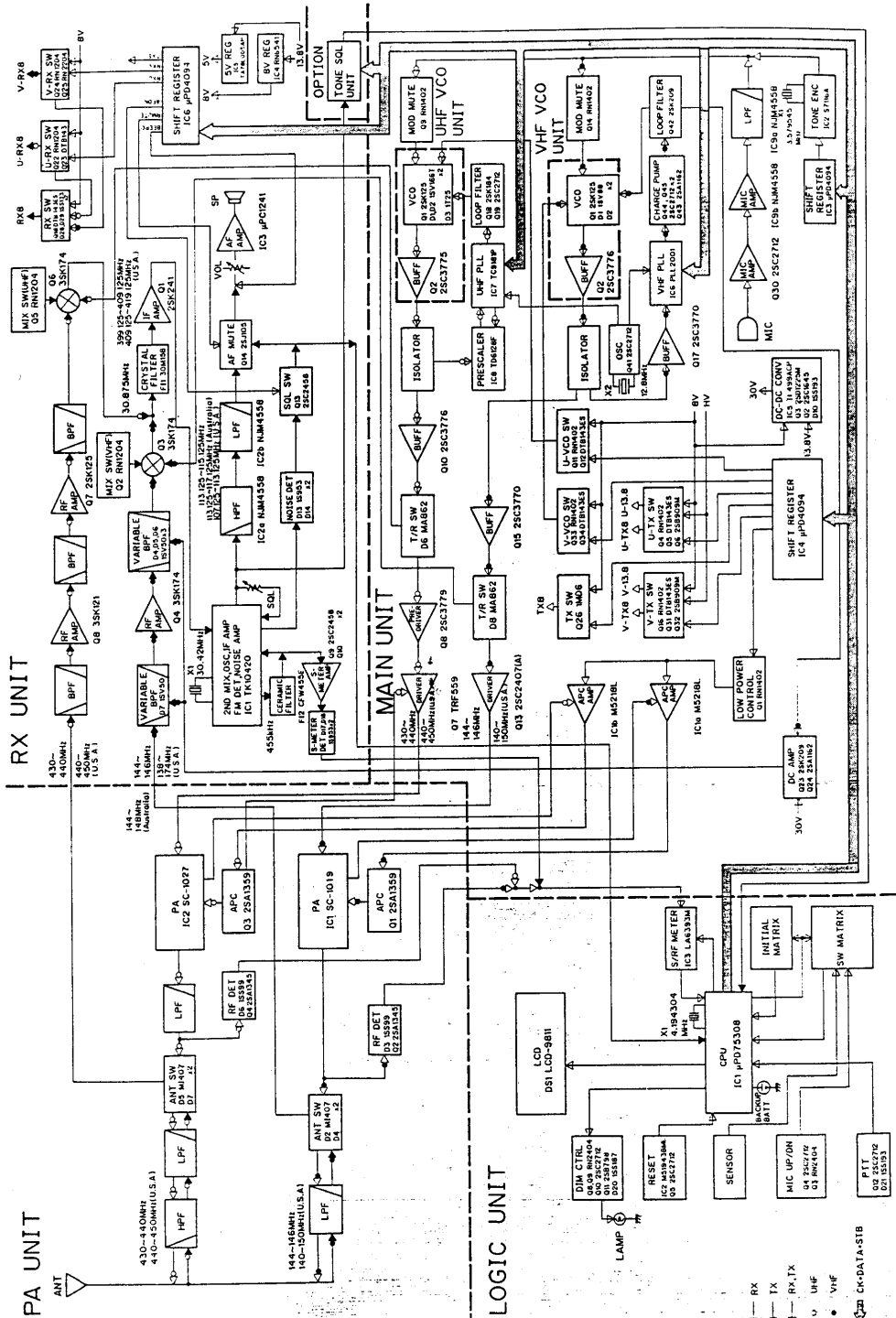

SECTION 4 CIRCUIT DESCRIPTION

4-1 RECEIVER CIRCUITS

4-1-1 VHF ANTENNA SWITCHING CIRCUIT (VHF PA UNIT)

Received VHF signals enter the antenna connector and pass through a three-stage Chebyshev low-pass filter (C12~C15, L3, L4, L6). The signals are applied to the antenna switching circuit (D2, D4), and then to the VHF RF circuit.

4-1-2 VHF RF CIRCUIT (RX UNIT)

The signals from the VHF antenna switching circuit pass through a bandpass filter (L8, C40~C43, D7), and are applied to the RF amplifier (Q4). Amplified signals are reapplied to the bandpass filter (L5~L7, C24, C26, C27, C29, C30, C32, C33, D4~D6), and are then applied to the VHF 1st mixer (Q3). The bandpass filters suppress out-of-band signals. D4~D7 are varactor diodes that track the bandpass filters and are controlled by the lock voltage of the VHF PLL. These diodes tune the center frequency of the bandpass filters for wide bandwidth reception and good image response rejection.

4-1-3 UHF ANTENNA SWITCHING CIRCUIT (UHF PA UNIT)

Received UHF signals enter the antenna connector and pass through a two-stage Chebyshev high-pass filter (C35~C37, L13, L14) and a two-stage Chebyshev low-pass filter (C32~C34, L11, L12). The signals are applied to the antenna switching circuit (D5, D7), and then to the UHF RF circuit.

4-1-4 UHF RF CIRCUIT (RX UNIT)

The signals from the UHF antenna switching circuit pass through a tuning circuit (L15, C67, C70), and are applied to the RF amplifier (Q8). Amplified signals are applied to the bandpass filter (L13), amplified at Q7, applied to the bandpass filter (L11), and are then applied to the UHF 1st mixer (Q6). The bandpass filters consisting of helical coils suppress out-of-band signals.

4-1-5 1ST MIXER CIRCUIT (RX UNIT)

When VHF receiving, a mixer switch (Q2) is turned ON, activating the VHF 1st mixer (Q3). The signals from the VHF RF circuit are mixed with the "V.LO" signal from the MAIN UNIT to produce a 30.875 MHz 1st IF signal. At the same time, the mixer switch (Q5) is turned OFF to prevent interference from the UHF RF circuit.

When UHF receiving, Q5 is turned ON, activating the UHF 1st mixer (Q6). The signals from the UHF RF circuit are mixed with the "U.LO" signal from the MAIN UNIT to produce a 30.875 MHz 1st IF signal. At the same time, Q2 is turned OFF to prevent interference from the VHF RF circuit.

4-1-6 1ST IF CIRCUIT (RX UNIT)

After passing through the matching circuit (L3, C11), the 1st IF signal is applied to a pair of crystal filter (F1) to suppress out-of-band signals. The 1st IF signal is matched at L2 and C4, amplified at Q1 and then applied to the 2nd mixer circuit. D1 and D2 function as the limiter circuit when a strong signal is received.

4-1-7 2ND IF AND DEMODULATOR CIRCUITS (RX UNIT)

The 1st IF signal amplified at Q1 is applied to the 2nd mixer section of IC1, and is mixed with the 2nd LO signal to be converted to a 455 kHz 2nd IF signal. IC1 contains the 2nd mixer, local oscillator, limiter amplifier and quadrature detector circuits. The local oscillator section and X1 generate 30.42 MHz for the 2nd LO signal.

The 2nd IF signal from the 2nd mixer (IC1, pin 3) passes through the ceramic filter, F12, where unwanted signals are suppressed. It is then amplified at the limiter amplifier section (IC1, pin 5) and applied to the quadrature detector section (IC1, pin 8 and ceramic discriminator X2) to demodulate the 2nd IF signal into an AF signal.

AF signal output from pin 9 of IC1 is applied to the AF circuit and squelch circuit.

IF CIRCUIT

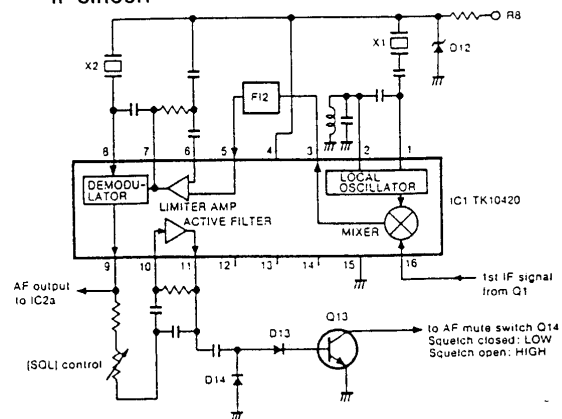

Fig. 1

4-1-8 AF CIRCUIT (RX UNIT)

The AF signal from IC1 is applied to a two-stage active filter consisting of IC2a and IC2b. The filter functions as a de-emphasis circuit with frequency characteristics of -6 dB/octave as well as a high-pass filter to suppress tone signals for the tone squelch operation.

The filtered signal passes through the AF mute circuit (Q14) and the volume control (R6). When the squelch is closed, Q14 is activated as the AF mute switch. The AF signal is power-amplified at the AF amplifier (IC3) and then applied to the speaker.

4-1-9 SQUELCH CIRCUIT (RX UNIT)

Some of the noise components in the AF signal from IC1 is applied to pin 10 of IC1 via the squelch control (R7). The squelch control adjusts the noise level.

The active filter section in IC1 amplifies noise components of frequencies of 20 kHz and above, and outputs the resulting signals from pin 11. Output signals are rectified by D13 and D14.

The rectified voltage triggers the squelch switch (Q13). The collector of Q13 outputs the squelch signal. The signal activates the AF mute circuit and turns Q17 ON to cut the AF signal from the volume control. The squelch signal is applied to Q13 on the LOGIC UNIT, turning OFF the [RX] indicator.

4-1-10 RECEIVER CONTROL CIRCUIT (RX UNIT)

IC6 forms an output expander to convert serial data from the CPU into receiver control signals. IC6 outputs control signals for the VHF and UHF receiver circuits. IC6 also outputs a beep tone and AF mute signals.

VHF TRANSMITTER CIRCUIT

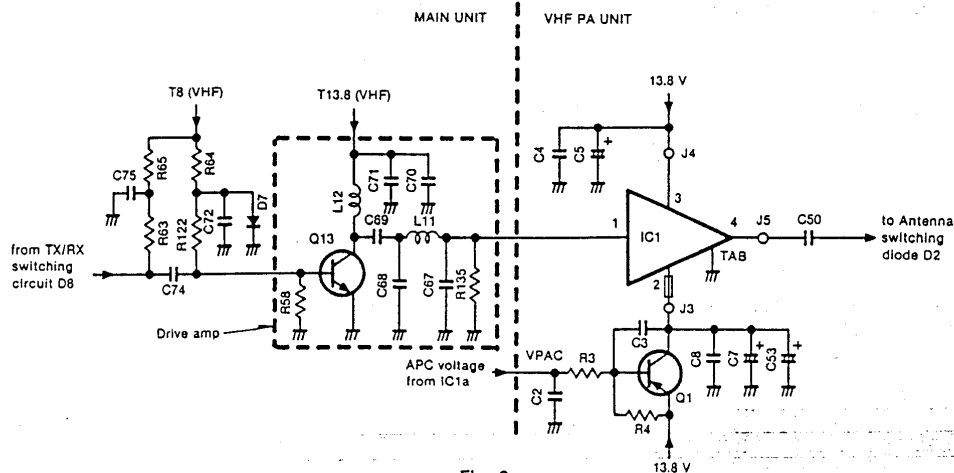

Fig. 2

4-2 TRANSMITTER CIRCUITS

4-2-1 MICROPHONE AMPLIFIER (MAIN UNIT)

AF signals from the microphone amplified at Q30 are applied to IC9b pin 5, and are pre-emphasized to 6 dB/octave through C120 and R113 connected to pin 6. IC9b functions as the microphone amplifier and the limiter.

The signals and a tone signal pass through the splatter filter circuit (IC9a) where signals of 3 kHz and above are attenuated. IC9 pin 1 then outputs the signals. The signals are applied to the VCO circuits to produce an FM signal.

4-2-2 VHF DRIVE AMPLIFIER (MAIN UNIT)

The VHF VCO output is buffer-amplified at Q15, and applied to the transmit/receive switching circuit (D8).

After passing through the transmit/receive switching circuit (D8), the VCO output is amplified at the drive amplifier (Q13) where 200 mW is obtained.

4-2-3 VHF RF POWER AMPLIFIER (VHF PA UNIT)

IC1 is a power module which provides a stable 25 W output power.

An RF signal from the drive amplifier (Q13) is applied to pin 1 of IC1. The amplified signal is output from pin 4, and applied to the antenna connector through the diode switching and low-pass filter circuits.

Downloaded by
Amateur Radio Directory

4-2-4 UHF DRIVE AMPLIFIER (MAIN UNIT)

The UHF VCO output is buffer-amplified at Q10, and applied to the transmit/receive switching circuit (D6).

After passing through the transmit/receive switching circuit (D6), the VCO output is amplified at the pre-driver (Q8) and the drive amplifier (Q7). Q7 is controlled by a collector current from Q3 on the UHF PA UNIT.

4-2-5 UHF RF POWER AMPLIFIER (UHF PA UNIT)

IC2 is a power module which provides a stable 25 W output power.

An RF signal from the drive amplifier (Q7) is applied to pin 1 of IC2. The amplified signal is output from pin 5, and applied to the antenna connector through the low-pass filter, diode switching, low-pass filter and high-pass filter circuits.

4-2-6 APC CIRCUIT (PA UNITS AND MAIN UNIT)

To obtain a stable RF output power, the APC circuit detects a current of the power module's final stage and controls a voltage of the power module's first stage and UHF drive amplifier.

The "VPAV" and "UPAV" voltages, generated in the VHF and UHF PA UNITS, are applied to the APC differential amplifiers IC1a and IC1b on the MAIN UNIT respectively.

The output voltages are applied to Q1 (VHF PA UNIT) or Q3 (UHF PA UNIT) to control the RF output power.

4-2-7 POWER OUTPUT CONTROL CIRCUIT (MAIN UNIT)

The power output control circuit consists of R9~R14 and Q1. This circuit selects the RF output power by changing the output voltage of the APC circuit.

When HIGH output power is selected, Q1 is turned OFF. RF output power is adjusted with R16 (VHF) or R7 (UHF). R7 and R16 set the APC reference voltage of the APC amplifiers.

When LOW output power is selected, Q1 is turned ON. R9~R14 are connected to the output of the APC amplifiers, reducing the output voltage. RF output power is adjusted with R12 (VHF) or R10 (UHF).

4-2-8 ANTENNA SWITCHING CIRCUIT (RF UNIT)

When VHF transmitting, D2 and D4 are turned ON. The RF output signal from IC1 is not applied to the receiver circuit, passing through C50 and D2, the low-pass filter (C12~C15, L3, L4, L6) and then on to the antenna. The low-pass filter suppresses high harmonic components.

When UHF transmitting, D5 and D7 are turned ON. The RF output signal from IC2 is not applied to the receiver circuit, passing through the low-pass filter (L9, C25, C26), D5, the low-pass filter (C32~C34, L11, L12), the high-pass filter (C35~C37, L13, L14) and then on to the antenna. The low-pass filters suppress high harmonic components.

4-2-9 TRANSMITTER CONTROL CIRCUIT (MAIN UNIT)

IC4 forms an output expander to convert serial data from the CPU into transmitter control signals. IC4 outputs control signals for the VHF and UHF transmitter circuits. IC4 also outputs a low power selection and VCO control signals.

4-3 VHF PLL CIRCUITS

4-3-1 GENERAL

The VHF PLL circuit, using a direct programmable divider (IC6), directly generates the desired frequency with the VCO circuit. IC6 sets the dividing ratio based on serial data from the CPU, and compares the phases of the VCO signal and the reference oscillator frequency. It detects the out-of-step phase and outputs it.

PLL CIRCUIT BLOCK DIAGRAM

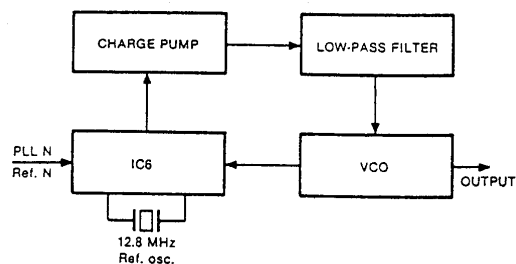

Fig. 3

4-3-2 REFERENCE OSCILLATOR CIRCUIT (MAIN UNIT)

A reference frequency is produced by Q41 and X2. The frequency is adjusted with C102. The reference frequency is applied to both the VHF and UHF PLL circuit.

4-3-3 CHARGE PUMP AND LOOP FILTER CIRCUITS (MAIN UNIT)

Phase-detected signals from pins 5 and 12 are converted to DC voltage by the charge pump Q43~Q45; and the loop filter consisting of R144, R145, R157 and C197. Q42 provides rapid PLL lock-up time when the PLL is unlocked.

The frequency at which the VHF VCO oscillates is controlled by varactor diodes (D1, D2). DC voltage (VHF PLL lock voltage) is provided through the loop filter.

The output of the loop filter is applied to the DC amplifier (Q23, Q24), and is used as voltage to control the bandpass filter (D4~D7) of the VHF receiver RF circuit.

4-3-4 VHF VCO CIRCUIT

The VHF VCO circuit forms a Hartley oscillator circuit (Q1). Varactor diodes (D1, D2) provide frequency control. The buffer amplifier (Q2) is unaffected by VCO oscillation.

4-4 UHF PLL CIRCUITS

4-4-1 GENERAL

The UHF PLL circuit, using a dual modulus prescaler (IC7, IC8), directly generates the desired frequency with the VCO circuit. The dual modulus prescaler (IC7, IC8) sets the dividing ratio based on serial data from the CPU, and compares the phases of the VCO signal and the reference oscillator frequency. It detects the out-of-step phase and outputs it. The reference frequency oscillated at X2 is applied to the PLL IC (IC7 pin 2).

4-4-2 LOOP FILTER CIRCUIT (MAIN UNIT)

Phase-detected signals from pins 16 and 17 are converted to DC voltage by the active low-pass filter (loop filter: Q18, Q19).

The frequency at which the UHF VCO oscillates is controlled by varactor diodes (D1, D2). DC voltage (UHF PLL lock voltage) is provided through the loop filter.

4-4-3 UHF VCO CIRCUIT

The UHF VCO circuit forms a transformed Colpitts oscillator circuit (Q1). Strip lines are used for stable oscillation over a wide frequency range. Varactor diodes (D1, D2) provide frequency control. The buffer amplifier (Q2) is unaffected by VCO oscillation.

UHF VCO CIRCUIT

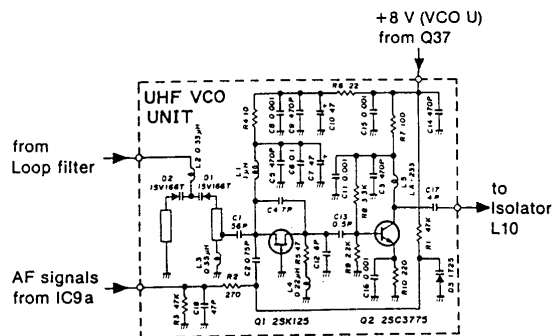

Fig. 4

4-5 LOGIC CIRCUITS (LOGIC UNIT)

4-5-1 RESET CIRCUIT

The CPU (IC1) is reset when the RESET port changes from "HIGH" to "LOW" and then becomes "LOW" again. The RESET port remains "HIGH" except when the CPU is reset.

The following is a diagram for the reset circuit and timing chart.

RESET CIRCUIT

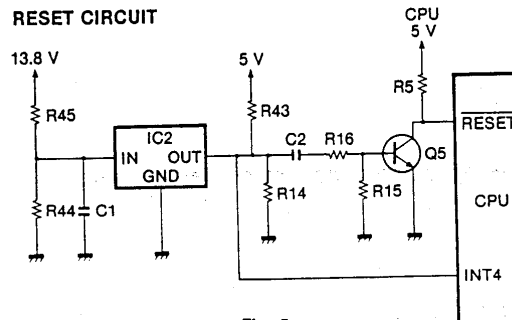

Fig. 5

RESET TIMING CHART

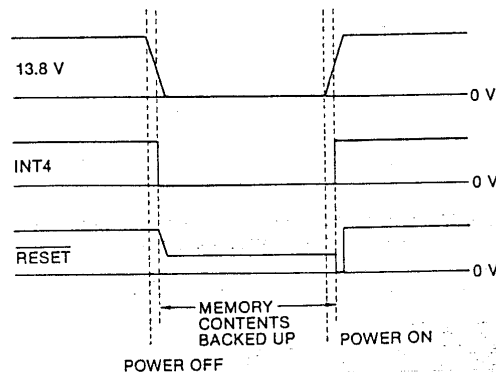

Fig. 6

P
R
O
C
E
D
U
R
E
S

4-5-2 CPU PORT ALLOCATIONS

PORT NUMBER	PIN NUMBER	DESCRIPTION
RESET	68	When a "HIGH" signal is applied here the CPU is initialized or changes to standby mode.
P00 [INT4]	38	Detects a signal for the standby mode of the CPU. The CPU enters the standby mode when the port reads a trailing edge of the signal.
P01 [SCK]	39	Outputs clock signals.
P02 [DATA]	40	Outputs serial data synchronized with the SCK signal.
P03 [SQLS]	41	Detects a squelch signal. When the signal is "HIGH," the squelch opens.
P10~P13 [KIR0~KIR3]	42~45	Input ports for the initial matrix.
P20 [STBTX]	46	Outputs a strobe signal for serial data to the output expander (transmitter control).
P21 [STBRX]	47	Outputs a strobe signal for serial data to the output expander (receiver control).
P22 [STBPLV]	48	Outputs a strobe signal for serial data to the VHF PLL IC.
P23 [STBPLU]	49	Outputs a strobe signal for serial data to the UHF PLL IC.
P30 [UNLKV]	50	Detects a VHF PLL unlock signal. When the signal is "HIGH," the VHF PLL is unlocked. Normally the port is "LOW."
P31 [UNLKU]	51	Detects a UHF PLL unlock signal.
P32 [TXLED]	52	Outputs a signal for turning the [TX] indicator ON and OFF. The port becomes "LOW" and "HIGH" when transmitting and receiving (squelch opens) respectively.
P33 [SRFO]	53	Outputs a reference voltage for the S/R/F indicator.
P40~P43 [KR0~KR3]	29~32	These are input ports for the key matrix.
P50~P53 [KS0~KS3]	34~37	These are output ports for strobe signals for the initial and key matrix.
P60 [SRFI]	60	Inputs a resulting signal from S/R/F indicator circuit.
P61 [PTT]	61	Inputs a signal on the PTT line. The port should be "HIGH" when the PTT switch is pushed.
P62 [TSQ]	62	Input port for an acknowledge signal in the optional tone squelch unit. The port is "HIGH" when the tone squelch opens.
P63 [OPT]	63	Input port whether the optional tone squelch unit is installed or not. The port is "LOW" when the tone squelch unit is installed.
P70 [STBOP]	64	Outputs a strobe signal for serial data to the optional tone squelch unit.
P71 [STBCT]	65	Outputs a strobe signal for serial data to the output expander for subaudible tone IC (S7116A).
P72, P73 [DIM01, DIM02]	66, 67	Outputs a signal for controlling intensity of the function display. Refer to Table 2.

Table 1

4-5-3 KEY MATRIX

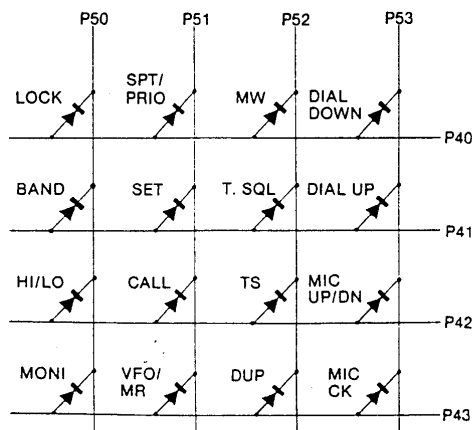

Fig. 7

4-5-4 S/RF INDICATOR CIRCUIT

IC3 functions as a comparator. IC1 pin 53 outputs a "HIGH" signal as a reference voltage to a detected S/RF signal level.

• Relative signal strength indicator

When receiving, the 455 kHz 2nd IF signal, amplified at Q9 and Q10 on the RX UNIT, is rectified at D17 and D18 to be converted to DC voltage as an "SRF" signal.

The signal is applied to IC3 pin 2 on the LOGIC UNIT. IC3 pin 1 outputs a "HIGH" signal when the voltage at pin 3 becomes the same as or higher than the SRF voltage at pin 2. It takes time to output "HIGH" from IC3 pin 1 after IC1 pin 53 outputs "HIGH." The time depends on the level of the SRF voltage. The higher the level of SRF voltage, the longer time it takes. IC1 measures the time and the S/RF indicator displays the relative signal strength.

S/RF INDICATOR CIRCUIT

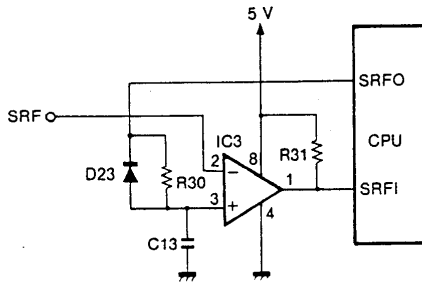

Fig. 8

• RF output power selection indicator

Q2 and D3 on the VHF PA UNIT detects VHF RF output power. Q2 outputs a "HIGH" signal whether high or low output power is transmitted. Q4 on the UHF PA UNIT also outputs a "HIGH" signal during UHF transmitting. The signal from Q2 or Q4 is applied to IC3 pin 2 on the LOGIC UNIT. IC3 pin 1 outputs a "HIGH" signal to the CPU. The CPU detects either high or low output power with the key matrix of P42 and P50.

4-5-5 DIMMER CIRCUIT

The function display changes its brightness at 4 levels using combinations of output level at P72 and P73. By changing levels at P72 and P73, the base voltage and collector current changes. Therefore, the collector voltage is changed and brightness of lamps DS2~DS4 changes.

DIMMER CIRCUIT

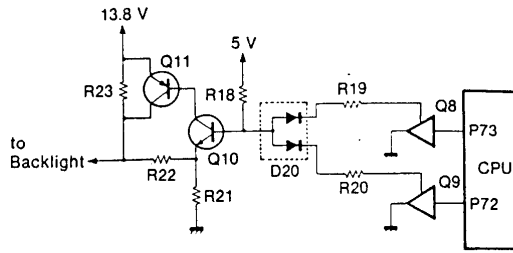

Fig. 9

BRIGHTNESS	P72	P73	INDICATION
Brightness ↑ Dark ↓	H	H	d-4
	L	H	d-3
	H	L	d-2
	L	L	d-1

Table 2

4-6 OTHER CIRCUITS

4-6-1 REGULATOR CIRCUITS (RX UNIT)

IC4 is a 3-terminal voltage regulator IC chip. +13.8 V is applied to pin 1 and pin 3 outputs +9 V. The regulated voltage is applied to each unit.

IC5 is a 3-terminal voltage regulator IC chip. +13.8 V is applied to an input terminal and the output terminal outputs +5.5 V using D30.

4-6-2 DC-DC CONVERTER (MAIN UNIT)

A DC-DC converter consisting of IC5 and Q2 creates approximately 30 V DC from 9 V DC to obtain wide range lock voltages for the PLL circuits and a power source for the DC amplifier consisting of Q23 and Q24. This DC amplifier amplifies the control voltage for the varactor diodes (D4~D7) of the bandpass filter located in the VHF RF circuit. The noise components of the output of IC5 are removed by Q2.

4-6-3 CPU POWER SUPPLY CIRCUIT (LOGIC UNIT)

When the power switch is turned OFF, a voltage is applied to the CPU (IC1) pin 54 via D22 from the lithium backup battery installed in the transceiver to provide backup for the memory contents.

CPU POWER SUPPLY CIRCUIT

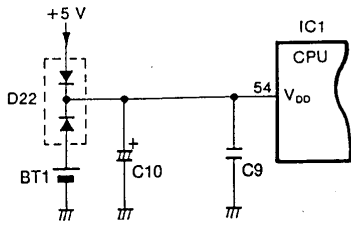

Fig. 10

4-6-4 SUBAUDIBLE TONE ENCODER CIRCUIT (MAIN UNIT)

IC3 forms an output expander to convert serial data from the CPU into tone encoder input data.

IC2 is an IC chip for generating subaudible tone frequency signals from 67 Hz~250.3 Hz. The following table shows the relation between input data and the output frequency of IC2.

SUBAUDIBLE TONE ENCODER FREQUENCY TABLE (IC-3210A: U.S.A., AUSTRALIA VERSIONS)

OUTPUT FREQUENCY [Hz]	IC2 INPUT PIN NUMBER						OUTPUT FREQUENCY [Hz]	IC2 INPUT PIN NUMBER						OUTPUT FREQUENCY [Hz]	IC2 INPUT PIN NUMBER					
	8	9	10	11	12	13		8	9	10	11	12	13		8	9	10	11	12	13
67.0	H	L	L	L	L	L	107.2	L	H	H	H	L	L	167.9	H	H	L	H	H	L
71.9	L	H	L	L	L	L	110.9	H	H	H	H	L	L	173.8	L	L	H	H	H	L
74.4	H	H	L	L	L	L	114.8	L	L	L	L	H	L	179.9	H	L	H	H	H	L
77.0	L	L	H	L	L	L	118.8	H	L	L	L	H	L	186.2	L	H	H	H	H	L
79.7	H	L	H	L	L	L	123.0	L	H	L	L	H	L	192.8	H	H	H	H	H	L
82.5	L	H	H	L	L	L	127.3	H	H	L	L	H	L	203.5	L	L	L	L	L	H
85.4	H	H	H	L	L	L	131.8	L	L	H	L	H	L	210.7	H	L	L	L	L	H
88.5	L	L	L	H	L	L	136.5	H	L	H	L	H	L	218.1	L	H	L	L	L	H
91.5	H	L	L	H	L	L	141.3	L	H	H	L	H	L	225.7	H	H	L	L	L	H
94.8	L	H	L	H	L	L	146.2	H	H	H	L	H	L	233.6	L	L	H	L	L	H
97.4	H	H	L	H	L	L	151.4	L	L	L	H	H	L	241.8	H	L	H	L	L	H
100.0	L	L	H	H	L	L	156.7	H	L	L	H	H	L	250.3	L	H	H	L	L	H
103.5	H	L	H	H	L	L	162.2	L	H	L	H	H	L							

H: HIGH L: LOW

Table 3

Downloaded by

 Amateur Radio Directory

SECTION 5 DISASSEMBLY AND ASSEMBLY DIAGRAMS

5-1 MECHANICAL PARTS DISASSEMBLY

LABELLED NUMBER	DESCRIPTION	ORDER NUMBER	QTY.
①	543 Top Cover	8110002040	1
②	ICOM Screw (B) 5	8810003710	4
③	PH B0 2 × 4	8810000980	3
④	543 Lock Plate	8930012730	1
⑤	K-113 Button	8610004330	1
⑥	FH M2.6 × 4	8810002100	4
⑦	Front Panel-1 (IC-3210A)	8210003810	1
	Front Panel-1 (IC3210E)	8210003820	1
⑧	K-114 Button (VFO/M)	8610004340	1
⑨	K-114 Button (A) [CALL]	8610004350	1
⑩	N-130 Tuning Control Knob	8610004400	1
⑪	K-115 Button (BAND)	8610004390	1
⑫	K-114 Button (B) [TS]	8610004360	1
⑬	K-114 Button (D) [PRIO]	8610004380	1
⑭	K-114 Button (C) [HI/LO]	8610004370	1
⑮	N-131 Control Knob	8610004410	2
⑯	Included with ⑭ below	—	—
⑰	K-112 Button	8610004320	4
⑱	Push Spring (H)	8930006450	4
⑲	543 Switch Plate	8930012720	1
⑳	Sub-Chassis	8010007250	1
㉑	Tuning Control SRBM1L038A	2260000880	1
㉒	PH B1 2 × 5	8810001240	4
㉓	LED Spacer	8930012790	1
㉔	543 LOGIC Grounding Plate	8930012940	1
㉕	543 LCD Reflector	8930012691	1
㉖	VR Nut (E)	8830000550	3
㉗	LCD Contact Strip SRCN543	8930012660	1
㉘	543 LCD Filter	8930012670	1
㉙	LCD 9811J	5030000330	1
㉚	543 LCD Holder-1	8930012681	1
㉛	671 LCD Rubber	8930013180	1
㉜	ICOM Screw (C) 9	8810003750	4
㉝	Mic Connector Assembly 8S-S-E	6510000290	1
㉞	543 Mic Spacer	8930012430	1
㉟	SQUELCH CONTROL RK0971114005A	7210001490	1
㊱	VOLUME CONTROL RK097111200BA	7210001480	1
㊲	57 Speaker Holder	8930002650	1
㊳	Speaker 57S38-1	2510000280	1
㊴	57 Speaker Spacer	8930004950	1
㊵	543 Bottom Cover	8110002030	1
㊶	ICOM Screw (B) 5	8810003710	4
㊷	BuH M2.6 × 5 ZK	8810003871	4
㊸	Set Screw (A) M3 × 5	8810003150	6
㊹	BuH M2.6 × 4 Ni BS	8810002600	5
㊺	PA (A) Top Cover	8510002860	1
㊻	365 Heatsink (C)-1	8410001190	1
㊼	543 MAIN Shield plate-1	8950000481	1
㊽	543 Chassis	8010007260	1
㊾	Grounding Plate	8010001610	2
㊿	PA (B) Top Cover	8510002870	1
1	Power Supply Cable OPC-084 (Connector included)	8900000620	1
2	PH M2.6 × 4	8810000130	4
3	543 VCO case	8510005240	1
4	ICOM Screw (A) 6 Ni	8810003670	2
5	Antenna Cable OPC-186 (Connector included)	8900001890	1
6	499 VCO Case	8510001010	1
7	ICOM Screw (A) 5	8810003650	5
8	Standoff (F)	8930000100	5
9	Spring Washer M3 Ni	8850000420	5
0	Set Screw (A) M3 × 5	8810003150	2
1	FH M3 × 5	8810002160	8
2	Half-thread Spacer	8930000990	4

* Screw type Screw: M2.6 × 4, etc. Self-tapping screw: B0 2 × 4, etc.

Screw's head style PH: Pan head FH: Flat head BuH: Button head

U
S
N
A
V
Y
M
I
S
S
I
O
N
S
R
E
C
O
R
D
S

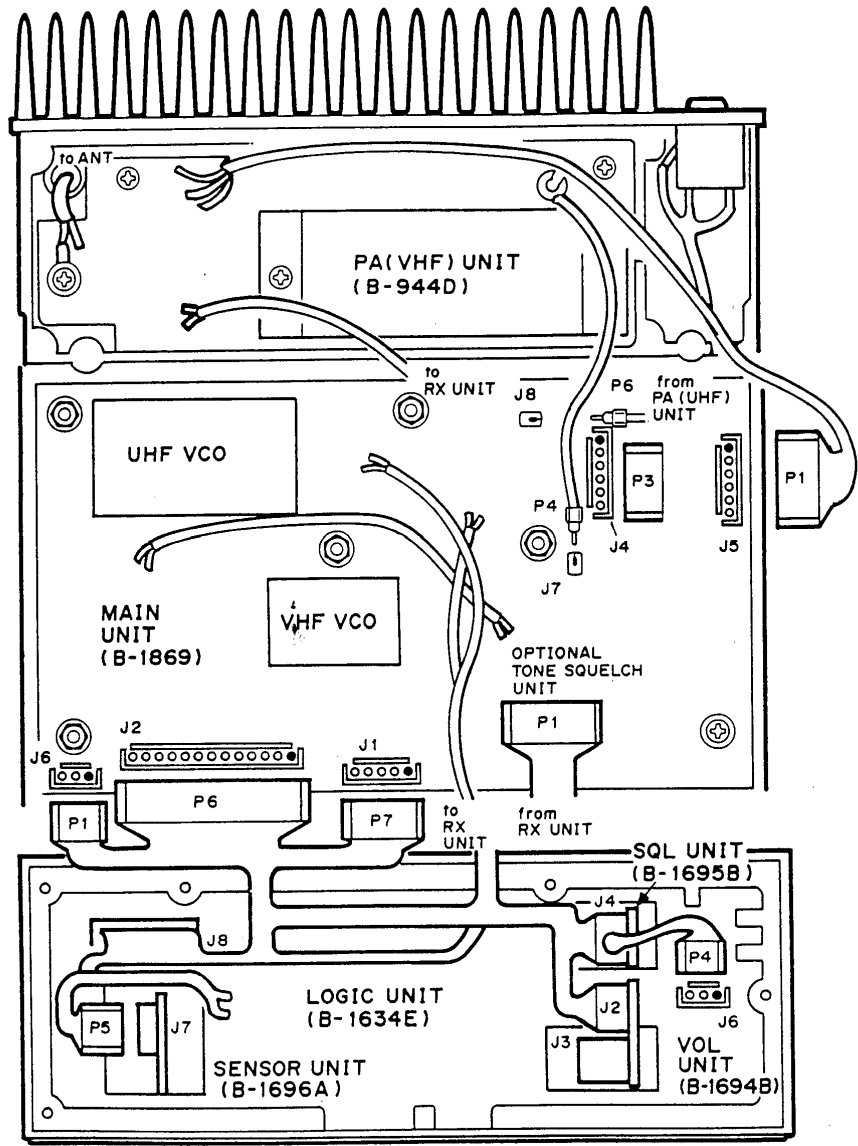

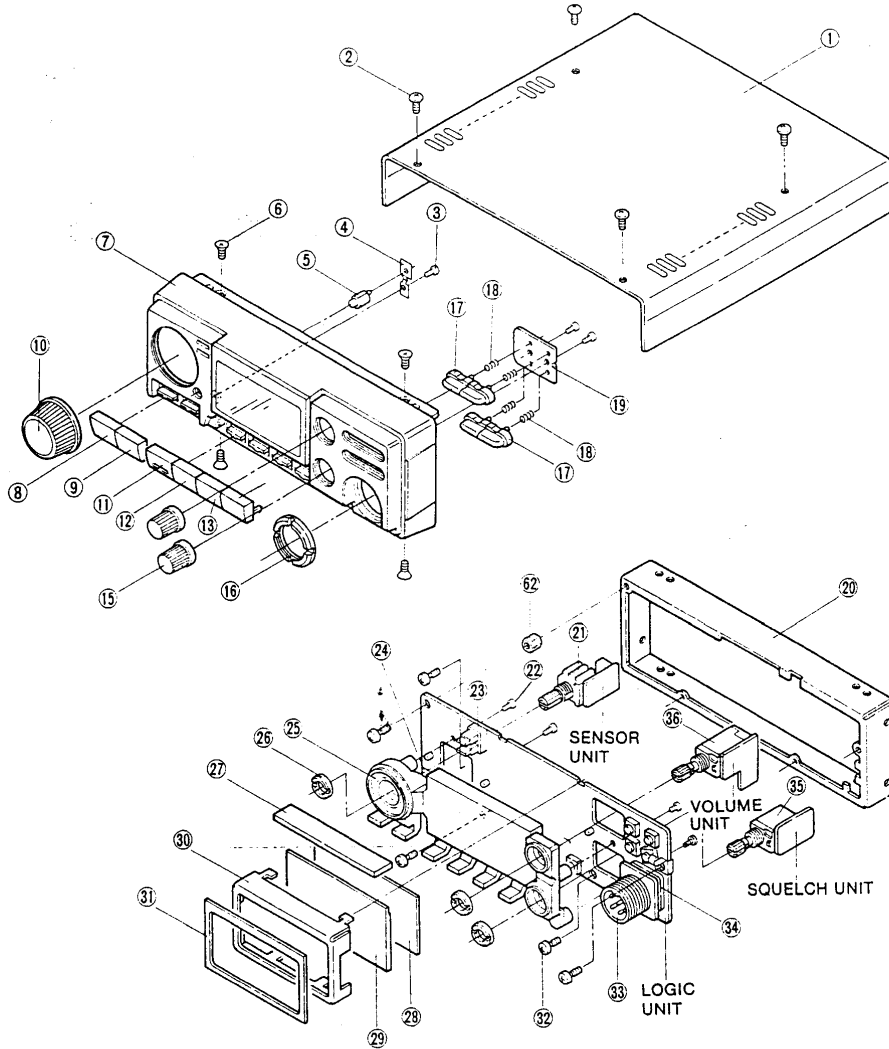

Downloaded by

Amateur Radio Directory

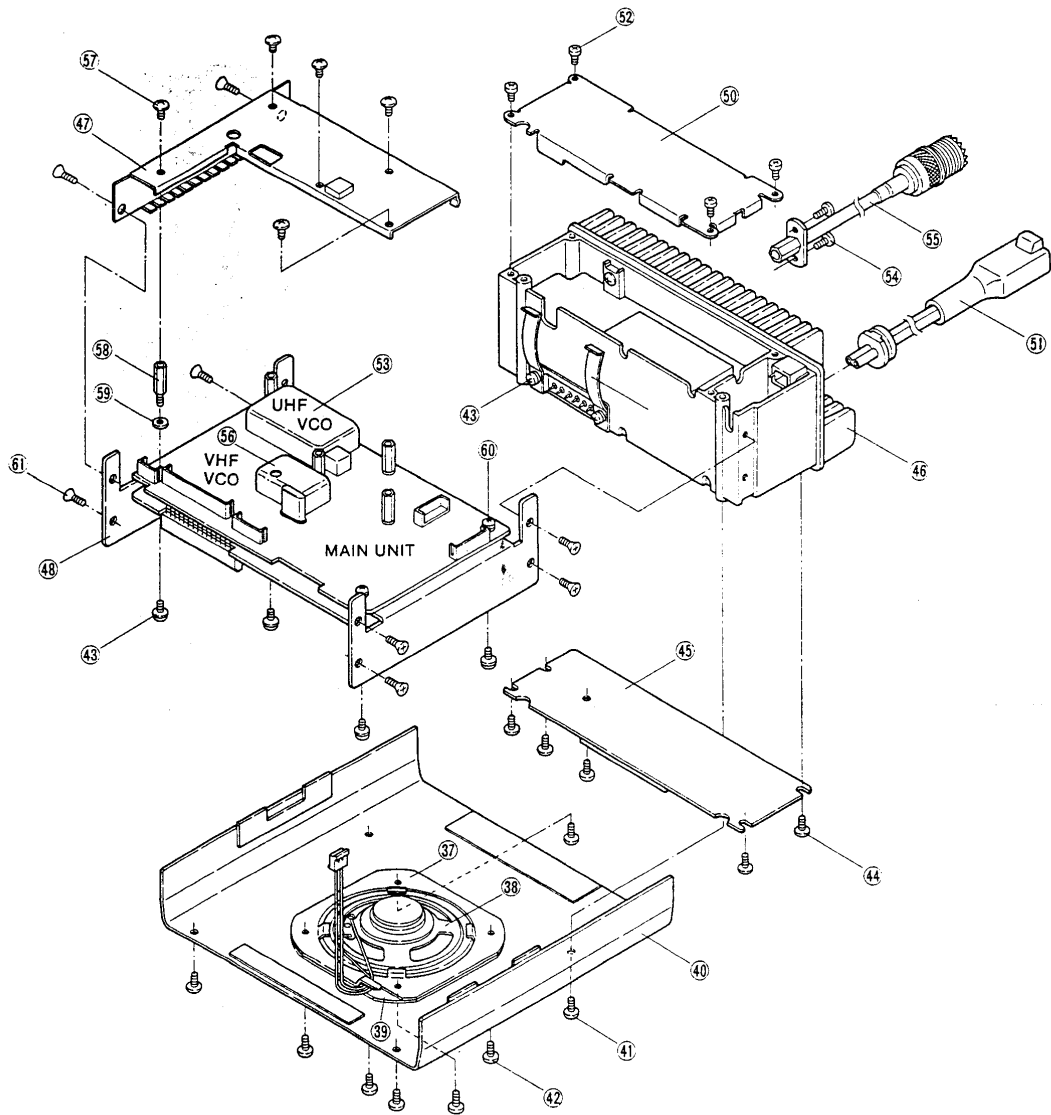

5-2 CONNECTOR ASSEMBLY

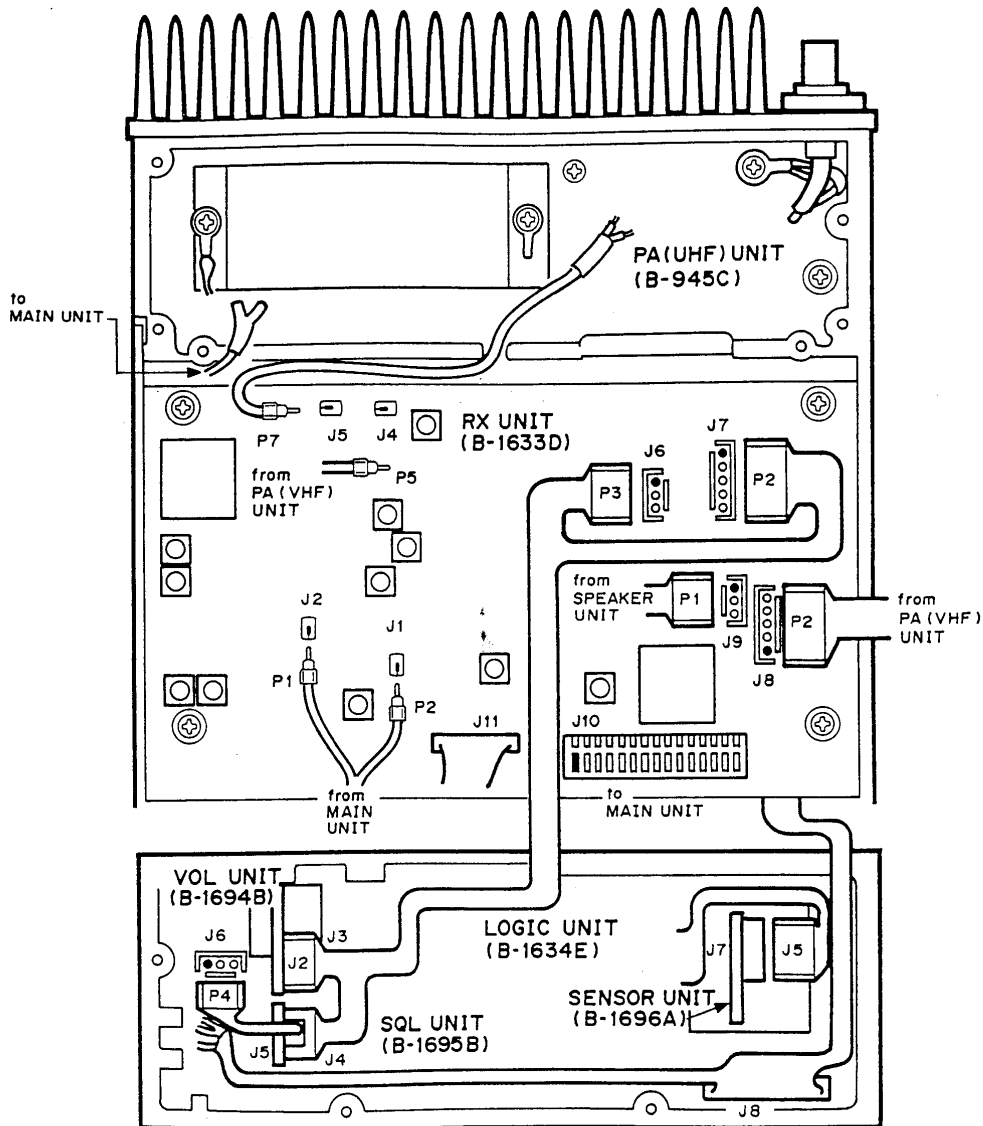

Downloaded by

Amateur Radio Directory

SECTION 6 MAINTENANCE AND ADJUSTMENT

6-1 PLL ADJUSTMENT

TEST INSTRUMENTS REQUIRED		MEASUREMENT CONNECTION LOCATION				
(1) AC POWER SUPPLY • Output voltage : 13.8 V DC \pm 15 % • Current capacity : 10 A or more (2) DC VOLTMETER • Input impedance : 50 k Ω /DC or better (3) FREQUENCY COUNTER • Frequency minimum : 500 MHz • Frequency accuracy : \pm 1 ppm or better • Sensitivity : 100 mV or better (4) RF POWER METER (or 50 Ω dummy load) • Minimum power rating : 50 W • Frequency minimum : 500 MHz • Input impedance : 50 Ω • SWR : 1.2:1 or better						
ADJUSTMENT	ADJUSTMENT CONDITIONS	MEASUREMENT		VALUE	ADJUSTMENT POINT	
		UNIT	LOCATION		UNIT	ADJUST
LOCK VOLTAGE	1 • Frequency display: 146.000 MHz (IC-3210A) 145.000 MHz (IC-3210E) • Receiving	MAIN	Connect the DC voltmeter to J3 pin 4.	6.8 V (IC-3210A) 6.4 V (IC-3210E)	MAIN (VHF VCO)	L2
REFERENCE FREQUENCY	1 • Frequency display: 450.000 MHz (U.S.A.) 440.000 MHz (except U.S.A.) • Transmitting	MAIN	Loose couple the frequency counter to the LPF circuit.	450.000 MHz (U.S.A.) 440.000 MHz (except U.S.A.)	MAIN	C102

• MAIN UNIT

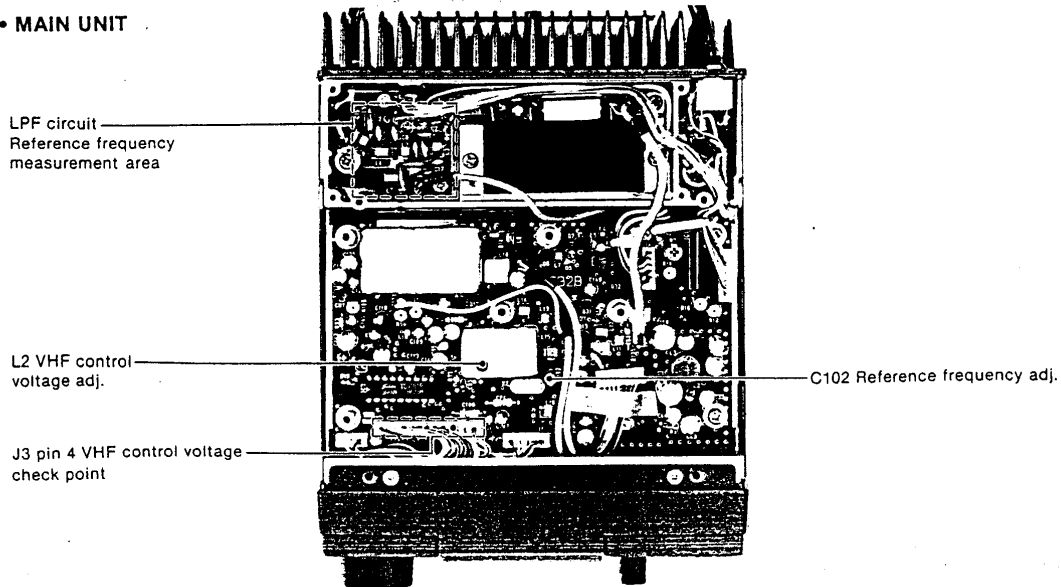

6-2 RECEIVER ADJUSTMENT

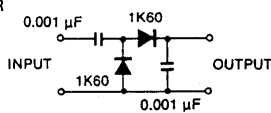
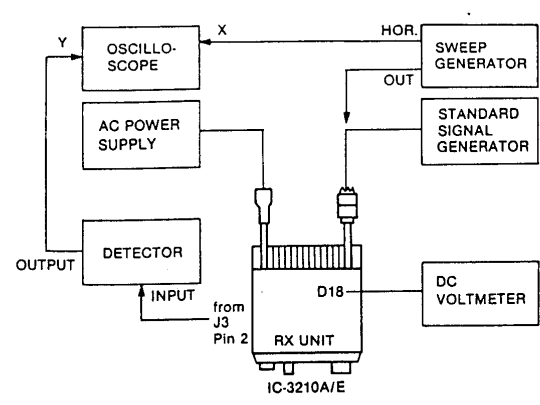
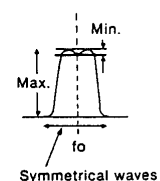
TEST INSTRUMENTS REQUIRED		MEASUREMENT CONNECTION LOCATION					
<p>(1) AC POWER SUPPLY</p> <ul style="list-style-type: none"> Output voltage : 13.8 V DC \pm 15 % Current capacity : 10 A or more <p>(2) STANDARD SIGNAL GENERATOR (SSG)</p> <ul style="list-style-type: none"> Frequency range : 0.1~500 MHz Output level : -127~-17 dBm (0.1 μV~32 mV) <p>(3) DC VOLTMETER</p> <ul style="list-style-type: none"> Input impedance : 50 kΩ/DC or better <p>(4) OSCILLOSCOPE</p> <ul style="list-style-type: none"> Frequency range : DC~20 MHz Measuring range : 0.01~10 V <p>(5) SWEEP GENERATOR</p> <ul style="list-style-type: none"> Frequency range : 0.1~500 MHz Sweep bandwidth : At least 30 MHz Output impedance : 50 Ω <p>(6) DETECTOR</p> 							
ADJUSTMENT	ADJUSTMENT CONDITIONS	MEASUREMENT		VALUE	ADJUSTMENT POINT		
		UNIT	LOCATION		UNIT	ADJUST	
UHF BANDPASS FILTER	1	RX	Connect the oscilloscope to J3 pin 2 via the detector.	Adjust as follows:  Symmetrical waves	RX	C70 L13 L11 C48	
IF AMP	1	RX	Connect the DC voltmeter to D18 cathode.	Maximum	RX	C48 L3 L2 L1	
NOTE: Adjust the signal generator output level for each time showing the DC voltmeter at 30 % of the lowest range full scale.							
VHF SENSITIVITY	1	RX	Connect the DC voltmeter to D18 cathode.	Maximum	RX	L8 L7 L6 L5	
NOTE: Adjust the signal generator output level for each time showing the DC voltmeter at 30 % of the lowest range full scale.							

RECEIVER ADJUSTMENT (CONTINUED)

ADJUSTMENT	ADJUSTMENT CONDITIONS	MEASUREMENT		VALUE	ADJUSTMENT POINT	
		UNIT	LOCATION		UNIT	ADJUST
S-METER	<ul style="list-style-type: none"> • Frequency display: 146.000 MHz (IC-3210A) 145.000 MHz (IC-3210E) • Receiving • Apply an RF signal to the antenna connector. Level: -107 dBm (1 μV) Dev. : ±3.5 kHz Mod. : 1 kHz 	Function display	S/RF indicator	S3 (2 dots)	RX	R53
	<ul style="list-style-type: none"> • Frequency display: 445.000 MHz (U.S.A.) 435.000 MHz (except U.S.A.) 			S5 (3 dots)		R52

• RX UNIT

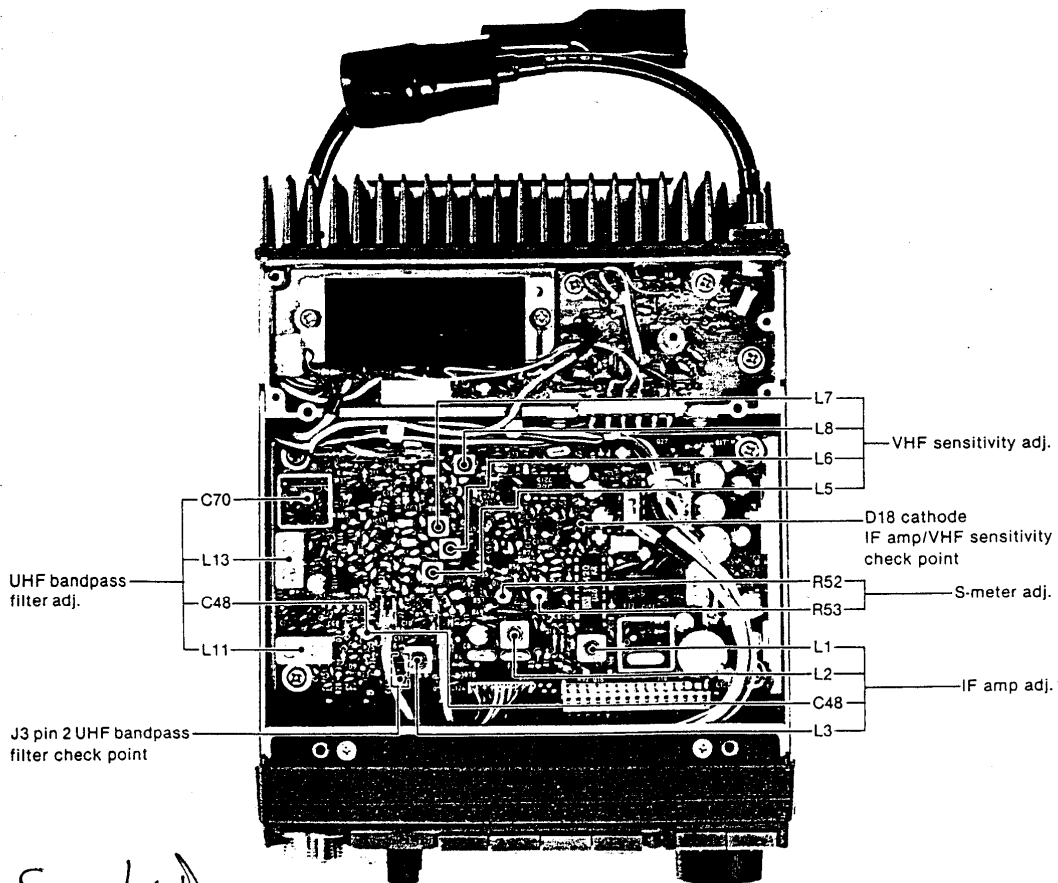

6-3 TRANSMITTER ADJUSTMENT

TEST INSTRUMENTS REQUIRED		MEASUREMENT CONNECTION LOCATION				
<p>(1) AC POWER SUPPLY</p> <ul style="list-style-type: none"> Output voltage : 13.8 V DC \pm 15 % Current capacity : 10 A or more <p>(2) RF POWER METER</p> <ul style="list-style-type: none"> Terminated type Minimum power rating : 50 W Frequency minimum : 500 MHz Input impedance : 50 Ω SWR : 1.2 : 1 or better <p>(3) FM DEVIATION METER</p> <ul style="list-style-type: none"> Frequency minimum : 500 MHz Measuring range : 0 \sim \pm 10 kHz <p>(4) AF GENERATOR</p> <ul style="list-style-type: none"> Frequency range : 200 \sim 2000 Hz Output range : 2 \sim 200 mV <p>(5) ATTENUATOR</p> <ul style="list-style-type: none"> Attenuation : 40 dB or 50 dB Input power rating : At least 50 W 						
ADJUSTMENT	ADJUSTMENT CONDITIONS	MEASUREMENT		VALUE	ADJUSTMENT POINT	
		UNIT	LOCATION		UNIT	ADJUST
OUTPUT POWER	1	Rear panel	Connect the RF power meter to the antenna connector.	25 W	MAIN	R16
	2			5 W		R12
	3			25 W		R7
	4			5 W		R10
DEVIATION	1	Rear panel	Connect the FM deviation meter to the antenna connector via the attenuator.	\pm 4.8 kHz	MAIN	R56
	2			\pm 3.5 kHz		R109

TRANSMITTER ADJUSTMENT (CONTINUED)

ADJUSTMENT	ADJUSTMENT CONDITIONS	MEASUREMENT		VALUE	ADJUSTMENT POINT		
		UNIT	LOCATION		UNIT	ADJUST	
DEVIATION	3	<ul style="list-style-type: none"> Frequency display: 445.000 MHz (U.S.A.) 435.000 MHz (except U.S.A.) Apply an AF signal to the [MIC] connector. Level: 65 mV/1 kHz (U.S.A.) 20 mV/1 kHz (except U.S.A.) 	Rear panel	Connect the FM deviation meter to the antenna connector via the attenuator.	±4.8 kHz	MAIN	R55
TONE DEVIATION (IC-3210A)	1	<ul style="list-style-type: none"> Frequency display: 146.000 MHz Apply no signal to the [MIC] connector. [T./T. SQL] SWITCH: ON Tone frequency: 88.5 Hz Set the FM deviation meter. HPF: OFF LPF: 20 kHz 	Rear panel	Connect the FM deviation meter to the antenna connector via the attenuator.	±0.65 kHz	MAIN	R24

MAIN UNIT

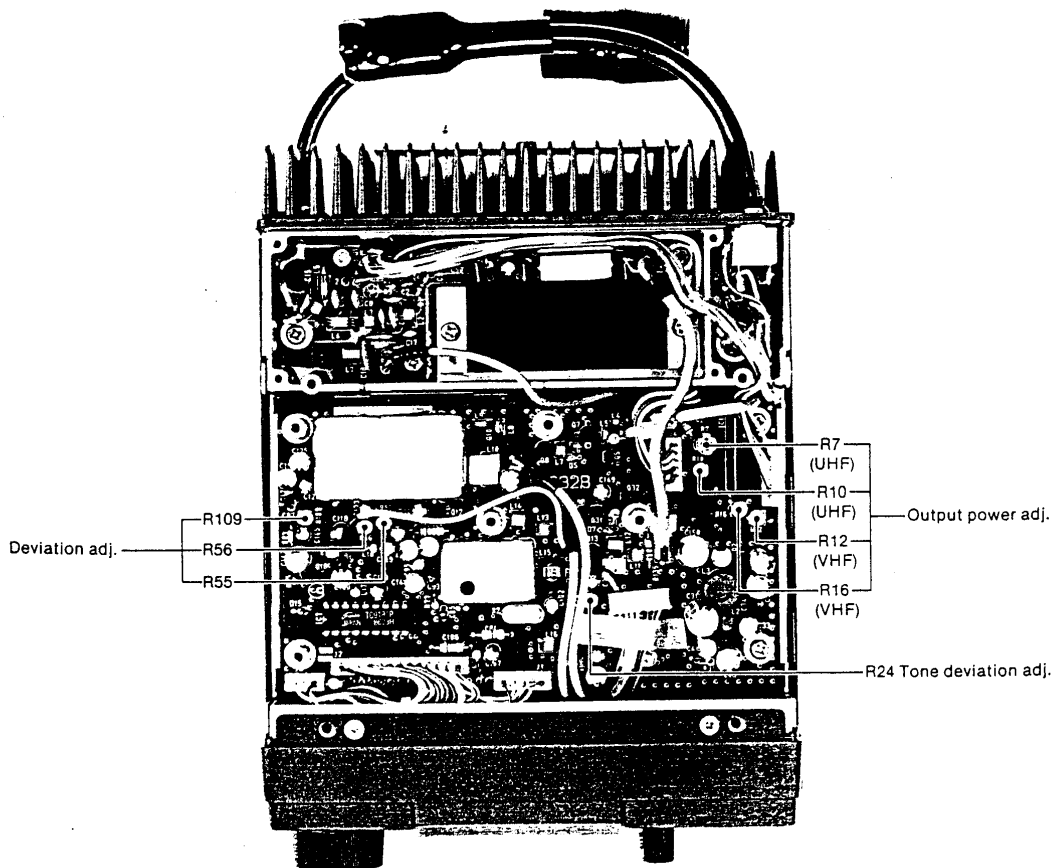

SECTION 7 BOARD LAYOUTS

7-1 LOGIC UNIT

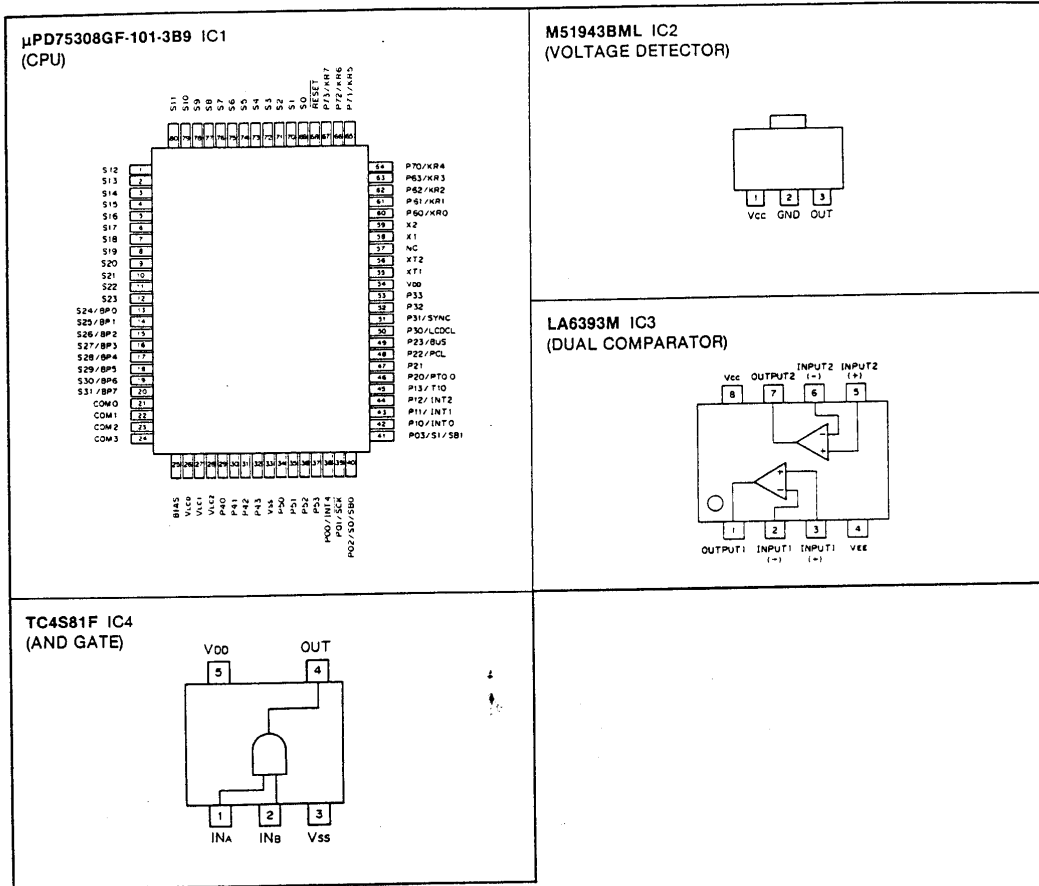

2SB798 DK
Q11

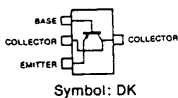

2SC2712 Y
Q1, Q2, Q4
Q5, Q10, Q12
Q15

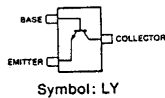

RN1404
Q13

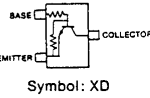

RN2404
Q3, Q8
Q9, Q14

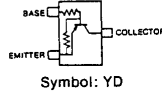

1SS181
D20

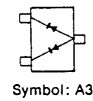

1SS184
D4, D6, D7, D9
D12 (IC-3210A/E:
Europe, Australia)
D22

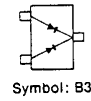

1SS190
D1, D25



1SS193
D2, D3, D5, D8
D15 (IC-3210A: Australia)
D16 (IC-3210E: Europe)
D21, D23, D24



1SS196
D10 (IC-3210A: U.S.A.)
D11 (IC-3210A: U.S.A.)
D12 (IC-3210A: U.S.A.)
D15 (IC-3210E: Europe)
D16 (IC-3210A: U.S.A., Australia)



RD9.1M B2
D18



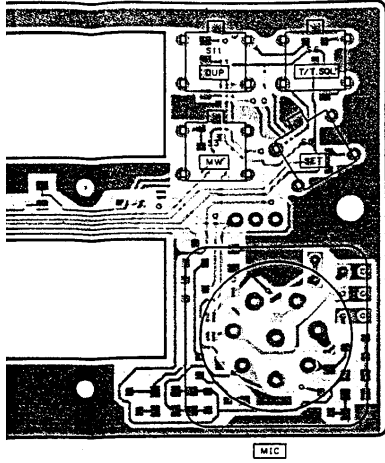

FOIL SIDE
COMPONENT SIDE

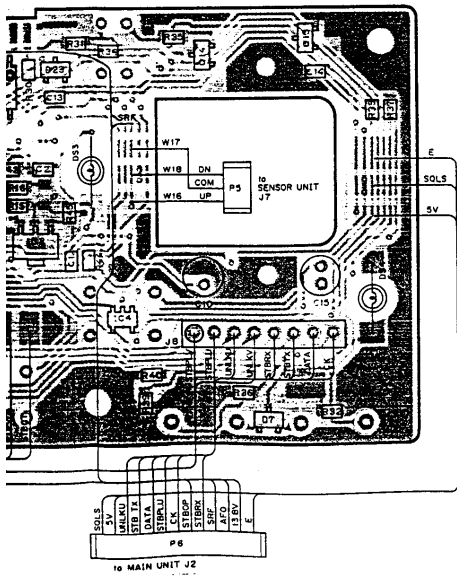

FOIL SIDE
COMPONENT SIDE

• SENSOR UNIT

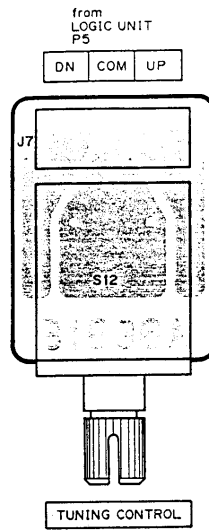

• VOL UNIT

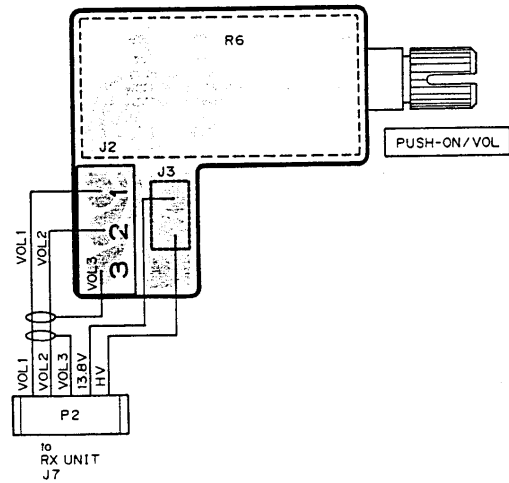

• SQL UNIT

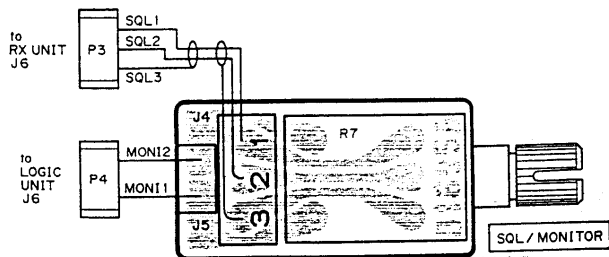

COMPONENT SIDE

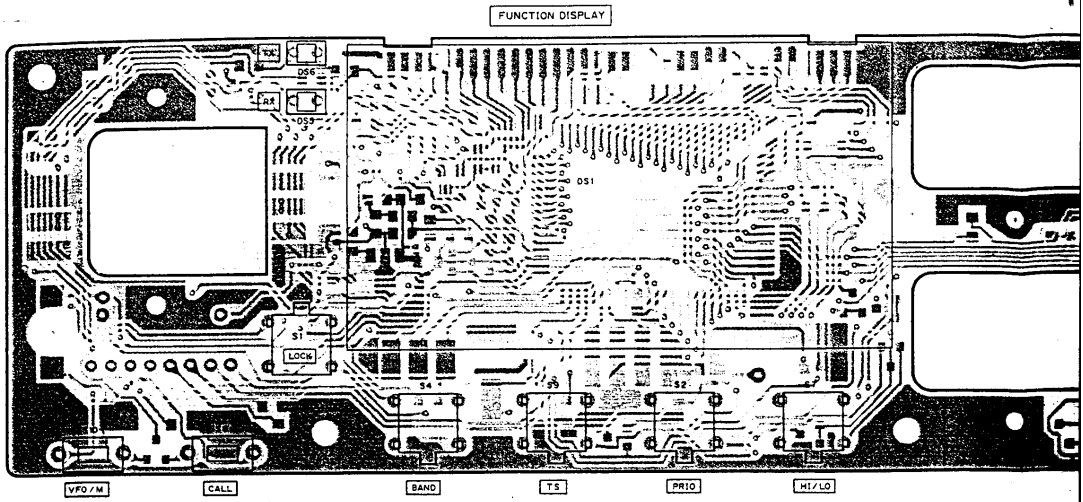

FOIL SIDE

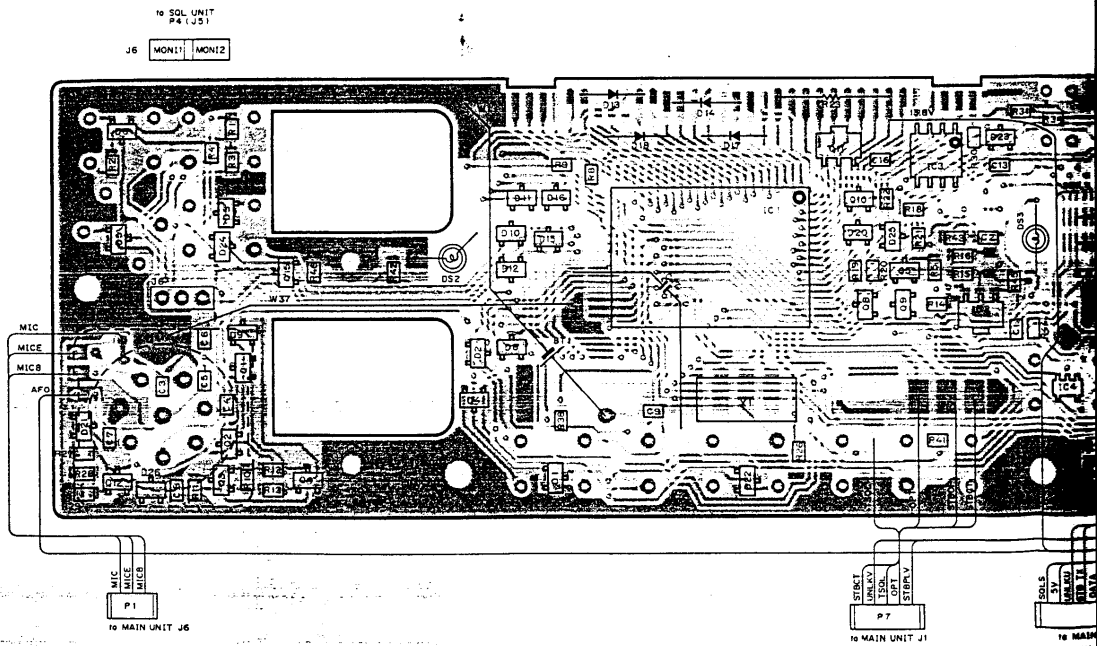

7-2 MAIN UNIT

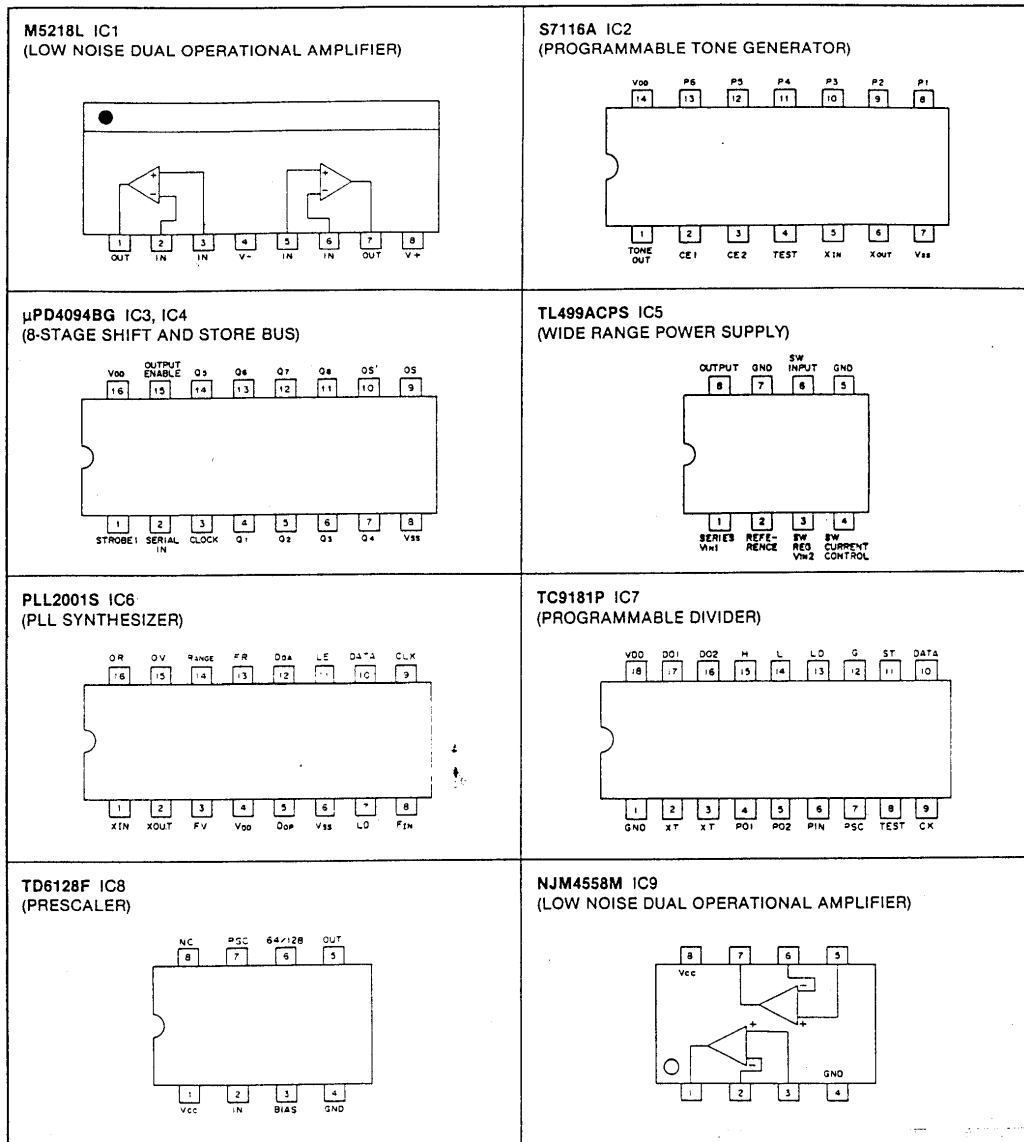

1SS184
D1, D2



Symbol: B3

1SS193
D3, D4, D9
D10, D11, D12
D13, D14, D16
D18



Symbol: F3

MA8620
D6, D8



Symbol: M11

RD4.7M B2
D17



Symbol: 472

COMPONENT SIDE

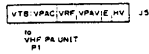
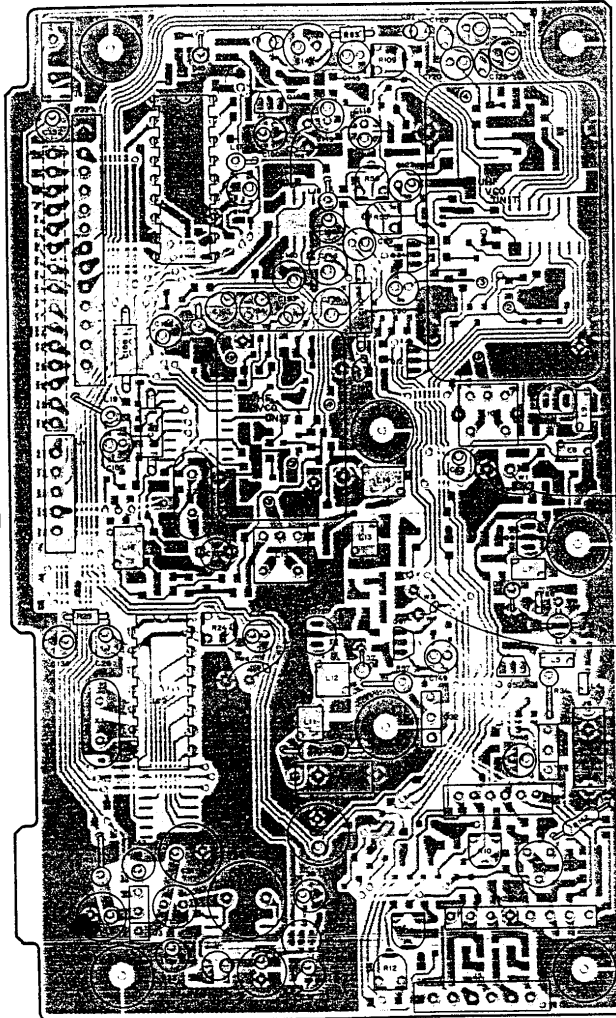
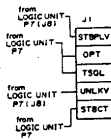
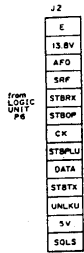

FOIL SIDE
COMPONENT SIDE

2SA1162 Y/GR
Q22, Q24, Q43

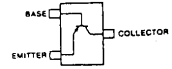

Symbol: SG, SY

2SB909M R
Q32

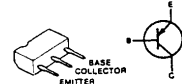

2SC1645 B
Q2

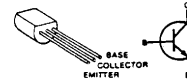

2SC2407 (A)
Q13



2SC2712 Y/BL/GR
Q19, Q30, Q41
Q44, Q45, Q46

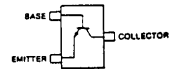

Symbol: LY, LL, LG

2SC3661
Q37, Q40

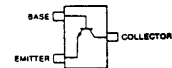

Symbol: FY

2SC3770 3
Q15, Q17

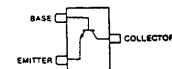

Symbol: JY3

2SC3776 D
Q10

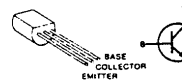

FOIL SIDE

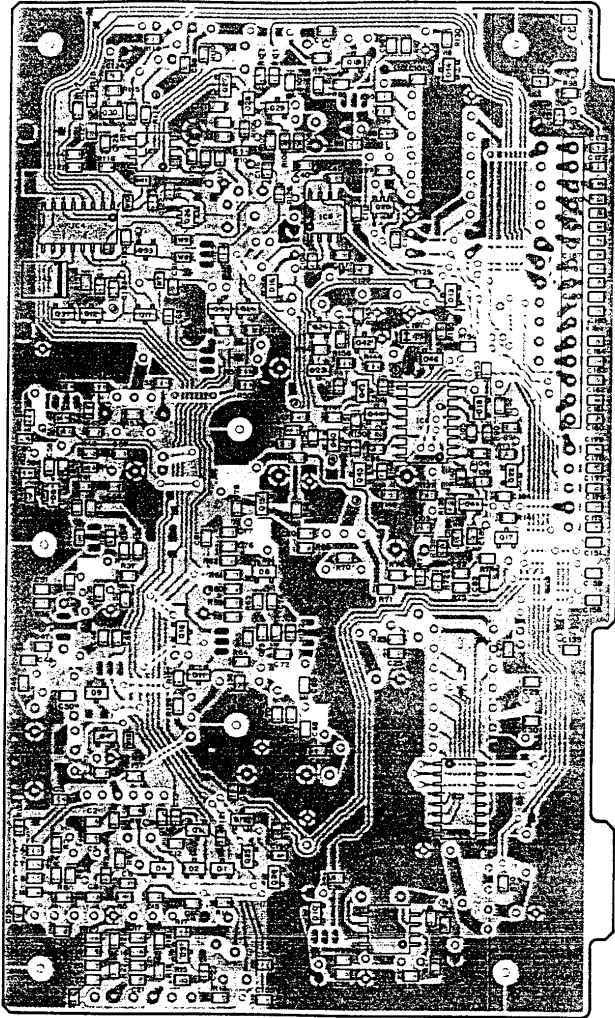

FOIL SIDE
COMPONENT SIDE

J3	
15.8V	
AFO	
5V	
SRF	IN
STBR	PK UNIT
STBOP	J10
DATA	
CK	
5V	
E	
SOLS	
TUN	
DET	
TSOL	
OPV	

2SC3779 D
Q8



2SD1225M R
Q3



RN1402
Q1, Q4, Q9
Q11, Q14
Q16, Q27
Q33, Q35
Q36

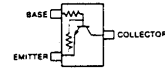

Symbol: XB

DTB143ES
Q5, Q12
Q31, Q34

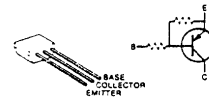

TRF559
Q7

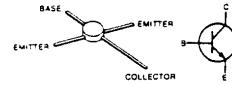

IMD6
Q25, Q26

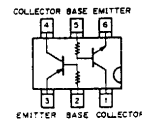

2SK184 Y
Q18

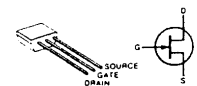

2SJ106 GR
Q28, Q29

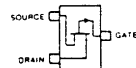

Symbol: VG

2SK209 Y
Q23, Q42

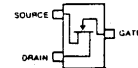

Symbol: XY

7-3 RX UNIT

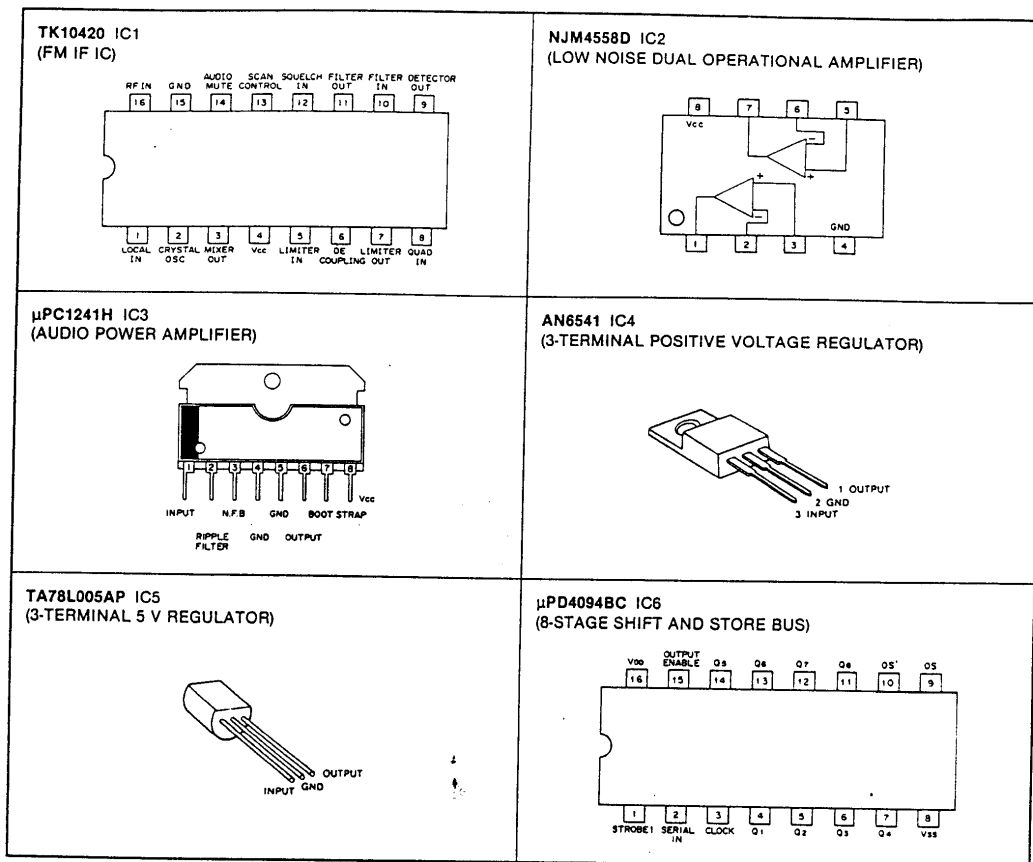

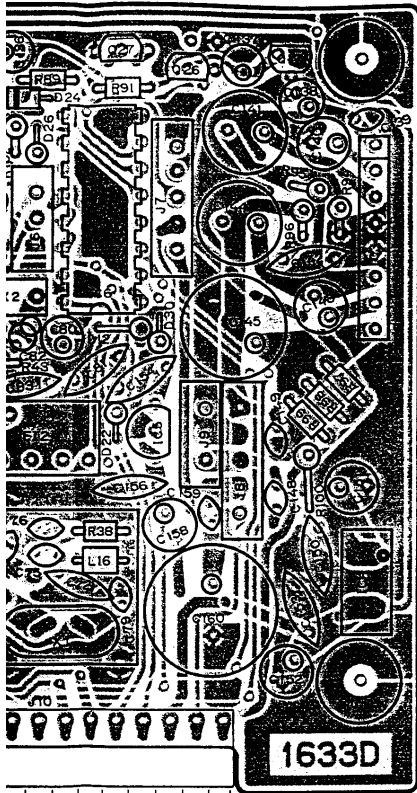

5V CK DATA STBOP STBRX SRF 8V AFO 13.8V

UNIT J3

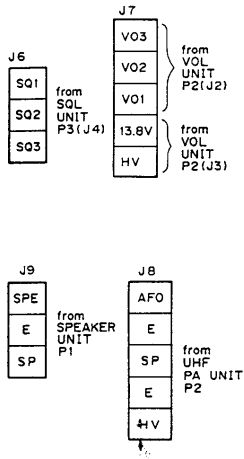

2SA1048 GR
Q16



RN2204
Q15, Q21
Q25

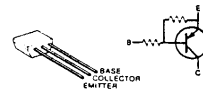

2SC2458 GR
Q9, Q10, Q13



3SK121 Y
Q8

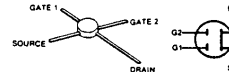

2SC3776 D
Q11, Q12

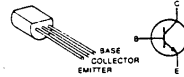

2SK125
Q7

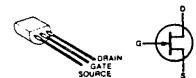

3SK174 L or M
Q3, Q4, Q6

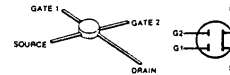

2SJ105 GR
Q14



2SK241 Y
Q1



DTB143ES
Q18, Q23

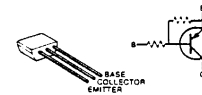

RN1204
Q2, Q5, Q17
Q19, Q20
Q22, Q24
Q26, Q27

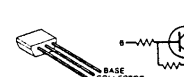

from UHF PA UNIT — P7

from UHF PA UNIT — P5

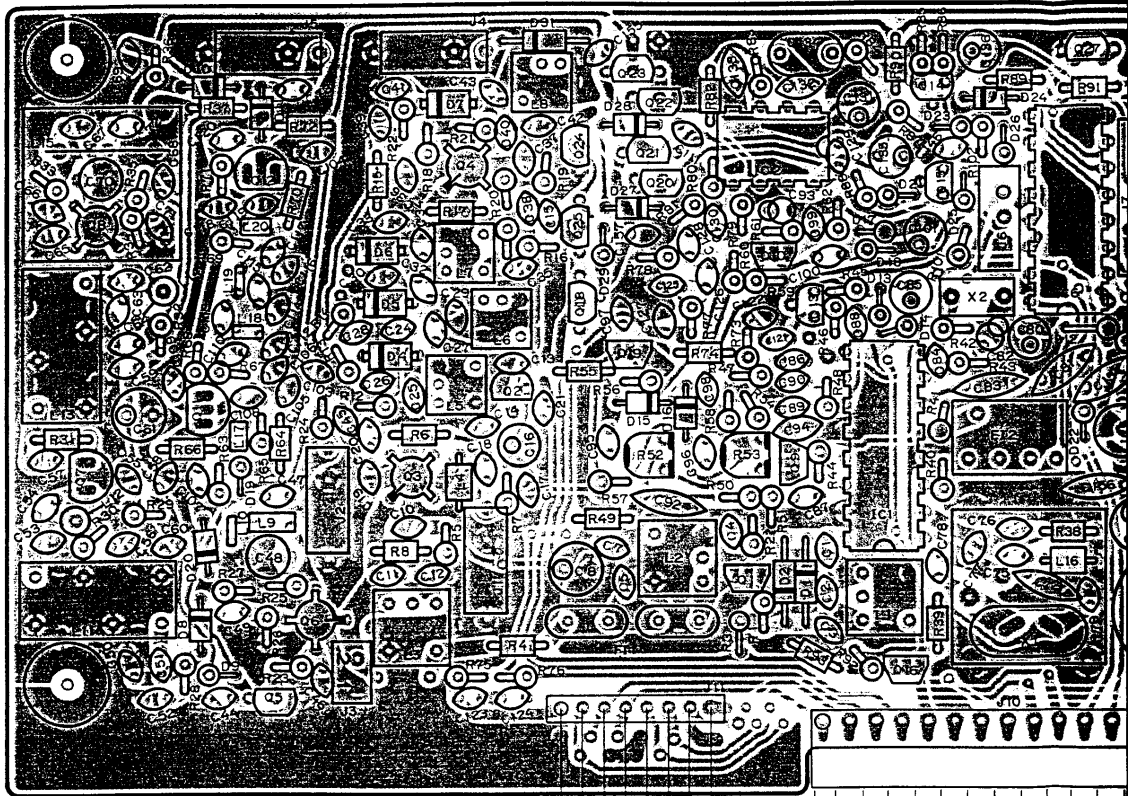

NC	DETO
5V	TSOL
NC	OPT
DETA	STBOP
CK	E
P1	

OPT	TSOL	DETA	TON	SOLS	E	5V	CK	DATA	STBOP	STB
-----	------	------	-----	------	---	----	----	------	-------	-----

P1 U.LO
from MAIN UNIT

P2 V.LO
from MAIN UNIT

to OPTIONAL TONE SQUELCH UNIT (UT-40)

from MAIN UNIT J3

7-4 VCO UNITS

• UHF VCO UNIT

COMPONENT SIDE

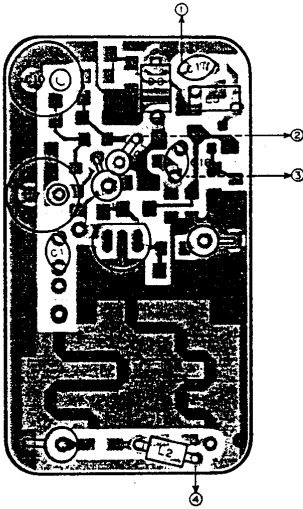

2SK125
Q1

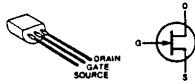

FOIL SIDE

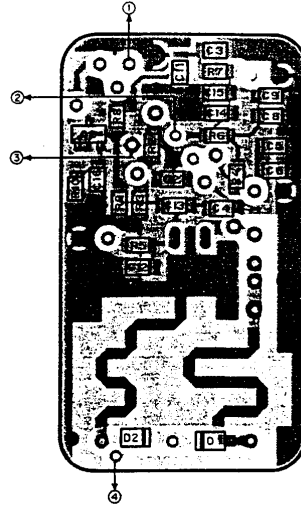

2SC3775 3
Q2

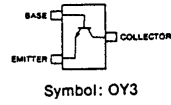

FOIL SIDE
COMPONENT SIDE

FOIL SIDE
COMPONENT SIDE

• VHF VCO UNIT

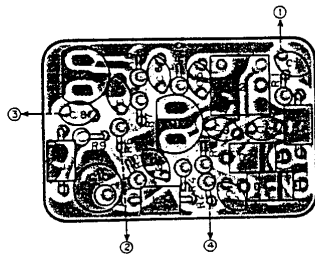

2SK125
Q1



2SC3776 D
Q2

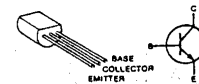

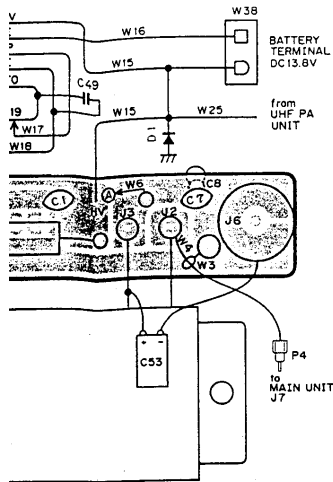

SC-1019 IC1
(VHF RF POWER AMP)

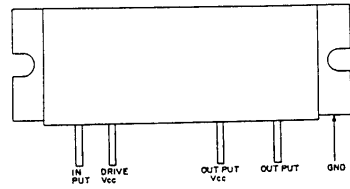

2SA1345
Q2

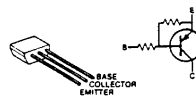

2SA1359 Y
Q1

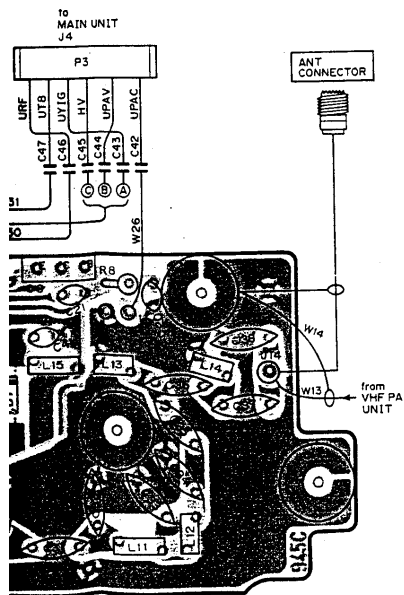
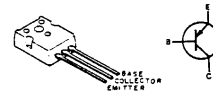

SC-1027 IC2
(UHF RF POWER AMP)

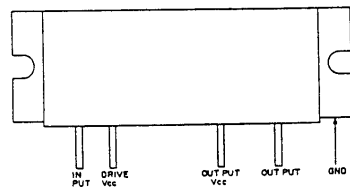

2SA1345
Q4

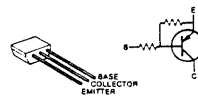

2SA1359 Y
Q2

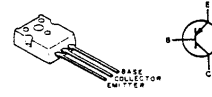

7-5 PA UNITS

• VHF PA UNIT

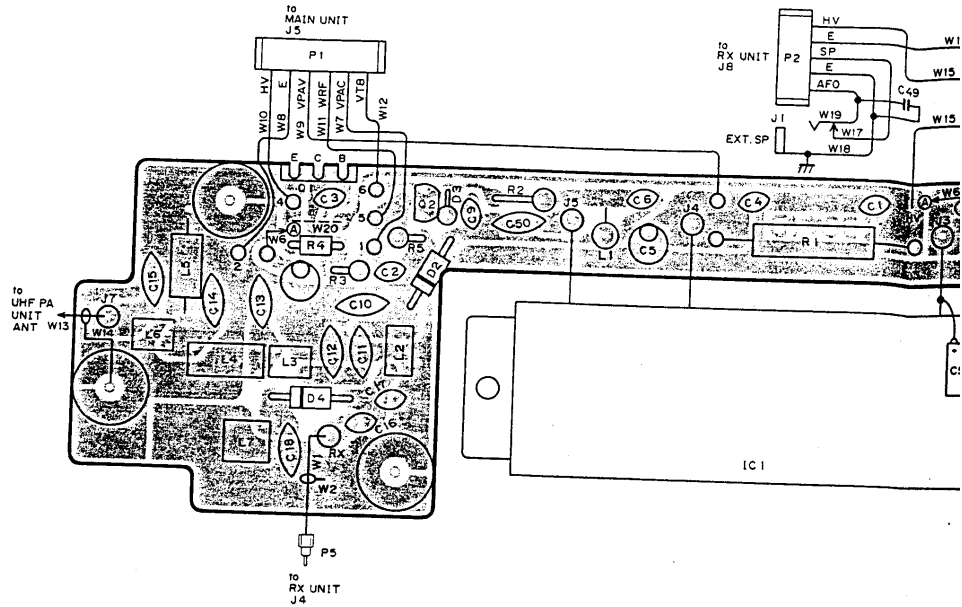

• UHF PA UNIT

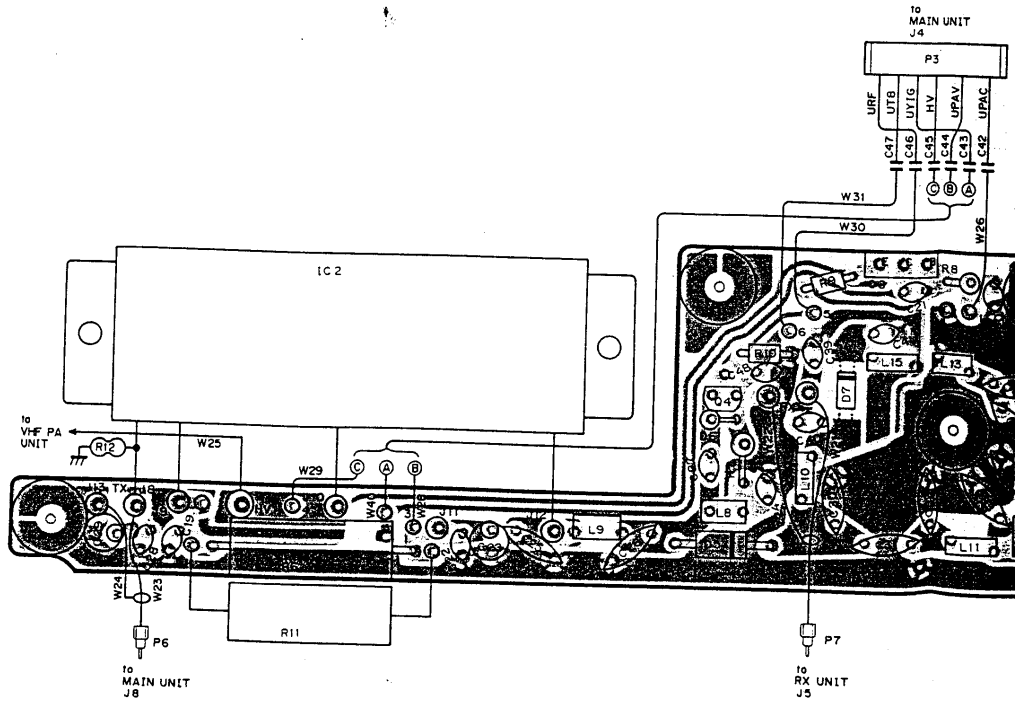

SECTION 8 PARTS LIST

[LOGIC UNIT]

REF. NO.	DESCRIPTION	PART NO.
IC1	IC	μPD75308GF-101-3B9
IC2	IC	M51943BML
IC3	IC	LA6393M
IC4	IC	TC4S81F
Q1	Transistor	2SC2712 Y
Q2	Transistor	2SC2712 Y
Q3	Transistor	RN2404
Q4	Transistor	2SC2712 Y
Q5	Transistor	2SC2712 Y
Q8	Transistor	RN2404
Q9	Transistor	RN2404
Q10	Transistor	2SC2712 Y
Q11	Transistor	2SB798 DK
Q12	Transistor	2SC2712 Y
Q13	Transistor	RN1404
Q14	Transistor	RN2404
Q15	Transistor	2SC2712 Y
D1	Diode	1SS190
D2	Diode	1SS193
D3	Diode	1SS193
D4	Diode	1SS184
D5	Diode	1SS193
D6	Diode	1SS184
D7	Diode	1SS184
D8	Diode	1SS193
D9	Diode	1SS184
D10	Diode	1SS196 (IC-3210A: U.S.A.)
D11	Diode	1SS196 (IC-3210A: U.S.A.)
D12	Diode	1SS196 (IC-3210A: U.S.A.)
D12	Diode	1SS184 (IC-3210A/E: Europe, Australia)
D13	Diode	1SS254
D14	Diode	1SS254
D15	Diode	1SS193 (IC-3210A: Australia)
D15	Diode	1SS196 (IC-3210E: Europe)
D16	Diode	1SS193 (IC-3210E: Europe)
D16	Diode	1SS196 (IC-3210A: U.S.A., Australia)
D17	Diode	1SS254 (IC-3210A/E: Europe, Australia)
D18	Diode	1SS254
D20	Diode	1SS181
D21	Diode	1SS193
D22	Diode	1SS184
D23	Diode	1SS193
D24	Diode	1SS193
D25	Diode	1SS190
D26	Zener	RD9.1M B2
X1	Crystal	FAR-C4CA-04194000-M01 (4.194304 MHz)
R1	Resistor	47 kΩ MCR10
R2	Resistor	47 kΩ MCR10
R3	Resistor	47 kΩ MCR10
R4	Resistor	47 kΩ MCR10
R5	Resistor	82 kΩ MCR10
R6	Variable Resistor	10 kΩ A RK0971112008A [PUSH-ON/VOL]
R7	Variable Resistor	10 kΩ B RK0971114005A [SQL/MONITOR]
R8	Resistor	47 kΩ MCR10
R9	Resistor	47 kΩ MCR10
R10	Resistor	1 kΩ MCR10

[LOGIC UNIT]

REF. NO.	DESCRIPTION	PART NO.
R11	Resistor	100 kΩ MCR10
R12	Resistor	100 kΩ MCR10
R13	Resistor	100 kΩ MCR10
R14	Resistor	220 kΩ MCR10
R15	Resistor	100 kΩ MCR10
R16	Resistor	100 kΩ MCR10
R18	Resistor	27 kΩ MCR10
R19	Resistor	27 kΩ MCR10
R20	Resistor	56 kΩ MCR10
R21	Resistor	1.2 kΩ MCR10
R22	Resistor	1.8 kΩ MCR10
R23	Resistor	220 Ω R50X
R26	Resistor	100 kΩ MCR10
R27	Resistor	220 Ω MCR10
R28	Resistor	3.9 kΩ MCR10
R29	Resistor	1 kΩ MCR10
R30	Resistor	1.2 MΩ MCR10
R31	Resistor	100 kΩ MCR10
R32	Resistor	33 Ω MCR10
R33	Resistor	4.7 kΩ MCR10
R34	Resistor	180 Ω MCR10
R35	Resistor	330 Ω MCR10
R36	Resistor	1 MΩ MCR10
R37	Resistor	8.2 kΩ MCR10
R38	Resistor	15 kΩ MCR10
R39	Resistor	100 kΩ MCR10
R40	Resistor	100 kΩ MCR10
R41	Resistor	100 kΩ MCR10
R42	Resistor	470 kΩ MCR10
R43	Resistor	4.7 kΩ MCR10
R44	Resistor	3.3 kΩ MCR10
R45	Resistor	2.7 kΩ MCR10
R46	Resistor	150 kΩ MCR10
C1	Ceramic	0.001 μF GRM40
C2	Ceramic	0.01 μF GRM40 F
C3	Ceramic	0.001 μF GRM40
C4	Ceramic	0.001 μF GRM40
C5	Ceramic	0.001 μF GRM40
C6	Ceramic	0.001 μF GRM40
C7	Ceramic	0.001 μF GRM40
C8	Ceramic	0.001 μF GRM40
C9	Ceramic	0.1 μF GRM40 F
C10	Electrolytic	47 μF 6.3 V MS7
C13	Ceramic	330 pF GRM40 CH
C14	Ceramic	0.001 μF GRM40
C15	Electrolytic	47 μF 6.3 V MS7
C16	Ceramic	0.001 μF GRM40
C17	Barrier Layer	0.1 μF 16 V
J1	Connector	8S-S-E
J2	Connector	TLB-P03H-B1
J3	Connector	TZB-P02H-A1
J4	Connector	TLB-P03H-B1
J5	Connector	TZB-P02H-A1
J6	Connector	TXL-P03P-C1
J7	Connector	B03B-EH-S
J8	Connector	PD09A08
P1	Connector	EHR-03
P2	Connector	EHR-05
P3	Connector	EHR-03
P4	Connector	TXL-P03H-A1
P5	Connector	EHR-03
P6	Connector	EHR-13
P7	Connector	EHR-05

[LOGIC UNIT]

REF. NO.	DESCRIPTION	PART NO.
DS1	LCD	LCD-9811J
DS2	Lamp	HRS-7219A-Y2 30
DS3	Lamp	HRS-7219A-Y2 30
DS4	Lamp	HRS-7219A-Y2 30
DS5	LED	SLP-251B
DS6	LED	SLP-151B
S1	Switch	HKW0270-30 [LOCK]
S2	Switch	HKW0270-30 [PRIO]
S3	Switch	HKW0270-30 [MW]
S4	Switch	HKW0270-30 [BAND]
S5	Switch	HKW0270-30 [SET]
S6	Switch	HKW0270-30 [T/T. SQL]
S7	Switch	HKW0270-30 [HI/LO]
S8	Switch	SKHLAB064A [CALL]
S9	Switch	HKW0270-30 [TS]
S10	Switch	SKHLAB064A [VFO/M]
S11	Switch	HKW0270-30 [DUP]
S12	Encoder	SRBM1L038A [TUNING CONTROL]
BT1	Lithium Battery	BR2032-1T2
EP1	P.C. Board	B-1634E (LOGIC)
EP2	P.C. Board	B-1694B (VOL)
EP3	P.C. Board	B-1695B (SQL)
EP4	P.C. Board	B-1696A (SENSOR)
EP5	LCD Contact Strip	SRCN543

[MAIN UNIT]

REF. NO.	DESCRIPTION	PART NO.
IC1	IC	M5218L
IC2	IC	S7116A
IC3	IC	μPD4094BG
IC4	IC	μPD4094BG
IC5	IC	TL499ACPS
IC6	IC	PLL2001S
IC7	IC	TC9181P
IC8	IC	TD6128F
IC9	IC	NJM4558M
Q1	Transistor	RN1402
Q2	Transistor	2SC1645 B
Q3	Transistor	2SD1225M R
Q4	Transistor	RN1402
Q5	Transistor	DTB143ES
Q7	Transistor	TRF559
Q8	Transistor	2SC3779 D
Q9	Transistor	RN1402
Q10	Transistor	2SC3776 D
Q11	Transistor	RN1402
Q12	Transistor	DTB143ES
Q13	Transistor	2SC2407 (A)
Q14	Transistor	RN1402
Q15	Transistor	2SC3770 3
Q16	Transistor	RN1402
Q17	Transistor	2SC3770 3
Q18	FET	2SK184 Y
Q19	Transistor	2SC2712 Y
Q22	Transistor	2SA1162 Y
Q23	FET	2SK209 Y
Q24	Transistor	2SA1162 Y
Q25	Transistor	IMD6

[MAIN UNIT]

REF. NO.	DESCRIPTION	PART NO.
Q26	Transistor	IMD6
Q27	Transistor	RN1402
Q28	FET	2SJ106 GR
Q29	FET	2SJ106 GR
Q30	Transistor	2SC2712 Y
Q31	Transistor	DTB143ES
Q32	Transistor	2SB909M R
Q33	Transistor	RN1402
Q34	Transistor	DTB143ES
Q35	Transistor	RN1402
Q36	Transistor	RN1402
Q37	Transistor	2SC3661
Q40	Transistor	2SC3661
Q41	Transistor	2SC2712 BL
Q42	FET	2SK209 Y
Q43	Transistor	2SA1162 GR
Q44	Transistor	2SC2712 GR
Q45	Transistor	2SC2712 GR
Q46	Transistor	2SC2712 GR
D1	Diode	1SS184
D2	Diode	1SS184
D3	Diode	1SS193
D4	Diode	1SS193
D5	Diode	1SS133
D6	Diode	MA862
D7	Diode	1SS133
D8	Diode	MA862
D9	Diode	1SS193
D10	Diode	1SS193
D11	Diode	1SS193
D12	Diode	1SS193
D13	Diode	1SS193
D14	Diode	1SS193
D15	Zener	RD15E B2
D16	Diode	1SS193
D17	Zener	RD4.7M B2
D18	Diode	1SS193
X1	Crystal	RF4A3 FAA (3.579545 MHz)
X2	Crystal	CR-206 (12.8 MHz)
L2	Coil	FL5H 101K 100μ
L3	Coil	S0971136-101K 100μ
L4	Coil	LA-223
L5	Coil	LA-232
L6	Coil	LA-222
L7	Coil	LA-234
L8	Coil	LA-232
L9	Coil	LA-242
L10	Coil	LR-178
L11	Coil	LA-235
L12	Coil	LA-237
L13	Coil	LA-235
L14	Coil	LA-246
L15	Coil	LR-116
L16	Coil	LA-246
L17	Coil	LAL03NA 101K 100μ
L18	Coil	LAL03NA 101K 100μ
L19	Coil	LAL03NA 101K 100μ
R1	Resistor	1 kΩ MCR10
R2	Resistor	47 kΩ MCR10 FX
R3	Resistor	1 kΩ MCR10
R4	Resistor	47 kΩ MCR10 FX
R5	Resistor	22 kΩ MCR10 FX
R6	Resistor	100 Ω MCR10
R7	Trimmer	4.7 kΩ RH0621CS3J2NA
R8	Resistor	1.8 MΩ MCR10
R9	Resistor	1.2 MΩ MCR10
R10	Trimmer	100 kΩ RH0421C15J06A

[MAIN UNIT]

REF. NO.	DESCRIPTION	PART NO.	
R11	Resistor	10 kΩ	MCR10
R12	Trimmer	47 kΩ	RH0421CS4J08A
R13	Resistor	22 kΩ	MCR10
R14	Resistor	560 kΩ	MCR10
R15	Resistor	1.2 MΩ	MCR10
R16	Trimmer	10 kΩ	RH0421C14J0KA
R17	Resistor	18 kΩ	MCR10 FX
R18	Resistor	47 kΩ	MCR10 FX
R19	Resistor	1 kΩ	MCR10
R20	Resistor	22 kΩ	MCR10 FX
R21	Resistor	47 kΩ	MCR10 FX
R22	Resistor	1 kΩ	MCR10
R23	Resistor	33 kΩ	MCR10
R24	Trimmer	47 kΩ	RH0421CS4J08A
R25	Resistor	22 Ω	R20
R26	Resistor	470 Ω	MCR10
R27	Resistor	4.7 kΩ	MCR10
R28	Resistor	100 kΩ	MCR10
R29	Resistor	4.7 kΩ	MCR10
R30	Resistor	220 Ω	MCR10
R31	Resistor	4.7 Ω	R50X
R34	Resistor	47 Ω	R50X
R35	Resistor	150 Ω	MCR10
R36	Resistor	1 kΩ	MCR10
R37	Resistor	4.7 kΩ	MCR10
R38	Resistor	100 Ω	MCR10
R39	Resistor	5.6 kΩ	MCR10
R40	Resistor	1 kΩ	MCR10
R41	Resistor	2.2 kΩ	MCR10
R42	Resistor	470 Ω	MCR10
R43	Resistor	120 Ω	MCR10
R44	Resistor	56 Ω	MCR10
R45	Resistor	120 Ω	MCR10
R46	Resistor	4.7 kΩ	MCR10
R48	Resistor	6.8 kΩ	MCR10
R49	Resistor	1 kΩ	MCR10
R50	Resistor	150 Ω	MCR10
R51	Resistor	8.2 Ω	MCR10
R52	Resistor	8.2 Ω	MCR10
R53	Resistor	47 Ω	MCR10
R54	Resistor	100 Ω	MCR10
R55	Trimmer	10 kΩ	RH0421C14J0KA
R56	Trimmer	10 kΩ	RH0421C14J0KA
R57	Resistor	56 Ω	R25
R58	Resistor	1 kΩ	MCR10
R59	Resistor	100 Ω	MCR10
R60	Resistor	68 Ω	MCR10
R61	Resistor	100 Ω	MCR10
R62	Resistor	4.7 kΩ	MCR10
R63	Resistor	2.2 kΩ	MCR10
R64	Resistor	4.7 kΩ	MCR10
R65	Resistor	470 Ω	MCR10
R66	Resistor	100 Ω	MCR10
R68	Resistor	4.7 kΩ	MCR10
R69	Resistor	680 Ω	MCR10
R70	Resistor	47 Ω	MCR10
R71	Resistor	22 Ω	MCR10
R72	Resistor	22 Ω	MCR10
R73	Resistor	47 Ω	MCR10
R74	Resistor	680 Ω	MCR10
R75	Resistor	4.7 kΩ	MCR10
R76	Resistor	100 Ω	MCR10
R83	Resistor	6.8 kΩ	R20
R84	Resistor	2.2 kΩ	MCR10
R85	Resistor	560 Ω	MCR10
R86	Resistor	1 kΩ	MCR10
R87	Resistor	1.8 kΩ	MCR10
R88	Resistor	100 Ω	MCR10
R90	Resistor	15 kΩ	MCR10
R91	Resistor	270 kΩ	MCR10
R92	Resistor	100 kΩ	MCR10
R93	Resistor	120 kΩ	MCR10
R94	Resistor	270 kΩ	MCR10
R95	Resistor	1.8 kΩ	MCR10
R96	Resistor	1.8 kΩ	MCR10

[MAIN UNIT]

REF. NO.	DESCRIPTION	PART NO.	
R97	Resistor	3.9 kΩ	MCR10
R98	Resistor	10 Ω	MCR10
R99	Resistor	100 Ω	MCR10
R100	Resistor	82 kΩ	MCR10
R101	Resistor	68 kΩ	MCR10
R102	Resistor	68 kΩ	MCR10
R103	Resistor	150 kΩ	MCR10
R104	Resistor	150 kΩ	MCR10
R105	Resistor	22 kΩ	MCR10
R106	Resistor	47 kΩ	MCR10
R107	Resistor	47 kΩ	MCR10
R108	Resistor	10 kΩ	MCR10
R109	Trimmer	100 kΩ	RH0421C15J06A
R110	Resistor	1.5 kΩ	MCR10
R111	Resistor	10 kΩ	MCR10
R112	Resistor	12 kΩ	MCR10
R113	Resistor	100 Ω	MCR10
R114	Resistor	270 kΩ	MCR10
R115	Resistor	330 Ω	MCR10
R116	Resistor	220 kΩ	MCR10
R117	Resistor	100 Ω	MCR10
R118	Resistor	5.6 kΩ	MCR10
R119	Resistor	1 kΩ	MCR10
R120	Resistor	1.2 MΩ	MCR10
R121	Resistor	1 kΩ	MCR10
R122	Resistor	47 Ω	MCR10
R123	Resistor	47 kΩ	MCR10
R124	Resistor	47 Ω	MCR10
R125	Resistor	6.8 kΩ	MCR10
R126	Resistor	27 kΩ	MCR10
R127	Resistor	4.7 kΩ	MCR10
R128	Resistor	10 kΩ	MCR10
R129	Resistor	220 Ω	MCR10
R130	Resistor	2.2 kΩ	MCR10
R131	Resistor	5.6 kΩ	MCR10
R132	Resistor	56 kΩ	MCR10
R134	Resistor	5.6 kΩ	MCR10
R135	Resistor	100 Ω	R25
R136	Resistor	2.2 kΩ	MCR10
R137	Resistor	100 kΩ	MCR10
R138	Resistor	100 kΩ	MCR10
R139	Resistor	1 kΩ	MCR10
R140	Resistor	1 kΩ	MCR10
R141	Resistor	100 Ω	MCR10
R142	Resistor	18 kΩ	CRB25FX
R143	Resistor	270 Ω	MCR10
R144	Resistor	10 kΩ	MCR10
R145	Resistor	1 kΩ	MCR10
R146	Resistor	56 kΩ	MCR10
R147	Resistor	220 kΩ	MCR10
R148	Resistor	220 kΩ	MCR10
R149	Resistor	47 kΩ	MCR10
R150	Resistor	47 kΩ	MCR10
R151	Resistor	100 kΩ	MCR10
R152	Resistor	220 kΩ	MCR10
R153	Resistor	4.7 kΩ	MCR10
R154	Resistor	270 kΩ	MCR10
R155	Resistor	100 kΩ	MCR10
R156	Resistor	2.2 MΩ	MCR10
R157	Resistor	2.2 kΩ	R20
C1	Ceramic	0.001 μF	GRM40
C2	Ceramic	0.001 μF	GRM40
C3	Ceramic	0.001 μF	GRM40
C4	Ceramic	0.001 μF	GRM40
C5	Ceramic	0.001 μF	GRM40
C6	Ceramic	470 pF	GRM40
C7	Ceramic	0.001 μF	GRM40
C8	Ceramic	470 pF	GRM40
C9	Ceramic	0.001 μF	GRM40
C10	Ceramic	0.001 μF	GRM40
C11	Ceramic	0.001 μF	GRM40
C12	Ceramic	0.001 μF	GRM40
C13	Ceramic	0.001 μF	GRM40

[MAIN UNIT]

REF. NO.	DESCRIPTION	PART NO.
C14	Ceramic	0.001 μF GRM40
C15	Ceramic	0.001 μF GRM40
C16	Ceramic	470 pF GRM40
C17	Ceramic	0.001 μF GRM40
C18	Ceramic	470 pF GRM40
C19	Ceramic	0.001 μF GRM40
C20	Ceramic	0.001 μF GRM40
C21	Ceramic	0.001 μF GRM40
C22	Ceramic	0.001 μF GRM40
C23	Ceramic	0.001 μF GRM40
C24	Ceramic	0.001 μF GRM40
C25	Ceramic	0.01 μF GRM40 F
C26	Electrolytic	10 μF 16 V MS7
C27	Ceramic	0.001 μF GRM40
C28	Electrolytic	0.47 μF 50 V MS7
C29	Ceramic	39 pF GRM40
C30	Ceramic	39 pF GRM40
C31	Electrolytic	470 μF 10 V SS
C32	Ceramic	0.1 μF GRM40 F
C33	Electrolytic	100 μF 10 V SS
C34	Tantalum	0.1 μF 35 V DN
C35	Electrolytic	47 μF 50 V SS
C36	Ceramic	0.001 μF GRM40
C37	Electrolytic	10 μF 50 V SS
C38	Electrolytic	10 μF 50 V SS
C39	Ceramic	0.01 μF GRM40 F
C40	Ceramic	0.001 μF GRM40
C41	Ceramic	0.001 μF GRM40
C42	Electrolytic	10 μF 16 V SS
C43	Electrolytic	100 μF 16 V SS
C44	Ceramic	0.001 μF GRM40
C45	Ceramic	8 pF GRM40
C46	Ceramic	8 pF GRM40
C47	Ceramic	7 pF GRM40
C48	Ceramic	0.001 μF GRM40
C49	Ceramic	0.001 μF GRM40
C50	Ceramic	470 pF GRM40
C51	Ceramic	10 pF GRM40
C52	Ceramic	0.001 μF GRM40
C53	Ceramic	4 pF GRM40
C54	Ceramic	0.001 μF GRM40
C55	Ceramic	2 pF GRM40
C56	Ceramic	0.001 μF GRM40
C57	Ceramic	0.001 μF GRM40
C58	Ceramic	0.001 μF GRM40
C59	Ceramic	8 pF GRM40
C60	Ceramic	8 pF GRM40
C61	Ceramic	5 pF GRM40
C62	Electrolytic	47 μF 10 V SS
C63	Ceramic	0.001 μF GRM40
C64	Ceramic	0.001 μF GRM40
C65	Ceramic	0.001 μF GRM40
C66	Ceramic	3 pF GRM40
C67	Ceramic	22 pF GRM40
C68	Ceramic	22 pF GRM40
C69	Ceramic	15 pF GRM40
C70	Ceramic	0.001 μF GRM40
C71	Ceramic	0.001 μF GRM40
C72	Ceramic	0.001 μF GRM40
C73	Ceramic	0.001 μF GRM40
C74	Ceramic	22 pF GRM40
C75	Ceramic	0.001 μF GRM40
C76	Ceramic	39 pF GRM40
C77	Ceramic	39 pF GRM40
C78	Ceramic	22 pF GRM40
C79	Ceramic	0.001 μF GRM40
C80	Ceramic	22 pF GRM40
C81	Ceramic	0.001 μF GRM40
C82	Ceramic	22 pF GRM40
C83	Ceramic	0.001 μF GRM40
C84	Cylinder	22 pF UP125SL 220J-NA
C87	Tantalum	0.22 μF 35 V DN
C88	Ceramic	470 pF GRM40
C89	Electrolytic	4.7 μF 25 V MS7
C90	Electrolytic	4.7 μF 25 V MS7

[MAIN UNIT]

REF. NO.	DESCRIPTION	PART NO.
C91	Ceramic	470 pF GRM40
C96	Ceramic	0.1 μF GRM40 F
C97	Tantalum	4.7 μF 35 V DN
C98	Ceramic	0.1 μF GRM40 F
C99	Ceramic	470 pF GRM40
C100	Electrolytic	10 μF 16 V SS
C101	Ceramic	0.01 μF GRM40 F
C102	Trimmer	10 pF ECRGA010A30
C103	Ceramic	27 pF GRM40 CH
C104	Ceramic	0.001 μF GRM40
C105	Ceramic	0.001 μF GRM40
C106	Cylinder	0.001 μF UP125B 102K-NA
C107	Electrolytic	1 μF 50 V MS7
C108	Ceramic	0.01 μF GRM40 F
C109	Electrolytic	10 μF 16 V MS7
C110	Cylinder	0.001 μF UP125B 102K-NA
C111	Ceramic	0.001 μF GRM40
C112	Ceramic	0.001 μF GRM40
C113	Electrolytic	4.7 μF 25 V MS7
C114	Ceramic	0.0022 μF GRM40
C115	Ceramic	120 pF GRM40
C116	Ceramic	0.001 μF GRM40
C117	Ceramic	470 pF GRM40
C118	Electrolytic	1 μF 50 V MS7
C119	Electrolytic	1 μF 50 V MS7
C120	Electrolytic	0.22 μF 50 V MS5
C121	Ceramic	470 pF GRM40
C122	Ceramic	0.001 μF GRM40
C123	Electrolytic	10 μF 16 V MS7
C124	Ceramic	470 pF GRM40
C125	Electrolytic	100 μF 10 V SS
C126	Ceramic	470 pF GRM40
C127	Ceramic	0.01 μF GRM40 F
C128	Barrier Layer	0.01 μF 25 V
C129	Ceramic	470 pF 50 V
C130	Ceramic	0.001 μF GRM40
C131	Ceramic	0.001 μF GRM40
C132	Electrolytic	10 μF 16 V MS7
C133	Ceramic	0.1 μF GRM40 F
C134	Electrolytic	10 μF 16 V SS
C135	Ceramic	0.1 μF GRM40 F
C136	Ceramic	0.001 μF GRM40
C137	Ceramic	0.001 μF GRM40
C138	Electrolytic	100 μF 10 V SS
C139	Ceramic	0.1 μF GRM40 F
C140	Electrolytic	33 μF 35 V SS
C141	Ceramic	0.1 μF GRM40 F
C142	Electrolytic	100 μF 25 V SS
C143	Tantalum	33 μF 10 V SV
C144	Ceramic	470 pF GRM40
C145	Electrolytic	1 μF 50 V MS7
C146	Electrolytic	100 μF 10 V SS
C147	Ceramic	0.001 μF GRM40
C148	Electrolytic	4.7 μF 25 V MS7
C149	Electrolytic	4.7 μF 25 V MS7
C150	Electrolytic	470 μF 10 V SS
C151	Ceramic	470 pF GRM40
C152	Electrolytic	100 μF 10 V SS
C153	Ceramic	120 pF GRM40
C154	Ceramic	120 pF GRM40
C155	Ceramic	470 pF GRM40
C156	Ceramic	470 pF GRM40
C157	Ceramic	120 pF GRM40
C158	Ceramic	120 pF GRM40
C159	Ceramic	470 pF GRM40
C160	Ceramic	120 pF GRM40
C161	Ceramic	120 pF GRM40
C162	Ceramic	120 pF GRM40
C163	Ceramic	120 pF GRM40
C164	Ceramic	120 pF GRM40
C165	Ceramic	120 pF GRM40
C166	Ceramic	120 pF GRM40
C167	Ceramic	120 pF GRM40
C168	Ceramic	120 pF GRM40
C169	Ceramic	120 pF GRM40

[MAIN UNIT]

REF. NO.	DESCRIPTION	PART NO.
C170	Ceramic	120 pF GRM40
C171	Ceramic	120 pF GRM40
C172	Ceramic	120 pF GRM40
C173	Ceramic	120 pF GRM40
C175	Ceramic	120 pF GRM40
C176	Ceramic	120 pF GRM40
C177	Ceramic	120 pF GRM40
C178	Ceramic	120 pF GRM40
C179	Ceramic	120 pF GRM40
C180	Ceramic	120 pF GRM40
C181	Ceramic	120 pF GRM40
C182	Ceramic	120 pF GRM40
C183	Ceramic	47 pF GRM40
C184	Ceramic	0.01 μF GRM40 F
C185	Ceramic	56 pF GRM40 CH
C186	Ceramic	120 pF GRM40 CH
C187	Ceramic	100 pF GRM40
C188	Ceramic	100 pF GRM40
C189	Ceramic	100 pF GRM40
C190	Ceramic	100 pF GRM40
C191	Ceramic	18 pF 50 V
C192	Ceramic	27 pF GRM40
C193	Tantalum	2.2 μF 35 V DN
C194	Tantalum	10 μF 35 V DN
C195	Tantalum	10 μF 35 V DN
C196	Electrolytic	4.7 μF 25 V MS7
C197	Tantalum	0.1 μF 35 V SV
J1	Connector	B05B-EH-S
J2	Connector	B13B-EH-S
J3	Connector	SB15P-HVQ-24
J4	Connector	TXL-P06P-C1
J5	Connector	B06B-EH-S
J6	Connector	B03B-EH-S
J7	Connector	TMP-J01X-A2
J8	Connector	TMP-J01X-A2
P1	Connector	TMP-P01X-A1
P2	Connector	TMP-P01X-A1
EP1	P.C. Board	B-1869

[RX UNIT]

REF. NO.	DESCRIPTION	PART NO.
IC1	IC	TK10420
IC2	IC	NJM4558D
IC3	IC	μPC1241H
IC4	IC	AN6541
IC5	IC	TA78L005AP
IC6	IC	μPD4094BC
Q1	FET	2SK241 Y
Q2	Transistor	RN1204
Q3	FET	3SK174 L or M
Q4	FET	3SK174 L or M
Q5	Transistor	RN1204
Q6	FET	3SK174 L or M
Q7	FET	2SK125
Q8	FET	3SK121 Y
Q9	Transistor	2SC2458 GR
Q10	Transistor	2SC2458 GR
Q11	Transistor	2SC3776 D
Q12	Transistor	2SC3776 D

[RX UNIT]

REF. NO.	DESCRIPTION	PART NO.
Q13	Transistor	2SC2458 GR
Q14	FET	2SJ105 GR
Q15	Transistor	RN2204
Q16	Transistor	2SA1048 GR
Q17	Transistor	RN1204
Q18	Transistor	DTB143ES
Q19	Transistor	RN1204
Q20	Transistor	RN1204
Q21	Transistor	RN2204
Q22	Transistor	RN1204
Q23	Transistor	DTB143ES
Q24	Transistor	RN1204
Q25	Transistor	RN2204
Q26	Transistor	RN1204
Q27	Transistor	RN1204
D1	Diode	1SS97
D2	Diode	1SS97
D4	Varicap	1SV50E
D5	Varicap	1SV50E
D6	Varicap	1SV50E
D7	Varicap	1SV50E
D8	Diode	1SS265
D9	Diode	1SS133
D10	Diode	1SS265
D11	Diode	1SS265
D12	Zener	RD6.2E B2
D13	Diode	1S953
D14	Diode	1S953
D15	Diode	1SS265
D16	Diode	1SS265
D17	Diode	1S953
D18	Diode	1S953
D19	Diode	1SS133
D20	Diode	1SS265
D21	Diode	1SS133
D22	Diode	1SS133
D23	Diode	1SS133
D24	Diode	1SS133
D25	Zener	RD6.2E B2
D26	Diode	1SS133
D27	Diode	1SS133
D28	Diode	1SS133
D29	Diode	1SS133
D30	Diode	1SS133
D31	Diode	1S953
F11	Crystal	30M15B
F12	Ceramic	CFW455 E
X1	Crystal	CR-125 (30.42 MHz)
X2	Discriminator	CDB455C7A
L1	Coil	LS-181
L2	Coil	LS-181
L3	Coil	LS-300
L4	Coil	LAL02KR R22M 0.22μ
L5	Coil	LS-291
L6	Coil	LS-291
L7	Coil	LS-291
L8	Coil	LS-291
L9	Coil	LA-232
L10	Coil	LA-222
L11	Coil	7HW-252MX-1550A
L12	Coil	LW-25
L13	Coil	7HW-252MX-1550A
L14	Coil	LW-25
L15	Coil	LA-159
L16	Coil	LAL02KR R22M 0.22μ
L17	Coil	LA-224
L18	Coil	LA-223

[RX UNIT]

REF. NO.	DESCRIPTION	PART NO.
L19	Coil	LA-222
L20	Coil	LA-224
R1	Resistor	10 kΩ ELR20
R2	Resistor	1 kΩ ELR20
R3	Resistor	100 Ω ELR20
R4	Resistor	10 Ω R20
R5	Resistor	100 Ω ELR20
R6	Resistor	270 Ω R20
R7	Resistor	820 Ω ELR20
R8	Resistor	1 kΩ R20
R12	Resistor	3.3 kΩ ELR20
R13	Resistor	100 kΩ ELR20
R14	Resistor	100 kΩ ELR20
R15	Resistor	100 kΩ R20
R16	Resistor	47 Ω ELR20
R17	Resistor	22 Ω R20
R18	Resistor	82 Ω ELR20
R19	Resistor	10 kΩ ELR20
R20	Resistor	47 kΩ ELR20
R21	Resistor	10 kΩ ELR20
R22	Resistor	100 kΩ ELR20
R23	Resistor	220 Ω ELR20
R24	Resistor	470 Ω ELR20
R25	Resistor	10 kΩ ELR20
R26	Resistor	10 kΩ ELR20
R27	Resistor	6.8 kΩ ELR20
R28	Resistor	1 kΩ ELR20
R29	Resistor	22 Ω ELR20
R30	Resistor	1 kΩ ELR20
R31	Resistor	47 Ω R20
R32	Resistor	100 Ω ELR20
R33	Resistor	82 Ω ELR20
R34	Resistor	33 kΩ ELR20
R35	Resistor	100 kΩ ELR20
R36	Resistor	1 kΩ ELR20
R37	Resistor	3.3 kΩ R20
R38	Resistor	4.7 kΩ R20
R39	Resistor	100 Ω R20
R40	Resistor	1.5 kΩ ELR20
R41	Resistor	1.5 kΩ ELR20
R42	Resistor	1.5 kΩ ELR20
R43	Resistor	47 kΩ ELR20
R44	Resistor	22 kΩ ELR20
R45	Resistor	100 kΩ ELR20
R46	Resistor	100 kΩ ELR20
R47	Resistor	5.6 kΩ ELR20
R48	Resistor	330 kΩ ELR20
R49	Resistor	100 Ω R20
R50	Resistor	180 kΩ ELR20
R51	Resistor	47 kΩ ELR20
R52	Trimmer	10 kΩ RH0421C14J0KA
R53	Trimmer	10 kΩ RH0421C14J0KA
R54	Resistor	2.7 kΩ ELR20
R55	Resistor	39 kΩ R20
R56	Resistor	39 kΩ ELR20
R57	Resistor	22 kΩ ELR20
R58	Resistor	39 kΩ ELR20
R59	Resistor	47 kΩ ELR20
R60	Resistor	100 kΩ ELR20
R61	Resistor	2.7 kΩ ELR20
R62	Resistor	1 kΩ ELR20
R63	Resistor	1 kΩ ELR20
R64	Resistor	220 Ω R20
R65	Resistor	470 Ω ELR20
R66	Resistor	47 Ω R20
R67	Resistor	100 kΩ ELR20
R68	Resistor	47 Ω ELR20
R69	Resistor	470 Ω ELR20
R70	Resistor	47 Ω R20
R71	Resistor	56 kΩ ELR20
R72	Resistor	1 kΩ R20
R73	Resistor	470 Ω ELR20
R74	Resistor	470 Ω R20

[RX UNIT]

REF. NO.	DESCRIPTION	PART NO.
R75	Resistor	470 Ω ELR20
R76	Resistor	470 Ω ELR20
R77	Resistor	27 kΩ ELR20
R78	Resistor	27 kΩ ELR20
R79	Resistor	5.6 kΩ ELR20
R80	Resistor	1.2 MΩ ELR20
R81	Resistor	1.2 MΩ ELR20
R82	Resistor	12 kΩ R20
R83	Resistor	12 kΩ ELR20
R84	Resistor	2.7 kΩ ELR20
R85	Resistor	4.7 kΩ ELR20
R86	Resistor	10 kΩ ELR20
R87	Resistor	100 kΩ ELR20
R88	Resistor	4.7 kΩ ELR20
R89	Resistor	470 kΩ R20
R90	Resistor	100 Ω R20
R91	Resistor	220 kΩ R20
R92	Resistor	10 kΩ ELR20
R93	Resistor	10 kΩ R20
R94	Resistor	3.3 Ω ELR20
R95	Resistor	1 kΩ ELR20
R96	Resistor	2.2 Ω ELR20
R97	Resistor	1 Ω R20
R98	Resistor	1 Ω R20
R99	Resistor	1 Ω R20
R100	Resistor	3.3 Ω R50X
R101	Resistor	39 kΩ ELR20
R102	Resistor	100 kΩ ELR20
C1	Ceramic	0.001 μF 50 V
C2	Ceramic	18 pF 50 V TH
C3	Barrier Layer	0.01 μF 25 V
C4	Ceramic	27 pF 50 V
C5	Ceramic	12 pF 50 V
C7	Ceramic	0.001 μF 50 V
C8	Electrolytic	1 μF 50 V SS
C10	Barrier Layer	0.01 μF 25 V
C11	Ceramic	12 pF 50 V
C12	Barrier Layer	0.01 μF 25 V
C13	Ceramic	0.001 μF 50 V
C14	Ceramic	0.001 μF 50 V
C15	Ceramic	0.001 μF 50 V
C16	Electrolytic	1 μF 50 V MS7
C17	Ceramic	0.001 μF 50 V
C18	Ceramic	7 pF 50 V
C19	Ceramic	0.001 μF 50 V
C20	Ceramic	1 pF 50 V
C21	Ceramic	0.001 μF 50 V
C24	Ceramic	0.35 pF 50 V
C25	Ceramic	2 pF 50 V
C26	Ceramic	12 pF 50 V
C27	Ceramic	0.35 pF 50 V
C28	Ceramic	0.001 μF 50 V
C29	Ceramic	1 pF 50 V
C30	Ceramic	12 pF 50 V
C32	Ceramic	0.35 pF 50 V
C33	Ceramic	10 pF 50 V
C34	Ceramic	1 pF 50 V
C35	Ceramic	0.001 μF 50 V
C36	Ceramic	0.001 μF 50 V
C37	Ceramic	0.001 μF 50 V
C38	Ceramic	0.001 μF 50 V
C39	Ceramic	0.001 μF 50 V
C40	Ceramic	68 pF 50 V
C41	Ceramic	22 pF 50 V
C42	Ceramic	0.5 pF 50 V
C43	Ceramic	6 pF 50 V
C44	Ceramic	0.001 μF 50 V
C45	Ceramic	0.001 μF 50 V
C46	Ceramic	0.001 μF 50 V
C47	Ceramic	12 pF 50 V
C48	Trimmer	6 pF ECRGA006A30
C49	Ceramic	470 pF 50 V
C50	Ceramic	1 pF 50 V

[VHF VCO UNIT]

REF. NO.	DESCRIPTION	PART NO.	
R1	Resistor	470 Ω	ELR20
R2	Resistor	2.7 kΩ	ELR20
R3	Resistor	470 Ω	ELR20
R4	Resistor	47 Ω	ELR20
R5	Resistor	47 Ω	ELR20
R6	Resistor	100 Ω	ELR20
R7	Resistor	4.7 kΩ	ELR20
R8	Resistor	680 Ω	ELR20
R9	Resistor	47 Ω	ELR20
R10	Resistor	220 Ω	ELR20
C1	Ceramic	470 pF	50 V
C2	Ceramic	470 pF	50 V
C3	Ceramic	0.001 μF	50 V
C4	Ceramic	1 pF	50 V
C5	Ceramic	0.001 μF	50 V
C6	Ceramic	1 pF	50 V
C7	Ceramic	470 pF	50 V
C8	Ceramic	100 pF	50 V
C9	Ceramic	470 pF	50 V
C10	Electrolytic	33 μF	10 V MS5
EP1	P.C. Board	B-1303	

[UHF VCO UNIT]

REF. NO.	DESCRIPTION	PART NO.	
Q1	FET	2SK125	
Q2	Transistor	2SC3775 3	
D1	Varicap	1SV166T 2B	
D2	Varicap	1SV166T 2B	
D3	Varicap	1T25	
L1	Coil	LAL02NA 1R0M 1μ	
L2	Coil	LAL02NA R33M 0.33μ	
L3	Coil	LAL02NA R33M 0.33μ	
L4	Coil	LAL02NA R22M 0.22μ	
L5	Coil	LA-233	
R1	Resistor	47 kΩ	R20
R2	Resistor	270 Ω	MCR10
R3	Resistor	47 kΩ	MCR10
R4	Resistor	10 Ω	MCR10
R5	Resistor	47 Ω	MCR10
R6	Resistor	22 Ω	MCR10
R7	Resistor	100 Ω	MCR10
R8	Resistor	3.3 kΩ	MCR10
R9	Resistor	2.2 kΩ	MCR10
R10	Resistor	220 Ω	MCR10
C1	Ceramic	56 pF	50 V
C2	Ceramic	0.75 pF	GRM40 CK
C3	Ceramic	470 pF	GRM40
C4	Ceramic	7 pF	GRM40 UJ
C5	Ceramic	470 pF	GRM40 F
C6	Ceramic	0.1 μF	GRM40 F
C7	Electrolytic	47 μF	10 V MS5
C8	Ceramic	0.001 μF	GRM40
C9	Ceramic	470 pF	GRM40
C10	Electrolytic	47 μF	10 V MS5
C11	Ceramic	0.001 μF	GRM40

[UHF VCO UNIT]

REF. NO.	DESCRIPTION	PART NO.	
C12	Ceramic	6 pF	GRM40 UJ
C13	Ceramic	0.5 pF	GRM40
C14	Ceramic	470 pF	GRM40
C15	Ceramic	0.001 μF	GRM40
C16	Ceramic	0.001 μF	GRM40
C17	Ceramic	4 pF	50 V
C18	Ceramic	47 pF	50 V
EP1	P.C. Board	B-1734	

[VHF PA UNIT]

REF. NO.	DESCRIPTION	PART NO.	
IC1	IC	SC-1019	
Q1	Transistor	2SA1359 Y	
Q2	Transistor	2SA1345	
D1	Diode	15CD11	
D2	Diode	MI407	
D3	Diode	1SS99	
D4	Diode	MI407	
L1	Coil	LW-25	
L2	Coil	LA-244	
L3	Coil	LA-244	
L4	Coil	LA-254	
L5	Coil	LW-19	
L6	Coil	LA-235	
L7	Coil	LA-238	
R1	Resistor	0.15 Ω	RGB2L-R15
R2	Resistor	100 Ω	R50X
R3	Resistor	470 Ω	ELR20
R4	Resistor	100 kΩ	R20
R5	Resistor	10 kΩ	ELR20
C1	Ceramic	0.001 μF	50V
C2	Ceramic	0.001 μF	50V
C3	Ceramic	0.001 μF	50V
C4	Ceramic	0.001 μF	50 V
C5	Electrolytic	10 μF	16 V MS7
C6	Ceramic	0.001 μF	50 V
C7	Tantalum	10 μF	35 V DN
C8	Ceramic	0.001 μF	50 V
C9	Ceramic	0.5 pF	50 V
C10	Ceramic	22 pF	500 V
C11	Ceramic	0.001 μF	500 V
C12	Ceramic	18 pF	500 V
C13	Ceramic	39 pF	500 V
C14	Ceramic	39 pF	500 V
C15	Ceramic	15 pF	500 V
C16	Ceramic	0.001 μF	50 V
C17	Ceramic	20 pF	50 V
C18	Ceramic	100 pF	500 V
C49	Ceramic	0.001 μF	50 V
C50	Ceramic	0.001 μF	500 V
C53	Electrolytic	220 μF	16 V SS
J1	Connector	SJ-296	
J2	Connector	RT-01T-1.0B	

[VHF PA UNIT]

REF. NO.	DESCRIPTION	PART NO.
J3	Connector	RT-01T-1.0B
J4	Connector	RT-01T-1.0B
J5	Connector	RT-01T-1.0B
J6	Connector	RT-01T-1.0B
J7	Connector	RT-01T-1.0B
P1	Connector	EHR-06
P2	Connector	EHR-05
P4	Connector	TMP-P01X-A1
P5	Connector	TMP-P01X-A1
EP1	P.C. Board	B-944D

[UHF PA UNIT]

REF. NO.	DESCRIPTION	PART NO.
IC2	IC	SC-1027
Q3	Transistor	2SA1359 Y
Q4	Transistor	2SA1345
D5	Diode	MI407
D6	Diode	1SS99
D7	Diode	MI407
L8	Coil	LA-136
L9	Coil	LA-120
L10	Coil	LA-242
L11	Coil	LA-232
L12	Coil	LA-232
L13	Coil	LA-232
L14	Coil	LA-232
L15	Coil	LA-242
R6	Resistor	0.15 Ω RGB2L-R15
R7	Resistor	100 Ω R50X
R8	Resistor	470 Ω ELR20
R9	Resistor	100 kΩ R20
R10	Resistor	10 kΩ R20
R11	Resistor	0.15 Ω RGB2L-R15
R12	Resistor	150 Ω R25
C19	Ceramic	0.001 μF 50 V
C20	Ceramic	0.001 μF 50 V
C21	Ceramic	0.001 μF 50 V
C22	Ceramic	0.001 μF 50 V
C23	Electrolytic	10 μF 16 V MS7
C24	Ceramic	47 pF 50 V
C25	Ceramic	2 pF 500 V
C26	Ceramic	2 pF 500 V
C27	Ceramic	0.5 pF 50 V
C28	Ceramic	0.001 μF 50 V
C29	Electrolytic	220 μF 16 V SS
C30	Ceramic	2 pF 500 V
C31	Ceramic	39 pF 500 V
C32	Ceramic	6 pF 500 V
C33	Ceramic	10 pF 500 V
C34	Ceramic	6 pF 500 V
C35	Ceramic	6 pF 500 V
C36	Ceramic	4 pF 500 V
C37	Ceramic	6 pF 500 V

[UHF PA UNIT]

REF. NO.	DESCRIPTION	PART NO.
C38	Ceramic	4 pF 500 V
C39	Ceramic	5 pF 50 V
C40	Ceramic	20 pF 50 V
C41	Ceramic	20 pF 50 V
C42	Feed Through	0.0033 μF TF240-602-332Z
C43	Feed Through	0.0033 μF TF240-602-332Z
C44	Feed Through	0.0033 μF TF240-602-332Z
C45	Feed Through	0.0033 μF TF240-602-332Z
C46	Feed Through	0.0033 μF TF240-602-332Z
C47	Feed Through	0.0033 μF TF240-602-332Z
C48	Ceramic	0.001 μF 50 V
J8	Connector	RT-01T-1.0B
J9	Connector	RT-01T-1.0B
J10	Connector	RT-01T-1.0B
J11	Connector	RT-01T-1.0B
J12	Connector	RT-01T-1.0B
J13	Connector	RT-01T-1.0B
J14	Connector	RT-01T-1.0B
P3	Connector	TXL-P06H-A1
P6	Connector	TMP-P01X-A1
P7	Connector	TMP-P01X-A1
EP2	P.C. Board	B-945C

SECTION 9 OPTIONAL UNITS

9-1 UT-40 TONE SQUELCH UNIT CIRCUIT DESCRIPTION

9-1-1 GENERAL DESCRIPTION

IC1 is a tone encoder/decoder IC chip that outputs and detects 37 different kinds of tones. A tone is set by serial data from IC1 on the LOGIC UNIT in the IC-3210A/E DUAL BAND FM TRANSCEIVER.

IC2 functions as a serial/parallel converter, applying 6-bit parallel data to IC1. The following table shows the relation between frequency and input data in IC1.

OUTPUT FREQUENCY [Hz]	IC1 INPUT PIN NUMBER						OUTPUT FREQUENCY [Hz]	IC1 INPUT PIN NUMBER						OUTPUT FREQUENCY [Hz]	IC1 INPUT PIN NUMBER					
	3	4	5	6	7	8		3	4	5	6	7	8		3	4	5	6	7	8
67.0	H	L	H	H	H	L	110.9	H	L	H	L	H	H	173.8	L	L	L	H	L	H
71.9	L	L	H	H	H	L	114.8	L	L	H	L	H	H	179.9	H	H	H	L	L	H
74.4	H	H	L	H	H	L	118.8	H	H	L	L	H	H	186.2	L	H	H	L	L	H
77.0	L	H	L	H	H	L	123.0	L	H	L	L	H	H	192.8	H	L	H	L	L	H
79.7	H	L	L	H	H	L	127.3	H	L	L	L	H	H	203.5	L	L	H	L	L	H
82.5	L	L	L	H	H	L	131.8	L	L	L	L	H	H	210.7	H	H	L	L	L	H
85.4	H	H	H	L	H	L	136.5	H	H	H	H	L	H	218.1	L	H	L	L	L	H
88.5	L	H	H	L	H	L	141.3	L	H	H	H	L	H	225.7	H	L	L	L	L	H
91.5	H	L	H	L	H	L	146.2	H	L	H	H	L	H	233.6	L	L	L	L	L	H
94.8	H	L	L	H	H	H	151.4	L	L	H	H	L	H	241.8	H	H	H	H	H	L
100.0	L	L	L	H	H	H	156.7	H	H	L	H	L	H	250.3	L	H	H	H	H	L
103.5	H	H	H	L	H	H	162.2	L	H	L	H	L	H	—	—	—	—	—	—	—
107.2	L	H	H	L	H	H	167.9	H	L	L	H	L	H	—	—	—	—	—	—	—

H: HIGH L: LOW

9-1-2 ENCODER CIRCUIT

Pin 26 in IC1 outputs a programmed tone frequency when pin 12 in IC1 becomes "L."

Q4 functions as a buffer amplifier. The collector of Q4 outputs the tone signal and the signal is applied to the VCO circuit to be modulated.

Tone deviation can be adjusted by R10.

9-1-3 DECODER CIRCUIT

Detected signals from pin 9 in IC1 on the RX UNIT of the IC-3210A/E are applied to pin 29 in IC1 on the UT-40 through the DETO line. When the signals have a tone modulated and the tone is matched with the programmed tone frequency by IC2, pin 23 in IC1 changes from "LOW" to "HIGH."

- When the tone squelch function is turned OFF:

Both pins 11 and 12 in IC2 are "HIGH" and +5 V are not applied to IC1. Q2 and Q3 turn OFF and the TSQL line is "HIGH."

- When the tone squelch function is turned ON:

Pin 11 of IC2 is "HIGH" and pin 12 of IC2 is "LOW." Both Q2 and Q3 turn ON.

When the received tone frequency is not matched with the programmed tone frequency, pin 23 of IC1 is "LOW" and the TSQL line is "LOW."

When the received tone frequency is matched with the programmed tone, pin 23 becomes "HIGH" and the TSQL line becomes "HIGH."

9-2 UT-40 VOLTAGE/CIRCUIT DIAGRAM

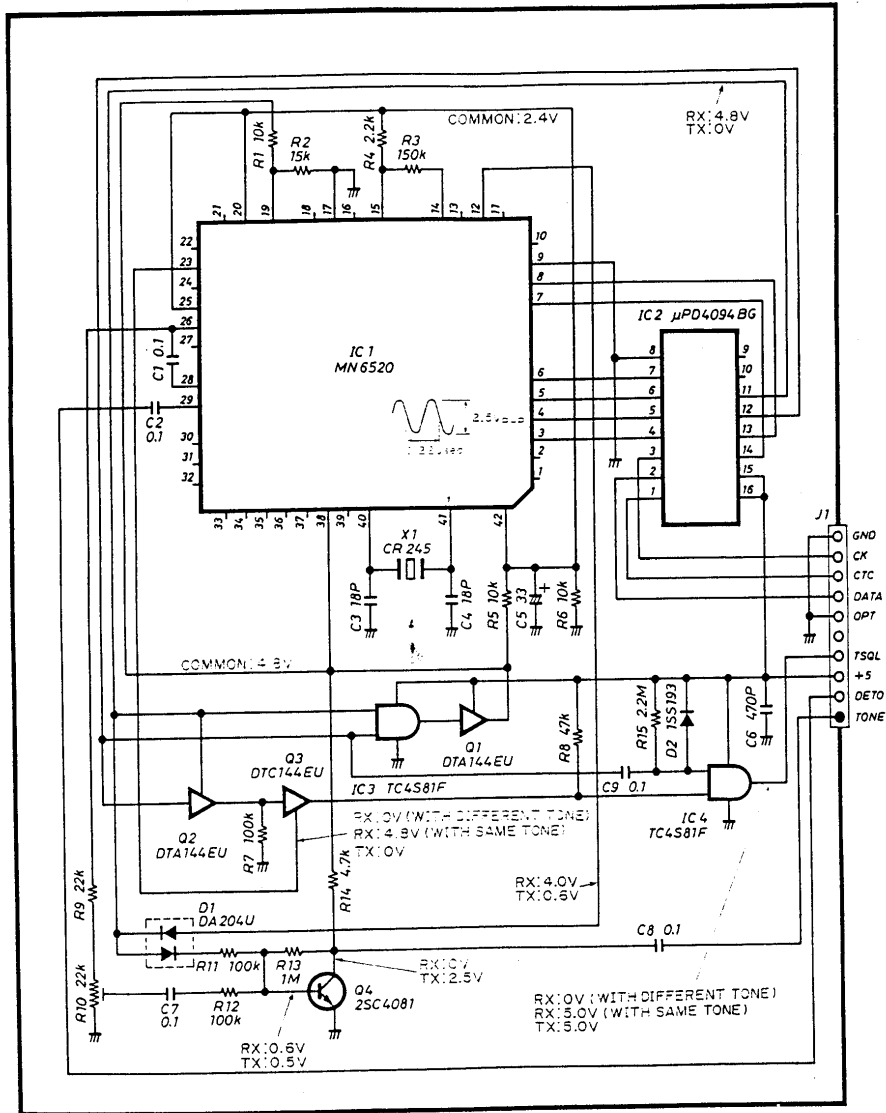



9-3 UT-40 BOARD LAYOUTS

COMPONENT SIDE

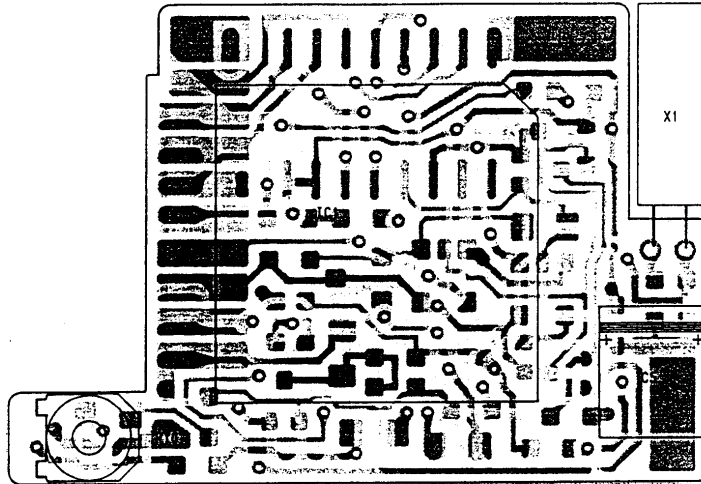

FOIL SIDE

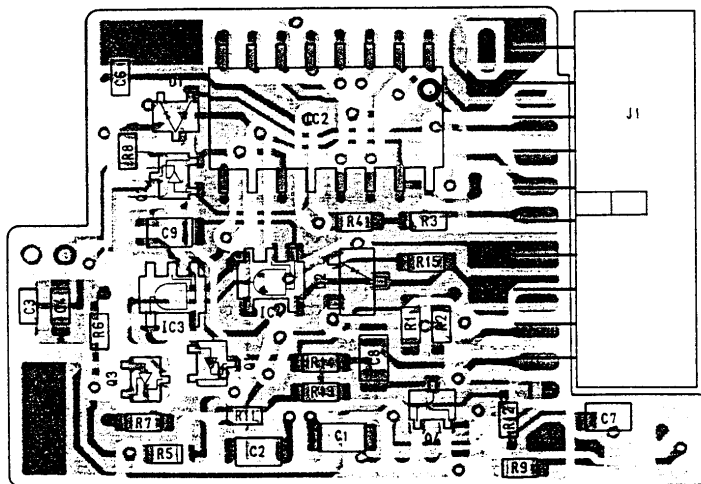

9-4 UT-40 BLOCK DIAGRAM

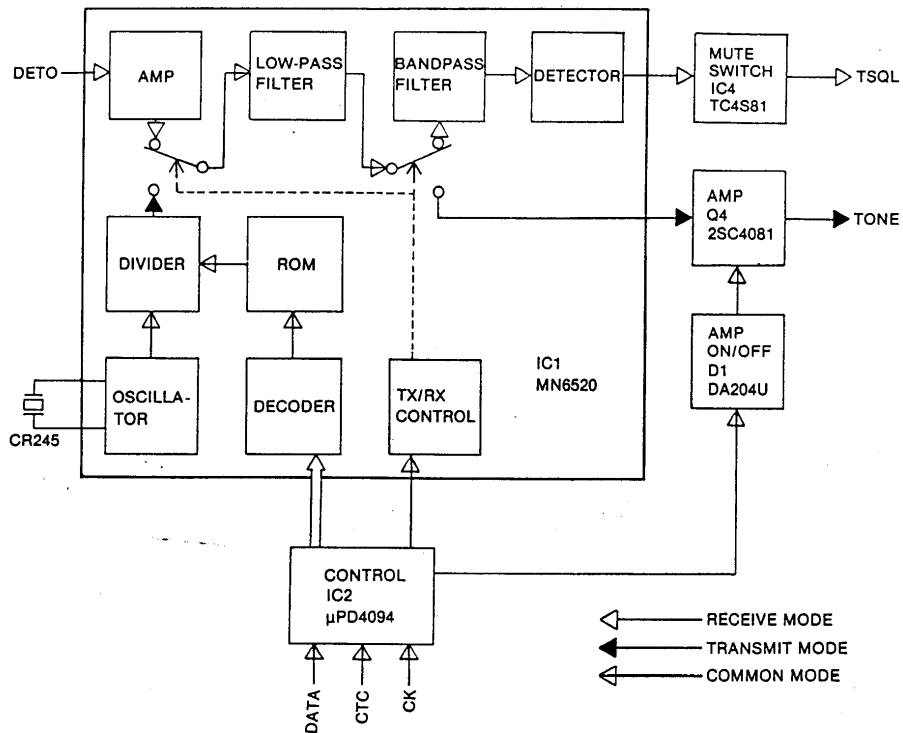

9-5 UT-40 PARTS LIST

[T. SQL UNIT]

REF. NO.	DESCRIPTION	PART NO.
IC1	IC	MN6520
IC2	IC	μPD4094BG
IC3	IC	TC4S81F
IC4	IC	TC4S81F
Q1	Transistor	DTA144EU
Q2	Transistor	DTA144EU
Q3	Transistor	DTC144EU
Q4	Transistor	2SC4081 R
D1	Diode	DA204U
D2	Diode	1SS193
X1	Crystal	CR245
R1	Resistor	10 kΩ MCR03 EZH J
R2	Resistor	15 kΩ MCR03 EZH J
R3	Resistor	150 kΩ MCR03 EZH J
R4	Resistor	2.2 kΩ MCR03 EZH J
R5	Resistor	10 kΩ MCR03 EZH J
R6	Resistor	10 kΩ MCR03 EZH J
R7	Resistor	100 kΩ MCR03 EZH J
R8	Resistor	47 kΩ MCR03 EZH J

REF. NO.	DESCRIPTION	PART NO.
R9	Resistor	22 kΩ MCR03 EZH J
R10	Trimmer	22 kΩ RH04A3AJ4J
R11	Resistor	100 kΩ MCR03 EZH J
R12	Resistor	100 kΩ MCR03 EZH J
R13	Resistor	1 MΩ MCR03 EZH J
R14	Resistor	4.7 kΩ MCR03 EZH J
R15	Resistor	2.2 MΩ MCR03 EZH J
C1	Ceramic	0.1 μF GRM40 F
C2	Ceramic	0.1 μF GRM40 F
C3	Ceramic	50 μF GRM39 SL 180J
C4	Ceramic	50 μF GRM39 SL 180J
C5	Tantalum	33 μF TESVCOG336M12L
C6	Ceramic	50 μF GRM39 B 471K
C7	Ceramic	0.1 μF GRM40 F
C8	Ceramic	0.1 μF GRM40 F
C9	Ceramic	0.1 μF GRM40 F
J1	Connector	PI28A10M
EP1	P.C. Board	B-1577C