

ICOM

INSTRUCTION MANUAL

TRIBAND FM TRANSCEIVER

IC-4100H

Downloaded by
RadioAmateur.EU

This device complies with Part 15 of the FCC Rules. Operation is subject to the following two conditions: (1) This device may not cause harmful interference, and (2) this device must accept any interference received, including interference that may cause undesired operation.



Icom Inc.

IMPORTANT

READ ALL INSTRUCTIONS carefully and completely before using the transceiver.

SAVE THIS INSTRUCTION MANUAL – This instruction manual contains important safety and operating instructions for the IC-Δ100H.

FOREWORD

Thank you for choosing this Icom product.

The IC-Δ100H is a compact, easy-to-operate, multi-function transceiver designed using Icom's state-of-the-art technology. It is operational on 3 bands: 144, 430(440) and 1200 MHz.

NOTE: See "Unpacking" on p. 79 for included accessories.

CAUTIONS

NEVER connect the transceiver to an AC outlet or to a power source of more than 16 V DC. These connections will ruin the transceiver.

NEVER connect the transceiver to a power source using reverse polarity. This connection will ruin the transceiver.

NEVER place the transceiver where normal operation of the vehicle may be hindered or where it could cause bodily injury.

NEVER allow children to touch the transceiver.

DO NOT use or place the transceiver in areas with temperatures below -10°C ($+14^{\circ}\text{F}$) or over $+60^{\circ}\text{C}$ ($+140^{\circ}\text{F}$) or, in areas subject to direct sunlight, such as the dashboard.

AVOID the use of chemical agents such as benzine or alcohol when cleaning, as they can damage the transceiver surfaces.

BE CAREFUL! The transceiver will become hot when operating the transceiver continuously for long periods.

TABLE OF CONTENTS

1 PANEL DESCRIPTION	1-3	<input type="checkbox"/> Crossband double duplex	32	<input type="checkbox"/> Transmitting a DTMF code	58
<input type="checkbox"/> Front panel (remote controller)	1	<input type="checkbox"/> One-touch PTT function	32	12 AFC, RIT AND VFO FUNCTIONS	57-58
<input type="checkbox"/> Function display	3	3 REPEATER OPERATION	33-35	<input type="checkbox"/> Selecting RIT/VFO types	57
<input type="checkbox"/> Rear panel	5	<input type="checkbox"/> Operation	33	<input type="checkbox"/> AFC function	59
<input type="checkbox"/> Microphone	6	<input type="checkbox"/> Tone information	34	<input type="checkbox"/> RIT/VFO functions	58
<input type="checkbox"/> Microphone keyboard	7	<input type="checkbox"/> Subaudible tone	35	13 EXTERNAL DTMF REMOTE	59-60
2 INSTALLATION	9-13	<input type="checkbox"/> Offset frequency	38	14 PAGER AND CODE SQUELCH	31-37
<input type="checkbox"/> Installation methods	9	7 MEMORY OPERATION	37-41	<input type="checkbox"/> Pager function	61
<input type="checkbox"/> Location	10	<input type="checkbox"/> General description	37	<input type="checkbox"/> Code channel	62
<input type="checkbox"/> One body installation	10	<input type="checkbox"/> Memory channel selection	37	<input type="checkbox"/> Code programming	63
<input type="checkbox"/> Separate installation	11	<input type="checkbox"/> Programming a memory channel	38	<input type="checkbox"/> Pager operation	64
<input type="checkbox"/> Optional MB-50 installation	12	<input type="checkbox"/> Programming a memory channel via the	39	<input type="checkbox"/> Code squelch function	68
<input type="checkbox"/> Battery connection	13	microphone	39	<input type="checkbox"/> Code squelch operation	67
<input type="checkbox"/> DC power supply connection	13	<input type="checkbox"/> Transferring memory contents	40	15 POCKET BEEP AND	
<input type="checkbox"/> Antenna installation	14	<input type="checkbox"/> Memory area setting	41	 TONE SQUELCH	39-39
<input type="checkbox"/> Antenna splitter connections	15	<input type="checkbox"/> Memory bank selection	41	<input type="checkbox"/> Pocket beep operation	68
<input type="checkbox"/> Optional unit installation	16	3 CALL CHANNEL OPERATION	42-43	<input type="checkbox"/> Tone squelch operation	69
3 MODE ARRANGEMENT CHART	17-18	<input type="checkbox"/> Calling up a call channel	42	16 OTHER FUNCTIONS	70-74
4 SETTING A FREQUENCY	19-23	<input type="checkbox"/> Transferring call channel contents	42	<input type="checkbox"/> Beep tone volume selection	70
<input type="checkbox"/> Pre-operation	19	<input type="checkbox"/> Programming a call channel	43	<input type="checkbox"/> Speaker jack selection	70
<input type="checkbox"/> Lock functions	20	9 SCAN OPERATION	44-51	<input type="checkbox"/> Display dimmer setting	71
<input type="checkbox"/> VFO and memory modes	21	<input type="checkbox"/> Scan types	44	<input type="checkbox"/> Optional voice synthesizer	71
<input type="checkbox"/> Using a tuning dial	21	<input type="checkbox"/> Full scan and programmed scan	45	<input type="checkbox"/> Partial resetting	72
<input type="checkbox"/> Using [UP]/[DN] switches	22	<input type="checkbox"/> Scan edge selection	46	<input type="checkbox"/> Resetting the transceiver	73
<input type="checkbox"/> Tuning step selection	22	<input type="checkbox"/> Programming scan edges	47	<input type="checkbox"/> Microphone address	73
<input type="checkbox"/> Using the keyboard	23	<input type="checkbox"/> Programming scan edges via microphone	48	<input type="checkbox"/> Time-out timer	74
5 BASIC OPERATION	24-32	<input type="checkbox"/> Memory scan	49	17 MAINTENANCE	75-77
<input type="checkbox"/> Receiving	24	<input type="checkbox"/> Skip channel setting	50	<input type="checkbox"/> Troubleshooting	75
<input type="checkbox"/> Setting a squelch level	25	<input type="checkbox"/> Scan resume condition	51	<input type="checkbox"/> Fuse replacement	77
<input type="checkbox"/> Monitor function	26	10 PRIORITY WATCH	52-53	<input type="checkbox"/> Backup battery	77
<input type="checkbox"/> Audio mute function	26	<input type="checkbox"/> Priority watch types	52	<input type="checkbox"/> External equipment connection	77
<input type="checkbox"/> RF attenuator	26	<input type="checkbox"/> Priority watch operation	53	18 SPECIFICATIONS	78
<input type="checkbox"/> Sub band access	27	11 DTMF MEMORY	54-56	19 OPTIONS	79-80
<input type="checkbox"/> Sub band mute/sub band busy beep	28	<input type="checkbox"/> Programming a DTMF code	54	<input type="checkbox"/> Unpacking	79
<input type="checkbox"/> Reduced band operation	29	<input type="checkbox"/> Clearing the DTMF memory contents	54	<input type="checkbox"/> Options	79
<input type="checkbox"/> Para-watch	29	<input type="checkbox"/> Programming a DTMF code via the	55		
<input type="checkbox"/> Transmitting	31	microphone	55		
<input type="checkbox"/> Selecting the output power	31				

PANEL DESCRIPTION

Front panel (remote controller)

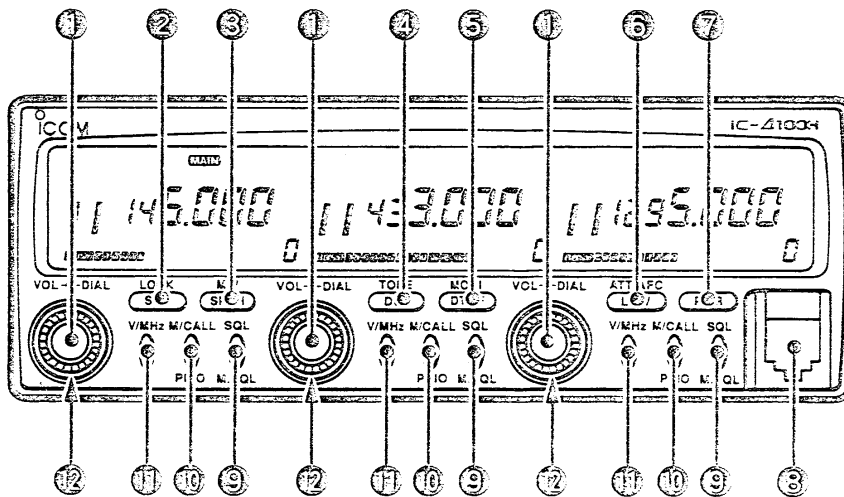

① TUNING DIALS [DIAL]

- Select the operating frequency (p. 21), the memory channel (p. 37), the contents of the set mode display (p. 17) and the scanning direction (pgs. 45, 49).
- Select the main band by pushing a dial. (p. 19)
- Activate the sub band access function when pushed and held (when the main band is not selected). (p. 27)
- Change the operating band for para-watch when pushed and held (when the main band is selected). (p. 29)

② SET MODE SWITCH [SET/LOCK]

- Accesses set mode and advances the set mode display. (p. 17)
- Activates the lock function when pushed and held. (p. 20)

③ SPEECH/MEMORY WRITE SWITCH [SPCH/MW]

- Programs a memory channel or a call channel. (pgs. 38, 43)
- Transfers the contents of a memory channel or a call channel to the VFO. (pgs. 40, 42)
- Announces the accessed band frequency in a synthesized voice when an optional UT-66 VOICE SYNTHESIZER UNIT is installed. (p. 71)
- Reverses the set mode selection order in set mode. (p. 17)

④ DUPLEX/TONE SWITCH [DUP/TONE]

- Selects simplex, - duplex or + duplex. (p. 33)
- Activates the optional subaudible tone encoder* (p. 34); pocket beep (p. 68) or tone squelch function (p. 69) when pushed and held.

* U.S.A. version : Built-in.

Other versions : Optional except for 88.5 Hz.

- ⑤ **DTMF/MONITOR SWITCH [DTMF/MONI]**
 - Activates the DTMF memory function. (p. 54).
 - Activates the optional pager, code squelch or external DTMF remote functions when an optional UT-75 DTMF DECODER UNIT is installed. (pgs. 59, 64, 67)
 - Opens the accessed band squelch and monitors the transmit frequency when pushed and held. (pgs. 26, 33)
- ⑥ **TRANSMIT POWER SWITCH [LOW/ATT/AFC]**
 - Selects the transmit output power levels. (p. 31)
 - Activates the RF attenuator function when pushed and held on VHF or UHF. (p. 26)
 - Activates the AFC, RIT or VXO (selectable in set mode) function when pushed and held on the 1.2 GHz band. (p. 58)
- ⑦ **POWER SWITCH [PWR]** (p. 19)
Turns power ON and OFF.
- ⑧ **MICROPHONE CONNECTOR**
Connects the supplied microphone.

- ⑨ **SQUELCH SWITCHES [SQL/M.SQL]** (p. 25)
 - Select 1 of the 4 preset squelch levels.
 - The [VOL] (outer control) sets the squelch level manually after being pushed and held 1 time.
 - Select the squelch threshold point when pushed and held 2 times.
- ⑩ **MEMORY/CALL CHANNEL SWITCHES [M/CALL/PRIO]**
 - Select memory mode or call channel. (pgs. 37, 42)
 - Activate the priority watch function when pushed and held. (p. 53)
 - Cancel the priority watch function when the function is activated. (p. 53)
- ⑪ **VFO/MHz SWITCHES [V/MHz]**
 - Select VFO mode. (p. 21)
 - Select the 1 MHz tuning step in VFO mode. (p. 21)
 - Select the 10 MHz tuning step when pushed and held. Some versions do not have this tuning step. (p. 21)
- ⑫ **VOLUME CONTROLS [VOL]**
 - Adjust the audio level. (p. 24)
 - Vary the squelch level after pushing and holding the [SQL] switch. (p. 25)

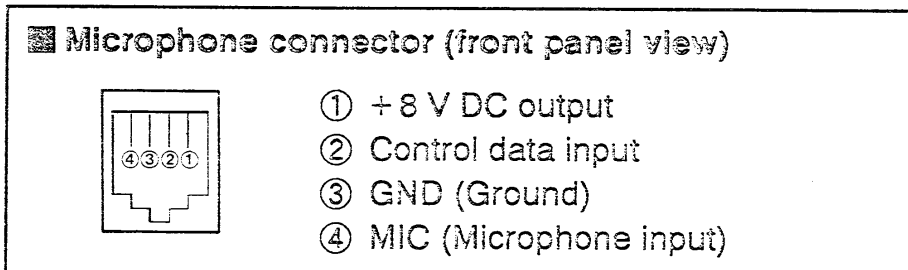

1 PANEL DESCRIPTION

■ Function display

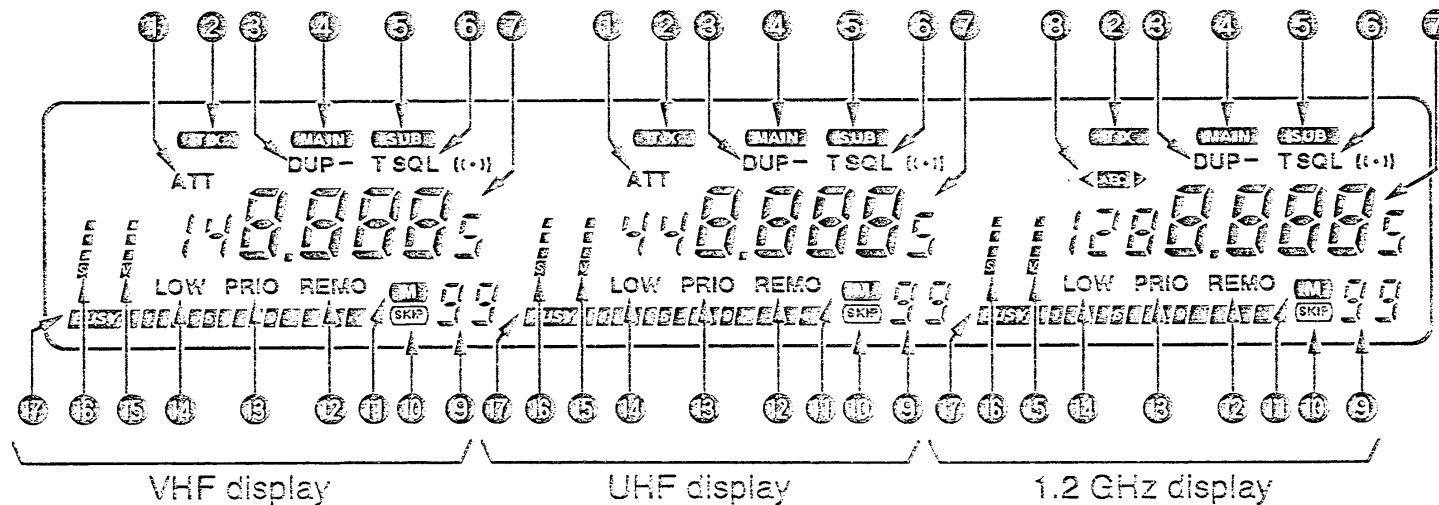

① RF ATTENUATOR INDICATORS (p. 26)

Appear while the RF attenuator is in use.

② TRANSMIT INDICATORS

Appear while transmitting. (p. 31) Blink while transmitting with the one-touch PTT function. (p. 32)

③ DUPLEX INDICATORS (p. 33)

"DUP -" or "DUP" appear during semi-duplex operation (repeater operation).

④ MAIN BAND INDICATORS (p. 19)

Appear above the frequency readout to show the main band for transmitting and function control.

⑤ SUB BAND ACCESS INDICATORS (p. 27)

Appear above the frequency readout to show the accessed band for function control (except transmitting).

⑥ TONE INDICATORS

- "T" appears while the subaudible tone encoder is in use. (p. 34)

- "T SQL" appears while the optional tone squelch function is in use. (p. 69)

- "T SQL (t·i)" appears while the optional pocket beep function is in use. (p. 68)

⑦ FREQUENCY READOUTS

- Show the operating frequency, set mode contents, etc.
- The decimal point of the frequency flashes while scanning. (pgs. 45, 49)
 - "P," "C" or "d" appears in place of the 100 MHz digit while the DTMF memory function, optional pager or optional code squelch is in use, respectively. (pgs. 54, 64, 67)

⑧ AFC INDICATORS

- "AFC" appears while the AFC (Automatic Frequency Control) function is in use. (p. 58)
- "◀" or "▶" indicates a fine tuning direction. (p. 58)
- Both "◀" and "▶" appear when the center frequency is set during manual RIT/YXO operation or when the RF attenuator is in use during 430(440) MHz band receiving on the 1.2 GHz band. (p. 26)

⑨ MEMORY CHANNEL READOUTS

- Show the selected memory channel numbers. (p. 37)
- 3 large "L" 's appear while the lock function is in use. (p. 20)
 - A large "C" appears while on the call channel. (p. 42)
 - A small "c" appears when VFO mode is selected from the call channel. (p. 42)

⑩ SKIP INDICATORS (p. 50)

Appear when the displayed memory channel is specified as a skip channel.

⑪ MEMORY INDICATORS (p. 37)

Appear when memory mode is selected.

⑫ REMOTE INDICATORS (p. 59)

Appear while the optional external DTMF remote is in standby. Blink while the function is activated.

⑬ PRIORITY WATCH INDICATORS (p. 53)

Appear while the priority watch is activated; flash while the watch is paused.

⑭ LOW POWER INDICATORS (p. 31)

Appear while low output power 1 or 2 is selected.

⑮ VOLUME LEVEL INDICATORS

- Show the audio volume level. (p. 24)
- Blink while the audio mute function is in use. (p. 26)

⑯ SQUELCH LEVEL INDICATORS (p. 25)

- Show the squelch volume level.
- "S" blinks while the [VOL] control is set for squelch level adjustment.

⑰ S/RF INDICATORS

- Show the relative strength while receiving signals. (p. 24)
- Show the output power selection while transmitting. (p. 31)

1 PANEL DESCRIPTION

■ Rear panel

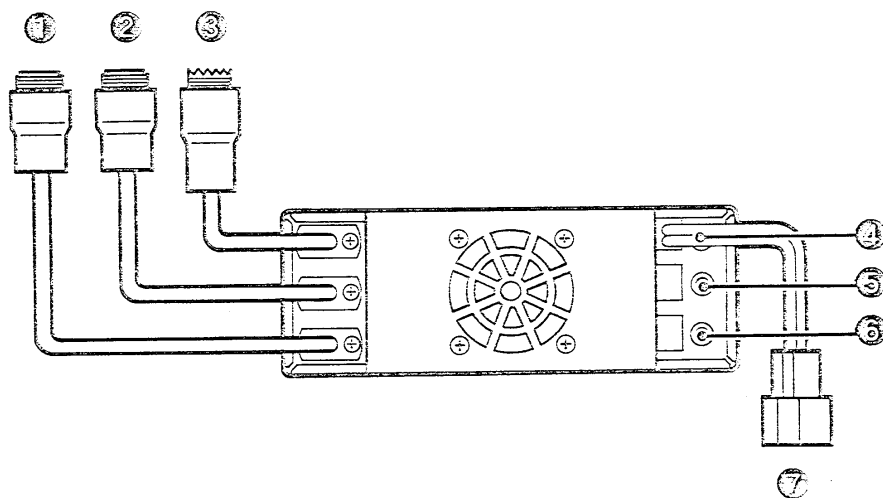

- ① 1.2 GHz ANTENNA CONNECTOR [1200 MHz ANT]
Accepts a 50 Ω 1.2 GHz band antenna with a type-N connector. (p. 15)
- ② 430(440) MHz ANTENNA CONNECTOR [430(440) MHz ANT]
Accepts a 50 Ω 430(440) MHz band antenna with a type-N connector. (p. 15) This connector is used for the 430(440) MHz band operation even when a 430(440) MHz band frequency is selected in the VHF display or 1.2 GHz display. (p. 29)

- ③ 144 MHz ANTENNA CONNECTOR [144 MHz ANT]
Accepts a 50 Ω 144 MHz band antenna with a PL-259 connector. (p. 14) This connector is used for the 144 MHz band operation even when a 144 MHz band frequency is selected in the UHF display. (p. 29)
- ④ 144 MHz SPEAKER JACK [144 MHz SP]
Connects a 4–8 Ω speaker, if required. Outputs the 144 MHz band audio or all band audio according to the initial set mode selection. (p. 70)
- ⑤ 430(440) MHz SPEAKER JACK [430(440) MHz SP]
Connects a 4–8 Ω speaker. Outputs the 430(440) MHz band audio or no audio according to the initial set mode selection. (p. 70)
- ⑥ 1.2 GHz SPEAKER JACK [1200 MHz SP]
Connects a 4–8 Ω speaker. Outputs the 1.2 GHz band audio or no audio according to the initial set mode selection. (p. 70)
- ⑦ POWER RECEPTACLE [DC13.8V] (p. 13)
Accepts 13.8 V DC with the supplied DC power cable.

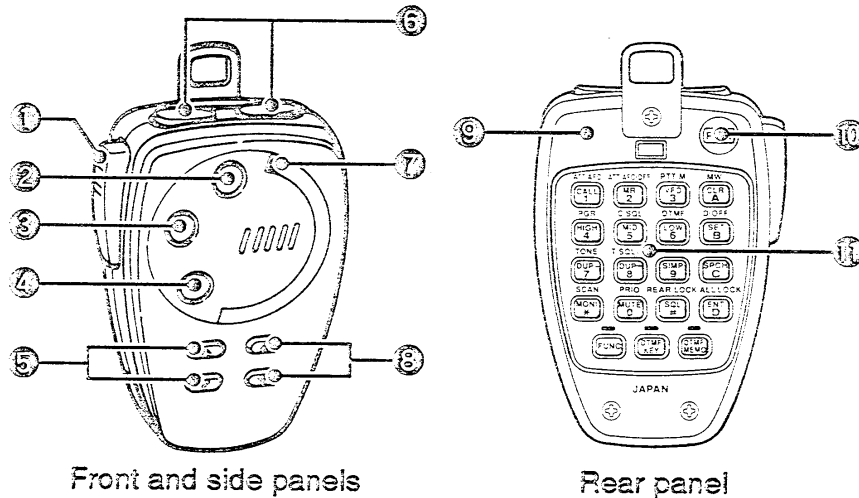

Front and side panels

Rear panel

① PTT SWITCH

- Push and hold to transmit; release to receive. (p. 31)
- Toggles between transmitting and receiving while the one-touch PTT function is in use. (p. 32)

② 1.2 GHz SWITCH [1.2G]

③ UHF SWITCH [UHF]

④ VHF SWITCH [VHF]

- Selects the desired band as the main band. (p. 19)
- Changes the operating band when pushed and held (when the main band is selected). (p. 29)
- Activates the sub band access function after pushing [FUNC] on the rear panel. (p. 27)

⑤ SQUELCH LEVEL UP/DOWN SWITCHES

[△SQL], [▽SQL]

Vary the accessed band squelch threshold point for noise mute. (p. 25)

⑥ FREQUENCY UP/DOWN SWITCHES [UP], [DN]

- Push either switch to change the operating frequency, memory channel, set mode contents, etc. (pgs. 22, 37)
- Push and hold either switch to start scanning. (pgs. 45, 49)

⑦ ACTIVE INDICATOR

Lights up in red while a key is pushed; lights up in green while the one-touch PTT function is in use. (p. 32)

⑧ AUDIO VOLUME UP/DOWN SWITCHES

[△VOL], [▽VOL]

Adjust the accessed band audio level. (p. 24)

⑨ MODE INDICATOR

Indicates the microphone condition.

- Lights up in red when [FUNC] is pushed.
- Lights up in green when [DTMF KEY] is pushed.
- Lights up in orange when [DTMF MEMO] is pushed.

⑩ POWER SWITCH [PWR] (p. 19)

Remotely turns power ON and OFF when the [PWR] switch on the remote controller is pushed IN.















⑪ KEYBOARD









Used for controlling the transceiver, transmitting a DTMF memory channel, etc. See pgs. 7 and 8 for function details.

1 PANEL DESCRIPTION

Downloaded by
RadioAmateur.EU

Microphone keyboard

KEY	FUNCTION	SECONDARY FUNCTION (After )	OTHER FUNCTIONS
ATT/AFC 	Calls up a call channel. (p. 42)	Turns the RF attenuator or AFC function ON. (pgs. 26, 58)	<p>• After  : Input the appropriate digit. (pgs. 23, 37)</p> <p>• After  : Transmit the appropriate DTMF code. (p. 56)</p> <p>• After  : Transmit the appropriate DTMF memory contents. (p. 56)</p>
ATT/AFC-OFF 	Selects memory mode. (p. 37)	Turns the RF attenuator or AFC function OFF. (pgs. 26, 58)	
PTT-M 	Selects VFO mode. (p. 21)	Turns the one-touch PTT function ON and OFF. (p. 32)	
PGR 	Selects high output power. (p. 31)	Turns the optional pager function ON. (p. 64)	
C SQL 	Selects middle output power (low-2, for VHF and UHF only). (p. 31)	Turns the optional code squelch function ON. (p. 67)	
DTMF 	Selects lowest output power (low-1). (p. 31)	Turns the DTMF memory function ON. (p. 54)	
TONE 	Selects - duplex. (p. 33)	Turns the subaudible tone encoder ON. (p. 34)	
T SQL (I+I) 	Selects + duplex. (p. 33)	Turns the optional pocket beep function ON. (p. 68)	
T SQL 	Selects simplex. (p. 33)	Turns the optional tone squelch function ON. (p. 69)	
PRIO 	Mutes all bands' audio signals. (p. 26)	Starts the priority watch. (p. 53)	

KEY	FUNCTION	SECONDARY FUNCTION (After )	OTHER FUNCTIONS
	Clears the entered digit before entry. (p. 23) Cancels the DTMF memory function, optional pager, optional code squelch or optional external DTMF remote. (pgs. 54, 59, 64, 67)	Writes the VFO contents into the memory channel or call channel. (pgs. 39, 43)	<ul style="list-style-type: none"> ◦ After  : Transmit the appropriate DTMF code. (p. 56) ◦ After  : [ⓐ CLR]—[ⓓ ENT] Transmit the appropriate DTMF memory contents. (p. 56) [Ⓢ MONI] Transmits a 1750 Hz tone call signal for 0.5 sec. (p. 34) [Ⓢ SQL] Transmits a 1750 Hz tone call signal continuously. (p. 34)
	Enters set mode. (p. 17)	Turns the DTMF memory function, optional pager or optional code squelch OFF. (pgs. 54, 64, 67)	
	Announces the accessing band frequency in a synthesized voice when an optional UT-66 is installed. (p. 71) Reverses the set mode selection order in set mode. (p. 17)	Turns the subaudible tone encoder, optional pocket beep or optional tone squelch OFF. (pgs. 34, 68, 69)	
	Sets the keyboard for numeral use. (pgs. 23, 37)	Locks all keys on the microphone except the PTT switch. (p. 20)	
	Opens the accessed band squelch. (p. 26)	Starts scanning. (pgs. 45, 49)	
	Selects 1 of the 4 preset squelch levels. (p. 25)	Locks all keys on the microphone keyboard. (p. 20)	

■ Installation methods

◇ One body installation

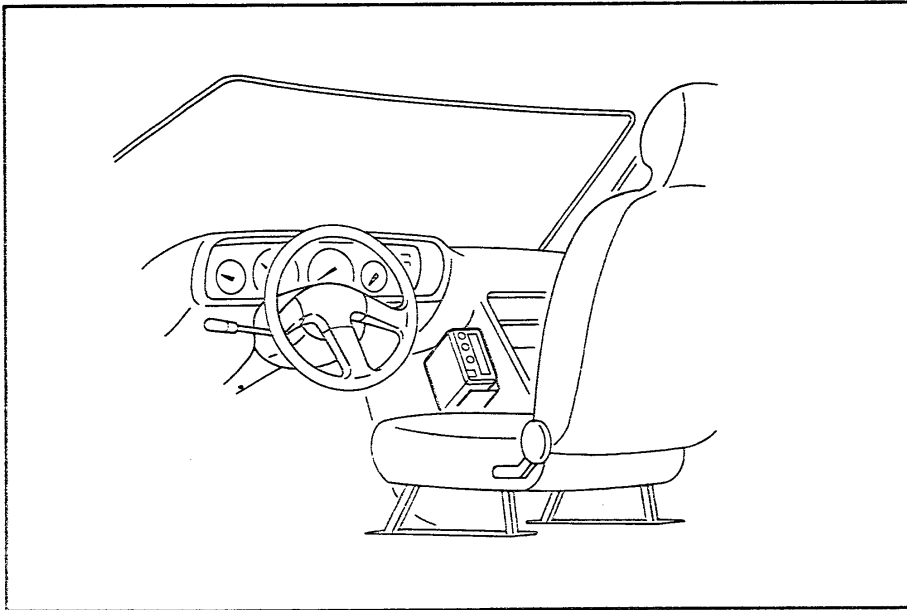

- It is not necessary to purchase a mounting bracket. The supplied mounting bracket (MB-27) can be used for installation.

◇ Separate installation

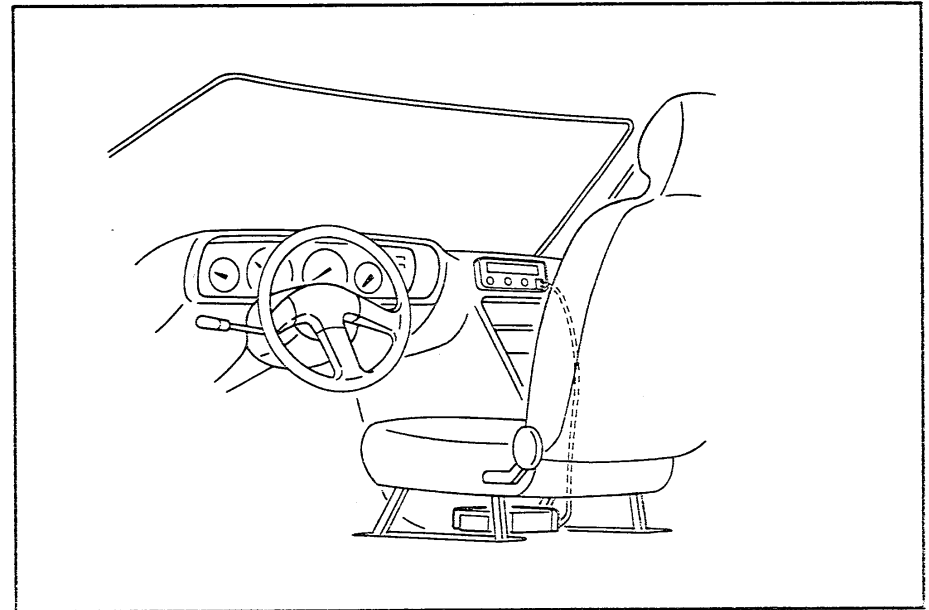

- Optional OPC-332 SEPARATION KIT (3.5 m; 11.5 ft) or OPC-333 (7.0 m; 23.0 ft) is necessary.
- Optional MB-50 REMOTE CONTROLLER BRACKET is available for front panel mounting.
- Optional OPC-335 SPEAKER CABLE is available to extend the speaker cable.

■ Location

Select a location which can support the weight of the transceiver and does not interfere with driving in any way. We recommend the locations shown in the diagram below.

NEVER place the transceiver or remote controller where normal operation of the vehicle may be hindered or where it could cause bodily injury.

NEVER place the transceiver or remote controller where air bag operation may be obstructed.

DO NOT place the transceiver or remote controller where hot or cold air blows directly onto it.

AVOID placing the transceiver or remote controller in direct sunlight.

• EXAMPLE INSTALLATION LOCATIONS

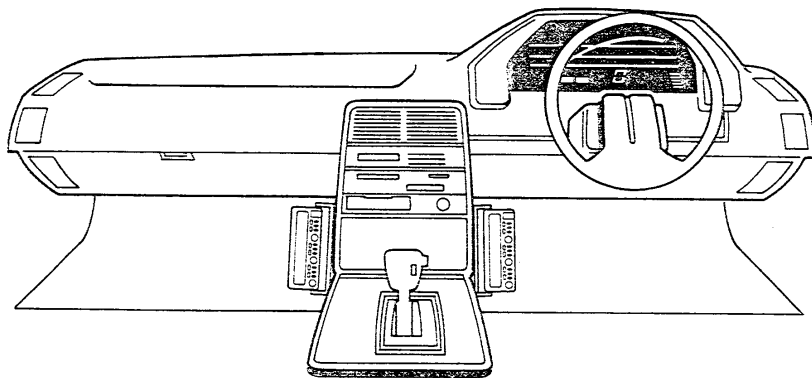

■ One body installation

- ① Drill 4 holes where the mounting bracket is to be installed.
 - Approx. 5.5–8 mm when using nuts; approx. 2–3 mm when using self-tapping screws. (1 mm ≈ 1/32 in)
- ② Insert the supplied screws, nuts and washers through the mounting bracket and tighten.
- ③ The supplied mounting support bracket may help achieve a secure fit.
- ④ Adjust the angle for the clearest view of the function display.

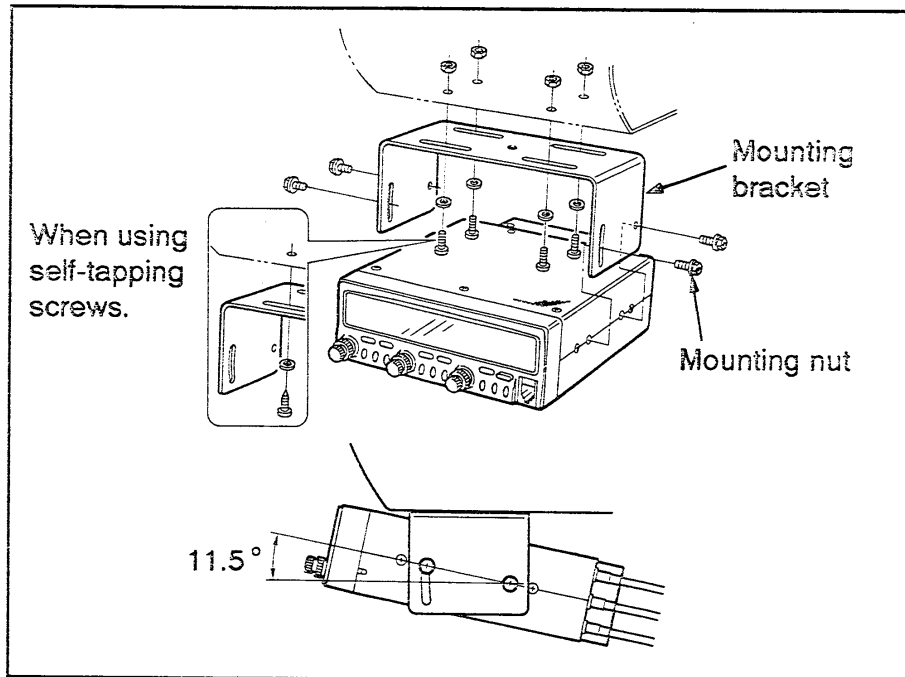

2 INSTALLATION

■ Separate installation

Using an optional OPC-332/333 SEPARATION KIT, the front panel can be separated from the main body, doubling as a remote controller.

The remote controller can be placed on the vehicle dashboard or in another convenient place. To install the main body in the trunk, an optional OPC-335 SPEAKER CABLE is available to extend the speaker cable.

- ① Turn power OFF, then disconnect the DC power cable.
- ② Push the release button upwards, then open the remote controller as shown below.
- ③ Disconnect the control cable from the main body.

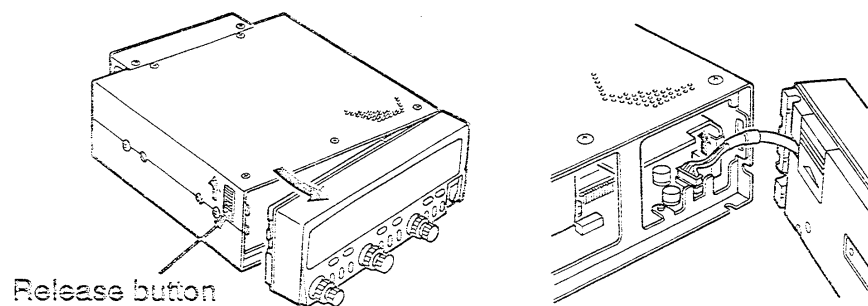

- ④ Remove the cable cover on the controller rear panel.
- ⑤ Replace the control cable with the optional OPC-332/333. Replace the cable cover. Keep the original control cable for future use.

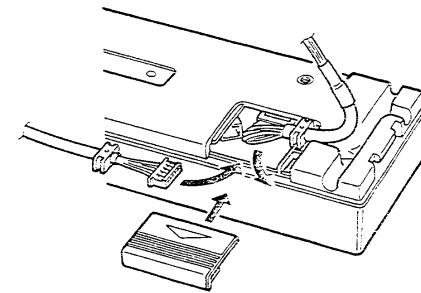

- ⑥ Insert the other end's connector to the main body connector. Insert the rubber fitting (A) between 2 prongs.
- ⑦ Pull down (B), then pass the control cable through the opening in the dummy front cover (supplied with the OPC-332/333). Insert (B) to the original position.

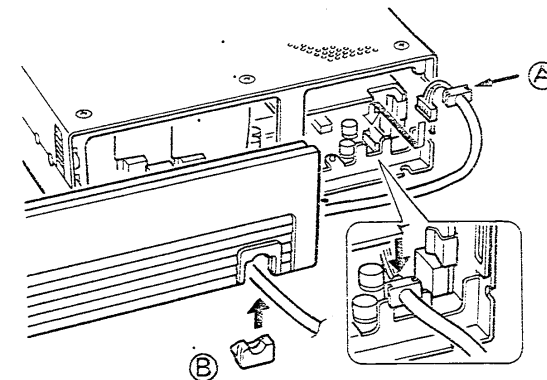

- ⑧ Attach the dummy front cover to the main body.
- ⑨ Connect the DC power cable.

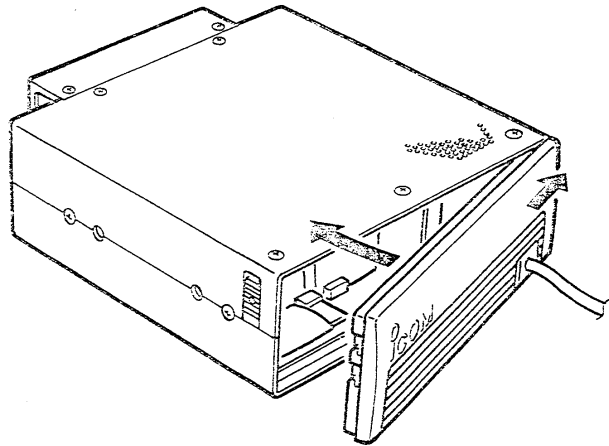

■ Optional MB-50 installation

The optional MB-50 REMOTE CONTROLLER BRACKET is available for separate installation.

- ① Mount the MB-50 to a flat place using the supplied screws or nuts as shown below.
 - A gooseneck mount with a tripod-type screw (1/4-20 UNC) may be useful.
- ② Adjust the angle for the clearest view of the function display and tighten the 2 adjustment screws.

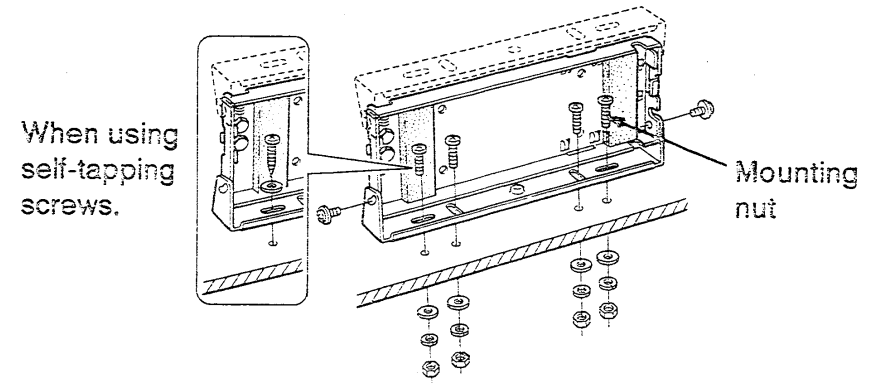

- ③ Attach the remote controller as shown below.

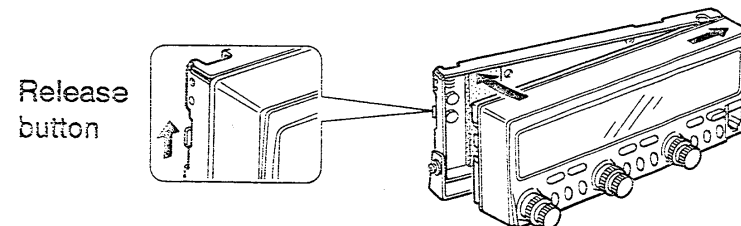

2 INSTALLATION

■ Battery connection

NEVER connect the transceiver directly to a 24 V battery.

DO NOT use the cigarette lighter socket for power connections.

To prevent voltage drops, solder or crimp the supplied cable lugs when connecting the power cable to the battery.

• CONNECTING TO A DC POWER SOURCE

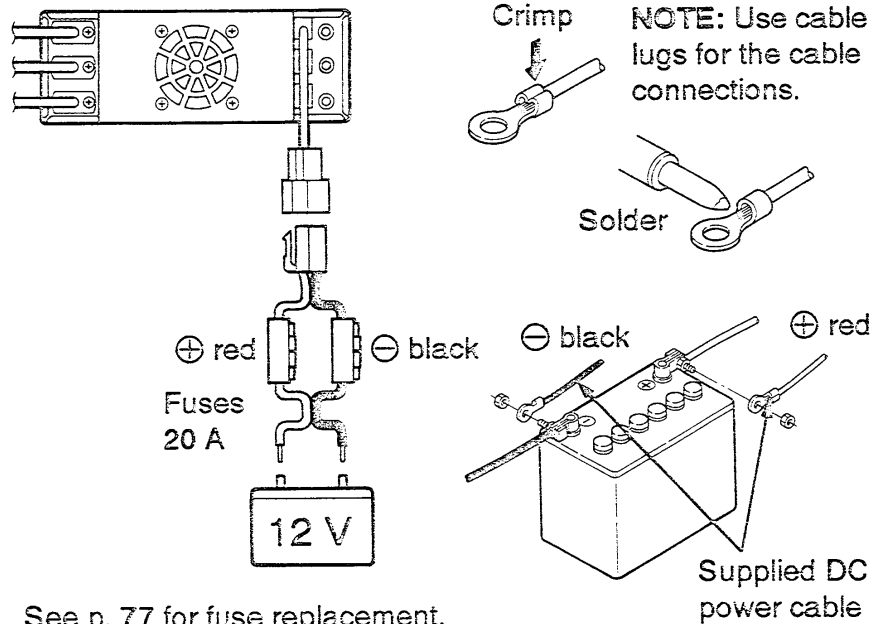

■ DC power supply connection

Use a 13.8 V DC power supply more than 12 A capability. An optional IC-PS30 DC POWER SUPPLY is available for using the transceiver with a DC power supply in your home.

Make sure the ground terminal of the DC power supply is grounded.

• CONNECTING TO A DC POWER SUPPLY

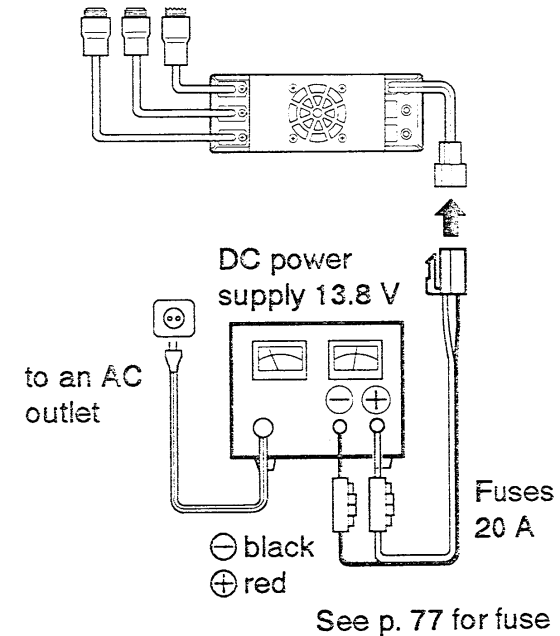

Antenna installation

◇ Antenna location

To obtain maximum performance from the transceiver, select a high-quality antenna and mount it in a good location.

A duplexer or antenna splitter must be purchased when using a dual band or triband antenna.

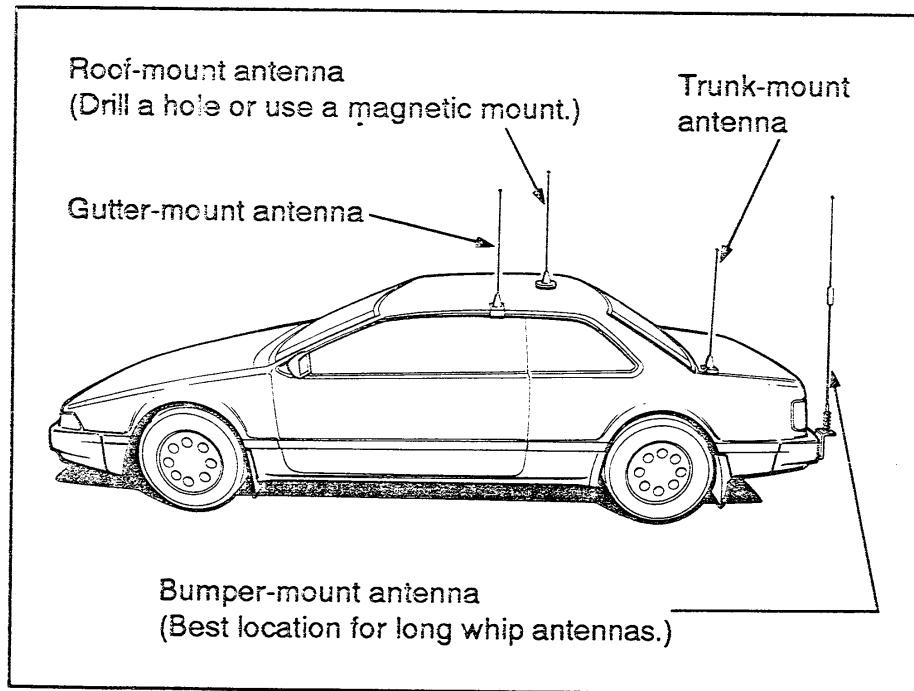

◇ Antenna connector

The [144 MHz ANT] connector uses a PL-259 connector and the [430(440) MHz ANT] and [1200 MHz ANT] connectors use type-N connectors.

• PL-259 CONNECTOR

- ① Slide the coupling ring over the coaxial cable.

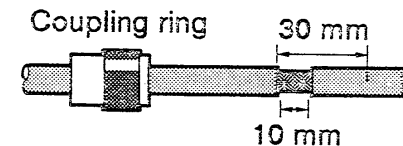

- ② Strip the cable as shown in the diagram, and soft solder the center conductor.

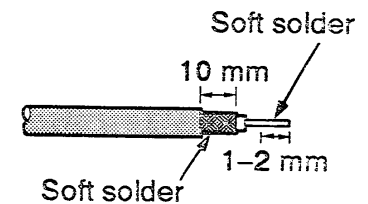

- ③ Slide the connector body onto the cable and solder.

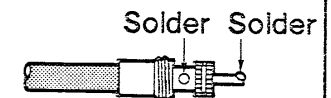

- ④ Screw the coupling ring onto the connector body.

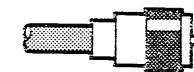

30 mm \approx 9/8 in
10 mm \approx 3/8 in
1-2 mm \approx 1/16 in

over

2 INSTALLATION

• TYPE-N CONNECTOR

- ① Slide the nut, washer, rubber gasket and clamp over the coaxial cable. Then cut the end of the cable evenly.
- ② Strip the cable and fold the braid back over the clamp. Evenly trim the braid ends.
- ③ Soft solder the center conductor. Install a center conductor pin and solder it.
- ④ Carefully slide the connector body into place aligning the center conductor pin on the cable. Tighten the nut onto the connector body.

• Be sure the center conductor is the same height as the connector body.

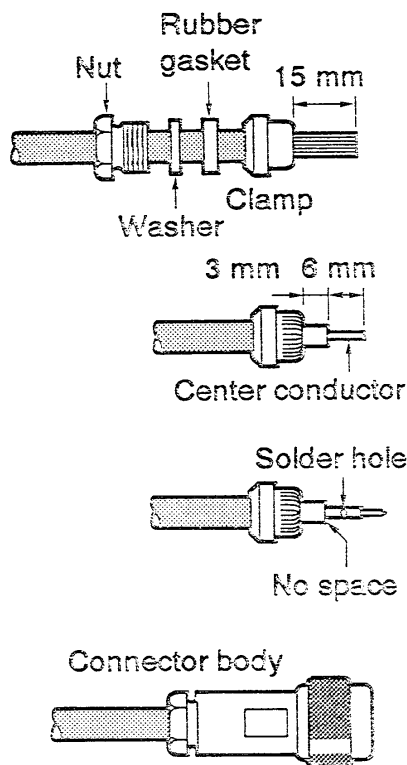

15 mm \approx 5/8 in
 3 mm \approx 1/8 in
 6 mm \approx 1/4 in

■ Antenna splitter connections

The transceiver has an independent antenna connector for each band (not for each display), therefore, a duplexer or antenna splitter can be used for reducing the number of antennas.

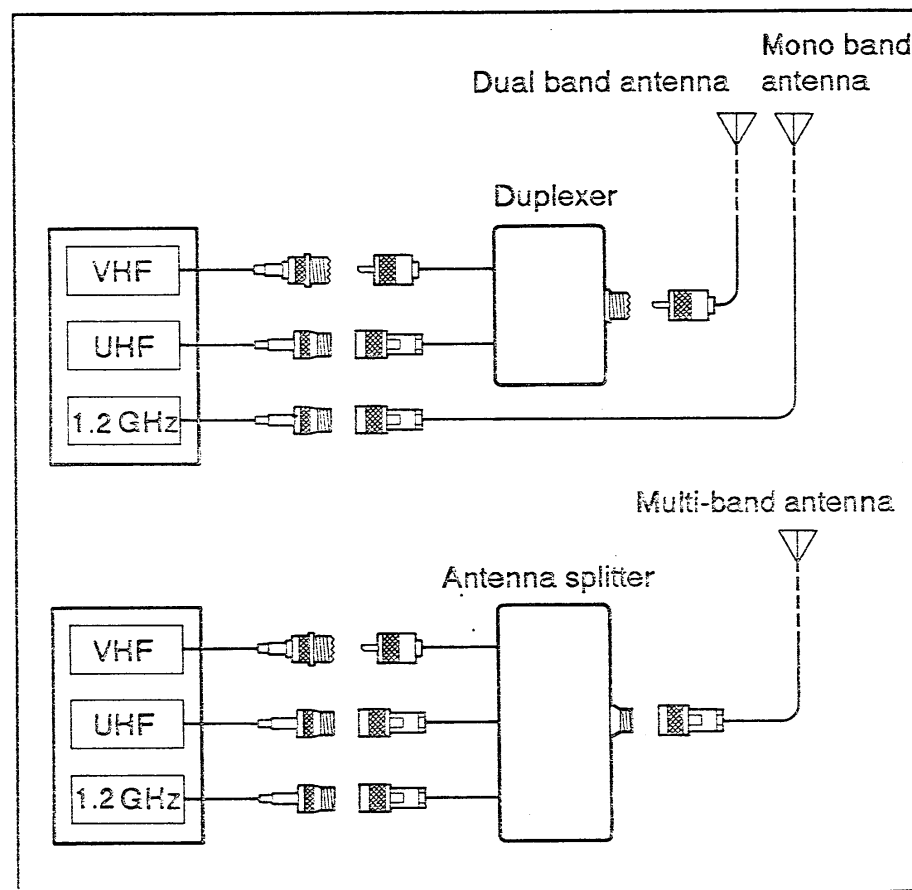

■ Optional unit installation

There are 3 types of optional internal units available.

- **UT-66 VOICE SYNTHESIZER UNIT** (p. 71)
Announces the operating band frequency in English or Japanese.
- **UT-75 DTMF DECODER UNIT** (pgs. 59, 64, 67)
Allows you to operate the pager and code squelch function. Necessary for the external DTMF remote.
- **UT-76 TONE SQUELCH UNIT** (pgs. 68, 69)
Allows you to operate a repeater that requires a sub-audible tone* for access, the pocket beep function or the tone squelch function.
 - * U.S.A. version : Built-in.
 - Other versions : 88.5 Hz only.

For installation, proceed as follows:

- ① Turn power OFF, then disconnect the DC power cable.
- ② Push the release button upwards, then open the remote controller as shown at right.
- ③ Install the optional unit as shown in the diagram at right.
 - For the U.S.A. version, replace the UT-76 with the built-in TONE UNIT.
- ④ Attach the remote controller and connect the DC power cable.

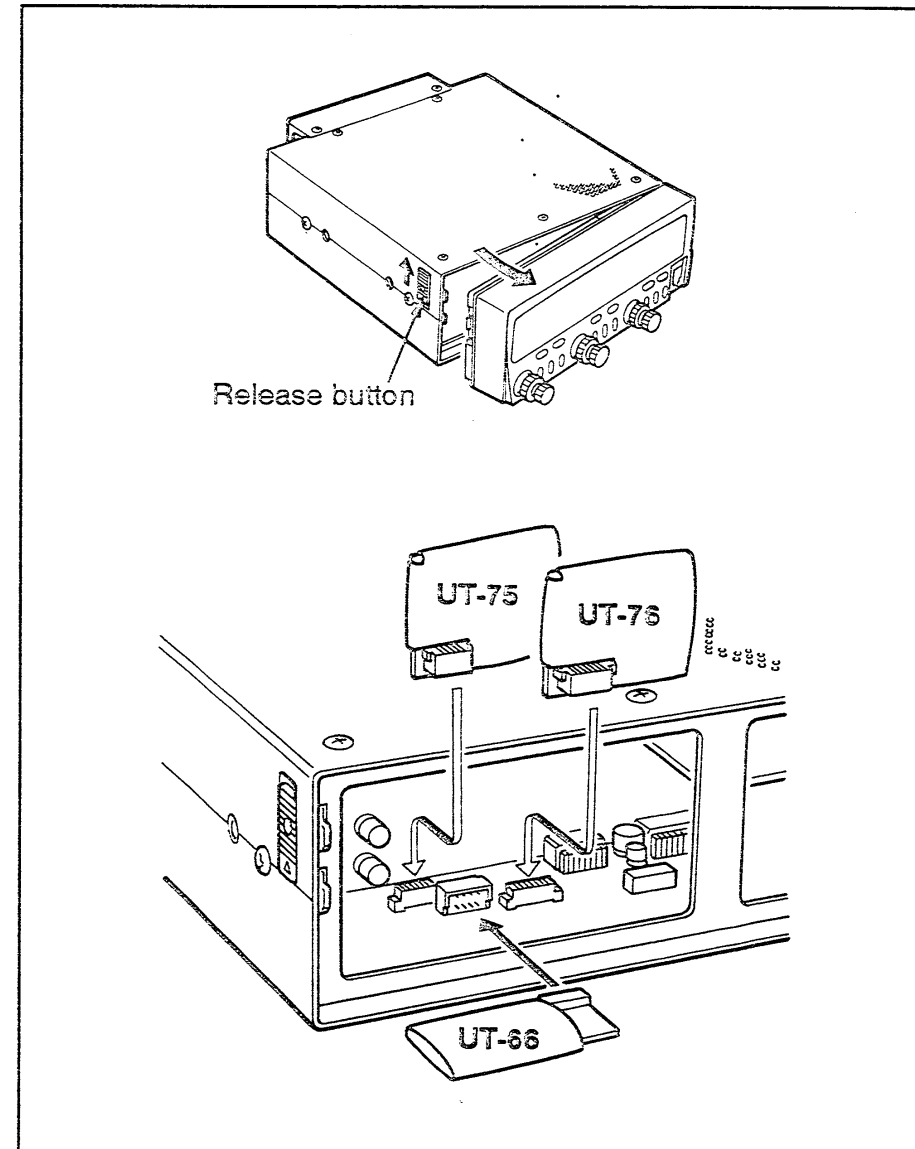

3

MODE ARRANGEMENT CHART

Although the following chart refers only to the VHF band, the transceiver has the same mode arrangement in the UHF and 1.2 GHz bands.

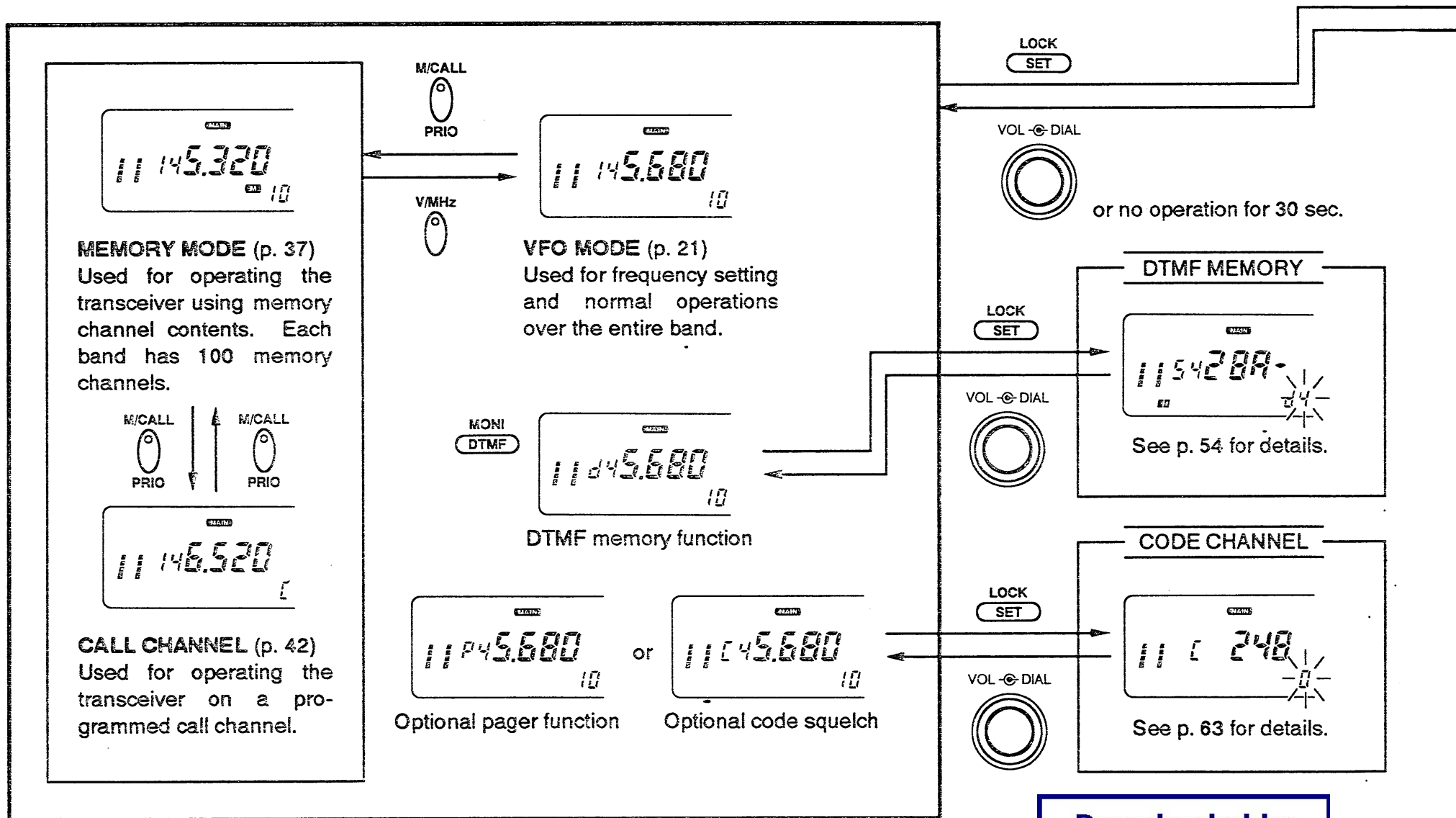

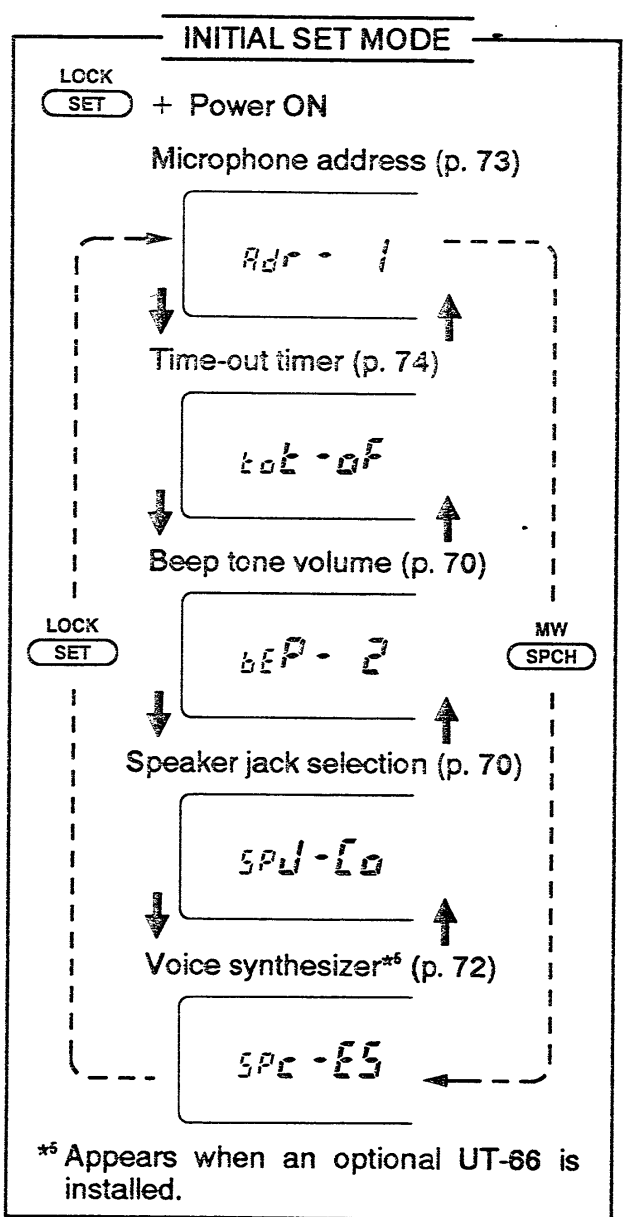
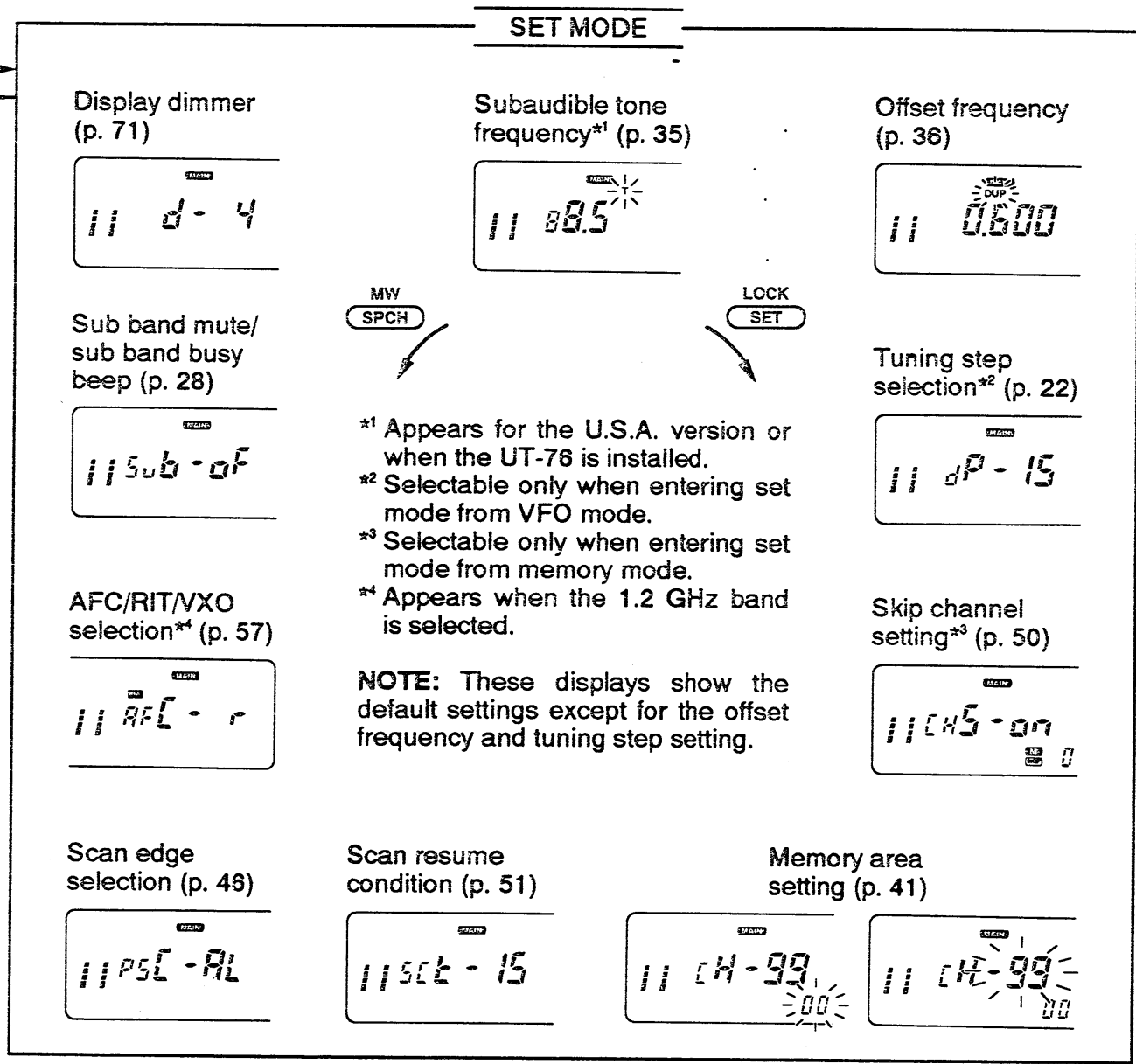

4

SETTING A FREQUENCY

■ Pre-operation

◇ Turning power ON

Push [PWR] on the transceiver IN to turn power ON.

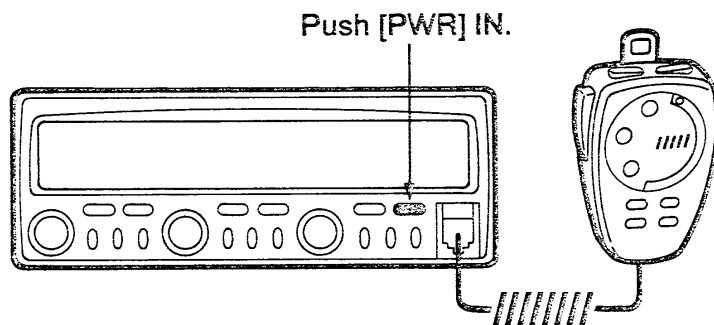

Push [PWR] on the microphone to turn power ON or OFF when [PWR] on the transceiver is pushed IN.

NOTE: Be sure to push [PWR] on the transceiver OUT, when you leave the transceiver; otherwise the power is automatically turned ON when the power source drops (when starting the vehicle's engine, etc.).

◇ Main band

This transceiver can receive VHF, UHF and 1.2 GHz band signals simultaneously. To activate all functions or to change frequency via the microphone, you must designate one band as the main band. The transceiver can transmit a signal on the main band only.

Push the desired band's tuning dial to select the main band.

• "MAIN" indicator shows the selected band as the main band.



Push the desired band switch: [VHF], [UHF] or [1.2G] to select the main band.

◇ Microphone address

The microphone has 8 kinds of control address. If the transceiver cannot be controlled from the microphone, check the microphone address. (p. 73)

■ Lock functions

To prevent accidental frequency changes and unnecessary function access, use the lock function. The transceiver has 3 kinds of lock functions for your needs.

◇ Frequency lock

This function locks the tuning dials and switches electronically. This function can be used together with the microphone all lock or microphone rear lock functions.

Push and hold [SET/LOCK] until "L" appears in the memory channel readout to activate the function.

- To cancel the function, push and hold [SET/LOCK] until "L" disappears.
- [PTT], [MONI], [VOL], [SQL] and optional [SPCH] can be used while the frequency lock function is in use. DTMF tone or DTMF memory contents can be transmitted from the microphone.

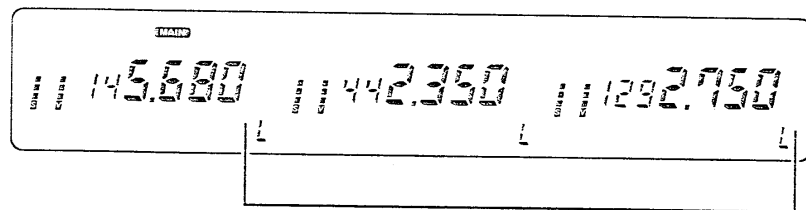

3 "L" 's appear while the frequency lock function is in use.

◇ Microphone all lock

This function locks all switches on the microphone except for [PTT].



Push [FUNC] then [ⓈALL LOCK] to turn the function ON and OFF.

- All switches and tuning dials on the remote controller and [PTT] can be used while the microphone all lock function is in use.

◇ Microphone rear lock

This function locks all switches on the microphone rear panel except [PWR].



Push [FUNC] then [ⓈREAR LOCK] to turn the function ON and OFF.

- All switches and tuning dials on the remote controller and microphone front panel can be used while the microphone rear lock function is in use.

4 SETTING A FREQUENCY

■ VFO and memory modes

This transceiver has 2 normal operating modes: VFO mode and memory mode. You can select VFO mode or memory mode independently on each band.

Push the desired band's [V/MHz] to select VFO mode when the transceiver is not in VFO mode.

- If VFO mode is already selected, the digits below 100 kHz unit disappear. In this case, push [V/MHz] again.

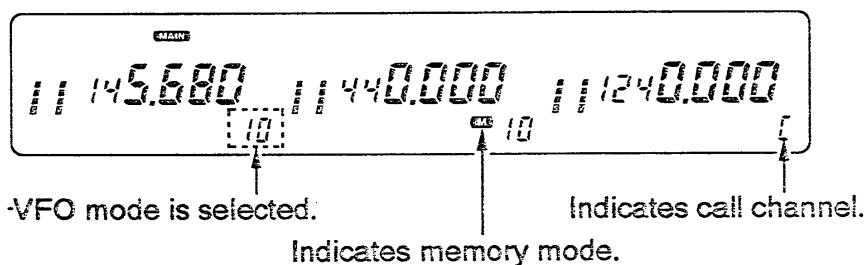

Push [③ VFO] to select VFO mode.

- The microphone controls the main band only. Push the desired band switch: [VHF], [UHF] or [1.2G] in advance to change the main band.

■ Using a tuning dial

- ① Rotate the desired band's tuning dial to set the frequency.
 - If VFO mode is not selected, push the desired band's [V/MHz] to select VFO mode.
 - Frequency changes according to the selected tuning steps. (p. 22)
- ② For the 1 MHz frequency setting, rotate the desired band's tuning dial after pushing [V/MHz].
 - Pushing [V/MHz] for 1 sec. selects the 10 MHz tuning step in some versions.

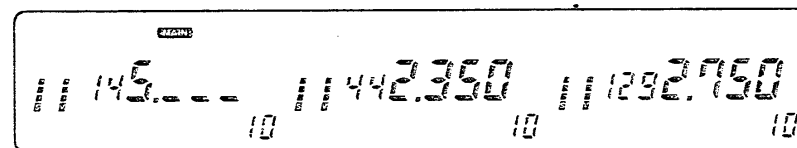

The display shows that the 1 MHz tuning step is selected in VHF.

Using [UP]/[DN] switches



Push [UP] or [DN] to set the main band's frequency in the selected tuning steps.



- If VFO mode is not selected, push [③ VFO] to select VFO mode.
- Frequency changes according to the selected tuning steps.
- Pushing [UP] or [DN] for more than 0.5 sec. will activate scan.
- If the scan is started, push [UP] or [DN] again to stop it.

Tuning step selection

USING SET MODE

Tuning steps are the minimum frequency change increments when you rotate the tuning dial or push the [UP]/[DN] keys on the microphone. Separate tuning steps can be specified for each band. The following tuning steps are available.

- 5 kHz*¹
- 10 kHz
- 12.5 kHz
- 15 kHz*¹
- 20 kHz
- 25 kHz
- 30 kHz*²

*¹ VHF and UHF only.

*² 1.2 GHz band only.

NOTE: For your convenience, select a tuning step that matches the frequency intervals of repeaters in your area.

- ① Push the desired band's tuning dial.
- ② Push the desired band's [V/MHz] to select VFO mode if another mode has been selected.
- ③ Push [SET] one or more times until "dP" appears as shown below.
 - Pushing [SPCH] reverses the order. (p. 18)
 - Cancel the DTMF memory function, optional pager or code squelch in advance. (pgs. 54, 64, 67)
- ④ Rotate the selected band's tuning dial to select the tuning step.
- ⑤ Push the selected band's tuning dial to exit set mode.

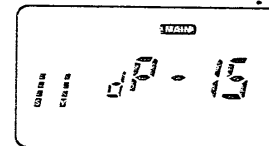

15 kHz tuning step

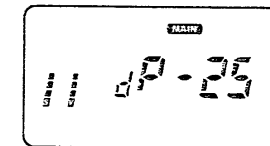

25 kHz tuning step



- ① Push the desired band switch.
- ② Push [③ VFO] to select VFO mode.
- ③ Push [Ⓑ SET] one or more times until "dP" appears as shown above.
 - Pushing [Ⓒ SPCH] reverses the order. (p. 18)
 - Cancel the DTMF memory function, optional pager or code squelch in advance. (pgs. 54, 64, 67)
- ④ Push [UP] or [DN] to select the tuning step.
- ⑤ Push [Ⓐ CLR] to exit set mode.

4 SETTING A FREQUENCY

Using the keyboard

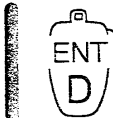
 The frequency can be directly set via numeral keys on the microphone.

- 1 Push the desired band switch.
- 2 Push [**3** VFO] to select VFO mode.
- 3 Push [**D** ENT] to activate the keyboard for digit input.
- 4 Push 5 or 6 appropriate digit keys to input a frequency.
 - When an undesired digit is input, push [**A** CLR] to clear the input, then start again from step 3.
 - An out-of-band frequency cannot be entered.
- 5 Push [UP] or [DN] to make adjustments below the 10 kHz digit, if desired.

[EXAMPLE]: Setting the frequency to 145.360 MHz.

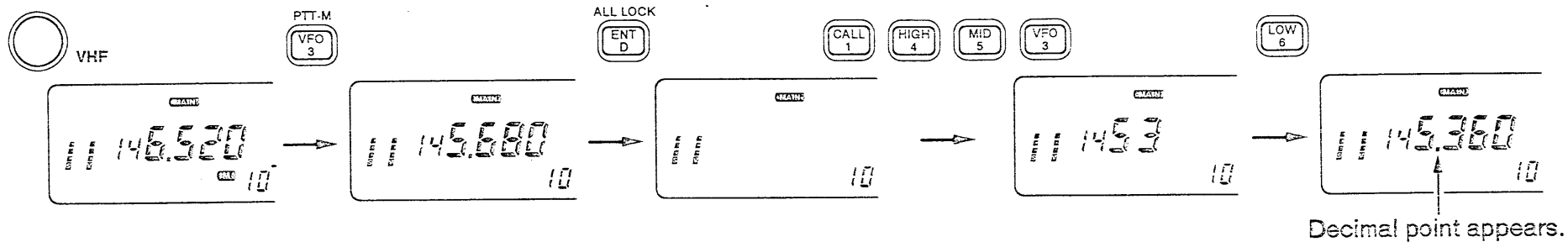

[EXAMPLE]: Setting the frequency to 1295.325 MHz. (When the 25 kHz tuning step is selected on the 1.2 GHz band.)

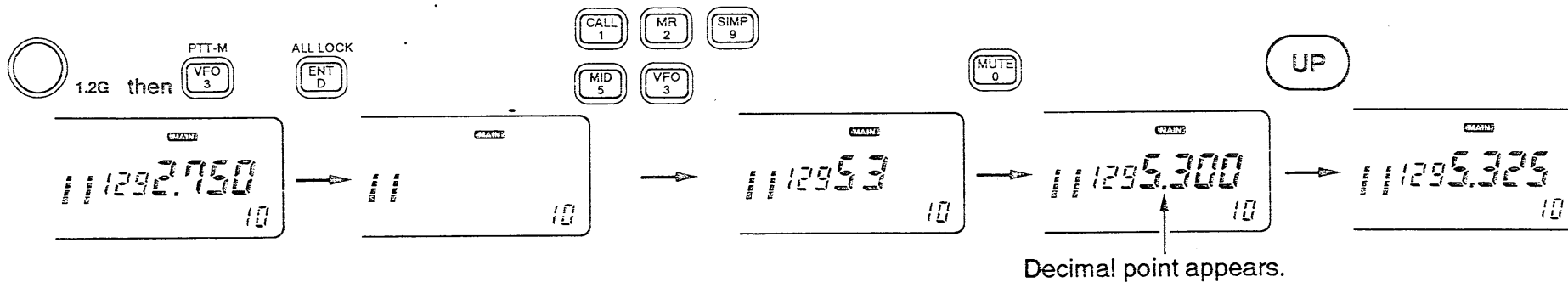

Receiving

The transceiver can receive a 144 MHz, a 430(440) MHz and a 1.2 GHz band signal simultaneously.

- ① Push [PWR] IN to turn power ON.
- ② Set the audio levels.
 - Push the desired band's [SQL] one or more times until noise is emitted. (Squelch opens.)
 - Rotate the desired band's [VOL] to adjust the audio output level.
 - Push the desired band's [SQL] one or more times until noise is muted. See p. 25 for setting the squelch level.
 - Set the other bands' audio and squelch levels, if desired.
- ③ Set the operating frequency. (pgs. 19–23)
- ④ When receiving a signal on the set frequency, squelch opens and the transceiver emits audio.
 - The S/Rf indicator shows the relative signal strength on the received band.
 - The RIT/VXO function is available for fine tuning on the 1.2 GHz band. (p. 58)

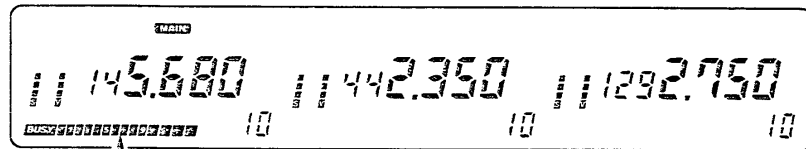

When receiving a signal on VHF.



- ① Push [PWR] to turn power ON.
 - To remotely turn power ON and OFF, push [PWR] on the remote controller IN in advance.



- ② Set the audio levels.
 - Push the desired band switch.
 - Push [⊕ MONI] to open the squelch.
 - Push [▲ VOL] or [▼ VOL] on the microphone front panel to adjust the audio output level.
 - Push [⊕ MONI] to cancel the monitor function.
 - Push [⊕ SQL] one or more times until noise is muted. See p. 25 for setting the squelch level.
 - Set the other bands' audio and squelch levels, if desired.
- ③ Set the operating frequency. (pgs. 19–23)

5 BASIC OPERATION

■ Setting a squelch level

A squelch circuit allows you to mute undesired audio noise while receiving no signal and emit audio while receiving signals. This provides quiet standby.

- The [DTMF/MONI] switch bypasses the mute circuit without changing the squelch setting. This is useful for weak signal reception. (p. 26)

◇ 4-step digital squelch

The transceiver has 34 selectable squelch levels. For rapid and easy setting, 4 preset squelch levels are available.

Push the desired band's [SQL] one or more times to set the squelch level.

- 
- 1 Push the desired band switch.
 - 2 Push [⊕SQL] one or more times to set the squelch level.

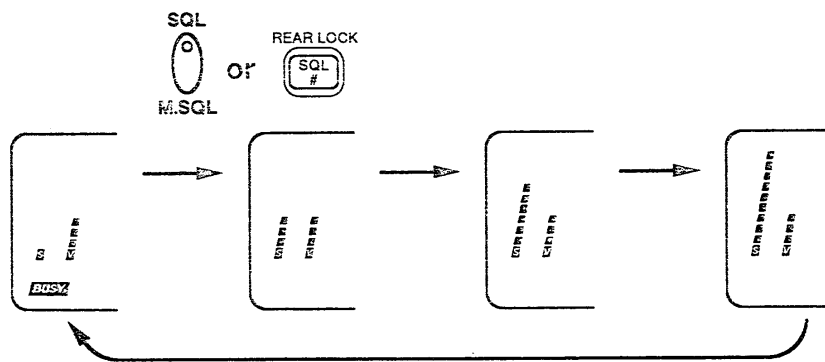

◇ Manual squelch

- 1 Push the desired band's [SQL/M.SQL] for 1 sec.
 - "SQL" starts blinking.
- 2 Rotate the desired band's [VOL] to vary the squelch level manually.
- 3 Push [SQL] to set the squelch level.
 - "SQL" stops blinking.



- 1 Push the desired band switch.
- 2 Push [▲SQL] or [▼SQL] to adjust the squelch level.

◇ Automatic squelch setting

The transceiver can be set to the squelch threshold point automatically.

- 1 Push the desired band's [SQL/M.SQL] for 1 sec.
 - "SQL" starts blinking.
- 2 Push the desired band's [SQL/M.SQL] for 1 sec. again to set the squelch to the threshold point.
 - The squelch level changes from minimum to the threshold point automatically.
- 3 If the squelch level becomes maximum, set the frequency to an open frequency; then, repeat steps 1 and 2 above.

Monitor function

This function is used to listen to weak signals without disturbing the squelch setting or to open the main band's squelch manually even when the optional pager, code squelch, pocket beep or tone squelch is in use.

Push and hold [DTMF/MONI] to open the main band's squelch.

- While duplex is ON for repeater operation, the transmitting frequency can be monitored with [DTMF/MONI].



- 1 Push the desired band switch.
- 2 Push [⊗ MONI] to open the main band's squelch.

Audio mute function



This function mutes all bands' audio signals quickly without disturbing the volume setting.

- 1 Push [⊙ MUTE] to mute all bands' audio signals.
 - The volume level indicators blink.
- 2 Push [⊙ MUTE] again to cancel the function.
 - The volume level indicators stop blinking.

RF attenuator

The transceiver has a 20 dB (approx.) RF attenuator for VHF and UHF. The attenuator does not allow reception of weak signals. This attenuator, therefore, is useful for short-distance contacts since undesired long-distance signals will be eliminated.

- 1 Push the VHF or UHF tuning dial.
- 2 Push and hold [LOW/ATT/AFC] until "ATT" appears.
 - To cancel the function, push and hold [LOW/ATT/AFC] until "ATT" disappears.
 - The RF attenuator can be separately set in VHF or UHF.
 - "◀ ▶" appears instead of "ATT" when receiving a 430(440) MHz signal on the 1.2 GHz display. (p. 29)

"ATT" appears.

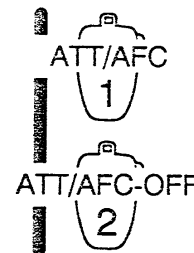
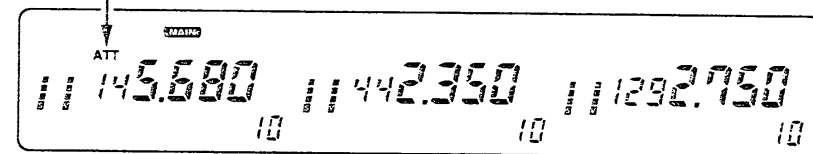

- 1 Push [VHF] or [UHF].
- 2 Push [FUNC] then [1 ATT/AFC] to turn the RF attenuator ON.
- 3 Push [FUNC] then [2 ATT/AFC-OFF] to turn the RF attenuator OFF.

5 BASIC OPERATION

■ Sub band access

This function allows you to change sub band settings such as frequency and duplex settings, especially useful from the microphone, while transmitting or receiving on the main band.

It is easy to access the sub band and return to the main band with the band switch.

- ① Push and hold the desired non-main band's tuning dial until "SUB" appears as shown below.
 - The main band still functions for receiving and transmitting.
 - When the main band's tuning dial is pushed, the para-watch function is activated. In this case, push and hold the main band's tuning dial for 1 sec. and repeat ① again. (p. 29)

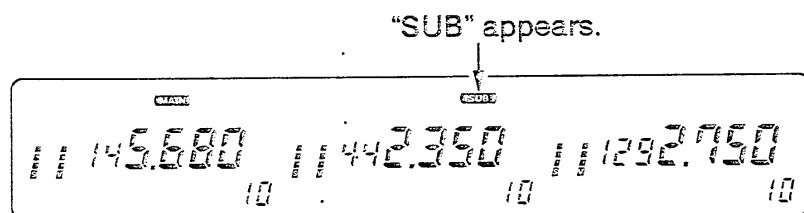

- ② Set a sub band's operating frequency or activate functions.
 - The main band's output power cannot be changed while accessing the sub band.

Downloaded by
RadioAmateur.EU

- ③ To exit the sub band access, push the main band's tuning dial.
 - Pushing and holding the sub band's tuning dial until "SUB" disappears also exits the sub band access.
 - To switch from the sub band to the main band, push the sub band's tuning dial.



The sub band access function is also available from the microphone and is useful for setting the sub band's frequency, etc. while operating on the main band.

- ① Push [FUNC]; then, push the desired non-main band's band switch: [VHF], [UHF] or [1.2G].
 - "SUB" appears above the frequency display.
 - The main band still functions for receiving and transmitting.
- ② Set a sub band's operating frequency or activate functions.
 - The main band's output power cannot be changed while accessing the sub band.
- ③ To exit the sub band access, push the main band's band switch.
 - "SUB" disappears.
 - To switch from the sub band to the main band, push the sub band's band switch.

■ Sub band mute/ sub band busy beep

USING SET MODE

The sub band mute function automatically cuts out sub band AF signals when both main and a sub band's signals are received.

The sub band busy beep sounds when a sub band's squelch is closed to inform you that the sub band's squelch has been opened.

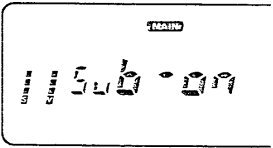

The display shows that the sub band mute is turned ON and the sub band busy beep is turned OFF.

Common setting for each band.

- ① Push [SET] one or more times until "Sub" appears in the display as shown above.
 - Pushing [SPCH] reverses the order. (p. 18)
 - Cancel the DTMF memory function, optional pager or code squelch in advance. (pgs. 54, 64, 67)

- ② Rotate the main band's tuning dial to set the condition.

DISPLAY	SUB BAND MUTE	BUSY BEEP
Sub - oF	OFF	OFF
Sub - oF ((·))	OFF	ON
Sub - on	ON	OFF
Sub - on ((·))	ON	ON

- ③ Push the main band's tuning dial to exit set mode.



- ① Push [SET] one or more times until "Sub" appears in the display as shown at left.
 - Pushing [SPCH] reverses the order. (p. 18)
 - Cancel the DTMF memory function, optional pager or code squelch in advance. (pgs. 54, 64, 67)
- ② Push [UP] or [DN] to set the desired condition as shown in the table above.
- ③ Push [CLR] to exit set mode.

5 BASIC OPERATION

■ Reduced band operation

Any band that is not necessary for operation can be turned OFF. Reduced band operation cuts down current consumption by turning OFF the circuit of the band not displayed.

◇ Deactivating a band

- ① Push [PWR] on the transceiver OUT to turn power OFF.
- ② While pushing and holding the desired band's tuning dial, push [PWR] IN to turn the desired band OFF.
 - Any 1 or 2 bands can be turned OFF.
 - The frequency display disappears while the circuit of the band is turned OFF.

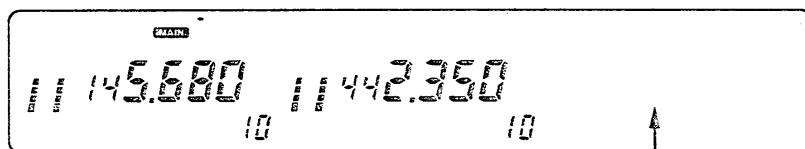

The 1.2 GHz band is turned OFF.

◇ Activating a band

- ① Push [PWR] on the transceiver OUT to turn power OFF.
- ② While pushing and holding the deactivated band's tuning dial, push [PWR] IN to turn the circuit of the band ON.

■ Para-watch

The transceiver can receive 2 frequencies simultaneously on the VHF band or can receive 2 or 3 frequencies simultaneously on the UHF band using the para-watch function.

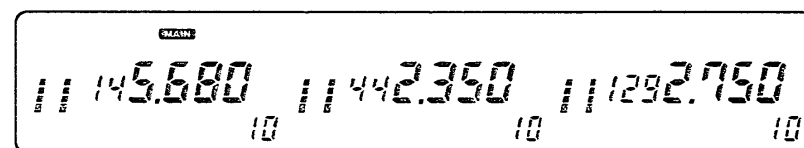

↑ Can be switched
between VHF and
UHF.

↑ Can be switched
between 1.2 GHz
and UHF.

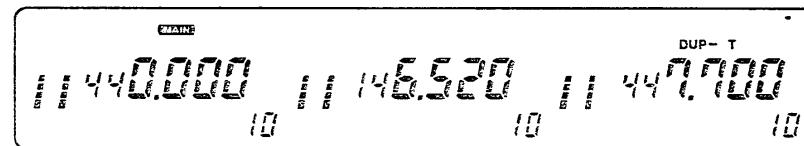

- ① Push the desired band's tuning dial.
 - The VHF band can receive a 430(440) MHz signal; the UHF band can receive a 144 MHz signal; the 1.2 GHz band can receive a 430(440) MHz signal.
- ② Push and hold the desired band's tuning dial until "-144-" or "-430-" appears to change the operating band.
- ③ Push and hold the desired band's tuning dial until "-144-," "-430-" or "-1200-" appears to cancel the function.
 - When the sub band access function is in use, the operation is ignored. Cancel the sub band access function in advance.

NOTE:

- The frequency which would normally be in the other band is weaker.
- The S-meter indication on the para-watch frequency may differ from regular indication.
- The RF attenuator simultaneously activates while receiving 2 or 3 frequencies on the same band.
- Memory channels are common for the same band.
- Transmitting on the para-watch frequency is possible and the transmission quality is the same as usual.
- During main band transmitting, the receive frequency on the same band is muted.

[EXAMPLE]

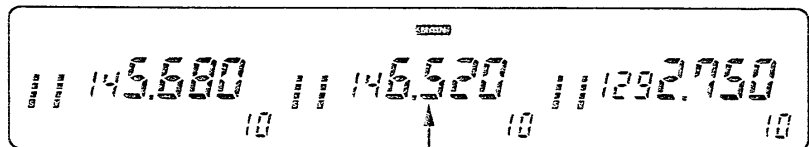

Receiving a VHF signal

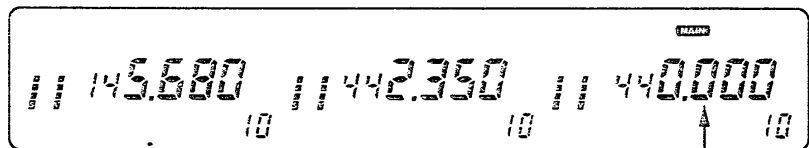

Receiving a UHF signal

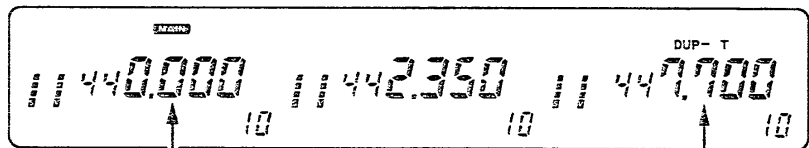

Receiving a UHF signal

Receiving a UHF signal



- 1 Push the desired band switch.
- 2 Push and hold the desired band switch until "-144-" or "-430-" appears to change the operating band.
- 3 Push and hold the desired band switch until "-144-," "-430-" or "-1200-" appears to cancel the function.

5 BASIC OPERATION

■ Transmitting

CAUTION: Transmitting without an antenna may damage the transceiver.

NOTE: To prevent interference, listen on the frequency before transmitting by pushing [⊕MONI] or by pushing and holding [DTMF/MONI].

NOTE: To prevent howling and sensitivity rejection, AVOID setting the 430(440) MHz or 1.2 GHz band frequencies near a multiple of the 144 MHz or 430(440) MHz band frequencies, respectively; e.g. setting for 145 MHz and 435 MHz; 432 MHz and 1296 MHz.

- ① Push the desired band's tuning dial to select the main band for transmitting.
- ② Set the operating frequency. (pgs. 19–23)
 - Select output power, if desired. See section at right for details.
- ③ Push and hold [PTT] to transmit.
 - "TX" appears.
 - The S/RF indicator shows the output power selection.
 - One-touch PTT function is available. See p. 32 for details.
- ④ Speak into the microphone using your normal voice level.
 - DO NOT hold the transceiver too close to your mouth or speak too loudly. This may distort the signal.
- ⑤ Release [PTT] to return to receive.

■ Selecting the output power

The transceiver has 2 or 3 output power levels to suit your operating requirements. Lower output power during short-distance communication may reduce interference to other stations and reduces current consumption.

- ① Push the desired band's tuning dial.
- ② Push [LOW] one or more times to select the desired output power.

POWER SELECTION	S/RF INDICATOR	OUTPUT POWER		
		VHF	UHF	1.2G
HIGH		50 W	35 W	10 W
LOW 2 (LPo-2)	LOW 	10 W	10 W	N/A
LOW 1 (LPo-1)	LOW 	5 W	5 W	1 W

Above values are typical.



The microphone can select the desired output power directly.

- ① Push the desired band switch.
 - ② Push [④HIGH] for high output power; push [⑤MID] for low output power 2* (middle); push [⑥LOW] for low output power 1.
- * VHF and UHF only.

■ Crossband double duplex

The transceiver can receive 2 signals on the sub bands while transmitting on the main band. Using this capability, crossband double duplex operation or crossband full duplex operation is possible. No special setting is necessary for crossband duplex operation.

- ① Set the desired transmit and receive frequencies on the main and sub bands respectively for your transceiver. (pgs. 19–23)
 - 1 receive frequency for crossband full duplex; 2 receive frequencies for crossband double duplex.
- ② Set the same frequencies, but select your receiving band as the main band for the other transceiver.
- ③ For the crossband double duplex operation, set the same frequencies, but select the remaining band as the main band for the 3rd transceiver.
- ④ Push and hold [PTT] to operate with full duplex.
 - Transmitting and receiving activate simultaneously.

Transmitting on VHF.

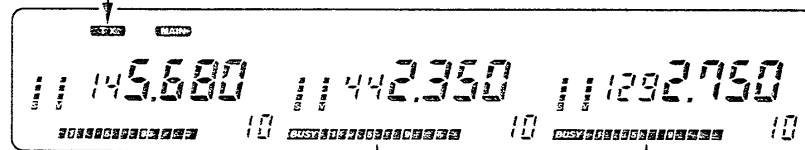

Receiving on UHF and 1.2 GHz bands.

■ One-touch PTT function



The PTT switch can be operated as a one-touch PTT switch (transmit/receive switch). Using this function, you can transmit without pushing and holding the PTT switch.

To prevent accidental continuous transmission with the one-touch PTT function, the transceiver has a time-out timer. See p. 74 for details.

- ① Push [FUNC], then, push [③ PTT-M] to turn the one-touch PTT function ON.
 - The active indicator on the microphone front panel lights up in green.
- ② Push [PTT] to transmit and push it again to receive.
 - 2 beeps sound when transmission is started and a long beep sounds when returning to receive.
 - “” blinks while transmitting with the one-touch PTT function.
- ③ Push [FUNC], then, push [③ PTT-M] to turn the one-touch PTT function OFF.
 - The active indicator goes out.

■ Operation

A repeater amplifies a received signal and transmits it at a different frequency. When using a repeater, the transmit frequency is shifted from the receive frequency by the offset frequency. (p. 36) It is convenient to program repeater information into a memory channel. (p. 38)

[REPEATER SIMULATION]

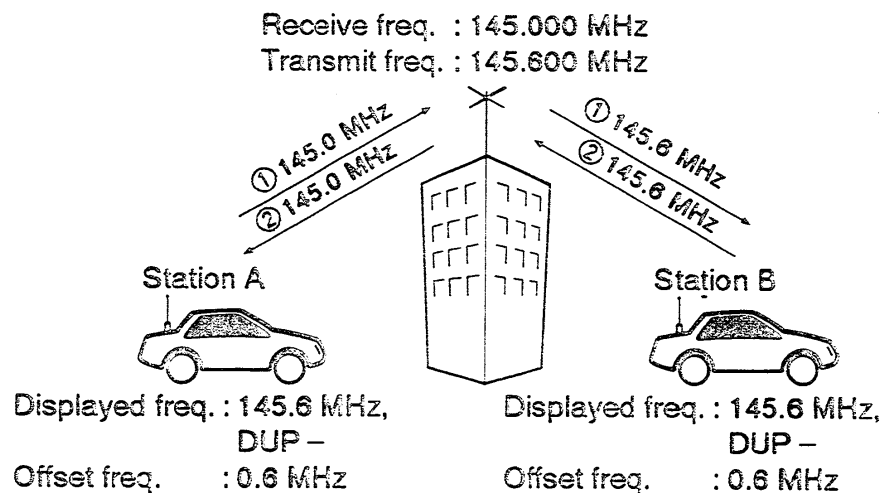

- ① Push the desired band's tuning dial.
- ② Set the receive frequency (repeater output frequency). (pgs. 19-23)
- ③ Push [DUP] to select -duplex or push it again for + duplex.
 - "DUP -" or "DUP" appears to indicate the transmit frequency for minus shift or plus shift, respectively.

- ④ Push and hold [PTT] to transmit.
 - Push and hold [DTMF/MONI] to check whether the other station's transmit signal can be directly received or not.
 - The displayed frequency automatically changes to the transmit frequency (repeater input frequency).
 - When the repeater requires a tone, see the page at right.
 - If "oFF" appears, confirm the offset frequency. (p. 36)
- ⑤ Release [PTT] to receive.
- ⑥ To return to simplex, push [DUP] once or twice to clear the "DUP" indicator.



- ① Push the desired band switch.
- ② Set the receive frequency (repeater output frequency). (pgs. 19-23)



- ③ Push [⑦ DUP -] to select -duplex; push [⑧ DUP +] for + duplex.

- ④ Push and hold [PTT] to transmit.
 - Push [⊗ MONI] to check whether the other station's transmit signal can be directly received or not.



- ⑤ Release [PTT] to receive.
- ⑥ To return to simplex, push [⑨ SIMP].

■ Tone information

◇ Subaudible tone

To access some closed repeaters, the transmit signal needs to superimpose a correct subaudible tone. Turn the subaudible tone encoder ON in this case. To set the subaudible tone frequency, see "Subaudible tone" on p. 35. An optional UT-76 is necessary except for 88.5 Hz tones for non-U.S.A. versions.

- ① Push and hold [DUP/TONE] for 1 sec. one or more times until only "T" appears on the main band's display to turn ON the subaudible tone encoder.
- ② Push and hold [DUP/TONE] for 1 sec. one or more times until "T" disappears to turn OFF the subaudible tone encoder.

Shows that the subaudible tone encoder is ON.

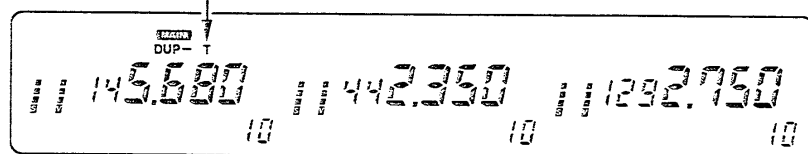

- ① Push [FUNC], then, push [7 TONE] to turn the subaudible tone encoder ON.



- ② Push [FUNC], then, push [C T-OFF] to turn the subaudible tone encoder OFF.

◇ DTMF tones



- ① Push [DTMF KEY] to turn the DTMF encoder ON.
 - The mode indicator lights up in green.
 - Cancel the DTMF memory function, optional pager or code squelch in advance. (pgs. 54, 84, 87)
- ② Push the desired digit key to transmit DTMF tones.
 - The transceiver has 14 DTMF memory channels. See p. 54 for details.
- ③ Push [DTMF KEY] to turn the DTMF encoder OFF.
 - The mode indicator goes out.

◇ 1750 Hz tone

A 1750 Hz tone is necessary to activate some European repeaters. The transceiver has 1750 Hz tone capability.



- ① Push [DTMF MEMO] to set the microphone to the DTMF memory reading condition.
 - The mode indicator lights up in orange.
- ② Push [⊗ MONI] to transmit a 1750 Hz tone call signal for 0.5 sec.; push and hold [⊕ SQL] for a desired period to transmit a 1750 Hz tone call signal continuously.
 - The mode indicator goes out automatically.

6 REPEATER OPERATION

Subaudible tone USING SET MODE

(An optional UT-76 is necessary for non-U.S.A. versions.)

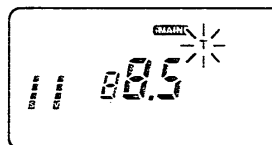

The display shows that an 88.5 Hz subaudible tone frequency.

Separate setting for each band.

- 1 Push the desired band's tuning dial.
- 2 Select the desired mode or channel you wish to set the subaudible tone frequency to, such as VFO mode, memory channel or call channel.
 - The subaudible tone frequency is independently programmed into each mode or channel.
- 3 Push [SET] one or more times until "T" appears and blinks as shown above.
 - Pushing [SPCH] reverses the order. (p. 18)
 - Cancel the DTMF memory function, optional pager or code squelch in advance. (pgs. 54, 64, 67)
- 4 Rotate the selected band's tuning dial to select and set the desired frequency.
- 5 Push the selected band's tuning dial to exit set mode.



- 1 Push the desired band switch.
- 2 Select the desired mode or channel you wish to set the subaudible tone frequency to, such as VFO mode, memory channel or call channel.
 - The subaudible tone frequency is independently programmed into each mode or channel.
- 3 Push [SET] one or more times until "T" appears and blinks as shown at left.
 - Pushing [SPCH] reverses the order. (p. 18)
 - Cancel the DTMF memory function, optional pager or code squelch in advance. (pgs. 54, 64, 67)
- 4 Push [UP] or [DN] to select and set the desired frequency.
 - Pushing and holding [UP] or [DN] changes the frequency continuously.
- 5 Push [CLR] to exit set mode.

• Subaudible tone frequency list.

67.0	82.5	100.0	123.0	151.4	186.2	233.6
69.3	85.4	103.5	127.3	156.7	192.8	241.8
71.9	88.5	107.2	131.8	162.2	203.5	250.3
74.4	91.5	110.9	136.5	167.9	210.7	
77.0	94.8	114.8	141.3	173.8	218.1	
79.7	97.4	118.8	146.2	179.9	225.7	

(Unit: Hz)

Offset frequency USING SET MODE

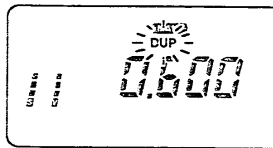

The display shows that a 0.6 MHz (600 kHz) offset frequency.

Separate setting for each band.

- ① Push the desired band's tuning dial.
- ② Select the desired mode or channel you wish to set the offset frequency to, such as VFO mode, memory channel or call channel.
 - The offset frequency is independently programmed into each mode or channel.
- ③ Push [SET] one or more times until "DUP" appears and blinks as shown above.
 - Pushing [SPCH] reverses the order. (p. 18)
 - Cancel the DTMF memory function, optional pager or code squelch in advance. (pgs. 54, 64, 67)
- ④ Rotate the selected band's tuning dial to set the desired frequency.
 - Selectable step increment is the same as the preset tuning step. (p. 22)
 - Use [V/MHz] for quick MHz setting.
- ⑤ Push the selected band's tuning dial to exit set mode.



- ① Push the desired band switch.
- ② Select the desired mode or channel you wish to set the offset frequency to, such as VFO mode, memory channel or call channel.
 - The offset frequency is independently programmed into each mode or channel.
- ③ Push [SET] one or more times until "DUP" appears and blinks as shown at left.
 - Pushing [SPCH] reverses the order. (p. 18)
 - Cancel the DTMF memory function, optional pager or code squelch in advance. (pgs. 54, 64, 67)
- ④ Push [UP] or [DN] to set the desired frequency.
 - Selectable step increment is the same as the preset tuning step. (p. 22)
 - Pushing and holding [UP] or [DN] changes the frequency continuously.
- ⑤ Push [CLR] to exit set mode.

General description

The transceiver has 100 regular memory channels plus 6 scan edge memory channels on each band; each of these can be individually programmed with the following data.

- Operating frequency (pgs. 19–23)
- Duplex direction (DUP or DUP –) (p. 33)
- Offset frequency (p. 36)
- Subaudible tone frequency*¹ (p. 35)
- Subaudible tone encoder ON/OFF (p. 34)
- Tone squelch ON/OFF*² (p. 69)
- Skip information*³ (p. 50)

*¹ An optional UT-76 TONE SQUELCH UNIT is necessary for non-U.S.A. versions.

*² An optional UT-76 TONE SQUELCH UNIT is necessary.

*³ Except for the scan edge memory channels.

Two additional great features are also available: ① Usable memory channel area can be specified for quick memory channel selection (p. 41), and ② A separate memory bank. This means that a total of 200 + 12 memory channels can be used on each band. (p. 41)

Downloaded by
RadioAmateur.EU

Memory channel selection

Using a tuning dial

- ① Push the desired band's [M/CALL] once or twice to display "MR" and a memory channel number.
- ② Rotate the desired band's tuning dial to select the desired memory channel.

Using [UP]/[DN] switches



- ① Push the desired band switch.
- ② Push [MR] to select memory mode.
- ③ Push [UP] or [DN] several times to select the desired memory channel.
 - Pushing [UP] or [DN] for more than 0.5 sec. will activate scan:
 - If the scan is started, push [UP] or [DN] again to stop it.

Using the keyboard



- ① Push the desired band switch.
- ② Push [MR] to select memory mode.
- ③ Push [ENT] to activate the keyboard for numeral input.
- ④ Push 2 appropriate digit keys to input a channel number.
 - Any memory channel which is outside of the memory area is cleared. (p. 41)

■ Programming a memory channel

VFO mode settings, including the set mode contents such as subaudible tone frequency, etc., are programmed into a memory channel.

- ① Push the desired band's tuning dial.
- ② Select the memory channel to be programmed:
 - Push the desired band's [M/CALL] once or twice to select memory mode. ("MEMO" appears.)
 - Rotate the desired band's tuning dial to select the memory channel.

- ③ Set the desired frequency in VFO mode:
 - Push the desired band's [V/MHz] to select VFO mode.
 - Set the desired frequency using the desired band's tuning dial.
 - Set other data (e.g. offset frequency, duplex direction, subaudible tone encoder ON/OFF and its frequency), if required.
- ④ Push and hold [SPCH/MW] for 1 sec. to program.
 - If the beep tone is ON, 3 beeps alert you that the VFO contents, including duplex information, subaudible tone frequency, etc., are programmed.

[EXAMPLE]: Programming 145.320 MHz into memory channel 20 via the remote controller.

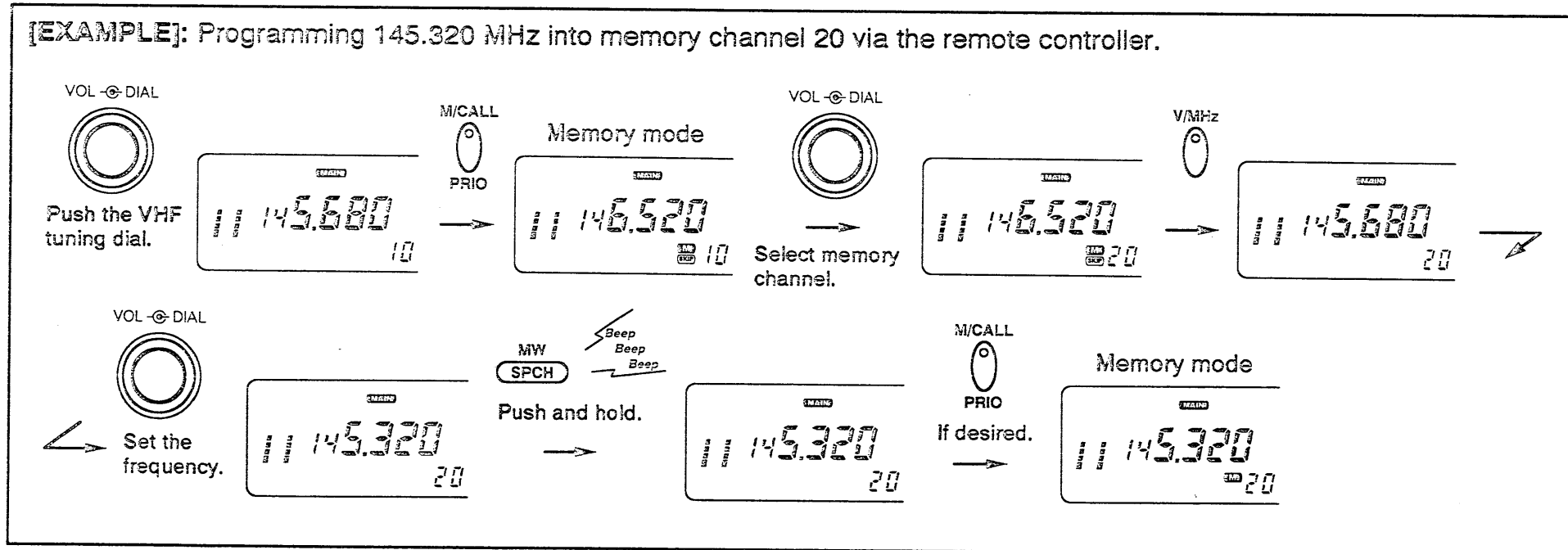

7 MEMORY OPERATION

■ Programming a memory channel via the microphone

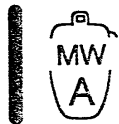

Memory channel programming can be performed via the microphone.

- 1 Push the desired band switch.
- 2 Select the memory channel to be programmed:
 - Push [MR] to select memory mode. ("MEM" appears.)
 - Push [UP] or [DN] to select the memory channel.
 - Push [ENT]; then, push the desired memory channel number (2 digits) to select the memory channel directly.
- 3 Set the desired frequency in VFO mode:
 - Push [VFO] to select VFO mode.
 - Set the desired frequency using the keyboard.
 - Set other data (e.g. offset frequency, duplex direction, sub-audible tone encoder ON/OFF and its frequency), if required.
- 4 Push [FUNC], then, push and hold [MW] for 1 sec. to program.
 - If the beep tone is ON, 3 beeps alert you that the VFO contents, including duplex information, subaudible tone frequency, etc., are programmed.

[EXAMPLE]: Programming 145.320 MHz into memory channel 20 via the microphone.

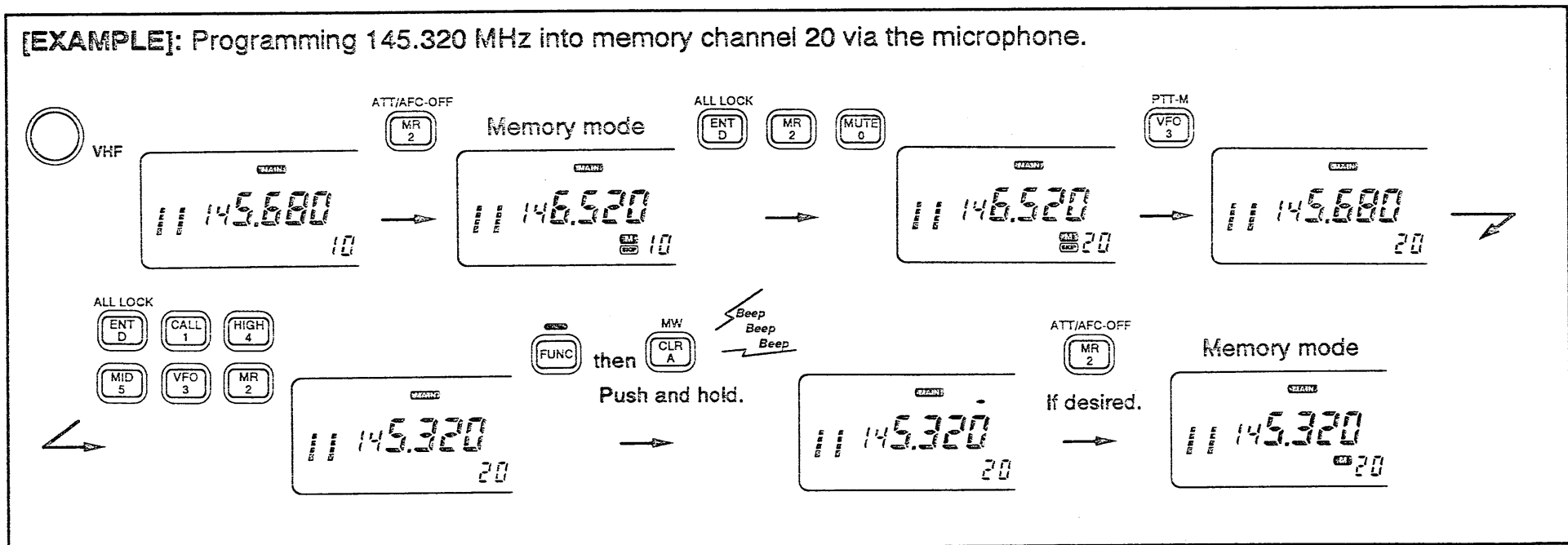

■ Transferring memory contents

This function transfers a memory channel's contents into a VFO. This is useful when searching for signals around a memory channel frequency and for recalling the offset frequency, subaudible tone frequency, etc.

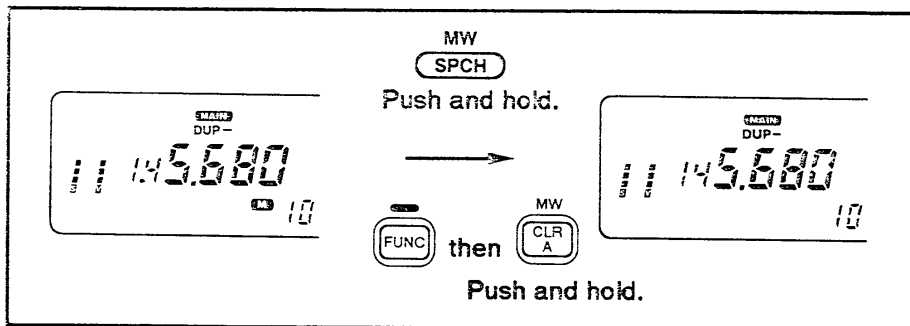

- ① Push the desired band's tuning dial.
- ② Select the memory channel to be transferred:
 - Push the desired band's [M/CALL] once or twice to select memory mode. ("M" appears.)
 - Rotate the desired band's tuning dial to select the memory channel.
- ③ Push and hold [SPCH/MW] for 1 sec.
 - "M" disappears as VFO mode is automatically selected.
 - If the beep tone is ON, 3 beeps alert you that the memory channel contents, including duplex information, subaudible tone frequency, etc., are transferred.



- ① Push the desired band switch.
- ② Select the memory channel to be transferred:
 - Push [MR] to select memory mode.
 - Push [UP] or [DN] to select the memory channel.
 - Push [ENT]; then, push the desired memory channel number (2 digits) to select the memory channel directly.
- ③ Push [FUNC]; then, push and hold [MW] for 1 sec.
 - "M" disappears as VFO mode is automatically selected.
 - If the beep tone is ON, 3 beeps alert you that the memory channel contents, including duplex information, subaudible tone frequency, etc., are transferred.

7 MEMORY OPERATION

Memory area setting

USING SET MODE

The usable range of memory channels on each band can be specified. This function speeds up memory scan or memory channel selection with the tuning dial or [UP]/[DN] keys. Memory area setting does not clear the memory contents.

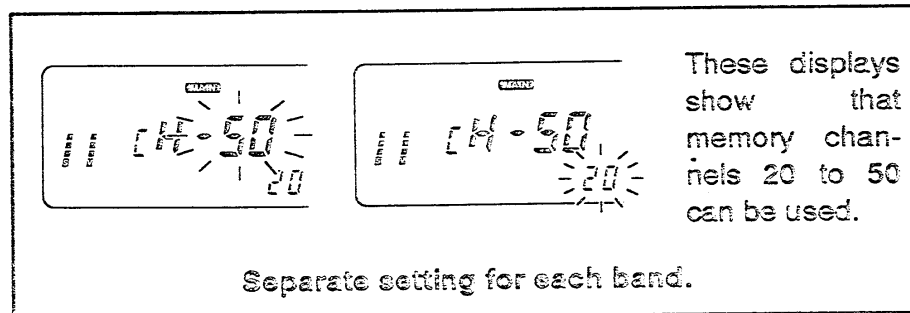

- ① Push the desired band's tuning dial.
- ② Push [SET] one or more times until "CH-99" (or another number) appears and "-99" blinks as shown above.
 - Pushing [SPCH] reverses the order. (p. 18)
 - Cancel the DTMF memory function, optional pager or code squelch in advance. (pgs. 54, 64, 67)
- ③ Rotate the selected band's tuning dial to set the desired channel number.
- ④ Push [SET]; then, rotate the selected band's tuning dial to set the other desired channel number.
- ⑤ Push the selected band's tuning dial to exit set mode.



- ① Push the desired band switch.
- ② Push [SET] one or more times until "CH-99" (or another number) appears and "-99" blinks as shown at left.
 - Pushing [SPCH] reverses the order. (p. 18)
 - Cancel the DTMF memory function, optional pager or code squelch in advance. (pgs. 54, 64, 67)
- ③ Push [UP] or [DN] to set the desired channel number.
 - Pushing and holding [UP] or [DN] changes the frequency continuously.
- ④ Push [SET] then [UP] or [DN] to set the other desired channel number.
- ⑤ Push [CLR] to exit set mode.

Memory bank selection

The transceiver has 2 separate memory banks for convenience when 2 persons operate the transceiver. Each memory bank has 106 memory channels, 3 VFO's and 3 call channels.

- ① Push [PWR] on the transceiver OUT to turn power OFF.
- ② While pushing [SET] and [LOW], turn power ON to toggle between memory banks.

■ Calling up a call channel

Each band has an independent call channel to store a most-often-used frequency for quick recall.

- ① Push the desired band's [M/CALL] once or twice to display a large "C" in the memory channel readout.
 - To transmit on the call channel, select the desired band as the main band in advance.
- ② To return to VFO mode, push the selected band's [V/MHz]; to return to memory mode, push the selected band's [M/CALL] again.

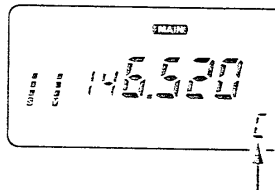

Large "C" shows the call channel is selected.

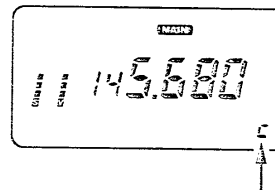

Small "c" shows VFO mode is selected from the call channel.



- ① Push the desired band switch.
- ② Push [① CALL] to select the call channel.

■ Transferring call channel contents

- ① Push the desired band's tuning dial.
- ② Push the desired band's [M/CALL] once or twice to display a large "C" in the memory channel readout.
- ③ Push and hold [SPCH/MW] for 1 sec.
 - The large "C" changes to a small "c."
 - If the beep tone is ON, 3 beeps alert you that the call channel contents, including duplex information, subaudible tone frequency, etc., are transferred.



- ① Push the desired band switch.
- ② Push [① CALL] to select the call channel.
- ③ Push [FUNC]; then, push and hold [Ⓐ MW] for 1 sec.
 - The large "C" changes to a small "c."
 - If the beep tone is ON, 3 beeps alert you that the call channel contents, including duplex information, subaudible tone frequency, etc., are transferred.

8 CALL CHANNEL OPERATION

■ Programming a call channel

As well as an operating frequency, duplex information and subaudible tone* information (tone encoder or tone squelch ON/OFF and its frequency) can be programmed into the call channel.

* Optional for non-U.S.A. versions.

- ① Push the desired band's tuning dial.
- ② Push the desired band's [M/CALL] once or twice to display a large "C" in the memory channel readout.
- ③ Set the desired frequency in VFO mode:
 - Push the desired band's [V/MHz] to select VFO mode.
 - Set the desired frequency using the desired band's tuning dial.
 - Set other data (e.g. offset frequency, duplex direction, sub-audible tone encoder ON/OFF and its frequency), if required.

- ④ Push and hold [SPCH/MW] for 1 sec. to program.
 - If the beep tone is ON, 3 beeps alert you that the VFO contents, including duplex information, subaudible tone frequency, etc., are programmed.

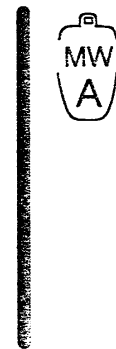

- ① Push the desired band switch.
- ② Push [① CALL] to select the call channel.
- ③ Set the desired frequency in VFO mode:
 - Push [③ VFO] to select VFO mode.
 - Set the desired frequency using the keyboard.
 - Set other data, if required.
- ④ Push [FUNC], then, push and hold [Ⓐ MW] for 1 sec. to program.

[EXAMPLE]: Programming 145.120 MHz into the VHF call channel via the microphone.

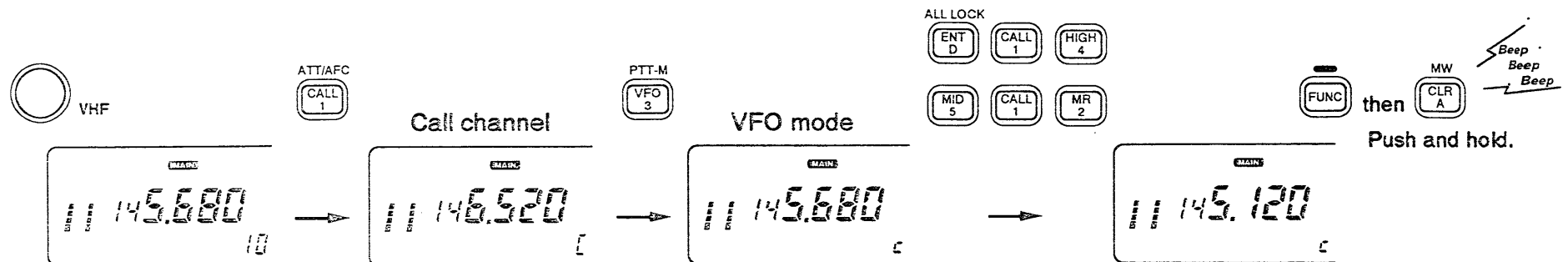

Scan types

Scanning searches for transmitted signals automatically and makes it easier to locate new stations for contact or listening purposes.

Each band has 3 scan types and 5 resume conditions to suit your needs. Scans on the 3 bands can be operated separately or simultaneously.

FULL SCAN (p. 45)

Repeatedly scans all frequencies over the entire selected band. Used as the simplest scan without any presetting.

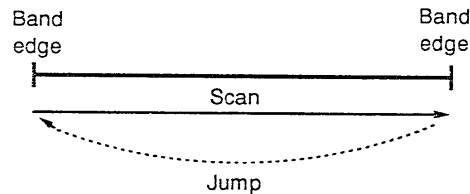

PROGRAMMED SCAN (p. 45)

Repeatedly scans between two user-programmed frequencies. Used for checking for frequencies within a specified range such as repeater output frequencies, etc. 3 pairs of scan edges are selectable.

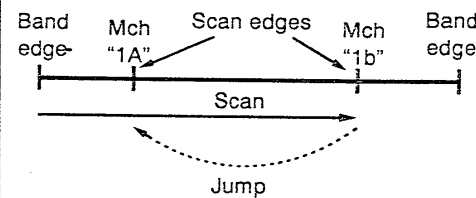

MEMORY SCAN (p. 49)

Repeatedly scans memory channels within the range of the memory area except skip channels. Used for checking often-called channels and bypassing normally busy channels such as repeater frequencies.

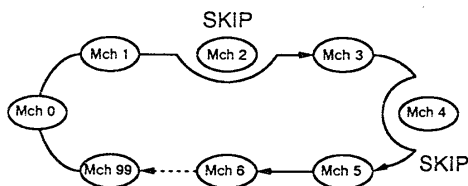

SCAN RESUME CONDITION (p. 51)

5 resume conditions are available: 3 timer scans, pause scan, empty pause. When receiving a signal, pause scan pauses until the signal disappears; timer scans pause for 5, 10 or 15 sec. Empty pause pauses until a signal appears.

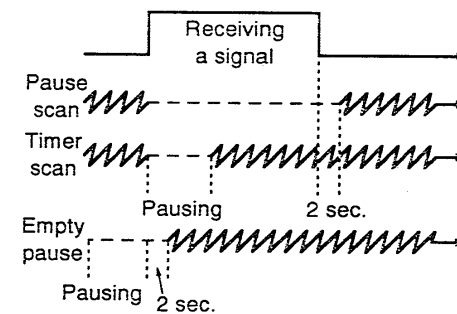

9 SCAN OPERATION

■ Full scan and programmed scan

- ① Push the desired band's tuning dial.
- ② Push the desired band's [V/MHz] to select VFO mode.
- ③ Push the desired band's [SQL] until the noise is muted.
- ④ Select full scan or one of 3 programmed scan edges (p. 46):
 - Push [SET] one or more times until "PSC" appears.
 - Rotate the selected band's tuning dial to select full scan or one of 3 programmed scan edges.
 - Push the selected band's tuning dial to exit set mode.
- ⑤ Push [UP] or [DN] for 1 sec. to start the scan.
 - To change the scanning direction, rotate the selected band's tuning dial.
- ⑥ To stop the scan, push [UP] or [DN].



- ① Push the desired band switch.
- ② Push [③ VFO] to select VFO mode.
- ③ Push [Ⓡ SQL] one or more times until the noise is muted.
- ④ Select full scan or one of 3 programmed scan edges (p. 46):
 - Push [Ⓢ SET] one or more times until "PSC" appears.
 - Push [UP] or [DN] to select full scan or one of 3 programmed scan edges.
 - Push [Ⓐ CLR] to exit set mode.
- ⑤ Push [UP] or [DN] for 1 sec. to start the scan.
 - Pushing [Ⓡ SCAN] after pushing [FUNC] starts upward scan.
- ⑥ To stop the scan, push [UP] or [DN].

◇ Scan resume condition:

- Following scan resume conditions are available:
 - Scan resumes 5 sec. after the scan stops.
 - Scan resumes 10 sec. after the scan stops.
 - Scan resumes 15 sec. after the scan stops.
 - Scan pauses until a signal disappears and resumes 2 sec. thereafter.
 - Scan pauses at a frequency that is not busy and resumes 2 sec. after a signal appears.
- The scan resume condition can be selected in set mode. (p. 51)
- While scanning, rotating the scanning band's tuning dial changes the scanning direction or skips a paused frequency.

■ Scan edge selection

USING SET MODE

The transceiver has 4 pairs of scan edges. 3 pairs of scan edges are programmable and are used for scanning within a range such as repeater output frequencies, regulated simplex frequencies, etc. The remaining scan edges are the band edges for full scan and cannot be changed.

Select the scan edges in advance to activate full scan or programmed scan as follows:

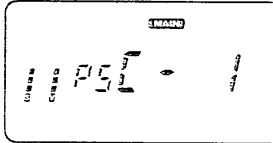

The display shows the pair of scan edge channels (memory channels) "1A/1b" is selected.

Separate setting for each band.

- ① Push the desired band's tuning dial.
- ② Push [SET] one or more times until "PSC" appears as shown above.
 - Pushing [SPCH] reverses the order. (p. 18)
 - Cancel the DTMF memory function, optional pager or code squelch in advance. (pgs. 54, 64, 67)

- ③ Rotate the selected band's tuning dial to select full scan or one of 3 programmed scan edges.
 - "PSC-AL" : Scan operates as full scan.
 - "PSC- 1" : A pair of scan edge channels "1A/1b" is selected.
 - "PSC- 2" : A pair of scan edge channels "2A/2b" is selected.
 - "PSC- 3" : A pair of scan edge channels "3A/3b" is selected.
- ④ Push the selected band's tuning dial to exit set mode.



- ① Push the desired band switch.
- ② Push [SET] one or more times until "PSC" appears as shown at left.
 - Pushing [SPCH] reverses the order. (p. 18)
 - Cancel the DTMF memory function, optional pager or code squelch in advance. (pgs. 54, 64, 67)
- ③ Push [UP] or [DN] to select full scan or one of 3 programmed scan edges.
 - "PSC-AL" } See item ③ above for description.
 - "PSC- 1" }
 - "PSC- 2" }
 - "PSC- 3" }
- ④ Push [CLR] to exit set mode.

9 SCAN OPERATION

Downloaded by
RadioAmateur.EU

■ Programming scan edges

Scan edges can be programmed in the same way as memory channels. Memory channels "1A"–"3A" and "1b"–"3b" are available for programming scan edges.

- ① Push the desired band's tuning dial.
- ② Select the scan edge memory channel "1A," "2A" or "3A":
 - Push the desired band's [M/CALL] once or twice to select memory mode.
 - Rotate the desired band's tuning dial to select the memory channel "1A," "2A" or "3A."

- ③ Set the desired frequency in VFO mode:
 - Push the desired band's [V/MHz] to select VFO mode.
 - Rotate the desired band's tuning dial to set the desired frequency.
- ④ Push and hold [SPCH/MW] for 1 sec. to program.
 - If the beep tone is ON, 3 beeps alert you that the contents are programmed.
- ⑤ To program a frequency for the other scan edge memory channel "1b," "2b" or "3b," repeat steps ②–④.
 - If the same frequency is programmed into a pair of the scan edges and the pair is selected as scan edges, programmed scan will not function.

[EXAMPLE]: Programming 145.30 MHz and 145.80 MHz for the VHF scan edges, "1A" and "1b."

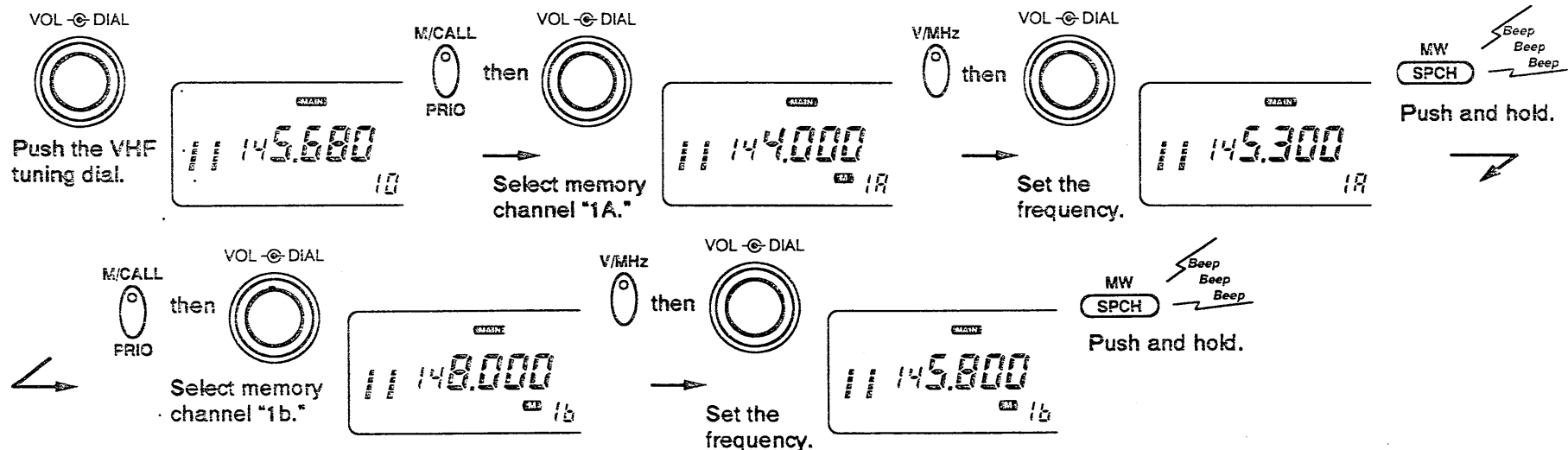

■ Programming scan edges via the microphone



- 1 Push the desired band switch.
- 2 Select the scan edge memory channel "1A," "2A" or "3A":
 - Push [MR] to select memory mode.
 - Push [UP] or [DN] to select the memory channel "1A," "2A" or "3A."
- 3 Set the desired frequency in VFO mode:
 - Push [VFO] to select VFO mode.
 - Set the desired frequency using the keyboard.

- 4 Push [FUNC], then, push and hold [MW] for 1 sec. to program.
 - If the beep tone is ON, 3 beeps alert you that the contents are programmed.
- 5 To program a frequency for the other scan edge memory channel "1b," "2b" or "3b," repeat steps 2-4.
 - If the same frequency is programmed into a pair of the scan edges and the pair is selected as scan edges, programmed scan will not function.

[EXAMPLE]: Programming 145.30 MHz and 145.80 MHz for the VHF scan edges, "1A" and "1b."

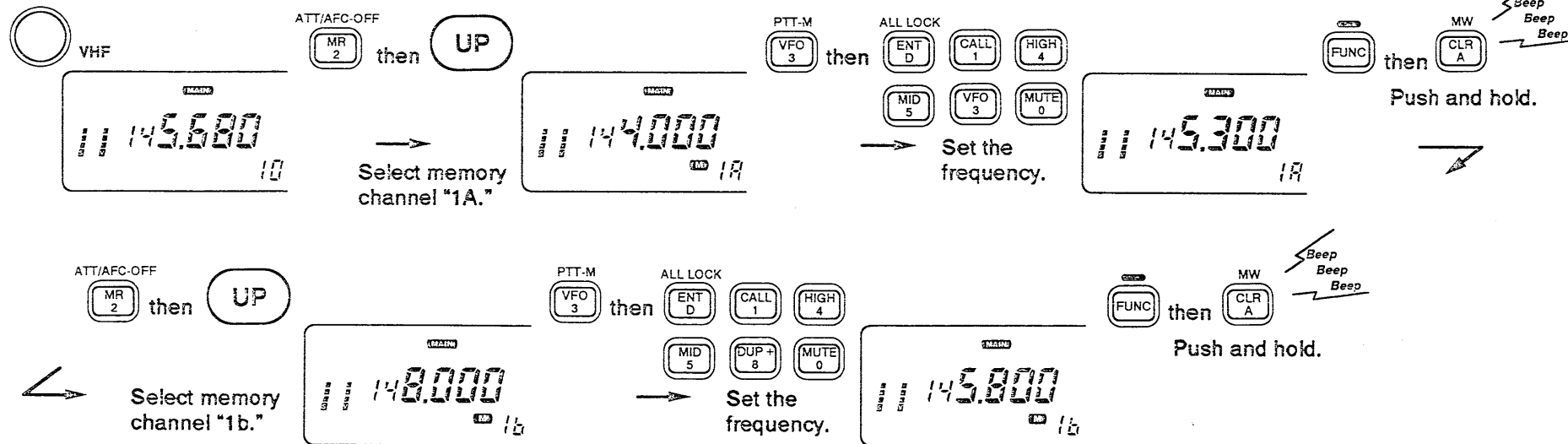

9 SCAN OPERATION

Memory scan

- ① Push the desired band's tuning dial.
- ② Push the desired band's [M/CALL] once or twice to select memory mode.
- ③ Push the desired band's [SQL] until the noise is muted.
- ④ Push [UP] or [DN] for 1 sec. to start the scan.
 - To change the scanning direction, rotate the selected band's tuning dial.
 - The scan resume condition is the same as the programmed scan. See p. 45 for details.
 - Set memory area, if desired. (p. 41)
- ⑤ To stop the scan, push [UP] or [DN].

CONVENIENT

The skip channel setting (p. 50) and memory area setting (p. 41) are convenient to speedup the memory scan, checking the desired memory channels only.

NOTE: All memory channels are set as skip channels for default setting. Program the memory channels more than two channels (p. 38) or cancel the skip function more than two channels (p. 50) in advance.



- ① Push the desired band switch.
- ② Push [②MR] to select memory mode.
- ③ Push [⊕SQL] one or more times until the noise is muted.
- ④ Push [UP] or [DN] for 1 sec. to start the scan.
 - Pushing [FUNC] then [⊕SCAN] starts upward scan.
 - Set memory area, if desired. (p. 41)
 - When all memory channels are set as skip channels (default setting) or all memory channels except one memory channel are set as skip channels, memory scan does not start.
- ⑤ To stop the scan, push [UP] or [DN].

Skip channel setting

USING SET MODE

Memory skip function speeds up the scan rotation, checking only the desired memory channels. When first applying power or after resetting the CPU, all memory channels are specified as skip channels. Programming a memory channel automatically cancels the skip function. Set the memory channels to be skipped or scanned as follows.

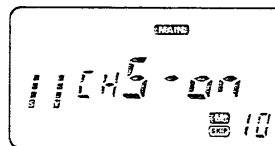

The display shows that the VHF memory channel 10 is set as a skip channel.

Separate setting for each band.

- ① Push the desired band's tuning dial.
- ② Select the memory channel to program or to cancel the skip function:
 - Push the desired band's [M/CALL] once or twice to select memory mode.
 - Rotate the desired band's tuning dial to select the memory channel.
- ③ Push [SET] one or more times until "CHS" appears as shown at left.
 - Pushing [SPCH] reverses the order. (p. 18)

- ④ Rotate the selected band's tuning dial to turn the skip function ON or OFF on the selected channel.
 - "SKIP" appears : The memory channel is skipped during (CHS-on) memory scan.
 - "SKIP" disappears: The memory channel is scanned during (CHS-oF) memory scan.
- ⑤ Push the selected band's tuning dial to exit set mode.

NOTE: The scan edge memory channels (1A-3b) cannot be specified as skip channels but they are skipped during memory scan.



- ① Push the desired band switch.
- ② Select the memory channel to cancel or to program the skip function:
 - Push [MR] to select memory mode.
 - Push [UP] or [DN] to select the memory channel.
- ③ Push [SET] one or more times until "CHS" appears as shown at left.
 - Pushing [SPCH] reverses the order. (p. 18)
- ④ Push [UP] or [DN] to set or cancel the skip information.
 - See item ④ above for skip indicator details.
- ⑤ Push [CLR] to exit set mode.

9 SCAN OPERATION

■ Scan resume condition

USING SET MODE

The resume condition can be selected as pause, empty pause or timer scan. The empty pause is useful for finding unused frequencies. The resume condition is also used for priority watch. (p. 53)

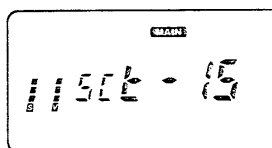

The display shows that the scan resumes 15 sec. after the scan stops.

Separate setting for each band.

- ① Push the desired band's tuning dial.
- ② Push [SET] one or more times until "SCT" or "SCP" appears as shown above.
 - Pushing [SPCH] reverses the order. (p. 18)
 - Cancel the DTMF memory function, optional pager or code squelch in advance. (pgs. 54, 64, 67)

- ③ Rotate the selected band's tuning dial to set the desired timer.
 - "SCT-15" : Scan pauses 15 sec. while receiving a signal.
 - "SCT-10" : Scan pauses 10 sec. while receiving a signal.
 - "SCT- 5" : Scan pauses 5 sec. while receiving a signal.
 - "SCP- 2" : Scan pauses until the signal disappears and then resumes 2 sec. thereafter.
 - "SCT-EP" : Scan pauses on a frequency that is not busy and resumes 2 sec. after a signal appears.
- ④ Push the selected band's tuning dial to exit set mode.



- ① Push the desired band switch.
- ② Push [ⒷSET] one or more times until "SCT" or "SCP" appears as shown at left.
 - Pushing [ⒸSPCH] reverses the order. (p. 18)
 - Cancel the DTMF memory function, optional pager or code squelch in advance. (pgs. 54, 64, 67)
- ③ Push [UP] or [DN] to select the scan resume condition.
 - See item ③ above for the scan resume condition details.
- ④ Push [ⒶCLR] to exit set mode.

Priority watch types

The priority watch checks for signals on a memory or call channel every 5 sec. while operating on a VFO frequency. The transceiver has 3 priority watch types to suit your needs. You can transmit on the VFO frequency while the priority watch operates.

The watch resumes according to the selected scan resume condition. See page at left for settings.

NOTE:

- The DTMF memory function, an optional pager and code squelch are turned OFF when priority watch starts.
- An optional pocket beep function is automatically changed to the tone squelch function when priority watch starts.
- When "SCt-EP" is selected for the scan resume condition, the priority watch pauses on a no-signal channel. See page at left for details.

MEMORY CHANNEL WATCH (p. 53)

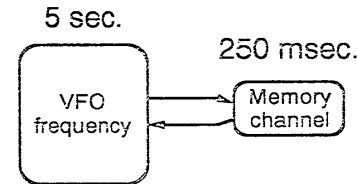

While operating on a VFO frequency, priority watch checks for a signal in the selected memory channel every 5 sec.

- A memory channel with skip information can be watched.

MEMORY SCAN WATCH (p. 53)

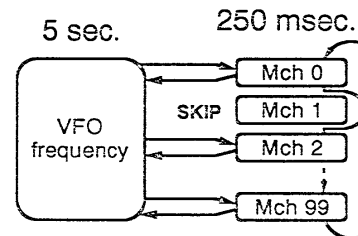

While operating on a VFO frequency, priority watch checks for signals in each memory channel in sequence.

- The memory skip function and memory area setting is useful for speedup the scan rotation.

CALL CHANNEL WATCH (p. 53)

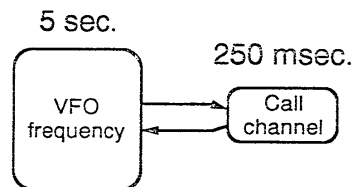

While operating on a VFO frequency, priority watch checks for a signal in the call channel every 5 sec.

Priority watch operation

- ① Push the desired band's tuning dial.
- ② Select VFO mode; then, set an operating frequency.
- ③ Set the watching channel(s).
 - For memory channel watch:*
Select the desired memory channel.
 - For memory scan watch:*
Select memory mode; then, push and hold [UP] or [DN] for 1 sec. to start the memory scan.
 - For call channel watch:*
Push the desired band's [M/CALL] once or twice to select the call channel.
- ④ Push and hold the desired band's [M/CALL/PRIO] for 1 sec. to start the watch.
 - The transceiver checks the memory or call channel frequency every 5 sec.
 - The watch resumes according to the selected scan resume condition. (p. 51)
 - While the watch is pausing, pushing the desired band's [M/CALL] resumes the watch manually.
- ⑤ Push the desired band's [M/CALL] while the display shows the VFO frequency to stop the watch.

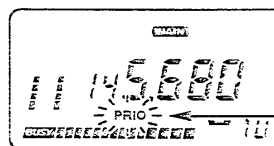

While pausing on the memory or call channel, "PRIO" blinks.



- ① Push the desired band switch.
- ② Select VFO mode; then, set an operating frequency.
- ③ Set the watching channel(s).
 - For memory channel watch:*
Push [②MR] then [UP] or [DN] to select the desired memory channel.
 - For memory scan watch:*
Push [②MR]; then, push and hold [UP] or [DN] for 1 sec. to start the memory scan.
 - Pushing [FUNC] then [⊗SCAN] starts upward scan.
 - For call channel watch:*
Push [①CALL] to select the call channel.
- ④ Push [FUNC] then [⊙PRIO] to start the watch.
 - The transceiver checks the memory or call channel frequency every 5 sec.
 - The watch resumes according to the selected scan resume condition. (p. 51)
 - While the watch is pausing, pushing [ⒶCLR] resumes the watch manually.
- ⑤ Push [ⒶCLR] while the display shows the VFO frequency to stop the watch.

■ Programming a DTMF code

DTMF codes are used for autopatching, accessing repeaters, controlling other equipment, etc. The transceiver has 14 DTMF memory channels (d0–d9, dA–dd) for storage of often-used DTMF codes of up to 24 digits.

NOTE: DTMF memory channels are commonly used for all bands. Therefore, each band programming is not necessary.

- ① Push [DTMF] one or more times until “d” appears in place of the main band’s 100 MHz digit as shown below.

“d” appears in the place of the 100 MHz digit.

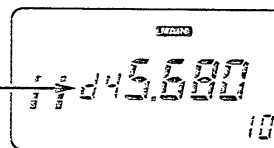

- ② Push [SET] to enter the programming condition.
- ③ Rotate the main band’s tuning dial to select the desired channel.
- ④ Push [SET] to start programming.
- ⑤ Rotate the main band’s tuning dial to select a digit.
 - “E” stands for “*” and “F” stands for “#.”

- ⑥ Push [SET] to set the next digit.
 - If you make a mistake, push [SPCH] to backspace and rotate the main band’s tuning dial to correct the digit.
 - The S/RF indicator shows the digit group. The indication increases for every 6 digits.
 - Select “-” to clear the remaining digits when programming over a previously used memory channel.
- ⑦ Repeat ⑤ and ⑥ until the last digit is entered.
- ⑧ Push the main band’s tuning dial to exit the programming condition.

■ Clearing the DTMF memory contents

- ① Push [DTMF] one or more times until “d” appears in place of the main band’s 100 MHz digit.
- ② Push [SET] to enter the programming condition.
- ③ Rotate the main band’s tuning dial to select the desired channel.
- ④ Push [SET] once to start programming.
- ⑤ Rotate the main band’s tuning dial to select “-” to clear the memory contents.
- ⑥ Push the main band’s tuning dial to exit the programming condition.

11 DTMF MEMORY

■ Programming a DTMF code via the microphone

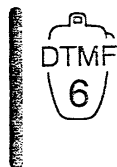

DTMF codes can be directly programmed via the keyboard on the microphone. The contents can be overwritten, but cannot be cleared via the microphone. See p. 54 for clearing the contents.

- 1 Push [FUNC] then [6 DTMF] to turn the DTMF memory function ON.
 - “d” appears in place of the main band’s 100 MHz digit.
- 2 Push [B SET] to enter the programming condition.
- 3 Push [UP] or [DN] to select the desired channel.

- 4 Push the desired digit keys.
 - When the 1st digit is input, previous memory contents are cleared automatically.
 - “E” stands for “*” and “F” stands for “#.”
 - Push [UP] or [DN] and repeat this step when making a mistake.
 - The S/RF indicator shows the digit group. The indication increases for every 6 digits.
- 5 Push the band switch to exit the programming condition.
 - Pushing [PTT] also exits the condition and transmits the memory contents.

[EXAMPLE]: Programming “5428A*” into DTMF memory channel “d4.”

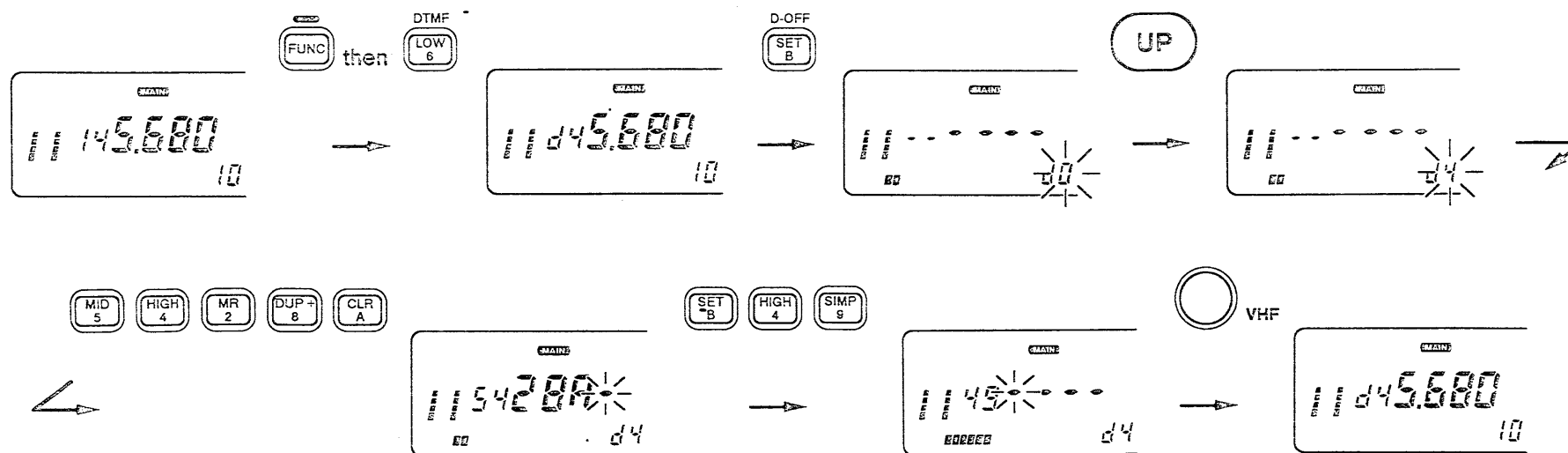

■ Transmitting a DTMF code

◇ Using the DTMF memory function (automatic transmission)

The selected DTMF code is transmitted at each push of the PTT switch when the DTMF memory function is turned ON.

- ① Push [DTMF] one or more times until "d" appears in place of the main band's 100 MHz digit.
- ② Push [SET] to enter the programming condition.
- ③ Rotate the main band's tuning dial to select the desired DTMF memory channel.
- ④ Push [PTT] to transmit the selected DTMF code.
 - At each push of [PTT], the selected DTMF code is transmitted.
 - The speaker emits the DTMF tones sent.
- ⑤ Push [DTMF] once or twice to cancel the function.
 - "d" disappears and the function display shows the operating frequency. Be sure "REMO" does not illuminate.



- ① Push [FUNC] then [ⓈDTMF] to turn the DTMF function ON.
 - "d" appears in place of the main band's 100 MHz digit.
- ② Push [ⓈSET] to enter the programming condition.

- ③ Push [UP] or [DN] to select the desired channel.
- ④ Push [PTT] to transmit the selected DTMF code.
 - At each push of [PTT], the selected DTMF code is transmitted.
- ⑤ Push [ⓈCLR] to cancel the function.

◇ Transmitting a DTMF memory channel



- ① Push [DTMF MEMO] to set the keyboard for transmitting a DTMF memory channel.
 - The mode indicator lights up in orange.
- ② Push the desired DTMF memory channel number [①]–[Ⓣ] or [Ⓜ]–[Ⓞ].
 - The memorized DTMF code is automatically transmitted.
 - The mode indicator goes out automatically.

◇ Transmitting a DTMF code manually



- Push the keys of the desired DTMF digits after pushing [DTMF KEY].
- The mode indicator lights up in green.
 - 1–0, A–D, * (E) and # (F) are available.
 - Cancel the DTMF memory function, optional pager or code squelch in advance. (pgs. 54, 64, 67)
 - Push [DTMF KEY] again to set the keyboard for function control (normal condition).

12 AFC, RIT AND VXO OPERATION

Downloaded by
RadioAmateur.EU

Selecting RIT/VXO types

USING SET MODE

To compensate for the off frequency of a transmitting station, the transceiver has AFC-RIT, AFC-VXO, manual RIT and manual VXO functions for the 1.2 GHz band.

The AFC (Automatic Frequency Control) function automatically and immediately fine tunes the receive frequency or both receive and transmit frequencies to the transmitting station.

The RIT (Receive Incremental Tuning) shifts only the receive frequency and the VXO (Variable crystal Oscillator) shifts both the receive and transmit frequencies within approx. ± 7.5 kHz.

When the transmitting station does not have RIT, VXO or AFC functions, use either the AFC-VXO or manual VXO function.

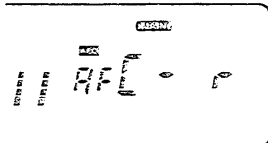

The display shows that AFC-RIT is selected.

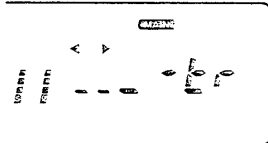

The display shows that manual VXO is selected.

- ① Push the 1.2 GHz band's tuning dial.
- ② Push [SET] one or more times until "AFC" or "◀ ▶" appears as shown at left.
 - Pushing [SPCH] reverses the order. (p. 18)
 - Cancel the DTMF memory function, optional pager or code squelch in advance. (pgs. 54, 64, 67)
- ③ Rotate the 1.2 GHz band's tuning dial to select the desired function.

FUNCTION	DISPLAY	FINE TUNING	
		TRANSMIT FREQUENCY	RECEIVE FREQUENCY
AFC-RIT	AFC-r	OFF	Auto
AFC-VXO	AFC-tr	Auto	Auto
Manual RIT	---r	OFF	Manual
Manual VXO	---tr	Manual	Manual

- ④ Push the 1.2 GHz band's tuning dial to exit set mode.

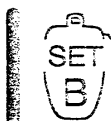

- ① Push the 1.2 GHz band switch.
- ② Push [ⓑSET] one or more times until "AFC" or "◀ ▶" appears as shown at left.
 - Pushing [ⓒSPCH] reverses the order. (p. 18)
 - Cancel the DTMF memory function, optional pager or code squelch in advance. (pgs. 54, 64, 67)
- ③ Push [UP] or [DN] to select the desired function as shown in the table above.
- ④ Push [ⒶCLR] to exit set mode.

■ AFC function

- ① Push the 1.2 GHz band's tuning dial.
- ② Select the AFC-RIT or AFC-VXO function. (See page at left.)
- ③ Push and hold [LOW/ATT/AFC] for 1 sec. to activate the function.
 - "AFC" appears in the 1.2 GHz function display.
- ④ While receiving a signal, the transceiver automatically fine tunes the receive frequency or both receive and transmit frequencies to the received frequency.
 - "◀" or "▶" appears while fine tuning.
 - "◀" or "▶" blinks when the transceiver cannot tune to the received frequency. Change the operating frequency in this case.
- ⑤ Push and hold [LOW/ATT/AFC] for 1 sec. to cancel the function.



- ① Push the 1.2 GHz band switch.
- ② Select the AFC-RIT or AFC-VXO function.
- ③ Push [FUNC] then [① ATT/AFC].
- ④ While receiving a signal, the transceiver automatically fine tunes the receive frequency or both receive and transmit frequencies to the received frequency.



- ⑤ Push [FUNC] then [② ATT/AFC-OFF] to cancel the function.

■ RIT/VXO functions

- ① Push the 1.2 GHz band's tuning dial.
- ② Select the manual RIT or manual VXO function. (See page at left.)
- ③ Push and hold [LOW/ATT/AFC] for 1 sec. to activate the function.
 - Both "◀" and "▶" appear in the 1.2 GHz function display.
- ④ Rotate the 1.2 GHz band's tuning dial for fine tuning.
 - Both "◀" and "▶" appear when the fine tuning is at center.
 - "◀" or "▶" shows the fine tuning direction.
 - "◀" or "▶" blinks when the fine tuning reaches the maximum. Change the operating frequency in this case.
 - Pushing [UP] or [DN] change the operating frequency or memory channel.
- ⑤ Push and hold [LOW/ATT/AFC] for 1 sec. to cancel the function.



- ① Push the 1.2 GHz band switch.
- ② Select the manual RIT or VXO function.
- ③ Push [FUNC] then [① ATT/AFC].
- ④ Rotate the 1.2 GHz band's tuning dial on the transceiver for fine tuning.
 - Pushing [UP] or [DN] change the operating frequency or memory channel.



- ⑤ Push [FUNC] then [② ATT/AFC-OFF] to cancel the function.

13 EXTERNAL DTMF REMOTE

External DTMF remote

The transceiver can be remotely controlled using DTMF signals. To operate external DTMF remote, an optional UT-75 and a 144 MHz, 430(440) MHz or 1.2 GHz transceiver with a DTMF encoder are necessary.

Indicates the 1.2 GHz band is in standby for remote control.

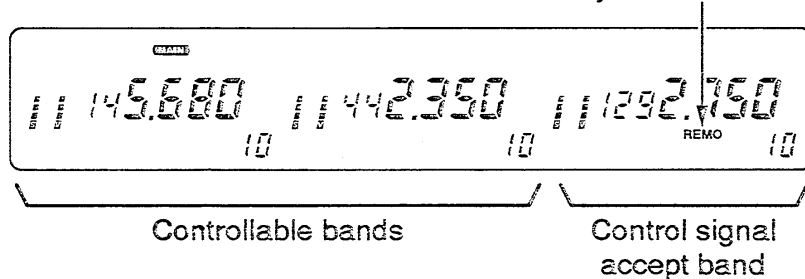

- ① Set a control frequency for receiving of a DTMF control signal.
 - An optional tone squelch function can be used for the control signal accept band to increase remote control reliability. (p. 69)
- ② Program a 3-digit password into the control signal accept band's code channel 5, if required. (p. 63)
 - The initial value of code channel 5 is "000." If you do not require the password, set the channel as "receive inhibit."
- ③ Push [DTMF] one or more times until "REMO" appears to select standby for the remote control.

- ④ Push the desired band's tuning dial to select the main band; then, set the desired frequency for operation.
- ⑤ Set the operating frequency of the controller transceiver equal to the control frequency of the IC-Δ100H.
 - Turn ON the subaudible tone encoder and set the tone frequency when the IC-Δ100H uses an optional tone squelch function.
 - The external DTMF remote does not accept a control signal on the main band frequency.
- ⑥ From the controller transceiver, transmit the DTMF code as follows.

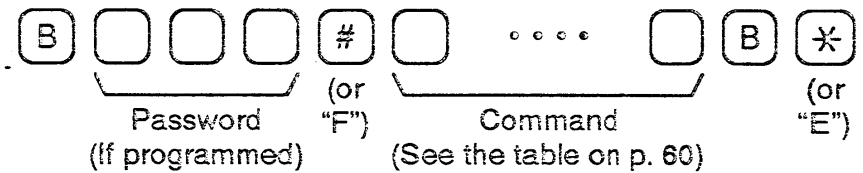

- ⑦ To cancel standby for the remote control, push [DTMF] after selecting the desired band as the main band.
 - "REMO" disappears.

KEY	DESCRIPTION	KEY	DESCRIPTION
[B] + [#] (or "F") or [B] + password + [#] (or "F")	Activates external DTMF remote.	[8] (LOW 2)	Selects low power 2 for the main band. Selects low power 1 when the 1.2 GHz band is selected as the main band.
[B] + [*] (or "E")	Returns to standby.	[9] (LOW 1)	Selects low power 1 for the main band.
[1] (CALL)	Selects the call channel for the main band.	[#] (or "F") (UP)	Increases the operating frequency or memory channel in preset tuning steps.
[2] (MR)	Selects memory mode for the main band.	[*] (or "E") (DOWN)	Decreases the operating frequency or memory channel in preset tuning steps.
[3] (VFO)	Selects VFO mode for the main band.	[A] (CLR)	Clears input digits and retrieves the previous key input.
[4] (VHF)	Selects VHF as the main band for control.	[D] (ENT)	Sets the transceiver to enter a frequency or memory channel number in 10 kHz tuning steps.
[5] (UHF)	Selects UHF as the main band for control.	[0]–[9] (after pushing [D])	Enters a frequency up to the 10 kHz digit* ¹ or enters memory channels (0–99, 1A–3A and 1b–3b* ²).
[6] (1.2G)	Selects 1.2 GHz band as the main band for control.		
[7] (HIGH)	Selects high power for the main band.		

*¹ When the entered frequency is outside of the frequency coverage or the entered memory channel is outside of the memory area, the input digit will be cleared.

² To select a scan edge memory channel (1A–3A, 1b–3b), select memory channel 0 or 99; then, push [] (or "E") or [#] (or "F"), respectively.

[EXAMPLE]: Setting the operating frequency to 145.8125 MHz (when the VHF tuning step is 12.5 kHz).

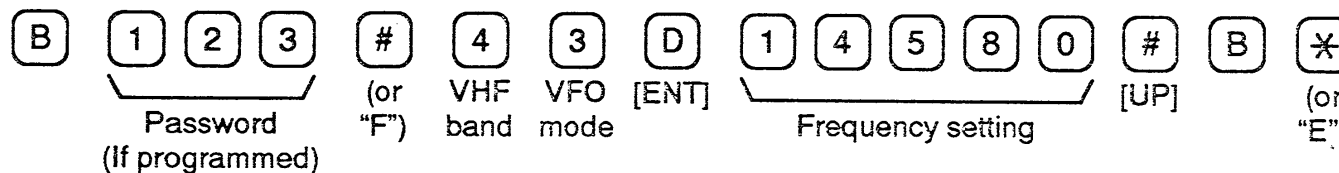

14 PAGER AND CODE SQUELCH

■ Pager function

This function uses DTMF codes for paging and can be used as a "message pager" to inform you of a caller's identity even if you leave the transceiver temporarily unattended.

To operate the pager function, an optional UT-75 is necessary. See p. 16 for installation.

Personal calls and group calls are available with the pager function. Personal calls use the receiving parties' ID code for calling. The receiving parties' display shows your ID code and other stations in the party know that you called. You can also call all stations in your group using the group call.

To use the pager function in your group, all stations need the pager function.

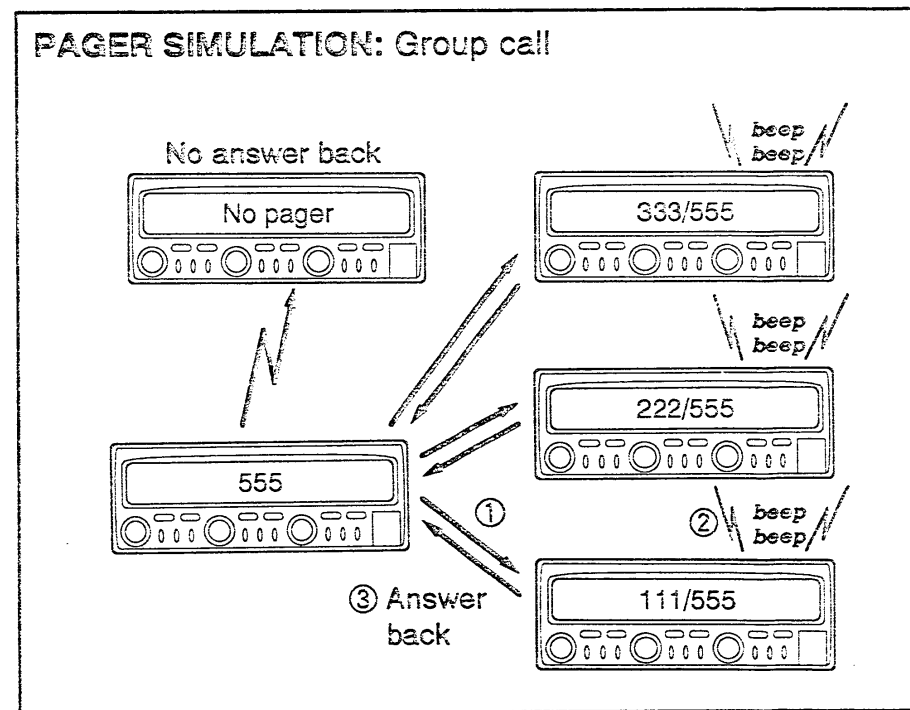
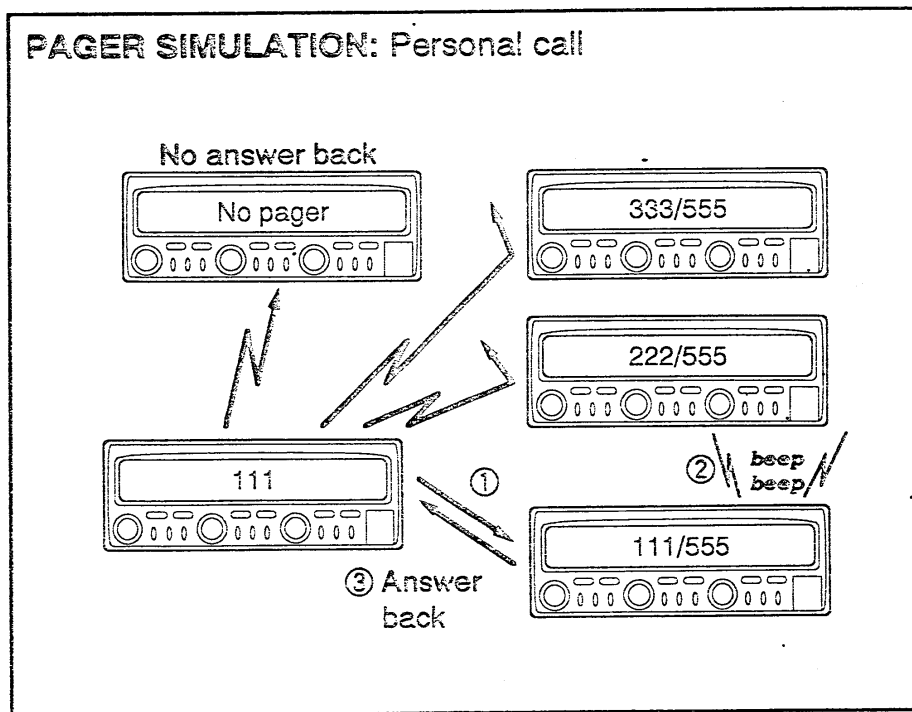

■ Code channel

◇ Before programming

The pager and code squelch functions require ID codes and a group code. These codes are 3-digit DTMF codes and must be written into the code channels before operation. The transceiver has separate code channels for each band.

◇ Code channel assignment

ID or group code	Code channel number	"Receive accept" or "Receive inhibit"
Your ID code	0	"Receive accept" only.
Other parties' ID code	1-5	"Receive inhibit" should be programmed in each channel.
Group code	One of 1-5	"Receive accept" must be programmed.
Memory space*	P	"Receive inhibit" only.

* Channel P automatically memorizes an ID code when receiving a pager call. The contents in channel P cannot be changed manually.

"RECEIVE ACCEPT" OR "RECEIVE INHIBIT"

Code channels 1-5 should be effectively programmed as "Receive accept" or "Receive inhibit."

- ▷ "Receive accept" ("GRP" indicator is not illuminated) accepts pager calls when the transceiver receives a signal with a code the same as that in the code channel.
- ▷ "Receive inhibit" ("GRP" indicator is illuminated) rejects calls even when the transceiver receives a signal with a code the same as that in the code channel.

For example, the code channel that stores the group code should be programmed as "Receive accept." If the channel is programmed as "Receive inhibit," you cannot receive group calls.

The code channels that store other parties' ID codes for a transmit code should be programmed as "Receive inhibit." If the channels are programmed as "Receive accept," personal calls for parties other than yourself will be received.

14 PAGER AND CODE SQUELCH

Code programming

- ① Push the desired band's tuning dial.
 - Each band has separate code channels.
- ② Push [DTMF] to turn the pager function ON.
 - "P" appears in place of the 100 MHz digit.
- ③ Push [SET] to select the code channel setting display.
- ④ Rotate the desired band's tuning dial to select the desired code channel, 0-5.
 - Code channel P cannot be used for programming.
- ⑤ Push [SET] or [SPCH] to select the digit to be programmed.
- ⑥ Rotate the desired band's tuning dial to set the digit.
- ⑦ Repeat ⑤ and ⑥ until the last digit is programmed.
- ⑧ Push [DTMF] to set the code channel for "receive inhibit" or "receive accept."
 - When "receive inhibit" is set, "SKIP" is illuminated.
 - Code channel 0 cannot be set as "receive inhibit."
 - See p. 62 for "receive inhibit" or "receive accept" details.
- ⑨ Push the desired band's tuning dial to exit the setting display.

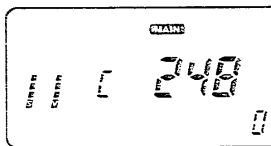

The display shows that VHF band code channel 0 is programmed for 248.



- ① Push the desired band switch.
 - Each band has separate code channels.
- ② Push [FUNC] then [PGR] to turn the pager function ON.
 - "P" appears in place of the 100 MHz digit.
- ③ Push [SET] to select the code channel setting display.
- ④ Push [UP] or [DN] to select the desired code channel, 0-5.
 - Code channel P cannot be used for programming.
- ⑤ Push the numeral keys to enter the desired 3-digit code.
 - Digits are automatically stored once the 3rd digit has been entered.
 - When an unwanted digit is entered, push [CLR] then repeat steps ③ and ⑤.
- ⑥ Push [SET] to set the code channel for "receive inhibit" or "receive accept."
 - When "receive inhibit" is set, "SKIP" is illuminated.
 - Code channel 0 cannot be set as "receive inhibit."
 - See p. 62 for "receive inhibit" or "receive accept" details.
- ⑦ Push [CLR] to exit the setting display.

■ Pager operation

◇ Calling a specific station

- ① Push the desired band's tuning dial.
- ② Set the operating frequency.
- ③ Push [DTMF] to turn the pager function ON.
 - "P" appears in place of the 100 MHz digit.
 - An optional tone squelch can be used together with the pager function. (p. 69)
- ④ Select the desired code channel:
 - Push [SET].
 - Rotate the desired band's tuning dial to select the code channel.
 - Push the desired band's tuning dial to exit the setting display.
- ⑤ Push [PTT] to transmit the pager code.
- ⑥ Wait for an answer back.
 - When the transceiver receives an answer back code, the function display shows the other party's ID or group code and beeps. (p. 66)
- ⑦ After confirming a connection, push the desired band's tuning dial to display the operating frequency.
 - **DO NOT** push numeral keys on the microphone while code channels 0-5 are indicated, or code channel contents are changed.
- ⑧ Push [DTMF] once to select code squelch or 4 times to select the non-selective calling system.
 - Be sure that "REMO" does not illuminate when the non-selective calling system is selected.



- ① Push the desired band switch.
- ② Set the operating frequency.
- ③ Push [FUNC] then [④ PGR] to turn the pager function ON.
 - "P" appears in place of the 100 MHz digit.
 - An optional tone squelch can be used together with the pager function. (p. 69)
- ④ Select the desired code channel:
 - Push [Ⓑ SET].
 - Push [UP] or [DN] to select the code channel.
 - Push [Ⓐ CLR] to exit the setting display.
- ⑤ Push [PTT] to transmit the pager code.
- ⑥ Wait for an answer back.
 - When the transceiver receives an answer back code, the function display shows the other party's ID or group code and beeps. (p. 66)
- ⑦ After confirming a connection, push [Ⓐ CLR] to display the operating frequency.
 - **DO NOT** push numeral keys while code channels 0-5 are indicated, or code channel contents are changed.
- ⑧ Push [FUNC] then [⑤ C SQL] to select code squelch or push [Ⓐ CLR] to select the non-selective calling system.
 - Pushing [FUNC] then [Ⓑ D-OFF] also selects the non-selective calling system.

14 PAGER AND CODE SQUELCH

◇ Waiting for a call from a specific station

- ① Push the desired band's tuning dial.
- ② Set the operating frequency.
- ③ Push [DTMF] to turn the pager function ON.
 - "P" appears in place of the 100 MHz digit.
 - An optional tone squelch can be used together with the pager function. (p. 69)
- ④ Wait for a call.
 - When receiving a call, the other party's ID or group code appears; "(••)" and the channel number blink as shown on the next page.
 - **DO NOT** push numeral keys on the microphone while code channels 0-5 are indicated, or code channel contents are changed.
- ⑤ Push [PTT] to send an answer back call and display the operating frequency.
- ⑥ Push [DTMF] once to select code squelch or 4 times to select the non-selective calling system.



- ① Push the desired band switch.
- ② Set the operating frequency.
- ③ Push [FUNC] then [④ PGR] to turn the pager function ON.
 - "P" appears in place of the 100 MHz digit.
 - An optional tone squelch can be used together with the pager function. (p. 69)
- ④ Wait for a call.
 - When receiving a call, the other party's ID or group code appears; "(••)" and the channel number blink as shown on the next page.
 - **DO NOT** push numeral keys while code channels 0-5 are indicated, or code channel contents are changed.
- ⑤ Push [PTT] to send an answer back call and display the operating frequency.
- ⑥ Push [FUNC] then [⑤ C SQL] to select code squelch or push [Ⓐ CLR] to select the non-selective calling system.
 - Pushing [FUNC] then [Ⓑ D-OFF] also selects the non-selective calling system.

PERSONAL CALLS

This display appears when you are called with your ID code and the calling station's ID code is 263.

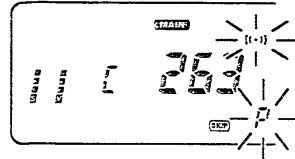

GROUP CALLS

This display appears when you are called with the group code, 123, and 123 has been programmed into code channel 5.

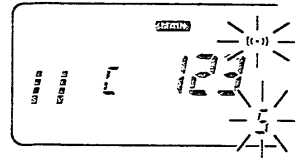

ERROR INFORMATION

When the transceiver receives an incomplete signal, "E" appears.

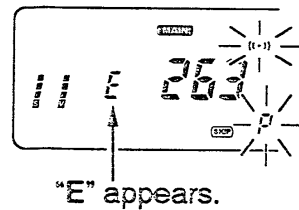

Code squelch function

The code squelch provides communication with silent standby since you will only receive calls from stations which know your ID or group code. To operate the code squelch function, an optional UT-75 is necessary. See p. 16 for installation. To use the code squelch function in your group, all stations need the code squelch function.

The code squelch transmits a 3-digit code prior to voice transmission in order to open the receiving station's code squelch.

CODE SQUELCH SIMULATION: ID code

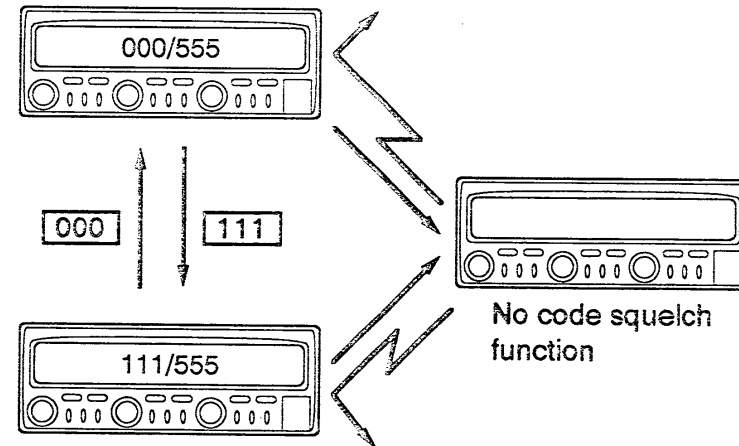

Code squelch operation

- ① Push the desired band's tuning dial.
- ② Set the operating frequency.
- ③ Push [DTMF] twice to turn the code squelch ON.
 - "C" appears in place of the 100 MHz digit as shown below.
 - An optional tone squelch can be used together with the code squelch. (p. 69)

"C" appears in the place of the 100 MHz digit.

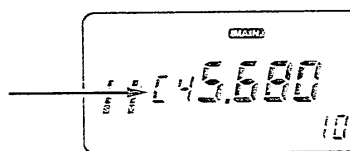

- ④ Select the desired code channel:
 - Push [SET].
 - Rotate the desired band's tuning dial to select the code channel.
 - Push the desired band's tuning dial to exit the setting display.
- ⑤ Operate the transceiver in the normal way (push [PTT] to transmit; release [PTT] to receive).
 - Prior to voice transmission, a 3-digit transmit code is sent each time [PTT] is pushed in order to open the receiving station's code squelch.
- ⑥ To cancel the code squelch, push [DTMF] 3 times.
 - The display shows the operating frequency and "REMO" does not illuminate.



- ① Push the desired band switch.
- ② Set the operating frequency.
- ③ Push [FUNC]; then, push [5 C SQL] to turn the code squelch ON.
 - "C" appears in place of the 100 MHz digit.
 - An optional tone squelch can be used together with the code squelch. (p. 69)
- ④ Select the desired code channel:
 - Push [8 SET].
 - Push [UP] or [DN] to select the code channel.
 - Push [A CLR] to exit the setting display.
- ⑤ Operate the transceiver in the normal way (push [PTT] to transmit; release [PTT] to receive).
 - Prior to voice transmission, a 3-digit transmit code is sent each time [PTT] is pushed in order to open the receiving station's code squelch.
- ⑥ To cancel the code squelch, push [A CLR].
 - Pushing [FUNC] then [8 D-OFF] also cancels the code squelch.



■ Pocket beep operation

This function uses subaudible tones for calling and can be used as a "common pager" to inform you that someone has called while you were away from the transceiver.

To operate the pocket beep function, an optional UT-76 is necessary for non-U.S.A. versions. See p. 16 for installation.

◇ Waiting for a call from a specific station

- ① Push the desired band's tuning dial.
- ② Set the operating frequency.
- ③ Program the subaudible tone frequency in set mode.
 - See p. 35 for programming details.
- ④ Push and hold [DUP/TONE] for 1 sec., several times until "T SQL (1.0)" appears in the function display.
 - Turn OFF the optional pager or code squelch to activate the pocket beep. (pgs. 64, 67) The pocket beep cannot be used in combination with the pager or code squelch.
- ⑤ When a signal with the correct tone is received, the transceiver emits beep tones for 30 sec. and flashes "(1.0)."
- ⑥ Push [PTT] to answer or push the desired band's tuning dial to stop the beeps and flashing.
 - Tone squelch is automatically selected.
- ⑦ Push and hold [DUP/TONE] for 1 sec. to cancel the function.



- ① Push the desired band switch.
- ② Set the operating frequency.
- ③ Program the subaudible tone frequency in set mode.
 - See p. 35 for programming details.
- ④ Push [FUNC] then [Ⓢ T SQL (1.0)] to turn the pocket beep ON.
 - Turn OFF the optional pager or code squelch to activate the pocket beep. (pgs. 64, 67) The pocket beep cannot be used in combination with the pager or code squelch.
- ⑤ When a signal with the correct tone is received, the transceiver emits beep tones for 30 sec. and flashes "(1.0)."
- ⑥ Push [PTT] to answer or push [Ⓐ CLR] to stop the beeps and flashing.
 - Tone squelch is automatically selected.
- ⑦ To cancel the function, push [FUNC] then [Ⓢ T-OFF].



◇ Calling a waiting station using pocket beep

A subaudible tone matched with the station's tone frequency is necessary. Use the tone squelch at right or a subaudible tone encoder (p. 34, optional except for 88.5 Hz for non-U.S.A. versions).

15 POCKET BEEP AND TONE SQUELCH

■ Tone squelch operation

The tone squelch opens only when receiving a signal with the same pre-programmed subaudible tone. You can silently wait for a call from group members using the same tone. This function can be activated on 3 bands with separate tone frequencies simultaneously.

- ① Push the desired band's tuning dial.
- ② Set the operating frequency.
- ③ Program the subaudible tone frequency in set mode.
 - See p. 35 for programming details.
- ④ Push and hold [DUP/TONE] for 1 sec., several times until "T SQL" appears in the function display.
 - The optional code squelch can be used together with the tone squelch. (p. 67)
- ⑤ When the received signal includes the correct tone, the squelch opens and the signal can be heard.
 - When the received signal includes an incorrect tone, the squelch does not open. Only the S/RF indicator shows the signal strength.
 - To open the accessed band squelch manually, push and hold [DTMF/MONI].
- ⑥ Operate the transceiver in the normal way (push [PTT] to transmit; release [PTT] to receive).
- ⑦ To cancel the tone squelch, push and hold [DUP/TONE] for 1 sec.
 - "T SQL" disappears from the function display.



- ① Push the desired band switch.
- ② Set the operating frequency.
- ③ Program the subaudible tone frequency in set mode.
 - See p. 35 for programming details.
- ④ Push [FUNC] then [9 T SQL] to turn the tone squelch ON.
 - The optional code squelch can be used together with the tone squelch. (p. 67)
- ⑤ When the received signal includes the correct tone, the squelch opens and the signal can be heard.
 - When the received signal includes an incorrect tone, the squelch does not open. Only the S/RF indicator shows the signal strength.
 - To open the accessed band squelch manually, push [⊗ MONI].
- ⑥ Operate the transceiver in the normal way (push [PTT] to transmit; release [PTT] to receive).
- ⑦ To cancel the tone squelch, push [FUNC] then [© T-OFF].



■ Beep tone volume selection

You can select silent operation with beep tone OFF or confirmation operation with beep tone ON. Beep tone volume can be set to 1 of 3 levels.

To inform you which band is operating, a low beep tone, medium beep tone or a high beep tone is emitted while operating on the VHF, UHF or 1.2 GHz band, respectively.

The display shows that beep tone is turned ON and the beep tone volume level is medium.

- ① Push [PWR] on the transceiver OUT to turn power OFF.
- ② While pushing [SET], push the [PWR] switch IN to enter initial set mode.
- ③ Push [SET] 2 times to select "bEP" in the VHF function display as shown above.
 - Pushing [SPCH] reverses the order. (p. 18).
- ④ Rotate the VHF tuning dial to select the condition.
 - "bEP-oF" : Beep tone is turned OFF.
 - "bEP- 1"-"bEP- 3" : Beep tone is turned ON. "bEP- 3" is the maximum volume level.
- ⑤ Push the [PWR] switch OUT to exit initial set mode.

■ Speaker jack selection

You can select the audio output for each band separately or mix them.

When mixed output is selected, all band's audio signals are output from the [144 MHz SP] jack.

The display shows that all band's audio signals are output from the [144 MHz SP] jack.

- ① Push [PWR] on the transceiver OUT to turn power OFF.
- ② While pushing [SET], push the [PWR] switch IN to enter initial set mode.
- ③ Push [SET] 3 times to select "SPJ" in the VHF function display as shown above.
 - Pushing [SPCH] reverses the order. (p. 18).
- ④ Rotate the VHF tuning dial to select the condition.
 - "SPJ-Co" : Received audio is output from the [144 MHz SP] jack. No audio signal is output from other jacks.
 - "SPJ-SE" : Received audio is output from each speaker jack.
- ⑤ Push the [PWR] switch OUT to exit initial set mode.

16 OTHER FUNCTIONS

■ Display dimmer setting

USING SET MODE

Adjust the intensity to suit lighting conditions and personal preference.

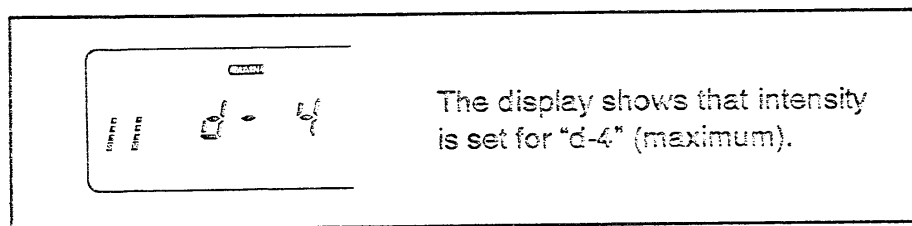

- ① Push [SET] several times until one of "d-1"—"d-4" appears as shown above.
 - Pushing [SPCH] reverses the order. (p. 18).
 - Cancel the DTMF memory function, optional pager or code squelch in advance. (pgs. 54, 64, 67)
- ② Rotate the main band's tuning dial to set the desired intensity.
 - The intensity level can be changed in 4 steps from d-1 (Dark) to d-4 (Bright).
- ③ Push the main band's tuning dial to exit set mode.



- ① Push [ⓑSET] one or more times until "d-1"—"d-4" appears as shown at left.
 - Pushing [ⓒSPCH] reverses the order. (p. 18).
 - Cancel the DTMF memory function, optional pager or code squelch in advance. (pgs. 54, 64, 67)

- ② Push [UP] or [DN] to set the desired intensity.
 - The intensity level can be changed in 4 steps from d-1 (Dark) to d-4 (Bright).
- ③ Push [ⒶCLR] to exit set mode.

■ Optional voice synthesizer

The transceiver announces the operating frequency in English or Japanese when an optional UT-66 VOICE SYNTHESIZER UNIT is installed. This function can be activated even when the frequency lock function is turned ON. See p. 16 for installation.

Push [SPCH] to announce the operating frequency.

- While accessing a sub band, the transceiver announces the sub band frequency.
- 4 types of speech conditions are available. See page at right.

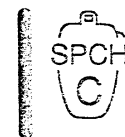

Push [ⓒSPCH] to announce the operating frequency.

◇ Speech condition setting

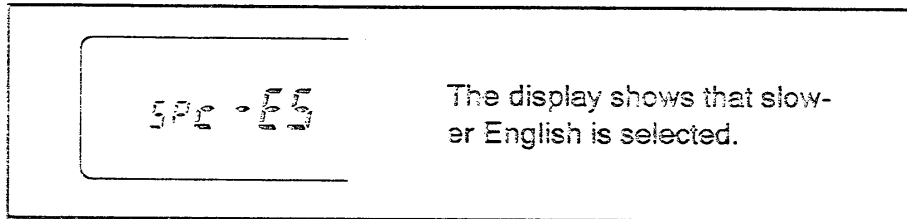

- ① Push [PWR] on the transceiver OUT to turn power OFF.
- ② While pushing [SET], push the [PWR] switch IN to enter initial set mode.
- ③ Push [SPCH] to select "SPc" in the VHF function display as shown above.
- ④ Rotate the VHF tuning dial to select the condition.

DISPLAY	SPEECH CONDITION
SPc-ES	Slower English
SPc-EF	Faster English
SPc-JS	Slower Japanese
SPc-JF	Faster Japanese

- ⑤ Push the [PWR] switch OUT to exit initial set mode.

■ Partial resetting

If you want to initialize the operating conditions (VFO frequency, VFO settings, set mode contents, initial set mode contents, memory bank selection) without clearing the memory contents, a partial resetting function is available for the transceiver.

- ① Push [PWR] on the transceiver OUT to turn power OFF.
- ② While pushing [SPCH], turn power ON to partially reset the transceiver.
- ③ Change the memory bank, if desired. (p. 41)
 - Check the memory channel. The transceiver automatically selects the primary memory bank. If the memory contents are not your usual memory contents, turn power ON while pushing [SET] and [LOW] to change the memory bank.

16 OTHER FUNCTIONS

■ Resetting the transceiver

The function display may occasionally display erroneous information, (e.g., when first applying power). This may be caused externally by static electricity or other factors.

If this problem occurs, turn power OFF. After waiting a few seconds, turn power ON again. If the problem continues, perform the following procedure.

Partial resetting is alternatively available. See previous page for details.

NOTE: Resetting the CPU **CLEARs** all memory information, and initializes all values.

- ① Push [PWR] on the transceiver OUT to turn power OFF.
- ② While pushing [SET] and [SPCK], turn power ON.
 - All segments appear on the function display, and the CPU is reset.

■ Microphone address

The transceiver has 8 kinds of microphone address. Set both the microphone address and the microphone dip switch to address 1 as follows.

◇ Microphone address

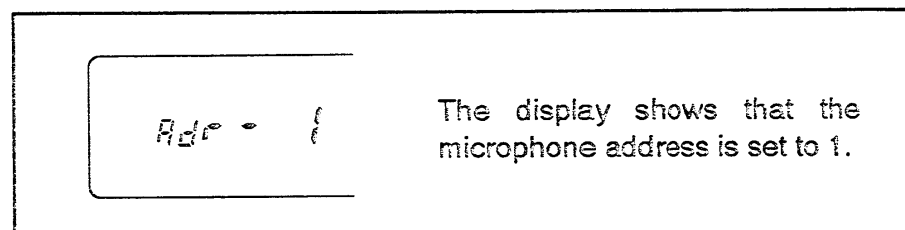

- ① Push [PWR] on the transceiver OUT to turn power OFF.
- ② While pushing [SET], push the [PWR] switch IN to enter initial set mode.
 - "Adr" appears in the VHF function display.
- ③ Rotate the VHF tuning dial to set the microphone address to 1 ("Adr- 1").
- ④ Push the [PWR] switch OUT to exit initial set mode.

▨ The microphone dip switch is set to address 1 as a default value. If the microphone address is set to any value other than 1, the transceiver cannot be controlled by the microphone. Be sure to set the microphone address to 1 ("Adr- 1").

◇ Microphone dip switch

- ① Remove the switch cover from the microphone rear panel.
- ② Set the microphone dip switch to address 1 as shown below.
- ③ Replace the switch cover.

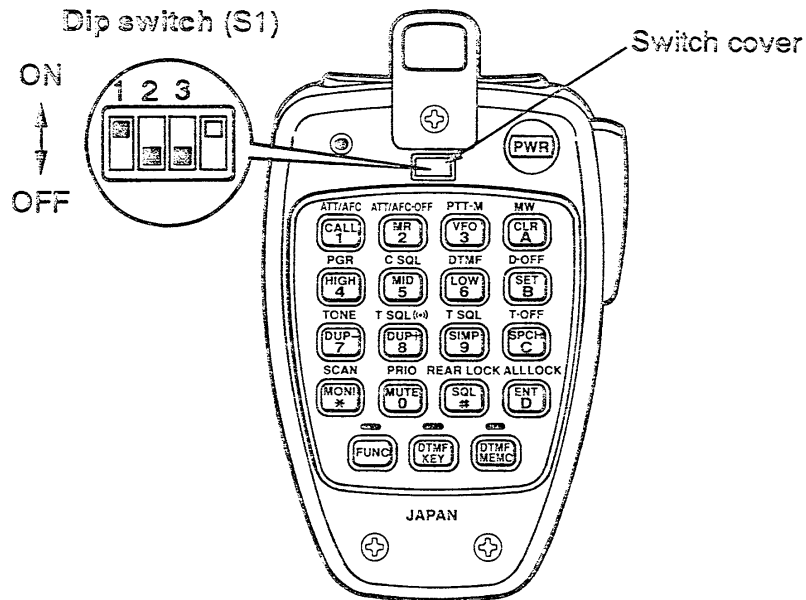

■ Time-out timer

To prevent continuous transmission with the one-touch PTT function, etc., the transceiver has a time-out timer. This timer turns the transmission OFF 3, 5, 15 or 30 min. after the transmission starts. This timer can be cancelled.

Approx. 10 sec. before the time-out time passes, the transceiver emits a beep tone.

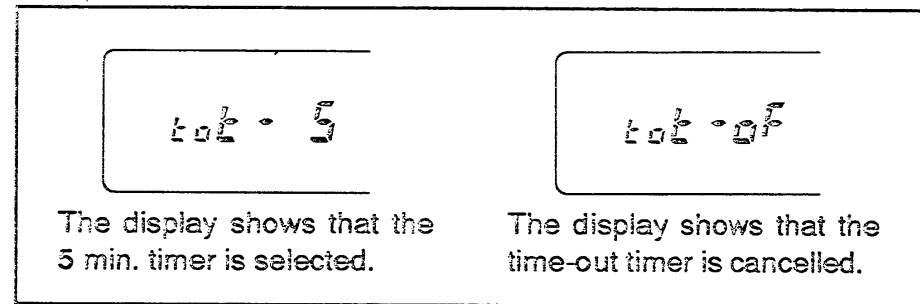

- ① Push [PWR] on the transceiver OUT to turn power OFF.
- ② While pushing [SET], push the [PWR] switch IN to enter initial set mode.
- ③ Push [SET] once to select "tot" in the VHF function display as shown above.
- ④ Rotate the VHF tuning dial to select the desired time-out time to 3, 5, 15, 30 min. or turn the timer OFF ("oF").
- ⑤ Push the [PWR] switch OUT to exit initial set mode.

17 MAINTENANCE

■ Troubleshooting

If your transceiver seems to be malfunctioning, please check the following points before sending it to a service center.

PROBLEM	POSSIBLE CAUSE	SOLUTION	REF.
<ul style="list-style-type: none"> • No power comes on. 	<ul style="list-style-type: none"> • Power connector has a poor contact. • Polarity of the power connection is reversed. • Blown fuse. 	<ul style="list-style-type: none"> • Check the connector pins. • Reconnect the power cable observing the proper polarity. Replace the fuse, if damaged. • Check the cause, then replace the fuse. 	<p>–</p> <p>pgs. 13, 77</p> <p>p. 77</p>
<ul style="list-style-type: none"> • No sound comes from the speaker. 	<ul style="list-style-type: none"> • Volume level is low. • The squelch level is set too tight. • The optional pager, code squelch, pocket beep or tone squelch is turned ON. 	<ul style="list-style-type: none"> • Rotate [VOL] clockwise. • Set the squelch level to the threshold. (4 dots) • Turn the appropriate function OFF. 	<p>p. 24</p> <p>p. 25</p> <p>pgs. 64–69</p>
<ul style="list-style-type: none"> • Sub band signals are not audible. 	<ul style="list-style-type: none"> • The sub band mute function is activated. 	<ul style="list-style-type: none"> • Turn the function OFF. 	<p>p. 28</p>
<ul style="list-style-type: none"> • Sensitivity is low and only strong signals are audible. 	<ul style="list-style-type: none"> • Antenna feedline or the antenna connector solder has a poor contact or is short circuited. • The RF attenuator is turned ON. 	<ul style="list-style-type: none"> • Check, and if necessary, replace the feedline or solder the antenna connector again. • Push [LOW/ATT/AFC] for 1 sec. to turn the function OFF. 	<p>p. 14</p> <p>p. 26</p>
<ul style="list-style-type: none"> • No contact possible with another station. 	<ul style="list-style-type: none"> • The transceiver is set to semi-duplex. • The other station is using code or tone squelch. 	<ul style="list-style-type: none"> • Set to simplex. • Turn ON the code or tone squelch. (UT-75 or UT-76 is necessary.) 	<p>p. 33</p> <p>pgs. 67, 69</p>
<ul style="list-style-type: none"> • Repeater cannot be accessed. 	<ul style="list-style-type: none"> • Wrong offset frequency is programmed. • Wrong subaudible tone frequency is programmed. 	<ul style="list-style-type: none"> • Correct the offset frequency. • Correct the subaudible tone frequency. (UT-76 is necessary for non-U.S.A. versions.) 	<p>p. 36</p> <p>p. 35</p>
<ul style="list-style-type: none"> • Frequency cannot be set. 	<ul style="list-style-type: none"> • The frequency lock function is activated. • Priority watch is paused on the watching frequency. 	<ul style="list-style-type: none"> • Turn the function OFF. • Push [M/CALL/PRIO] to resume the watch. 	<p>p. 20</p> <p>p. 53</p>

PROBLEM	POSSIBLE CAUSE	SOLUTION	REF.
<ul style="list-style-type: none"> ◦ Frequency cannot be set via microphone. 	<ul style="list-style-type: none"> ◦ The microphone all lock or rear lock function is activated. ◦ The microphone address is not matched. ◦ Priority watch is paused on the watching frequency. 	<ul style="list-style-type: none"> ◦ Turn the function OFF. ◦ Reset the microphone address and dip switch. ◦ Push [M/CALL/PRIO] to resume the watch. 	<p>p. 20</p> <p>p. 73</p> <p>p. 53</p>
<ul style="list-style-type: none"> ◦ Some memory channels cannot be selected. 	<ul style="list-style-type: none"> ◦ The memory channel is outside of the memory area. 	<ul style="list-style-type: none"> ◦ Reset the memory area. 	<p>p. 41</p>
<ul style="list-style-type: none"> ◦ Scan does not operate. 	<ul style="list-style-type: none"> ◦ Squelch is open. ◦ The selected scan edge memory channels (e.g. 1A and 1b) have the same frequencies (for programmed scan). ◦ All memory channels are programmed as skip channels (for memory scan). ◦ Priority watch is activated. 	<ul style="list-style-type: none"> ◦ Set the squelch to the threshold point. ◦ Reset the scan edges. ◦ Cancel the memory skip function in the desired channel. ◦ Turn the function OFF. 	<p>p. 25</p> <p>pgs. 47, 48</p> <p>p. 50</p> <p>p. 53</p>
<ul style="list-style-type: none"> ◦ Transmission is automatically cut off. 	<ul style="list-style-type: none"> ◦ Time-out timer is activated. 	<ul style="list-style-type: none"> ◦ Set the timer to OFF. 	<p>p. 74</p>
<ul style="list-style-type: none"> ◦ Transmission continues even when the PTT switch released. 	<ul style="list-style-type: none"> ◦ One-touch PTT function is activated. 	<ul style="list-style-type: none"> ◦ Turn the function OFF. 	<p>p. 32</p>
<ul style="list-style-type: none"> ◦ All programmed memories have been erased. 	<ul style="list-style-type: none"> ◦ The CPU is malfunctioning. ◦ Backup battery is exhausted. 	<ul style="list-style-type: none"> ◦ Reset the CPU. ◦ Send the transceiver to an authorized Icom Dealer or Service Center to replace the backup battery. 	<p>p. 73</p> <p>p. 77</p>

■ Fuse replacement

If the fuse blows or the transceiver stops functioning, find the source of the problem if possible, and replace the damaged fuse with a new, rated fuse (20 A) as shown in the diagram below.

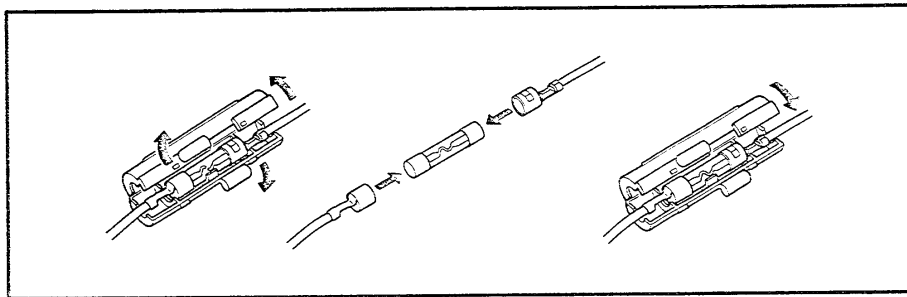

■ Backup battery

The transceiver is equipped with a lithium backup battery for retaining memory information.

The life of the lithium backup battery is usually more than 5 years. When the battery is exhausted, the transceiver operates normally but the CPU cannot retain memory information.

NOTE: DO NOT attempt to replace the backup battery yourself. It can be replaced only by an authorized Icom Dealer or Service Center.

■ External equipment connection

The microphone connector accepts only digital control signals. When connecting external equipment, proceed as below. Note that the audio signal from the microphone is cut out when using this "PTT" terminal. The "O" terminal outputs only the main band's audio signal.

- ① Turn power OFF, then disconnect the DC power cable.
- ② Remove the transceiver bottom cover as shown at right.
- ③ Solder the desired equipment cable as shown below.
- ④ Replace the bottom cover and DC power cable.

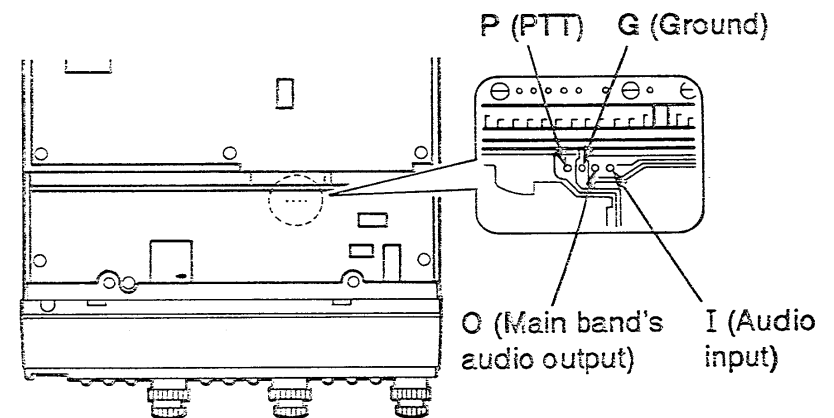
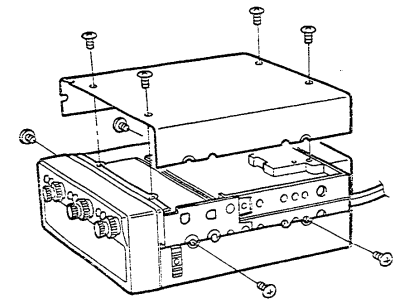

■ GENERAL

• Frequency coverage

VERSION		144 MHz	430(440) MHz	1.2 GHz
U.S.A.	Tx	144–148 MHz	440–450 MHz	1240–1300 MHz
	Rx	136–174 MHz*1		
Asia	Tx	144–148 MHz	430–440 MHz	1240–1300 MHz
	Rx	136–174 MHz*1		
Australia		144–148 MHz	430–440 MHz	1240–1300 MHz
Europe		144–148 MHz	430–440 MHz	1240–1300 MHz
Italy	Tx	144–148 MHz	430–440 MHz	1240–1300 MHz
	Rx	136–174 MHz*1	400–479 MHz*2	

*1 Guaranteed frequency coverage is 144–148 MHz.

*2 Guaranteed frequency coverage is 430–440 MHz.

- Mode : FM
- Antenna impedance : 50 Ω (nominal)
- Power supply requirement : 13.8 V DC ± 15%
- Usable temperature range : -10°C to +60°C; +14°F to +140°F
- Dimensions : 140(W) × 50(H) × 194.5(D) mm
(projections not included) 5.5(W) × 2.0(H) × 7.7(D) in
- Weight : 2.05 kg; 4.5 lb

■ TRANSMITTER

- Modulation system : Variable reactance frequency modulation
- Max. frequency deviation : ± 5.0 kHz
- Spurious emissions :
144 MHz/430(440) MHz Less than -80 dB
1.2 GHz Less than -50 dB
- Microphone impedance : 600 Ω

• Output power and current drain:

CONDITION		POWER	CURRENT
144 MHz	High	50 W	12.0 A
	Low 2	10 W	7.0 A
	Low 1	5 W	5.5 A
430(440) MHz	High	35 W	10.5 A
	Low 2	10 W	7.0 A
	Low 1	5 W	5.5 A
1.2 GHz	High	10 W	6.5 A
	Low 1	1 W	3.8 A

■ RECEIVER

- Receive system : Double-conversion superheterodyne
- Intermediate frequencies :
144 MHz 1st 41.8 MHz 2nd 455 kHz
430(440) MHz 1st 42.25 MHz 2nd 455 kHz
1.2 GHz 1st 72.2 MHz 2nd 455 kHz
- Sensitivity (for 12 dB SINAD): Less than 0.16 μV
- Squelch sensitivity (at threshold): Less than 0.13 μV
- Selectivity : More than 15 kHz/-6 dB
Less than 30 kHz/-60 dB
- Spurious response rejection ratio
(except 1/2 intermediate frequency): More than 60 dB
- Audio output power : More than 2.4 W at 10% distortion
with the 8 Ω internal speaker.
- Current drain :
Rated audio output on all 3 bands 3.2 A
Squelched on all 3 bands 1.8 A

All stated specifications are subject to change without notice or obligation.

19 OPTIONS

Unpacking

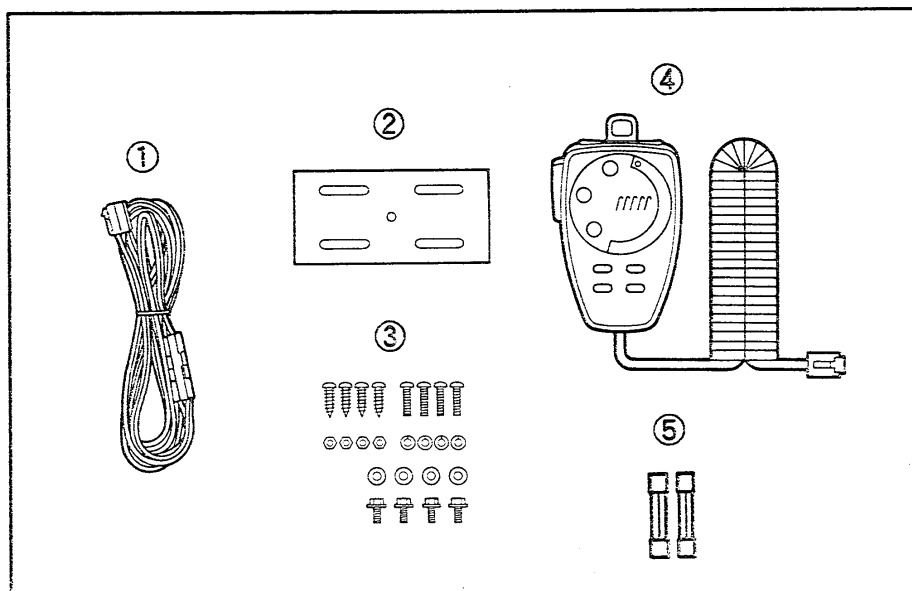

Accessories Included with the transceiver:	Qty.
① DC power cable (OPC-346)	1
② Mounting bracket (MB-27)	1
③ Mounting screws; nuts and washers	1 set
④ Microphone*	1
⑤ Fuses (20 A)	2

* U.S.A. version : HM-88A
 Non-U.S.A. versions : HM-88

Options

Some versions cannot use all of the following options since electrical standards, etc. vary between countries. Ask your Icom Dealer which options are available.

SP-7 EXTERNAL SPEAKER

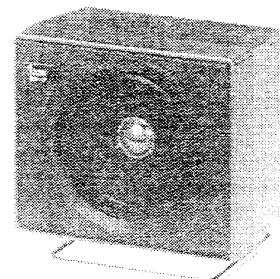

Cable length: 1.0 m; 3.3 ft

SP-10 EXTERNAL SPEAKER

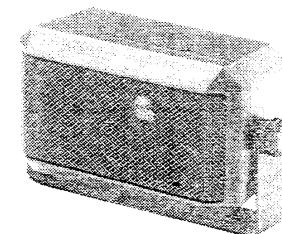

Cable length: 1.5 m; 4.9 ft

SP-12 EXTERNAL SPEAKER

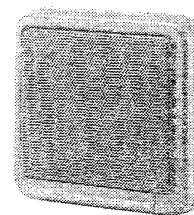

Cable length: 2.0 m; 6.6 ft

OPC-332/333 SEPARATION KIT

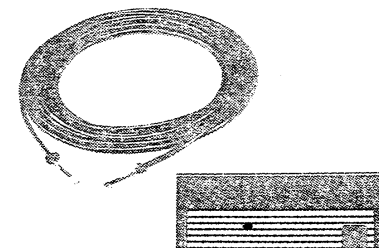

Cable length:
 OPC-332 : 3.5 m; 11.5 ft
 OPC-333 : 7.0 m; 23.0 ft

AH-32 144/430(440) MHz DUAL BAND ANTENNA

Dual band mobile antenna.

Frequency range : 144–148 MHz and 430–450 MHz

Max. input power : 150 W

AHB-32 TRUNK MOUNT

Trunk mount with a coaxial cable for the AH-32.

HM-88/A HAND MICROPHONE

Same as the supplied one.

MB-27 MOBILE MOUNTING BRACKET

Same as the supplied one.

MB-50 REMOTE CONTROLLER BRACKET

Mounts the remote controller in a convenient location.

OPC-335 SPEAKER CABLE

Extends the speaker cable. Has 3 band capability and a length of 5.0 m (16.4 ft).

OPC-346 DC POWER CABLE

Same as supplied one.

OPC-347 DC POWER CABLE

Has 20 A capacity and a length of 7.0 m (23.0 ft).

IC-PS30 DC POWER SUPPLY

Provides 13.8 V DC and 25 A max. for base station use.

UT-66 VOICE SYNTHESIZER UNIT

Announces the accessing band frequency.

UT-75 DTMF DECODER UNIT

Provides pager and code squelch functions. Necessary for external DTMF remote.

UT-76 TONE SQUELCH UNIT

Provides pocket beep and tone squelch functions. Also functions as a subaudible tone encoder.

Count on us!

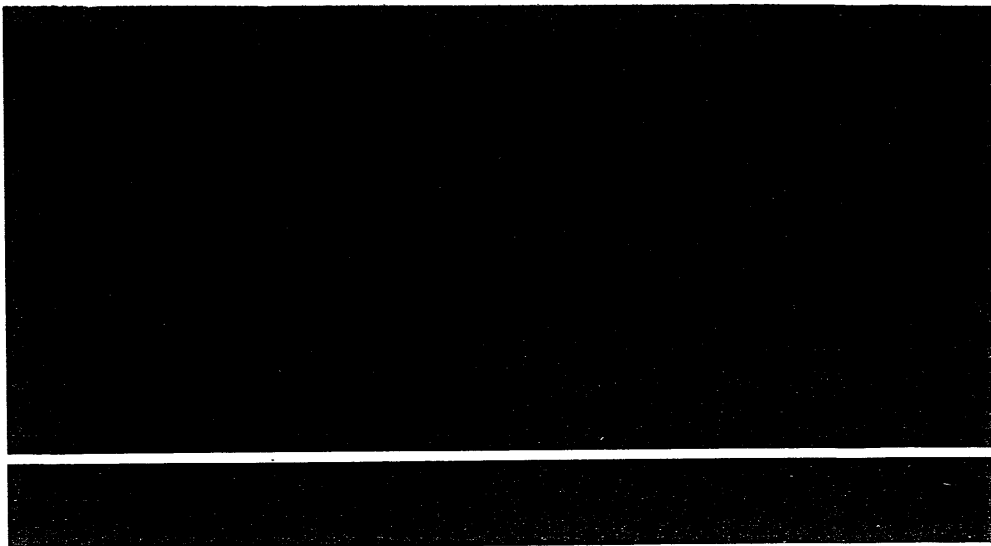

A-5253S-1EX
Printed in Japan
Copyright © 1993 by Icom Inc.

Icom Inc.
6-9-16, Kamihigashi, Hirano-ku, Osaka 547, Japan
