

KENWOOD

DC POWER SUPPLY

PS-33
PS-53

Scanned by IW1AXR
Downloaded by
RadioAmateur.EU

INSTRUCTION MANUAL

KENWOOD CORPORATION

Thank you for purchasing this new DC Power Supply. This unit has been carefully engineered and manufactured to rigid quality standards, and should give you satisfactory and dependable operation for many years.

This Instruction Manual covers the following model versions:
U.S.A. and Canada,
Europe and Oceania,
U.K.,
and General Markets

The following explicit definitions apply in this Instruction Manual.
WARNING : Risk of fire or electric shock may occur. **DO NOT DISREGARD!**
CAUTION : Equipment damage may occur, but not personal injury.
NOTE : If disregarded, inconvenience only, no risk of equipment damage or personal injury.

IMPORTANT
1. Please read this Instruction Manual carefully before placing your DC Power Supply in service.
2. Save this Instruction Manual.

NOTE
The first time this equipment is used, a faint odor may be given off by the power transformer. This is merely the filler in the power transformer or the wax on the capacitors evaporating as the unit warms up. This is normal and is not a defect.

For United Kingdom
The mains plug must be removed from the wall socket prior to any internal examination.

Important
The wires in this mains lead are coloured in accordance with the following code:
Blue Neutral
Brown Live
Green and Yellow Earth

The wires in this mains lead must be connected to the terminals in the plug as follows:

Wire colour	Plug terminal making
Blue	N or Black
Brown	L or Red
Green and Yellow	E or \perp or Green and Yellow

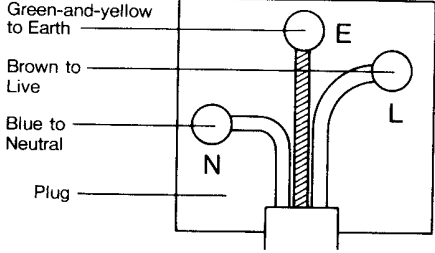

Note:
If a 13-amp plug is used, this must be fitted with a 5-amp fuse.

1. **WARNING** BEFORE OPERATION

TO PREVENT ELECTRIC SHOCK, FIRE AND OTHER INJURY. PLEASE NOTE THE FOLLOWINGS:

Do not place this unit, where it will be exposed to direct sunlight or close to heating appliances.

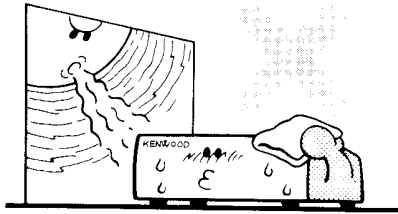

Do not place anything on top of the cabinet.

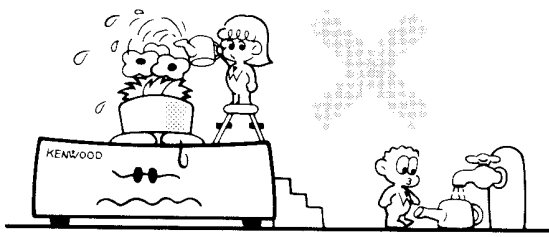

To ensure good ventilation, do not put anything on top of the cabinet and allow at least 15 cm (6 inches) of space behind the unit.

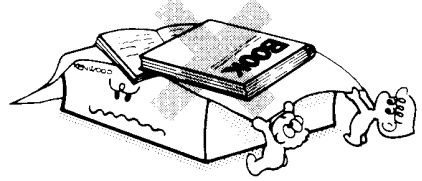

Do not place the unit in areas of excessive dust, high humidity or on unstable surfaces.

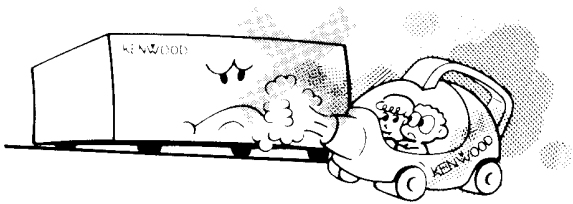

To avoid risk of electric shock, under no circumstances should the unit be opened:

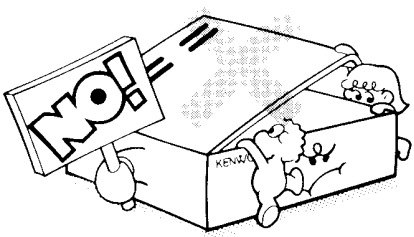

Do not drop pieces of metal, needles, coins and other electrically conductive materials into the unit.

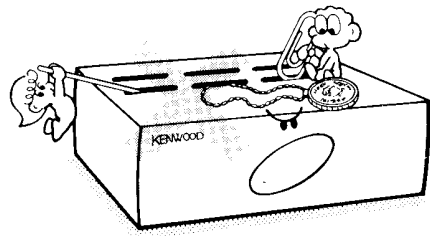

Do not touch the power plug, when your hands are wet.

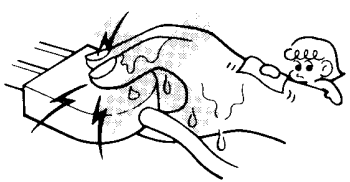

Do not pull the power cord, when disconnecting it from the AC wall outlet. Grasp the plug and ensure that your fingers do not touch the live pins.

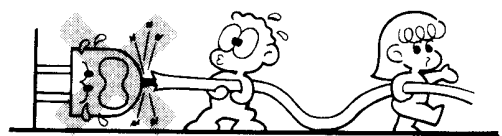

If an abnormal odor or smoke is detected, immediately turn the power off and pull out the power plug. Contact the KENWOOD service station or your dealer.

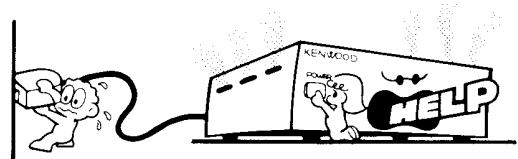

CLEANING

1. Turn the power off, before cleaning the unit.
2. Do not use any type of abrasive pad, thinner, benzine or any substances which may damage the unit.
3. Wipe the front panel and other exterior surfaces of the unit with a soft dry cloth or a soft cloth lightly moistened with water.

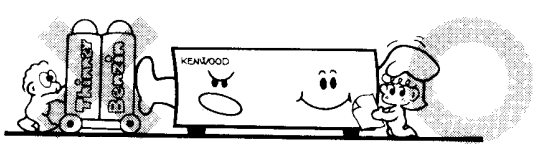

2. SPECIFICATIONS AND ACCESSORIES

2-1. SPECIFICATIONS

VERSIONS SPECIFICATIONS	PS-33		
	U.S.A. and Canada	Europe and General markets	U.K. and Oceania
Power requirements	120 VAC ±10%, 60Hz	*120/220~230 VAC ±10%, 50/60Hz	240 VAC ±10%, 50/60Hz
Output voltage	13.8 VDC (Reference)		
Rated output current	20.5 A (25% duty cycle) 15 A (50% duty cycle)		
Output voltage regulation	Within ±0.7 V (at 120/220~230/240 VAC ±10% variation with 15A) Within 0.7 V (at load current variation from 2 to 15A)		
Ripple voltage	Less than 20 mVrms (at 13.8 VDC/15A)		
Power consumption	Approx. 500 W (at 13.8 VDC/20.5A)		
Dimensions (W×H×D) Dimensions in [] include projections.	173×96×296 mm [173×107×322 mm] 6-13/16"×3-25/32"×11-21/32" [6-13/16"×4-7/32"×12-11/16"]		
Weight	Approx. 7.0 kg (15.4 lbs)		

VERSIONS SPECIFICATIONS	PS-53		
	U.S.A. and Canada	Europe and General markets	U.K. and Oceania
Power requirements	120 VAC ±10%, 60Hz	*120/220~230 VAC ±10%, 50/60Hz	240 VAC ±10%, 50/60Hz
Output voltage	13.8 VDC (Reference)		
Rated output current	22.5 A (25% duty cycle) 16 A (50% duty cycle) 20.5 A max. (Continuous operation for 1 hour)		
Output voltage regulation	Within ±0.7 V (at 120/220~230/240 VAC ±10% variation with 16A) Within 0.7 V (at load current variation from 2 to 16A)		
Ripple voltage	Less than 20 mVrms (at 13.8 VDC/16A)		
Power consumption	Approx. 550 W (at 13.8 VDC/22.5A)		
Dimensions (W×H×D) Dimensions in [] include projections.	173×96×296 mm [173×107×322 mm] 6-13/16"×3-25/32"×11-21/32" [6-13/16"×4-7/32"×12-11/16"]		
Weight	Approx. 6.9 kg (15.2 lbs)		

NOTES

1. Rating are subject to change without notice due to advancements in technology.
2. *: Switchable.

2-2. ACCESSORIES

Please unpack your new DC Power Supply carefully, and confirm that the accessories listed below are included in the box. If any of the items are missing contact the dealer where the radio was purchased.

Spare fuse, 3A (Oceania version only)	F05-3022-05	1 ea.
Spare fuse, 4A (Except U.S.A., Canada and Oceania version)	F05-4024-05	1 ea.
Spare fuse, 6A (Except U.K. and Oceania version)	F05-6021-05	1 ea.
Instruction manual	B62-0142-XX	1 copy
Warranty card (U.S.A., Canada and Europe version only)		1 ea.

After unpacking

Shipping container:

Save the boxes and packing in the event your unit needs to be transported for remote operation, maintenance or service.

3. INSTALLATION AND CONNECTION

NOTE

The following instructions are for use by either your KENWOOD dealer, an authorized KENWOOD service facility, or the factory.

WARNING

Never connect AC power to the DC Power Supply until installation is complete.

3-1. INSTALLATION

CAUTIONS

1. Prior to installation, check that the correct fuse is installed.
2. Choose a location that is relatively free from vibration.
3. Do not place the unit in a place which is exposed to direct sunlight, near a heater, etc.
4. Do not store or use the unit in a dusty location or in a moist atmosphere. Select a well ventilated location.
5. To maintain good ventilation:
 - Remove the packing materials.
 - Do not cover the unit.
 - Place the unit at least 10 cm (4") away from the walls.
6. (With the Europe and the General Markets version only)
Prior to installation, check that the AC Voltage Selector on the side panel is set to the correct line voltage.

AC VOLTAGE SELECTION

(With the Europe and General Markets version)

CAUTION

Make sure that the AC cable is disconnected before selecting an AC voltage.

When changing an AC operating voltage, select the desired voltage with the selector switch located on the side cover. In this case, the correct fuse must be installed, referring to Section 5-4. FUSE REPLACEMENT.

3-2. CONNECTION

WARNING

Never connect AC power to the DC Power Supply until installation is complete.

CAUTIONS

1. Before connecting or disconnecting the DC Power Cable, be sure to turn off the POWER switches of both the radio and the DC Power Supply.
2. Observe polarity of the DC Power Cable. The radio operates on 13.8 VDC, negative ground.

NOTES

1. The DC Power Supply will not operate if the output terminals are shorted.
 2. The DC Power Supply may not operate if the POWER switch is turned on with the radio in transmit mode because the protection circuit may operate.
1. Connect the DC Power Cable from the radio to the Output Terminals on the Rear Panel, as shown in Fig. 3-1..
 - Red lead → Plus (+) Terminal
 - Black lead → Minus (-) Terminal
 2. Connect the AC power Cable to the AC outlet.

NOTE

Illustration shows the U.S.A. version.

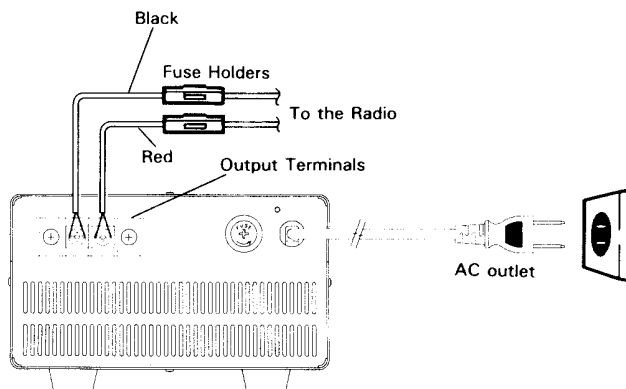

Fig. 3-1.

4. OPERATION

WARNING

1. Do not operate the DC Power Supply with the packing materials attached.
2. Never remove the case. If the internal parts are accidentally touched, a serious electric shock might occur.
3. To reduce the risk of fire or electric shock, do not expose the DC Power Supply to rain or moisture.

NOTE

For operation of the radio, refer to the Instruction Manual provided with the radio.

CONTROL AND FUNCTIONS

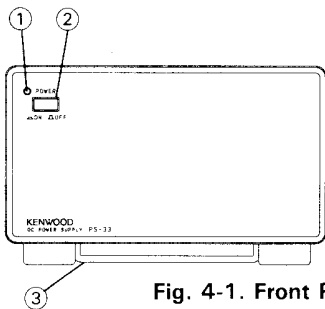

Fig. 4-1. Front Panel

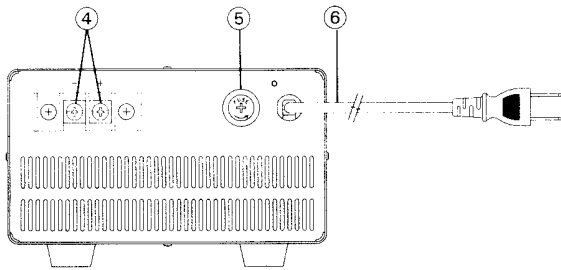

Fig. 4-2. Rear Panel

- ① POWER ON Indicator
This Indicator lights when the DC Power Supply is on.
- ② POWER Switch
This switch turns power on and off.
- ③ BAIL
Used to elevate the front Panel.
- ④ Output Terminals
- ⑤ Fuse Holder
Contains a specified fuse.
- ⑥ AC Power Cable

1. Turn the radio POWER switch on after the DC Power Supply POWER switch is turned on.

NOTE

If the DC Power Supply protection circuit operates, turn the POWER switches of both the radio and the DC Power Supply off, and perform the procedure above again.

2. When communication is completed for the day, turn off the POWER switches of both the radio and the DC Power Supply.

5. MAINTENANCE

5-1. GENERAL INFORMATION

Your DC Power Supply has been factory adjusted and tested to specifications before shipment. Under normal circumstances, the DC Power Supply will operate in accordance with these operating instructions. All adjustments were preset at the factory and should only be readjusted by a qualified technician with proper test equipment. Attempting service or adjustment without factory authorization can void the DC Power Supply's warranty. If your DC Power Supply fails to work, contact the authorized KENWOOD dealer from which you purchased it for quick, reliable repair.

NOTES

1. When claiming warranty service, please include a photocopy of the bill of sale, or other proof of purchase showing the date of sale.
2. Record the Date of Purchase, Serial Number and Dealer from whom purchased.
3. For your own information, retain a written record of any maintenance performed on the unit.

5-2. SERVICE

Should it ever become necessary to return the equipment to your dealer or service center for repair, pack in its original box and packing, and include a full description of the problems involved. Also include your telephone number. You need not return accessory items unless directly related to the service problem.

CAUTION

Do not pack the equipment in crushed newspaper for shipment. Extensive damage may result during shipment.

NOTE

If you desire to correspond on a technical or operational problem, please make your note short, complete, and to the point, and PLEASE make it readable.

Please list:

Model and Serial Number.

The problem you are having.

Please give sufficient detail to diagnose.

Information such as other equipment in the station, meter readings and anything else you feel might be useful in attempting diagnosis.

5-3. CLEANING

The DC Power Supply is likely to become soiled after extended use. It should be cleaned with a silicone cloth or a clean dry cloth.

CAUTION

Do not use volatile solvents such as alcohol, paint thinner, gasoline, benzine, etc.

5-4. FUSE REPLACEMENT

If the fuse blows, DISCONNECT the AC Power Cable and contact an authorized KENWOOD service facility; either your KENWOOD dealer, or the factory to repair the cause.

NOTE

The following instructions are for use by either your KENWOOD dealer, an authorized KENWOOD service facility, or the factory.

WARNING

1. Never connect the AC cable to the AC outlet until fuse replacement has been made.
2. Never use a fuse of higher rating. Replace with a new fuse of the same rating.

This DC Power Supply is equipped with a fuse listed below. If the fuse blows, check for the cause before replacing the defective fuse. (Replacement fuses are available from your authorized KENWOOD dealer.)

Version	Voltage Setting	Part Number
U.S.A. and Canada	120 VAC	F05-6021-05 (6A)
Europe and General Market	120 VAC	F05-6021-05 (6A)
	230 VAC	F05-4024-05 (4A)
U.K.	240 VAC	F05-4024-05 (4A)
Oceania	240 VAC	F05-3022-05 (3A)

NOTE

Fuse Holder is located on rear panel for U.S.A. version as Fig. 4-2. ⑤.
Other version except for U.S.A. version, fuse holder is located inside of the top cover.

5-5. SUPPLY CORD REPLACEMENT (Oceania version only)

If the supply cord of this appliance is damaged, it must only be replaced by a repair shop appointed by the manufacturer, because special purpose tools are required.

5-6. ORDERING SPARE PARTS

NOTE

The following instructions are for use by either your KENWOOD dealer, an authorized KENWOOD service facility, or the factory.

When ordering replacement or spare parts for the equipment, be sure to specify the following:

Model and Serial Number.

Schematic Number of the part.

Printed Circuit Board Number on which the part is located.

Part Number and Name, if known, and Quantity desired.

Part Numbers for most replacement parts are contained in the Service Manual (usually available as an option from KENWOOD dealer).

KENWOOD CORPORATION

KENWOOD ELECTRONICS AUSTRALIA PTY. LTD.
P.O. BOX 504, 8 Figtree Drive, Australia Centre, Homebush N.S.W. 2140, Australia

■ AVR UNIT (X43-3030-01)

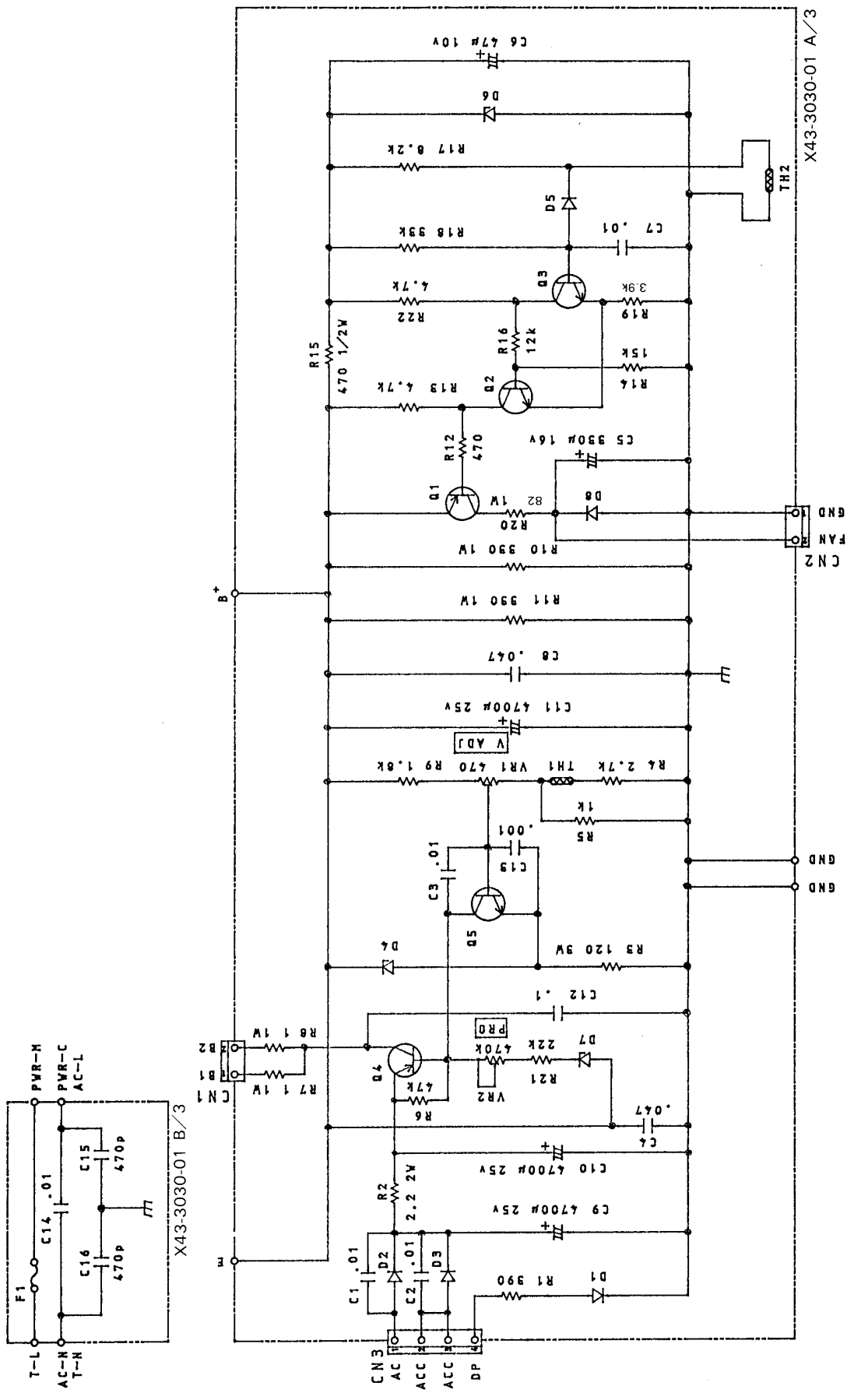

- Q1: 2SA562 (Y)
- Q2, Q3, Q5: 2SC2458 (Y)
- Q4: 2SB941(Q)
- D1, 5, 6: 1S1555
- D2, 3: DSA9A1
- D4, 6: UZ9.1BL
- D7: UZ15BH
- TH1: 92D27
- TH2: 5TP41L

Note:
Circuit is subject to change without notice due to advancement in technology.