

KENWOOD

IN-DEPTH MANUAL



Downloaded by RadioAmateur.EU

Preface

This in-depth manual for the TS-480 was written by the engineers who actually planned and designed the product. It is our hope that this guide will serve to convey the joys of HF and all the benefits of owning and using the TS-480 to whoever reads this guide – whether you have already purchased a TS-480, an accomplished operator, thinking of buying a transceiver, or just thinking of taking up Amateur Radio as a hobby. We believe the TS-480 will appeal to everyone.

CONTENTS

Design Objectives	2
Development Objectives for the TS-480 Series	5
Circuitry	7
TX circuits	7
RX circuitry	13
Auxiliary Features	19
Features of the Built-in DSP	21
Tips	28
Structural Features	36
New Option: Voice Guide & Storage Unit (VGS-1)	42
New Option: ARCP-480 (Freeware)	45
New Option: ARHP-10 (Freeware)	51



TS-480HX

200W output
(HF: 200W, 50MHz: 100W)

TS-480SAT

100W output (HF: 100W, 50MHz: 100W,
built-in automatic antenna tuner)

■ Design Objectives

Determination to create a unique transceiver

The concept of a compact HF transceiver first saw the light of day with Kenwood's TS-50. From then on, such equipment has become an essential part of the Amateur Radio world. Equipment has now evolved with the appearance of multi-band models.

In developing this new HF transceiver, Kenwood has boldly chosen not to follow this path, because we wanted to develop a transceiver unlike any other available. If we had developed a product along the same lines as the others currently in the market, the customers would not have found it a very attractive buy and few would choose it. This is why we wanted to develop a unique and attractive Kenwood product, something that would effectively serve to create a new market.

It was with these thoughts that we embarked on our new project and began to mull over the details. It was not to be an easy task. After all, every engineer involved in development wants to create something special and innovative. We had to find a way to put it into practice.

Back to basics: “The appeal of HF lies in DX’ing.”

The search for “a completely new kind of transceiver” sounds like it might turn out to be a wild goose chase, and in truth it is in the nature of things that such ideas rarely amount to much. But as part of our brainstorming, we went back to basics. What first emerged as a key concept was this: “The appeal of HF lies in DX’ing.” This is simple to say, but maybe more difficult to realize. From here the discussion moved ahead rapidly once it was decided to develop a compact HF transceiver.

According to conventional wisdom, a compact HF transceiver is by definition a mobile transceiver, and a fixed, base station is physically large. But we refused to stick to these stereotypes as we fleshed out the concept for a compact HF transceiver designed to make DX’ing really enjoyable.

- Even if it were to be a mobile unit, as an HF transceiver we wanted to ensure it would offer the operating ease and basic performance needed to enjoy DX’ing.
- Consequently, it should also be able to serve as a fixed station.
- The typical shack today has been equipped with a computer and there is not a great deal of room available for a large transceiver. This PC-transceiver combination would become even more common.
- Operating both as a mobile and as a fixed station, this new model would target customers dissatisfied with the compact transceivers currently on the market.

This was the concept that we started with.

Standalone control panel

For mobile operations, a separate control panel is ideal, but what if the transceiver is also to be used as a base station? This was the problem we faced. With a large desktop rig, it is no easy matter to shift things around to find the best position, so perhaps it would be a good idea to have a separate control panel that could be moved easily. Also, a desktop unit has various kinds of cables connected to it. What with the heat the main unit produces and the noise of the fan, etc., and considering that it does not have to be on the desk in front of you, it would surely be better to separate the control panel and place the main unit elsewhere.

With the appearance of computers in today's shacks, it is certainly desirable to tidy up the desktop as much as possible. We felt that we could contribute to this evolutionary process. By opting for a completely separate panel, we could ensure that it would be large enough to offer sufficient operating ease, since its dimensions would not be dictated by those of the compact main unit. This was how we arrived at the idea of a standalone control panel that is slightly larger than the main unit.

Focus on basic performance

The appeal of HF lies in DX'ing those places near and far. For this reason, we put a priority on operating ease and basic performance. At this point the project team had already excluded any idea of incorporating the V/UHF bands. Our approach was this: "Rather than spending development money on the V/UHF bands, let's spend money on HF performance." "If someone needs the V/UHF bands, then they can buy another product that is tailored for these bands." This meant we had confidence that our product would offer more than enough punch to perform well even on grueling DX'peditions.

The 200W challenge

As explained, our initial starting point was a desire to create a transceiver like no other. But we would not have succeeded in meeting this objective with just a standalone control panel and an emphasis on basic performance. We needed something more if we were to make the product truly special and stand out from the crowd.

The answer was to be found in the realization that DX operations depend on basic performance and power. Real "power" in a transceiver is something that many people look for. So a radical proposal was made: "Rather than making the output 100 watts, let's go all out for 200 watts!" But in fact the only transceivers on the market with 200W output were the expensive high-end models. What we were developing was a compact transceiver.

We seemed to have run up against a wall: Did this mean that in terms of size and cost we would inevitably end up creating a high-end transceiver? After long discussions, we made a straightforward decision to challenge the status quo: If conventional wisdom dictated that a 200W output was only available from a high-end transceiver, then we would change that dynamic.

At this point we could not see how this could be possible, but we stuck to our conviction that a 200W transceiver did not have to be expensive. We were determined to provide the customer with a 200W transceiver at a reasonable price. As a result of our single-mindedness, we were eventually able to achieve our goal, creating a product of about the same size as the TS-50 and, of course, it had heavy-duty specs.

Adding appeal to fixed station operations

It is now increasingly common to see a PC sitting beside the transceiver in the shack, but we wanted to expand the interaction between computers and transceivers. It was with this in mind that Kenwood came up with the idea of an Internet remote-controlled transceiver. You may be away on a business trip, but you want to operate, or you may want to use a large Yagi antenna out in the suburbs from your downtown apartment. In these and many other ways, fixed station operations are becoming more varied and more difficult. However, laws governing radio transmissions vary from country to country. In Japan, we had just about resigned ourselves to the fact that this could only be implemented as an RX feature when fortunately the law changed: starting January 13, 2004, both TX and RX operations became possible. This made all our development work worthwhile for our market in Japan and worldwide.

Overview of the TS-480 Series

The product concept for the TS-480 Series, as outlined, can be summarized thus:

- Not simply a compact HF mobile transceiver like the TS-50 and other transceivers on the market, the TS-480 is a completely new type of powerful compact HF transceiver offering the performance and features required for HF DX operations.
- TX output of 200W (HF), an astounding figure; and up till now, only available from the top-of-the-line models.
- Transceiver remote control

In order to realize all three of these, we started the design process with the following planning objectives:

1. Priority on basic performance that stresses the 1.8 ~ 50 MHz range;
2. Dynamic range on a par with the TS-950;
3. Uncompromising RX performance, AF DSP as standard;
4. A control panel design that ensures top-notch operating ease, so that desired functions can be accessed instantly;
5. Support for a range of different operations as a mobile station and as a full-fledged base station, allowing the user to enjoy HF DX as much as with a conventional fixed station;
6. A quantum leap in power output in a compact chassis, generating 200W even when working off a DC 13.8V supply (in the USA there are no limitations on the power output of mobile transceivers, so it is being described as a “power mobile”);
7. Internal automatic tuner for the 100W model to make it more versatile and expand the range of possible applications; and
8. Remote control via the Internet.

As for the name of the new series, which was intended to reflect our planning objectives, we decided on the 400's in order to express continuity with the popular TS-450 workhorse transceiver. This was because the new product was not simply a compact transceiver but would offer the sort of performance and features Kenwood fans would expect of a 400-series model. A workhorse transceiver that could prove its worth in a variety of places – in the shack, in a vehicle, in the field – this was the TS-480 Series being planned by Kenwood.

Development Objectives for the TS-480 Series

The following is an explanation of our development objectives, distinct from the planning objectives.

If asked about the origins of the compact HF rig, people outside Japan would no doubt think of the Atlas Series. Following the Atlas, a variety of different products appeared on the market, but it is probably no exaggeration to say that Kenwood's TS-50 was the first in the category of the 100W (HF) compact all-mode transceiver. It is already more than a decade since the TS-50 was launched. Since then, successive models have grown increasingly smaller while adding new features and expanding band coverage to include V/UHF. Today, this category has matured to the point of actually forming a definable market. What we developed in order to stir up and add fresh stimulus to this market was the TS-480 Series.

- Why a compact 200W transceiver?
- Why a 100W model with a built-in antenna tuner?
- Why HF~50MHz coverage?

The answers to these questions can be found in our planning objectives. Let's look at the technical background.

The TS-480 concept began with development of the TS-570?

We first started looking in detail at the technical feasibility not of the 200W model but of the model with the internal antenna tuner. Today, there is nothing special about a built-in AT, but for the TS-570 we developed a relay-type AT. This replaced the previous motor-driven variable capacitor type of AT. Naturally this technology was used elsewhere and by other manufacturers, but if applied not to TX but to RX also, it is possible to use it for receiver front-end passive tuning. For transmission purposes, it is smaller than the conventional type of AT of the time, especially with regard to height, making it a good choice for building into a compact set.

In 1996, when on a visit to the US to promote the TS-570 a local salesman asked whether we were next going to put an AT into the TS-50. Well, perhaps that was where the TS-480 got its start!

Achieving 200W output in a compact transceiver

In achieving our goal of 200W there was one major constraint – namely, we could not raise the voltage of the power supply. The TS-480 Series was to be sold not only in Japan but internationally. If we had been looking only at our domestic market, things would have been different since the output of mobile transceivers here is limited to 50W, but conditions are different abroad, especially in the US. In the US, since there are no limitations on the output of either mobile or fixed stations, mobile transceivers in the several hundred watt class are not unusual. A common pattern for operations is not to hook up a 100W unit to a linear amp and mount a 200W fixed transceiver in a car. Moreover, the most common type of vehicle is a pickup with a 12V battery, so people expect to obtain a 200W output with a regular 13.8V power supply.

If one thinks of the way people operate such transceivers here in Japan, a question arises: Why add that much power if it cannot be used as a mobile rig? The TS-480 has been designed with a priority on operating ease. One reason for this is that we saw the TS-480 being used as a fixed station in Japan, where 200W mobile operations are not permitted. Most 200W HF transceivers are high-end and their price reflects this. But in the workhorse class, most models offer only 100W output. So we can say that our new product can fulfill the wishes of those who have received an advanced permit and thus want a 200W rig – as long as it is not expensive.

Focusing on HF

Raising power output and adding an antenna tuner are both moves in the right direction, but limiting the transceiver to the HF bands when the mainstream nowadays is HF~V/UHF would seem to be going against the tide of the times. Yet opting for the multi-band route inevitably leads to larger dimensions and higher prices. In this genre, price is an important factor, so by limiting the TS-480 to HF, we developed what is in fact a compact transceiver that stands apart from the competition. The TS-480 is designed to ensure not only excellent TX performance but also superior RX performance.

■ Circuitry

Downloaded by
RadioAmateur.EU

● TX circuits

200W final section

Explained here is the circuitry for the 200W final section, the crown jewel of the TS-480 Series.

This circuit is responsible for developing 200W output with a DC 13.8V power supply. Of course, various approaches are possible. The typical one would be to use a high voltage (28V or more) with the FETs in a push-pull arrangement. However, we did not adopt this approach since a DC-DC combination that raises the voltage to 28V exclusively for this purpose was considered inappropriate for a compact rig. The final section of a regular transceiver delivers 100W from 13.8V, so the normal approach would be to use this as the basis for a 200W design. Hence, we considered the pros and cons of using 4 final devices, each with 50W output, to produce a total of 200W.

I will not go into details here, but following our calculations and tests we discovered that simply hooking up the devices in parallel would not be a practical solution because of issues related to the output transformer. The solution we finally adopted was to have a pair of 100W final sections with a standard push-pull arrangement, combining these to obtain an output of 200W. Since this is the most popular method, we should perhaps have adopted it from the start, but having no past experience with a transceiver producing 200W from a 13.8V supply, we looked at the design issues from various angles including performance, quality, size, cost, and manufacturability.

When one simply says “combine”, there are in fact different ways to do this. For example, you can take a pair of 100W final circuits and connect in series the secondary circuit of the output transformer in phase to double the output, thus producing 200W. When we actually experimented with this, we found that it worked okay. Frequency characteristics were good. However, using this method means that one cannot provide isolation between the amplifiers. So what we finally adopted was the old standby in situations like this – namely, a wideband hybrid combiner.

The circuit for this combiner is straightforward: if you reverse the input and output it will actually work as a splitter. For the TS-480HX, we put together a 200W output final circuit by using this type of combiner on the input/output of a pair of 100W final amplifiers. For the 50MHz band, we have limited the output to 100W because of the heat that we knew would be generated from loss.

A hybrid combiner only works on the condition that the two signals are identical in amplitude and phase. Since our final section was to operate in the HF~50MHz bands, it would qualify as wideband in terms of frequency but there would be some concern for the balance frequency characteristics. However, this sort of power combiner has been used before for general applications, so in that sense it is an approach that can be adopted with some confidence.

When it came to the actual design (mounting), an ideal, symmetrical layout of the components was not possible; however, care was taken to preserve the balance, for example by employing isometric wiring for patterns in which there are many high-frequency currents flowing.

The device used was the 2SC2782 bipolar transistor. Since this has a collector loss of 220W, there would be a total loss of 880W in a 200W set equipped with four of them; this represents more than enough leeway for operations.

Continuous transmission performance with such a compact design is explained in the section on the TS-480 structure.

Fig. 1 illustrates TX IM characteristics with 200W output at 14MHz, while the second graph (Fig. 2) charts high-frequency spurious emissions.

Fig. 1: TX IMD (output 200W)

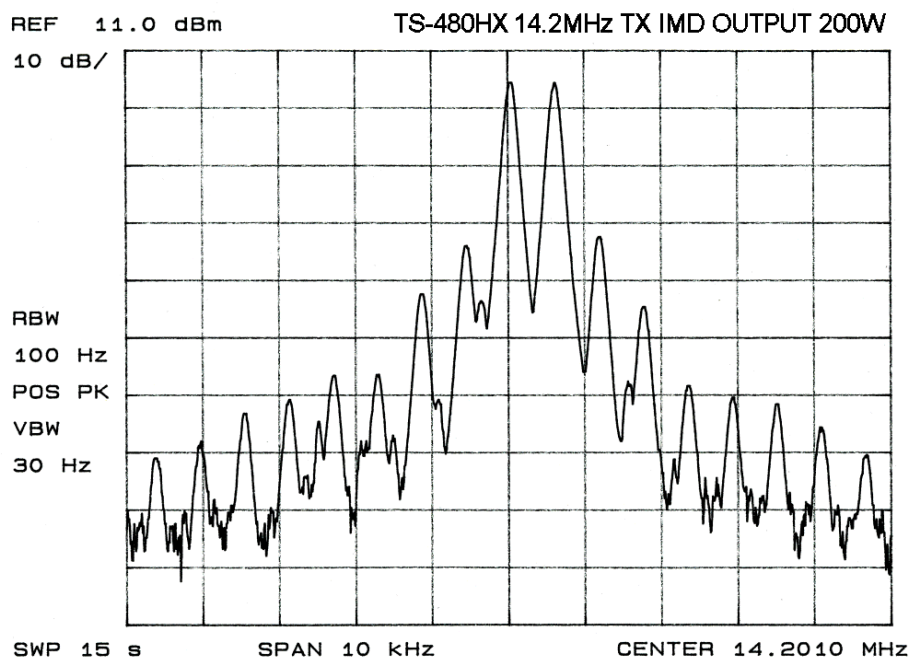
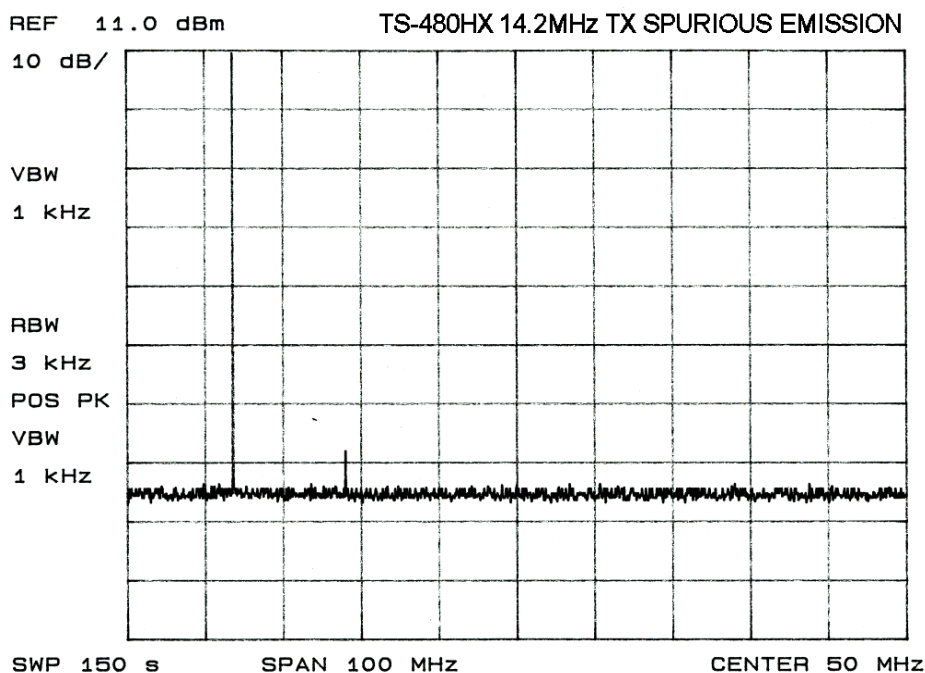

Fig. 2: TX Spurious emissions



SPS (separate power sources) [TS-480HX only]

SPS is shorthand for “operating at 200W using two 100W 13.8V power sources.” To generate a 200W output from 13.8V requires a maximum (total) current of 41A. As previously explained, the TS-480HX employs a pair of 100W final amps. What the SPS design does is to supply these amps from two separate power supplies, as shown in Fig. 3 below.

The use of two power supplies may appear inconvenient, but in actual fact this arrangement is quite practical. Many customers already possess a 100W class power supply, so when they acquire this 200W transceiver they do not have to make an additional purchase of a new 200W class power supply. It is possible for them to make use of the 100W unit in their possession.

The PS-53 power supply is specified for the TS-480; however, as long as it can produce 20.5A or more continuously at 13.8V, other power supplies can be used. Also, it is possible to operate this transceiver using a single power supply that can produce at least 41A continuously; note, however, that two power cables would still be needed.

Fig. 3: SPS schematic diagram

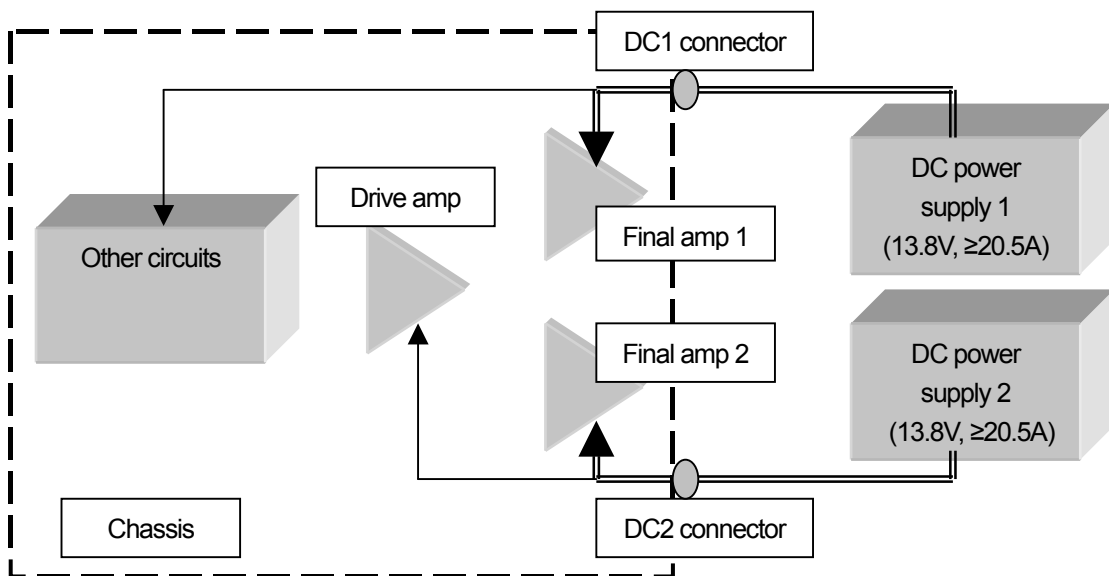

Failsafe device (some TS-480HX versions only)

The use of two power supplies and two final amps in parallel is something that has not been tried before, and naturally there may be some anxiety on the part of the user regarding what would happen if just one of the power supplies suddenly failed. Such a situation would be handled safely, since the TS-480 series is equipped with several failsafe devices.

- Should a difference of 1V or more be detected between the two power supplies: “RX ONLY” appears in the display and transmission operations are inhibited.
- Should the voltage of one power supply drop to zero: if the failed supply is DC1 (Fig. 3), the transceiver is powered down; if DC2 fails, “RX ONLY” appears in the display and only RX operations are possible.
- Should a final amp malfunction: if, for example, the output of one of the final amps fell, resulting in an imbalance, “PA-ERROR” appears in the display and transmission operations are terminated.

In addition, there is the usual complement of failsafe devices, including output control triggered by high temperature, high voltage detection, and SWR output control. These failsafe devices will provide temporary protection for the internal circuitry; however, should such a situation arise you should not continue using the transceiver, but rather deal with the problem in accordance with the troubleshooting guidelines.

100W final section

Like the 200W final section, the 100W final section uses 2SC2782 transistors. The drive and peripheral circuits are virtually identical to those in the 200W model, enabling 100W output for the HF~50MHz bands.

For the Japanese market, there are 50W and 10W (50MHz: 20W) models, allowing buyers to choose whichever best suits them – that is, their license and their intended use (mobile or fixed).

It should be pointed out that it is possible to increase the output of these models: the 50W model to 100W, and the 10W model to 50W or 100W. A TS-480 owner who acquires a more advanced license and wants to make use of this capability should go to the nearest service center. Note that it is not possible to upgrade to 200W output.

Also, 50W mobile transceiver warranty certification is available for both 200W and 100W models used as fixed stations.

Ever since the TS-570, Kenwood has adopted a method of converting transceivers to higher output specifications that does not require a kit. Conversion cannot be performed by the individual user, but because this method does not depend on finding stock of the appropriate kit it is proving popular.

Antenna tuner (TS-480SAT)

The 100W model is equipped with the relay-driven antenna tuner that was developed for the TS-570. Since there is no variable capacitor, gears or other rotating parts, this antenna tuner is very responsive and trouble-free. Thanks also to the several preset memories supplied for each band, you can instantly call up settings when moving up or down a band.

You can see the 200W and 100W final sections in Figs. 4 and 5, respectively.

Fig. 4: 200W final section



Fig. 5: 100W final section with antenna tuner



FM circuit

There were two approaches used for the FM circuit of the conventional all-mode transceiver. Either there was a dedicated modulation circuit using a 10.695MHz crystal, or the modulation was performed by the VCO on the 2nd OSC. The latter was not an option for the TS-480, and since the whole transceiver had to be compact, we did not adopt the former approach. How then is FM handled by the TS-480?

What we have employed for the TS-480 is something that is rarely seen these days in ham radios: the reactance modulation approach, which does not have the modulation applied directly to the oscillating circuit. This type of circuit was widely used in the days when a crystal was used to change channels in FM car transceivers, but it dropped from sight when PLL became the norm. It is not a new circuit, but it has excellent characteristics. In the TS-480, this reactance modulation circuit is connected to the output of the DDS, which serves as the source for the PLL reference frequency, so effectively it is modulating the 1st OSC.

This approach offers several advantages:

- Since frequency modulation is not conducted in the TX signal circuitry, even if the TX RF signal is passed through a roofing filter, it will not suffer from any delay distortion caused by the filter;
- Since there is no need for an oscillator to perform modulation, “one-shot” frequency management is permitted when transmitting on FM with the same precision as SSB;
- This approach saves on space and cost.

Fig. 6: FM modulation block diagram

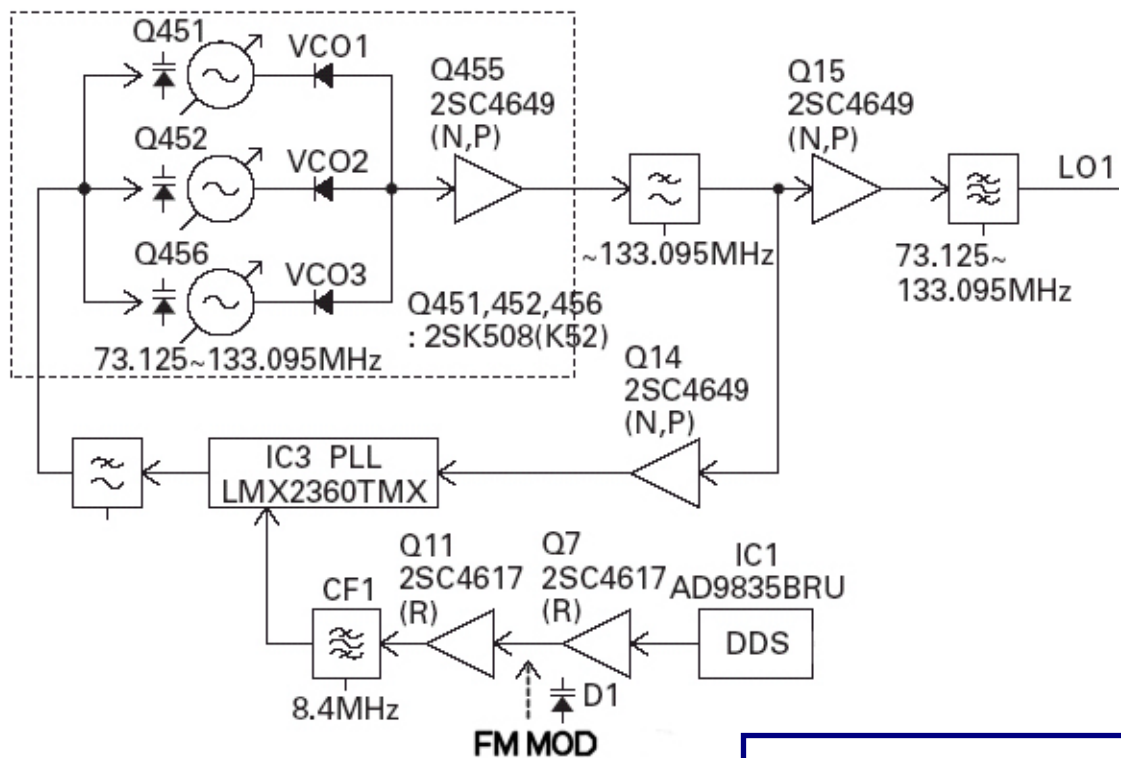

Downloaded by RadioAmateur.EU

● RX circuitry

Front end

As explained in the section on development objectives, what distinguishes the TS-480 Series are incomparable features and performance that result from our focus on HF. Of special note are the dynamic range characteristics in the HF bands, demonstrating the fact that, despite the compact dimensions of this transceiver, there has been no design compromise.

One of the circuits that is important in determining dynamic range is the first mixer. Now there are some compact transceivers covering HF~V/UHF that are designed to cover all frequency bands with a single mixer. Since HF~50MHz is the “home turf” for the TS-480 Series, it has an advantage as in regards to the operating conditions for the mixer. Since developing the TS-950, Kenwood has exclusively employed J-FET quad mixers, and the TS-480 is no exception. Fig.7 illustrates the mixer circuit.

Fig. 7: RX 1st mixer

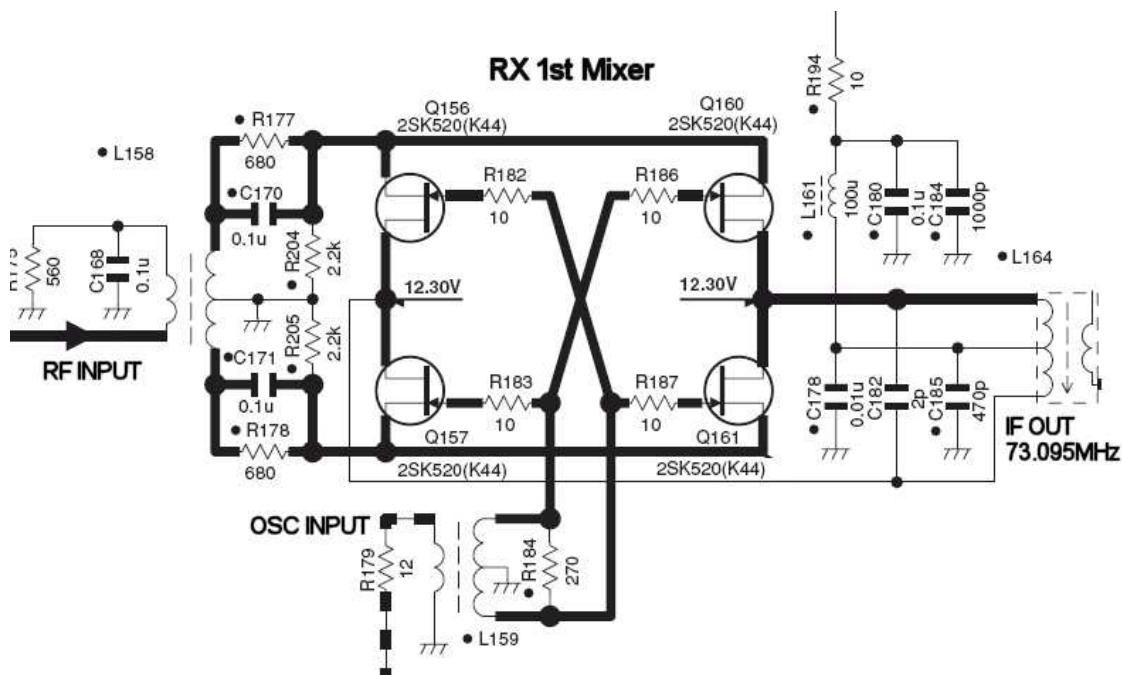

How well does it actually perform? Fig. 8 is a graph illustrating the dynamic range characteristics when changing the separation of two interfering signals. For the sake of reference, results for the TS-480 are plotted against those obtained using other compact mobile transceivers (on the market) under the same conditions.

Fig. 8: RX dynamic range

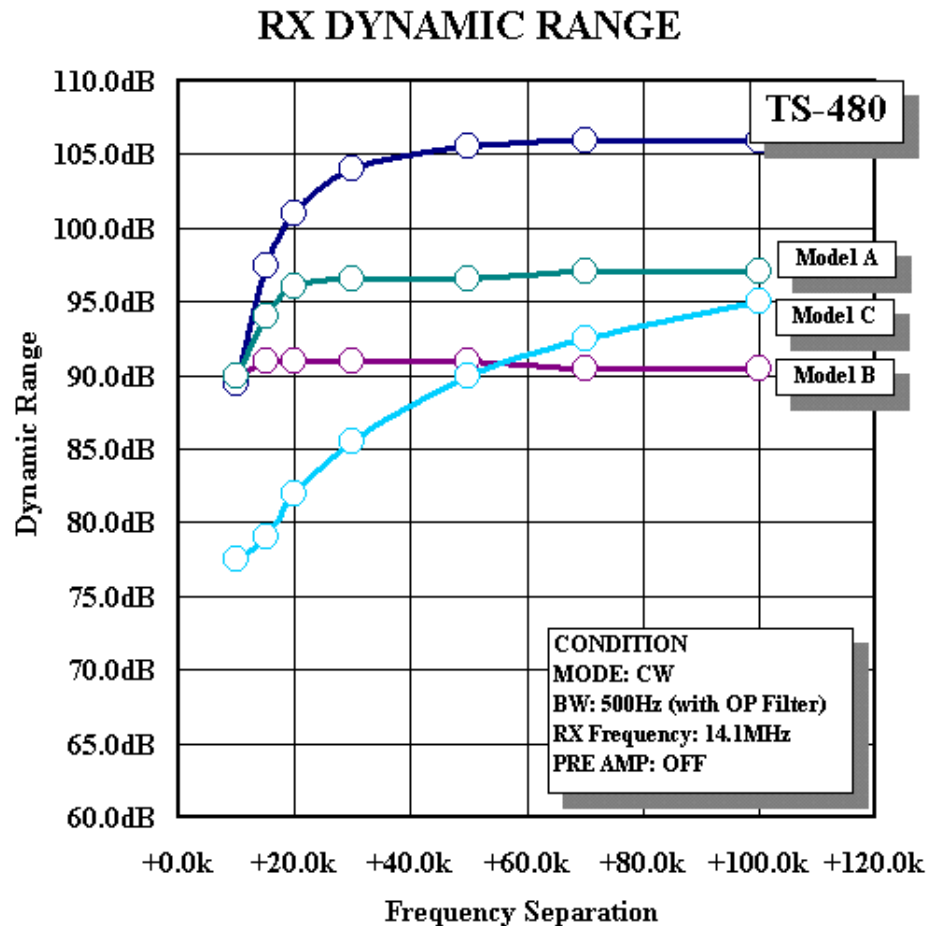

Looking at Fig. 8, results higher up the graph indicate wider dynamic range.

When the RX frequency is 14.100MHz, and for example there is simultaneous interference from two signals at 14.150MHz and 14.200MHz, with the nonlinearity of the RX section, spurious signals are generated at 14.100MHz and 14.250MHz, enabling reception. Since the frequency separation at this point is 14.200MHz - 14.150MHz = 50kHz, the +50.0kHz point on the horizontal axis of Fig. 8 corresponds to these conditions. Under these conditions, if there were interfering signals that were faintly picked up by the other transceivers in this comparison, the strength of those interfering signals would have to rise by 10~15dB for the TS-480 to begin suffering the same effects.

When there is interference in close proximity to the RX frequency, there is no difference between these models, with one notable exception. In this area we are approaching the bandwidth of the roofing filter, so to put it another way, the fact that we can observe a difference between the transceivers at the +50kHz point – where the interference is sufficiently eliminated by the roofing

filter – reflects a difference in the manufacturers’ approach to design from the antenna to the 1st mixer.

It is not just the mixer that determines the characteristics of the front end: all of the components between the antenna terminal and the mixer can have an impact.

Despite the compact design of the TS-480 Series, its RX BPF divides up the 500kHz~60MHz range into 10 bandwidths. Since several coils are employed in this BPF circuit, small coils have to be used in a compact transceiver. When discussing front end linearity, attention focuses on semiconductors such as the PIN diode for switching bands, but in fact the coils used in this BPF can be “nonlinear” parts, depending on operating conditions. Differences in their characteristics become more noticeable the smaller they are. In the early stages of developing the TS-480, we looked at the mutual modulation characteristics of a number of coils, picking only those that demonstrated the best performance.

With this compact transceiver it was not possible to use a passive tuner equivalent to what is found in top-end models, but our emphasis on HF performance was such that we selected components whose advantage cannot even be appreciated from a circuit diagram.

Fig. 9 is a graph demonstrating RX sensitivity. Needless to say, for HF, especially in the low bands, there is more importance attached to multi-signal characteristics than to sensitivity, but obtaining a sufficient level of sensitivity can be vital during mobile operations when one cannot expect much in the way of antenna gain.

As with previous models, sensitivity is set to switch at 21.5MHz with the pre-amp on. However, there is a difference: previously the pre-amp itself was switched, but in the case of the TS-480 this is managed by switching the pre-amp’s NFB gain.

Fig. 9: RX sensitivity

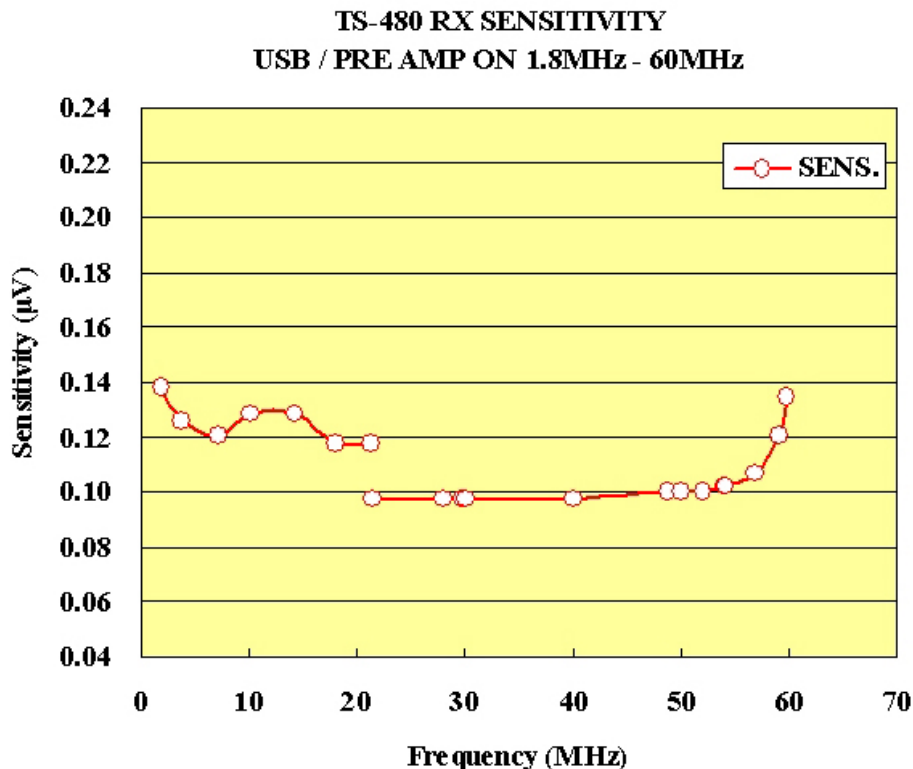

◀ Jumpers for joy ▶

As with the TS-2000, something special has been provided for both the BPF ATT in the BC band and the regular ATT:

- The BPF has been equipped with an ATT in order to cope with powerful local broadcasting stations in the BC band. However, a jumper can be used to switch from NORM to DX, bypassing this ATT and raising sensitivity by about 20dB.
- The ATT accessible from the control panel defaults to 12dB, but by removing the CN4 jumper it is possible to increase this to about 20dB.

Fig. 10: Jumper locations

RF unit (X44-3270-00) component surface (J72-0874-19)

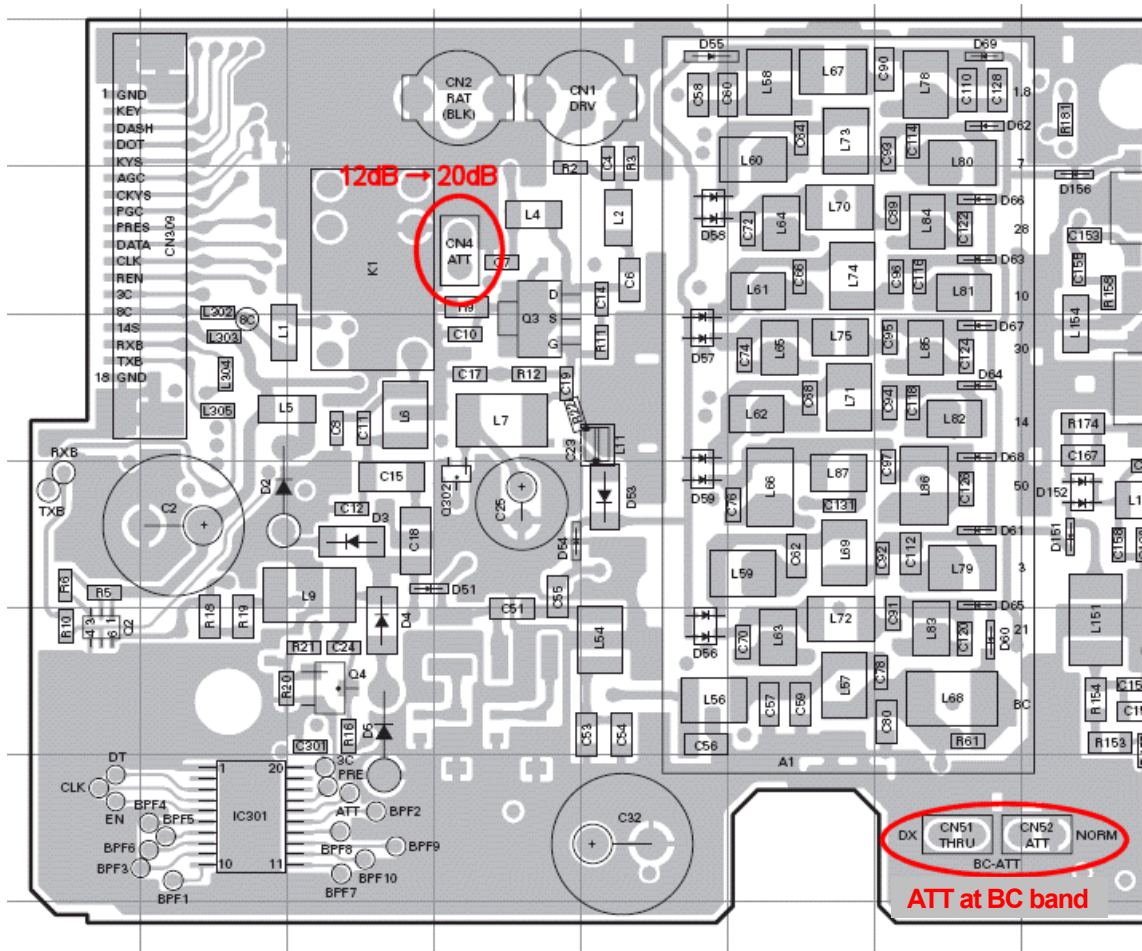

Circuitry after the roofing filter

Except for FM, the TS-480 has a double super: 1st IF is 73.095MHz and the 2nd IF is 10.695MHz. For FM, there is also a triple super as low as 455kHz. This is followed by analog detection and signal processing performed by the AF DSP in a standard arrangement. The AF DSP is not optional: it is equipped as standard. DSP features and characteristics are explained in the DSP section.

Three newly developed optional filters are available for the 2nd IF. Previously, there was only one 10.695MHz optional filter: the YK-107C (500Hz). This filter was developed at the same time as the TS-790, and since the focus was on its use for V/UHF, there may have been times when users felt it was lacking when it came to HF operations. So when we were developing the TS-480, we redesigned the 500Hz filter, greatly improving its shape factor. We also used the opportunity to design new 270Hz and 1.8kHz (SSB narrow) filters.

Fig. 11 graphically illustrates the difference between these filters in the 500Hz band.

Fig. 11: Comparison of optional CW filters (500Hz)

Downloaded by
RadioAmateur.EU

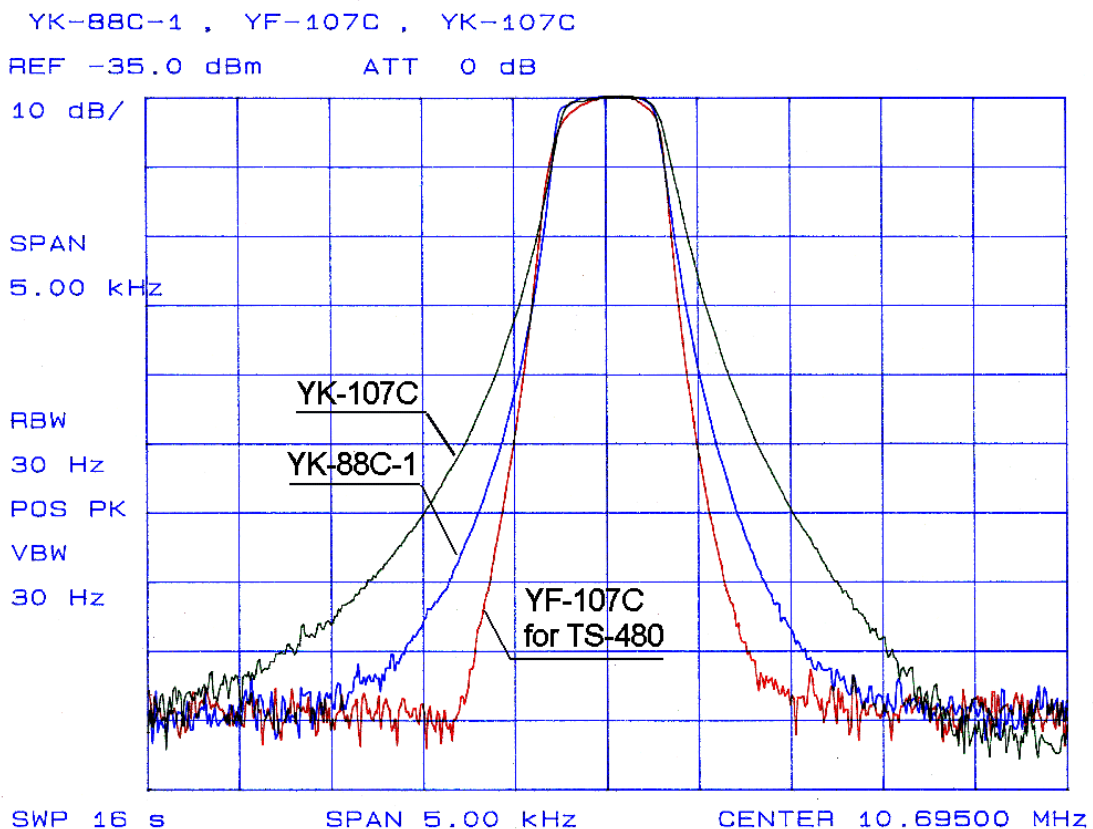

Whereas the TS-570 provided only a single slot for installing an optional filter, the TS-480 has two slots, meaning that two of the three filters can be installed at the same time. And the process of installation itself is quite easy: there is no need to remove the main unit, since the option installation unit has been designed to be separately removable.

The photograph in Fig. 12 shows the option installation unit. This can be used to install not only these IF filters but also a high-stability TCXO SO-3 ($\pm 0.5\text{ppm}$, $-10\sim+50^{\circ}\text{C}$), which is optionally available.

Fig. 12: Option installation unit

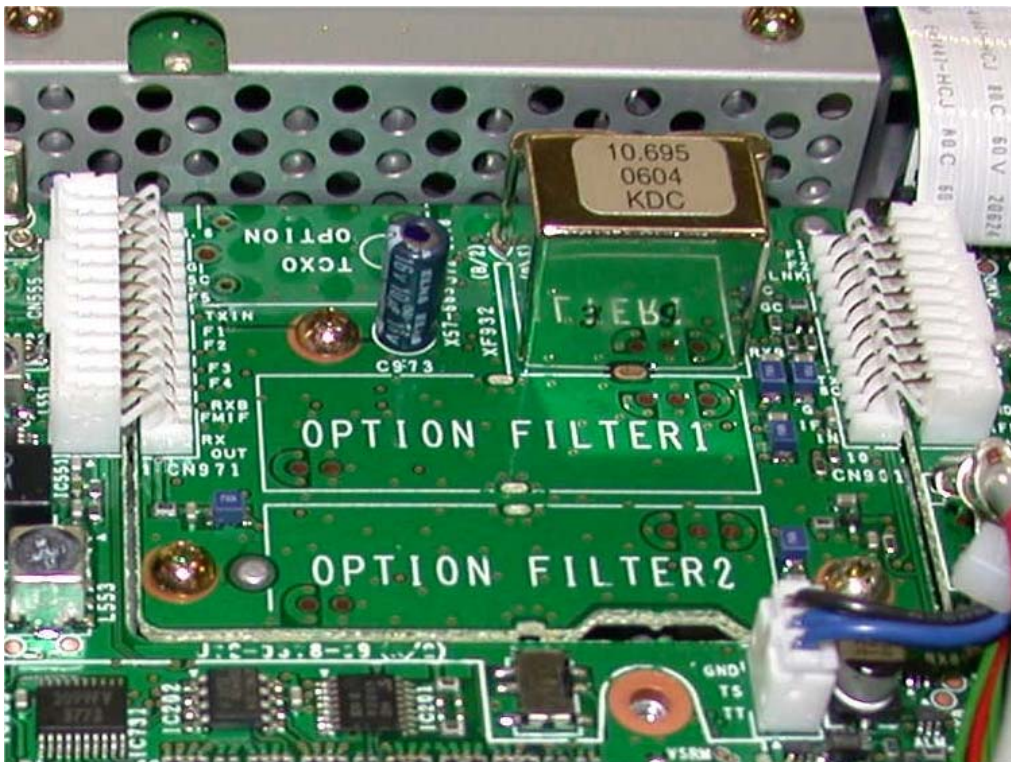

If you unclip the white connectors on either side and remove the screws that hold the board in place, you can independently remove the unit for installing the optional filters.

Since the type of filter is recognized automatically, it does not matter in which order you install filters in the slots.

■ Auxiliary Features

In addition to the basic TX/RX circuitry already described, the TS-480 is equipped with a number of auxiliary features of considerable practical benefit. What follows is an introduction to some of these.

● Full compatibility with digital modes (data modes)

PSK31 and RTTY operations can now be performed with ease using PC software. The TS-480 has been designed to make it easy to use such digital modes.

- External audio input/output terminals, separate from the mic and speaker terminals, are provided. For each of these the level can be adjusted in ten steps.
- You can select special AF DSP filters for use with digital modes. Specially provided for PSK31 use is the choice of either a 1000Hz or 1500Hz beat frequency.
- With the optional CW filters installed, you can choose between them even during SSB reception, which we have had many requests for.
- It is possible to switch the VOX function so that it will respond either to mic input or to an external audio signal. No special standby wiring is needed for making digital use of this VOX function.
- When transmitting voice with PTT, external input signals are muted. Conversely, when transmitting using an external input, the mic input is muted; thanks to this feature, there is no need to disconnect the mic during digital mode operations. (Note that if you put an external input on standby using the mic PTT, it will not be modulated; sometimes users have queried as a possible fault, but it is not.)

● Features useful for 50MHz operations

- You discover a DX CW signal during a USB band search! The TS-480 has a feature that is perfect for such times: you can automatically switch to CW transmission by just keying the transmitter (key down) with your CW key, keyer or CW computer program.
- When scanning 50.110~50.150 with the SSB program scan, if you want to watch carefully at 10kHz intervals just use a slower scan speed. This is also possible with memory scan, but in that case you cannot hear frequencies in between. This allows you to set the scan speed slower by up to 5 points for selected frequencies.
- The noise blanker, which has a reputation for being very effective in combating even weak noise, is now even better: we have added the ability to adjust the threshold level.

● Features useful for mobile operations

- The TS-480 is equipped with a newly developed DNL (digital noise limiter). Although the principle and operation of this DNL is quite different, the effect is somewhat like the old ANL (audio noise limiter). Pulse noise is handled by a standard noise blanker, but if you find this is not working very well as a result of a strong signal overlap or because of different types of noise, you should give the DNL a try. In some cases, by processing audio signals with the DSP one can effectively eliminate pulse noise. For details, see the DSP section.

- TX tuning is a handy feature to have. It outputs a low-power continuous carrier for adjusting a screw-drive or similar antenna. It allows you to transmit a continuous carrier that is independent of the mode and power of your current operations. Simply assign a PF key to this function.
- No paddle, but you want to give CW a try? No problem. With mic paddle mode, you can use the up/down keys on your microphone as a simple paddle.

● **New 5MHz band**

US versions are compatible with the new 5MHz band; this also goes for the antenna tuner.

Features of the Built-in DSP

● DSP circuit



The digital signal processor equipped on the TS-480 is the 16-bit fixed-point TMS320VC5402 from Texas Instruments, which offers excellent value for the money. Running at 100MHz, it provides double-precision arithmetic operations (equivalent to 32-bit processing), making it more than capable of serving as an AF DSP. Thanks to this, the TS-480 offers many powerful features of use in HF operations.

● Ideal for mobile operations: DNL

NEW

When you hear the crackling of ignition and other types of pulse noise, it is possible to remove it using the noise blanker (NB); however, this does not work in all cases. Depending on the type of noise, or if there is a very strong signal close by, the pulse noise may remain and be demodulated. This can result in an unpleasant sound being emitted from the speaker, thus reducing the clarity of your target signal. In such cases, the DNL (digital noise limiter) can reduce pulse noise that has been demodulated at the AF stage, effectively extracting your target audio signal.

Fig.13 is a block diagram illustrating in principle how the DNL operates.

Fig. 13: Principle of DNL operation

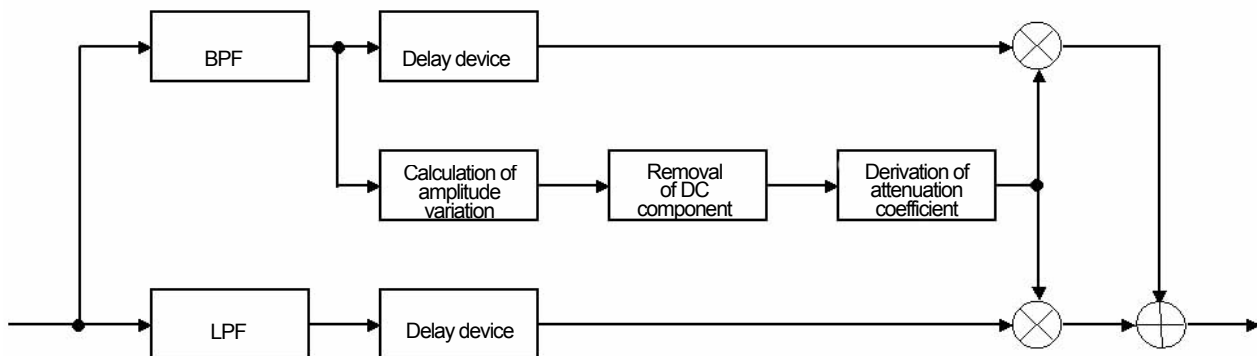

First, the input signal is divided into its low- and high-frequency components. Ignition and other pulse noise tends to be concentrated in the latter, from which amplitude variation is output. The attenuation coefficient derived from this signal is multiplied by the input signal. As soon as pulse noise occurs, the attenuation coefficient rises instantaneously, thus damping the amplitude variation in the input signal. Because of this adaptive processing performed by the DNL and based on the amplitude variation, the output signal has virtually none of the “digital feel” that is often the mark of digital signal processing. It is perhaps only natural to associate this DNL with the old “noise limiter” technology, but as explained it works on a completely different principle, performing the sort of advanced processing that is only possible with DSP.

Because the TS-480 will be often used for mobile operations, DNL parameters have been tuned so as to have maximum effect on ignition noise. However, even when used as a fixed station, it can be very effective on irregular, unanticipated noise, so we recommend that you try making use of it, in combination with the noise blanker as well.

Fig.14 demonstrates how ignition noise is reduced by the DNL.

Fig. 14: The effect of DNL on ignition noise

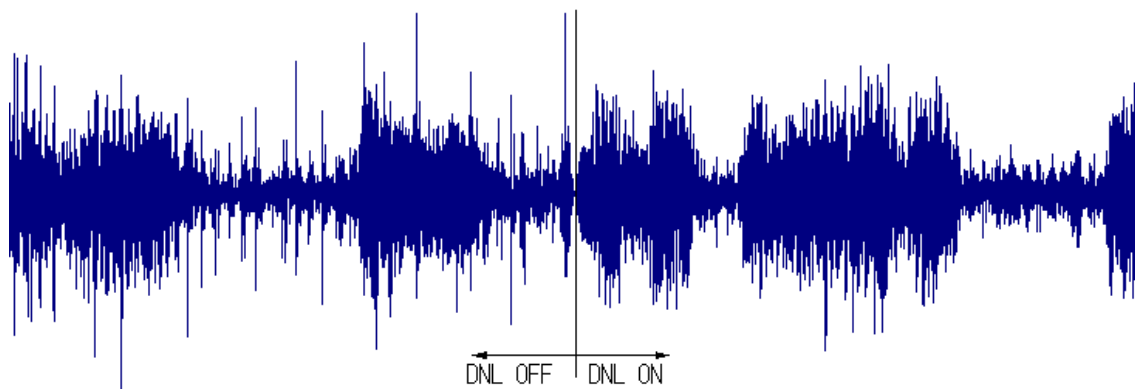

The DNL works in SSB, CW, FSK and AM modes, and it can be used in conjunction with other interference reduction and noise elimination features.

● Noise reduction

There are two methods available for noise reduction: NR1 and NR2. NR1 is a line enhancer that employs adaptive filter technology. By shaping a filter that lets through signals with a certain amount of periodicity, as with voice and CW, it can suppress noise that falls outside the passband. NR2 employs what is known as SPAC (speech processing by auto correlation) technology. What results from looping one cycle of the RX signal's autocorrelation coefficient is then output as the received audio. What this means is that only periodic signals found in the received audio emerge. In principle this approach can result in a small amount of noise at the “seam” where the periodic signal is looped together, but in practice it proves extremely effective at noise compression.

NR1 is a good choice for SSB and other audio signals, while NR2 is especially effective when used with single frequencies, as with a CW signal.

Figs. 15~17 demonstrate the effect of applying NR1 and NR2. For comparison purposes, the same weak sine signal was received, with the audio output monitored by an FFT analyzer.

Fig. 15: NR OFF

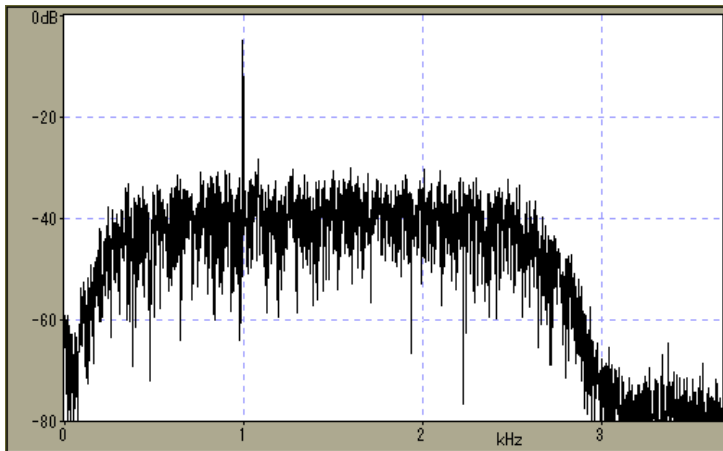

Fig. 16: NR1 ON

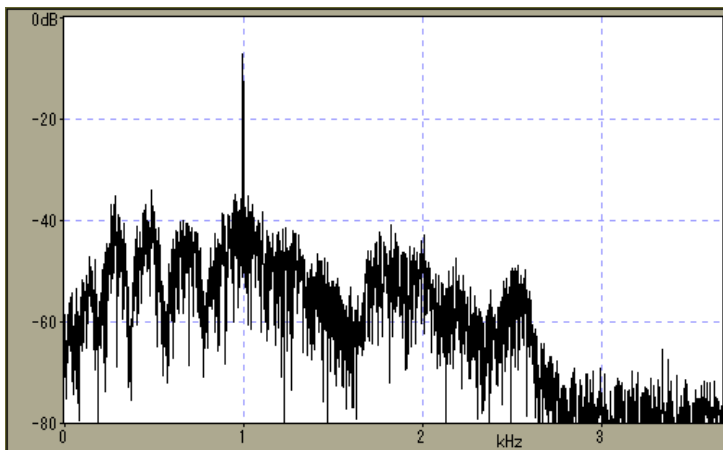
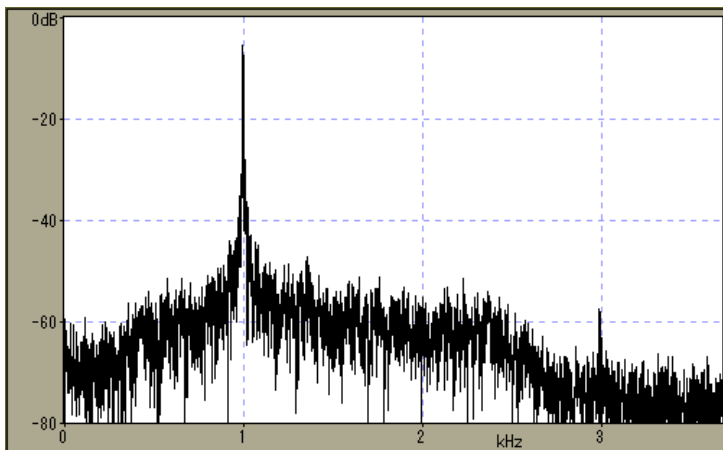

Fig. 17: NR2 ON



● Beat cancel

Beat cancel (BC), as its name implies, is designed to cancel unpleasant beat interference. Like NR1, it uses adaptive filter technology, tracking a beat and canceling it by shaping. It is very similar to a band elimination filter. Even if there are multiple beats, BC can track and cancel them all. However, since BC operates at the AF stage, should powerful beat interference be experienced during DX operations, even though beat cancel works properly, by then the AGC has already attenuated both the interference and the target signal. To combat this sort of beat, IF shift is used to eliminate the interference.

Figs. 18 and 19 show how BC cancels beat signals, as monitored by an FFT analyzer. You can see how the three beats present in the signal are removed with almost surgical precision.

Fig. 18: BC OFF

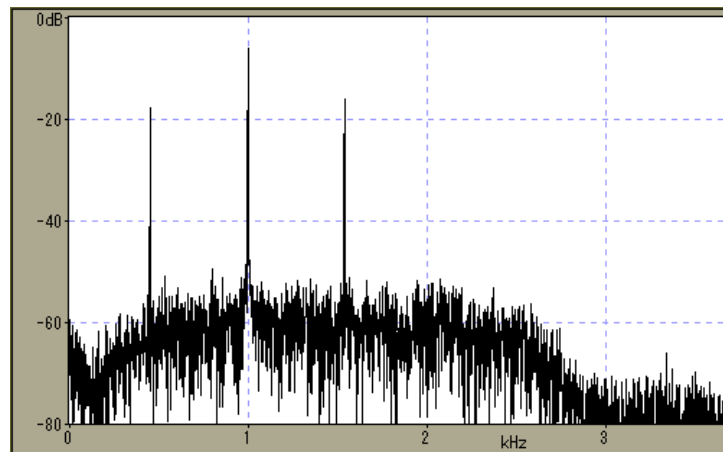
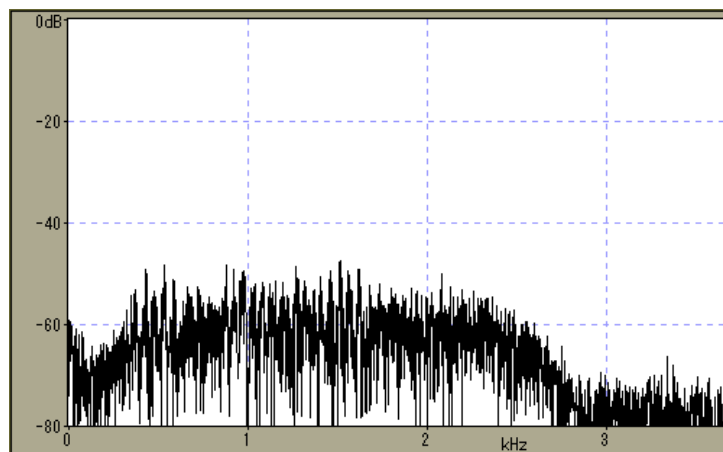

Fig. 19: BC ON



There are two methods available for beat cancellation: BC1 and BC2. These have been tuned so that BC1 is effective against weak or continuous beat interference, while BC2 cancels intermittent beat such as a CW Morse signal. (Note that since BC is designed to remove the beat, and does not function in CW mode.)

● **RX DSP filters**

In SSB, AM and FM modes, you can independently set high- and low-cut frequencies for the AF filters to suit operating conditions (slope tune).

Fig. 20 illustrates how slope tune works. When there are interfering signals in proximity to the target signal, you can use a high-cut filter and a low-cut filter to remove the signals above and below the target.

In SSB mode, installing the optional SSB narrow filter results in even better interference reduction. In AM mode if you select NAR, RX is possible using this SSB IF filter.

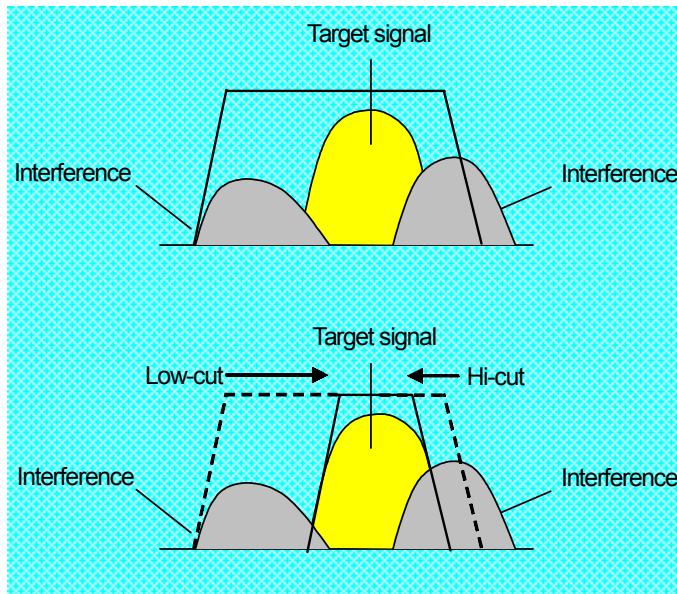

Fig. 20: Slope tune in action

Listed below are the cutoff frequencies (unit: Hz) that can be chosen; default values are shown in bold.

SSB/FM	
Low-cut	0 50 100 200 300 400 500 600 700 800 900 1000 <input type="text"/> <input type="text"/>
Hi-cut	1000 1200 1400 1600 1800 2000 2200 2400 2600 2800 3000 3400 4000 5000

AM	
Low-cut	0 100 200 500
Hi-cut	2500 3000 4000 5000

In CW and FSK modes, the AF filters function as a VBT, changing bandwidth without altering the center frequency. In CW mode, the center frequency is coupled to the CW pitch, whereas in FSK mode it is determined by the FSK tone and FSK shift frequencies.

Fig. 21 shows how it is possible during CW operations to extract a target signal from surrounding interference by changing the AF filter bandwidth (WIDTH).

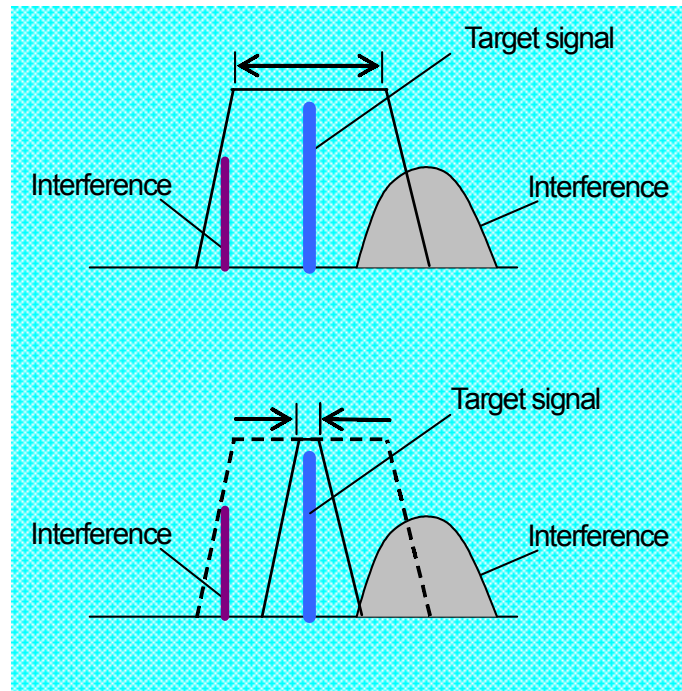

Fig. 21: Switching WIDTH during CW operations

Listed below are the filter bandwidths (unit: Hz) that can be chosen; default values are shown in bold.

CW										
WIDTH	50	80	100	200	300	400	500	600	1000	2000

FSK				
WIDTH	250	500	1000	1500

When the optional CW filters are installed, the TS-480 will automatically select the optimum IF filter in accordance with the DSP filter bandwidth.

Also available are filters for PSK31 and RTTY data mode operations. From the menu, if you select ON for the "Available data communications filters", these data communications filters can be used in SSB mode. You can choose from 3 center frequencies and 7 WIDTH settings.

Listed below are the filter types (unit: Hz) that can be chosen; default values are shown in bold.

For data communications							
Center	1000	1500	2210				
WIDTH	50	100	250	500	1000	1500	2400

During PSK31 operations, the center frequency is set to either 1000Hz or 1500Hz.

Furthermore, since it is now possible to select an optional CW IF filter in SSB mode, it is possible to narrow the bandwidth.

● RX equalizer & TX equalizer

If you use the RX equalizer it is easy to adjust RX audio quality. Take your pick from flat (default), high boost, Formant pass, bass boost, and conventional settings. As a new feature, the TS-480 actually offers two types of high boost and two types of bass boost.

TX audio quality can similarly be adjusted with the TX equalizer. It is easy to make any changes to suit your taste: for example, mic characteristics can be corrected, and you can apply compensation to match the characteristics of your own voice. For TX there are now two types of high boost and two types of bass boost, so why not give them a try?

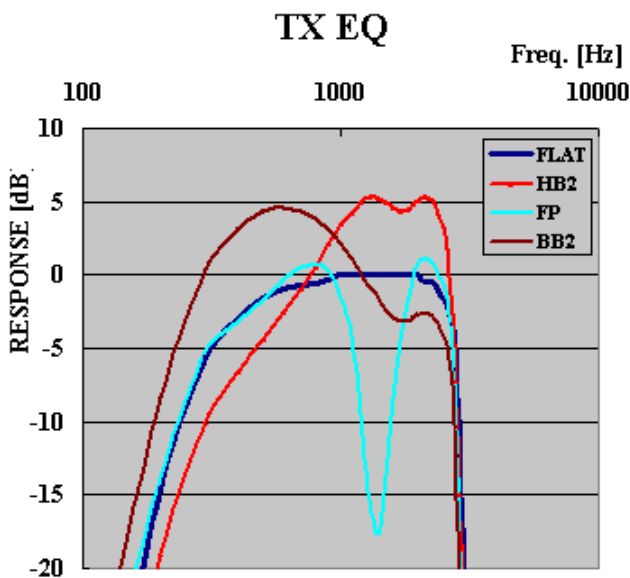

The graph in Fig. 22 plots overall frequency characteristics from mic input to antenna output, illustrating the effect of some of these equalizer settings.

Fig. 22: TX equalizer characteristics (example)

If you use the Audio Editor function (ARCP-480), available free for downloading, the options for equalizing expand even more. In addition to a total of 35 types of equalizing samples, it offers tools for freely adjusting such parameters as filter type, cutoff frequency and amount of attenuation. The settings made with the ARCP-480 software can be applied by selecting U (user) from any of the TS-480's equalizer menus.

While it is true that neither the built-in equalizers nor the audio editor software provide the same degree of freedom as the graphic equalizers found in audio entertainment equipment, they are useful as a means for tailoring audio quality to suit.

● CW auto tune

A useful feature for tuning in to another station is CW auto tune. There is more than one method for zeroing in on a target frequency – such as matching RX beat with sidetone pitch, or getting the pitch frequencies that can be heard when CW reverse is ON and OFF to be the same – but it is very easy if you engage CW auto tune when you can hear the other station. It just takes the press of a button to make the VFO automatically zero in on the target. Note, however, that there are various limitations associated with this feature – for example, the tuning range is 300Hz on either side of the pitch frequency, and it can be confused by interference – so you should learn how to make good use of it.

■ Tips

As with other Kenwood HF transceivers, the TS-480 provides menu access to its many features. By selecting and adjusting these features, you can customize the TS-480 so that it fits perfectly into your way of operating a radio. Introduced here are tips on how to get the most out of the various items listed in the menus.

● TS-480 menus

Group	#	Function	Use
Operator interface	00	Brightness of display backlighting (5 levels, including OFF)	You can adjust brightness to suit the ambient lighting level. Turning backlighting off reduces power consumption by about 30mA.
	01	Key illumination ON/OFF	Turning illumination off reduces power consumption by about 30mA.
Tuning	02	Auto mode	Mode can be changed automatically depending on frequency. This is more convenient than setting VFO A to CW and VFO B to USB.
	03	Tuning control adjustment rate	By reducing the adjustment rate, you can make it easier to tune.
	04	Frequency step for the main encoder in FM mode	You can change frequency with the main encoder in the same way that you can change channels.
	05	Frequency rounding for the MULTI control	With this switched OFF, if you accidentally change frequency with the MULTI control, you can return to the original frequency.
	06	Frequency step size for BC band	When ON, frequency step size is 9kHz. When OFF, step size is determined by the STEP value. The factory setting for US models is OFF; for other markets ON is the default.
Memory channels	07	Temporarily change memory frequency	Switch ON to operate a frequency in memory without transferring it to a VFO.
Scan functions	08	Program slow scan	Useful for 50MHz scanning.
	09	Program slow scan setting	You can choose how much to slow the scan.
	10	Program scan hold	You can pause the scan for 5 seconds, a handy way to avoid missing a signal.
	11	Scan resume method	You can switch between time-operated and carrier-operated scan resume to suit your purpose.

Volume adjustment	12	Beep output level	You can adjust this to suit your preference.
	13	Sidetone volume	For full break-in, it is easier to hear the sidetone if you raise this volume.
	14	VGS-1 message playback volume	You can check what has been recorded.
	15	VGS-1 announcement volume	Switch this OFF if you do not need announcements while working the radio.
	16	VGS-1 announcement speed	You can adjust this to suit your preference.
RX IF filters	17	Use CW IF filter for SSB reception	This is useful for PSK31 operations.
DSP equalizers	18	DSP RX equalizer	You can adjust frequency characteristics during reception. Select the position that best suits your external speaker/headphones.
	19	DSP TX equalizer	As with #18, this is not as versatile as a dedicated graphic equalizer, but it is useful for tailoring TX frequency characteristics to match your mic and voice.
DSP TX filters	20	DSP TX filter bandwidth	As this is AF DSP, it is not as versatile as IF DSP, but it can be used to remove low frequencies during transmit.
Fine-tuning TX output	21	TX power output control	You can choose between a 5W step and a 1W step. Useful for fine adjustment of output when using a linear amp.
TX control	22	Time-out timer	This automatically terminates transmission after a set time. Useful as a failsafe for network (KNS) operations.
Transverter	23	Frequency when using transverter	You can change the frequency displayed by the transceiver to the operating frequency of the Transverter. Unlike the TS-570, you can set any frequency.
	24	Output power adjustment for transverter	Transverter output is fixed at 5W for the TS-570, but with the TS-480 you can choose output freely (within the transmitter's capability).

Antenna tuner	25	TX hold when internal AT completes tuning	After completion of tuning, there is still approximately 10W of output, so this is useful if you want to go on to tune the linear amp.
	26	In-line AT while receiving	The internal antenna tuner can also be used during RX. Depending on conditions, sensitivity can vary by enough to see a change in the S-meter. It can also reduce low-frequency interference.
	27	External AT control method	If you own an AT-300, you can connect it to the TS-480; however, operation is limited by the capabilities of the AT-300.
Linear amp	28	Linear amp control for HF band	You can control the linear amp independently for the HF and 50MHz bands. And if the amp is not compatible with full break-in, you can add in a delay for the TX attack.
	29	Linear amp control for 50MHz band	
Message playback	30	VGS-1 constant recording	With the VGS-1 Voice Guide and storage unit installed, you can engage constant record for the RX signal. Maximum playback time is 30 seconds.
	31	Repeat playback of voice/CW messages	This is not just for contest CQ machines; it can be used as a simple beacon.
	32	Interval time for #31	Interval time can be adjusted up to a maximum of 60 seconds.

CW	33	Keying priority over playback	Without switching off the repeat playback for messages, you can start keying.
	34	CW RX pitch / TX sidetone frequency	Select RX pitch frequency between 400Hz and 1000Hz. At the same time, sidetone frequency changes with the pitch frequency. This can be used to zero in on a target signal by matching the sidetone frequency with the RX beat.
	35	CW keying weight ratio	Change the dot/dash weight ratio. This is usually set to AUTO.
	36	Reverse CW keying auto weight ratio	You can change the AUTO setting for #35.
	37	Bug key function	Manual TX can be enabled for dashes only.
	38	Swap dot & dash paddle position	Swap the paddle position to suit either right-handed or left-handed use.
	39	Auto CW TX in SSB mode	Automatically switch mode to CW transmission by simply operating the paddle.
	40	Define CW tune frequency	Useful if used in combination with #39, as there is no need to operate the dial to zero in on a target.
FSK	41	FSK shift	Standard FSK operating parameters are covered by these menus.
	42	FSK keying polarity	
	43	FSK tone frequency	
FM	44	Mic gain for FM	You can adjust FM mic gain (3 levels)
Data communications	45	Filter bandwidth for data communications	This enables you to pick the appropriate DSP filter for data communications using the filter switch on the control panel.
	46	AF input level for data connector	Adjust input and output levels independently when the TS-480 is connected to a SoundBlaster™ card or other external device.
	47	AF output level for data connector	

PF keys	48	Assign PF keys on the control panel	You can assign functions to the PF keys on the control panel as detailed in the separate table.
	49	Mic PF1 key	You can assign functions to the PF keys on a multifunction mic as detailed in the separate table.
	50	Mic PF2 key	
	51	Mic PF3 key	
	52	Mic PF4 key	
Split frequency transfer	53	Split frequency transfer	Transfer modes/frequencies between compatible transceivers. Useful when one is being used as a slave receiver.
	54	Permit to write #54 to target VFOs	
TX inhibit	55	TX inhibit	Inhibits TX, which is useful if the transceiver is to be used for RX only as it prevents unintentional transmissions.
PC data rate	56	COM port communication speed	Select 4800~115200bps.
External devices	57	DTS polarity	In data communications this switches the logic for transmission. You should match polarity to the external device you are using.
TX inhibit	58	Busy lockout	You can select BSY lockout to inhibit transmission when busy.
APO	59	APO (auto power off) function	Power can be switched off automatically in the absence of any operations.
VOX source	60	Select input for VOX	Select either the mic or the data input for VOX activation. Standby wiring may not be required provided that the method used is compatible with data communications. (Be careful to ensure correct TX delay.)

● Functions that can be assigned to PF keys

#	Assigned function	Use
0~60	MENU #00~60	The selected menu item can be called up directly, making this useful for menu functions that you often use.
61	Voice1	In addition to the automatic Voice Guide, you can have frequency and other displayed data read out when you press a PF key.
62	Voice2	S-meter reading is read out when you press a PF key.
63	RX monitor	The squelch can be forced open for as long as the PF key is depressed. Useful for monitoring when setting CTCSS, etc.
64	RX DSP monitor	The TS-480 will receive using the widest passband available in that mode for as long as the PF key is depressed. This is a quick way to check on nearby interference.
65	Main encoder lock	You can lock the main encoder. This prevents unintentional operation of the encoder when the transceiver is being used in a vehicle.
66	SEND key	There is no SEND key on the control panel, but this role can be assigned to a PF key.
67	TX tuning	Irrespective of the current operating mode and power, this function allows you to transmit a continuous carrier at a fixed output. Useful for configuring external devices.
68	LSB/USB toggle	Toggle between LSB and USB when LSB (USB) is displayed.
69	CW/FSK toggle	Toggle between CW and FSK when CW (FSK) is displayed.
70	FM/AM toggle	Toggle between FM and AM when FM (AM) is displayed.

71	TF-SET	<p>You can assign a function you often use to a PF key on the mic. Also, a function defined by pressing the key for 1 second can be called up instantly. For example, if you find yourself frequently switching between antennas, you can save time if you assign a panel PF key to ANT 1/2.</p>
72	Q MR	
73	Q MI	
74	SPLIT	
75	A/B	
76	M/V	
77	A=B	
78	SCAN	
79	M > V	
80	M.IN	
81	CW TUNE	
82	CH1	
83	CH2	
84	CH3	
85	FINE	
86	CLR	
87	MTR	
88	MHz	
89	ANT 1/2	
90	NB	
91	NR	
92	BC	
93	DNL	
99	OFF	No function is assigned to the PF key.

Downloaded by 
RadioAmateur.EU

● Making menus easier to use

Menu switching

There are so many different menu selections and parameters to choose from that it is impossible to remember them all. Consequently, the menu system can be a little inconvenient when you need to change several settings at once.

To solve this problem, the TS-480 offers two sets of menus: A and B. Switching between these can greatly simplify operations – for example, when switching from DX to local, from regular to data communications, or from fixed station to mobile operations.

Quick menu

The TS-480 offers many menu functions. If you know which functions you use most of the time, you can arrange for other functions to be hidden when selections are displayed.

Structural Features

● Internal structure of the main unit

The internal structure of the main unit is straightforward: employing a die-cast aluminum chassis, it is designed so that the circuit boards are attached from both above and below. From above one can see the TX/RX unit, the filter unit and the relay unit; seen from below, there are the RF unit and the final unit (or final/AT unit, in the case of the SAT model). There is also a separate display unit in the standalone control panel.

Figs. 23~25 illustrate the arrangement of these units.

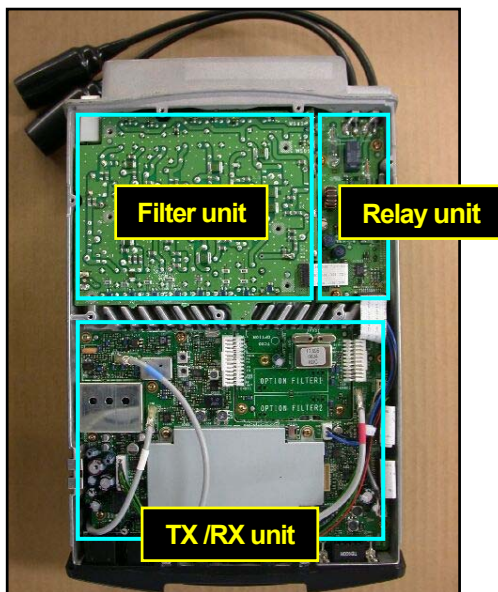

Fig.23: View from above (both models)

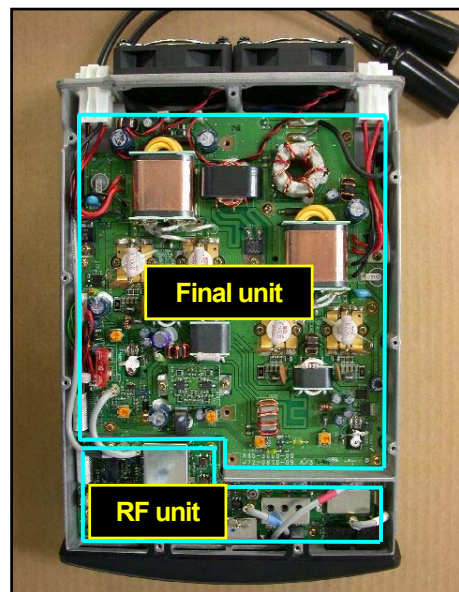

Fig.24: View from below (TS-480HX)

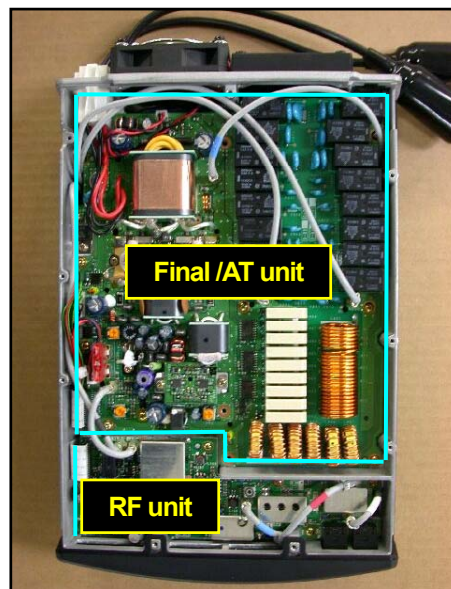

Fig.25: View from below (TS-480SAT)

● Cooling

In developing the TS-480HX, the most important issue when it came to structural design was how to arrange for sufficient cooling.

In order for this transceiver to be capable of 200W output and yet have the same compact design as the TS-50, we examined dozens of different cooling fans, various circuit board patterns, and a variety of different cooling fan layouts. After conducting several hundred different types of heat dissipation tests, we finally decided on the present structural design of the TS-480.

The principle features of this structure are as follows:

- Improved cooling efficiency as a result of employing twin cooling fans;
- Concentration of efficient cooling fins in one location since space limitations meant that a normal fin arrangement was not possible.

Fig. 26 illustrates how the TS-480 is cooled. The air that is sucked in through the front panel and the top and bottom of the case directly cools the surface of those internal components that are generating heat, such as the final section. At the same time, it absorbs the heat that has dispersed through the die-cast chassis before being expelled by the twin cooling fans at the rear.

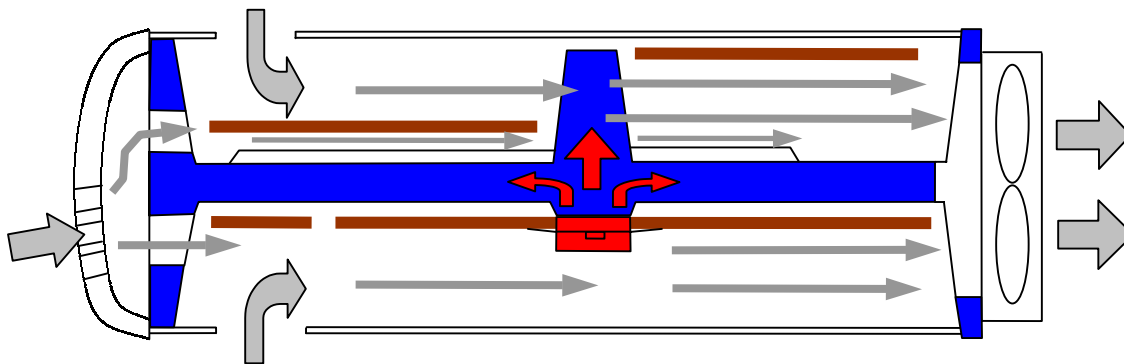

Fig. 26: Cooling diagram

Blue: Die-cast aluminum chassis

Red: Heat flow from final transistors

Brown: Circuit boards

Gray: Air flow (from front panel on left)

As you can tell from this diagram, the cooling fans located at the rear must be powerful enough to be able to suck in fresh air through the intakes on the front panel. In order to make the TS-480 as compact as possible the mounting density of the internal components has been increased; for this reason, we decided to install a pair of powerful cooling fans so as to ensure a strong flow of air and the increased cooling efficiency that would result.

The TS-480HX is equipped with 4 final transistors (2 in the case of the SAT model), and the heat produced by these disperses through the die-cast aluminum chassis. In order to efficiently transfer this heat outside the transceiver, cooling fins are absolutely essential. We would like to provide as many of these fins as possible, but in fact on more than one occasion we have found that, owing to space limitations, we were not able to fit in the normal complement of cooling fins. In the case of the TS-480, in order to make the transceiver compact we provided a single row of tall, highly efficient cooling fins right above the final transistors. This compensated for the lack of cooling fins dictated by the design restrictions.

Our decision to suspend the filter unit was made in order to fit in as many cooling fins as possible by packing in the components.

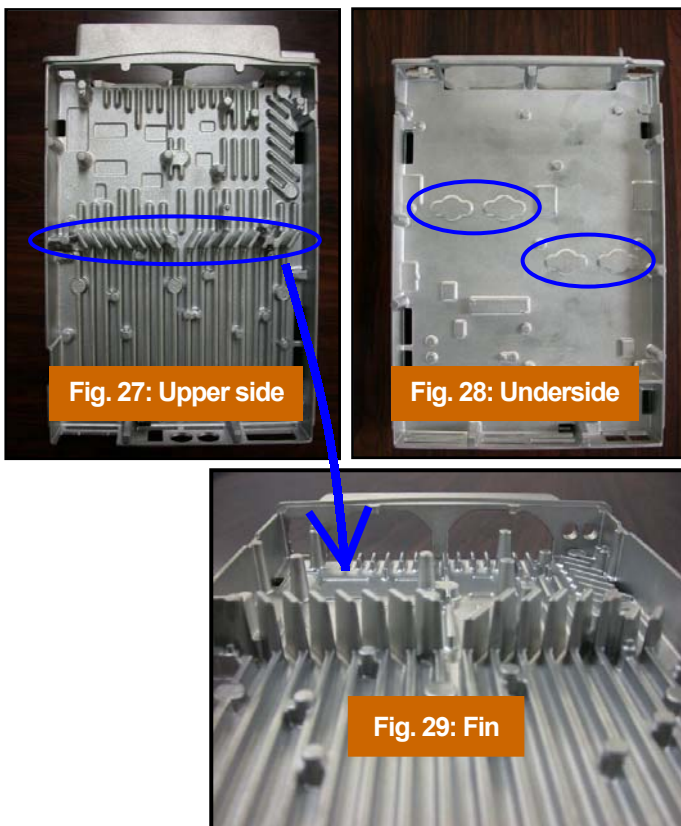

Figs. 27~29 are photographs of the TH-480HX die-cast aluminum chassis. The final transistors are positioned on the four raised areas (circled) that can be seen in the middle of the chassis (underside). On the opposite side to the final transistors, running across the middle of the upper side of the chassis, can be seen a row of relatively tall, flat cooling fins.

The air that is sucked in from the front is divided into two flows, one through the top of the chassis and the other through the bottom. The upper flow of air must pass through these high-efficiency cooling fins, absorbing the heat from them before it is expelled to the outside.

These fins, which also serve as a partition between the TXRX unit and the filter unit, are set diagonally so as to offer a degree of shielding.

Now let's have a look at the rise in temperature of the different parts when the TS-480HX transmits continuously (14MHz) for 30 minutes at 200W. To provide a comparison, plotted on the same graph is test data compiled for a compact 100W model (designed so as not to power-down during continuous transmission at 100W).

Fig. 30: Temperature rise around final transistors

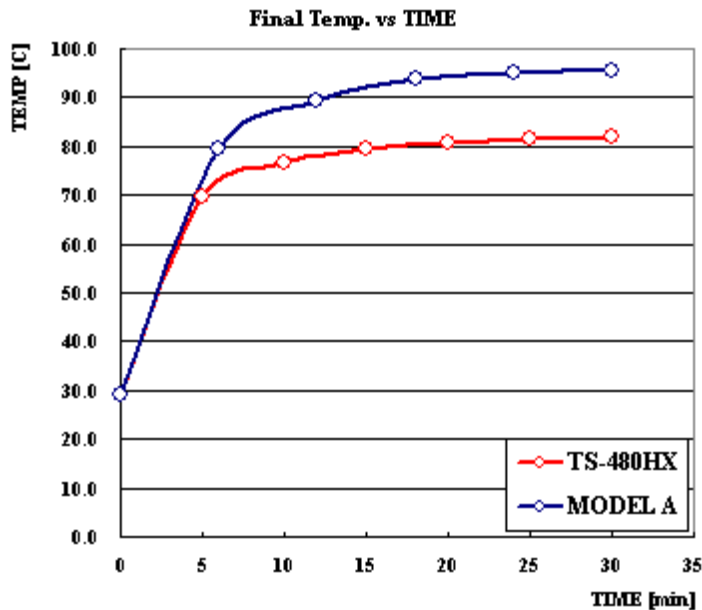

Fig. 31: Temperature rise of die-cast aluminum chassis around GND terminal on rear

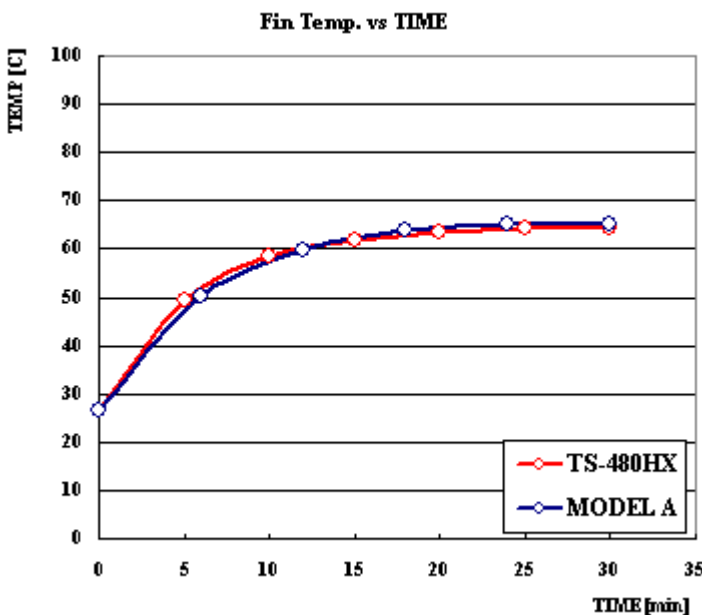
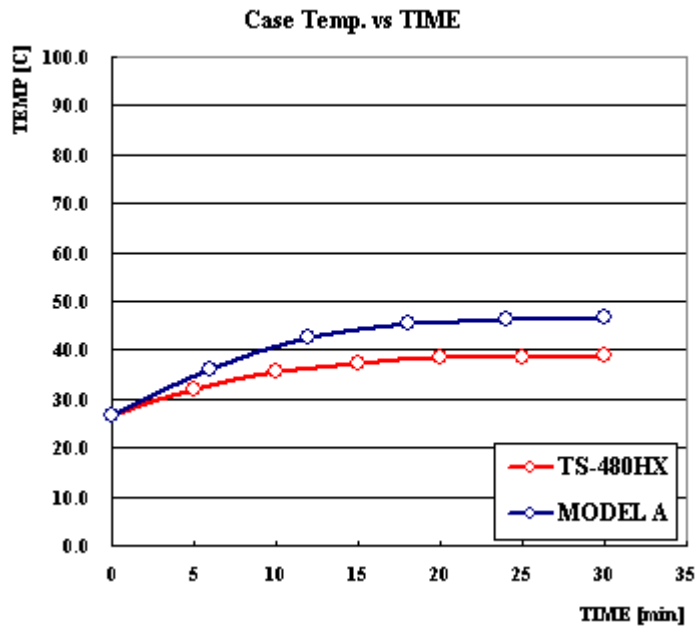

Fig. 32: Temperature rise measured at center of the upper case of the main unit



As you will appreciate from these results, despite the fact that the TS-480HX has an output of 200W, twice that of the comparison model, it boasts the same or even better cooling performance. It is not only designed not to power-down (for temperature protection) during continuous, normal transmission, but you can see that we have taken into full consideration the rise in temperature that occurs during continuous transmission.

Despite the fact that the TS-480 Series is compact, it has the same heavy-duty specifications as the previous, fixed station model. Nevertheless, electronic components, whether from Kenwood or another manufacturer, are generally susceptible to heat: the higher the temperature, the shorter is their working life. Therefore, in order that you can use the product for a long time, we recommend that you adjust output to suit conditions.

● Standalone control panel

In the compact size range, virtually all transceivers are designed so the control panel can be removed and replaced. While this is convenient, owing to the small dimensions of the main unit, the area of the front panel is necessarily limited. Consequently, in order to access the many functions that are used in HF operations using only a limited number of switches, hierarchical menus are unavoidable.

As explained in the section on development objectives, we started out with the premise that the TS-480 would not be limited to mobile applications but that it would be able to serve as a reasonably priced 200W fixed station. So rather than going for a simple appearance, we decided on a standalone control panel in order to provide true operating ease.

By separating the control panel from the main unit, its size can be decided independently of the cross-sectional area of the main unit. As a result, we were able to realize just about the same operability as one would expect of a conventional base station. Naturally, at the same time we adopted a large TN LCD, thus ensuring a responsive, easy-to-view display.

For the main encoder, we picked a magnetic encoder with 250-pulse resolution made by Copal Electronics Corp., using software to quadruple resolution to 1000 pulses per revolution. Since this encoder uses the same components used in virtually all of the models in Kenwood's HF fixed station lineup, even during mobile operations it should offer the same operability as during fixed station operations. In addition, by ringing the main encoded dial with rubber we have further improved operating ease, since it provides a good grip and is more pleasing to the touch.

In addition, installed inside this standalone panel is a 66mm-diameter speaker. Since the speaker grill is on the rear of the panel, you might wonder whether it can deliver sufficient volume. However, when you are actually using the standalone panel, you will find that the sound is reflected off your desk, the dashboard of your car, or the windshield, that is indeed loud enough.

● Design concept

The standalone panel of the TS-480 Series draws on the design of the TS-2000. While inheriting the best aspects of the former model's design, the new series represents an evolution in design with added emphasis on the 3D look, sharpness, and the power that is associated with 200W output. Also, the case of the main unit has been given a rounded form so as not to appear simply as a box; its design creates the impression of aesthetic unity.

The TS-2000 was mainly designed for fixed station operations, so it has a silver-colored control panel. The TS-480 is of course expected to be used more frequently for mobile operations so a black color scheme was chosen. Black helps to minimize light reflection when used outside in sunny conditions.

Of course the part of the transceiver that is most frequently touched is the main encoder dial. Each one is carefully machined and processed. After spin finishing, it is treated with titanium-colored alumite. The design of this main encoder dial is one of those features the TS-480 has inherited from the acclaimed TS-2000.

Of course, we were not exclusively concerned with design aspects – for example, adopting backlit rubber keys with a creamy-white base in order to improve visibility, and mounting the speaker in the rear of the standalone panel. We believe that our design enhances visibility and operating ease in both fixed and mobile operating environments.

■ New Option: Voice Guide & Storage Unit (VGS-1)



Developed at the same time as the TS-480, the VGS-1 can be installed as an option. Combining in one unit the functions of the voice synthesizer unit (VS-3) and the digital recording unit (DRU-3A) previously offered by Kenwood, the VGS-1 goes beyond both of these.

Let's now take a close look at the functions that are available using this unit.

● Constant recording function

NEW

Haven't you ever wondered if your callsign was being used correctly by other stations while on a DX'pedition? If you use this constant recording function, you can record and playback the last 30 seconds of received audio or transmitted audio (sidetone when operating in CW mode), allowing you to check what was said afterwards. In addition, you can use this handy feature for other purposes, such as recording memos.

It could not be easier to use. From the menus, you set constant recording to ON, and then all you have to do is operate the CH3/REC key. If you press the CH3/REC key for more than one second, the last 30 seconds of audio data is recorded in flash ROM. Then when you press the CH3/REC key the audio data recorded in flash ROM is played back. The audio data is held in flash ROM until it is overwritten by a fresh recording. Note that when recording to flash ROM, or when other VGS-1 functions are in use, constant recording is temporarily paused.

● Message recording/playback function

If beforehand you record standard CQ messages such as your callsign in the voice message memory, you can transmit them repeatedly at will, a feature that is extremely useful for DX'peditions and contests.

The main features of this message/recording playback function are as follows:

- There are three recording channels;
- You can record up to 30 seconds in each channel (using all three channels this allows a maximum of 90 seconds for message playback);
- Used in conjunction with VOX, message playback can be used to switch between TX and RX;
- Repeat playback is possible;
- You can adjust the interval for repeat playback (0~60 sec.); and
- You can adjust recording level.

With VOX on, repeat playback on, and the interval set appropriately, if you play back a prerecorded message repeatedly, the TS-480 will automatically switch between transmitting the message and waiting for a response. There is thus no need to sit in front of the mic and actually repeat your message over and over again.

Even when you use a microphone with low sensitivity to record a message, the TS-480 is designed to set the appropriate recording level. Normally, this recording level is automatically linked to the mic gain setting, so if you wish to adjust recording level manually, you should adjust mic gain while recording is in standby. In message recording mode, the ALC meter scale serves as a recording level meter. As you speak into the microphone, adjust mic gain so that the recording level just crosses into the MAX zone occasionally. Even when you record in this zone, the AGC is designed to keep audio distortion to a minimum.

● Voice Guide

Kenwood's Voice Guide function is not the same as the basic versions fitted in some transceivers merely to announce the frequency. Of course, we have included a frequency guide, but we were convinced that a Voice Guide is an obvious and essential feature for the menus and function settings that are so crucial for daily operation.

The TS-480 has inherited intact those Voice Guide features that have proved so popular in other models. However, in addition we have enhanced the Voice Guide functions for the different configuration modes, and by making it possible to vary the speed (5 levels) we have made sure that this rig is even more user-friendly.

We have programmed the TS-480 Voice Guide so that it only announces what has been changed in configuration mode, menus, etc. Thus items that are unchanged are not read out. Previously, even if there had only been a change in the options, the Voice Guide would read out each item: "menu", menu number, option, and so forth. For the TS-480, however, we have changed the Voice Guide algorithm so that it only announces the option, enabling swift confirmation without you being forced to listen to unnecessary details being read out.

Normally, Voice1 is assigned to a PF key on the control panel to read out operating frequency, channel number, the settings for each function, and so on. However, if you reassign a PF key (using menu #48) to #62, by switching to Voice2 you can hear the S-meter level being read out.

Introduced here are a few of the benefits of the TS-480 Voice Guide. Some of these are automatic, while others are accessed by the PF keys.

1. Reset

When the power is switched on, if you press the power switch together with either A/B or A=B, the Voice Guide will automatically respond with the query "VFO/FULL RESET?"

2. Configuration mode for TX output, etc.

When the PWR switch is pressed, the Voice Guide will automatically respond with "TX PWR" plus the option. If you change the option using the MULTI/CH encoder, just the new option will be announced. With previous models if one pressed the PF key at this point, the frequency would be read out, but the TS-480 announces the setting plus the option.

3. Frequency lock

Whenever the MENU button is pressed for more than 1 second, the Voice Guide will automatically respond with "FREQUENCY LOCK ON" or "FREQUENCY LOCK OFF", whichever is appropriate.

4. Menu settings

If the MENU button is pressed, the Voice Guide responds with "MENU" plus the menu number and the option. If you change the option using the MULTI/CH encoder, the menu number and option will be announced. If the ▲ and ▼ keys are pressed, just the option will be read out. For the options actually announced for the various menu items, please refer to the menu list provided in the instruction manual.

5. Split mode

If you press a PF key during split operations, the Voice Guide will read out VFO + S + A + frequency. (Here "S" stands for split mode, while "A" means VFO A.)

6. VFO mode, direct frequency entry

Let us say you are operating at 7.033MHz and in VFO mode you press the PF key, the Voice Guide will announce “VFO”, “A” or “B”, and 7.033.00. If you use the key pad to input ENT, 2, 1, 1, 9, 5, ENT, you will hear each key announced – “Enter”, “2”, “1”, “point”, “1”, “9”, “5”, and finally “Enter”. On confirming with the Enter key, you will hear a beep to indicate “T” and then the input frequency will be read out. Note that in memory channel mode you can also specify channel number for frequency entry.

7. Memory channel

Let us imagine that the last memory channel you used was 89. Selecting memory channel mode from VFO mode will cause the Voice Guide to announce “Channel”, “89” and the stored frequency. Selecting memory scroll mode from VFO mode will cause the Voice Guide to announce “Memory in”, the channel number, “Blank” if the channel is unused or the stored frequency if it is in use. To store a frequency in a memory channel, pick the desired channel and once again press QMI; you will hear a beep to indicate “T” and the data will be written to the memory channel. It will return to VFO mode when the write has been completed. With quick memory mode, you can call up a stored frequency with QMR and the Voice Guide will announce “Quick Memory”, the channel number and the stored frequency.

8. Variable Voice Guide speed

With Menu #16 you can adjust the speed (5 levels) of the Voice Guide to suit your preference. The factory setting is level 1. Note that as the speed increases, the tone of the voice changes.

9. S-meter level

By assigning the Voice2 function to a PF key, you can hear the S-meter level being read out, according to the table below. (After operating PF(VOICE2))

Meter level	Voice guide	Meter level	Voice guide	Meter level	Voice guide
0	S0	7	S5	12	10dB
1 – 3	S1	8	S6	13 – 14	20dB
4	S2	9	S7	15	30dB
5	S3	10	S8	16 – 17	40dB
6	S4	11	S9	18	50dB
				19 – 20	60dB

Other features

This is not connected with the Voice Guide, but the TS-480 is also equipped with a feature that has proved popular on previous models – namely, it issues a beep that serves as an SWR alert when an error is detected in Morse mode with AT tune.

Also, the TS-480 offers a range of beep functions to facilitate operations. These include issuing an “end stop beep” to mark an end stop for options, differential beeps to distinguish between ON and OFF when toggling a key, or to distinguish between configuration mode and completion when adjusting TX output, etc.

Note:

For those people who do not require the Voice Guide, it is possible to disable it by simply turning the volume to OFF. Just proceed to menu #15 and select OFF.

■ New Option: ARCP-480 (Amateur Radio Control Program for TS-480) Freeware

Kenwood's ARCP software has proven very popular. For the TS-480 we have made some significant improvements, releasing it as "ARCP-480".

KNS added

ARCP-480 is compatible with the Kenwood Network Command System, enabling control of the TS-480 over a network and, using H.323 (VoIP), making voice transmission/reception possible. So that you can enjoy easy control of the TS-480 from your computer,

both ARCP-480 and ARHP-10 programs (explained later) are available free and can be downloaded from Kenwood's website.

URL: <http://www.kenwood.com/i/products/info/amateur.html>

There is ARCP software for the TS-870 and TS-570, as well as for the TS-2000. As with ARCP-2000 and the TS-2000, the new ARCP-480 program allows you to control virtually all of the functions on the TS-480 transceiver. What follows is an explanation of the major differences between ARCP-2000 and ARCP-480.

● Main functions

1. Button layout & basic operation

Just as when one uses the tuning control on the TS-480 to change frequency, how one changes frequency with ARCP-480 is very important. We have made the ARCP-480 software easier to use by improving the way you use the mouse to change frequency.

Click on the tuning control icon to enter tuning mode. To raise the frequency, keep your finger on the left mouse button while turning the mouse to the right. Similarly, to lower the frequency, keep your finger on the left button while turning the mouse to the left. To return to normal operations exit tuning mode.

If you want to use a wheel mouse* to change frequency, you can of course work in tuning mode but even when tuning mode has not been selected the wheel can be used to change frequency by whatever increment has been set in Click Enc./Step.

(Step no.)

Note that if the TS-480 is currently in a configuration mode, these actions will effectively change the settings. But in this case a message is displayed, so you can exit from configuration mode before continuing.

**This feature is only compatible with a genuine Microsoft® IntelliMouse® and driver.*

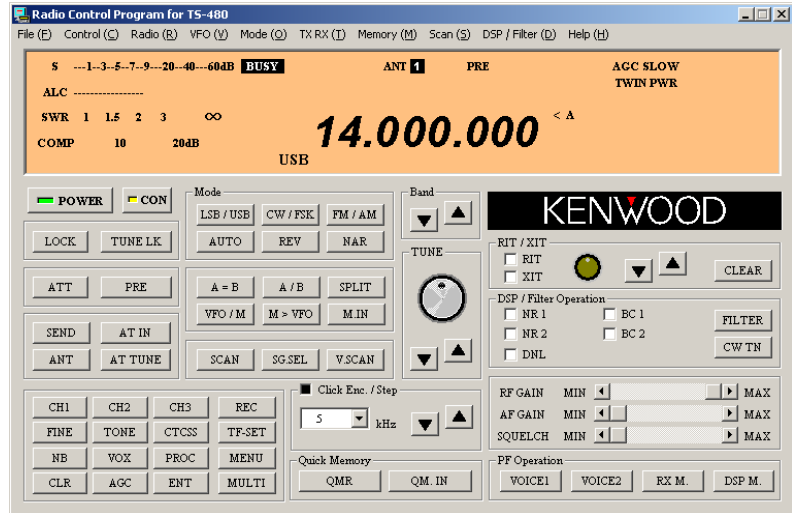

2. Changing memory and registered details

You can change any registration data from the appropriate window. You use this window when storing new data in memory. Display the frequency you wish to register and press M.IN. Then pick the channel (0-89) you want to write to and press DISP: the memory window (right) will open. This window now allows you to pick split operations. If you wish to switch to split mode, check the TX/End Frequency checkbox and you can then enter the frequency for the TX station as split memory. By clicking on the box displaying the frequency you can input the desired frequency, and you can also store it. As with ARCP-2000, you can input memory names in this window.

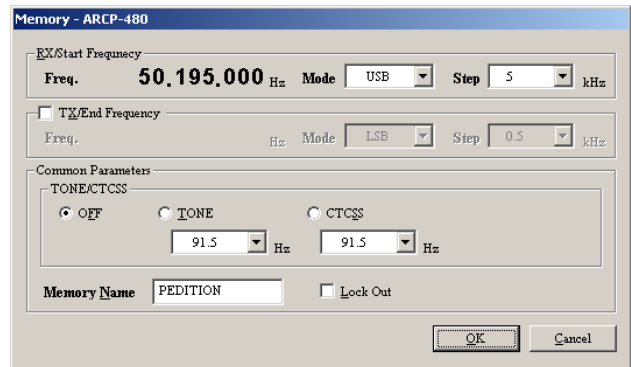

3. CW keying

You can also use ARCP for keying. If you think you may have made a mistake while keying, ARCP-480 allows you to click the Stop button to prevent the message from being sent, although with previous versions of ARCP you could not do this. Also, you can enter special codes (with a few exceptions) from the keyboard.

Since you can now enter BT and other special codes from the keyboard, you do not have to move your hands from the home position during a QSO. Also, the software now allows you to stretch the log window, which is useful when it becomes filled with messages. The window can be closed even during transmission by just pressing the ESC key.

ARCP-480 does not allow direct keying by typing, but for it is a fully practical solution for regular QSO.

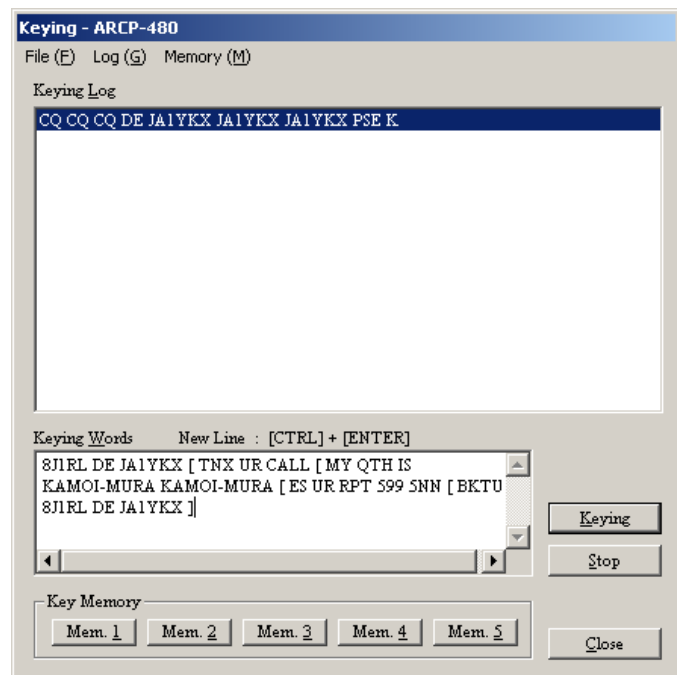

Special code input

Special code	Key / Display	Special code	Key / Display
<u>BT</u>	“[“	<u>AS</u>	“<“
<u>KN</u>	“] ”	<u>AR</u>	“ ”
<u>BK</u>	“\ ”	<u>HH</u>	“#”
<u>SK</u>	“>“	<u>SN</u>	“%”

4. Reading and writing files

With ARCP-480 you can write memory channel and menu data to a file for later recall. This does not apply in certain cases when using KNS.

● Compatibility with KNS (Kenwood Network Command System)

KNS is the name for the system that enables remote control of the transceiver over a LAN or WAN; ARCP-480 is equipped with the remote functions for this system. To use KNS, you need to have at least 2 computers, the remote one having ARCP installed and the host computer having ARHP installed.

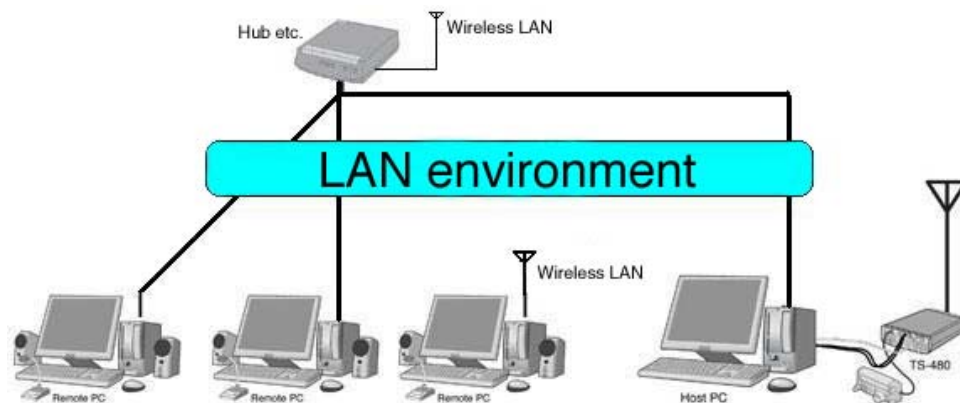

The basic arrangement is to connect the TS-480 to a host computer, which is on a LAN, and to install ARHP-10 on this computer. ARCP-480 is then installed on the remote computer.

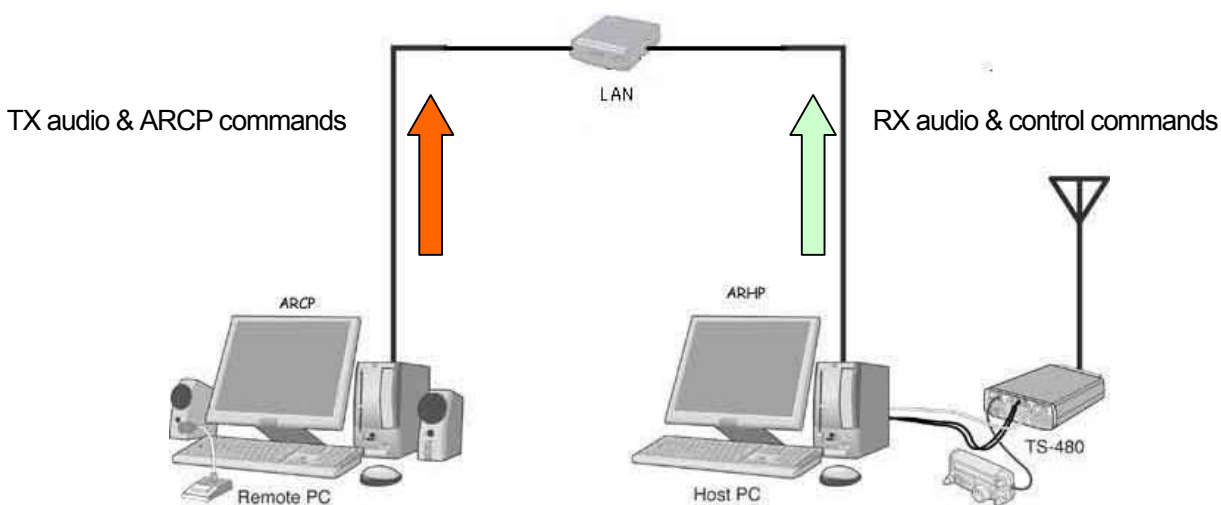

When the system is operating, RX audio and the commands that control ARCP are sent from the host PC, along with the TX audio and commands controlling the transceiver.

Using this combination of ARCP-480 and ARHP-10, in order to be able to communicate by voice, and to be able to hear the sidetone when keying, both the host PC and remote PC must be running Windows® 2000 (SP3 or later) or Windows® XP (SP1 or later). For voice exchanges, the remote PC must be connected to a microphone for TX audio input, and to a speaker for receiving audio. These are both plugged into a sound card.

Accidental continuous TX

Inasmuch as KNS is a network-based method for performing remote control over a network, it is possible that, through some malfunction, the TS-480 installed on the host end might go into continuous transmission accidentally.

By setting the time-out timer on the TS-480, it is possible to ensure that, after the set time period has passed, the transceiver will automatically switch back to RX mode. The timer count always starts with the commencement of transmission, so even in the case of a prolonged but intentional transmission, after the set period has passed it will switch back to RX; nevertheless, it is a good way to prevent the transceiver from going into continuous TX mode.

In the event that, following the start of transmission, some network problem arises that prevents you from executing the command for the transceiver to switch back to RX, the ARHP-10 software itself is equipped with a function* that, after the passage of a fixed period of time, will switch the transceiver back to RX mode. However, please make sure that you can obtain rapid access to the host if a malfunction occurs.**

**This software cannot handle every problem that may occur.*

***In Japan only. For details, refer to the laws governing radio transmissions.*

Setting up KNS on the ARCP side

First check the LAN/WAN. Ensure that everything is set up correctly, referring to the second section on ARHP10, ARCP-480 Help, and the instruction manuals for your network devices.*

Before setting up the host side for KNS, you should first check with the administrator of the host computer and obtain all necessary information. This includes the KNS host address, the command port number, user name and password, and guidance on how to connect the audio cable.

Within the setup window, you should fill in the necessary information in the KENWOOD NETWORK COMMAND SYSTEM frame.

If the To: combo box is empty, this means that no KNS host has been selected. You should input the host for the connection using the Setting and Add buttons.

In the KNS Connection Settings window, you should input the name of the other computer as the connection name, together with its description. For the address, input the IP address of the other computer. You must also input user name and password. If you are going to use voice

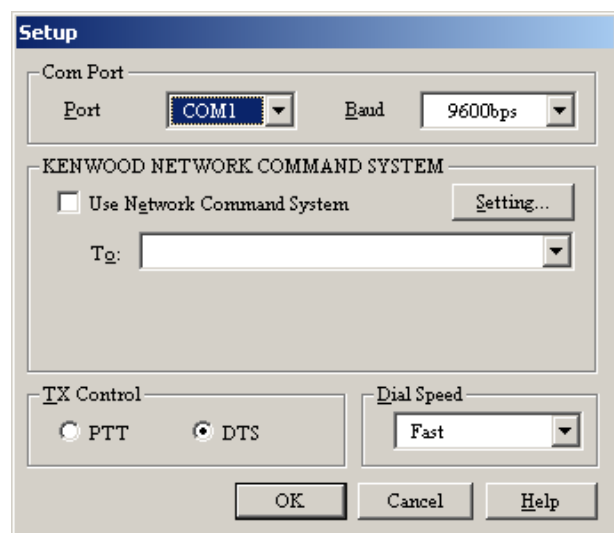

communications and the operating system on either end is compatible, check the Voice box. (It is possible to enter the description using double-byte characters. For the address, it is also possible to enter the domain name, provided that it can be resolved by DNS.)

Once you have finished, return to the setup window, select the other computer in the To: combo box, and check the box labeled Use Network Command System. In the TX Control frame, check DTS if the audio cable is connected to the data terminal of the transceiver; check PTT if it is connected to the mic and EXT-SP terminals. When you are finished, click on OK.

The next step is to make the connection by clicking on CON, as you would with any other ARCP software. If a normal connection is established, the green indicator lights on the CON button. When you are connected using the KNS system, certain functions are not available. For details, refer to ARCP/ARHP Help.

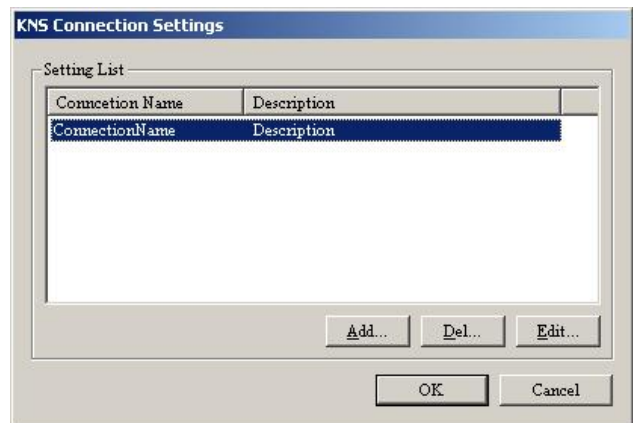

Downloaded by **RadioAmateur.EU**

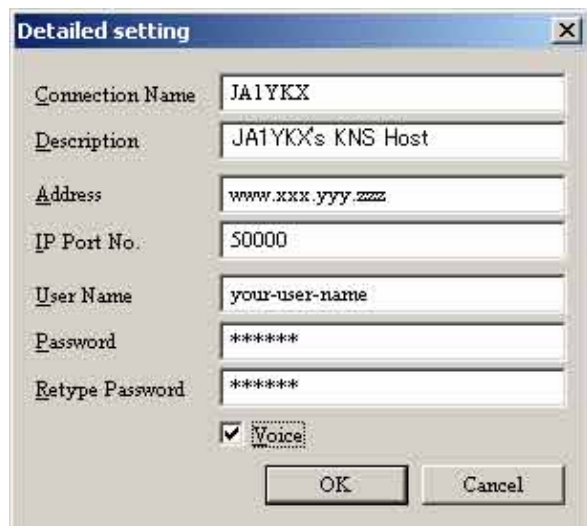

* In order to remotely control a transceiver via a WAN, you must apply for permission. For details, refer to the instruction manual and the materials available on our website. Once you have obtained permission, you can use KNS for remote control, but please make sure you follow correct operational procedure. The above applies to remote control operations within Japan.

To use KNS via a WAN, **you must obtain global IP addresses for the computers running ARCP and ARHP to enable external access.** Note that that when you open a broadband router port you do so at your own risk.

Using a broadband router

Many people using the Internet today use a broadband router (hereafter referred to simply as a router), but in order to use KNS in a setup that has routers installed at both the host and remote ends, you need to configure each end separately. With KNS, for transmission and reception using the TCP protocol you need to open one port for commands and several ports for VoIP. If a router is compatible with Microsoft® NetMeeting®, by setting it up correctly you should be able to make use of H.323 (VoIP) voice transmission/reception. For using only ARCP control, you open port 50000 (default) for bidirectional communications using the TCP protocol. If you also want to use VoIP audio communications, you would normally have to open the following ports:

Ports: 389, 522, 1503, 1720, 1731 Protocol: TCP

Direction: bidirectional

Ports: dynamically assigned ports in the range 1024-65535

Protocol: TCP/UDP

Direction: bidirectional

Note that even if the router is compatible with Microsoft® NetMeeting®, you must open the port for ARCP control for TCP in both directions. To conduct voice communications, in most instances ports 1503 and 1720 are opened and, if needed, NAT (Network Address Translation) set up to enable the two parties to converse via VoIP. If you are using a router that is not compatible with Microsoft® NetMeeting®, you may not be able to conduct voice communications via VoIP, even with the communications ports open and the correct NAT settings.

If you are using a router with a built-in xDSL modem, it may be possible to enable KNS with the correct bridge settings.

Once you have opened all these ports, you must be careful about security. Also, if you configure a bridge, you may require a client and another router externally to use PPPoE* authentication. When using a PPPoE client, refer to the relevant instruction manual to ensure that everything is set up correctly, and please remember that you use this feature so at your own risk. Note that a PPPoE client is available as a standard feature of Windows® XP.

Before opening router ports and making changes to your PC settings and to your network, you should first carefully read the instruction manuals for the hardware. And remember you do so at your own risk. Should you make a mistake, you may cause the network to fail or make it vulnerable to intruders.

■ New Option: ARHP-10 (Amateur Radio Host Program) Freeware

ARHP-10 is the host application for use with the Kenwood Network Command System. As was explained in the section on ARCP-480, if ARHP-10 is installed on the host computer it can serve as the host in a KNS connection.



1. Make an audio/voice cable & connect the TS-480 to your PC

To conduct voice communications you require a PC with the Windows®

2000 operating system or a later Windows OS, but in addition you need to connect the transceiver to the PC with an audio cable.

Kenwood does not supply a cable for this purpose so you must make up one by yourself. When doing this, please refer to the wiring diagram on the right.

Illustrated here is the wiring diagram for a cable that uses the DATA connector. It is also possible to make up a cable that uses the MIC terminal; to make such a cable, you will need a RJ-45 crimp tool to attach the connector. For the MIC terminal wiring diagram, please refer to the instruction manual.

If using the MIC terminal, you will need a cable in order to hear the audio received by the TS-480; this connects the transceiver's EXT-SP terminal to the input terminal on the PC sound card.

TS-480

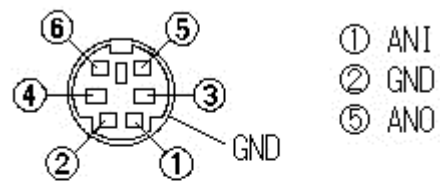

PC

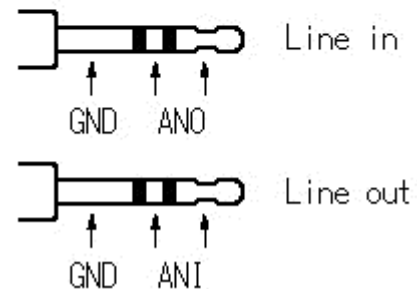

2. Checking LAN settings

In order to operate KNS, you must first check the correct settings (operating system, home LAN devices).

In regards to a LAN, by ensuring that each device is set up correctly, communications should be possible; however, if the connection is made via a WAN, one can suppose that as a result of various network problems, commands and/or voice may not get through properly. Even in such cases, you may find that the problem can be solved by changing the network device settings.

Depending on the service offered by your Internet provider, you may find that you cannot obtain a global IP address or that commands and/or voice are not getting through.

Also, if you are using a router to access the Internet, in addition to opening the command port for sending and receiving with TCP, if the router is compatible with Microsoft® NetMeeting®, by making the appropriate "port open" setting it should be possible to conduct voice communications when KNS is active. Be sure to read carefully the instruction manual before changing the settings on any network device. You do so at your own risk.

3. Adjust PC volume

Whether hosting via a WAN or within a LAN, it is recommended that you test your setup at least once using a KNS environment arranged with host and remote on the same LAN. This should allow you to adjust volume to the appropriate level. To adjust terminal level, display the recording control, confirm that MIC input is selected, and adjust the level. For speaker output level adjustment, adjust WAVE.

4. User setup

Open the setup window and set the COM port to be used for commands, whether or not to use voice communications, session time, and whether or not to keep a log. By clicking on Add, you can then input the name and password of the user to connect.

The host administrator then informs the remote PC user of the above user name and password, as well as other relevant information such as how to make up an audio cable (for use with either the DATA terminal or MIC/EXP-SP). The remote PC user can then connect to this host using the information provided.

Note that a red X mark within the user frame indicates that this user is temporarily barred from connecting to the host.

After the setup is completed, you can return to the main window and click on CON; the button will then appear yellow. This completes the setup: the host is now ready for the remote PC user to make a connection.

Once the audio cable has been made up, connect the various cables to your PC as illustrated below.

In addition, connect your PC to the TS-480 with an RS-232 cable.

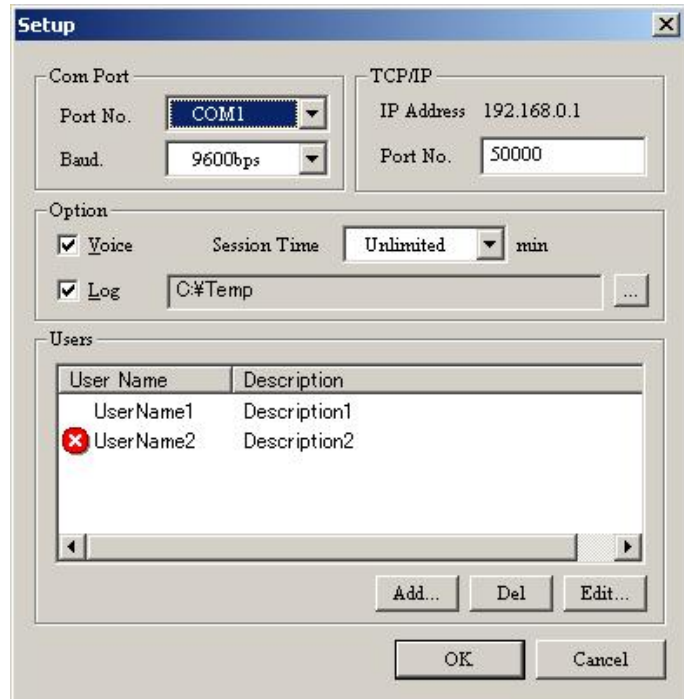

**KENWOOD NETWORK COMMAND SYSTEM
Connection with TS-480**

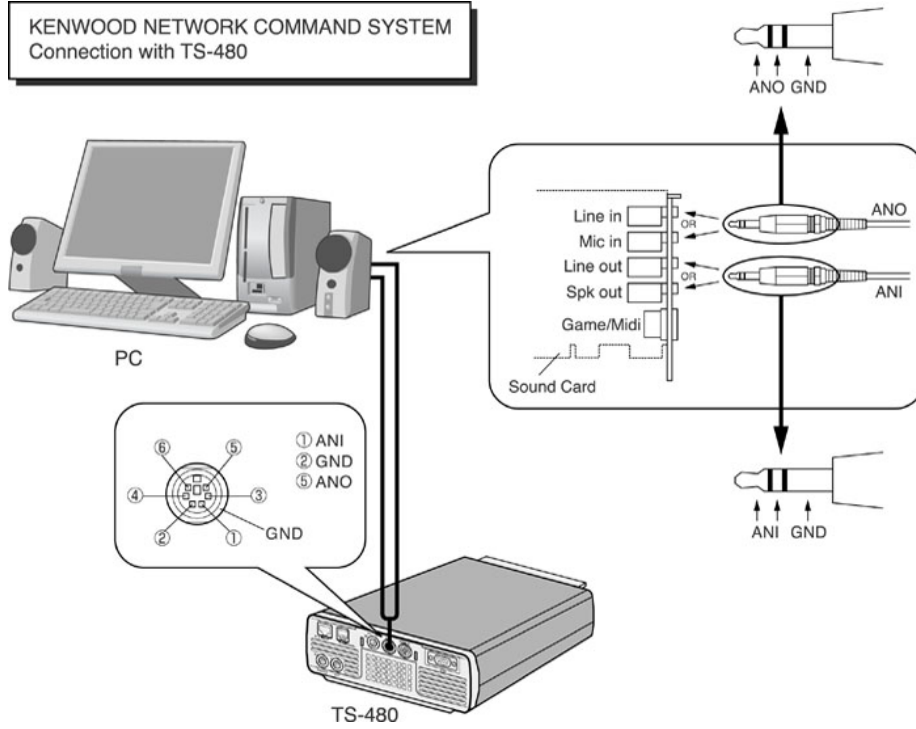

Downloaded by
RadioAmateur.EU

● Troubleshooting

Listed below are typical problems that you might encounter.

Network & Operations	
Problem	Solution
Is it possible to use an analog dial-up connection?	We recommend a broadband connection. Otherwise, if you have a narrowband connection of about 50kbps, it might work, though this will depend on network traffic conditions. You must also expect to encounter some noise and to lose audio contact intermittently.
I have broadband but is it compatible?	Yes, it is compatible provided that your ISP provides a global IP address, VoIP ports, and a command port.
Can I use my router with KNS?	We do not guarantee that KNS will work through a router. Nevertheless, if your router offers DMZ or “virtual computer” features, you may be able to set it up by yourself to enable KNS to work properly. You will have to make the required adjustments, referring to the instruction manuals for the devices you are currently using, at your own risk. Generally speaking, you can use any modem that is compatible with Microsoft® NetMeeting®. If your operating system is XP, switch off the ICF (personal firewall) provided by Windows®.
With a high-speed modem connected directly to my PC running Windows® XP, KNS does not work.	If the ICF (personal firewall) of Windows® XP is switched on, you should switch it off; however, be aware that this can represent a security risk.
I am using a high-speed modem connected directly to my PC, but the modem is inside the router.	<ul style="list-style-type: none"> • Switch to a modem that is not inside a router. • Open the ports required for KNS: a command port and H.323 control ports (if the router is compatible with Microsoft® NetMeeting®). • If you must use a router with built-in modem, try setting up a bridge. In this case, however, some ISPs will not issue an IP address. To solve this, you can either set up another router (compatible with Microsoft® NetMeeting®) externally, or have an IP address issued using a PPPoE* client. (A PPPoE* client is available as a standard feature of Windows® XP.) <p>Be aware that you do all of this at your own risk.</p>

<p>I cannot get KNS to work over the Internet connection that is provided as a collective service to my apartment block.</p>	<p>It is possible that one of more of the ports required by KNS is blocked. Talk to your network administrator to see if the requisite ports can be opened.</p>
<p>Can I use a software-based firewall?</p>	<p>KNS will probably work with your firewall, provided that it is set up for the ports required by ARCP and ARHP to be open.</p>
<p>I want to time-out TX after a set time.</p>	<p>Set the TOT to whatever duration you require. However, since this simply times your transmission, once the time is up, it will return the transceiver to RX even if you are in the middle of transmission.</p>
<p>Is KNS compatible with digital communications (PSK31, SSTV, etc.)?</p>	<p>There is a delay with KNS. If you are using a WAN, this delay increases, so it is not suitable for the various types of digital communications or other operations that demand a quick response. It is also not recommended if audio quality is a priority.</p>
<p>Is KNS compatible with full break-in or quick break-in times?</p>	<p>Owing to the delays inherent in a network, this system is not compatible with full break-in. For this same reason, it is also not recommended for operations that require strict TX/RX timing (contests or pileups). Also, break-in time should be set longer than usual.</p>

Sound	
Problem	Solution
The sound does not get through (host PC).	<p>First check that the audio cable is connected properly.</p> <ul style="list-style-type: none"> • Check what audio input method (MIC/EXP-SP or DATA) has been selected for the transceiver. <ul style="list-style-type: none"> • If the DATA terminal is used: Use menus #46 & #47 to check that I/O levels are correct. • If MIC/EXT-SP is used: Check that AF level and mic gain are correct. • Check your computer: Check that the computer can produce sound; update drivers as necessary. • Connect the transceiver's RX audio to the input of your computer and bring up the recording control window. Check that the input terminal you are using is active and that it is set to an appropriate level. Bring up the playback control window; make sure that it is not muted and that it is set to an appropriate level. Check that you can hear something from the speakers connected to your computer. After you have completed these checks, mute the PC output. • Check that you are using a compatible operating system. • Check that Voice is checked in the ARHP-10 setup window. • If using a WAN, check that KNS will work locally over your LAN. • If using a WAN, check your communications hardware and ISP settings. (If you are using a router, try removing it temporarily to see if that makes a difference.) <p>Check that KNS VOICE is illuminated in the ARCP-480 display. If it is not, recheck your operating system for compatibility and also your network settings (including your ISP service).</p>
The sound does not get through (remote PC).	<p>First check that the host audio is connected properly.</p> <ul style="list-style-type: none"> • Check what audio input method (MIC/EXP-SP or DATA) has been selected for the transceiver on the host side. <ul style="list-style-type: none"> • If the DATA terminal is used: Use menus #46 & #47 to check that I/O levels are correct. (Normally, there would be no need for the remote PC user to think about this.) • If MIC/EXT-SP is used: Check that AF level and mic gain are correct. • Check your computer:

	<p>Check that the computer can produce sound; update drivers as necessary.</p> <ul style="list-style-type: none"> ● Connect a microphone to the computer and bring up the recording control window. Check that the input terminal you are using is active and that it is set to an appropriate level. Bring up the playback control window; make sure that it is not muted and that it is set to an appropriate level. Check that you can hear something from the speakers connected to your computer. ● Check that you are using a compatible operating system. ● Check that Voice is checked in the ARHP-10 setup window on the host computer. ● Check that KNS VOICE is illuminated in the ARCP-480 display. If it is not, recheck the host computer operating system for compatibility and also the network settings (including the ISP service for the host computer). ● If using a WAN, check that KNS will work locally over your LAN. ● If using a WAN, check your communications hardware and ISP settings. (If you are using a router, try removing it temporarily to see if that makes a difference.) ● Check that Voice is checked in the ARCP setup window. ● Check the modulation line. Check that the host PC audio cable connection method in the TX Control frame of the Setup window is the same.
<p>TX/RX audio breaks up, is distorted or faint.</p>	<ul style="list-style-type: none"> ● Bring up the playback and recording control windows on both host and remote computers and try adjusting the levels. ● If the RX audio seems faint, and if the Line-in terminal is being used for input on the host computer, try switching to the Mic-in terminal. ● If modulation seems faint during TX, and if the Line-out terminal is being used for output on the host computer, try switching to the Speaker-out terminal.

KENWOOD

TS-480 In-Depth Manual

Published in April 2004 by Kenwood Corporation
Communications Equipment Division
Unauthorized reproduction is forbidden.
Copyright © 2004 KENWOOD CORPORATION

Downloaded by
RadioAmateur.EU