



COMMUNICATIONS RECEIVER

Model R-300



OPERATING MANUAL

FEATURES

1. **Wide receiving frequency range covering 170kHz ~ 410kHz and 525kHz ~ 30MHz to provide reception of all broadcast in LW, MW and SW bands.**
The 525kHz-30MHz receiving band (continuous coverage) permits reception of amateur radio stations, weather report stations and many others as well as standard broadcast stations.
 2. **Spread Dial (different depending on the destination area)**
Frequencies of 10 SW broadcast bands or 5 amateur bands are magnified on the spread dial for easy and accurate readouts of frequencies.
The receiver is also provided with its own built-in marker for frequency calibration.
 3. **Double Conversion Type F Band (18 ~ 30MHz)**
The F band uses a double conversion system with 4.034MHz 1st IF and 455kHz 2nd IF to provide dependable performance over the high frequency range.
 4. **AM, CW and SSB Reception**
Because of adoption of a variable pitch BFO and a balanced detecting circuit, signals of CW and SSB as well as AM can be received efficiently.
 5. **Built-in 500kHz Marker**
The built-in 500kHz crystal oscillator provides accurate reading of frequencies.
 6. **WIDE/NARROW Sensitivity Selector Switch**
The sensitivity selector switch permits HI-FI reception of broadcast at its WIDE position when signal conditions are favorable. The NARROW position eliminates interference noise for clear reception.
 7. **Dual Gate MOS FET**
The employment of dual gate FETs in RF and mixer circuits assures high sensitivity and outstanding cross modulation rejection.
 8. **Three-way Power System**
The receiver operates on AC, internal batteries or external DC source. It is automatically switched from AC to battery operation when AC failure is encountered.
 9. **Equipped with a handle for carrying convenience.**
 10. **Receiving Band Indicator**
The receiving band indicator adjacent to the dial drum allows easy check of receiving band.
 11. **Large Sized Flywheel**
The use of large sized flywheel allows easy and smooth turning in any desired station.
-

CONTENTS

SECTION 1. INSTALLATION.....	3
SECTION 2. OPERATING CONTROLS.....	6
SECTION 3. OPERATING INSTRUCTIONS.....	8
SECTION 4. CIRCUIT DESCRIPTION.....	14
SECTION 5. MAINTENANCE AND ALIGNMENT.....	15
SECTION 6. ENJOYING SW RECEPTION.....	21
SPECIFICATIONS.....	26
SCHEMATIC DIAGRAM.....	27

SECTION 1. INSTALLATION

1-1. UNPACKING

Remove the R-300 from its shipping box and packing material and examine it for visible damage. If the equipment has been damaged in shipment, save the boxes and packing material and notify the transportation company immediately. It is a good idea to save the boxes and packing material in any case because they are very useful for shipping or moving the equipment.

The following accessories should be included with the receiver.

Operating manual	1
AC Power Cord	1
(not included with receiver of SEV specification)	
DC Power Cord	1
Lead Wire for Indoor Antenna.....	5 m
Warranty Card	1
(in U.S.A. only)	

1-2. INSTALLATION

Select a place of installation where is out of the direct rays of the sun. Insure that there is ample space above and both sides of the receiver to allow free air circulation.

POWER CONNECTION

Make sure that your AC line voltage corresponds to the voltage marked on the name plate on the rear panel.

Connect the AC POWER cord to an appropriate external power source.

1-3. ANTENNA AND GROUNDING

Installation of antenna and grounding is important for optimum reception of short-wave broadcast or amateur radio signals. A good outdoor antenna will provide best results in reception of a variety of remote stations.

The following describes various types of antennas to be used and their installation:

NOTE: Install the supplied indoor antenna as high as possible. It must be extended to its full length, or else optimum results cannot be expected.

LONG-WIRE ANTENNA

This is the most simplified antenna. Use an antenna wire of about 30 ~ 100 feet (10 ~ 30 m) and install it on poles, trees or any other convenient location. The antenna wire may be a large sized, vinyl insulated, stranded wire (about 30 strands) or a copper wire of 1/16 ~ 5/64 in. (1.6 ~ 2 mm) diameter.

These type of antenna must be installed horizontally over a length of more than 60 feet (20 m) and positioned as high as possible. Note that it should be as far away as possible from buildings, AC power lines, trees and other objects.

The picture shows an inverted L-type antenna. Other types of antennas such as slant type, vertical type, etc. are also available.

The long-wire antenna, when installed in a open area, is available for all bands.

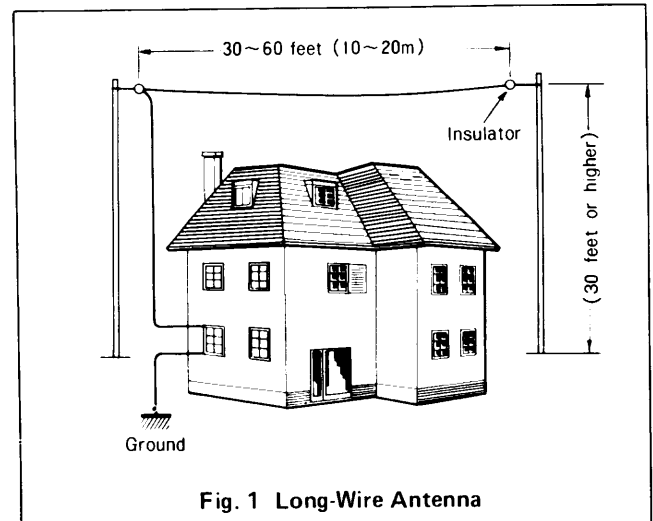

Fig. 1 Long-Wire Antenna

DOUBLET ANTENNA

This type of antenna is suitable for reception of a specific band. The relation between the overall length "L" and tuned frequency is as follows:

$$L (m) = \frac{143}{\text{Freq (MHz)}} \quad L (\text{feet}) = \frac{468}{\text{Freq (MHz)}}$$

This antenna has a directivity so that the gain is increased and noise is minimized in the right angle direction from the antenna at a tuned frequency of specific receiving band. It must be used with a 75Ω coaxial feeder.

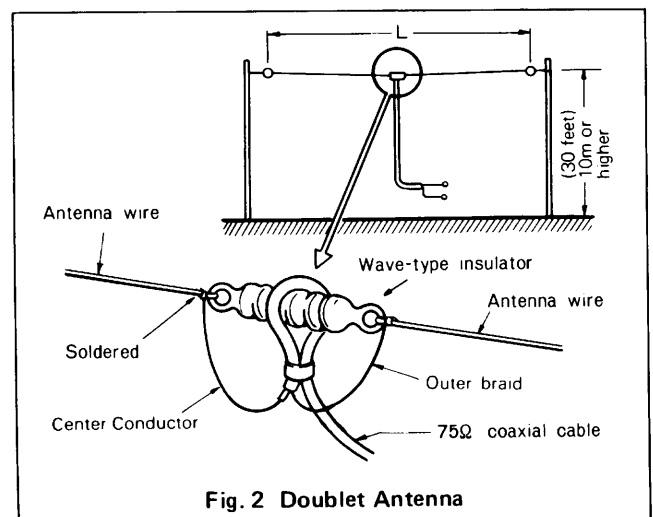

Fig. 2 Doublet Antenna

INVERTED V-TYPE ANTENNA

This is a modification of doublet antenna, designed to be installed on a single pole. The characteristics of this antenna are almost the same as those of doublet antennas.

The overall length "L" is a little larger than that of doublet antennas, and is obtained by the following:

$$L \text{ (m)} = \frac{148}{\text{Freq (MHz)}} \quad L \text{ (feet)} = \frac{486}{\text{Freq (MHz)}}$$

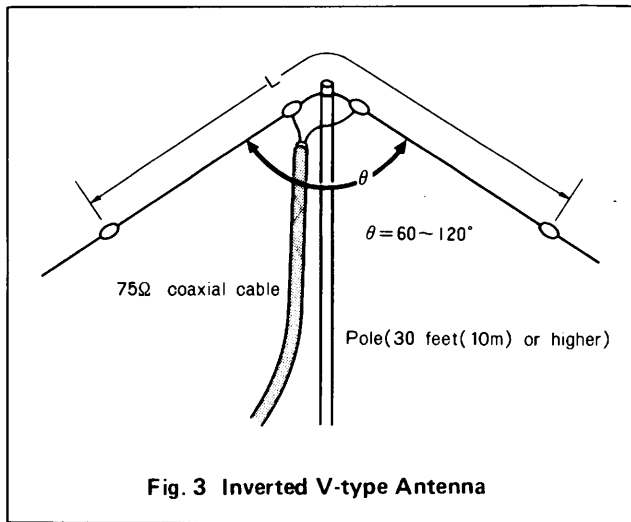

MULTIBAND ANTENNA

This antenna uses more than one doublet antennas for multiband reception. The overall length "L" is the same as that of doublet antennas. If the lengths L1, L2 and L3 are set to the frequencies 7 MHz, 14 MHz and 28 MHz, respectively, then L1 is tuned to 21 MHz (3 × 7 MHz), permitting both the reception and transmission of signals of 4 amateur bands of 7 ~ 28 MHz. If the antenna is used for only reception, it covers a wide 6 ~ 30 MHz broadcast band.

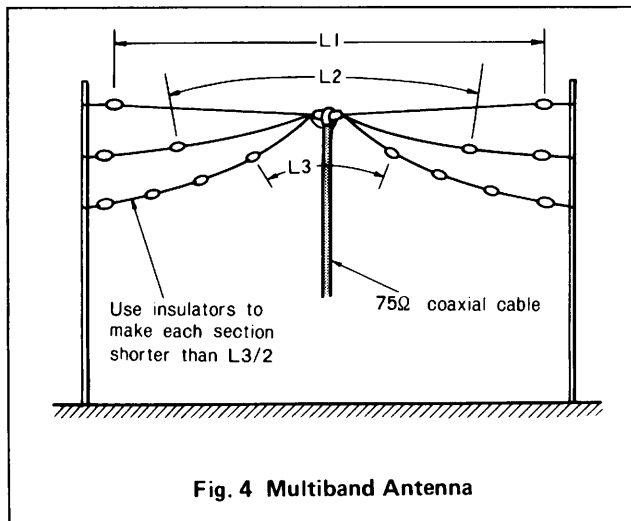

TRAP VERTICAL ANTENNA: (Fig. 5)

Antennas exclusively designed for BCL are not available from the market. These antennas may be built yourself. However, an antenna designed for ham band (3.5 ~ 28MHz or 7 ~ 14MHz) provides satisfactory reception of broadcast stations located in the vicinity of the band. Antenna of this type is most suitable for the listener who does not have an enough space for installation of a doublet antenna or a long wire antenna.

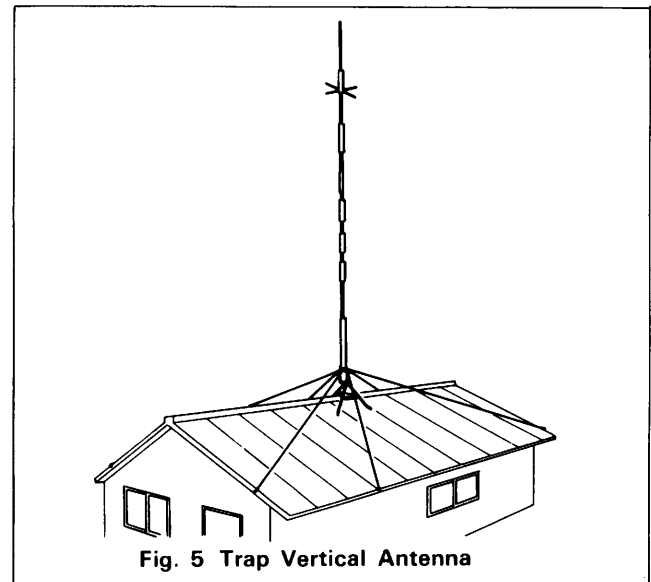

YAGI ANTENNA: (Fig. 6)

Use of YAGI antenna is best suited for reception of broadcast in a specific band. This antenna features excellent directivity; it provides high sensitivity and eliminates interference when it is properly installed.

YAGI antennas available from the market are designed only for ham band reception. For reception of BCL band, it is necessary for you to build a proper antenna yourself.

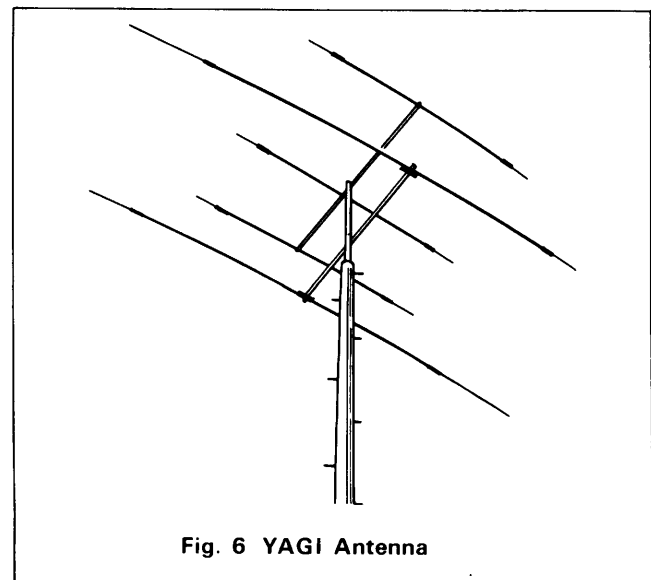

GROUNDING

Normally, the receiver operates without being grounded. However, grounding improves the efficiency of antenna such as a long-wire antenna. It is also effective because it eliminates inductive noise and protects the operator from electric shocks through AC line. To ground the receiver, use a copper or brass plate (or net or rod) connected to a copper wire and bury it in the ground about 1 ~ 7 feet (0.3 ~ 2.0 m) deep. A city water pipe (not vinyl type) may also be used for grounding. Never use a gas pipe for grounding purpose.

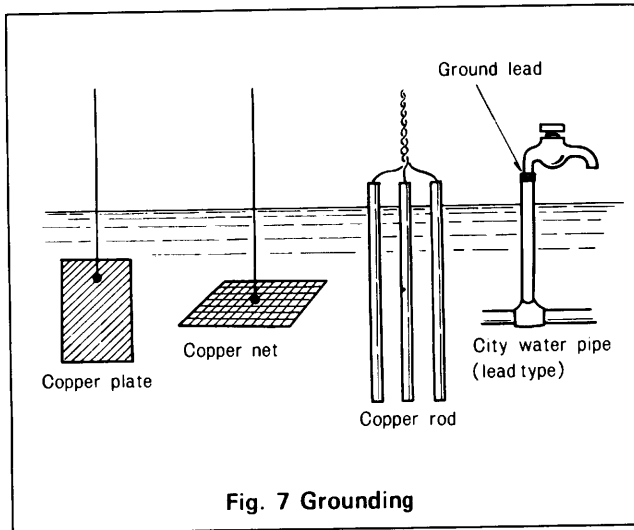
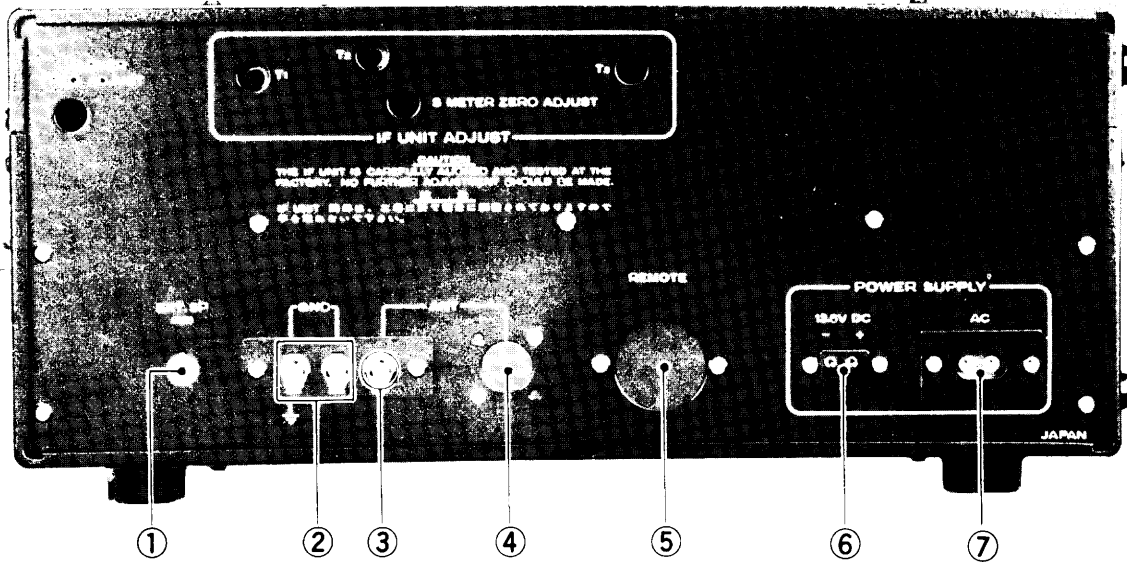
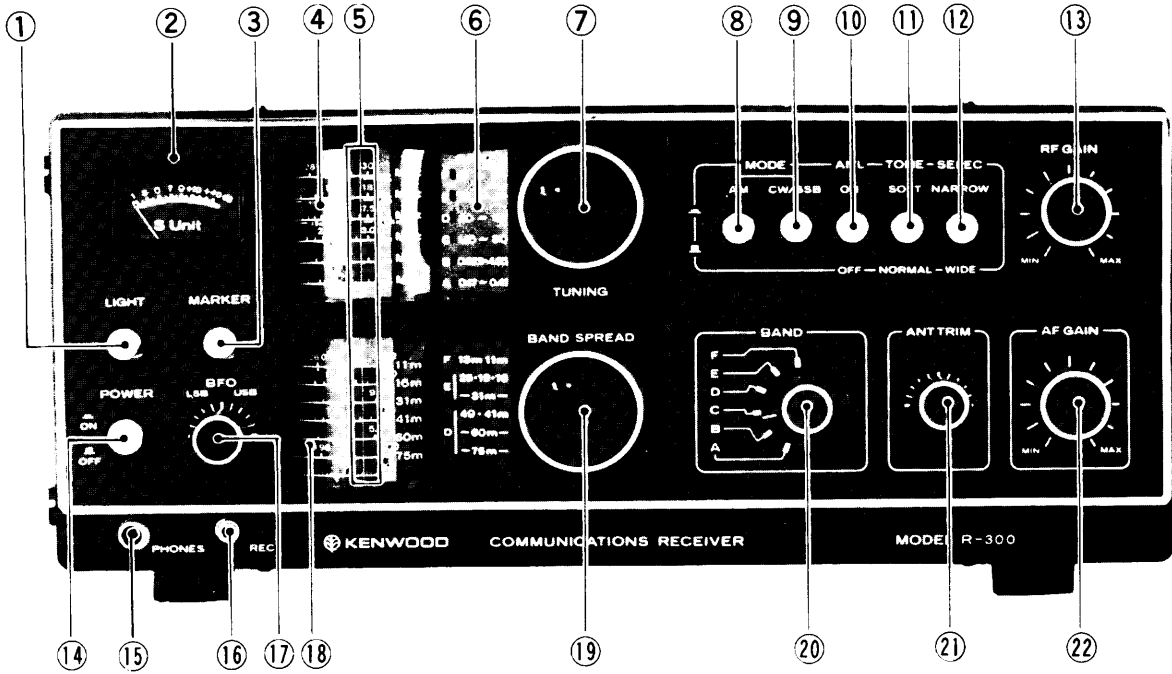

Fig. 7 Grounding

SECTION 2. OPERATING CONTROLS



2-1. FRONT PANEL CONTROLS

(1) LIGHT

By pressing this switch and holding it in that position, the lights in the dial and the S meter are illuminated during operation on internal batteries or external DC source. When the switch is pressed during internal battery operation, the lights glow dim to save the battery power.

(2) S Meter

The S meter shows received signal strength on a scale graduated in 1 to 9 and 9 to 9+40dB.

(3) MARKER

Turns on and off the 500kHz marker oscillator.

(4) TUNING Dial

Frequencies in A ~ F bands are indicated on MAIN TUNING dial.

(5) Dial Gauge

This gauge indicates correct frequencies.

(6) BAND Indicator

Interlocked with the band selector knob to indicate receiving bands.

(7) Main Tuning Knob

Turn this knob to tune in the desired frequency on the main tuning dial.

(8) AM

Push this button for reception of AM wave.

(9) CW/SSB

Push this button for reception of CW or SSB signals. BFO will be set to ON.

(10) AM ANL

Noise limiter for AM. It is used to eliminate pulse noise.

(11) TONE

NORMAL-SOFT selector switch to change tonal quality.

(12) SELEC

This WIDE-NARROW selector switch selects sensitivity.

At the NARROW position, IF band is narrowed to eliminate radio interference.

(13) RF GAIN

Turn this knob fully clockwise when the signal strength is normal. Turn it counterclockwise when the signal is too strong; the signal input will be reduced.

(14) POWER

Power ON/OFF switch for the receiver.

(15) PHONES

Connect a headphone (8Ω) and the speaker circuit will be disconnected.

(16) REC

For connection of tape recorder. The received signals are recorded through this jack.

(17) BFO

This knob is used to shift BFO frequency by 2.5kHz below or above the center frequency when the MODE switch is in CW position.

(18) BAND SPREAD Dial

This dial indicates frequencies of broadcast band or amateur radio band on a magnifying scale.

The picture shows the dial for broadcast band.

(19) Spread Dial Knob

Adjust this knob for the frequency indicated on the band spread dial.

(20) BAND SELECTOR

This selects the desired listening band among A ~ F bands.

(21) ANT TRM

Adjust this antenna trimmer for maximum deflection on S meter while receiving a signal.

(22) AF GAIN

Turn this knob clockwise to increase sound volume.

2-2. REAR PANEL CONTROLS

(1) EXT. SP

For connection of external speaker.

(2) GND

Connect an earth lead to this terminal.

(3) ANT (screw terminal)

For connection of antenna of 50 ~ 75Ω impedance.

(4) ANT (M type connector)

Connector (M type) can be mounted by use of this hole. When mounting, remove the cover plate (black).

(5) REMOTE

For mounting a REMOTE socket. Remove the cover plate (black) before mounting.

(6) 13.8V DC

An input terminal for external power supply of 12 ~ 15V, 0.5A or higher.

(7) AC

This is an AC power input terminal.

SECTION 3. OPERATING INSTRUCTIONS

3-1. POWER CONNECTION

AC Power

Plug in the AC cord supplied into the AC jack on the rear of the receiver.

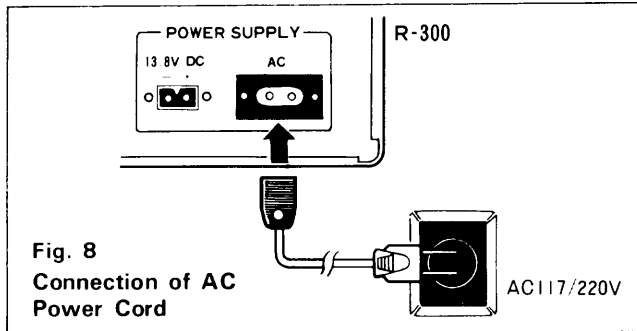

Fig. 8
Connection of AC
Power Cord

Internal Batteries

Install eight UM-1 batteries as shown in Fig. 9.

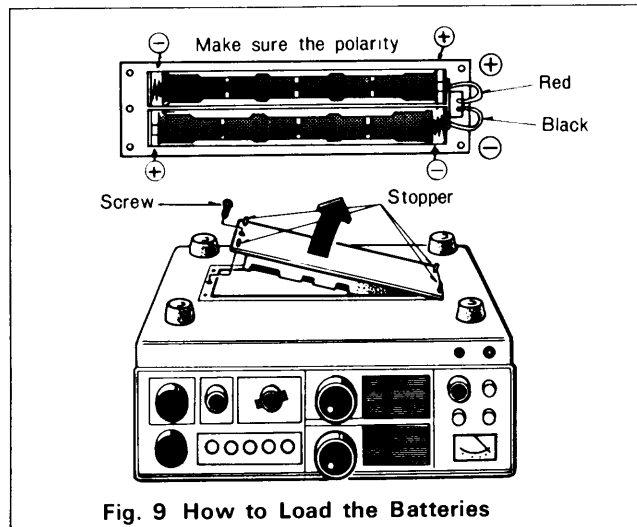

Fig. 9 How to Load the Batteries

External DC Source

For connection of DC power source such as car battery, use the supplied DC power cord.

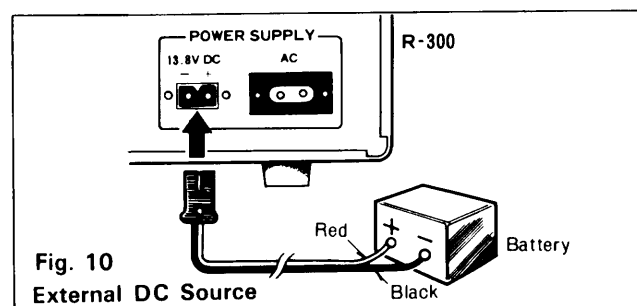

Fig. 10
External DC Source

LIGHT Switch:

The lamps in the dial and S meter will light as given in Table 1 below.

LIGHT switch POWER	ON	OFF	Remarks
AC power	Slightly dim	Normal	Lights at all times. LIGHT switch is not used.
Internal battery	Dim	Not lighted	Glow dim only when LIGHT switch is ON.
External DC source	Normal	Not lighted	Glow normally only when LIGHT switch is ON.

Table 1

NOTE:

1. AC power and external DC source are switched automatically.
2. Internal batteries are automatically switched on by removing AC power cord.

3-2. DIAL FREQUENCY READING

BAND SPREAD Dial

The BAND SPREAD Dial is graduated for either broadcast band frequencies or amateur radio band frequencies depending on the destination area where the receiver is shipped, as shown in Fig. 11.

The methods of using the broadcast band spread dial and receiving signals are described in the following paragraph. These methods also apply to the amateur band spread dial. The dial scale graduated from 0° to 100° can be used for reading both the broadcast and amateur band frequencies by referring to the above illustration; that is, amateur band frequencies can be read from the broadcast band spread dial, and vice versa.

Reading on TUNING Dial:

The TUNING dial scale indicates correct frequency when the BAND SPREAD dial is in the 100° position as shown in Fig. 12. In this example, the receive frequency is 900kHz.

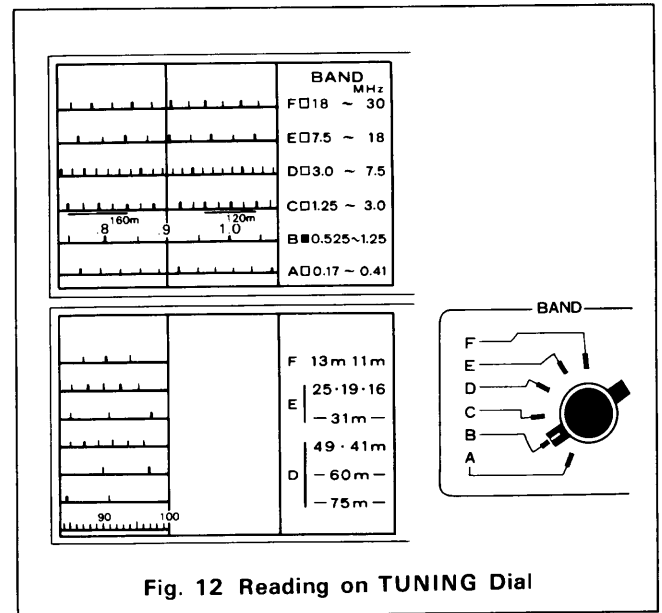

Fig. 12 Reading on TUNING Dial

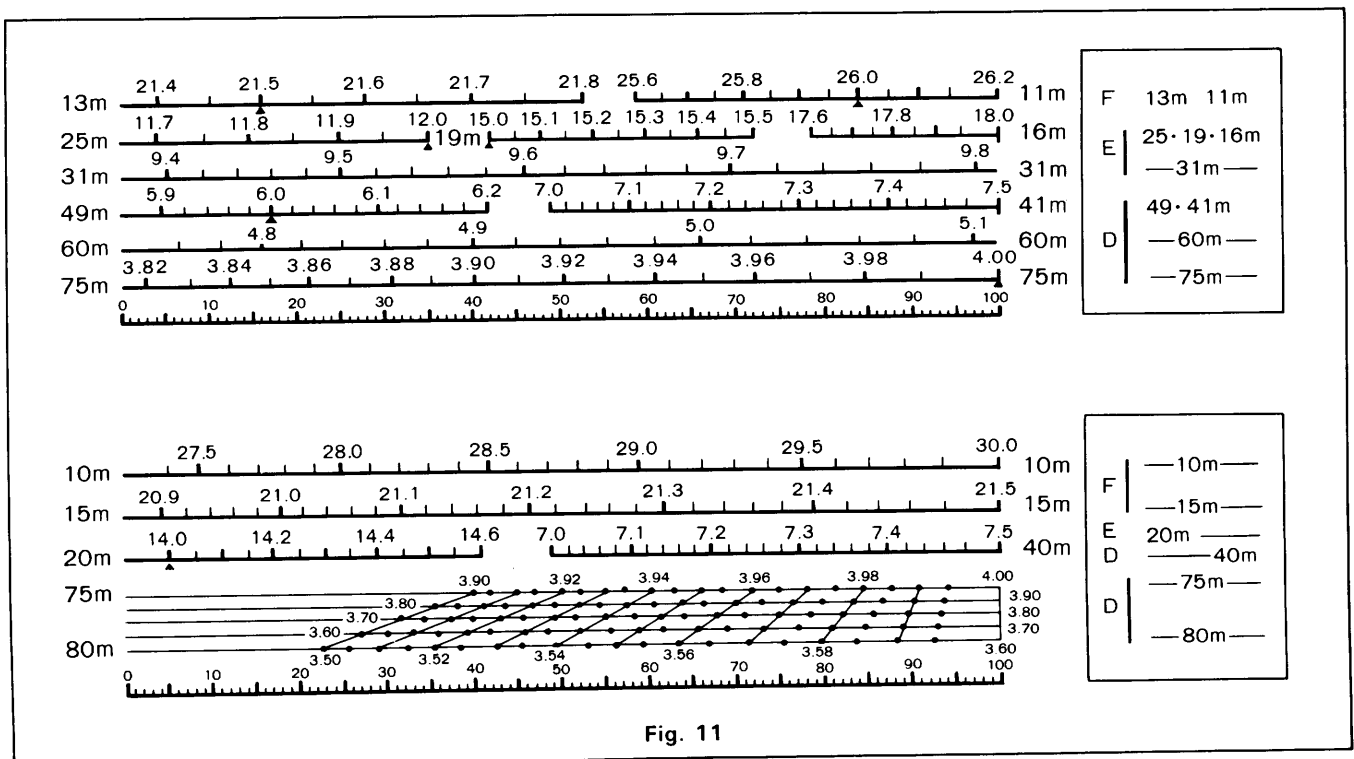

Fig. 11

Reading on BAND SPREAD Dial:

To read frequencies of each meter band on the BAND SPREAD dial, the meter band should be calibrated by using the marker.

1. Calibration of BAND SPREAD Dial Scale

Example: To calibrate 49m band, the receiver controls should be set as shown in Table 2 (see Fig. 13 and Table 2).

Front Panel:	
BAND	D
BAND SPREAD Dial	Triangle mark (▲) on 49m band
RF GAIN	MAX.
MODE	CW/SSB
AF GAIN	Set to suitable volume
MARKER	ON

Table 2

Then, turn the TUNING dial knob and set in the vicinity of the position marked 49m and a marker signal will be received. Adjust so that the S meter indicates maximum deflection. In this position of the TUNING dial, the 49m band scale on the BAND SPREAD dial indicates a correct frequency. Next, turn the MARKER switch to OFF. Without touching the TUNING dial, turn the BAND SPREAD dial. If a broadcast is received at the position shown in Fig.14, it means that the frequency of the broadcast signal is 6.1MHz.

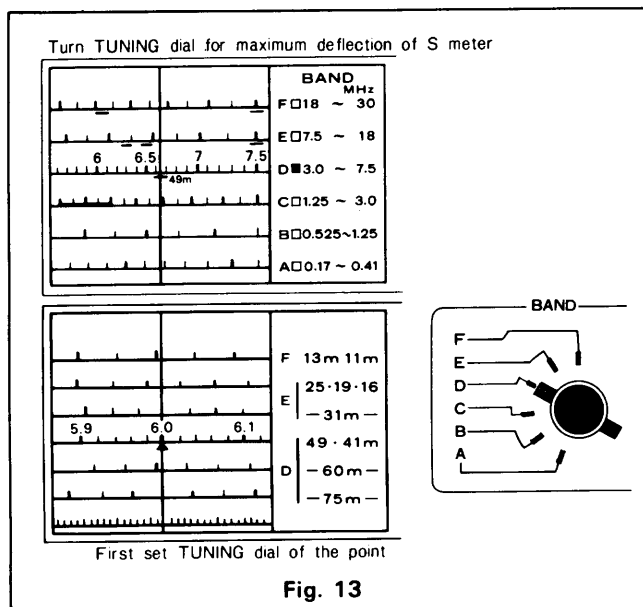
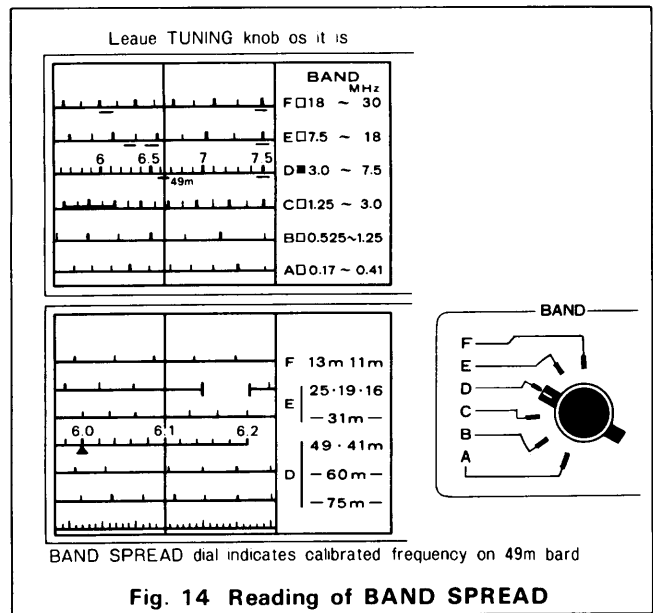

Fig. 13



2. 500kHz Marker Oscillator

Marker signals can be received at 500kHz intervals, from 500kHz to 1500kHz, 2000kHz ...

When calibrating with the antenna left connected, be sure to turn the MARKER switch on and off or turn the RF GAIN knob fully counterclockwise and then check the MARKER signal is received correctly. This eliminates the possibility of receiving broadcast signals. If several marker signals appear, use the largest one as your marker signal.

3-3. RECEPTION

Reception of LW and MW Broadcast

Signals in the A, B and C bands can be received by the TUNING dial alone. If you wish to receive 1MHz AM signals, set the control knobs of the receiver as shown in Table 3 below.

Front Panel:	
BAND	ON
MODE	AM
RF GAIN	MAX.
AF GAIN	Adjust for suitable volume.
MARKER	OFF
BAND SPREAD Dial	100°

Table 3

Then turn the TUNING knob to 1MHz on the dial while turning the ANT TRIM for maximum deflection of the S meter. If the signal is too strong and the sound is distorted. Turn the RF GAIN knob counterclockwise. If excessive noise (static noise, ignition noise, etc.) is heard, set the ANL switch to ON. This activates the noise limiter to reduce the noise. If radio interference is encountered, set the SELEC switch to the NARROW position and the receiving band-

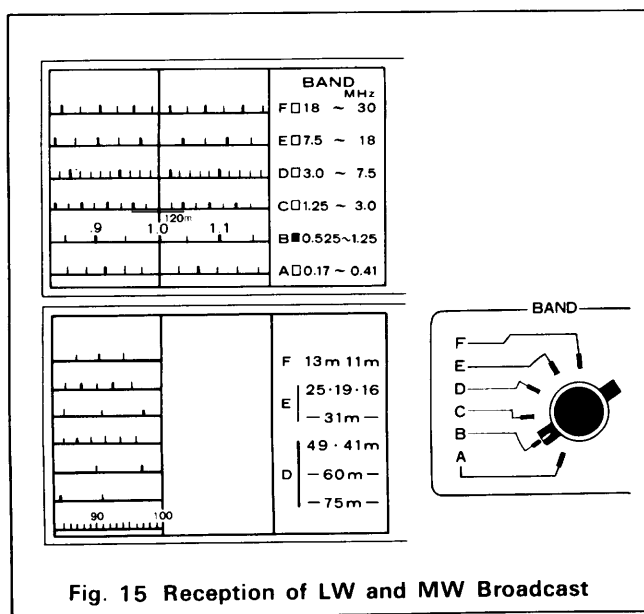

Fig. 15 Reception of LW and MW Broadcast

width is narrowed to improve the clarity of sound.

The tonal quality can be selected to suit your listening preference by setting the TONE switch to NORMAL or SOFT position. It may be set to the SOFT position to reduce noise and radio interference.

Reception of SW Broadcast

If you wish to receive 6MHz AM signals, set the control knobs of the receiver as shown in Table 4.

Front Panel:	
BAND	D
MODE	AM
RF GAIN	MAX.
AF GAIN	Adjust for suitable volume.
BAND SPREAD Dial	Set to the position marked ▲ on 49m band.
MARKER	ON

Table 4

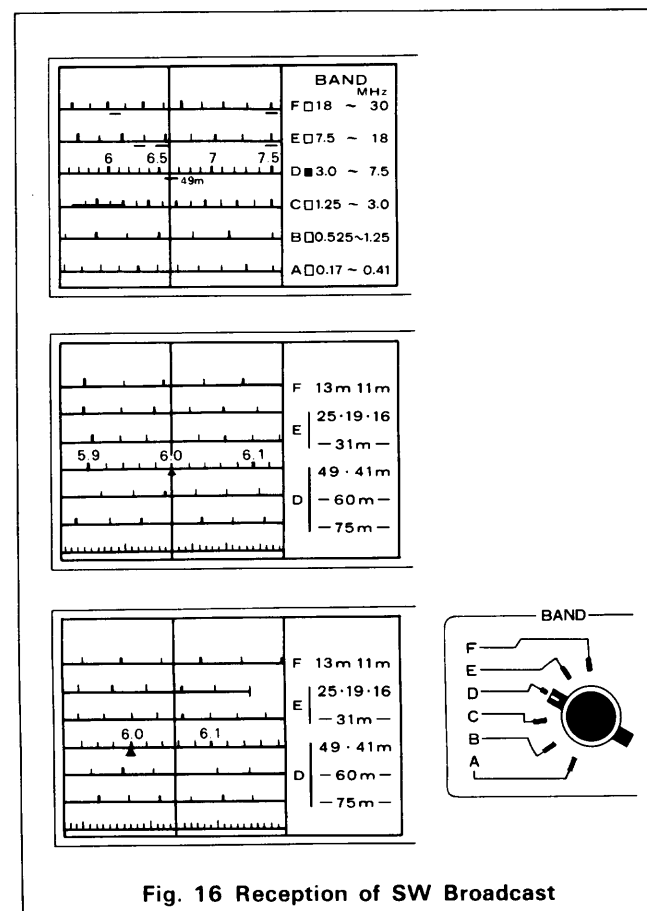

Fig. 16 Reception of SW Broadcast

then, turn the TUNING knob to 49m on the dial until a marker signal is received and the S meter indicates a maximum deflection. Next, set the MARKER switch to OFF and turn the BAND SPREAD dial knob to 6MHz on the scale. The 6MHz AM signal will now be received. Use the controls such as ANT TRIM, RF GAIN, ANL, SELEC and TONE in the same manner as described previously.

3-4. RECEIVING CW/SSB SIGNALS:

SSB signals are found in amateur radio band. With the MODE switch in AM position, these signals are heard unintelligibly while the S meter fluctuates.

CW signals are normally Morse code signals which can be received in the amateur radio band and other frequencies. For example, if you wish to receive SSB or CW signals in 7MHz amateur radio band, set the receiver controls as shown in Table 5.

Front Panel:	
BAND	D
MODE	CW/SSB
RF GAIN	MAX.
AF GAIN	Set to suitable volume.
BAND SPREAD dial	Triangle mark (▲) on 41m band
BFO	LSB for SSB reception Center position for CW reception

Table 5

Under such conditions, turn the TUNING dial and set it in the vicinity of the position marked 41m and the marker signal will be received. Adjust the TUNING dial so that the S meter indicates maximum deflection.

Then, turn the MARKER switch to OFF. Without touching the TUNING dial knob, set the BAND SPREAD dial to about 7.0MHz. You will now receive CW signals in amateur band.

By setting the dial to 7.05 ~ 7.1MHz (7.15 ~ 7.3MHz in area of U.S.A.), then SSB signals can be received. Adjust the BFO knob for maximum clarity. The methods of using ANT TRIM, RF GAIN, SELEC and TONE switches are the same as described in section "Receiving LW and MW Signals".

Note that the ANL switch has no effect on SSB and CW signals.

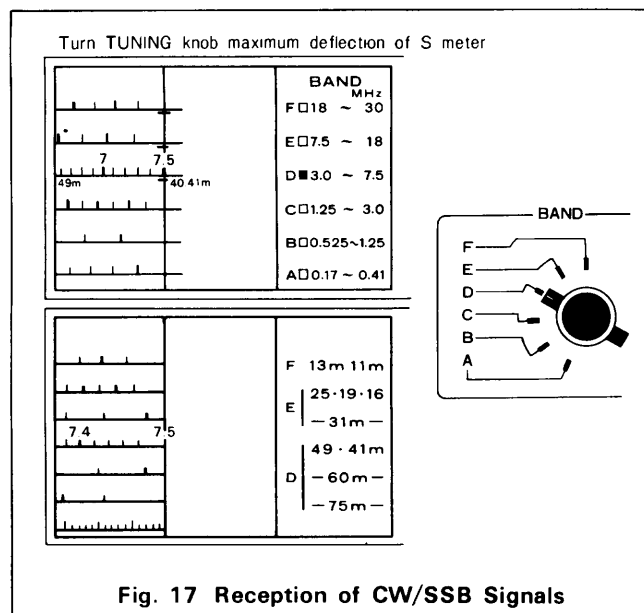

3-5. CONNECTORS AND THEIR USE

EXT. SP Terminal (Fig. 18)

If you wish to use an external speaker instead of the built-in speaker, connect a speaker of $4 \sim 8\Omega$ impedance to the EXT. SP terminal by using a 2P plug.

REC Jack (Fig. 18)

This is a line out jack for recording broadcast programs on tape. Use a small 2P plug for connection.

PHONES Jack (Fig. 18)

Connect your headphones to this jack using a 2P plug.

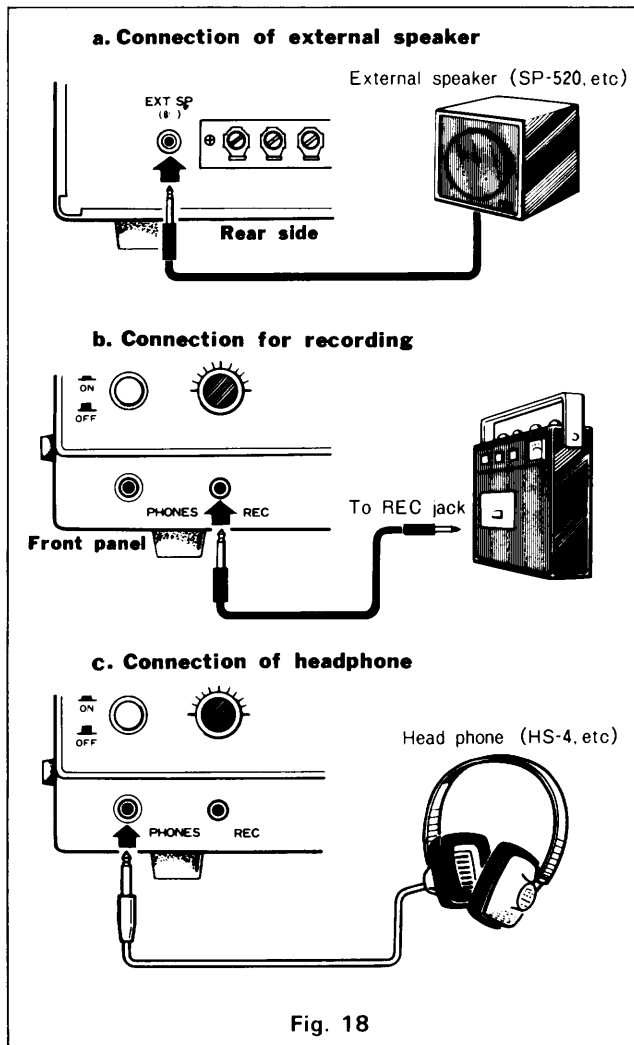

REMOTE Socket Mounting Hole

When R-300 is used as a sub-receiver for amateur radio station, mount a REMOTE socket (8P, US type) using this hole. This permits you to control the receiver remotely.

M Type Connector Mounting Hole (Fig. 19)

When you wish to use a standard type antenna, mount an M type antenna connector using this hole. Before connecting the antenna, the ANT terminals must be wired in parallel with the connector inside the chassis.

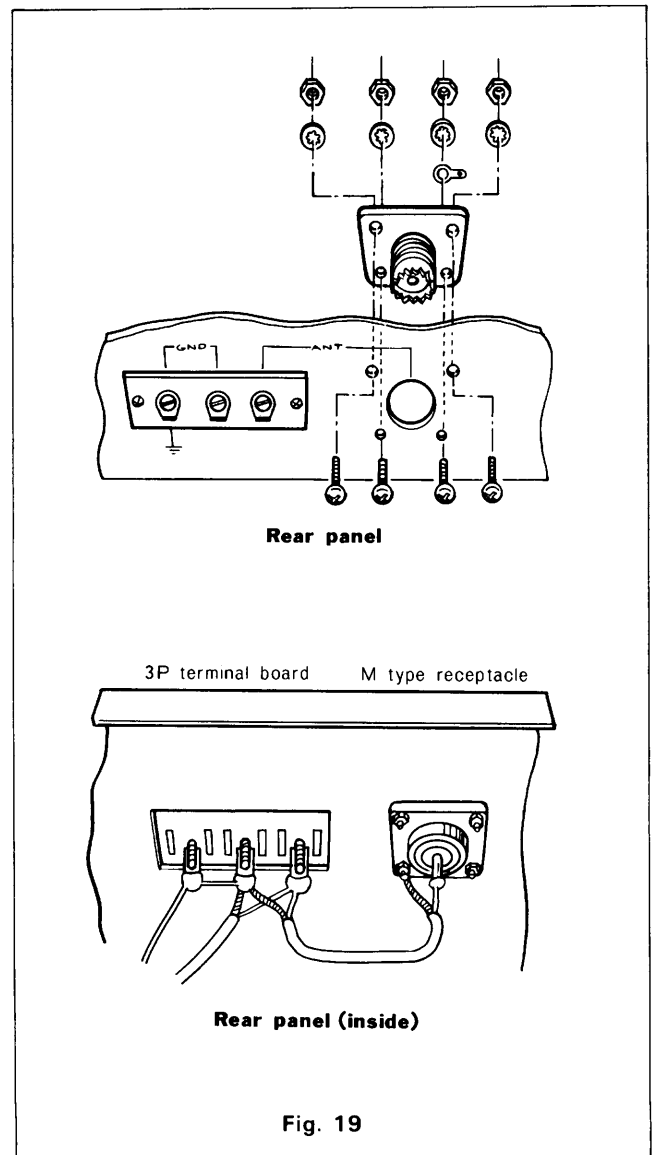

SECTION 4. CIRCUIT DESCRIPTION

4-1. RF UNIT (X44-1100-01)

The RF unit includes the RF amplifier for A through F bands, the 1st mixer, the IF amplifier (2nd mixer of F band) for A through E bands, and the F band local oscillator circuit. It also includes the 1st mixer output switching circuit, the bias switching circuit for IF amplifier and 2nd mixer, and the AGC circuit.

4-2. COIL PACK UNIT (X44-1110-00)

The coil pack consists of the input/output coils for the local oscillator circuit and the RF amplifier, and the rotary switch. The coils and the switch are neatly arranged on a printed circuit board and function in conjunction with the RF unit.

4-3. IF UNIT (X48-1160-00)

This unit is principally composed of the IF amplifier, the detector circuit and the BFO circuit. It also includes an AGC detector circuit and an S meter circuit.

4-4. SWITCHING UNIT (X41-1090-00)

This unit incorporates the MODE selector circuit and the AF amplifier together with the sensitivity switching circuit, the TONE circuit and the ANL circuit.

4-5. AF/PS UNIT (X49-1090-00)

The AF unit amplifies the AF signal voltage fed from the switching unit, and its power to the level necessary to drive the speaker. The PS unit is provided with a rectifier circuit to obtain DC14V and a 9V power supply stabilizer.

4-6. MARKER UNIT (X52-1060-00)

This unit produces 500kHz marker signal for frequency calibration.

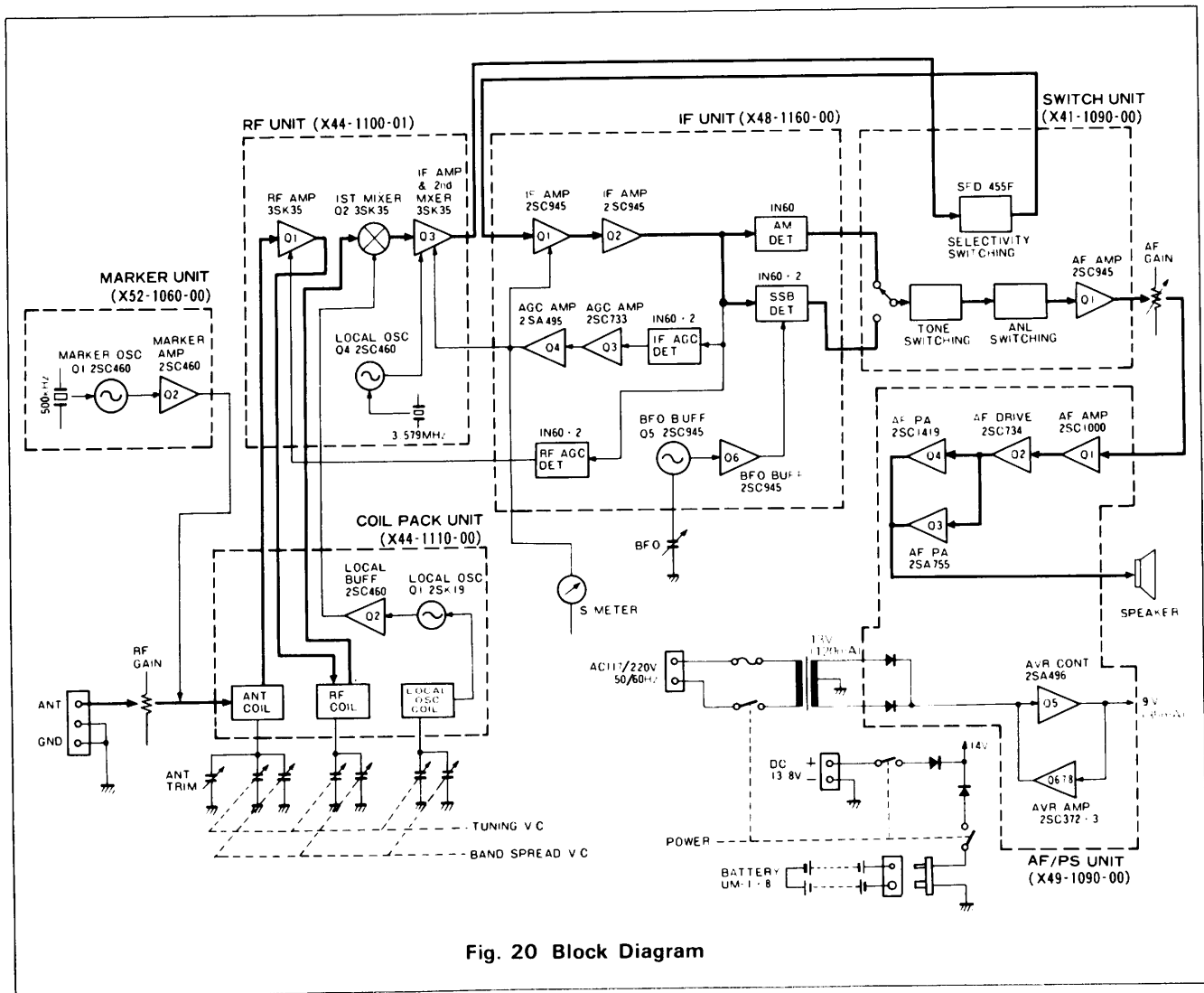

Fig. 20 Block Diagram

SECTION 5. MAINTENANCE AND ALIGNMENT

5-1. REMOVING THE CABINET

Remove the 8 screws holding the upper case and the 13 screws holding the lower case. When removing, be very careful not to break the battery cord provided on the lower case.

5-2. FUSE

Fuses are located inside the cabinet. When a fuse blows out, check the cause of it and replace with a new one. The following fuses are used in the receiver:

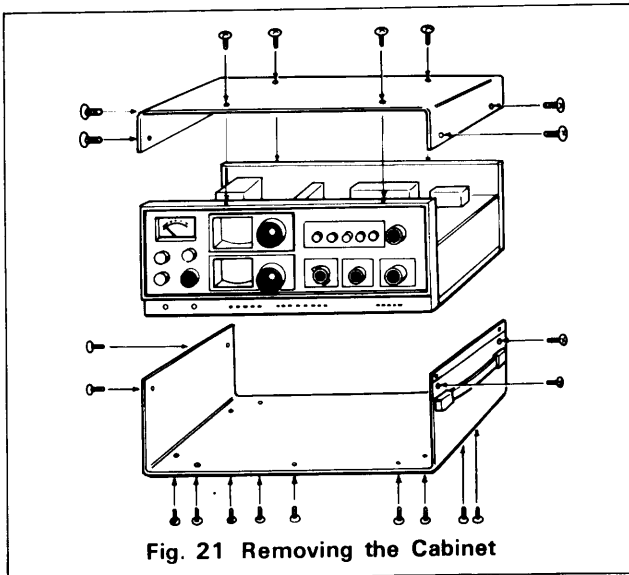

Fig. 21 Removing the Cabinet

5-3. SERVICE POSITION (Fig. 22)

When adjusting coils and dial tracking of R-300, place a stand under the receiver (or equipment) as shown in Fig. 22 for facilitated work. For adjustment of the coil pack, remove the battery case.

The IF unit can be adjusted through the adjusting hole on the rear panel.

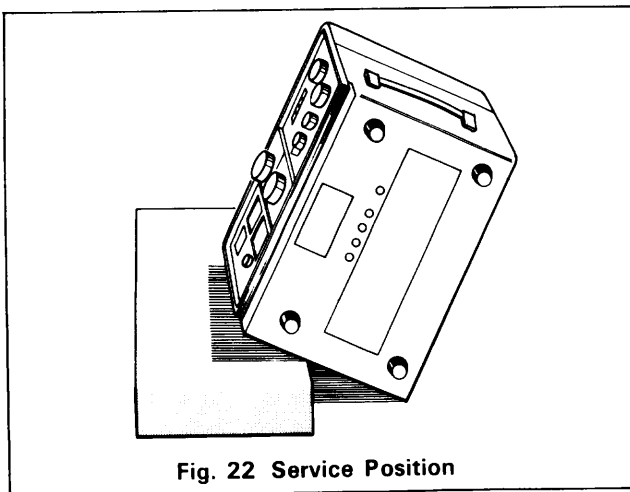

Fig. 22 Service Position

5-4. PRELIMINARY SETTINGS FOR ADJUSTMENT

1. For accurate adjustments, use a test oscillator or signal generator capable of amplitude modulation in 170 kHz ~ 30 MHz. The adjustments can also be made with the 500kHz marker generator, a dip meter or broadcast signal of known frequency.
2. Control Settings:
BAND SPREAD: Fully clockwise ("100" position on 100° scale)
RF GAIN: Fully clockwise
AF GAIN: Fully counterclockwise
ANT TRM: Extreme right
BAND SELECTOR: A
FUNCTION: AM PUSH ON
SELECTIVITY: PUSH NARROW

BFO PITCH: Center position
POWER: OFF
3. Connect AC cord and turn on POWER switches of the receiver and signal generator. Warm up the equipment for about 5 ~ 30 minutes.
4. Prepare alignment tool and a small, flat blade screwdriver.

5-5. ADJUSTMENT WITH SIGNAL GENERATOR

1. Set the signal generator in 400 Hz or 1,000 Hz, 30% amplitude modulation (modulation frequency and modulation degree may not necessarily be accurate).
2. Turn AF GAIN knob clockwise until noise is heard from the receiver, then proceed to adjustments in the following table:
3. For adjustment, use the S meter and obtain a peak point of received signal. Set the output of the signal generator so that the S meter indicates about "S9", making sure that the receiver is not overloaded.
4. Do not move or turn the coils, trimmers and capacitor excessively. If a tuning point can not be obtained by slightly moving of these adjusting parts, it is an indication that something is wrong with the receiver.

Frequency signal generator	Band selector	Tuning dial frequency	Position of ANT TRM	Process	Location to be adjusted (A method of obtaining a peak point of S-meter)	Remarks
190 kHz	A	190 kHz	Full rightward	1	Rotate the core of A-band OSC coil until any signal can be heard. (L13)	455 kHz IFT
				2	Core of A-band ANT coil (L1)	
				3	Core of A-band RF coil (L7)	
				4	Core of RF unit T1	
				5	Core of RF unit T4	
				6	Core of IF unit T1	
				7	Core of IF unit T2	
380 kHz	A	380 kHz	Full rightward	8	Rotate the trimmer capacitor of A-band OSC until any signal can be heard. (TC7)	
				9	Trimmer capacitor of A-band RF (TC1)	
190 kHz and 380 kHz	A	190 kHz and 380 kHz	Full rightward	10	Repeat the processes 1 ~ 3, 8 and 9 until the frequency of SG coincides with that of dial and the maximum signal can be obtained.	
600 kHz	B	600 kHz	Full rightward	11	Rotate the core of B-band OSC coil until any signal can be heard. (L14)	
				12	Core of B-band ANT coil (L2)	
				13	Core of B-band RF coil (L8)	
1.200 kHz	B	1.200 kHz	Full rightward	14	Rotate the trimmer capacitor of B-band OSC until any signal can be heard. (TC8)	
				15	Trimmer capacitor of B-band RF (TC2)	
600 kHz and 1.200 kHz	B	600 kHz and 1.200 kHz	Full rightward	16	Repeat the processes 11 ~ 15 in this order until the frequency of SG coincides with that of dial and the maximum signals can be obtained.	
1.3 MHz	C	1.3 MHz	Center	17	Rotate the core of C-band OSC coil until any signal can be heard. (L15)	
				18	Core of C-band ANT coil (L3)	
				19	Core of C-band RF coil (L9)	
2.8 MHz	C	2.8 MHz	Center	20	Rotate the trimmer capacitor of C-band OSC until any signal can be heard. (TC9)	
				21	C-band RF trimmer capacitor (TC3)	
			Refer to right column	22	It should be understood to be normal if the peak of S-meter can be obtained within the range of scale by rotating the ANT TRM.	When any peak can not be obtained, repeat the same adjustment after shifting the ANT TRM leftward by one of two scales from the center in the process 18*

Frequency signal generator	Band selector	Tuning dial frequency	Position of ANT TRM	Process	Location to be adjusted (A method of obtaining a peak point of S-meter)	Remarks
1.3 MHz and 2.8 MHz	C	1.3 MHz and 2.8 MHz		23	Repeat the processes 17 ~ 22 in the ascending order until the frequency of SG coincides with that of dial and the maximum signal can be obtained.	
3.4 MHz	D	3.4 MHz	2nd scale from the center (Leftward)	24	Rotate the core of D-band OSC coil until any signal can be heard. (L16)	
				25	Core of D-band ANT coil (L4)	
				26	Core of D-band RF coil (L10)	
7.0 MHz	D	7.0 MHz	2nd scale from the center (Leftward)	27	Rotate the trimmer capacitor of D-band OSC until any signal can be heard. (TC10)	
				28	D-band RF trimmer capacitor. (TC4)	
			Refer to right column	29	It should be understood to be normal if the peak of S-meter can be obtained by rotating the ANT TRM within the range of scale.	
3.4 MHz and 7.0 MHz	D	3.4 MHz and 7.0 MHz		30	Repeat the processes 24 ~ 29 in the ascending order until the frequency of SG coincides with that of dial and the maximum signal can be obtained.	
8.0 MHz	E	8.0 MHz	Center	31	Rotate the core of E-band OSC coil until any signal can be heard. (L17)	When the dial of receiver is adjusted to the SG signal of 17 MHz, the dial may be tuned at two points. It should be noted that the higher point is resulted from the real signal, but the lower point is resulted from an image signal.
				32	Core of E-band ANT coil (L5)	
				33	Core of E-band RF coil (L11)	
17.0 MHz	E	17.0 MHz	Center	34	Rotate the trimmer capacitor of E-band OSC until any signal can be heard. (TC11)	
				35	E-band RF trimmer capacitor (TC5)	
17.0 MHz	E	17.0 MHz	Refer to right column	36	It should be understood to be normal if the peak of S-meter can be obtained within the range of scale.	When any peak can not be obtained, repeat the same adjustment after shifting the ANT TRM leftward further more in the process 32.
8.0 MHz and 17.0 MHz	E	8.0 MHz and 17.0 MHz		37	Repeat the processes 31 ~ 36 in the ascending order until the frequency of SG coincides with that of dial and the maximum signal can be obtained.	
19 MHz	F	19 MHz	Center	38	Rotate the core of F-band OSC coil until any signal can be heard. (L18)	When the dial of receiver is adjusted to the SG signal of 29 MHz, the dial may be tuned at two points if the SG signal is too strong. It should be noted that the higher point is resulted from the real signal, but the lower point is resulted from an image signal.
				39	Core of F-band ANT coil (L6)	
				40	Core of F-band RF coil (L12)	
				41	Core of RF unit T2 (4.034 MHz IFT)	
29 MHz	F	29 MHz	Center	42	Rotate the trimmer capacitor of F-band OSC until any signal can be heard. (TC12)	
				43	F-band RF trimmer capacitor (TC6)	

Frequency signal generator	Band selector	Tuning dial frequency	Position of ANT TRM	Process	Location to be adjusted (A method of obtaining a peak point to S-meter)	Remarks
29 MHz	F	29 MHz	Refer to right column	44	It should be understood to be normal if the peak of S-meter can be obtained within the range of scale.	When any peak can not be obtained, repeat the same adjustment after shifting the ANT TRM leftward further more in the process 38.
19 MHz and 29 MHz	F	19 MHz and 29 MHz		45	Repeat the processes 38 ~ 40, 42 ~ 44 in the ascending order until the frequency of SG coincides with that of dial and the maximum signal can be obtained.	

5-6. ADJUSTMENT WITH MARKER GENERATOR OR BROADCAST SIGNAL

For adjustment, the 500 kHz marker generator may be used instead of SG. The generator may be calibrated using standard frequencies (2.5 MHz, 5 MHz, 10 MHz, 15 MHz, etc.) of WWV or the like to ensure accurate adjustments.

Adjustments with broadcast signals are also possible. In this case, receive a broadcast of known frequency and adjust the dial setting to the frequency.

5-7. BFO ADJUSTMENT

Adjustment of BFO frequency can be made in the following manner:

1. Receive a signal and set the S meter to maximum deflection.
2. Set FUNCTION to CW/SSB and BFO PITCH knob to the center position.
3. Adjust the core of T3 "IF UNIT COIL ADJUST" until zero-beat is obtained.
4. Turn BFO PITCH knob clockwise and counterclockwise to check that a beat of the same tone is heard. Now the adjustment is completed.

5-8. DIAL CORD STRINGING

For replacement of the dial cord, refer to Fig. 23.

When the dial cord is to be replaced, be sure to use the specified dial cord to prevent slipping or back-lash.

1. Cut a dial cord of 3.54 feet (1.08 m) for the main dial, and 3.87 feet (1.18 m) for the spread dial. The dial cord must be free of kinks.
2. With the dial pulley turned fully clockwise, tie the end of the dial cord to the spring (see illustration "A"). Pull the spring and hook it on the boss of the pulley.
3. Wind the longer end of the dial cord a half turn in the clockwise direction around the pulley. Then wind the cord 2 turns around the dial drum and as many turns around the pulley according to the numerical order (see Fig. 23). Tie the shorter end of the dial cord to the other end. (see illustration "B").
4. Remove the spring from the boss of the pulley, correct the tension of the cord and adjust the scale of the dial drum for correct setting.

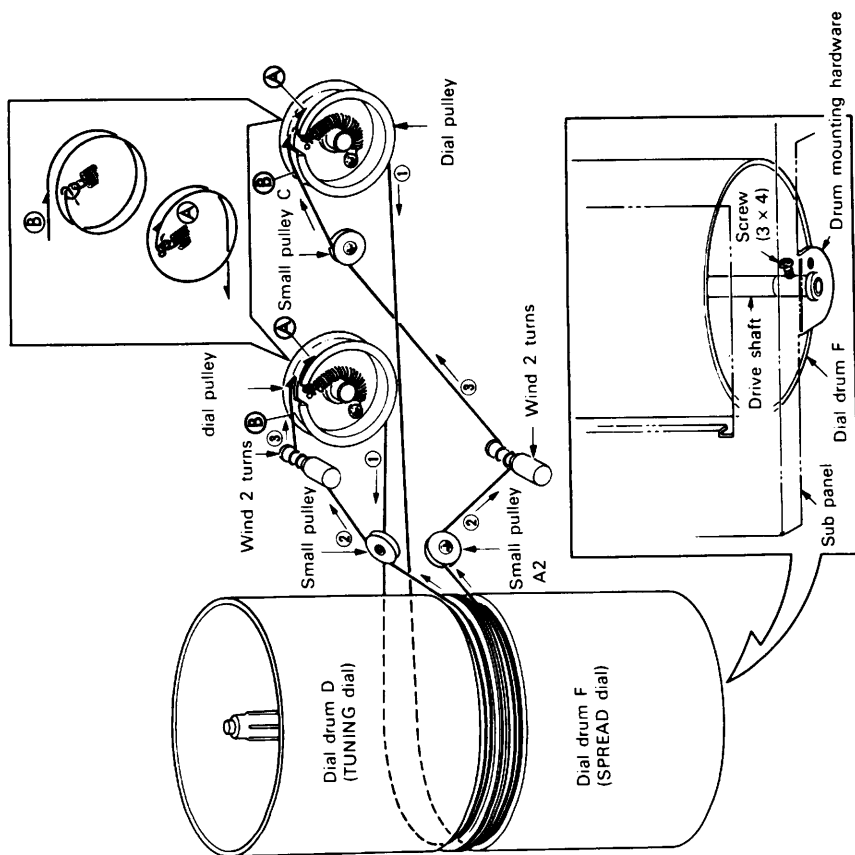

TUNING and SPREAD DIAL

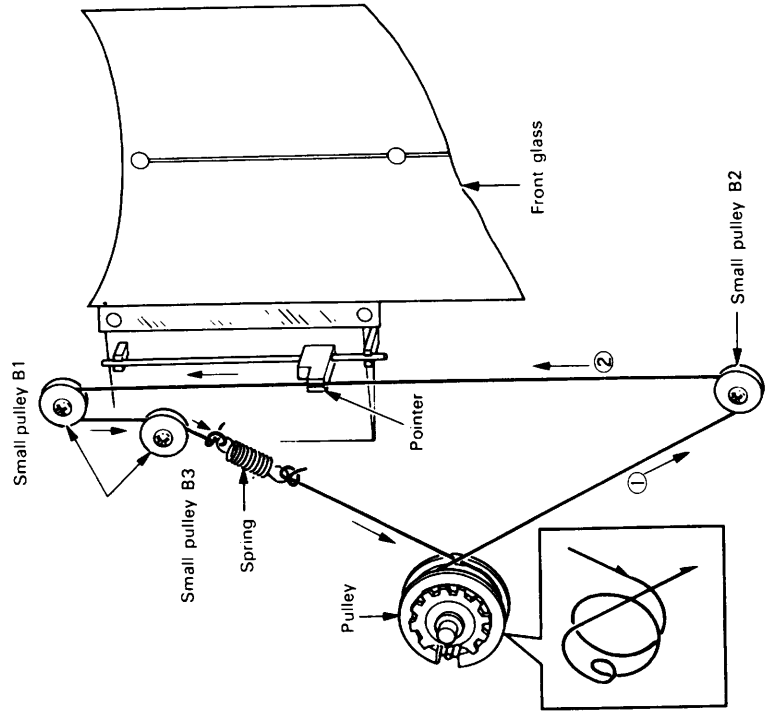
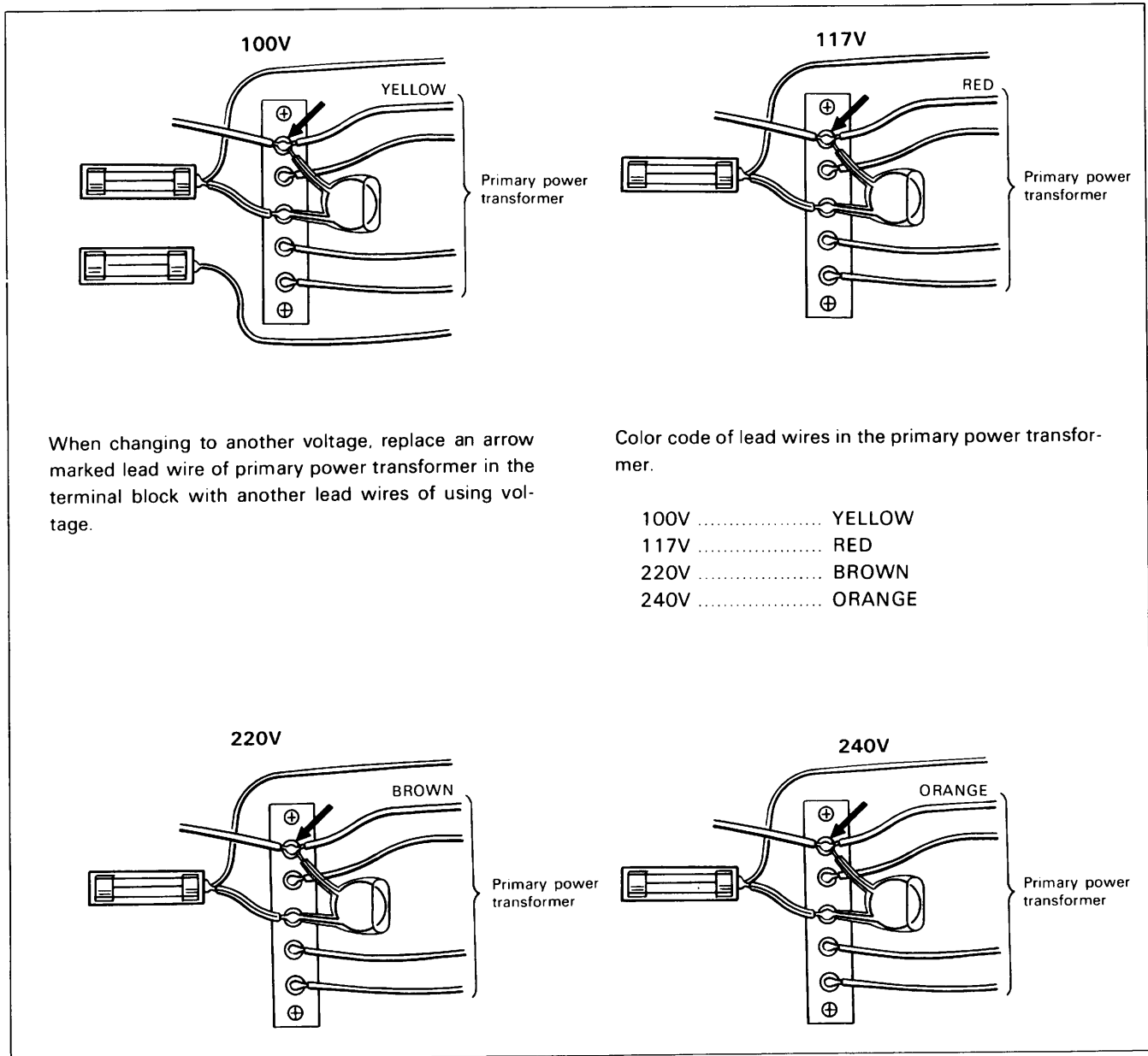

Fig. 23

5-9. POWER VOLTAGE SETTING

Your R-300 is preset to operate on 117V or 220V AC power before shipment. If the receiver is to be operated on any

other line voltage, change the connection of the wiring according to the instructions given in Fig. 24.



5-10. REPLACEMENT PARTS

The transistors in R-300 can easily be damaged by being shorted or shocked by metallic tools. Be very careful during service operations, and when possible, use insulated tools. Be sure to use replacement parts of equal or better ratings when servicing the receiver. When ordering replacement or spare parts for your equipment, be sure to specify the following information:

Model number and serial number of the equipment — Schematic number of the part — and the printed circuit board number on which the part is located. Should it ever be necessary to return the equipment for repair, be sure to pack it very care fully and include a full description of the problems involved.

SECTION 6. ENJOYING SW RECEPTION

ENJOYING SW RECEPTION

Every country in the world has broadcast stations, and most of countries have amateur radio stations. The earth is virtually surrounded by innumerable radio waves, providing us with various information and news. Your R-300 catches every one of these radio waves.

The radio waves used for broadcast spread in a wide range of frequencies including long-wave (LF), middle-wave (MF), short-wave (HF) and ultra-short-wave (VHF) frequencies. Since short-wave signals have a characteristic so that they

travel around the earth, it is fun receiving exciting news and exotic music from overseas broadcast stations or amateur radio stations. It is also fun communicating with reception cards or verification cards among BCL (broadcasting listeners). To ensure maximum enjoyment of short-wave reception, it is important to know the features of short-wave signals as to how the signals travel around the earth, the method of receiving signals most effectively, the method of locating the name of country broadcasting programs, etc.

	Frequency Band	Type of Radio Wave Propagation	
		Short-distance	Long-distance
VLF	Very Low Frequency (under 30kHz)	Surface wave	Ionospheric wave
LF	Low Frequency (30~300kHz)	Surface wave	Ionospheric wave
MF	Medium Frequency (300~3000kHz)	Surface wave	Ionospheric wave
HF	High Frequency (3~30MHz)	Ionospheric wave	Ionospheric wave
VHF	Very High Frequency (30~300MHz)	Surface wave	Tropospheric scatter wave or ionospheric scatter wave
UHF	Ultra High Frequency (300~3000MHz)	Direct wave or ground wave	Tropospheric scatter wave
SHF	Super High Frequency (3~30GHz)	Direct wave	Tropospheric scatter wave
EHF	Extremely High Frequency (30~300GHz)	Direct wave	

Table 6

Propagation of Radio Waves (SW signals travel through ionized layer)

The earth is surrounded by the atmosphere. The atmospheric molecules existing in the zone 50km ~ 500km above the earth collide with corpuscles containing ultraviolet rays and electricity emitted from the sun, and a layer crowded with electrons and ions is formed. This layer is called the ionized layer which has a characteristic to reflect radio waves.

Radio waves emitted into the air from the antenna of a broadcast station can be classified into the surface waves and the ionospheric waves by the propagation directions of radio waves. The surface waves travel along the earth

directly or indirectly, which are mainly used for medium frequency broadcast, TV and FM broadcast. The ionospheric waves travel a long distance because they are reflected repeatedly between the ionized layer and the earth. A short-wave broadcast use the ionospheric waves, their signals easily reach the rear side of the earth. The surface wave tend to become weak if the frequency is high and the short-wave frequencies therefore travel only a short distance, while the ionospheric waves become less weak as the frequency is higher, and travel a long distance with a small power because their jumping distance is very long when they are reflected between the ionized layer and the earth.

Ultra high frequencies pass through the ionized layer, thus the service area is limited to a short distance which offers an unobstructed view from the antenna.

The ionized layer is divided into 3 sub-layers of D, E and F as shown in the illustration, as the electron density in the layer is increased in step forms according to the distance from the sun. High frequency waves are reflected by the F layer so they travel a long distance.

The state of the ionized layer is closely concerned with the relative positions of the sun and the earth and also with the activity of the sun. The D and E layers almost disappear at

night, while the F layer changes in height and density depending on daytime and night time, which largely changes the upper limit of frequency to be reflected.

Such a phenomenon also occurs with changes in seasons or rotation cycle of the sun as well as unusual activities of the sun (change in the sunspot at every 11 years, unexpected explosion of the sun, etc.). To cope with this, international short-wave broadcast stations change their frequencies according to seasons or directions of radio waves, or use different frequencies at the same time for broadcasting the same program.

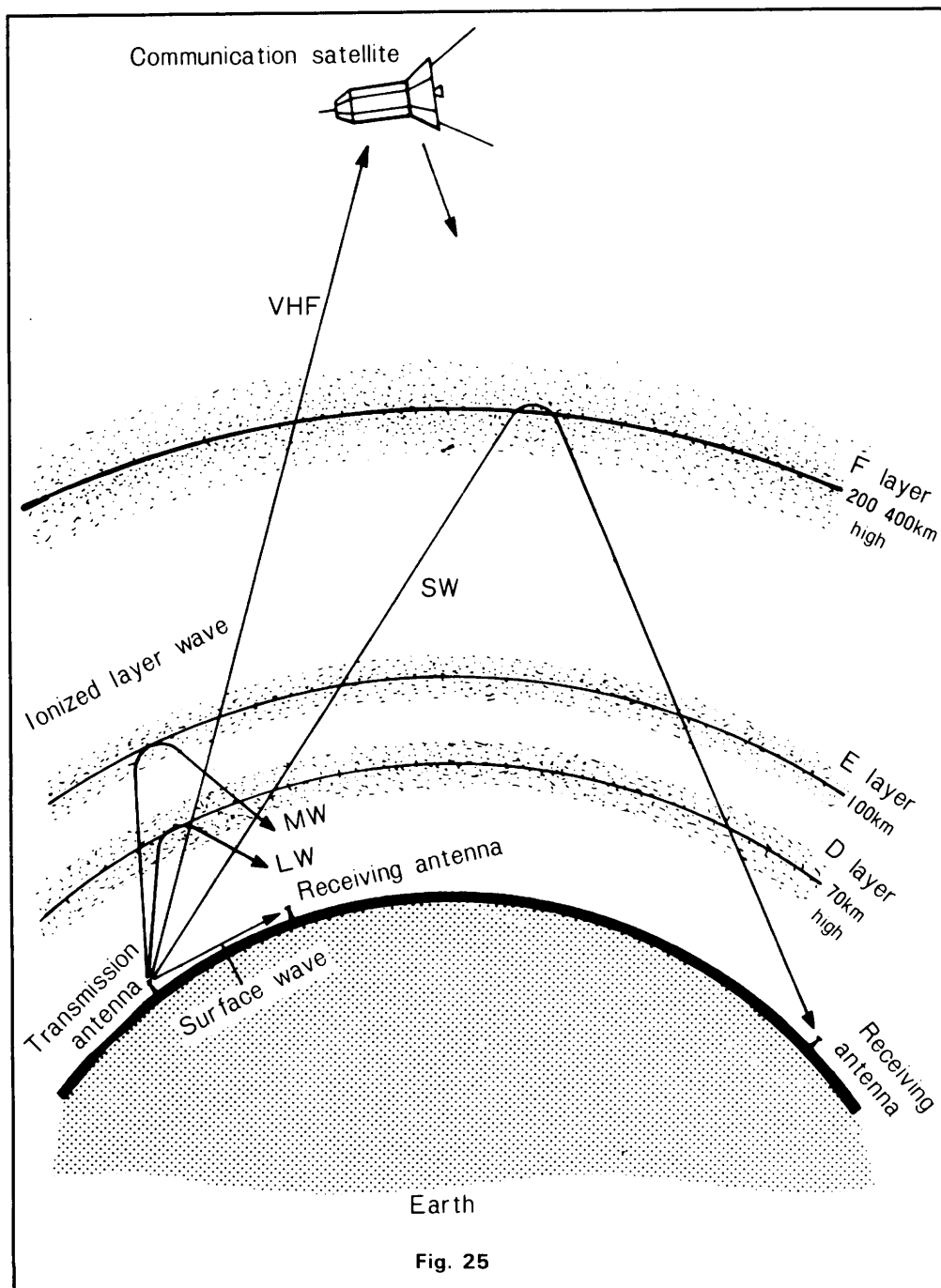

Frequency Distribution in Broadcast Band and Amateur Band The R-300 receiver covers a wide frequency range extending from 170kHz to 30MHz, while the frequency distributions in broadcast bands and amateur bands are internationally determined.

As shown in the Frequency Allocation Diagram at left, the frequencies of broadcast and amateur radio stations are allocated in specific bands expressed in mega-cycle (MHz) or wave-length (m). In Fig. 23, the frequencies of "other stations" are used for fixed stations for business use, marine

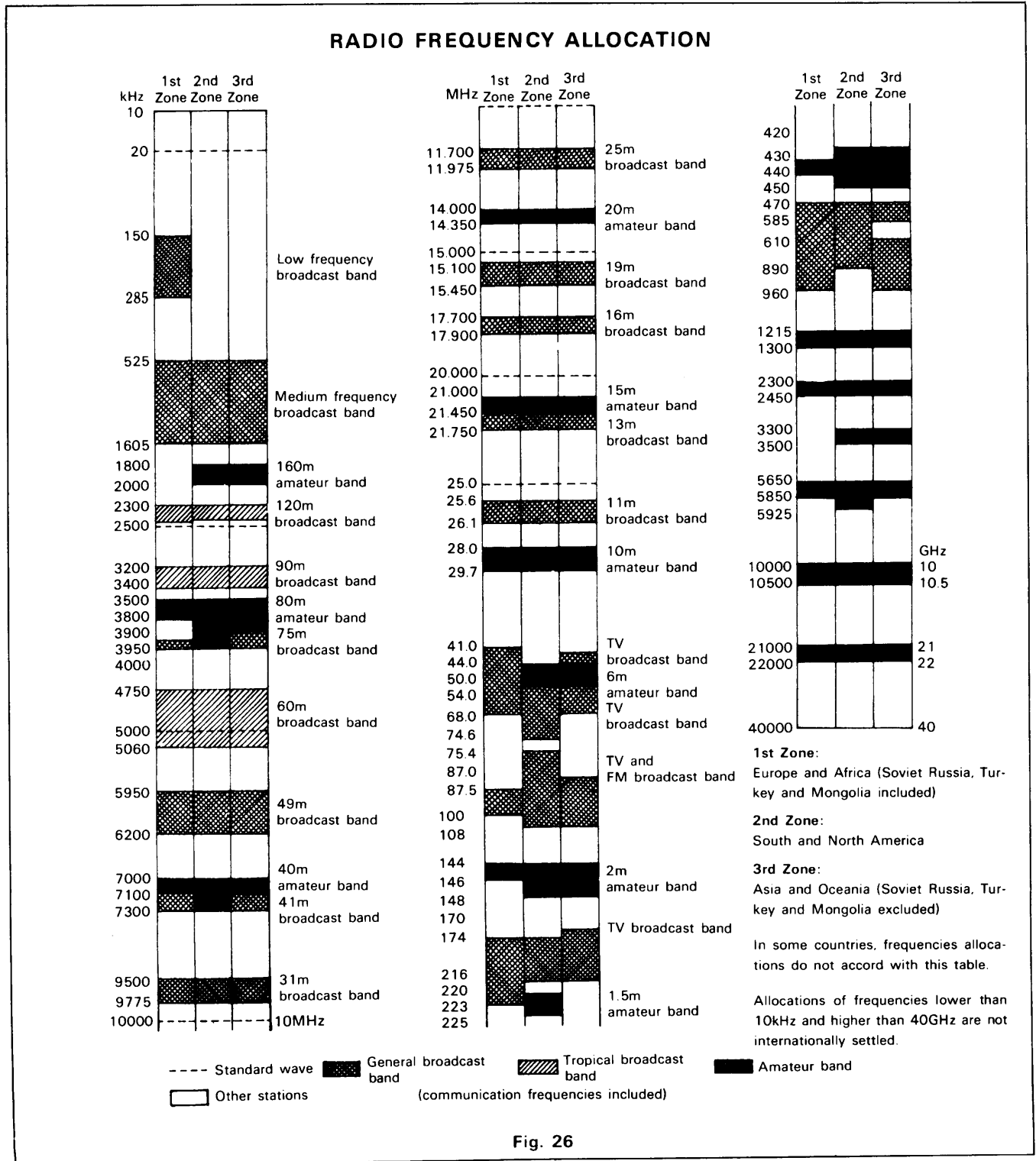

mobile stations, aviation mobile stations, land mobile stations, radio beacon stations, etc. Since the R-300 receiver uses a band spread system, the frequencies of SW broadcast bands and amateur bands are magnified on the BAND SPREAD dial for easier tuning to stations. There is the following relationship between frequency and wave length:

$$\begin{aligned}\text{Wave-length(m)} &= \frac{300}{\text{Frequency (MHz)}} \\ &= \frac{300000}{\text{Frequency (kHz)}}\end{aligned}$$

$$\text{Frequency (MHz)} = \frac{300}{\text{Wave length (m)}}$$

As will be understood from this relationship, the 31m band and 9MHz band, for example, are the same in terms of broadcast band, and are located in the range of 9500kHz to 9775kHz on the dial. It should be noted that some bands do not exactly correspond to the frequency range on the dial but minor differences between band frequencies and frequency range on the dial are customarily disregarded.

NOTE

SPECIFICATIONS

FREQUENCY RANGE

BAND A	170 ~ 410 kHz
BAND B	525 ~ 1250 kHz
BAND C	1.25 ~ 3.0 MHz
BAND D	3.0 ~ 7.5 MHz
BAND E	7.5 ~ 18.0 MHz
BAND F	18.0 ~ 30 MHz

BAND SPREAD

(different depending on the destination area)

Short wave bands:

75 m	3.82 ~ 4.0 MHz
60 m	4.75 ~ 5.1 MHz
49 m	5.9 ~ 6.2 MHz
41 m	7.0 ~ 7.5 MHz
31 m	9.4 ~ 9.8 MHz
25 m	11.7 ~ 12.0 MHz
19 m	15.0 ~ 15.5 MHz
16 m	17.6 ~ 18.0 MHz
13 m	21.4 ~ 21.8 MHz
11 m	25.6 ~ 26.2 MHz

Ham bands

80 m and 75 m	3.5 ~ 4.0MHz
40 m	7 ~ 7.5MHz
20 m	14 ~ 14.6MHz
15 m	21 ~ 21.5MHz
10 m	28 ~ 30MHz

MODE AM, SSB, CW

SENSITIVITY (S+N)/N, 10 dB at 50mW/8Ω

		AM	SSB
BAND A	280 kHz	Better than 1μV	Better than 0.3μV
BAND B	900 kHz	Better than 1μV	Better than 0.3μV
BAND C	2.0 MHz	Better than 1μV	Better than 0.3μV
BAND D	5.0 MHz	Better than 1.5μV	Better than 0.5μV
BAND E	12.0 MHz	Better than 1.5μV	Better than 0.5μV
BAND F	24.0 MHz	Better than 1μV	Better than 0.3μV

IMAGE RATIO

BAND A	280 kHz	Better than 65 dB
BAND B	900 kHz	Better than 50 dB
BAND C	2.0 MHz	Better than 45 dB
BAND D	5.0 MHz	Better than 40 dB
BAND E	12.0 MHz	Better than 25 dB
F	24.0 MHz	Better than 40 dB

IF REJECTION

BAND A	280 kHz	Better than 50 dB
BAND B	900 kHz	Better than 60 dB
BAND C	2.0 MHz	Better than 70 dB
BAND D	5.0 MHz	Better than 70 dB
BAND E	12.0 MHz	Better than 70 dB
BAND F	24.0 MHz	Better than 70 dB

SELECTIVITY

NARROW	More than 2.5 kHz at -6 dB
	Less than 12 kHz at -60 dB
WIDE	More than 5 kHz at -6dB
	Less than 17 kHz at -60 dB

AUDIO OUTPUT

1.5W at 8Ω load (10% distortion)

ANTENNA IMPEDANCE

50 ~ 75Ω

AUDIO OUTPUT IMPEDANCE

4 to 8 ohms

POWER REQUIREMENTS

AC 100/117/220/240V
DC 12 ~ 16V (13.8V as reference)

POWER CONSUMPTION

8W (AC 100/117/220/240V)
4.1W (DC13.8V)
6.9W (DC 13.8V, LIGHT switch ON condition)

SEMICONDUCTOR COMPLEMENT

4 FET's
21 Transistors
24 Diodes

DIMENSIONS

362 (W) × 163 (H) × 322 (D) mm
14-1/4 (W) × 6-7/16 (H) × 12-11/16 (D) inch

WEIGHT

7.6 kg (16.7 lbs)

SCHEMATIC DIAGRAM

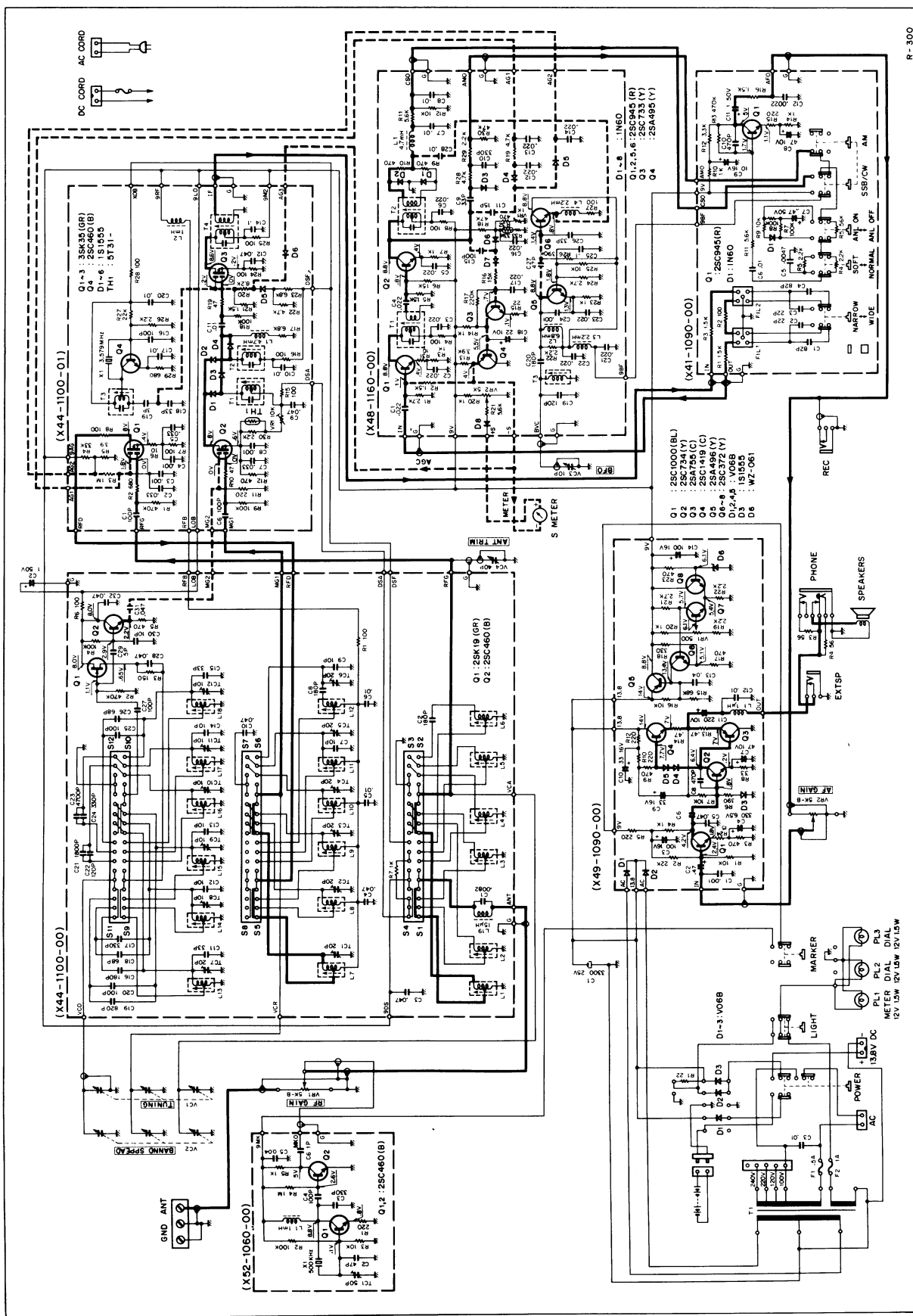

R-300



A product of

TRIO-KENWOOD CORPORATION

6-17, 3-chome, Aobadai, Meguro-ku, Tokyo 153, Japan

© 6445 PRINTED IN JAPAN B50-1557-00 (K) (W) (W₂) (G)