

KENWOOD

**COMMUNICATIONS RECEIVER
NACHRICHTENEMPFAÑGER
RECEPTEUR DE COMMUNICATIONS
RECEPTOR DE COMUNICACIONES**

Model R-2000



**INSTRUCTION MANUAL
BEDIENUNGSANLEITUNG
MODE D'EMPLOI
MANUAL DE INSTRUCCIONES**

Downloaded by
Amateur Radio Directory

www.hamdirectory.info

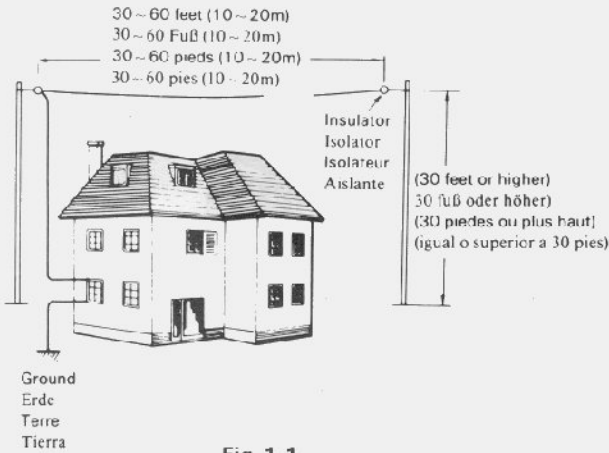

Fig. 1-1

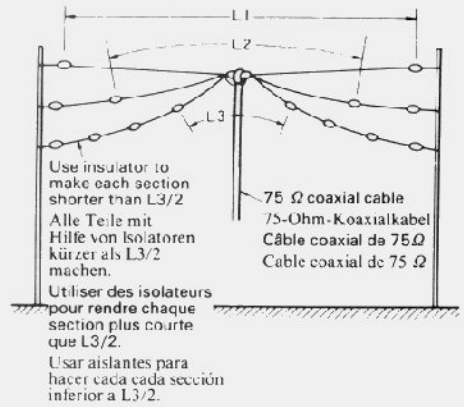

Fig. 1-4

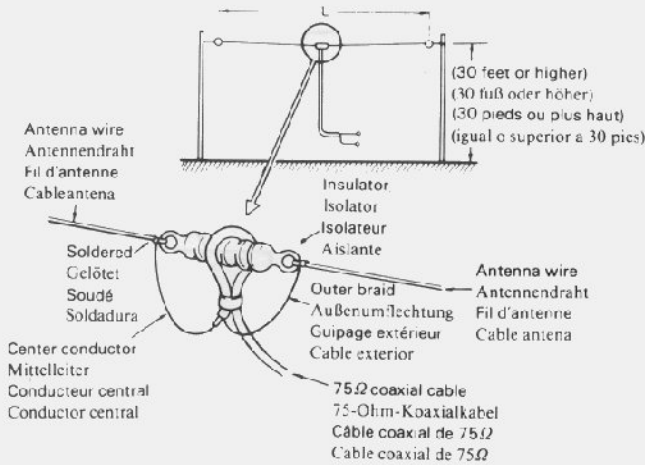

Fig. 1-2

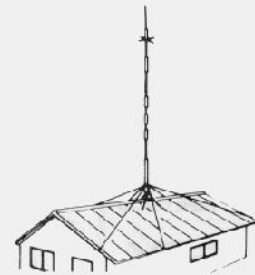

Fig. 1-5

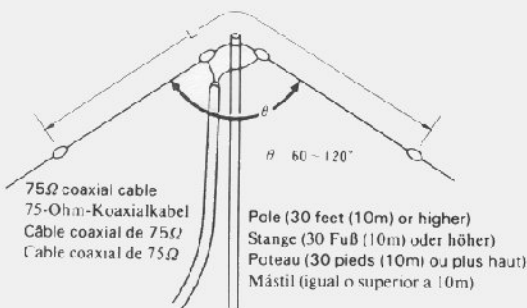

Fig. 1-3

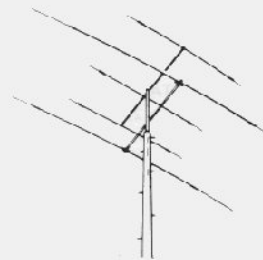

Fig. 1-6

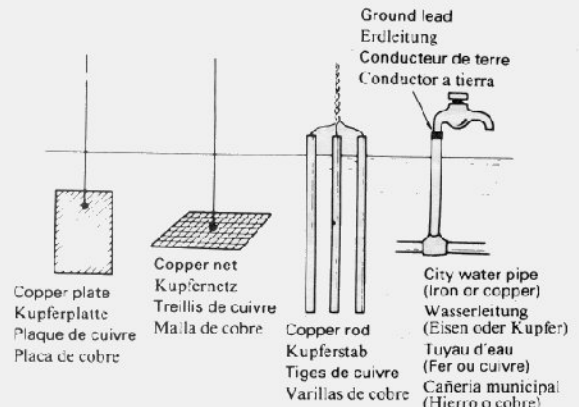
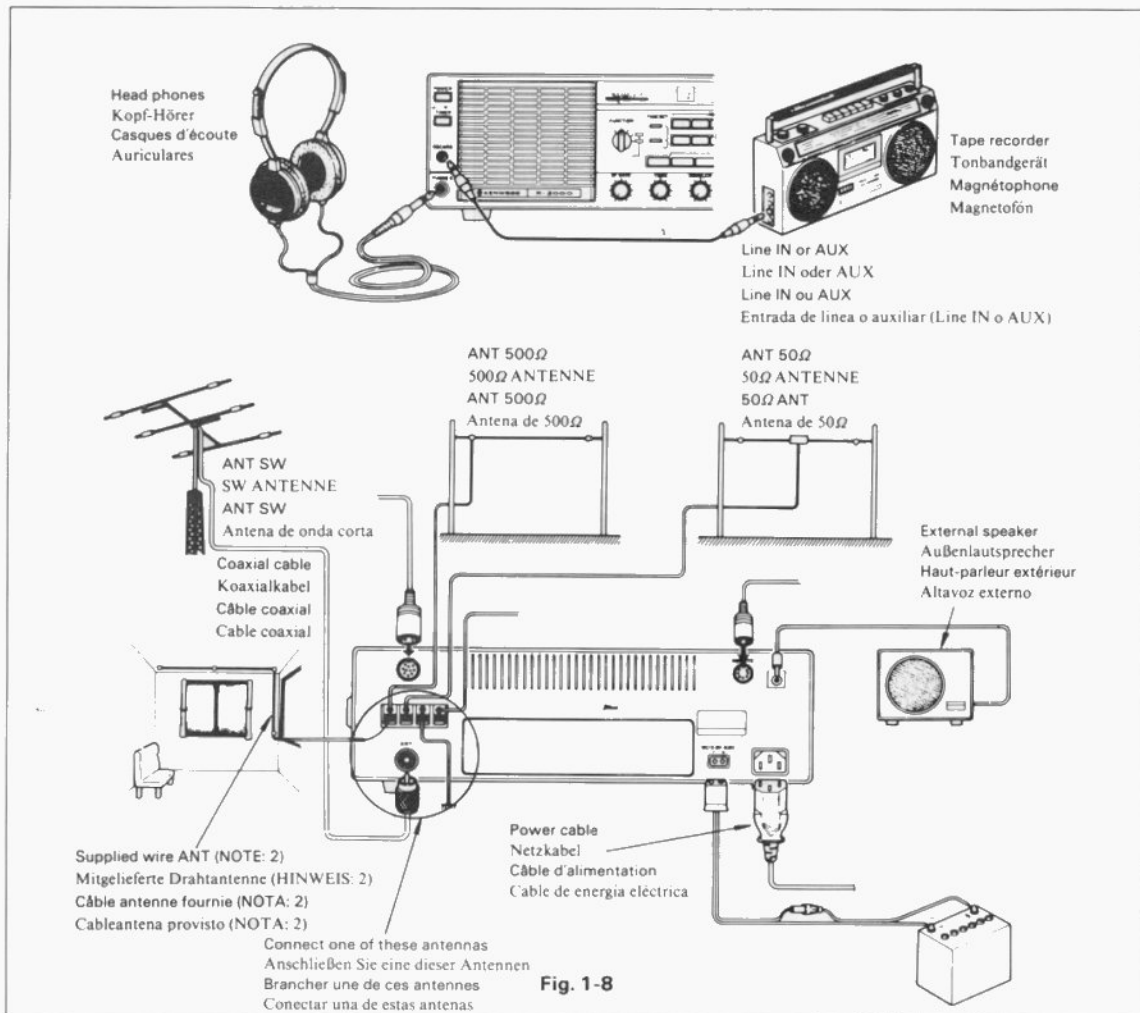

Fig. 1-7

INTERCONNECTION ZWISCHENVERKABELUNG

INTERCONNEXION INTERCONEXIONS



NOTE:

1. Fig. 1-8 shows an example of R-2000 interconnection. A suitable antenna should be selected (see pages 1 and 3)
2. A simpler (but less effective) antenna system is achieved by connecting the supplied wire antenna to 500Ω terminal.
3. The UHF type ANT terminal should be used for a low impedance antenna (50Ω ~ 75Ω) fed with coaxial cable.
4. Before operating, always be sure to connect an antenna or wire antenna to this receiver.
5. Do not supply an AC and DC power source at the same time.

HINWEISE:

1. Abb. 1-8 zeigt ein Beispiel der Zwischenverkabelung am R-2000. Die für dieses System geeignete Antenne sollte unter Bezugnahme auf Seite 1, 3 gewählt werden.
2. Für einfaches Anschließen die mitgelieferte Drahtantenne mit der 500Ω Klemme verbinden.
3. Die UHF-Typ ANT sollte für eine Antenne mit niedriger Impedanz (50Ω ~ 75Ω) benutzt werden.
4. Vor Betrieb darauf achten, ob die Antenne oder der Antennendraht am Empfänger angeschlossen ist.
5. Niemals gleichzeitig mit Netzstrom und Batterie betreiben.

NOTA:

1. La Fig. 1-8 donne un exemple de l'interconnexion du R-2000. En ce qui concerne le système d'antenne une antenne appropriée devrait être choisie en se référant aux pages 1, 3.
2. De manière simple connecter le fil d'antenne fourni à la borne 500Ω.
3. La borne ANT type UHF devrait être utilisée pour une antenne à faible impédance 50Ω ~ 75Ω avec le câble coaxial.
4. Absolument brancher une antenne ou descente d'antenne sur le récepteur avant de le mettre en service.
5. Ne pas brancher simultanément sur les alimentations secteur (CA) et CC.

NOTA:

1. La Fig. 1-8 ilustra un ejemplo de las distintas interconexiones del R-2000. La antena más apropiada debe seleccionarse de acuerdo con las páginas 1, 3.
2. El cableantena provisto con el aparato debe conectarse al terminal de 500Ω.
3. El terminal ANT tipo UHF debe utilizarse para una antena de baja impedancia (50Ω ~ 75Ω) conectada a través de un cable coaxial.
4. Antes del funcionamiento, cerciorarse siempre de conectar una antena normal o una antena de hilos a este receptor.
5. No suministrar CA y CC al mismo tiempo.

Note:

After unpacking, save the boxes and packing in the event your unit needs to be transported for remote operation, maintenance, or service.

CAUTION**CHECK YOUR LINE VOLTAGE.**

This receiver is equipped with a VOLTAGE SELECTOR switch on the rear panel.

BEFORE operating, set this switch to your local line voltage.

CONTENTS

FEATURES	2
SPECIFICATIONS	3
SECTION 1. INSTALLATION	3
SECTION 2. CONTROLS	4
SECTION 3. OPERATING INSTRUCTIONS	6
SECTION 4. MEMORY OPERATION	10
SECTION 5. TIMER OPERATION	12
SECTION 6. ENJOYING SW RECEPTION	14
SECTION 7. IN CASE OF DIFFICULTY	17
SECTION 8. OPTIONAL ACCESSORIES	18
BLOCK DIAGRAM	76
SCHEMATIC DIAGRAM	77

FEATURES**ALL MODES: SSB, CW, AM, AND FM**

Combined with a wide frequency coverage, the all mode R-2000 receives USB, LSB, CW, AM, and FM, providing expanded flexibility in receiving the various signal types. Mode selection is quickly accomplished through use of front panel mode keys having adjacent LED indicators.

DIGITAL VFO'S FEATURE EXCELLENT STABILITY

- Use of 50 Hz step digital VFO's results in superior frequency accuracy and stability.
- Tuning speed switches allow changing the size of the tuning step, for efficient operation, as follows: 50 Hz (10 kHz/360 degree knob rotation), 500 Hz (100 kHz/360 degree knob rotation), and 5 kHz (1 MHz/360 degree knob rotation).
- F.Lock switch protects against accidental frequency shift that might occur if the tuning knob were accidentally bumped.

TEN MEMORIES STORE FREQUENCY, BAND, AND MODE DATA

- Each of ten memory frequencies may be tuned by the VFO, operating as ten built-in digital VFO's. The original memory frequency may be recalled by simply pressing the appropriate memory channel key.
- All information on frequency, band, and mode is stored in memory, assuring ease of operation.
- The AUTO.M switch allows two types of memory storage: When the AUTO.M switch is OFF, data is memorized by pressing the M.IN switch. When the AUTO.M switch is ON, the current operating data is automatically being memorized.

LITHIUM BATTERY MEMORY BACK-UP

Memory and VFO information is backed-up by an internal lithium battery (estimated 5 year life), an important convenience when moving the receiver from one location to another.

MEMORY SCAN

Scans all memory channels, or may be user programmed to scan specific memory channels. Frequency, band, and mode are automatically selected in accordance with the memory channel being scanned. The scanning time is approximately 2 seconds for each channel, and a HOLD switch is provided to interrupt the scanning process.

PROGRAMMABLE BAND SCAN

Scans automatically within the programmed bandwidth. Memory channels 9 and 0 establish upper and lower scan limits. The HOLD switch interrupts the scanning process; however, the frequency may be adjusted, using the tuning knob, while in the scan HOLD mode.

FLUORESCENT TUBE DIGITAL DISPLAY (100 HZ RESOLUTION)

- The built-in 7 digit fluorescent tube digital display indicates frequency (or time), as well as selected memory channel number. The receiving frequency is displayed to 100 Hz, on any band, and in any mode, without the need for re-calibration when changing band or mode.
- The unique white fluorescent tube provides fatigue-free viewing over long operating periods, or during field operation. A DIM switch is provided for dimming the display and meter, if desired.
- The display is switched to indicate frequency, clock-1, clock-2, and timer ON-OFF by the front panel function switch.

DUAL 24-HOUR QUARTZ CLOCKS, WITH TIMER

Dual 24-hour quartz clocks are built-in to allow programming two different time zones, such as local time and GMT. A built-in timer provides ON and OFF programming, and remote control output from the timer (does not control AC power) is provided on the rear panel remote terminal.

THREE BUILT-IN IF FILTERS WITH NARROW-WIDE SELECTOR SWITCH. (CW FILTER OPTIONAL)

In the AM mode, 6 kHz wide or 2.7 kHz narrow may be selected. In the SSB mode, 2.7 kHz bandwidth is automatically selected. In the CW mode, 2.7 kHz wide or, if optional YG-455C is installed, 500 Hz narrow may be selected. In the FM mode, 15 kHz bandwidth is automatically selected.

SQUELCH CIRCUIT, ALL MODE, BUILT-IN

The squelch circuit is effective in suppressing back-ground noise in any operating mode.

NOISE BLANKER BUILT-IN

The R-2000 features an effective communications-type noise blanker circuit, which eliminates pulse-type noise on SSB, CW, and AM. In FM, pulse noise is automatically suppressed by FM receiver circuitry.

RECORD OUTPUT JACK ON FRONT PANEL

An output jack is located on the front panel for convenience in recording received signals.

REMOTE TERMINAL

Remote control output from the timer-operated relay, plus muting contacts, are available through the REMOTE terminal on the rear panel.

OUTSIDE VIEWS
AUSSENSEITE

LA VUE L'EXTERIEUR
VISTA EXTERIOR

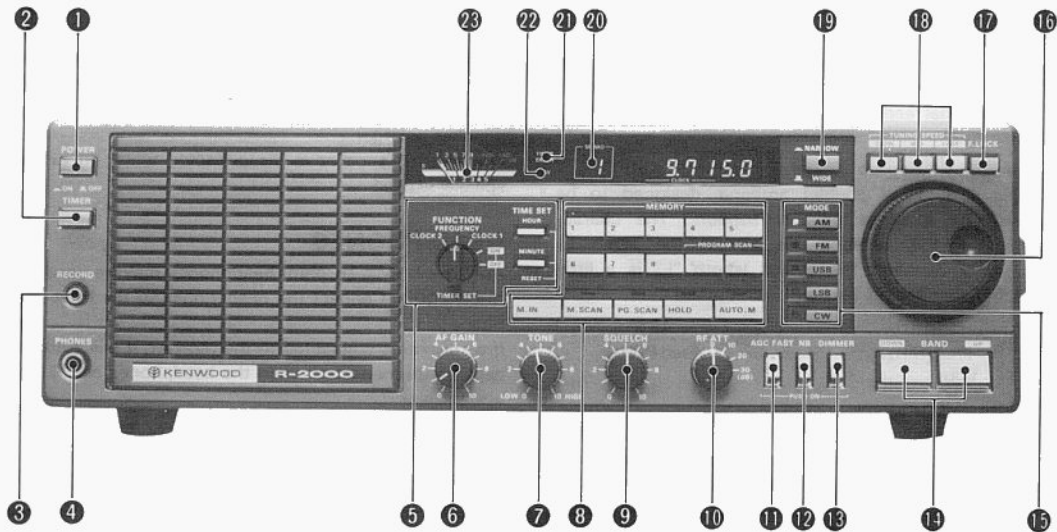

SECTION 1. INSTALLATION

R-2000 SPECIFICATIONS

Frequency Range: 150 kHz ~ 30 MHz
 150 kHz ~ 26 MHz (W2 type)
 2 MHz ~ 30 MHz (X type)

Mode: AM, FM, SSB (USB/LSB), CW

Sensitivity: (0 dB μ = 1 μ V)

Mode \ Frequency	150 kHz ~ 2 MHz	2 MHz ~ 30 MHz
SSB/CW (S+N/N 10 dB)	Less than 2 μ V	Less than 0.4 μ V
AM (S+N/N 10 dB)	Less than 20 μ V	Less than 4 μ V
FM (S+N/N 20 dB)	-	Less than 1 μ V

Selectivity:

Mode \ Selectivity	Selectivity	
AM-WIDE	6 kHz (-6 dB)	18 kHz (-50 dB)
AM-NARROW	2.7 kHz (-6 dB)	5 kHz (-50 dB)
SSB/CW	2.7 kHz (-6 dB)	5 kHz (-50 dB)
CW-NARROW	500 Hz (-6 dB)*	820 Hz (-60 dB)*
FM	15 kHz (-6 dB)	30 kHz (-50 dB)

*: with YG-455C optional CW crystal filter

Image Ratio: Better than 70 dB

IF Rejection: Better than 70 dB

Frequency Stability: Within ± 300 Hz during the first hour after 1 minute of warm-up.
 Within ± 50 Hz during any 30 minutes period thereafter.

Frequency Accuracy: $\pm 10 \times 10^{-6}$ or better (at normal temperatures)

Squelch Sensitivity: (threshold, 0 dB μ = 1 μ V)
 AM/SSB/CW = Less than 3.12 μ V
 FM = Less than 0.5 μ V

Audio Load Impedance: 4 Ω to 16 Ω

Audio Output Power: 1.5W (8 Ω load, 10% distortion)

Antenna Impedance: 50 Ω /500 Ω

Power Consumption: (at no signal) = 14W AC
 13.8V DC, 0.6A (with optional DCK-1)
 (at Memory Back-up) = 3W AC
 13.8V DC, 0.1A (with optional DCK-1)

Power Requirements: 100/120/220/240V AC, 50/60 Hz
 13.8V DC (with optional DCK-1)

Dimensions: 375 (14.8) W x 115 (4.5) H x 210 (8.3) D mm (inch)

Weight: 5.5 kg (12.1 lbs.) approx.

GENERAL

To obtain maximum performance from your R-2000 receiver, it is recommended you read Sections 2 and 3 in their entirety before attempting to operate the unit.

ACCESSORIES

The following accessory items are included:

1. Operating manual (B50-4022-XX) 1 copy
2. AC power cable 1 piece
 E30-1643-15 (USA & other countries)
 E30-1645-05 (European countries)
 E30-1647-05 (Oceanian countries)
3. Wire for antenna 10 m
4. Fuse (1.5A) (Power fuse) (F05-1521-05) 1 piece
 Fuse (0.1A) (ANT fuse) (F05-1013-05) 1 piece
5. Remote connector (7P) (E07-0751-05) 1 piece
6. Warranty card 1 piece

OPERATING LOCATION

As with any solid state electronic equipment, the R-2000 should be kept from extremes of heat and humidity. Choose an operating location that is dry and cool, and avoid operating the receiver in direct sunlight.

ANTENNA

● Antenna and Grounding

Installation of antenna and grounding is important for optimum reception of short-wave, broadcast or amateur radio signals. A good outdoor antenna will provide the best results.

The following describes various antenna types and their installation.

NOTE: _____
 A simple method is to install the supplied wire antenna as high as possible, it must be extended to its full length for good results.

● Long Wire Antenna

This is the simplest antenna, using about 30 ~ 1000 feet (10 ~ 30m) of wire installed between poles, trees or other convenient supports. The antenna wire should be heavy 18 gauge vinyl insulated, stranded wire or 4 gauge copper wire or Copperweld. This type of antenna must be installed horizontally to a length of 60 feet (20 m) or more, and be positioned as high as possible. Note that it should be as far away as possible from AC power lines, buildings, trees and other objects.

Fig. 1-1 shows an inverted L antenna. Other antenna types such as sloping, vertical, etc. are also possible.

A long-wire antenna, when installed in an open area, is suitable for all-band operation. (See Fig. 1-1)

● Doublet Antenna

This type of antenna is suitable for reception of a specific band.

The relation between the overall length "L" and the tuned frequency is:

$$L \text{ (m)} = \frac{143}{\text{Freq (MHz)}} \quad K \text{ (feet)} = \frac{468}{\text{Freq (MHz)}}$$

This antenna is directional. Signal strength is maximum when the antenna is at a right-angle (broad-side) to the desired signal and the frequency for which the antenna is cut. It must be used with a 75-ohm coaxial feeder.

(See Fig. 1-2)

● Inverted V Antenna

This is a modified doublet antenna, designed to be installed on a single pole or support. The characteristics of this antenna are almost the same as those of a doublet. The overall length "L" is a little more than that of a doublet, and is computed thus:

$$L \text{ (m)} = \frac{148}{\text{Freq (MHz)}} \quad L \text{ (feet)} = \frac{486}{\text{Freq (MHz)}}$$

(See Fig. 1-3)

● Multiband Antenna

This antenna uses more than one doublet for multiband reception. The overall length "L" is the same as that of the doublet. If the lengths L1, L2 and L3 are cut for 7 MHz, 14 MHz and 28 MHz, then L1 is tuned to 21 MHz (3 x 7 MHz), permitting reception on 4 amateur bands 7 ~ 28 MHz. When used only for reception, this antenna will cover the 6 ~ 30 MHz SW bands. (See Fig. 1-4)

● Trap Vertical Antenna

Antennas designed exclusively for BCL are available commercially, or may be built yourself. Antennas designed for HAM band (3.5 ~ 28 MHz or 7 ~ 14 MHz) operation will provide satisfactory broadcast reception for stations near the SW bands. Antennas of this type are most suitable for the listener who does not have enough space for installation of a doublet or long-wire antenna. (See Fig. 1-5)

● Yagi Antenna

The Yagi antenna is best suited for reception in a specific band. This antenna features excellent directivity; it provides high gain and minimizes interference when properly installed. Yagi antennas commercially available are designed only for HAM band reception. For SW reception, it will be necessary for you to construct such antennas yourself. (See Fig. 1-6)

● Grounding

Normally, the receiver will operate without being grounded. However, a good earth ground improves the efficiency of antennas such as a long-wire. It also eliminates inductive noise and protects the operator from electric shocks through the AC lines.

To ground the receiver, use a copper or brass plate (or net or rod) connected to a copper wire, and bury it in the ground about 1 ~ 7 feet (0.3 ~ 2.0 m) deep. A copper water pipe (not plastic) may also be used. Never use a gas pipe for grounding.

If the receiver cannot be grounded well, the counterpoise (antenna radial) would be acceptable.

SPEAKER

Audio output from the R-2000 is 1.5 watts into 8 ohms. The R-2000 has a built-in speaker. However, if an external speaker is desired (such as the KENWOOD SP-100), simply connect it to the SPEAKER jack of the rear panel. The speaker may be any good 8 ohm permanent magnet type, 4 inches or larger.

The internal speaker is disconnected when an external speaker is used.

HEAD PHONES

Any low-Z (4 ~ 16 ohm) headphones may be used with the R-2000. Connect the headphones to the front-panel phone jack.

If a speaker is connected to the receiver, it will automatically be disconnected when the headphones are plugged into the jack.

POWER REQUIREMENTS

The R-2000 operates from 100/120/220/240 VAC, 50 ~ 60 Hz. Stability is not affected within 10% of line voltage variation, due to the built-in regulated power supply. To change the voltage selector position.

CAUTION:

Operation of this receiver with a wrong power source may result in serious damage, and is not covered by the manufacturer's warranty.

CONNECTION

500Ω ANT Terminal

Connect a high impedance antenna such as a long wire antenna.

50Ω Terminal

Connect a low impedance antenna.

UHF coaxial ANT connector

Use a low impedance antenna. The antenna feeder should be a coaxial cable equipped with a UHF connector.

GND Terminal

It is recommended that a short, heavy ground lead be connected to the GND terminal (rear panel) to prevent the possibility of electric shock.

Headphones

Use headphones of 4 to 16 ohm impedance. The optional HS-5 or HS-6 headphones are best suited for use with the R-2000. Stereo type headphones can also be used.

External Speaker

Besides the built-in speaker, an external speaker can also be used (such as the optional SP-100). Connect to the rear panel EXT SP jack using the supplied plug.

SECTION 2. CONTROLS

1 POWER Switch

This switch controls power to the R-2000 receiver section. When the TIMER switch is ON, the timer has a priority over the POWER switch. Turning OFF the POWER switch when the CLOCK (1 or 2) time is displayed dims the display.

2 TIMER switch

This switch controls the timer operation.

When the TIMER switch is ON, the timer has priority over the POWER switch.

3 RECORD jack

This terminal may be used for recording broadcasts on tape. Connect it to the LINE IN jack of your tape recorder. The output level at this terminal is constant, regardless on the AF GAIN control setting (Output level: 300 mV/2k Ω).

4 PHONES jack

This jack accepts 4 to 16 ohm or greater impedance headphones. Stereo headphones may be used.

5 Timer switches

For details, refer to page 12.

6 AF GAIN control

This varies the audio output. Volume increases clockwise.

7 TONE control

This adjusts audio tone quality. Normally set to the center position.

8 Memory switches

For details, refer to page 10.

9 SQUELCH control

This control is used to eliminate noise when there is no signal. Turn clockwise until the noise threshold is just reached when there is no signal.

10 RF ATT (Attenuator) switch

This switch allows attenuation of the input signal by 10, 20 or 30 dB.

11 AGC FAST switch

This controls the AGC (Automatic Gain Control) circuit. Use this switch during CW reception or when tuning.

12 NB (Noise Blanker) switch

Turn ON to reduce pulsating, ignition-type noise. Power-line, radar, QRM and atmospheric "white" noises will not operate the blander.

13 DIMMER switch

For operator convenience, this switch selects either bright or dim intensity of both the digital display and meter illumination.

14 BAND switches

UP switch: When this switch is pressed, frequency increases in 1 MHz steps. The frequency stops at 29 MHz.

* When this switch is kept pressed, frequency increases continuously in 1 MHz steps.

DOWN switch: When this switch is pressed, frequency decreases in 1 MHz steps. The frequency change stops at 0.100 MHz.

* When this switch is kept pressed, frequency decreases continuously in 1 MHz steps.

15 MODE switches

The MODE switch selects the type of reception.

AM..... Press this switch for AM reception.

FM Press this switch for VHF 28 MHz amateur frequency band operation.

USB Press this switch to receive USB signals in and above the 10 MHz amateur band.

LSB..... Press this switch to receive LSB for operation below 10 MHz.

CW Press this switch to receive CW.

16 Tuning control

This selects the receiver's operating frequency. Turning this control clockwise increases the frequency.

17 F. LOCK (Frequency Lock) switch

This switch is used to lock the frequency selected by the Tuning Control. In the ON position, the frequency remains locked when the either BAND switch or tuning control is used.

18 TUNING SPEED switches

These are used to select the tuning knob step frequency.

SLOW..... 50 Hz step ...

Convenient for SSB and CW operation

MID..... 500 Hz step ...

Convenient for AM and FM (HF band).

FAST 5 kHz ...

Convenient for FM (VHF) operation.

The program scanning step frequency is also determined by these switches.

19 NARROW/WIDE switch

This switches the IF bandwidth to narrow from the normal wide position. This switch operates in the AM and CW modes. (A narrow CW filter is optional.)

NOTE:

When the optional CW filter (YG-455C) is not installed, always set the WIDE/NARROW switch to WIDE. The NARROW setting allows no CW reception.

20 MEMO (Memory) indicator

This lights to indicate reception on a fixed memory channel frequency (1 ~ 0), program scan (P), or cancell (\square).

21 TIMER ERROR indicator

Lights when the TIMER switch is placed ON and the clock time display is flashing due to a power interruption. In this case, reset the present time with the FUNCTION switch set to CLOCK 1.

SECTION 3. OPERATING INSTRUCTION (MW/SW)

● Initial Setup

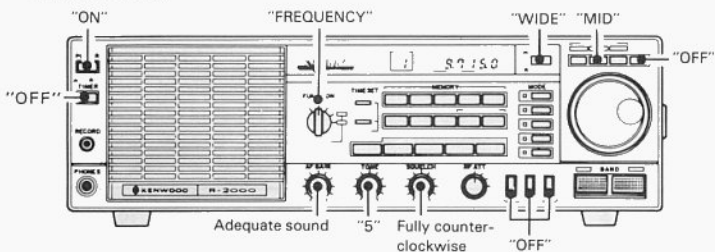

Downloaded by
 Amateur Radio Directory

www.hamdirectory.info

● Operating Instructions

● If interference occurs

- 1 Press the AM MODE switch.
Set the NARROW/WIDE switch to WIDE.

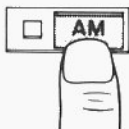

- 1 Set the NARROW/WIDE switch to NARROW.

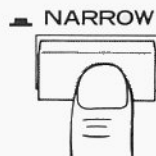

- 2 Tune with the BAND switches and tuning control.

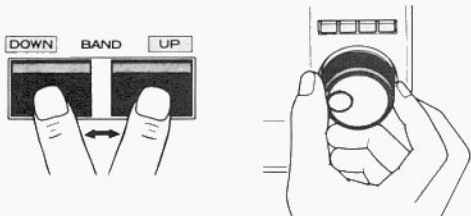

- 2 Readjust the tuning control.

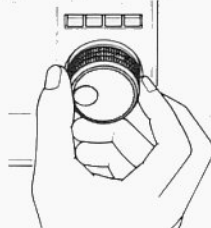

- 3 Use the AF GAIN control to adjust the sound level.

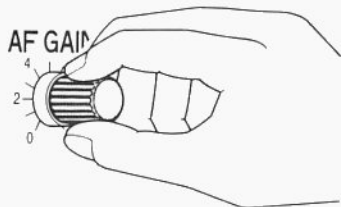

- 3 Use the AF GAIN control to readjust the level.

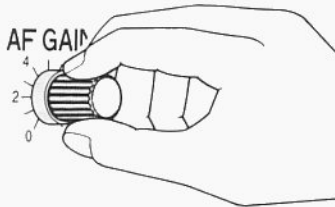

- 4 Use the TONE control to adjust the tone quality.

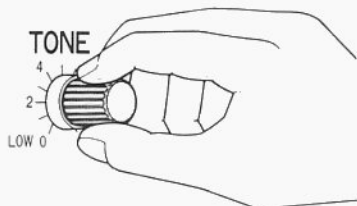

- 4 Use the TONE control to readjust the tone quality.

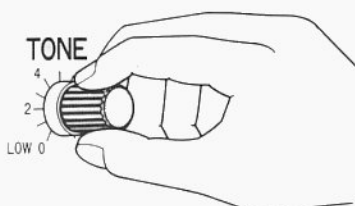

(FM RECEPTION)

● Initial Setup

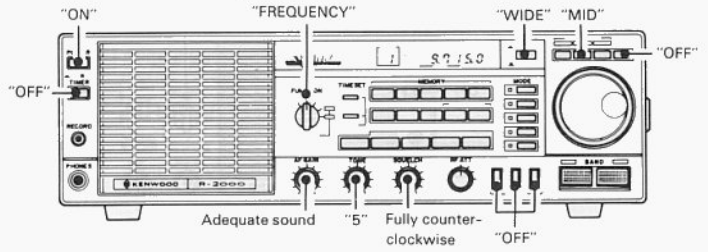

● If distortion occurs due to strong input signal

- 1 Use the RF ATT switch.

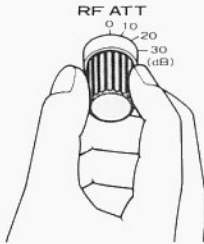

● Operating Instructions

- 1 Press the FM MODE switch.

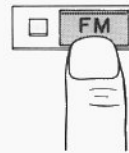

- 2 Readjust the tuning control.

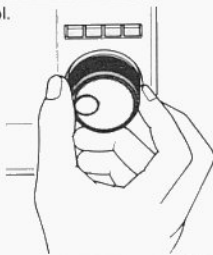

- 2 Tune with the BAND switches and tuning knob.

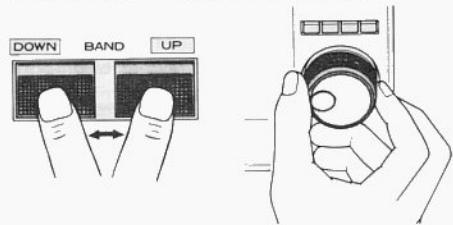

- 3 Use the AF GAIN control to adjust the sound level.

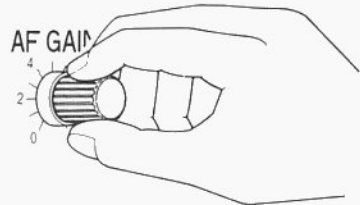

● If pulsating noise occurs

Set the NB switch to ON.

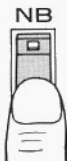

- 4 Use the TONE control to adjust the tone quality.

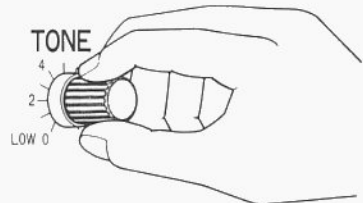

(SSB/CW RECEPTION)

● Initial Setup

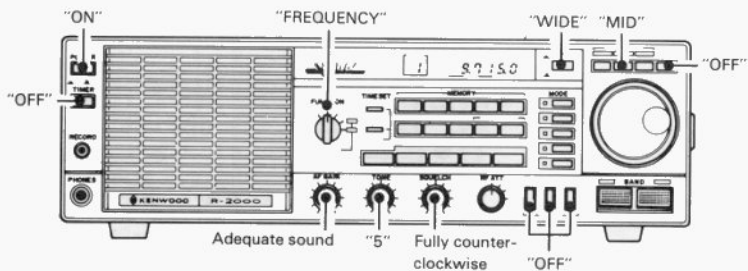

● Operating instructions

- 1 Press the USB, LSB or CW MODE switch.

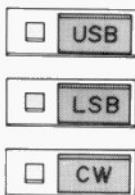

- 2 Operate the BAND switches to receive the required frequency band and turn the tuning knob to obtain the best sound. For precise tuning, the SLOW TUNING SPEED switch should be pressed.

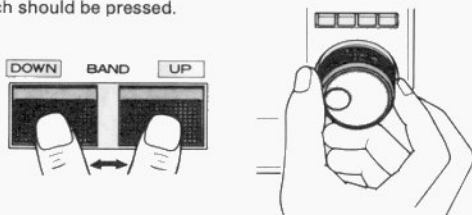

- 3 Use the AF GAIN control to adjust the sound level.

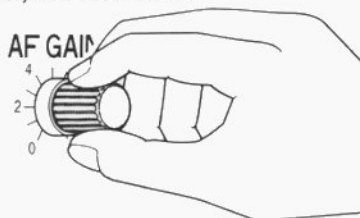

- 4 Use the TONE control to adjust the tone quality.

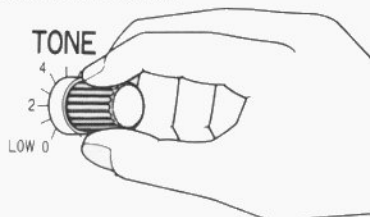

USE OF AN EXTERNAL SPEAKER OR HEADPHONES

This receiver has a built-in speaker. An external speaker can also be connected to the EXT SP jack on the rear panel. Connecting the external speaker disconnects the built-in speaker. Headphones (4 ohms or greater impedance) with a standard phone plug or stereo phone plug can be connected to the PHONES jack on the front panel.

RECORD JACK FOR RECORDING

The signal is fed to this jack for recording. To record the signal, connect the LINE IN jack, not the MIC input jack, of your tape recorder. The signal level fed to this jack (0.3V/2 k Ω terminal) is fixed regardless of the AF GAIN control setting, so the recording can be made with the AF GAIN control turned fully counterclockwise.

MODE SWITCH OPERATION

● To Receive Standard or Short Wave Broadcasts

Press the AM MODE switch. The corresponding LED lights. When the incoming signal is strong set the NARROW/WIDE switch to WIDE. This allows reception with improved tone.

● When The Incoming Signal is Weak or Distorted

Press the AM MODE switch. The corresponding LED lights. Set the NARROW/WIDE switch to NARROW. This narrows the bandwidth to reduce noise and interference.

● To Receive Amateur radio Stations

To receive voice transmissions on or above 10 MHz, press the USB MODE switch. The corresponding LED lights. To receive voice transmissions on or below 7 MHz, press the LSB MODE switch. The corresponding LED lights.

● To Receive CW (Morse code) transmissions

Press the CW MODE switch. The corresponding LED lights. The NARROW/WIDE switch should always be set to WIDE when there is no optional narrow CW filter installed. When the optional YG-455C is installed in the receiver, the NARROW/WIDE switch may be set to either setting according to reception conditions. With the YG-455C installed, the WIDE setting activates 2.7 kHz filter and the NARROW setting activates 500 Hz filter.

● When Receiving an FM Station

Press the FM MODE switch. The corresponding LED lights.

RF ATT SWITCH

If excessively strong nearby stations or high-power night broadcasts are present within the band being received,

a desired signal may be blocked by receiver desensitization. Also, if a signal is very strong, the meter may deflect off-scale. Use the RF ATT switch to reduce incoming signal strength.

NB SWITCH

For pulse type noise, such as generated by automobile ignition systems, turn the NB switch ON. The noise will be reduced or eliminated. Power line, radar, QRM and atmospheric white noise will not operate the blanker.

DIMMER SWITCH

Pressing this switch in reduces the digital display and the meter scale intensity. When operating this receiver at night or in subdued light, press this switch to make the display easier to view.

REMOTE CONNECTOR

By using the REMOTE connector as shown below. Operation with a transmitter or transceiver is possible.

EXAMPLE:

To use this unit as a second receiver in conjunction with a transceiver, the muting circuit in this unit is activated when the transceiver is set to the transmit mode to inhibit reception by this receiver. The antenna input to the R-2000 should be switched through the transmitter or transceiver's antenna relay.

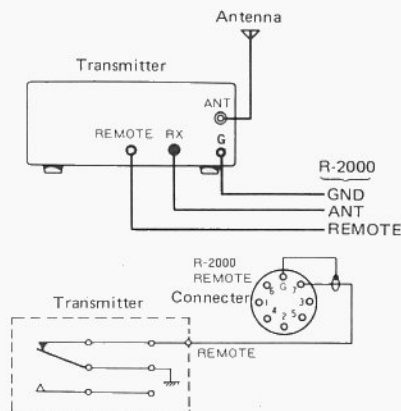

Fig. 3-1

BAIL

This is used to elevate the front of the receiver as shown.

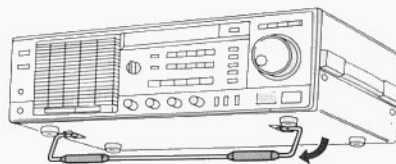

Fig. 3-2

SECTION 4. MEMORY OPERATION

MEMORY INPUT

This receiver has ten memory channels. Each channel can store a frequency and mode.

There are two ways of memory which can be input by use of the M. IN switch or the AUTO. M switch.

When new information is stored in a memory channel, the old information is erased.

Memory Input using the M. IN switch

When the station being received is to be memorized, keep the M. IN switch pressed and press one of the MEMORY switches (1 through 0). A beep will sound to confirm memory entry. A frequency and mode can be stored in each memory channel using this procedure. To recall from a memory, simply press the desired MEMORY switch.

The frequency and mode recalled can be changed by operating the tuning control and MODE switch without sacrificing the memory.

Memory Input using the AUTO.M switch

The beep will not sound in this memory input operation.

● To renew the content of the memory channel displayed or that of other one memory channel only, proceed as follows:

1. To renew the content of the displayed memory channel, shift the frequency and, if necessary, change the mode according to your operating purpose.
2. To store this new setting in the memory displayed, simply press the AUTO.M switch twice.
3. To renew the content of the memory channel not displayed, press the desired memory channel to recall the content.
4. Shift the frequency and, if necessary, change the mode according to your operating purpose.
5. To store this new setting in the memory channel displayed, simply press the AUTO.M switch twice.

● To renew the content stored in each memory one after another, proceed as follows:

1. Press the AUTO.M switch to light the indicator above the switch.
2. Press the desired MEMORY channel (example: MEMORY channel 1) to recall the content.
3. Shift the frequency and, if necessary, change the mode according to your operating purpose.
4. To store this new setting in the displayed memory channel (MEMORY channel 1), simply press the next desired MEMORY channel switch (example: MEMORY channel 2). This completes the memory-input into the memory channel 1 and recalls the contents stored in the memory channel 2.
5. To renew the content stored in each memory one after another, repeat the steps 3 and 4 until memory-input is completed (into the memory channels 1 through 0).
6. To terminate this operation, press the AUTO.M switch. The indicator above the switch goes off.

Scan operation

This receiver has three scan functions.

Memory-scan: Up to ten stored memory channels can be scanned.

Select-scan: Any selected memory channels out of the ten can be scanned.

Program-scan: Any frequency range between MEMORY 9 and 0 can be scanned. The beep will sound for every scan cycle.

Memory-scan operation

Press the M.SCAN switch and the indicator will light. When released, scanning will start from memory channel 1 and proceed 1 → 2 → 3 → 8 → 9 → 0 → 1 → at 1.5 seconds intervals. To release the scan operation, press the M.SCAN switch again.

Select scan operation

For example, to select the memory channels 2, 4, 6, and 8, depress and hold the M.SCAN switch and simultaneously depress the 2, 4, 6, and 8 memory channel switches in any order. If you should decide to cancel a selected channel (channel 4 for example) during initial programming with the M.SCAN switch still depressed, recall memory channel 4 and depress the channel 4 pushbutton again to cancel the scan setting. "□" appear in the MEMO display to indicate channel 4 is cancelled. When the M.SCAN switch is released, scan will begin in this order: channel 2, 6, and 8.

To release the select scan operation, depress the M.SCAN switch. This cancels the selected memory scan.

NOTE:

When the HOLD switch is depressed during memory scan or select scan operation, scan stops at the displayed channel. To resume scanning, depress the HOLD switch. During hold, the mode stored in memory can be changed. To change the mode, depress required MODE switch. Depress and hold the M.IN switch and then the desired MEMORY switch.

Program scan operation

NOTE:

In the FM mode, scan does not operate while the squelch is opened (the BUSY indicator is lit). Advance the squelch control until the BUSY lamp just goes off and the speaker is silenced.

Press the PG.SCAN switch and the indicator will light. The MEMO display will indicate the letter P. When the PG.SCAN switch is released, scanning will start from the frequency and in the mode stored in memory 9 and proceed to that in MEMORY 0 at the selected tuning speed. To release the scan, depress the PG.SCAN switch again. To change the mode and tuning speed used during program scan, press the HOLD switch to stop the scan, then select the new MODE and TUNING SPEED. Depressing

the HOLD switch stops the program scan. At hold, the frequency can be tuned within the range preset between memory channels 9 and 0 by using the tuning control. When the squelch opens during program scan in the FM mode, the BUSY indicator will light and scan will stop. When the squelch closes, the BUSY indicator will go off and scan resumes. When scan is held by opened squelch, depressing either the UP or DOWN switches restarts

scanning. With the UP or DOWN switch depressed, scan is continuous even when the squelch is opened. In AM, SSB, or CW modes, scan does not stop at a signal. If scan stop is desired, the jumper connection on the the RX Printed Board X55-1340-00 must be changed from the S1 to the S2 terminal. When operating this way, scan does not stop at the center tuning point. Depress the HOLD switch and tune precisely using the tuning control.

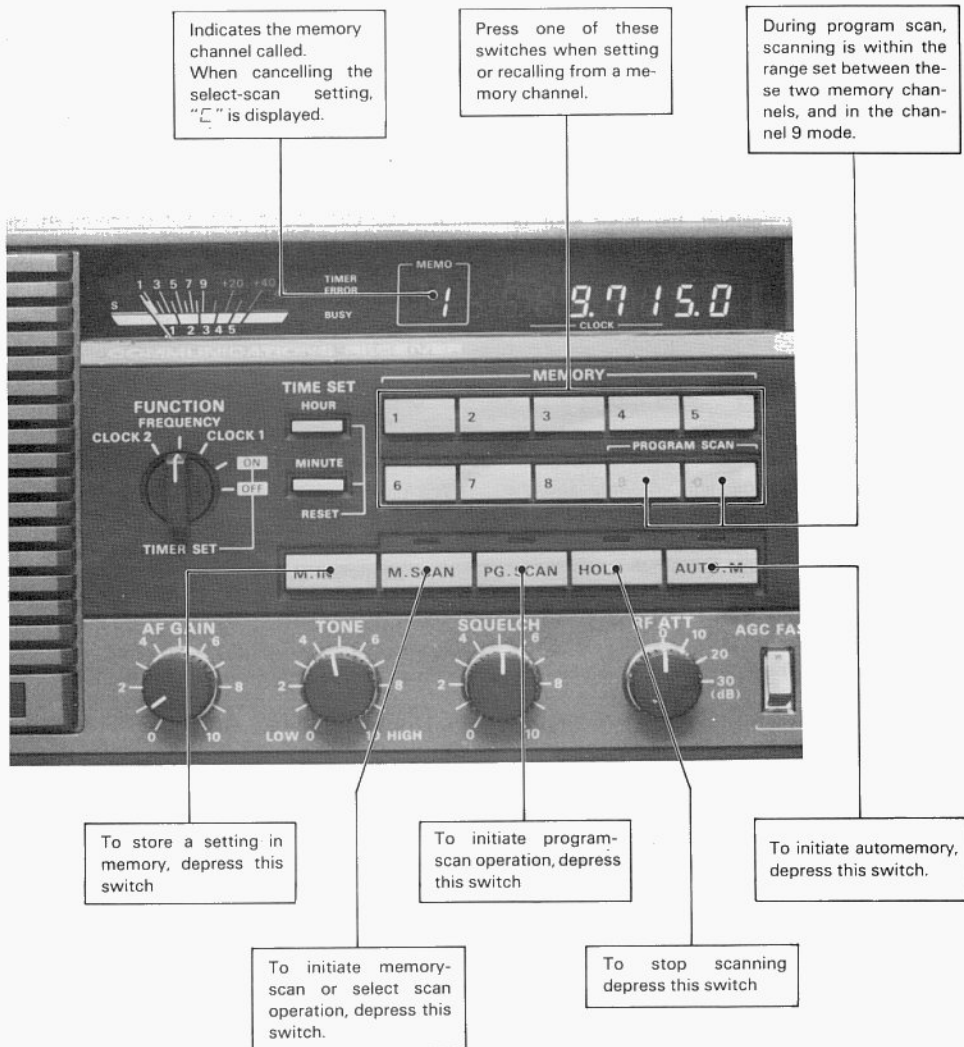

Fig. 4-1

SECTION 5. TIMER OPERATION

FUNCTION switch operation

FREQUENCY: With the switch in this position, the frequency is displayed.

CLOCK 1: In this position, local time is displayed.

Timer operation is controlled by local time.

When the display indication 0.00 flashes (when the receiver is first connected), reset the present time with the switch at this position.

CLOCK 2: In this position, a second time zone may be entered for display. Timer-ON/OFF operation is not controlled by clock 2 time. Set this clock to GMT or another country's standard time.

The CLOCK (1 and 2) time counts are working as long as the power cord is connected to a power source.

However, these CLOCK time settings are cleared when a power failure occurs.

TIMER-SET ON: In this position, the timer turnon time can be with the HOUR and MINUTE switches.

TIMER-SET OFF: In this position, the timer shut off time can be set with the HOUR and MINUTE switches.

TIMER RESET

When the clock display flashes 0.00 (when first connected or after a power failure), reset the timer as follows.

1. Set the FUNCTION switch to CLOCK 1.
2. Press the HOUR and MINUTE SET switches simultaneously. The flashing indication will stop and the clock will start from 0.00. Beginning at this time, seconds are counted up from zero (this is not displayed). To set correct time, press these switches simultaneously while listening to a standard time signal (WWV, CHV, etc.).
3. Press the HOUR switch to advance the hours digit to the present time. The hours digit indicates from 1 to 24.
4. Press the MINUTE switch to advance the minutes digit to the present time.

NOTE:

Pressing the HOUR switch once advances the display by one hour. By keeping the HOUR switch pressed, the hours digits are continuously advanced after one second. The MINUTE switch works in the same way. Either hours or minutes can be set first.

5. Set the FUNCTION switch to CLOCK 2.
6. Set the second reference time in the same way as previously described in steps 2 through 4.

NOTE:

With the switch set at CLOCK 2, a flashing display (after a powerfailure) cannot be reset.

SETTING TIME

Setting ON and OFF time

1. To set the ON time (when power-on is timer operated), set the FUNCTION switch to ON. To set the OFF time (when power is switched off), set the FUNCTION switch to OFF.
2. Set the desired ON and OFF times, by following steps 3 and 4 in the previous procedure.
3. Set the TIMER switch to ON. When CLOCK 1 reaches the time set for timer turn on, the receiver is turned on.
Turn-off will occur at the preset timer turn-off setting.

NOTE:

1. The TIMER switch has priority over the POWER switch.
2. When the TIMER switch is ON, placing the POWER switch ON does not turn on the receiver.
3. If the timer on and off times are exactly the same, timer operation will not take place.
4. While this receiver is connected to an AC (or DC optional) power source, the clocks operate regardless of the POWER switch setting. A power failure or disconnecting the power cable will clear the clock settings. If this occurs, placing the TIMER switch to ON causes "TIMER-ERROR" to be indicated by the display. Reset CLOCK 1 and 2. Timer ON and OFF settings are held in memory.

UNATTENDED TAPE RECORDING

The timer function allows you to record a program on tape even when you are away from home. The tape recorder to be used should be provided with the following functions:

1. A recording input terminal to accept external line input signals.
2. Automatic start/stop circuit which controls tape record operation by an external control signal.

CONNECTIONS AND SETTINGS

1. Place the receiver to the desired frequency and mode.
2. Connect the tape recorder LINE IN jack to the receiver RECORD jack. (Cable user-supplied.)
3. Set the receiver's timer to the required ON and OFF times and place the TIMER switch ON.
4. Connect the tape recorder external control terminal to the receiver's REMOTE connector (pins 1 and 4).
5. Set the tape recorder to the record mode.

The tape recorder is now ready for unattended recording. When the timer reaches the ON time, the receiver turns on and activates the tape recorder through the REMOTE connector.

NOTE:

Internal REMOTE connector wiring is shown in the illustration. Do not apply an AC voltage to this REMOTE connector.

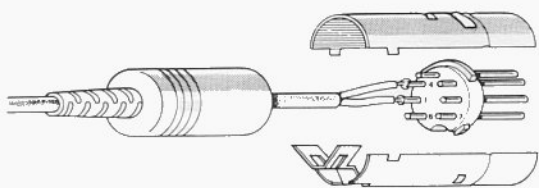
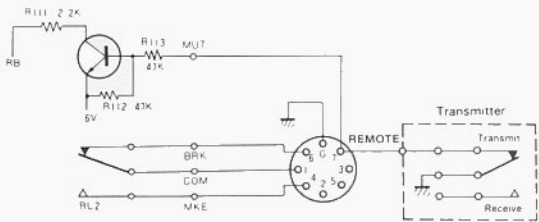

[A]

[B]

Fig. 5-1 Remote Terminal

When the timer switch is depressed and the radio is off, frequency does not display.

Depress this switch to set timer operation.

This setting allows another time to be set; i.e. GMT, or another country's standard time.

This setting allows the receiver frequency to be displayed.

This setting allows setting your local standard time. Timer operation is controlled by this clock.

Press to set hours.

Press to set minutes.

When either of these switches is kept depressed, the hours or minutes display advances rapidly. With the FUNCTION switch set to CLOCK 1, pressing the HOUR and MINUTE switches simultaneously brings the time count to 0.00. When released, the time is counted from zero seconds.

This position allows timer-on setting.

This position allows timer-off setting.

Fig. 5-2

SECTION 6. ENJOYING SW RECEPTION

ENJOYING SW RECEPTION

Every country in the world has broadcast stations, and most countries have Amateur radio stations. The earth is virtually surrounded by innumerable radio waves, providing us with information and news. Your R-2000 intercepts many of these transmissions.

Radio waves cover a wide range of frequencies including long-wave (LF), medium-wave (MF), and short-wave (SW) or high frequency (HF). Since short-wave signals travel around the earth, it is fun receiving exciting news and exotic music from overseas broadcast stations or transmissions from Amateur radio stations and various industrial, marine, government, and military. It is also interesting to collect reception or verification (QSL) cards. To ensure maximum enjoyment of short-wave reception, it is important to know the features of short-wave signals – how the signals travel around the earth, the method of receiving signals most effectively, the method of identifying the country broadcasting programs, etc.

Propagation of Radio Waves By the Ionosphere (See page 15 Fig. 6-1)

The earth is surrounded by the atmosphere. The atmospheric molecules existing between 50 km and 500 km above the earth collide with ultraviolet rays and electrons emitted from the sun, and a layer of electrons and ions is formed. This layer is called the ionosphere and it has a characteristic of refracting radio waves. Radio waves emitted from the antenna of a transmitter can be classified as surface waves and ionospheric waves. Surface waves travel along the earth directly, and are used mainly for medium frequency AM broadcast and TV and FM broadcast. Ionospheric (sky) waves travel a long distance because they are refracted repeatedly between the ionized layer and the earth. As short-wave broadcasts propagate by ionospheric waves, their signals often reach around the earth. The surface wave tends to weaken at HF and short-wave frequencies and therefore travel only a short distance, while ionospheric waves persist as the frequency increases (up to a certain point, determined by ionization intensity) and travel long distance with little path loss. Ultra high frequencies pass through the ionized layer, and thus the service area is limited to a short distance from the antenna. The ionosphere is divided into three layers, D, E and F, as shown in Fig. 6-1.

The electron density in the layer is increased in steps according to the distance from the sun. High frequency waves are refracted by the F layer and travel a long distance.

The state of the ionized layer is closely associated with the relative positions of the sun and the earth and also with the activity of the sun. The D and E layers almost disappear at night, while the F layer changes in height and density depending on daytime or night time, and changes the upper frequency limit to be reflected. Occasionally, "clouds" of ions will drift through the E layer, causing strong signal propagation (called "sporadic E propagation") over several hundred miles, usually between 15 MHz and 30 MHz, and sometimes higher in frequency.

Such a phenomenon also occurs with changes in seasons or rotation cycle of the sun as well as unusual activities of the sun (change in the sunspot cycle every 11 years, unexpected explosion on the sun, etc.). To cope with this, international short-wave broadcast stations change their frequencies according to seasons or directions of radio waves, or use different frequencies at the same time for broadcasting the same program.

Frequency Distribution in the Broadcast and Amateur Bands.

The R-2000 receiver covers from 150 kHz to 30 MHz, to receive international broadcast and communication services.

As shown in the Frequency Allocation Chart, Fig. 6-2, broadcast and Amateur radio station frequencies are allocated in specific bands expressed in megahertz (MHz) or wavelength in meters (m). Also in Fig. 6-2, the frequencies of "other stations" are assigned for fixed station business use, marine mobile, aviation mobile, land mobile, radio beacon stations, etc. The following relationship exists between frequency and wave length.

$$\begin{aligned} \text{Wave-length (m)} &= \frac{300}{\text{Frequency (MHz)}} \\ &= \frac{300,000}{\text{Frequency (kHz)}} \\ \text{Frequency (MHz)} &= \frac{300}{\text{Wave length (m)}} \end{aligned}$$

As will be seen from this relationship, the 31m band and 9 MHz band, for example, are the same shortwave broadcast band, covering the range of 9,500 kHz to 9.775 kHz.

	Frequency Band	Type of Radio Wave Propagation	
		Short-distance	Long-distance
VLF	Very Low Frequency (under 30 kHz)	Surface wave	Ionospheric wave
LF	Low Frequency (30 ~ 300 kHz)	Surface wave	Ionospheric wave
MF	Medium Frequency (300 ~ 3,000 kHz)	Surface wave	Ionospheric wave
HF	High Frequency (3 ~ 30 MHz)	Ionospheric wave	Ionospheric wave

Table 1

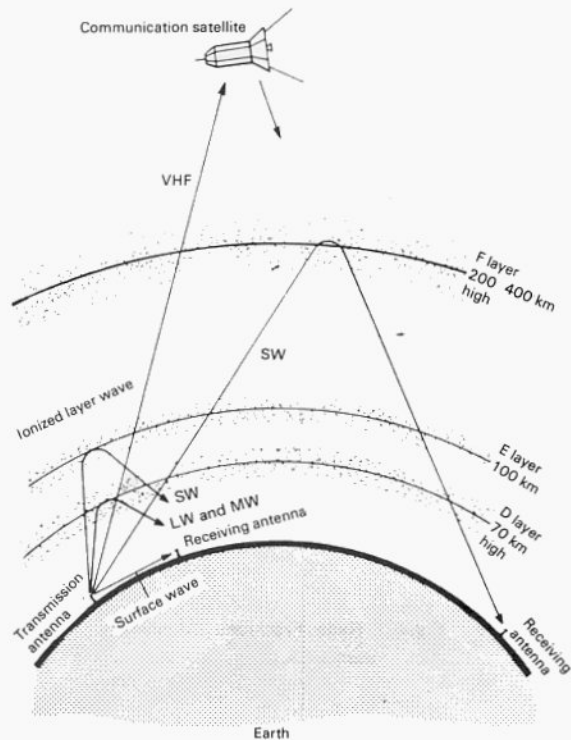
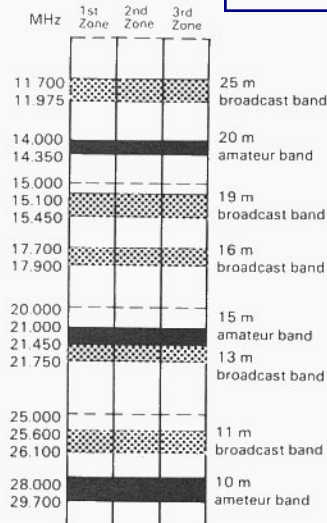
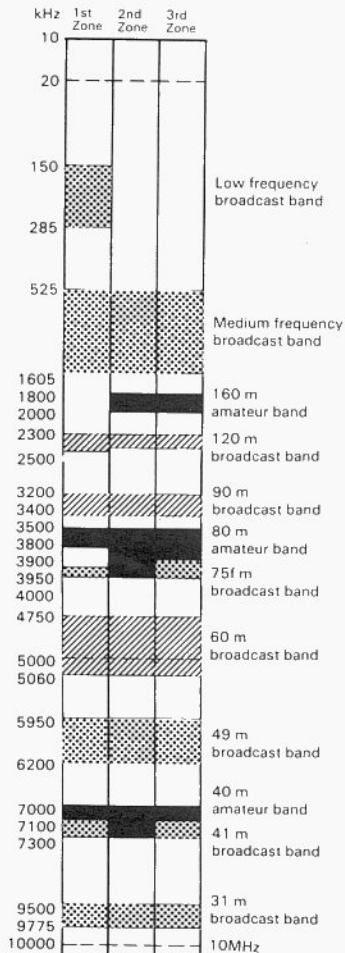

Fig. 6-1

RADIO FREQUENCY ALLOCATION

Downloaded by
 Amateur Radio Directory

www.hamdirectory.info



1st Zone:
 Europe and Africa (Soviet Russia, Turkey and Mongolia included)

2nd Zone:
 South and North America

3rd Zone:
 Asia and Oceania (Soviet Russia, Turkey and Mongolia excluded)

- In some countries, frequencies allocations do not accord with this table.
- Allocations of frequencies lower than 10kHz and higher than 40GHz are not internationally settled.

--- Standard wave

▨ Tropical broadcast band

▤ General broadcast band

■ Amateur band

□ Other stations

Fig. 6-2 Radio Frequency Allocation

SECTION 7. IN CASE OF DIFFICULTY

Symptom	Cause	Remedy
No dial illumination or reception with the POWER switch ON.	<ol style="list-style-type: none"> 1. Bad power connection. 2. Blown fuse. 	<ol style="list-style-type: none"> 1. Check power connection. 2. Replace the fuse. (If the fuse blows again, consult your dealer.)
No reception or weak signal with an antenna connected.	<ol style="list-style-type: none"> 1. Check RF ATT switch. 2. Squelch is on. 3. Antenna impedance does not match. 4. Open antenna fuse. 	<ol style="list-style-type: none"> 1. Correct RF ATT setting. 2. Turn the SQUELCH control counter-clockwise. 3. Choose the antenna terminal to match the antenna impedance. 4. Replace the fuse (100 mA fuse, only).
No dial illumination or reception with the POWER switch ON, but clock time displays.	<ul style="list-style-type: none"> ● TIMER switch ON. 	<ul style="list-style-type: none"> ● Set the TIMER switch to OFF.
No reception. Frequency display shows 150.055.0.	<ul style="list-style-type: none"> ● Memory back-up battery discharged. 	<ul style="list-style-type: none"> ● Replace battery and perform initial setup.
No reception. Frequency display and mode indicator malfunction.	<ul style="list-style-type: none"> ● Microcomputer latchup. 	<ul style="list-style-type: none"> ● Reset the microcomputer. Refer to initial setup.

NOTE:

When tuning across a strong station, a "click" may be heard. This is normal, and not a malfunction.

INITIAL SETUP

1. Disconnect the power cable with the POWER switch ON.
2. Remove the receiver top cover (8 screws).
3. Ground pin 40 of IC-12 on the PLL unit for about 5 seconds.
4. Reconnect power.
5. Keep the M.IN switch depressed and ground pin 29 of IC-12 for a few seconds.
6. Remove and then reinsert the power cord.

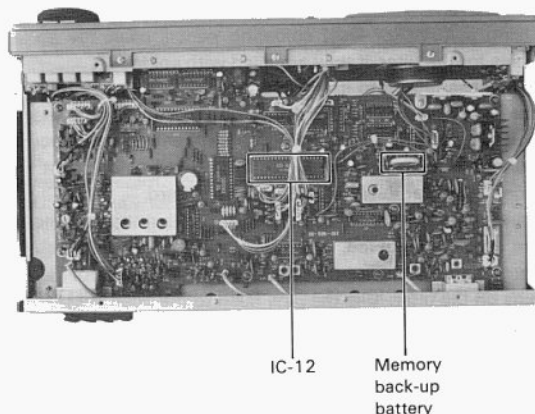

Fig. 7-1

SECTION 8. OPTIONAL ACCESSORIES

COMMUNICATION HEADPHONES

The HS-5 designed for communications equipment. These lightweight open air-type headphone remain comfortable during extended operation. Easily attached ear-pads are provided. The HS-6 is a deluxe, very lightweight headphones designed for communications equipment.

HC-10: DIGITAL WORLD CLOCK

The HC-10 is a highly advanced world clock with dual display which can memorized 10 preset world major cities and 2 additional programmable regions.

CRYSTAL FILTER FOR CW OPERATION

The YG-455C (option) is designed to minimize interference during CW reception.

Pass band Width..... 500 Hz (-6 dB)
Center Frequency..... 455.7 kHz

CF FILTER INSTALLATION

1. Using a #2 Phillips screwdriver, remove the bottom cover (8 screws).
2. Remove the 10 screws holding the IF unit X55-1430-00 and carefully unplug the five connectors at the side and rear corner. Swing the printed circuit board over.
3. Using a 45W (or less) soldering pencil, clear the six holes for the filter, if they are filled with solder.
4. Install the filter into its position on the IF unit. Tighten the 2 nuts, and solder the 4 input and output pins to the circuit board. Solder sparingly, and heat the connections only long enough to insure a good solder joint. Don't overheat the filter or the circuit board.
5. Carefully inspect your soldering. Be certain that all pins are actually soldered, and that you have not soldered across any spots on the board or between any of the pins on the filter. Clip the pins flush to the board.
6. Replace the IF unit. Make certain no wires will be pinched underneath the board. Replace the 10 screws and five connectors.
7. Reinstall the bottom cover.
8. Apply power and verify your work. Filter installation is now complete.

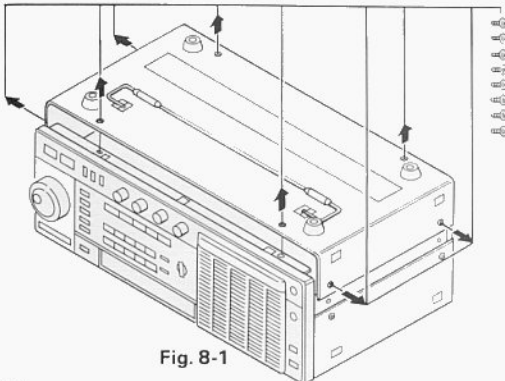

Fig. 8-1

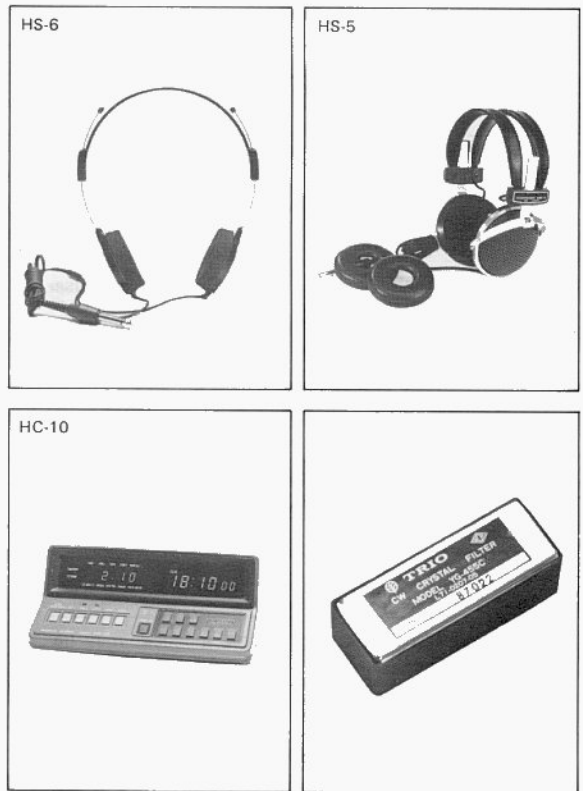

Fig. 8-2

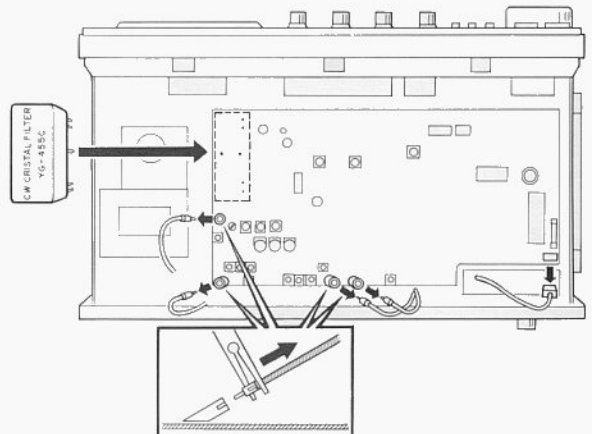

Fig. 8-3

KENWOOD CORPORATION

Shionogi Shibuya Building, 17-5, 2-chome Shibuya, Shibuya-ku, Tokyo 150 Japan

KENWOOD U.S.A. CORPORATION

2201 E. Dominguez Street, Long Beach, California 90810 U.S.A.

KENWOOD ELECTRONICS DEUTSCHLAND GMBH

Rembrücker Str. 15, 6056 Heusenstamm, West Germany

KENWOOD ELECTRONICS BENELUX N.V.

Mechelsesteenweg 418 B-1930 Zaventem, Belgium

KENWOOD ELECTRONICS AUSTRALIA PTY. LTD.

(INCORPORATED IN N.S.W.)

4E. Woodcock Place, Lane Cove, N.S.W. 2066 Australia