

KENWOOD

TS-670

ALL MODE QUAD BANDER

INSTRUCITON MANUAL



Thank you for buying the TS-670 amateur band transceiver. This equipment has been carefully engineered and manufactured to rigid quality standards and should provide satisfactory and dependable operation for many years.

■ STANDARD ACCESSORIES

The following parts are supplied with TS-670 as standard accessories.

- **DC power cord** (E30-1648-05)1
- **Fuse** (F05-4022-05)1
- **Instruction manual** (B50-4115-00)1
- **Warranty card** (for USA)1
- **Microphone** (option for USA)1

◦ **After unpacking**

• **Shipping container**

Save the box and packing in the event your unit needs to be transported for remote operation, maintenance, or service.

• **The following explicit definitions apply in this manual:**

NOTE:

If disregarded, inconvenience only, no risk of equipment damage or personal injury.

CAUTION:

Equipment damage may occur, but not personal injury.

■ CONTENTS

1. FEATURES	3
2. PREPARATION BEFORE USE	3
3. CONTROLS, INDICATORS AND CONNECTORS	4
4. OPERATION.....	6
5. TROUBLESHOOTING.....	30
6. ACCESSORIES	31
7. INTERNAL VIEWS	32
8. BLOCK DIAGRAM.....	32
9. SPECIFICATIONS.....	33

1. FEATURES

1. Built-in 4 bands, 7 MHz-50 MHz:

Three HF bands, 7 MHz, 21 MHz, 28 MHz and one VHF band, 50 MHz are provided. Band selection is accomplished by the UP/DOWN switch. Each band covers 1 MHz. Operating frequency can be continuously varied by the main tuning control.

2. All mode operation

Applicable to SSB, CW, FM (option) and AM (AM filter optional) modes. The transceiver is capable of operating in SSB, CW, FM (option) and AM (optional AM filter).

3. 500 kHz-30 MHz general coverage receiver:

With the optional GC-10, the TS-670 works as a general coverage receiver (except for the frequencies near 8.83 MHz).

4. Various frequency control functions:

- Selectable tuning rate, 10 Hz steps or 100 Hz steps for AM, SSB and CW, 10 kHz and 100 Hz for FM.
- Two different VFO's are built into the set allowing cross-band operation.
- 80 channel memory for band-mode information.
- Pushbutton frequency entry is also possible using the 0~9 keys.
- Provided with two kinds of scanning function.
- Memory channels are selectable with the main tuning control.

5. Lithium battery memory backup.

6. Built-in all mode squelch circuit.

7. An IF shift circuit is provided to allow shifting the IF passband, to aid in reducing adjacent channel interference. Filter: wide/narrow selectable.

8. Built-in peak power meter.

9. Continuously variable TX power.

10. CW semi break in circuit

11. 2-color fluorescent display tube.

2. PREPARATION BEFORE USE

2-1 PRECAUTIONS ON INSTALLATION

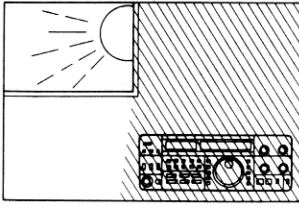

Avoid direct sunlight, and select a dry, well ventilated location.

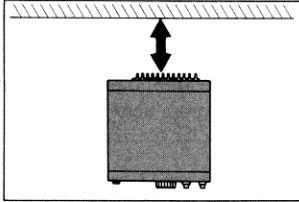

Since the heat sink is on the rear panel, avoid placing the equipment with the bottom and rear sides close to a wall or desk.

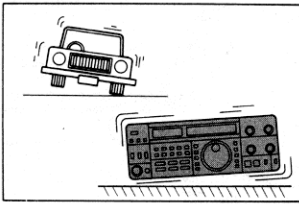

When installing the equipment in an automobile, ensure adequate ventilation. Install the equipment in a location where the rear does not make direct contact with the seat, and is not directly exposed to vibration.

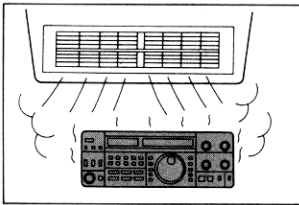

Avoid installing the equipment in front of the car heater air outlet.

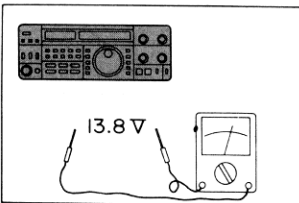

The standard operating voltage of the equipment is 13.8 V. Do not operate below 12 V or over 16 V.

2-2 PREPARATION BEFORE OPERATION

Before operating the equipment, the following preparation is required. Before connecting the power supply, carry out the following.

- (1) First, to familiarize yourself with the operation of this equipment, read the instruction manual thoroughly. If you are using the transceiver for the first time, practice while reading the manual, by actually operating each switch and control with the power switch OFF. After you have mastered the transmit procedure, you may begin actual operation.

NOTE:

Grounding

Making a good earth connection is important for preventing dangers such as electric shock and for emitting a high quality signal with minimum spurious radiation. Bury a commercially available ground rod or copper plate under the ground and connect it to the GND terminal of TS-670. A thick wire cut as short as possible, should be used for the connection.

A city water pipe cannot be used as a good earth in some cases.

Never use a gas pipe or electrical conduit pipe.

CAUTION:

Power supply

The standard operating voltage of TS-670 is 13.8 V and the current is 4 A. Do not use a power supply (both fixed and mobile) that provides over 16 V with the power switch of TS-670 turned off.

Operation under such a condition will void the warranty. Also, do not use a power supply that does not supply at least 12 V in transmit or receive. Use of such a supply may cause the performance of the TS-670 to suffer.

3. CONTROLS, INDICATORS AND CONNECTORS

Meter switch
 During transmission, the meter switch determines meter function. The switch selects between:
RF: In this position, the meter monitors the RF output of the transceiver.
ALC: The meter monitors the output of the final stage power amplifier during transmission. During SSB operation, adjust the MIC control so that the meter is within the ALC zone. Similarly, adjust the CAR control for CW operation.

Meter
 Works as an S-meter in receive, indicating the signal strength, and indicates the RF power or ALC level in transmit. These two modes are selected by the meter switch.

SPLIT indicator
 Lights when the SPLIT switch is ON.

VFO indicator
 Indicates VFO (A or B).

POWER switch
 Turns the TS-670 on (■) and off (■).

MCH (Memory Channel) display
 Indicates memory channels (1-79) or program scan (P).

NB (Noise Blanker) switch
 Set this switch to ON to eliminate short duration pulse noise.

VOICE switch
 Audible announcement of frequency when the VS-1 is installed.

STANDBY switch
REC: Indicates reception mode.
SEND: Indicates transmission mode.

ATT (Attenuator) switch
 Set this switch to ON to attenuate the input by approximately 20 dB.

NAR/WIDE filter selector
 Selects the passband width when optional filters are installed.

MIC (Microphone) connector
 Connect the microphone to this terminal.

PHONES jack
 Connect the headphone to this jack.

Numeric keypad
 Used to input numeric data for frequency etc. See page 18 for additional information.

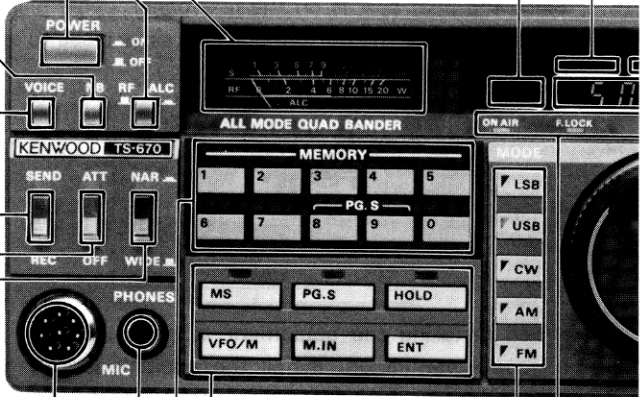

MODE switch
 Selects LSB, USB, CW, AM and FM (option) modes.

Scan/memory keyboard
 Used to select memory scan, program scan, VFO or memory operation and for memory input. See page 18 for additional data.

Indicators
 ONAIR : Li
 F.LOCK : Li
 S
 F.STEP : Li
 S

Frequency display
Indicates the operating frequency to the nearest 100 Hz.

RIT display
Indicates the RIT frequency with the RIT switch ON.

RF PWR (RF Power) control
Varies the transmit power in SSB, CW and FM modes.

MIC (Microphone Gain) control
Adjust the microphone gain in SSB and AM modes. Turn clockwise to increase the gain.

SQUELCH control
This is a squelch adjusting control. Turn clockwise to increase squelch. This control can be used in all modes.

RF (RF Gain) control
This is used to adjust the gain of RF amplifier stages of the receiver. Normally this control is set for maximum gain, full clockwise.

AF (Audio Gain) control
This is used to adjust the audio volume. Set this control to the desired position.

IF shift control
This is effective for eliminating interference from the near-by stations or for adjusting the receive tone quality.

RIT control
This allows shifting the receive frequency only, about ± 1.2 kHz.

RIT switch
This is the ON/OFF switch of the RIT circuit.

1 MHz step switch
This is used to vary the frequency in 1 MHz steps. This switch does not work unless the GC-10 (option) is connected.

BAND switch
This is the band selector. Press the UP button to switch to a higher frequency, and the DOWN button to a lower frequency.

VFO control
This is used to select the frequency. This is also used for memory channel selection.

lights in transmit.
lights when the LOCK switch is pressed.
lights when the STEP switch is pressed.

VFO keyboard
A/B : Selects the VFO (A or B).
SPLIT : For split frequency operations A-R, B-T or B-R, A-T.
A=B : During VFO operation, press this switch to equalize the frequency and mode of the idle VFO to that of the active VFO.
LOCK : Press this switch to lock the VFO and BAND switches.
STEP : Press this switch to change the VFO step.

ANT (Antenna) switch

Used to select either the 7-50 MHz or the 50 MHz connector.

7-50 MHz antenna connector

For connecting a single 7-50 MHz antenna. May also be used for a 7-28 MHz antenna with the proper setting of the ANT switch.

50 MHz antenna connector

Used for connection of a separate 50 MHz antenna.

KEY jack

Connect a key to this jack when operating in CW mode.

EXT SP (External Speaker) jack

An external speaker terminal. Use the supplied plug when connecting an external speaker.

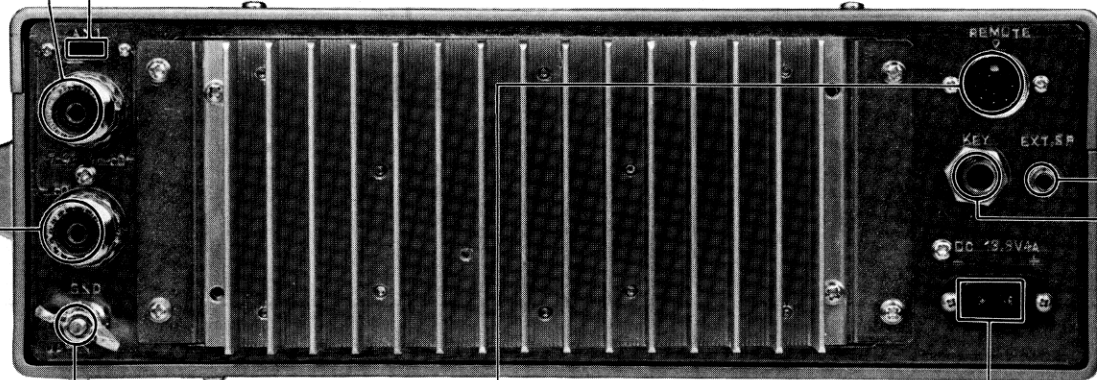

GND terminal

The TS-670 should be grounded through this terminal to avoid the possibility of TVI and BCI.

REMOTE connector

Use this connector when the TS-670 is operated in conjunction with an external device. This connector is internally connected as shown in the illustration. For connection use the supplied 7P DIN plug.

DC power connector

Connect a DC power supply to this connector using the supplied power cord. The standard voltage is 13.8 V. Pay attention to polarities.

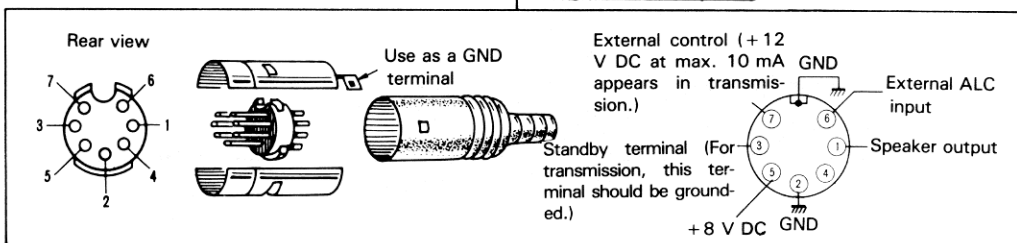

4. OPERATION

4-1 Connection

Make connection of TS-670 as shown below.

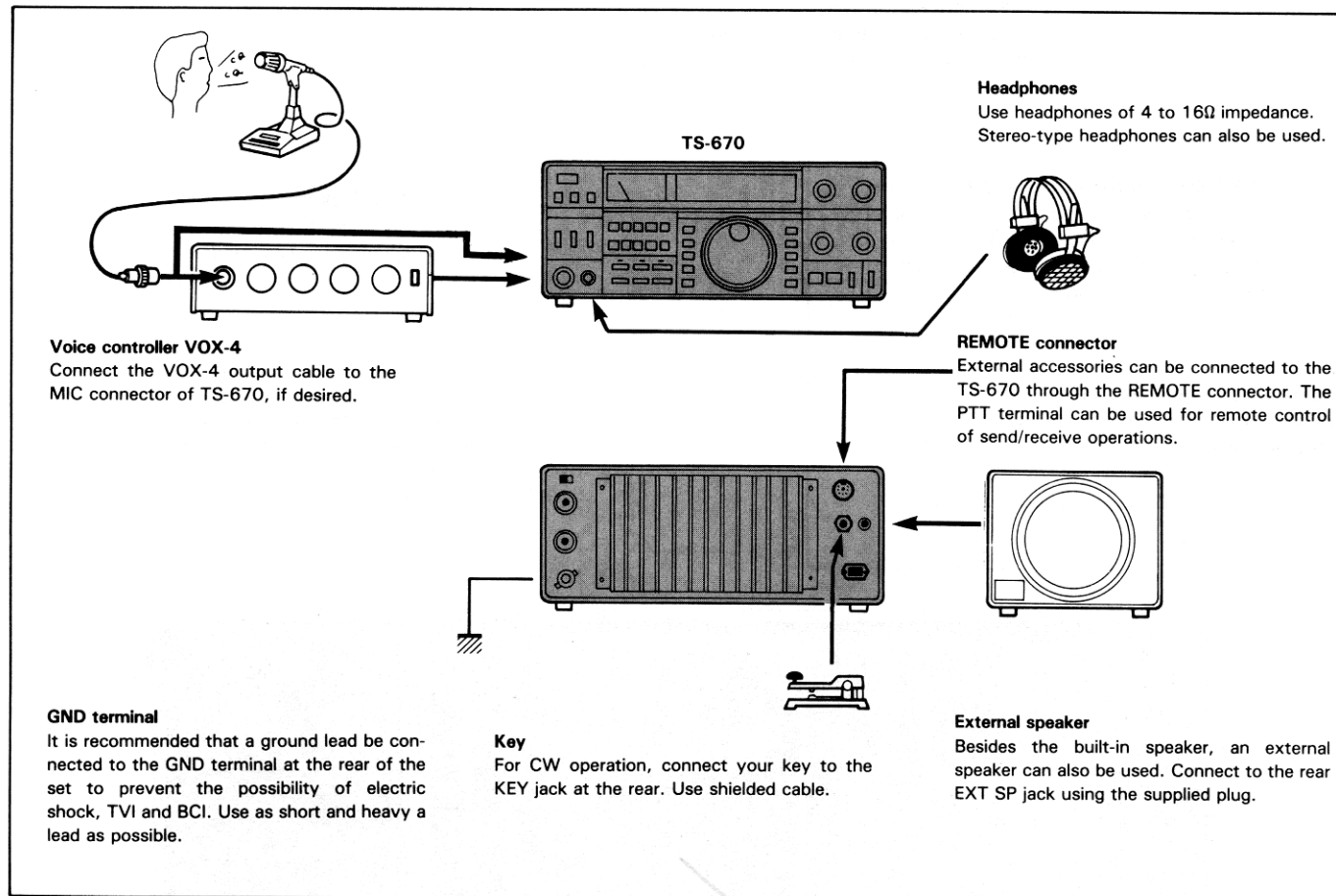

4-2 CONNECTION OF ANTENNA AND POWER SUPPLY FOR FIXED STATION

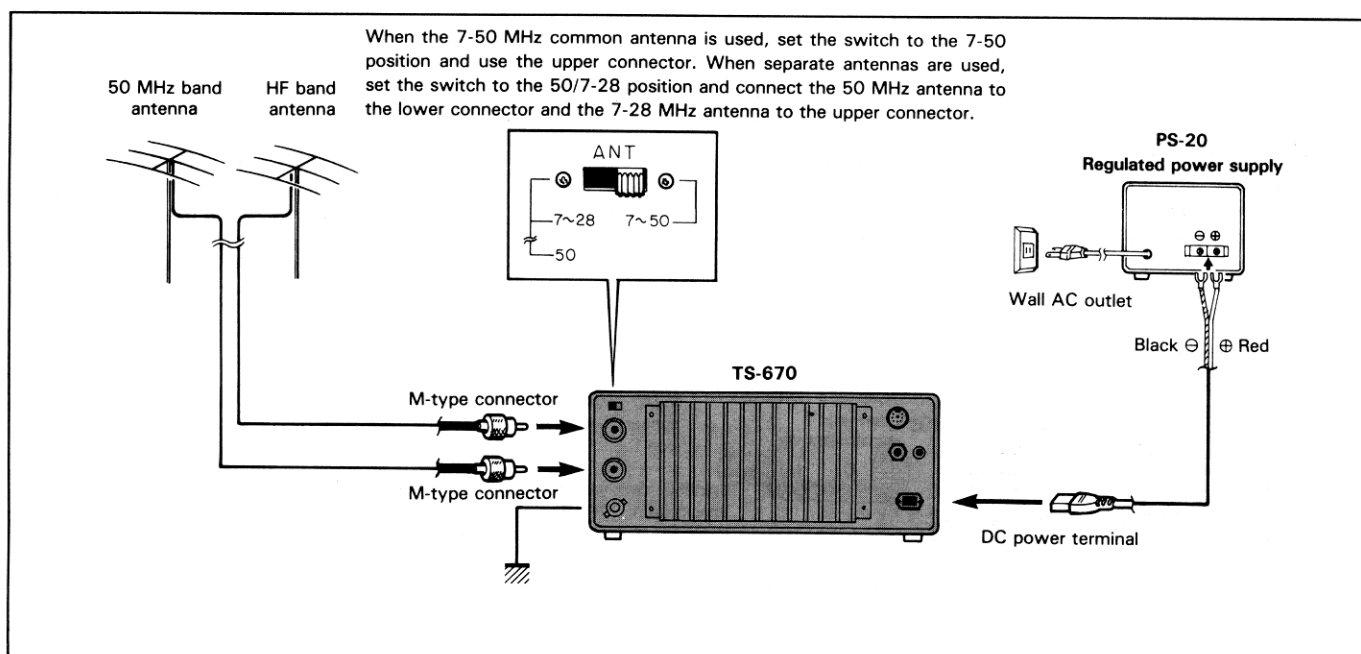

■ 4-3 CONNECTION OF MOBILE ANTENNA AND POWER SUPPLY

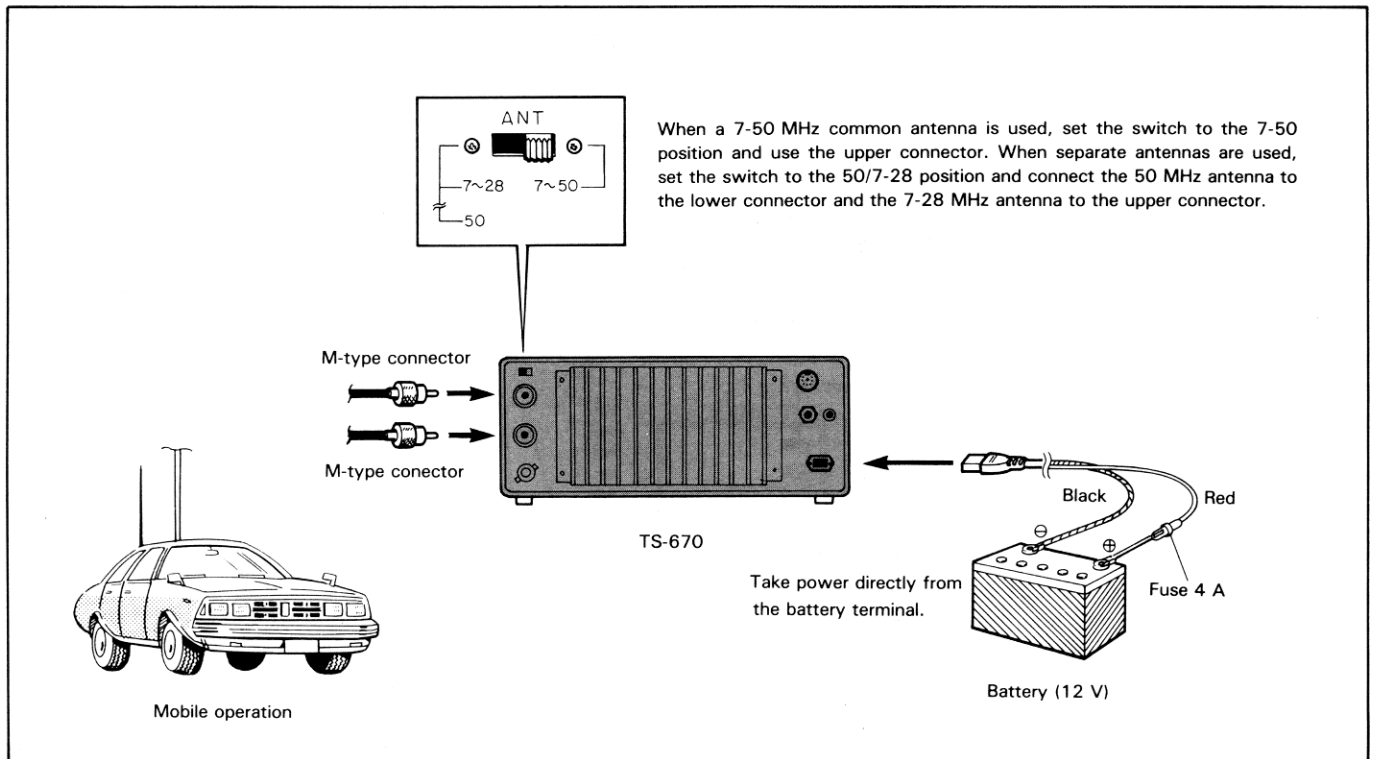

NOTE:

Before connecting and disconnecting the power connector, be sure to turn off the power switches of the TS-670 and the PS-20.

■ 4-4 RECEPTION

- (1) First connect the antenna, microphone and key. Preset the controls as shown at the left.

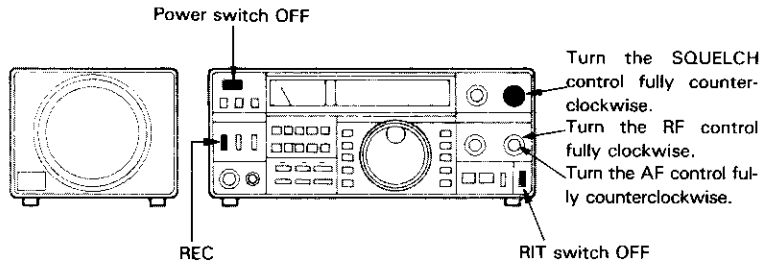

- (2) Turn the POWER switch on. (First turn on the power switch of PS-20 and then, the POWER switch of TS-670 when operating fixed station.)

- (3) The meter and digital display will illuminate, indicating the transceiver is in operation.

- (4) Select the desired band with the BAND switch (UP or DOWN).

- (5) Select the desired mode. (In SSB, LSB for 7 MHz or lower and USB for over 10 MHz is commonly used by international convention.)

- (6) Adjust the AF control to obtain the desired volume.

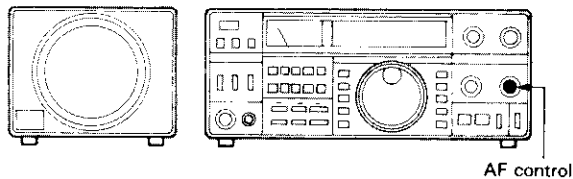
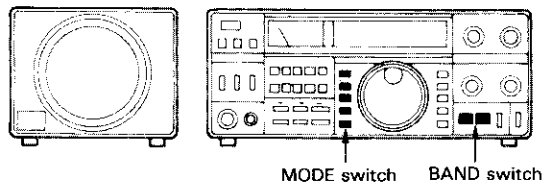

- (7) Turn the VFO control slowly so the desired signal can be heard clearly.

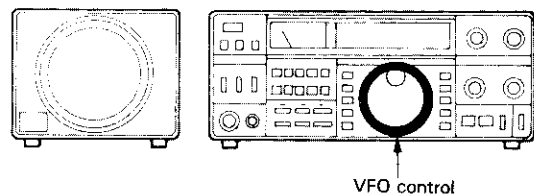

NOTES:

1. A weak beat will be heard at 53.9999 MHz. This is normal and is not an indication of trouble.
2. In AM mode without the YK-88A filter (option), the passband is the same as in SSB mode.

(1) How to use the RF ATT switch

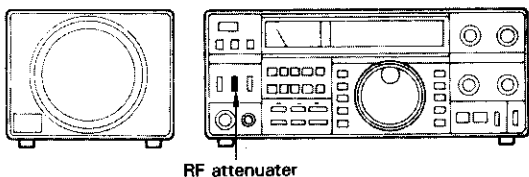

RF ATT SWITCH

When this switch is turned on the input to the receive RF amplifier is attenuated approximately 20 dB, providing distortion-free reception. This feature may be used in cases of receiver overload, caused either by a strong local signal, or during weak signal reception when a strong adjacent signal may blank the receiver.

(2) How to use the RF control

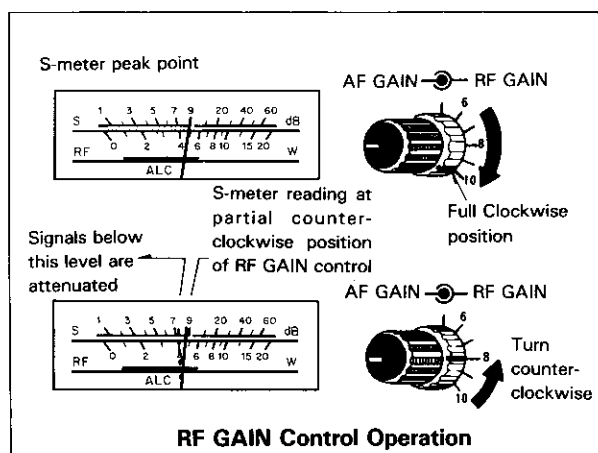
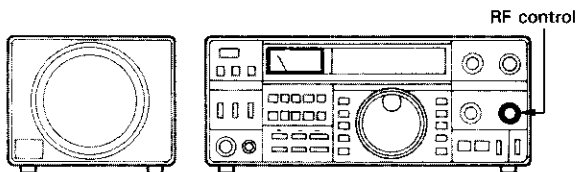

RF GAIN CONTROL

For normal operation, this control should be turned fully clockwise for maximum sensitivity. Receive sensitivity is reduced by turning the control counterclockwise. Adjust the RF GAIN so the S-meter does not show excessive deflection. This minimizes noise during reception and allows the S-meter to indicate signal peak (or a little below that point). Noise is markedly reduced when signals are absent.

(3) How to use NB switch

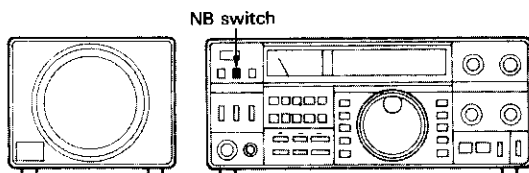

NB SWITCH

The TS-670 has a sophisticated noise blanker designed to reduce ignition-type pulse noise. The noise blanker is particularly important for mobile operation. When necessary, activate the noise-blanker by depressing the NB switch to ON.

(4) How to use SQUELCH control

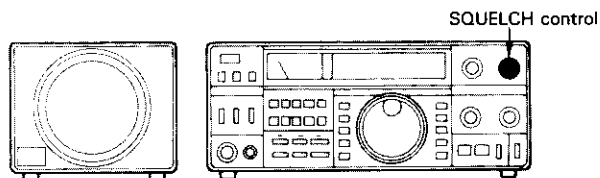

SQUELCH

To eliminate receiver noise during no-signal periods, slowly advance the squelch clockwise until the noise just disappears (threshold point).

The squelch will open and the speaker will operate when a signal is received. If the signal is weak or fades, readjust the squelch for consistent reception.

NOTE:

Squelch operation is possible in all (FM, SSB, CW and AM) modes, but the threshold point differs a little in each mode. Operation of the squelch circuit also varies depending on the external noise strength.

(5) How to use the RIT control

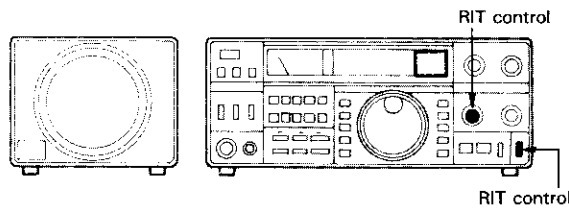

RIT CONTROL

By using the RIT (Receiver Incremental Tuning) control, the receive frequency can be shifted approximately ± 1 kHz without changing the transmit frequency.

If the frequency of the station you are working changes, your receiver frequency can be reset by turning the RIT switch ON, and adjusting the RIT control. Adjusting the control clockwise increases the frequency.

NOTE:

When first calling another station, the RIT should be OFF, otherwise your transmit and receive frequency will not coincide.

(6) How to use the IF SHIFT control

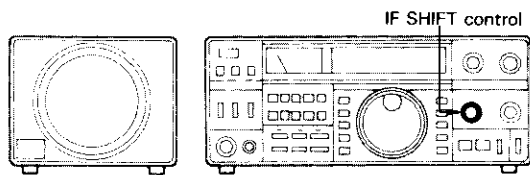

IF SHIFT CONTROL

The IF SHIFT control is used to shift the passband of the IF filter without changing receive frequency. By turning this control in either direction, the IF passband is shifted as shown in the figure at left.

The IF SHIFT is effective in eliminating interference when nearby signals are superimposed on the receive signal during either SSB or CW operation. IF SHIFT does not operate in the AM or FM modes.

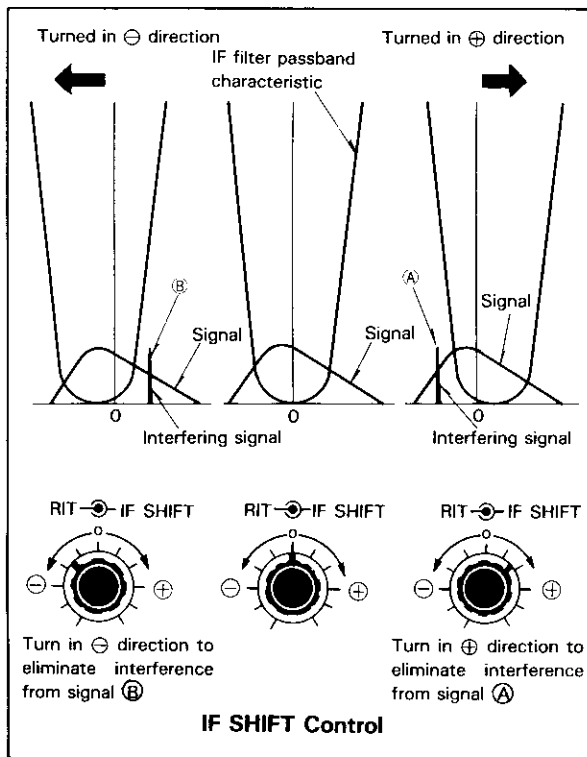

- **USB Mode (21 MHz, 28 MHz and 50 MHz bands)**

Adjust the IF SHIFT control in the + direction and lower frequencies are cut. Adjust the control in the - direction and high frequencies are cut.

- **LSB Mode (7 MHz and below)**

Adjust the control in the + direction and higher frequencies are cut. Adjust the control in the - direction and low frequencies are cut.

- **CW Mode**

By using the IF SHIFT in conjunction with the RIT, tone quality can be adjusted.

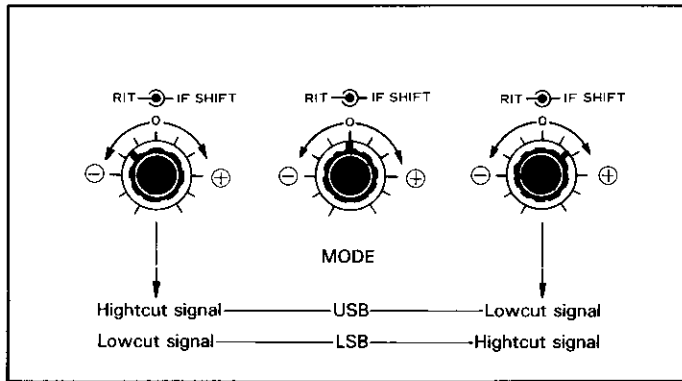

For short to medium distance communication, the WIDE position may be used for CW operation. For DX (long distance) communication, the NAR position will be an advantage in reducing interference.

This feature, in combination with the IF SHIFT control, will provide outstanding interference rejection. The receive IF bandwidth is 2.5 kHz in the SSB and CW wide position, 270 or 500 Hz for CW (with optional filters YK-88CN or YK-88C) in the NAR position.

*in the AM MODE without an optional filter, both WIDE NARROW positions are 2.5 kHz. With a YK-88A, Wide is 6 kHz, and Narrow is 2.5 kHz.

*In transmit bandwidth is automatically WIDE.

(7) NAR-WIDE switch

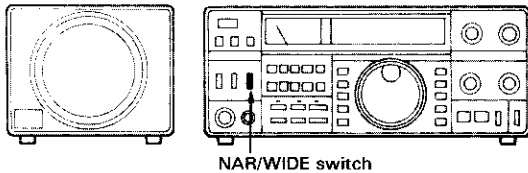

PASSBAND WIDTH (- 6 dB) kHz

MODE FILTER	CW		SSB		AM	
	WIDE	NAR-ROW	WIDE	NAR-ROW	WIDE	NAR-ROW
No optional filter	2.5	*	2.5	*	2.5	2.5
YK-88C or CN	2.5	500 or 270	—	—	—	—
YK-88A	—	—	—	—	6	2.5

NOTES:

1. In SSB, no reception is a result when the NAR/WIDE switch is set to NAR.
2. Without optional filters, there is no CW reception in the NAR switch position (*).
3. The NAR/WIDE switch does not function in the FM mode.

■ 4-5 TRANSMISSION

(1) SSB mode

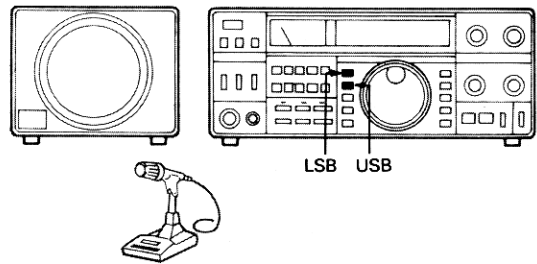

- (1) Set the MODE switch to LSB or USB.
LSB for 7 MHz or lower and USB for 10 MHz or over by international convention.

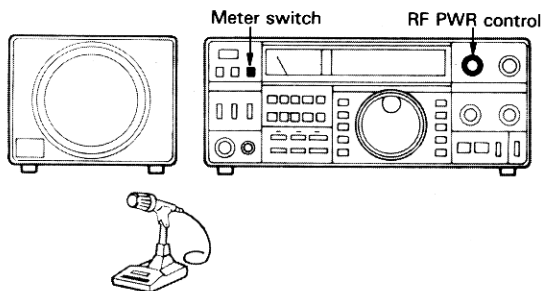

- (2) Set the meter switch to ALC.
- (3) Turn the RF PWR control fully clockwise.

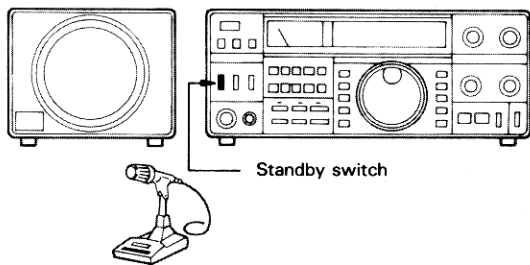

- (4) Press the PTT switch of the microphone, or set the standby switch to SEND.

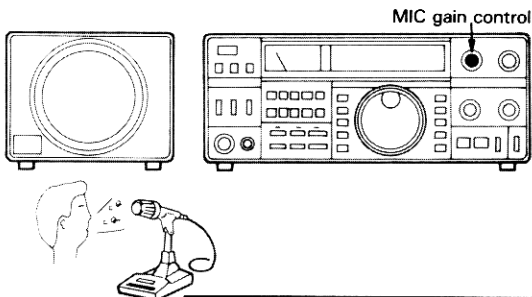

- (5) Speak into the microphone. Adjust the MIC gain control for an "ON-SCALE" meter reading on voice peaks.

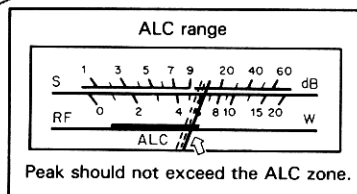

NOTE:

The RF meter pointer deflection may be small with some types of antenna. Therefore, monitoring the ALC reading during transmit operation will be effective. If the MIC gain is set past the ALC zone, it may cause distorted transmit audio.

An RF power control is provided with this transceiver for controlling the transmit power output.

Turning the RF PWR control counter clockwise reduces transmit power. This is useful for local QSO's.

(2) CW mode

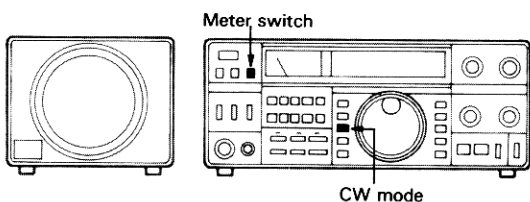

Set the MODE switch to CW, and the meter switch to ALC.

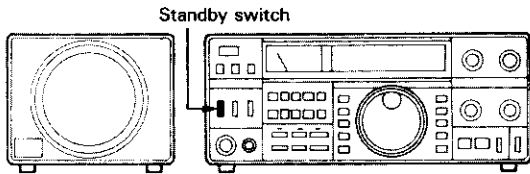

Set the standby switch to SEND, and press the key. Transmission is also possible by pressing the key with the standby switch set to REC. (Semi-break-in operation)

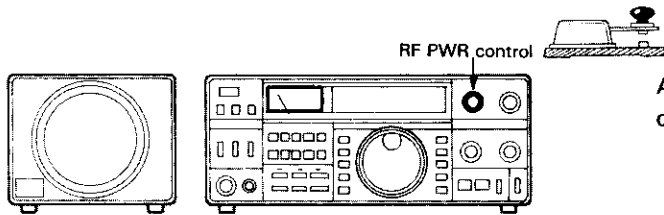

Adjust the RF PWR control so that the meter pointer deflects to about half of the ALC zone.

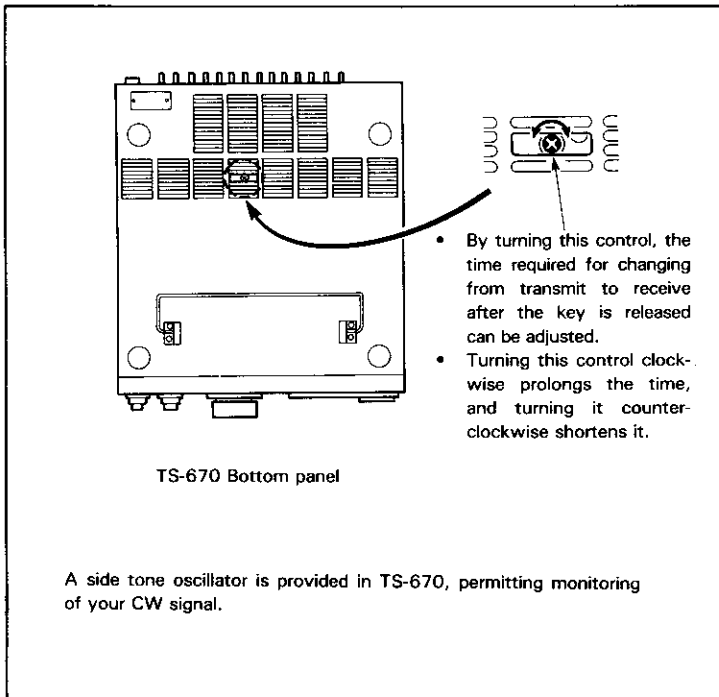

(3) AM mode

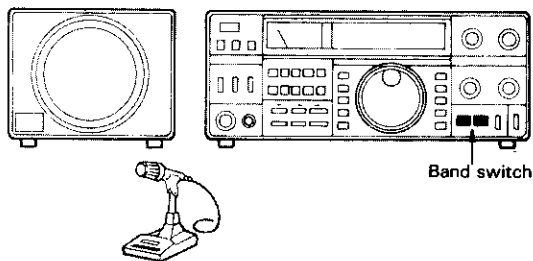

Select the desired frequency.

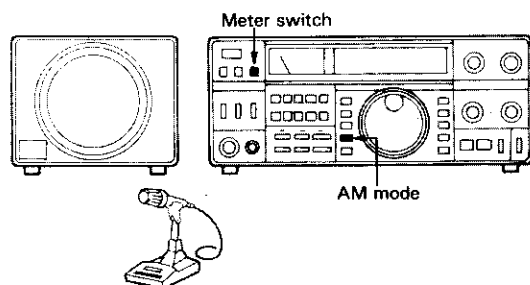

Set the MODE switch to AM.
Set the meter switch to RF.

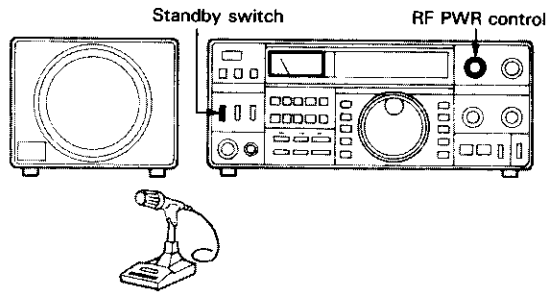

Press the PTT switch of the microphone, or set the standby switch to SEND. Adjust the RF PWR control so that the meter pointer deflects to 4 W.

NOTE:

While the protection circuit is activating due to poor antenna VSWR, turning the RF PWR control to the maximum may not provide 10 W meter reading. In such a case, check the antenna VSWR. If it is poor, correct before transmitting.

Speak into the microphone and adjust the MIC gain control so that the RF PWR meter reading does not exceed 8 W at voice peaks.

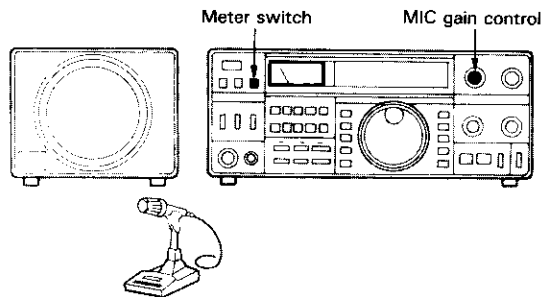

(4) FM mode (With FM-430 installed)

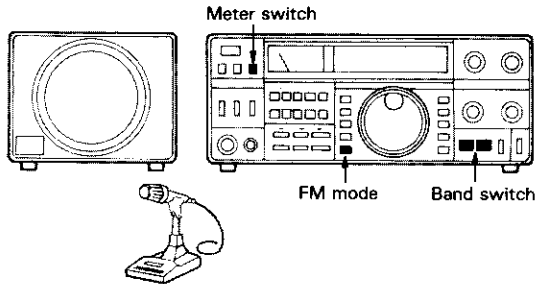

Set the MODE switch to FM, and the meter switch to RF.

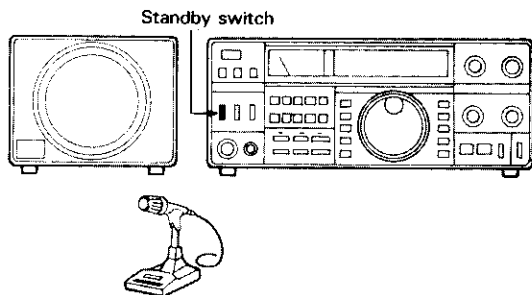

Press the PTT switch of the microphone, or set the standby switch to SEND.

NOTE:

In FM mode, the MIC control is not used.

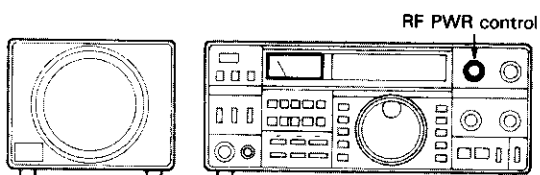

The RF power control is provided on the TS-670 to change the transmit power.

The transmit power can be lowered by turning the RF PWR control counterclockwise. This feature is effective for local communications.

The RF power control works only in SSB, CW and FM modes.

NOTES:

1. Before transmitting, be sure to connect an antenna with a low SWR. The TS-670 is provided with a final protection circuit to protect the final stage.
2. However, if the antenna terminal is open, a failure may occur. So never transmit without an antenna.
3. The RF PWR meter does not indicate correctly when the antenna VSWR is poor. Keep the VSWR as close to 1:1 as possible.

■ 4-6 HOW TO USE BAND (UP/DOWN) SWITCH

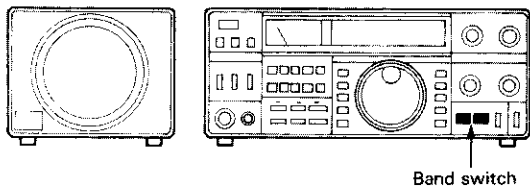

1. When the GC-10 general coverage unit (option) is not connected.
(1 MHz step switch OFF)

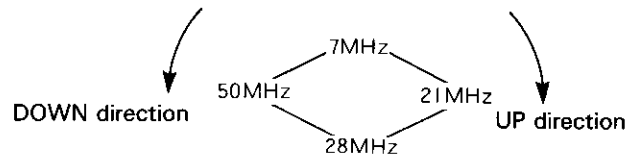

2. When the GC-10 general coverage unit (option) is connected.

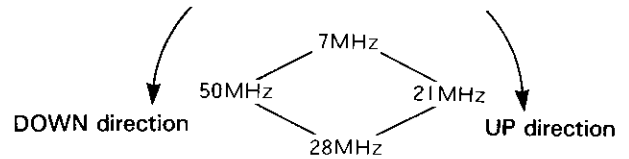

Works in this way.
(The 1 MHz step switch does not work.)

(1 MHz step switch ON)

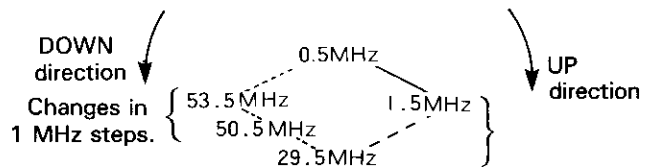

NOTES:(GC-10 unit is mounted)

1. When the DOWN switch is pressed with the VFO set to 1.000 MHz-1.4999 MHz, the VFO changes to 500 kHz.
2. When the DOWN switch is pressed with the VFO set to 999.9 kHz or lower, the VFO changes to 53 MHz.

■ 4-7 DUAL VFO OPERATION

(1) How to use the **A/B** switch

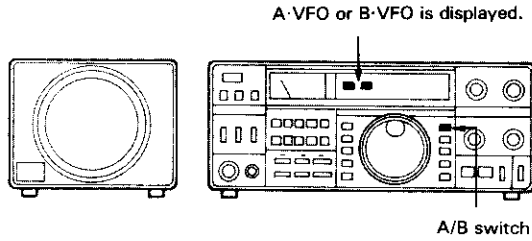

When the **A/B** switch is pressed, VFO-A or B will be displayed, indicating which VFO is operating.

(2) How to use the **SPLIT** switch

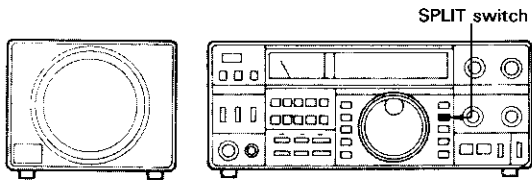

When receiving on VFO-A pressing the **SPLIT** switch will cause the transmit frequency to be on VFO-B. When receiving on VFO-B and pressing the **SPLIT** switch, the transmit frequency will be on VFO-A.

(3) How to use the **A=B** switch

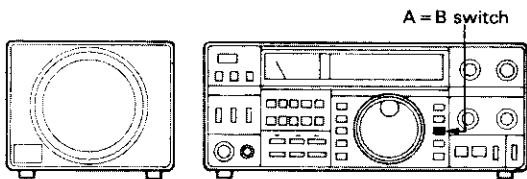

By pressing the **A=B** switch, the frequency and mode of the idle VFO are equalized with those of the operating VFO.

For example:

When VFO-A is 7 MHz LSB and VFO-B 21 MHz USB, pressing **A=B** will change VFO-B to 7 MHz LSB.

(4) How to use the **LOCK** switch

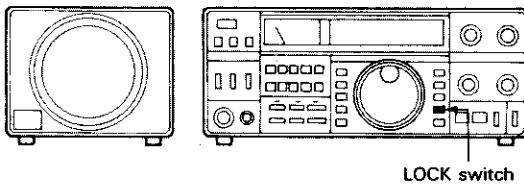

When the **LOCK** switch is pressed, the F.LOCK indicator lights on the display and the VFO and BAND switches (MIC UP/DOWN) are locked. This is useful for mobile operation. The RIT control is still active.

(5) How to use the **STEP** switch

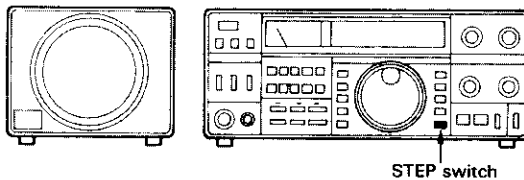

When the **STEP** switch is pressed, the **STEP** indicator lights on the display and the VFO step frequency is changed. See chart at left for step size explanation.

VFO frequency steps

STEP switch	SSB, CW-AM	FM
OFF	10 Hz	10 kHz
ON	100 Hz	100 Hz

- In SSB and CW modes, turn this switch on only for rapid frequency changes.
- In AM mode, tuning is easier with this switch ON.
- In FM mode tuning is in 100 Hz steps with the STEP switch "ON", and 10 kHz steps with the switch "OFF".

■ 4-8 CW OPERATION

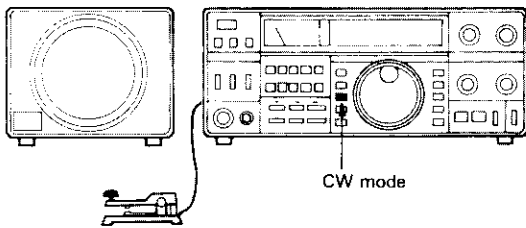

- When the YK-88C/CN filter (option) is not inserted:

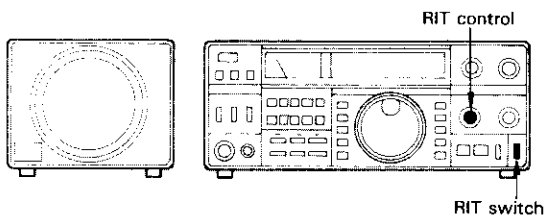
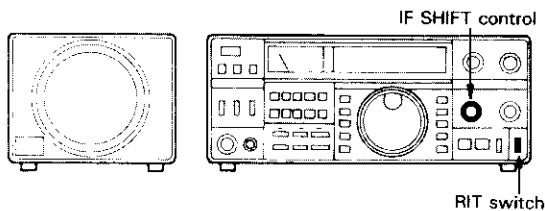

- When the YK-88C/CN filter (option) is inserted:

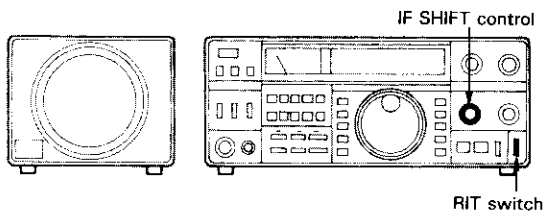

- When the key is connected:

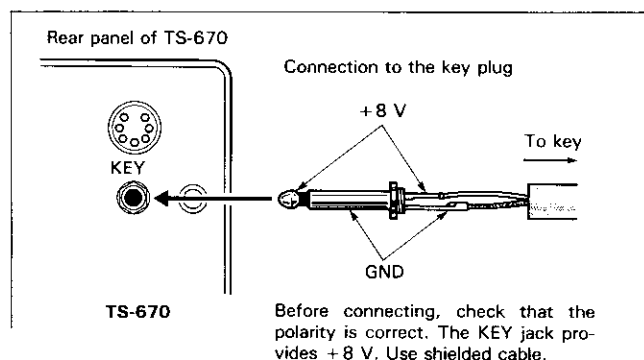

For CW operation, your transmit frequency should be "zero-beat" to the transmit frequency of the station you are contacting. This also allows your contact to receive your signal without having to retune his receiver. Tuning methods are detailed in the following paragraphs.

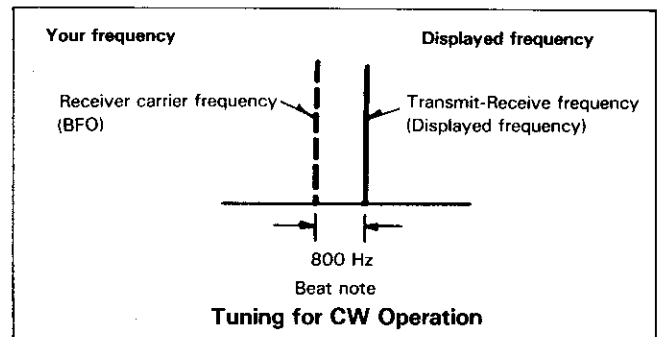

NOTE:

In CW mode, transmit frequency is displayed when both transmitting or receiving.

Set the IF SHIFT control to its center position and the RIT switch OFF. Adjust the main tuning control for an 800-Hz beat note and your transmit frequency will then coincide with that of your contact station ("zero-beat"). You may now adjust the RIT for a pitch which suits your preference. If interference is encountered, adjust the IF SHIFT. For more convenient and effective CW operation, use of the optional YK-88C or YK-88CN CW crystal filter is recommended.

Set the IF SHIFT to its center position and the RIT to OFF. Adjust the main tuning control for maximum deflection of the S-meter. Receive signal pitch will be about 800 Hz, indicating correct tuning.

NOTE:

When using an electronic keyer, make sure that polarity is set for positive. Always use shielded line from the key to transceiver.

■ 4-9 MEMORY CHANNEL OPERATION

The memory is used to store frequently used frequencies and specific frequencies. There are 80 channels in the memory. It is convenient to store data by considering 10 channels as one group. For example, channels 10 – 19 are for 7 MHz band LSB, channels 50 – 59 for 50 MHz

band USB, channels 60 – 69 for 50 MHz band FM, and channels 70 – 79 for short wave broadcasting. As memory scan can be designated for each group, this way of sorting the channels is easy to identify and convenient for memory scanning.

(1) Memory input

Use the **MIN** (Memory IN) switch.

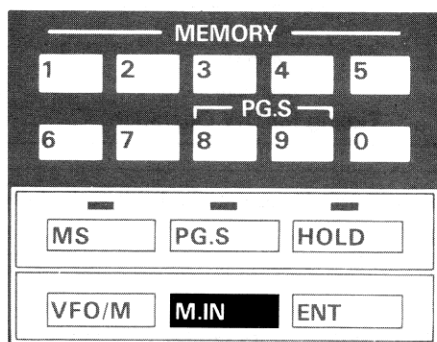

- (1) Select the frequency to be stored using the VFO control or the **ENT** key.
For operation of the **ENT** key, refer to 4-9-3 keyboard. Frequency entry on the following page.
- (2) Press and hold the **MIN** switch.
- (3) Select the desired channel (0 – 79) using the keypad.
- (4) The designated channel numbers are displayed in the **MCH** display, the mode and displayed frequency are entered into memory.
- (5) Release the **MIN** switch.

NOTE:

To designate a 2-digit channel, press the 1st digit number key and then, press the 2nd digit number key.

(2) Memory recall

2-1 When using the **VFO/M** (VFO/Memory) switch

Operation will be similar to that of a fixed channel. RIT is still possible.

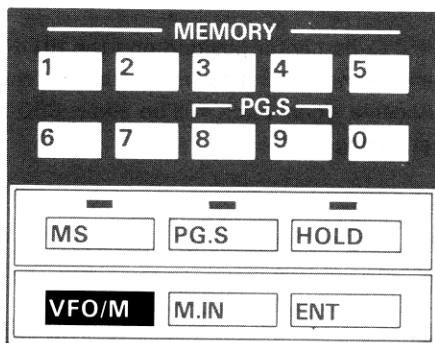

- (1) Set the **VFO/M** switch to ON.
- (2) M.CH number will be displayed.
- (3) Select the desired channel (0 – 79) using the keypad.
The stored channels can also be selected by the main dial. One full turn of the main dial is equivalent to 15 channels.
- (4) Pressing the **VFO/M** switch again restores operation to the VFO.

2-2 Memory recall using the keypad

- (1) To select the desired memory channel (0 – 79) while in the VFO A or the VFO B mode, press the desired channel number using the keypad.
- (2) The **MCH** channel number will be momentarily displayed and the display will indicate the frequency that was stored in that channel. The main tuning dial and the RIT will still be functional.

NOTE:

The frequency that was displayed prior to keypad recall will be erased from the display.
The contents of the memory channel will not be erased.

(3) Keyboard frequency entry

Frequency can be designated by operating the **ENT** switch and the 10-key.

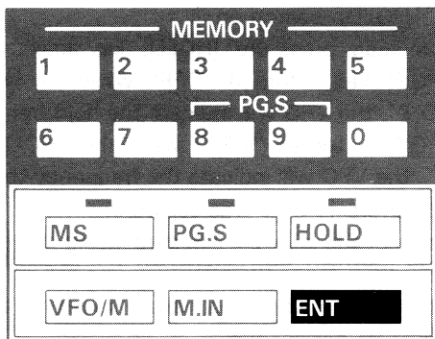

- (1) Set the **ENT** key to ON.
- (2) The letter and two dots will be displayed.
- (3) Press the keys corresponding to the frequency to be selected.
- (4) For entry to the nearest 10 Hz, press **2**, **1**, **2**, **3**, **4**, **5** and **6** keys. The frequency is displayed to the nearest 100 Hz.
- (5) Press the **ENT** key.

NOTES:

1. If the frequency is entered to the nearest 10 Hz, it is not necessary to press the **ENT** key.
2. It is not necessary to enter trailing zeros. For example, 21.20000 MHz is entered as 21.2 MHz.
3. You must enter leading zeros. For example to enter 7 MHz press **0** **7** **ENT**. To enter 500 kHz press **0** **0** **5** **ENT**.
4. When recalling memory channel using the **VFO/M** switch, the channel number can be selected by using the **ENT** switch, if the channel has data stored. If the channel is vacant, the channel No. can not be set using this method.
5. Frequencies outside of the operating range can not be entered.
6. To display the frequency to the nearest 10 Hz see page 27.

(4) Scan

4-1 **MS** (Memory Scan)

Memory scan in the TS-670 is performed on groups of 10 memory channels at a time. For example channels 0 thru 9 are considered to be one group, channels 10 thru 19 are considered to be a group etc. The TS-670 can scan up to 20 channels (memory locations) at a time, so you must specify which channels (up to two groups) you wish to scan.

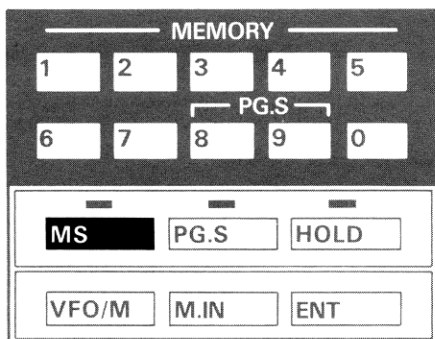

- (1) Press and hold the **MS** key.
- (2) Enter the first number of the two groups you wish to scan. For example: 10, and 40. Press **1** and **4** key.

NOTE:

To scan memory channels 0 – 9, simply press the **MS** key.

- (3) Release the **MS** key.
- (4) Scan will begin with the lowest channel.
- (5) To stop scan press the **HOLD** key.
- (6) To resume scan press the **HOLD** key again.
- (7) To release memory scan press the **MS** key again.
- (8) With the **STEP** switch OFF, scan speed is approx. 2.5 seconds per channel. With the **STEP** switch ON, scan speed is approx. 1.4 seconds per channel.

NOTES:

1. Transmit is inhibited when the **HOLD** switch or the **MS** switch is on.
2. During scan the band select relay will operate, as the different bands are selected.

4-2 **PGS** (Program Scan)

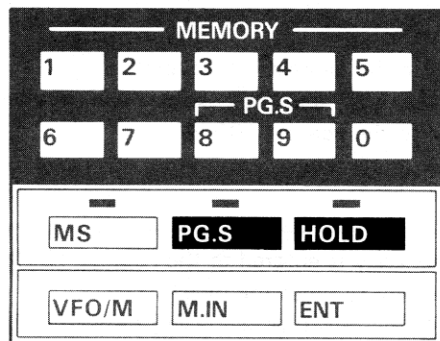

- (1) Enter the lower limit into memory channel 8, and the upper scan limit into memory channel 9 or vice versa.
- (2) To start scan press the **PGS** key.
- (3) To stop scan press the **HOLD** key.
- (4) The displayed frequency, and mode may be changed with the **HOLD** switch on.
- (5) To resume scan, press the **HOLD** key again.
- (6) If the **PGS** key is turned "OFF" while the **HOLD** key is "ON", the VFO will indicate the hold frequency. If the **PGS** is turned "OFF" while the **HOLD** key is "OFF", the VFO will indicate the frequency that was displayed before **PGS** was selected.
- (7) Two scan speeds can be selected using the **STEP** switch.
With the **STEP** switch ON, scan speed is approximately 600 Hz per second.
With the **STEP** switch OFF, scan speed is approximately 6 kHz per second.

NOTES:

1. Scan can take place only within a one MHz band-spread. For example: 28.000 – 28.9999 MHz. You cannot scan between bands, ie. 28.500 – 29.500 MHz.
2. When scan is initiated, the mode of channel 8 is selected.
3. When **PGS** has been selected, and the **HOLD** switch depressed you cannot change the scan speed, transmit, or enter memory.
4. The upper scan limit cannot be exceeded with the main tuning control when in "HOLD", the lower limit, however, can be passed.

(5) Memory erasing

Unnecessary memory can be erased by the **ENT** switch.

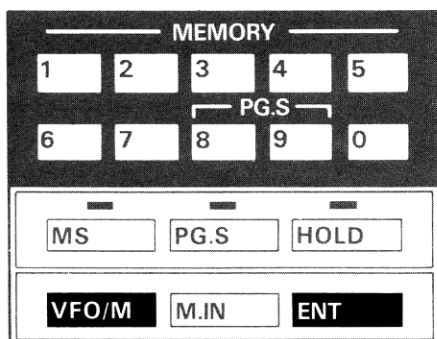

- (1) Press the **VFO/M** switch to select memory channel operation.
Designate the memory to be erased by operating the keypad or the tuning control.
- (2) Press the **ENT** switch and enter "00" by operating the 10-key.
- (3) Press the **ENT** switch again. Then, the designated memory is cleared.

■ 4-10 MIC UP-DOWN

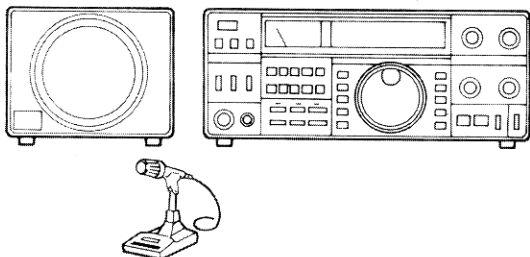

When a microphone with UP-DOWN pushbuttons is used with the TS-670, the frequency may be changed by depressing the desired button.

■ 4-11 VOICE SYNTHESIZER

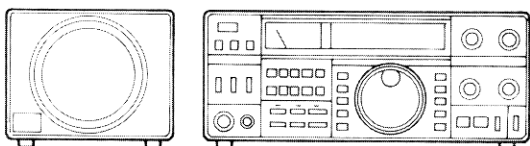

When the VOICE switch is pressed with the VS-1 installed, the displayed frequency will be announced to the nearest 100 Hz. If the VOICE switch is pressed in MCH operation and no frequency has been entered the voice unit will announce "OPEN".

■ 4-12 VOX-4 OPERATION

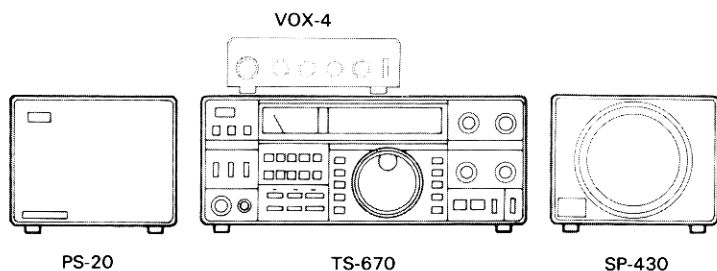

When used in conjunction with the VOX-4 the TS-670 is capable of voice operated keying in SSB, AM and FM modes.

NOTE:

If the VOX switch ON, and the TS-670 in CW mode, it is possible the radio may key due to voice input to the microphone. Therefore, turn the VOX switch OFF when in the CW mode.

■ 4-13 FIXED STATION OPERATION

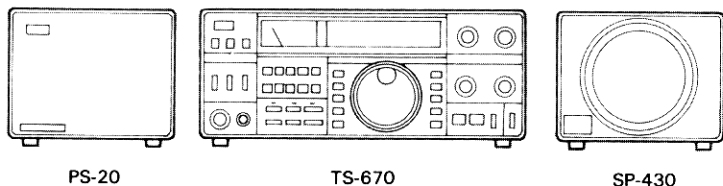

Connection of power supply:

A power supply of 13.8 V, 4 A or more is required at peaks in transmission.

The PS-20 is recommended. It matches the TS-670 in both design and performance.

NOTE:

Do not use a power source of less than 12 volts and greater than 16 V.

Antennas in Fixed Station:

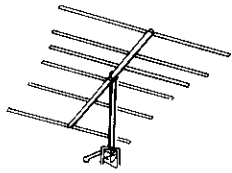

Beam antenna



Ground plane antenna

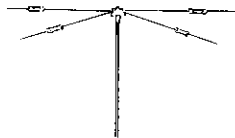

Dipole antenna

ANTENNAS

For HF fixed-station operation, an antenna specifically designed for amateur operation is recommended. Antenna types include wire antennas, verticals, rotary beams, and other antenna types. HF antennas are quite large and must be installed to withstand strong winds, heavy rain, etc.

Any antenna used with the TS-670 should be of 50-ohm impedance and should be connected using an appropriate coaxial cable such as RG-8/U.

Impedance matching is important. Impedance mismatching will result in a high VSWR and power loss, or can cause unwanted harmonic radiation and interference (TVI, BCI).

The impedance match can be checked with an SWR meter. Generally, satisfactory operation is assured when the VSWR (Voltage Standing Wave Ratio) is less than 1.5:1.

A rotary beam antenna is very effective for DX operation in the 14, 21, 28 and 50 MHz bands.

NOTE:

Protect your equipment-use a lightning arrester.

NOTE:

VSWR stands for voltage standing wave ratio.

■ 4-14 MOBILE STATION OPERATION

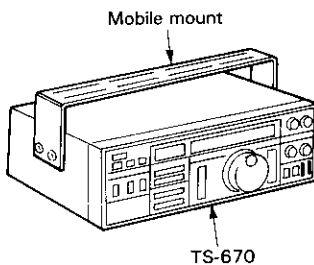

TS-670

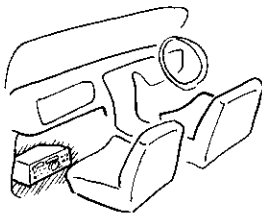

Install under dashboard

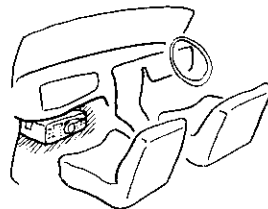

Under dashboard of passenger seat

INSTALLATION

Secure the TS-670 under the dashboard using the optional MB-430 mounting bracket (shown on page 31). As an alternative, use strapping, making sure that the TS-670 will not slip out of place while operating the vehicle.

NOTES:

1. Do not install the TS-670 near the heater outlet.
2. Allow sufficient space behind the TS-670 to ensure proper ventilation.

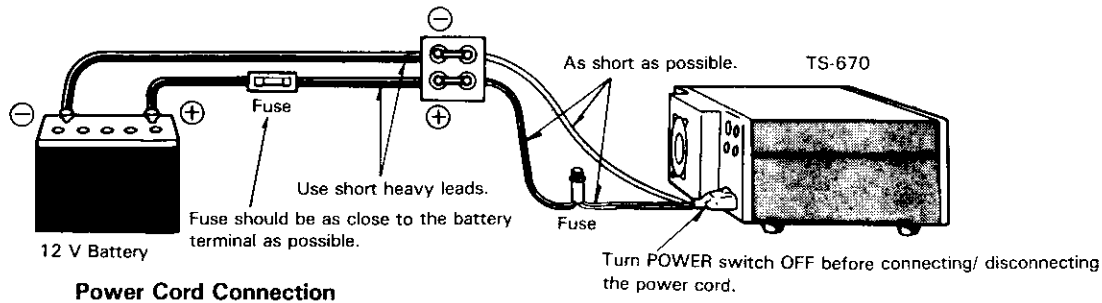

Connect the TS-670 power cable to the battery terminals, with consideration to current requirements and noise prevention. The maximum current drawn by the TS-670 reaches about 4 amps when transmitting. Therefore, the cable should be made as short as possible, using the specified fuse. Also, determine that the power system of the car (including the battery and generator or alternator) will handle the increased load of the TS-670.

Route battery and ANTENNA leads away from all high voltage secondary circuits to prevent ignition noise interference.

■ 4-16 MOBILE ANTENNA

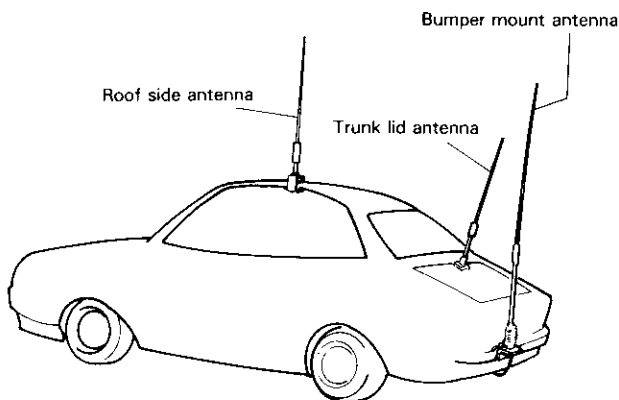
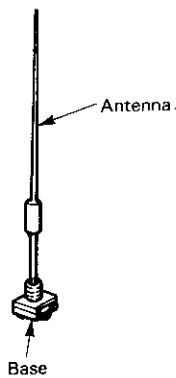

(1) Antenna Installation

Use a sturdy mount for the mobile antenna since HF antennas are larger (and have more wind load) and are heavier than VHF antennas. A bumper mount is recommended for general use. The ground side of the mount must be well grounded to the car body, since the body itself functions as the ground plane for the mobile antenna.

NOTES:

1. Some cars have plastic bumpers. For such cars, ground the antenna mount to the body.
2. When tuning a newly installed antenna, use the following procedure:
 - Turn the CAR control fully counter-clockwise for minimum transmit power.
 - With the transceiver in transmit mode, raise transmit power output slowly by rotating the CAR control clockwise. The antenna should be adjusted with minimum power.
 - Transmitting with full power is recommended only after the antenna has been adjusted for a VSWR below 1.5:1
3. Antenna installation is critical for successful mobile operation. For further information refer to THE RADIO AMATEUR'S HANDBOOK, RADIO HANDBOOK, or other texts.

(2) Coaxial Cable Connection

When the antenna is mounted on the vehicles bumper, the coaxial cable from the antenna can be routed through a drain hole in the trunk. When the antenna is roof mounted pass the cable between the body and door. Leave a driploop at the lowest point in the cable before entry into the vehicle to prevent water from entering the car.

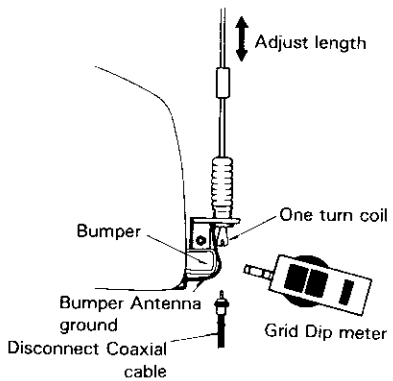

Adjusting Antenna Resonance

■ 4-17 NOISE REDUCTION

In motor vehicles, noise is generated by the ignition system. Other sources of noise include the wiper and heater motors.

Although the TS-670 is equipped with a noise blanker to minimize ignition noise, it is imperative that some preventive measures be taken to reduce the noise to the lowest possible level.

(3) Antenna Adjustment

Some mobile antennas are not designed at 50-ohm impedance. In this case, impedance matching between the antenna and the coaxial cable (50 Ω) is required. This can be achieved by using an antenna matching device or coupler.

The antenna to be used should first be checked with a dip meter to insure that it is designed for your operating band, then the impedance matching should be checked with an SWR meter.

The VSWR should preferably be less than 1.5:1 for satisfactory operation. For antenna adjustment refer to the antenna instruction manual.

(1) Antenna location Selection

Since ignition noise is generated by the vehicles engine, the antenna must be installed as far from the engine as possible.

(2) Antenna Matching

In general, mobile antennas have a lower impedance than the 50-ohm coaxial cable used to feed them, resulting in a mismatch between the antenna and the coax. Such trouble can be eliminated by using an antenna tuner between the TS-670 and the coaxial cable.

° Matching Circuit Examples

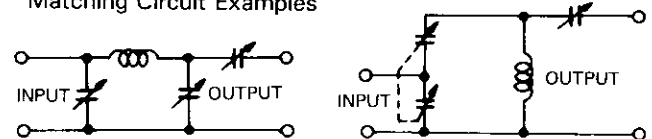

Matching Circuits

(3) Bonding

The component parts of motor vehicles, such as the engine, transmission, muffler system, accelerator, etc., are coupled to one another at DC and low frequencies, but are isolated at high frequencies. By connecting these parts using heavy, braided ground straps, ignition noise can be reduced. This connection is called "bonding".

(4) Use ignition Suppressor Cable or Suppressor Spark Plugs

Noise can be reduced by using spark plugs with internal resistors, or resistive suppressor ignition cable.

■ 4-18 POWER SUPPLY CAPACITY OF AUTOMOBILE

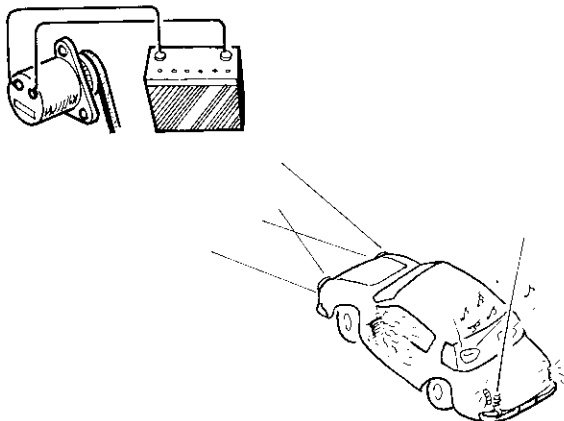

Battery Capacity

The power system of a motor vehicle is comprised of a battery and an alternator (which generates power while the engine is running) to supply current to loads or to charge the battery.

Since the transceiver draws high current during transmit, care should be exercised so the power system is not overloaded. When using the transceiver, the following points should be observed from the viewpoint of battery maintenance:

- (1) Turn the transceiver OFF when the lights, heater, wipers and other high-draw accessories are used.
- (2) Avoid transceiver operation when the engine is not running.
- (3) If necessary, use an ammeter and/or a voltmeter to check battery condition.

NOTES:

The standard supply voltage of TS-670 is 13.8 V. The standard current is about 4 A at transmission and about 1 A at reception.

Use of a voltage outside the 12 - 16 V range may cause reduced performance and or misoperation.

Avoid using such a voltage as a power supply.

■ 4-19 MICROPROCESSOR BACK-UP LITHIUM BATTERY

The TS-670 has a built-in lithium battery as a backup power supply for the memory. The life of this battery is estimated at 5 years. When the frequency display is reset by turning on and off the power switch (50.000.0 Hz, USB), it indicates expiration of the battery life. Replace the battery in this case.

When replacing the lithium battery for microprocessor back-up, consult an authorized agent or service station.

■ 4-20 OPTIONAL 10 Hz DISPLAY RESOLUTION

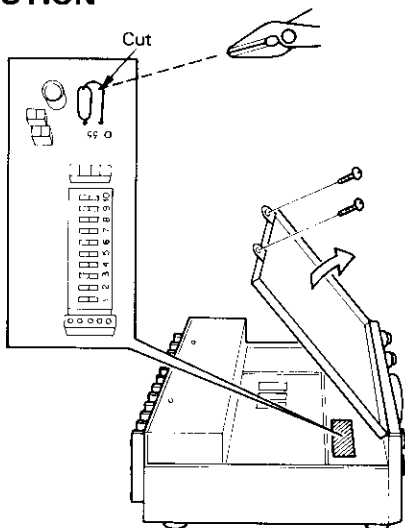

If you would like 10 Hz resolution instead of the supplied 100 Hz display resolution, cut D-55 as shown on the Control unit.

■ 4-21 INSTALLING GC-10

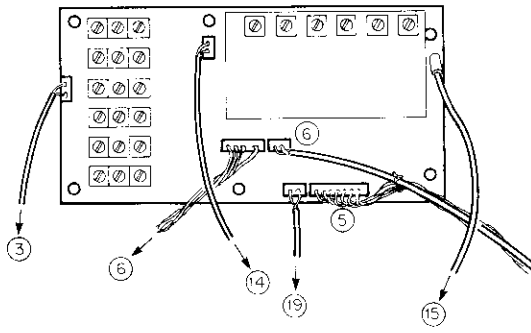

Make connection to each connector of RF unit.

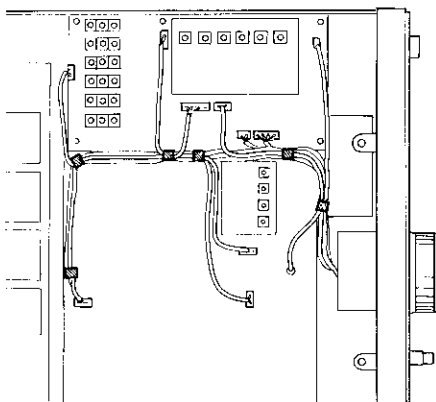
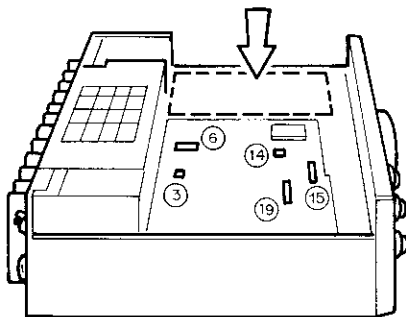
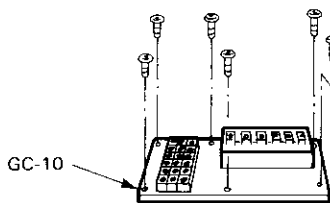

Wirings bound

GC-10 General Coverage Unit

Use of this unit will enable the receiver section of TS-670 for general coverage. The receiving frequency range becomes 500 kHz - 30 MHz. (However, 8.83 MHz and near-by frequencies cannot be received.)

Install the unit in the following sequence.

- (1) Remove the top cover of TS-670 using a No.2 Phillips screwdriver.
- (2) The speaker is mounted on the top cover. Take care not to break the lead wire when removing the top cover. The speaker lead wire may be unplugged.
- (3) Turn the TS-670 over, and remove the bottom cover using a No.2 Phillips screwdriver.
- (4) Install the GC-10 securely with 6 screws in the space adjacent to the RF unit, as shown at left.
- (5) Insert the connectors (2-pin and 7-pin) already wired to the TS-670 into the connectors Nos. 6 and 5 of GC-10, respectively.
- (6) Insert the connectors coming from GC-10 on the associated connector of RF unit (see the figure).
- (7) Secure the wires with a nylon band according to the figure as shown.
- (8) Replace the bottom cover and then the top cover. Be sure to reconnect the speaker lead..

4-22 VS-1 INSTALLATION

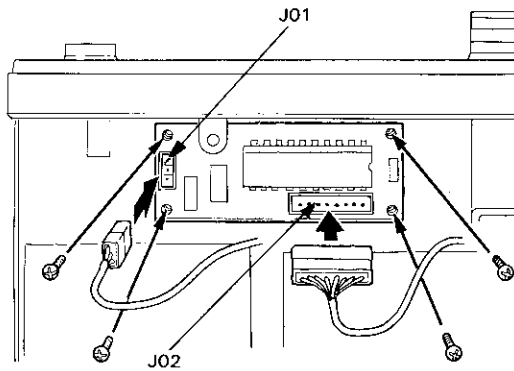

TS-670 top view

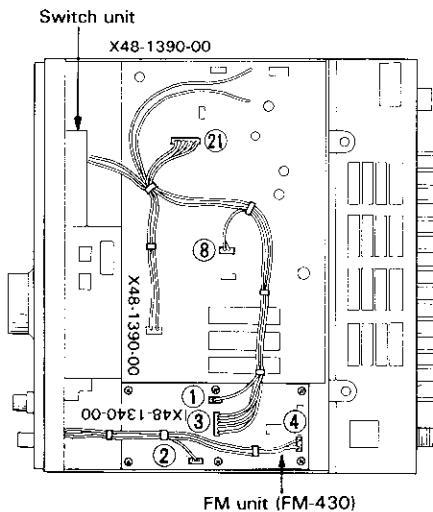

TS-670 bottom view

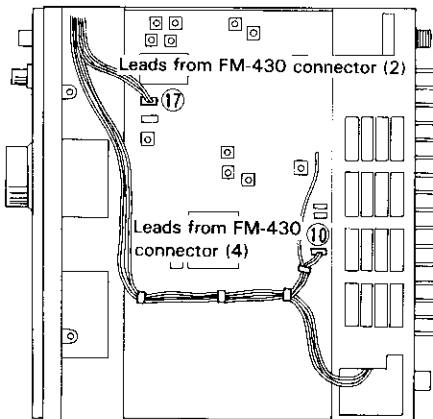

FM-430 Installation

NOTE:

Two 3-pin jacks are on the VS-1 pc board. The outer jack is J01. Use this jack when connecting.

When the VS-1 unit is installed, the displayed frequency is announced by voice.

To install, proceed as follows:

- (1) Remove the top cover with a No.2 Phillips screwdriver.
- (2) When removing the cover, be careful not to break the speaker lead since the speaker is mounted on the cover. Unplug the 2-pin lead, from the speaker.
- (3) Turn the TS-670 over and remove the bottom cover with the No.2 Phillips screwdriver.
- (4) Into the space between the RF unit and the front panel, right of the encoder unit, secure the VS-1 with the 4 screws supplied.
- (5) Connect 3-pin and 8-pin plugs equipped with the TS-670 as shown to J01 (3-pin jack) and J02 (8-pin jack).
- (6) Replace the bottom cover and then the top cover. Be sure to connect the speaker lead.

Optional FM-430 installation

- (1) Remove the transceiver top cover and unplug the speaker lead.
- (2) Mount the FM-430 on the top right side of the transceiver with the supplied 6 screws.
- (3) Connect the FM-430 harness to the transceiver as follows:
 - Connect the lead from connector (1) to connector (8) of the IF unit (X48-1390-00).
 - Connect the lead from connector (3) to connector (21) of the IF unit (X48-1390-00).
 - Arrange the lead from connectors (2) and (4) on the bottom of the transceiver to pass along the side of the Switch unit. Connect the lead from connector (2) to connector (17) of the RF unit (X44-1580-00). Connect the lead from connector (4) to connector (10) of the RF unit.
- (4) Tie the leads as illustrated using the supplied vinyl ties.
- (5) Reinstall the bottom cover, reconnect the speaker lead, and reinstall the top cover.

Connection of FM-430 Connectors

FM-430 connector No.	Unit and TS-670 connector No.
①	IF unit (X48-1390-00)..... ⑧
②	RF unit (X44-1580-00) ⑰
③	IF unit (X48-1390-00)..... ⑳
④	RF unit (X44-1580-00) ⑩

■ 4-23 INSTALLING OPTIONAL FILTERS

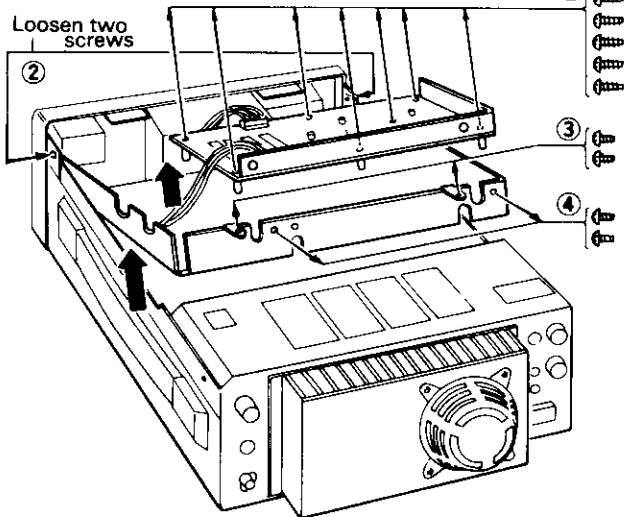
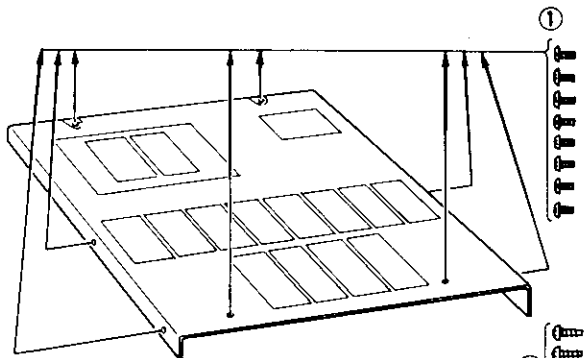
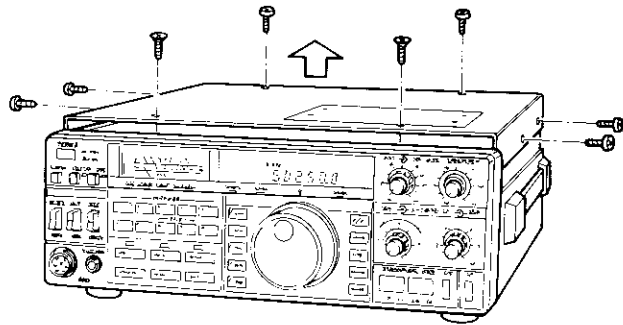

Filter disassembly detail

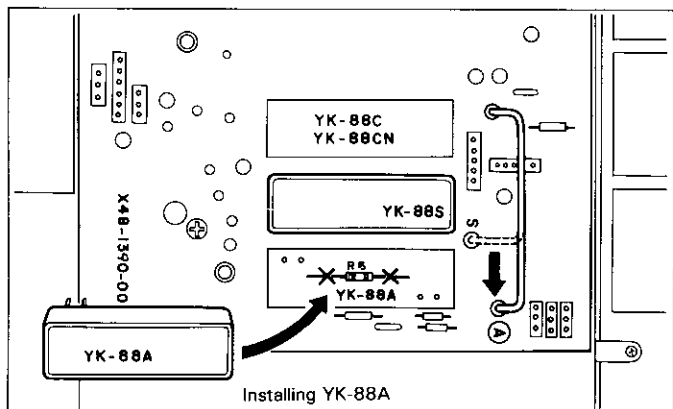

Installing the optional filters

- (1) Remove the power connector from the radio.
- (2) Using a #2 philips screwdriver, remove the top cover (8 screws). Be careful of the speaker lead, which may be unplugged.
- (3) Loosen the two side screws and remove the 2 screws securing the IF unit bracket. Swing the bracket up slightly to access and remove the two heat sink screws. Swing the assembly down.
- (4) Remove 7 screws from the IF unit. Switch the board forward. Protect the top of the front panel from scratching.
- (5) Using a 45 W (or less) soldering pencil, clear the 6 holes for the filter, if they are filled with solder. When installing an AM filter, first remove R5 on the IF unit.
- (6) There is no polarity to the filter. Install the filter into its position on the IF unit. Solder the 2 mounting tabs, and the 4 input and output pins to the circuit board. Solder sparingly, and heat the connections only long enough to insure a good solder joint. Don't overheat the filter or circuit board.
- (7) Carefully inspect your soldering. Be certain that all pins are actually soldered, and that you have not soldered across any spots on the board or between any of the pins on the filter. Clip the pins flush to the board.
- (8) Replace the IF unit in its place. Make certain no wires will be pinched underneath the board. Replace the 7 screws for the board, plus the two heat sink screws. Tighten the 2 side screws and replace the 2 rear bracket screws. (See that the wire harness does not interfere with the PG scan speed control).
- (9) Move the connection as illustrated when an AM filter is installed.
- (10) Reconnect the speaker lead, and reinstall the top cover.
- (11) Apply power and verify your work. Filter installation is now complete.

5. TROUBLESHOOTING

The problems described in this table are failures caused in general by improper operation or connection of the transceiver, not by defective components. Examine and check according to the following table. If the problem persists, contact an authorized agent or service station.

TRANSMISSION

SYMPTOM	CAUSE	REMEDY
No output in SSB (RF and ALC meters do not deflect.)	<ol style="list-style-type: none"> 1. The MIC plug is incompletely inserted. 2. Low microphone gain. 	<ol style="list-style-type: none"> 1. Insert the MIC plug fully. 2. Increase the microphone gain.
No output in CW	<ol style="list-style-type: none"> 1. The KEY plug is incompletely inserted or KEY contact failure. 2. CAR control is too low. 	<ol style="list-style-type: none"> 1. Insert the KEY plug fully. 2. Turn the CAR control clockwise.

RECEPTION

SYMPTOM	CAUSE	REMEDY
Indicators do not light and no receiver noise is heard when the POWER switch is turned on.	<ol style="list-style-type: none"> 1. Poor power cord connection with the connector. 2. Blown power supply fuse. 3. PS-20 is OFF. 	<ol style="list-style-type: none"> 1. Make correct connection. 2. Replace the fuse. (If the new fuse blows again, the set is defective.) 3. Set PS-20 to ON.
Nothing is displayed or wrong digits are displayed when the POWER switch is turned on.	The microprocessor malfunctions. This occurs when the battery is old or the supply voltage drops extremely on the occasion of consuming large current.	<ol style="list-style-type: none"> 1. Adjust the supply voltage to nominal voltage ± 10 V with use of a boosting transformer (in the case of using PS-20). Use a 12 – 16 V battery. 2. Turn the POWER switch on again.
No signal is received even when the antenna is connected.	<ol style="list-style-type: none"> 1. Squelch control works. 2. Microphone PTT switch is in the transmit position, and the TS-670 is in the transmit mode. 	<ol style="list-style-type: none"> 1. Turn the squelch control counterclockwise. 2. Set the PTT switch to the receive position.
An antenna is connected, but no signal is received and the S-meter fully deflects.	RF control is too low, decreasing the high frequency circuit gain.	Turn the RF control fully clockwise.
The S-meter deflects and stays at a certain position even with no signal.	<ol style="list-style-type: none"> 1. Too low supply voltage. 2. RF control is too low. 	<ol style="list-style-type: none"> 1. Adjust the supply voltage to nominal voltage ± 10 V with use of a boosting transformer (in the case of using PS-20). Use a 12 – 16 V battery. 2. Turn the RF control fully clockwise.
Signal is received, but no sound is heard.	MODE switch position is incorrect.	Change the MODE switch position.
SSB received signal is extremely high cut or low cut.	IF shift control is wrongly adjusted.	Set the control to the center (click position).
Frequency is not changed by pressing the BAND switch or turning the tuning control.	<ol style="list-style-type: none"> 1. LOCK switch is ON. 2. VFO/M is ON. 	<ol style="list-style-type: none"> 1. Set LOCK switch to OFF. 2. Set VFO/M to OFF.
Scan fails.	<ol style="list-style-type: none"> 1. HOLD switch is ON. 2. Memory is empty. 3. Frequencies entered in channels 8 and 9 exceed the limit. 	<ol style="list-style-type: none"> 1. Set HOLD switch to OFF. 2. Store data in the memory. 3. Re-enter the frequencies within the limit.
Display goes out with VFO/M ON.	When nothing is stored in the memory channel, a channel is displayed and blanked with only the decimal point displayed.	Store the frequency.

6. ACCESSORIES

■ PERIPHERAL DEVICES AND OPTIONAL PARTS

The following optional accessories are available for more efficient and enjoyable operation of the TS-670.

1. PS-20 DC Regulated Power Supply for Bases Station

This is a DC regulated power supply matching the TS-670. The built-in protection circuit protects the set from shortcircuit of the output terminal and overcurrent.

2. GC-10 General Coverage Unit

This unit makes the receiver section of TS-670 general coverage. With this unit installed, the receiving frequency range becomes 500 kHz - 30 MHz. (However, frequencies near 8.83 MHz cannot be received.)

3. VS-1 Sound Composing Unit

Announces frequencies down to the nearest 100 Hz. This permits the driver to verify the operating frequency without monitoring the display.

4. SP-430 External Speaker

5. SP-40 Compact Mobile Speaker

6. SP-50 Mobile Speaker

7. MB-430 Mobile Mount

8. MC-55 (6 pin or 8 pin) Mobile Microphone

The MC-55 provides UP/DOWN switch, LED display for switching transmit or receive, adjustable microphone gain, automatic receive returning circuit (approx. 5 minutes) and many functions.

9. MC-60A Base Station Microphone

Deluxe desk-top microphone with built-in preamplifier.

10. MC-42S Hand-Held Microphone with UP-DOWN Switch

11. MC-80 (8 pin) Desk-Top UP/DOWN Microphone with built-in Preamplifier

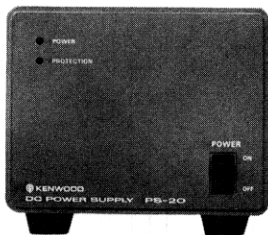

PS-20



SP-430

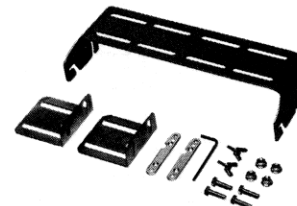

MB-430

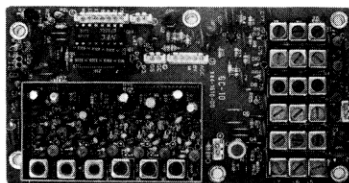

GC-10



SP-40

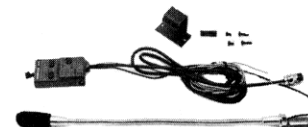

MC-55



VS-1

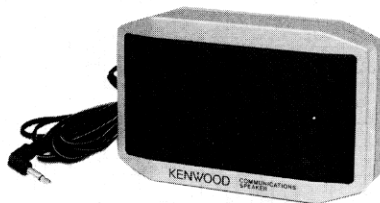

SP-50



MC-60A

12. MC-85 (8 pin) Deluxe Desk-Top UP/DOWN Microphone with built-in Audio Level Compensation

13. HS-4 Headphones

14. HS-5 Communications Headphones

Headphones designed for communications equipment. These light-weight open air-type headphones remain comfortable during extended operation. Easily attached earpads are provided.

15. HS-6 Communications Headphones

Deluxe, very lightweight headphones designed for communications equipment.

16. HS-7 Micro Headphones

17. YK-88C, YK-88CN CW Crystal Filters

Effective for severe QRM in CW operation. Easily attached to the transceiver.

YK-88C (-6 dB band width:
500 Hz, Center frequency: 8.830 MHz)

YK-88CN (-6 dB band width:
270 Hz, Center frequency: 8.830 MHz)

18. YK-88A AM Crystal Filter

Crystal filter for AM mode, easily attached to the transceiver.

YK-88A (-6 dB band width:
6 kHz, Center frequency: 8831.5 kHz)

19. PG-3A Noise Filter (for Mobile Transceiver)

Max. current 15 A. (continuous)

20. SW-100A SWR/POWER METER

Compact and lightweight SWR/POWER/VOLT meters cover 1.8 - 150 MHz (SW-100A).

21. FM-430

22. VOX-4 Voice Controller

In TS-670, selection between transmit and receive is accomplished by the standby switch or microphone PTT switch. The VOX-4 enables this selection by simply speaking into the microphone, without using the standby switch and PTT switch. Use of the VOX-4 will bring you more enjoyable operation.



MC-42S



HS-5

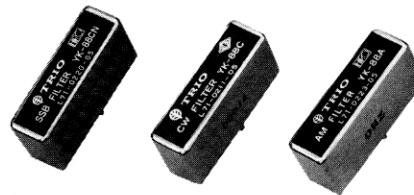

YK-88CN

YK-88C

YK-88A

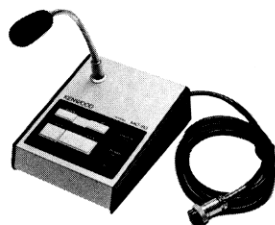

MC-80



HS-6

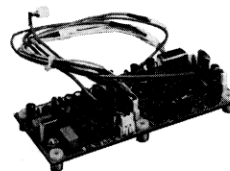

FM-430



MC-85

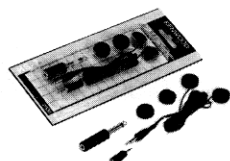

HS-7



VOX-4

7. INTERNAL VIEWS

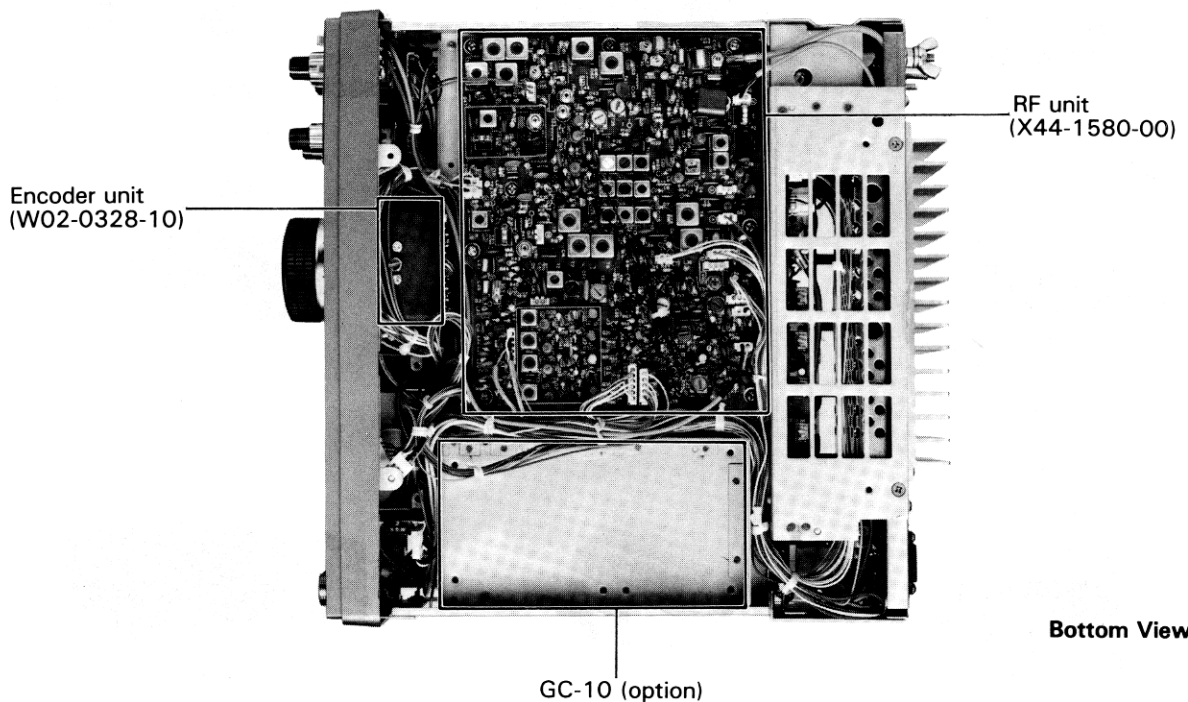
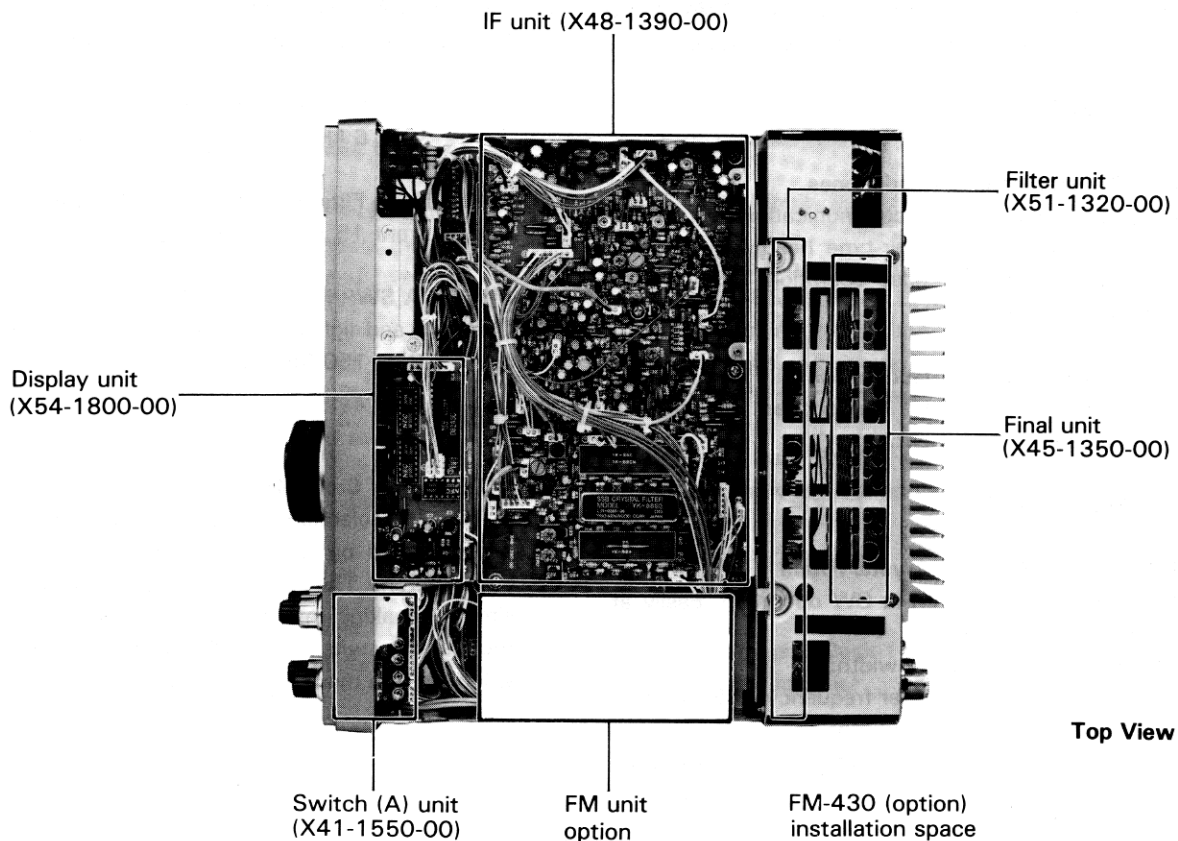

9. SPECIFICATIONS

[General]

Transmit/receive frequency range:

- 40 m band: 7.0 – 7.1 MHz
- 15 m band: 21.0 – 21.45 MHz
- 10 m band: 28.0 – 29.7 MHz
- 6 m band: 50.0 – 54.0 MHz

Mode:

SSB (A3J), CW (A1), AM (A3) and FM (F3-option)

Antenna impedance: 50 Ω

Supply voltage: 12 – 16 V DC

(Reference voltage: 13.8 V DC)

Power consumption:

- Approx. 4 A at transmission
- Approx. 1.1 A at reception with no signal

Dimensions: W270(279) × H96(108) × D260(298) mm

Dimensions in () are the maximum, including projections.

Weight: 5.4 kg (11.88 lb)

[Transmitter]

Final power input: SSB, CW, FM 10 W
AM 4 W

Modulation :

- SSB: Balanced modulation
- FM : Variable reactance direct shift
- AM : Low level modulation

Carrier suppression: Better than 40 dB

Unwanted sideband suppression: Better than 50 dB

Unwanted radiation intensity:

- 7, 21, 28 MHz bands : Less than –40 dB
- 50 MHz band : Less than –60 dB
- 21 MHz band 5th higher harmonic: Less than –70 dB
- 50 MHz band 2nd higher harmonic: Less than –70 dB

Transmission frequency response (SSB): 400 – 2600 Hz
(better than –6 dB)

Maximum frequency deviation (FM): ±5 kHz
(FM-430 installed)

Microphone impedance: 500 Ω – 50 kΩ

Note: Circuit and ratings are subject to change without notice due to developments in technology.

[Receiver]

Circuitry: SSB, CW, AM: Single conversion superheterodyne
FM : Double conversion superheterodyne

Intermediate frequency: SSB, CW, AM: 8.83 MHz

FM: 1st IF 8.83 MHz
: 2nd IF 455 kHz

Sensitivity:

- SSB, CW (10 dB S/N) : Less than –12 dBμ (0.25 μV)
- AM (10 dB S/N) : Less than 6 dBμ (2 μV)
- FM (30 dB S/N) : Less than 0 dBμ (1 μV)
- (12 dB SINAD) : Less than –8 dBμ (0.4 μV)

With YK-88A inserted in AM mode.

With FM-430 inserted in FM mode.

Squelch sensitivity:

- FM (28.50 MHz band): Less than –10 dBμ (0.32 μV)
- SSB, CW, AM : Less than 10 dBμ (3.2 μV)

Image ratio: More than 50 dB

IF reflection: More than 50 dB

Selectivity:

	–6	–60 dB
SSB, CW	2.5 kHz	6 kHz
AM*	6 kHz	11 kHz
FM**	12 kHz	22 kHz

* With YK-88A inserted.

** With FM-430 inserted.

RIT variable range: More than ±1.2 kHz

Audio output power: More than 1.5 W
(with 8 Ω load, 10% distortion)

Audio output impedance: 8 to 16 Ω

[Frequency Controller]

Frequency accuracy:

- Within ±10 × 10⁻⁶ at room temperature
- Within ±30 × 10⁻⁶ at 0°C to +50°C

Frequency stability (at reception):

- Within ±30 × 10⁻⁶ at 0°C to +50°C.
- Within ±300 Hz for up to 60 minutes after turn-on, and within 30 Hz for any 30 minute period thereafter.

GC-10 SPECIFICATIONS (Option)

Reception range	500kHz ~ 30MHz (Note that 8.83MHz, and vicinity of its frequency cannot be received.)
Image ratio	* 40dB or more
IF interference	* 40dB or more
Sensitivity	

Freq. \ MODE	SSB, CW (10dB S/N)	AM (10dB S/N)
0.5 ~ 1.8MHz	6dB μ (2 μ V) or less	24dB μ (16 μ V) or less
1.8 ~ 7MHz	- 6dB μ (0.5 μ V) or less	12dB μ (4 μ V) or less
(**) 7 ~ 7.1MHz	- 12dB μ (0.25 μ V) or less	6dB μ (2 μ V) or less
7.1 ~ 8.3MHz	- 6dB μ (0.5 μ V) or less	12dB μ (4 μ V) or less
9.5 ~ 21MHz	- 6dB μ (0.5 μ V) or less	12dB μ (4 μ V) or less
(**) 21 ~ 21.45MHz	- 12dB μ (0.25 μ V) or less	6dB μ (2 μ V) or less
21.45 ~ 23MHz	- 6dB μ (0.5 μ V) or less	12dB μ (4 μ V) or less
23 ~ 24.85MHz	4dB μ (1.6 μ V) or less	22dB μ (12.5 μ V) or less
(**) 24.8 ~ 28MHz	- 6dB μ (0.5 μ V) or less	12dB μ (4 μ V) or less
28 ~ 29.7MHz	- 12dB μ (0.25 μ V) or less	6dB μ (2 μ V) or less
29.7 ~ 30MHz	- 6dB μ (0.5 μ V) or less	12dB μ (4 μ V) or less

(*) 7.0 ~ 7.1MHz, 21.0 ~ 21.45MHz, 28 ~ 29.7MHz excluded.

(**) TS-670

Model TS-670

Serial No. _____

Date of Purchase _____

Dealer _____

TRIO-KENWOOD CORPORATION

Shionogi Shibuya Building, 17-5, 2-chome Shibuya, Shibuya-ku, Tokyo 150, Japan

TRIO-KENWOOD COMMUNICATIONS
1111 West Walnut Street, Compton, California 90220, U.S.A.

TRIO-KENWOOD COMMUNICATIONS
DIVISION OF TRIO-KENWOOD ELECTRONICS GmbH
Rembrücker Str. 15, 6056 Heusenstamm, West Germany

TRIO-KENWOOD ELECTRONICS, N.V.
Leuvensesteenweg 504, B-1930 Zaventem Belgium

TRIO-KENWOOD (AUSTRALIA) PTY. LTD. (INCORPORATED IN N.S.W.)
4E. Woodcock Place, Lane Cove, N.S.W. 2066, Australia

**Downloaded by
RadioAmateur.EU**