



KENWOOD

SERVICE MANUAL

**Model TS-700A
TS-700G**

Downloaded by



Amateur Radio Directory

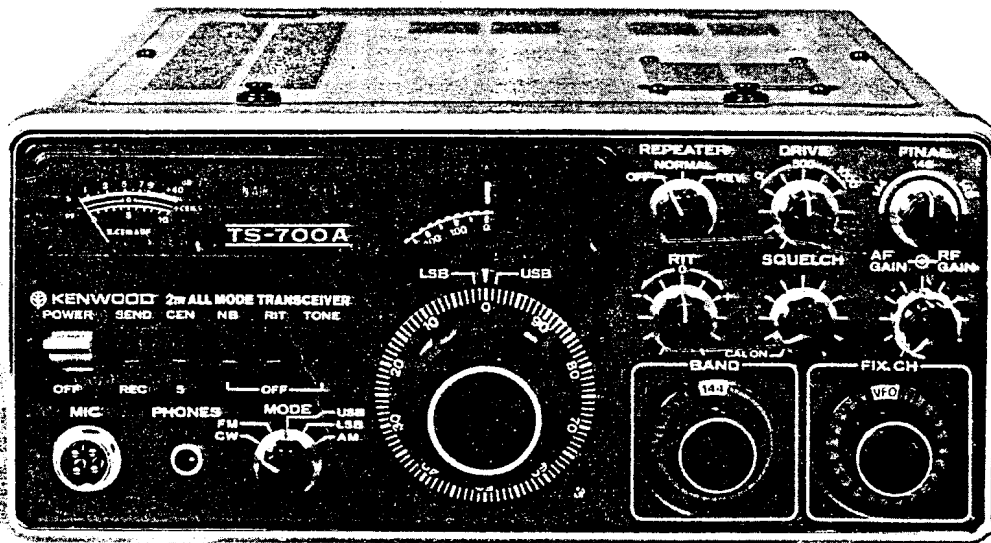

TS-700A

CONTENTS

TS-700A SPECIFICATIONS	3
TS-700G SPECIFICATIONS	4
FEATURES.....	5
TS-700A BLOCK DIAGRAM	7
TS-700G BLOCK DIAGRAM	8
CIRCUIT DESCRIPTION	9
PARTS ALIGNMENT	11
PC BOARD	13
PARTS LIST.....	22
PACKING.....	34
DISASSEMBLY	35
TROUBLESHOOTING	37
LEVEL DIAGRAM	38
ADJUSTMENTS.....	39
RECEIVER SECTION	42
TRANSMITTING SECTION	44
TS-700A SCHEMATIC DIAGRAM	Attached
TS-700G SCHEMATIC DIAGRAM	Attached

TS-700A SPECIFICATIONS

Frequency Range															
144 Band (T, R)	144 ~ 145 MHz														
145 Band (T, R)	145 ~ 146 MHz														
146 RPT	<table border="0" style="display: inline-table; vertical-align: middle;"> <tr> <td style="border-right: 1px solid black; padding-right: 5px;">OFF</td> <td>146 ~ 147 MHz</td> </tr> <tr> <td style="border-right: 1px solid black; padding-right: 5px;">NOR</td> <td> <table border="0" style="display: inline-table; vertical-align: middle;"> <tr> <td style="border-right: 1px solid black; padding-right: 5px;">(T</td> <td>146.0 ~ 146.4 MHz</td> </tr> <tr> <td style="border-right: 1px solid black; padding-right: 5px;">(R</td> <td>146.0 ~ 147.0 MHz</td> </tr> </table> </td> </tr> <tr> <td style="border-right: 1px solid black; padding-right: 5px;">REV</td> <td> <table border="0" style="display: inline-table; vertical-align: middle;"> <tr> <td style="border-right: 1px solid black; padding-right: 5px;">(T</td> <td>146.6 ~ 147.0 MHz</td> </tr> <tr> <td style="border-right: 1px solid black; padding-right: 5px;">(R</td> <td>146.0 ~ 146.4 MHz</td> </tr> </table> </td> </tr> </table>	OFF	146 ~ 147 MHz	NOR	<table border="0" style="display: inline-table; vertical-align: middle;"> <tr> <td style="border-right: 1px solid black; padding-right: 5px;">(T</td> <td>146.0 ~ 146.4 MHz</td> </tr> <tr> <td style="border-right: 1px solid black; padding-right: 5px;">(R</td> <td>146.0 ~ 147.0 MHz</td> </tr> </table>	(T	146.0 ~ 146.4 MHz	(R	146.0 ~ 147.0 MHz	REV	<table border="0" style="display: inline-table; vertical-align: middle;"> <tr> <td style="border-right: 1px solid black; padding-right: 5px;">(T</td> <td>146.6 ~ 147.0 MHz</td> </tr> <tr> <td style="border-right: 1px solid black; padding-right: 5px;">(R</td> <td>146.0 ~ 146.4 MHz</td> </tr> </table>	(T	146.6 ~ 147.0 MHz	(R	146.0 ~ 146.4 MHz
OFF	146 ~ 147 MHz														
NOR	<table border="0" style="display: inline-table; vertical-align: middle;"> <tr> <td style="border-right: 1px solid black; padding-right: 5px;">(T</td> <td>146.0 ~ 146.4 MHz</td> </tr> <tr> <td style="border-right: 1px solid black; padding-right: 5px;">(R</td> <td>146.0 ~ 147.0 MHz</td> </tr> </table>	(T	146.0 ~ 146.4 MHz	(R	146.0 ~ 147.0 MHz										
(T	146.0 ~ 146.4 MHz														
(R	146.0 ~ 147.0 MHz														
REV	<table border="0" style="display: inline-table; vertical-align: middle;"> <tr> <td style="border-right: 1px solid black; padding-right: 5px;">(T</td> <td>146.6 ~ 147.0 MHz</td> </tr> <tr> <td style="border-right: 1px solid black; padding-right: 5px;">(R</td> <td>146.0 ~ 146.4 MHz</td> </tr> </table>	(T	146.6 ~ 147.0 MHz	(R	146.0 ~ 146.4 MHz										
(T	146.6 ~ 147.0 MHz														
(R	146.0 ~ 146.4 MHz														
147 RPT	<table border="0" style="display: inline-table; vertical-align: middle;"> <tr> <td style="border-right: 1px solid black; padding-right: 5px;">OFF</td> <td>147 ~ 148 MHz</td> </tr> <tr> <td style="border-right: 1px solid black; padding-right: 5px;">NOR</td> <td> <table border="0" style="display: inline-table; vertical-align: middle;"> <tr> <td style="border-right: 1px solid black; padding-right: 5px;">(T</td> <td>147.6 ~ 148.0 MHz</td> </tr> <tr> <td style="border-right: 1px solid black; padding-right: 5px;">(R</td> <td>147.0 ~ 147.4 MHz</td> </tr> </table> </td> </tr> <tr> <td style="border-right: 1px solid black; padding-right: 5px;">REV</td> <td> <table border="0" style="display: inline-table; vertical-align: middle;"> <tr> <td style="border-right: 1px solid black; padding-right: 5px;">(T</td> <td>147.0 ~ 147.4 MHz</td> </tr> <tr> <td style="border-right: 1px solid black; padding-right: 5px;">(R</td> <td>147.6 ~ 148.0 MHz</td> </tr> </table> </td> </tr> </table>	OFF	147 ~ 148 MHz	NOR	<table border="0" style="display: inline-table; vertical-align: middle;"> <tr> <td style="border-right: 1px solid black; padding-right: 5px;">(T</td> <td>147.6 ~ 148.0 MHz</td> </tr> <tr> <td style="border-right: 1px solid black; padding-right: 5px;">(R</td> <td>147.0 ~ 147.4 MHz</td> </tr> </table>	(T	147.6 ~ 148.0 MHz	(R	147.0 ~ 147.4 MHz	REV	<table border="0" style="display: inline-table; vertical-align: middle;"> <tr> <td style="border-right: 1px solid black; padding-right: 5px;">(T</td> <td>147.0 ~ 147.4 MHz</td> </tr> <tr> <td style="border-right: 1px solid black; padding-right: 5px;">(R</td> <td>147.6 ~ 148.0 MHz</td> </tr> </table>	(T	147.0 ~ 147.4 MHz	(R	147.6 ~ 148.0 MHz
OFF	147 ~ 148 MHz														
NOR	<table border="0" style="display: inline-table; vertical-align: middle;"> <tr> <td style="border-right: 1px solid black; padding-right: 5px;">(T</td> <td>147.6 ~ 148.0 MHz</td> </tr> <tr> <td style="border-right: 1px solid black; padding-right: 5px;">(R</td> <td>147.0 ~ 147.4 MHz</td> </tr> </table>	(T	147.6 ~ 148.0 MHz	(R	147.0 ~ 147.4 MHz										
(T	147.6 ~ 148.0 MHz														
(R	147.0 ~ 147.4 MHz														
REV	<table border="0" style="display: inline-table; vertical-align: middle;"> <tr> <td style="border-right: 1px solid black; padding-right: 5px;">(T</td> <td>147.0 ~ 147.4 MHz</td> </tr> <tr> <td style="border-right: 1px solid black; padding-right: 5px;">(R</td> <td>147.6 ~ 148.0 MHz</td> </tr> </table>	(T	147.0 ~ 147.4 MHz	(R	147.6 ~ 148.0 MHz										
(T	147.0 ~ 147.4 MHz														
(R	147.6 ~ 148.0 MHz														
Mode	SSB (A3J), FM (F3), CW (A1), AM (A3)														
Output Power	10 watts for SSB, CW and FM 2 watts for AM														
Antenna Impedance	50 ohms (unbalanced)														
Carrier Suppression	Carrier better than 40 dB down from the output signal														
Sideband Suppression	Unwanted sideband is better than 40 dB down from the output signal														
Spurious Radiation	Less than -60 dB														
Max. Frequency Deviation (FM)	±5 kHz														
Modulation	Balanced modulation for SSB Variable reactance frequency shift for FM Low power modulation for AM														
Microphone	500 ohms dynamic microphone														
Audio Frequency Response	400 ~ 2600 Hz within -9 dB														
RPT Tone Frequency	(Option)														
Receiver Circuit	Single superheterodyne for SSB, CW and AM Double superheterodyne for FM														
Intermediate Frequency	10.7 MHz for SSB, CW and AM 10.7 MHz, first IF: 455 kHz, second IF for FM														
Receiver Sensitivity	Less than 0.25μV for 10 dB S/N for SSB and CW Less than 1μV for 10 dB S/N for AM (400 Hz, 30% Mod.) Less than 1μV for 30 dB S/N for FM (20 dB noise quieting: 0.4μV or less)														
Image Ratio	Image frequency better than 60 dB down from the output signal														
IF Rejection	IF frequency is 60 dB or more down from output signal														
Passband Width	More than 2.4 kHz at 6 dB down for SSB, CW and AM More than 12 kHz at 6 dB down for FM														
Receiver Selectivity	Less than 4.8 kHz at 60 dB down for SSB, CW and AM Less than 24 kHz at 60 dB down for FM														

Squelch Sensitivity	-6 dB or less
Audio Output	More than 2 watts (8 ohms, 10% distortion)
Audio Output Impedance	8 ohms
Frequency Stability	Within 200 Hz during any 30 minute period after warmup Within ±4 kHz during the first hour after 1 minute of warmup
Operating Temperature	-10°C to 50°C
Power Consumption	95 watts (AC 120/220 Volts), 4A (DC 13.8 Volts) for full power transmission 45 watts (AC 120/220 Volts), 0.8A (DC 13.8 Volts) for no-signal reception
Power Requirements	AC 120/220 Volts, 50/60 Hz DC 12 ~ 16 Volts (13.8 Volts as reference)
Dimensions	10-15/16" (278 mm) wide X 4-7/8" (124 mm) high X 12-9/16" (320 mm) deep
Weight	24.2 lbs (11 kg)

Scan by Dun

Downloaded by

Amateur Radio Directory

TS-700G SPECIFICATIONS

Frequency Range							
144 Band (T, R)	144 ~ 145 MHz						
145 RPT	<table border="0" style="margin-left: 20px;"> <tr> <td>OFF</td> <td>145 ~ 146 MHz</td> </tr> <tr> <td>NOR</td> <td>(T 144.4 ~ 145.4 MHz R 145.0 ~ 146.0 MHz)</td> </tr> <tr> <td>REV</td> <td>(T 145.0 ~ 146.0 MHz R 144.4 ~ 145.4 MHz)</td> </tr> </table>	OFF	145 ~ 146 MHz	NOR	(T 144.4 ~ 145.4 MHz R 145.0 ~ 146.0 MHz)	REV	(T 145.0 ~ 146.0 MHz R 144.4 ~ 145.4 MHz)
OFF		145 ~ 146 MHz					
NOR		(T 144.4 ~ 145.4 MHz R 145.0 ~ 146.0 MHz)					
REV	(T 145.0 ~ 146.0 MHz R 144.4 ~ 145.4 MHz)						
Mode	SSB (A3J), FM (F3), CW (A1), AM (A3)						
Output Power	10 watts for SSB, CW and FM 2 watts for AM						
Antenna Impedance	50 ohms (unbalanced)						
Carrier Suppression	Carrier better than 40 dB down from the output signal						
Sideband Suppression	Unwanted sideband is better than 40 dB down from the output signal						
Spurious Radiation	Less than -60 dB						
Max. Frequency Deviation (FM) Modulation	±5 kHz Balanced modulation for SSB Variable reactance frequency shift for FM						
Microphone	Low power modulation for AM						
Audio Frequency Response	500 ohms dynamic microphone						
RPT Tone Frequency	400 ~ 2600 Hz within -9 dB						
Receiver Circuit	1750 Hz						
Intermediate Frequency	Single superheterodyne for SSB, CW and AM Double superheterodyne for FM						
Receiver Sensitivity	10.7 MHz for SSB, CW and AM 10.7 MHz, first IF; 455 kHz, second IF for FM						
Image Ratio	Less than 0.25μV for 10 dB S/N for SSB and CW Less than 1μV for 10 dB S/N for AM Less than 1μV for 30 dB S/N for FM (20 dB noise quieting; 0.4μV or less)						
IF Rejection	Image frequency better than 60 dB down from the output signal						
Passband Width	IF frequency is 60 dB or more down from output signal						
Receiver Selectivity	More than 2.4 kHz at 6 dB down for SSB, CW and AM More than 12 kHz at 6 dB down for FM						
Squelch Sensitivity	Less than 4.8 kHz at 60 dB down for SSB, CW and AM						
Audio Output	Less than 24 kHz at 60 dB down for FM						
Audio Output Impedance	-6 dB or less More than 2 watts (8 ohms, 10% distortion)						
	8 ohms						

Frequency Stability	Within 200 Hz during any 30 minute period after warmup Within ±4 kHz during the first hour after 1 minute of warmup
Operating Temperature	-10°C to 50°C
Power Consumption	95 watts (AC 120/220 Volts), 4A (DC 13.8 Volts) for full power transmission 45 watts (AC 120/220 Volts), 0.8A (DC 13.8 Volts) for no-signal reception
Power Requirements	AC 120/220 Volts (Europe), AC 220/240 Volts (England), 50/60 Hz DC 12 ~ 16 Volts (13.8 Volts as reference)
Dimensions	10-15/16" (278 mm) wide X 4-7/8" (124 mm) high X 12-9/16" (320 mm) deep
Weight	24.2 lbs (11 kg)

Scanned by Duu

Downloaded by

Amateur Radio Directory

FEATURES

1. A completely solid-state, all-mode amateur transceiver, the Model TS-700A and G provides high-quality communications on SSB, FM, AM and CW in the 144-MHz band.
2. It operates with dual power supply, AC and DC, and is designed for two duties ...STATIONARY and MOBILE.
3. TS-700A and G is a highly sophisticated amateur radio transceiver incorporating VFO with frequency coverage, 144.00 ~ 148.00 Hz (TS-700A), 144.00 ~ 146.00 MHz (TS-700G), respectively.
Also included in the equipment is an additional provision for REPEATER operation with the frequency coverage, 146.00 ~ 148.00 MHz (700A), 144.00 ~ 146.00 MHz (700G).
It can perform frequency shift of NORMAL or REVERSE.
4. A newly developed two-speed dial mechanism facilitates tuning: MAIN TUNING knob (inner) for closer tuning covers a change of 25 kHz per revolution, QUICK (ROUGH) TUNING knob (outer) covers a change of 100 kHz similarly. You can tune in quickly with pinpoint accuracy — the feature which will prove very useful in receiving single-sideband (SSB) signals.
5. MAIN DIAL is calibrated to provide readings accurate to 1 kHz, presenting a circular (360 degrees) scale from zero to 100 kHz. SUB-DIAL is a similar scale calibrated in intervals of 50 kHz to cover a total range of 1 MHz for a revolution.
6. 11 channels in each band (to be loaded with optional crystals) are provided, so that total of 44 fixed channels (700A), 22 fixed channels (700G) are available. Moreover, the crystal loaded channels is shown by the loaded channel indicator.
7. A noise blanker (NB) circuit of the type adopted in many other HF products of our make and widely acknowledge for excellent noise eliminating performance is included. Such pulse signals as those coming from automotive ignition systems are beautifully excluded from audio output.
8. For improved FM-mode operation, a squelch circuit of noise count type with a schmitt trigger circuit is added to the FM unit.
9. Cross-talk and spurious response are minimized by the high selectivity of two special tuning circuits, one being of variable capacitance type built in the RF stage and the other being of High-Q type located on the antenna input side.
10. A balanced-type mixer circuit based on the use of field-effect transistors (FET) has been adopted for the pre-mixer and heterodyne mixer. These mixers assure improved rejection of spurious response during transmission.
11. In repeater operation, frequency is shifted with ease by selecting REPEATER knob set to NORMAL or REVERSE, and the tone oscillator is tone burst type which injects tone signal automatically at the beginning of transmission to activate the repeater, in FM mode. (700A)
In TS-700G, a piezo-electric tuning fork is employed for repeater operation. Turning TONE switch on leads TS-700G to transmitting condition independent of SEND — REC switch.
12. Excellent selectivity is realized by using 6 elements crystal filter, and a narrow passband ceramic filter in FM reception.
13. The built-in RF gain control is threshold type and, as such, ensures an optimized S/N ratio at all times in receiving SSB signals.
14. Speaker output is free from distortion: this owes to the amplifier-type AGC circuit. Signals transmitted are accompanied by little or no splutter and free from distortion: this owes to the advanced ALC circuit. The AGC circuit comprises such time-constant elements that this constant is "long" in SSB mode but "short" in FM, AM or CW mode.
15. A marker signal circuit, operating with a high-precision crystal oscillator which runs at 1 MHz, is included to enable you to calibrate the tuning dial extremely accurately at the edge of a frequency band.
16. S meter is of our original type. Its reading doesn't go beyond the scale even when an extraordinarily strong signal comes in.
During FM reception, switching CEN-S switch selects the CENTER meter circuit or the S meter circuit so that accurate tuning is performed.
17. The ON-AIR lamp lights up when the transceiver shifts itself into transmitting state. This feature keeps you informed of the state of operation at all times.
18. A receiver incremental tuning circuit (RIT) is included as a means of fine tuning. This circuit is particularly useful in SSB and CW modes, and is effective whether you have selected the VFO or one of 11 fixed channel.
19. The built-in speaker is a large 9 cm by 6 cm one. An extra jack is provided, so that you can drive an external speaker from it.
20. Two kinds of power supply are accepted: AC120/220V 50/60 Hz (700A), AC 220/240V 50/60 Hz (700G for England), AC 120/220 50/60 Hz (700G for Europe), and DC 13.8V.
Supply connection is simplified. A DC voltage multiplier of our own development is contained in the transceiver: this multiplier is exceptionally compact and has contributed much to the space-economy design of this model.

FEATURES

21. Significant improvements are embodied in the panel design for making this transceiver much easier to control and use. Dial and knobs are of more advanced type in visual and functional senses; meter illumination and pilot lighting are included by assuming nighttime use of the transceiver; and controls and connectors are laid out according to the principles of human engineering.
22. For assuring easier access to the internals, the transceiver enclosure or case is in two parts, complete with special mechanical details to allow the front control panel to be detached. The rear panel and final-stage unit are so arranged that this unit can be removed as an individual component by and from the rear panel.
23. The handle is provided for easy carrying and handling of this transceiver.
24. A microphone is included among the standard accessories.

CIRCUIT DESCRIPTION

GENERAL

The block diagram of the TS-700A or TS-700G transceiver is shown in page 4, to which the following description is referenced.

The circuits comprise a total of 71 (700A) 69 (700G) transistors, 17 (700A) 18 (700G) FETs, 6 (700A) 5 (700G) ICs, 138 (700A) 117 (700G) diodes. These circuit elements are arranged in untized groups, each group being designed to perform a specific function, and are interconnected by printed-circuit conduction paths. An exception from this manner of interconnection is the band-pass filter (BPF).

The receiving section operates on single superheterodyne for SSB mode or on double superheterodyne for FM mode. The transmitting section produces the SSB signal through a crystal filter circuit for the SSB mode of operation; it operates on direct voltage modulation by variable capacitance for FM mode, on low-power modulation for AM mode, and on block bias keying of double-conversion type for CW mode.

Crystal oscillator frequencies

CARRIER UNIT	USB	10.6985 MHz
	LSB	10.7015 MHz
	AM, CW	10.7006 MHz
GENERATOR UNIT	FM	10.7000 MHz
HET UNIT	TS-700A	
	144	125.1000 MHz
	145	126.1000 MHz
	146	127.1000 MHz
	147	128.1000 MHz
	145.4 ...	126.5000 MHz
	147.6 ...	128.7000 MHz
	TS-700G	
	144	125.1000 MHz
	145	126.1000 MHz
	RPT	125.5000 MHz

CARRIER UNIT (X50-1160-00)

This unit provides the carrier frequency for the generator unit in transmitting operation, but operates as a beat frequency oscillator (BFO) for ring-type detection in receiving operation. Crystals are used for the oscillating elements in the 2-transistor solid-state circuit of this unit. Switching diodes are included for switching between USB, LSB and CW.

GENERATOR UNIT (X52-1080-21)

The single sideband signal for transmitting operation originates in this unit. For the microphone output, a first-stage FET amplifier stage, followed by a two-transistor circuit, constitutes the audio-frequency amplifier, after which comes the 4-diode ring modulator and first-stage buffer. Other circuits are: a ring demodulator for SSB reception, a low-power AM modulator, a direct variable-capacitance modulator for FM transmission, an IF circuit for SSB, AM and CW modes, and an AM detector.

During SSB mode of operation, this unit generates a double sideband (DSB) signal, which casts off one of its sidebands by flowing through the crystal filter circuit, thereby turning to SSBsignal.

The carrier for CW mode is obtained by biasing the ring modulator with a DC voltage to break the balance in this modulator.

FM IF UNIT (X48-1140-20: 700A, -61: 700G)

During receiving operation, this unit takes in the signal from the output of the RX NB unit. The input signal is then passed through its 10.7 MHz ceramic filter and, by mixing, is reduced to 455 kHz. The 455 kHz signal is passed through another ceramic filter, from which it enters the IF stage, in which the signal flows through a limiter circuit and then undergoes FM demodulation. The demodulated signal divides into a squelch circuit and a gage circuit. The squelched output signal is fed back into the gate circuit. A 455 kHz ceramic filter for narrow (± 6 kHz) is employed. And a tone-burst circuit (700A), a piezo-electric tuning fork (700G) is incorporated respectively.

MIX UNIT (X48-1130-21)

The heterodyne mixer, voltage amplifier and power amplifier of the transmitting section are included in this unit. With the signal coming from the generator unit, a 144 MHz signal is produced in the balanced mixer. This signal undergoes voltage amplification by passing through the pre-driver circuit.

For CW mode, the voltage amplifying FETs are block-biased for keying.

FINAL UNIT (X56-1140-01)

This is a power amplifier unit capable of 10-watt output. Its circuit elements and mechanical parts are all in a compact cluster built on the chassis. It is complete with a heat sink for cooling and also with an ALC circuit.

BPF UNIT (X51-1090-21: 700A, -00: 700G)

The BPF unit couples the transceiver to the antenna during transmit-receive operation and eliminates spurious response from the signal being transmitted out. In addition to these two functions, it detects the RF output level.

MARKER UNIT (X50-1280-00)

A 1 MHz crystal oscillator is included, which is the circuit for producing the 1 MHz marker signal to be used for calibration purposes.

RX-NB UNIT (X55-1120-00)

The received RF signal is amplified, beaten down by heterodyne mixing and then filtered in this unit before it is forwarded to the IF circuit terminating with a blanking gate. For the filtering action, a crystal filter is employed.

The noise blanking gate is a part of the noise blanker (NB) circuit included in this unit. When the NB switch (on the panel) is OFF, the IF signal emerging from the filter flows through the IF circuit without encountering any obstruction. If this switch is ON, the path of the IF signal is turned on or off at the blanking gate according as the noise component of the RF signal is small or large.

Improved noise detection and elimination are secured here by subjecting both signal components — information and noise — to transistorized detection amplitude and frequen-

CIRCUIT DESCRIPTION

cy. The noise blanking scheme so formed is particularly effective where the noise is radically dissimilar to the information signal in terms of frequency composition and amplitude. A good example of this is the SSB signal against the noise due to the ignition system of a motor car running nearby.

A high-level noise with its frequencies extending beyond the iF band to the information signal frequency is hard to discriminate for noise blanking. Interference noises coming from high-frequency welding machines or corona-discharge machines, for instance, are similar to SSB signals in the sense mentioned above, and are hard for the noise blanker circuit to isolate them from the desired signal; possible results are distorted output voices. The transceiver should not be blamed for such distortion. A sensitivity adjustment circuit of the S, RF meter and CENTER meter is also incorporated.

VFO UNIT (X40-1080-00)

A perfectly shielded unit, this variable frequency oscillator provides extra-stable oscillation by its circuitry designed with 2 FETs, 2 transistors and 2 diodes. It is of the same type that is used in the TS-900.

AF UNIT (49-1060-00)

This is the final stage in the receiving section; it amplifies the audio-frequency signal derived from the received signal; it is by this amplified AF signal that the speaker is driven. Two stages of band amplification and 2 stages of AF amplification, plus a complementary amplifier, constitute the circuitry of this unit. Load impedance is 8 ohms.

Rating of FINAL transistor 2N5642

Application: RF power amplification

Structure: NPN epitaxial planar

1	V _{CEO}	35	V _{dc}
2	V _{CB}	65	V _{dc}
3	V _{EB}	4.0	V _{dc}
4	I _c	3.0	A _{dc}
5	P _D	30 171	W mW/°C
6	T _{stg} , T _j	-65 ~ 200	°C

POWER SUPPLY UNIT (X43-1120-00)

So TS-700A and 700G transceiver can be operated on two kinds of power, AC and DC, an AC bridge rectifier is built in this unit. The rectifier provides 13.8 volts DC, which is multiplied to 20 volts — the voltage needed by the AF unit and FINAL unit.

The 9-volt DC power supply for some units is made available by reducing the 13.8 volts through an IC chip having voltage stabilizing capability.

The other supply voltages are derived by tapping from the 20-volt and 9-volt supply circuits.

In order to facilitate wiring work for interconnecting the unit thus far described, interconnecting terminals are marked with symbols. Terminals with like symbols are connected to each other except where this manner of terminal identification is not practical or permissible.

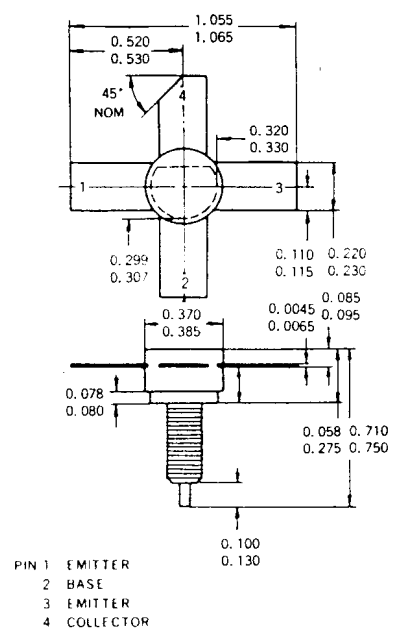

Downloaded by

Amateur Radio Directory

PARTS ALIGNMENT

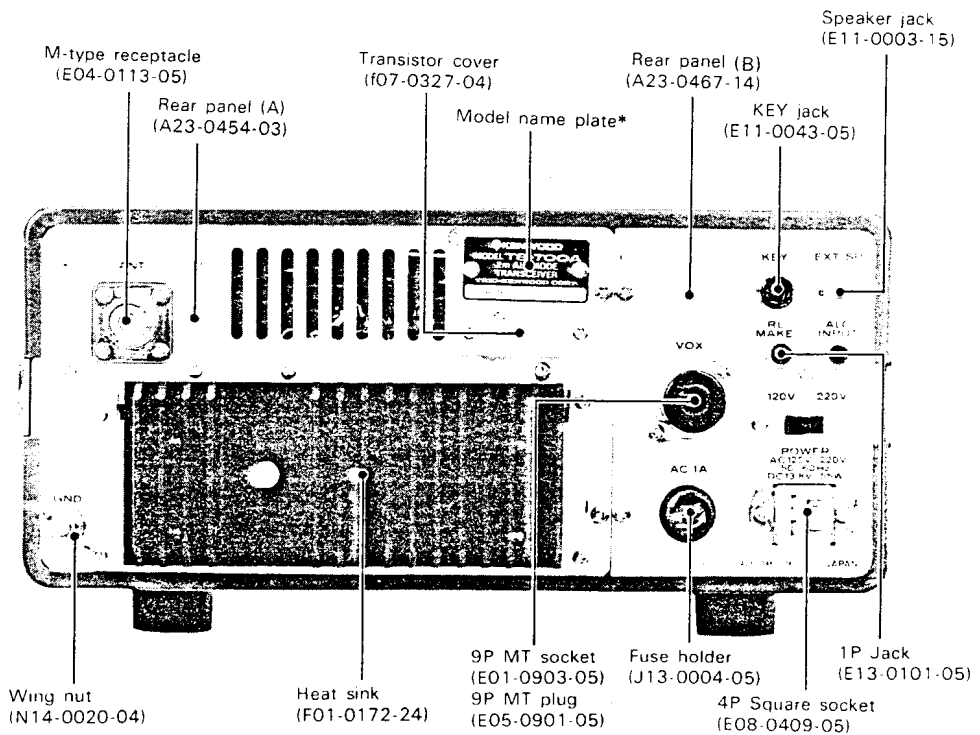
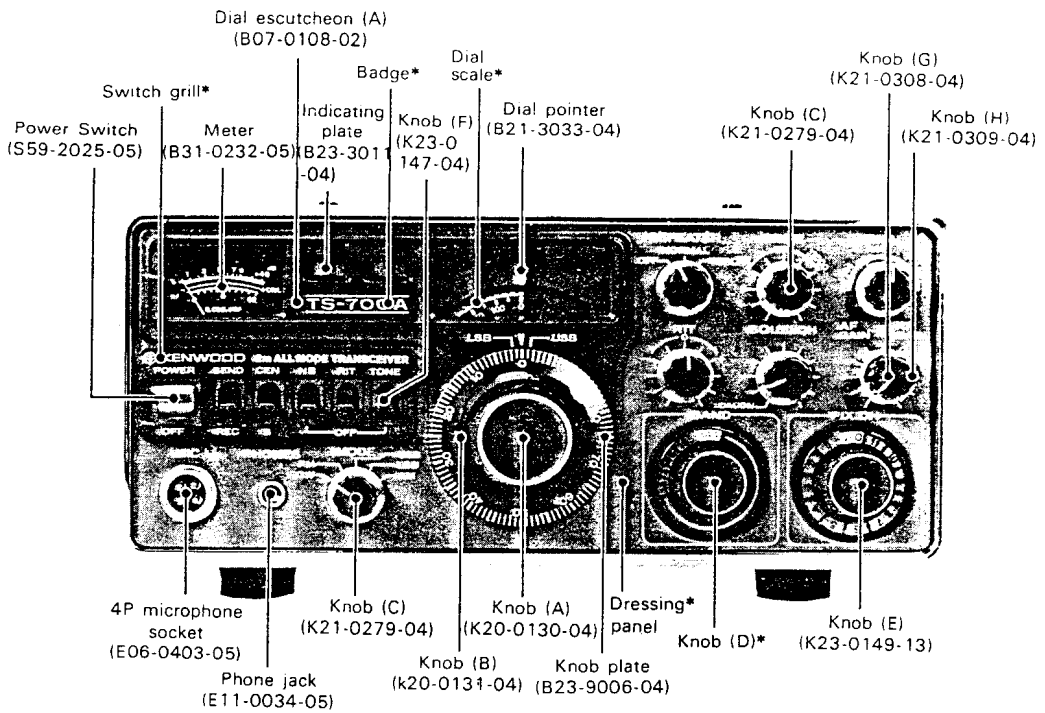

*Refer to PARTS LIST.

PARTS ALIGNMENT

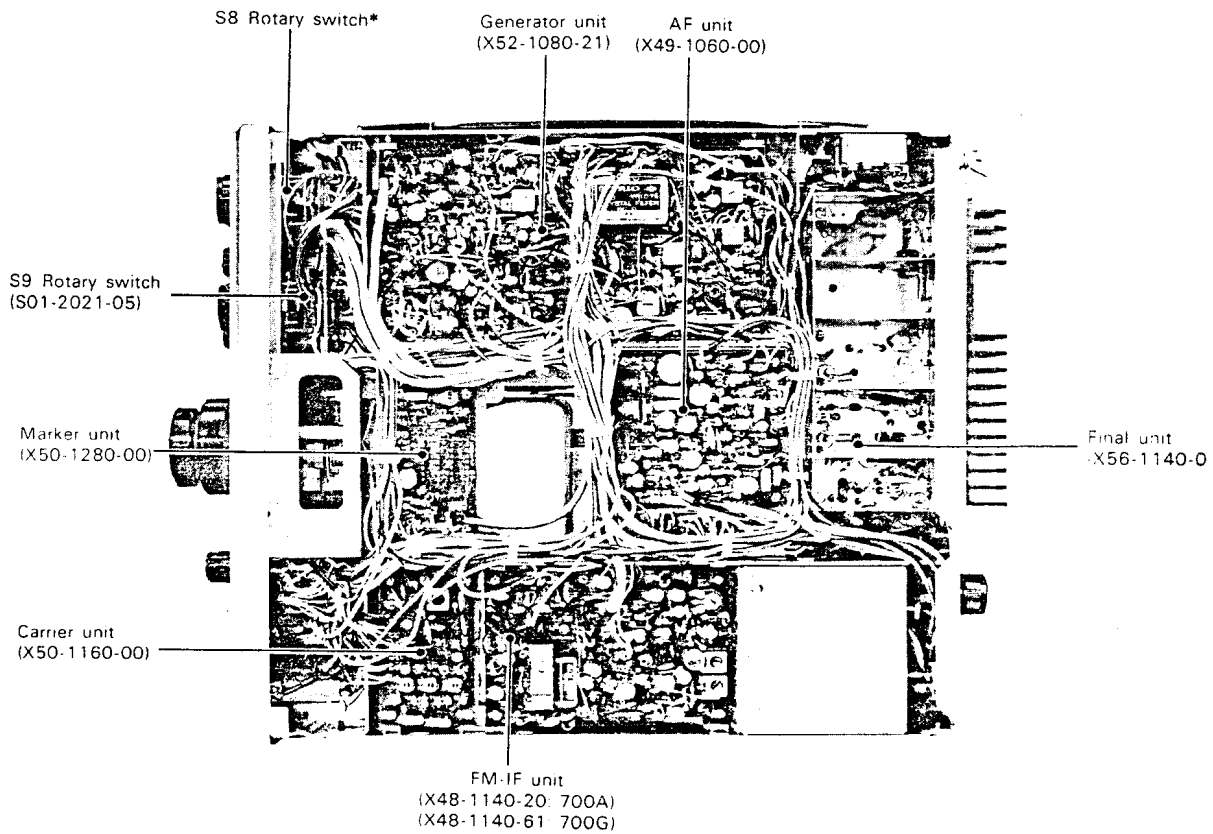
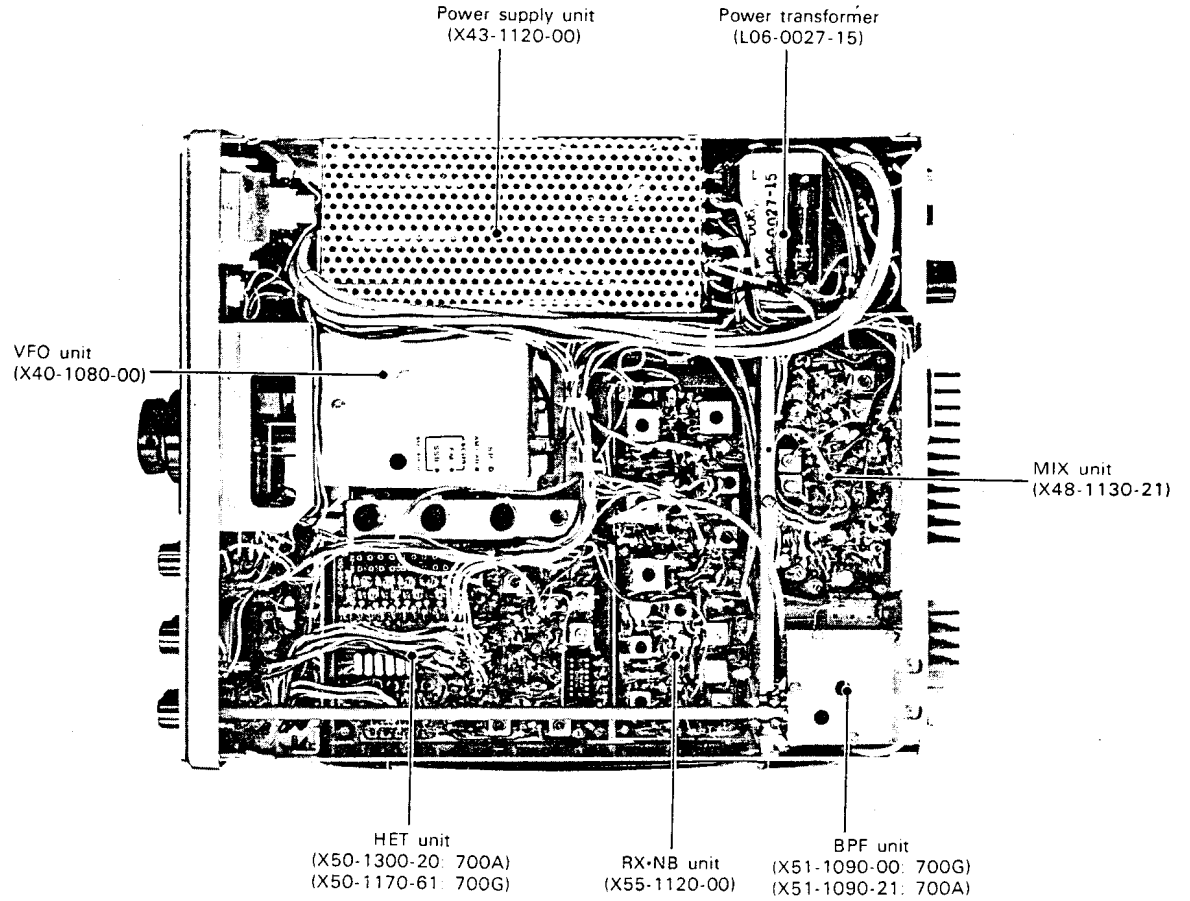

*Refer to PARTS LI

PC BOARD

▼ CARRIER unit (X50-1160-00)

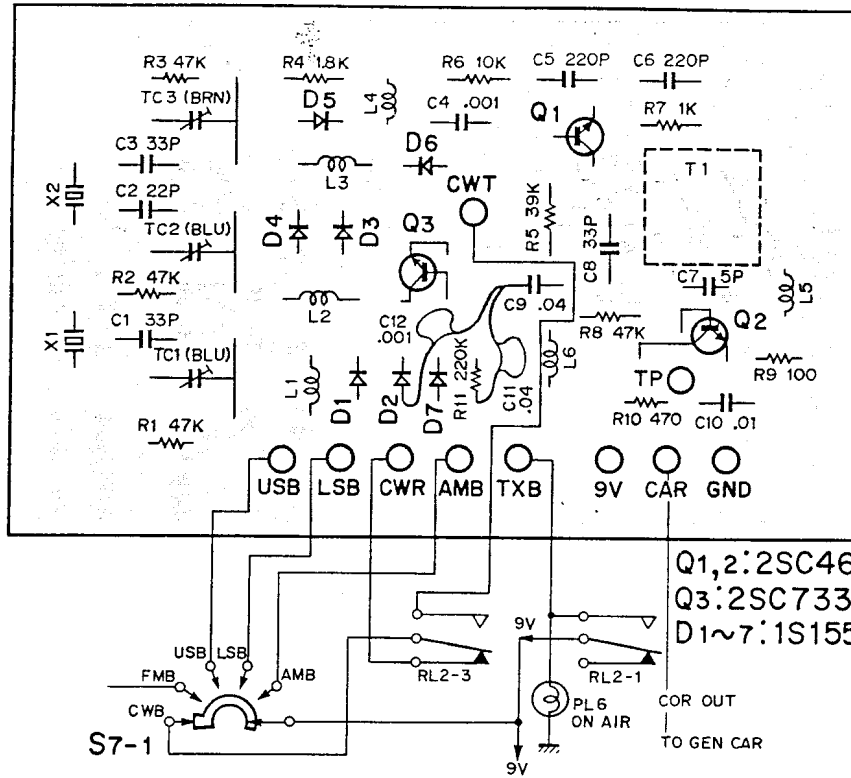

2SC460

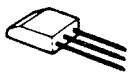

2SC733
2SC734



▼ AF unit (X49-1060-00)

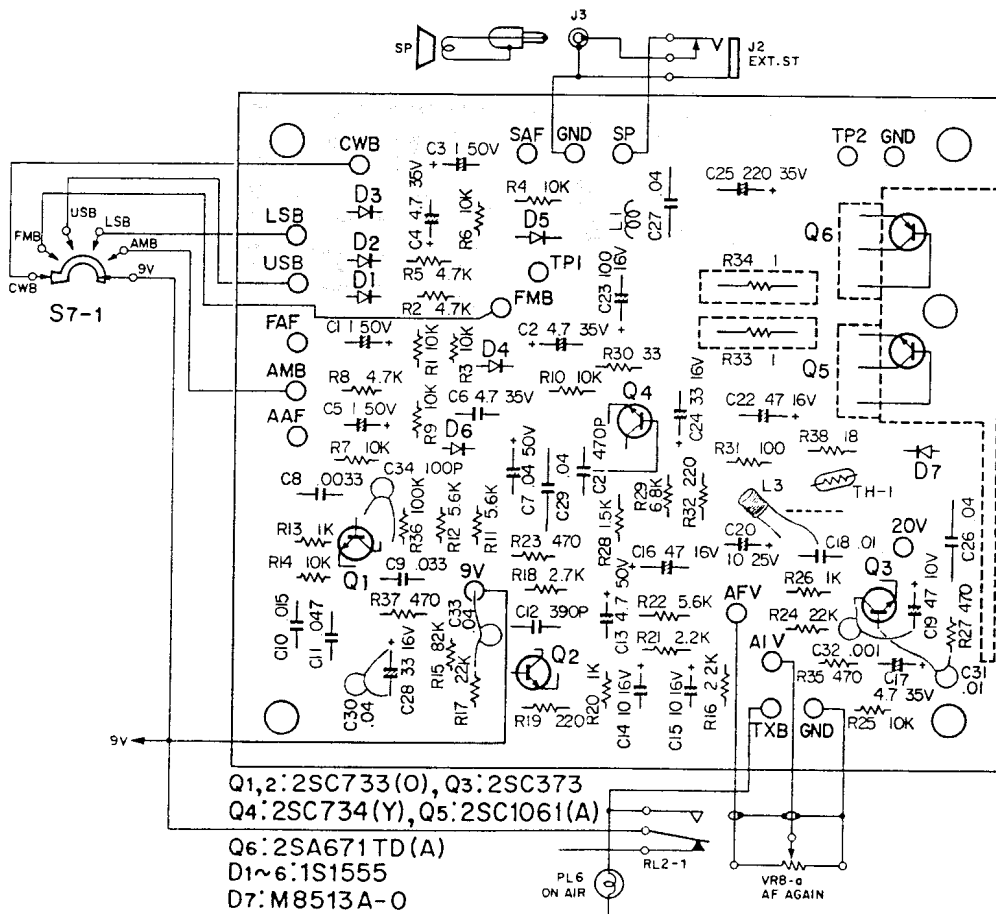

2SC1061
2SA671

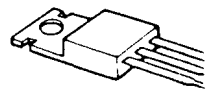





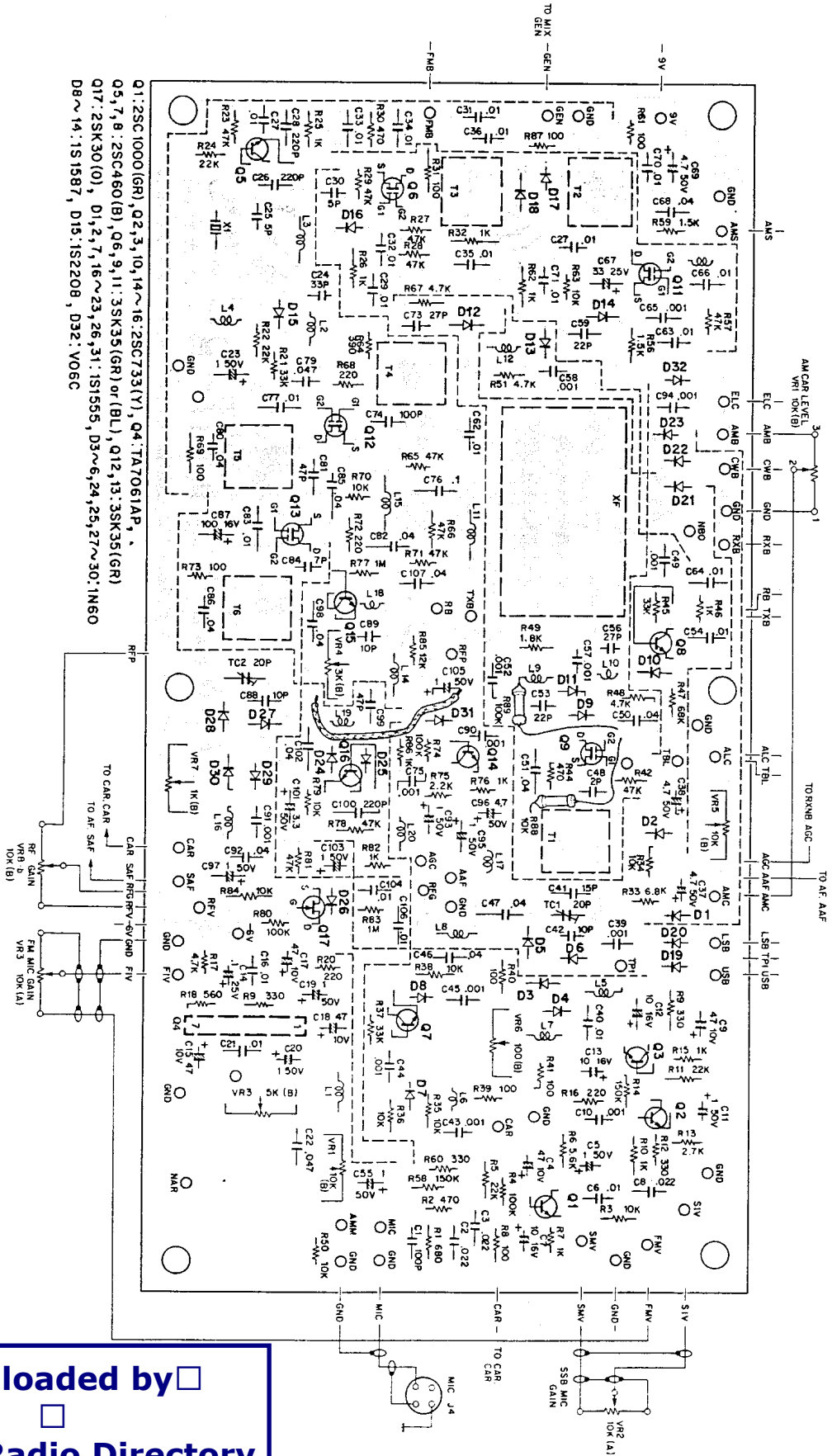





PC BOARD

▼ GENERATOR unit (X52-1080-21)



Q1:2SC1000(GR), Q2,3,10,14~16:2SC733(Y), Q4:TA7061AP,
 Q5,7,8:2SC460(B), Q6,9,11:3SK35(GR) or (BL), Q12,13:3SK35(GR)
 Q17:2SK30(O), D1,2,7,16~23,26,31:1S1555, D3~6,24,25,27~30:1N60
 D8~14:1S1587, D15:1S2208, D32:VO6C

- 25C99 
- 25C10 
- 25A5E 
- 25C73 
- 25C38 
- TA706 
- 25C4E 
- 25C4E 
- 3SK41 
- 3SK35 
- 25K3C 

Downloaded by

 Amateur Radio Directory

PC BOARD

▼ FM-IF unit (X48-1140-20): 700A

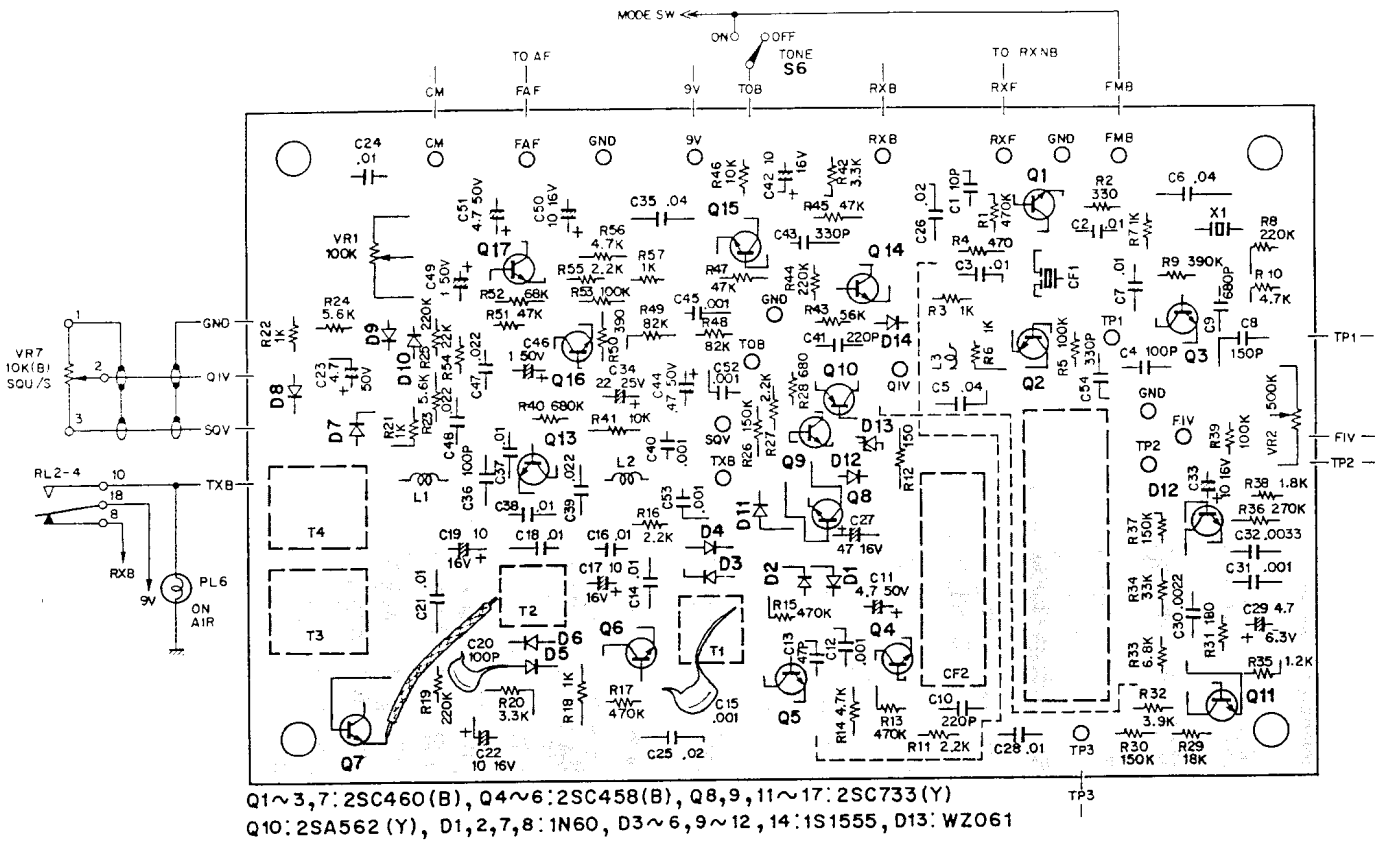

▼ FM-IF unit (X48-1140-61): 700G

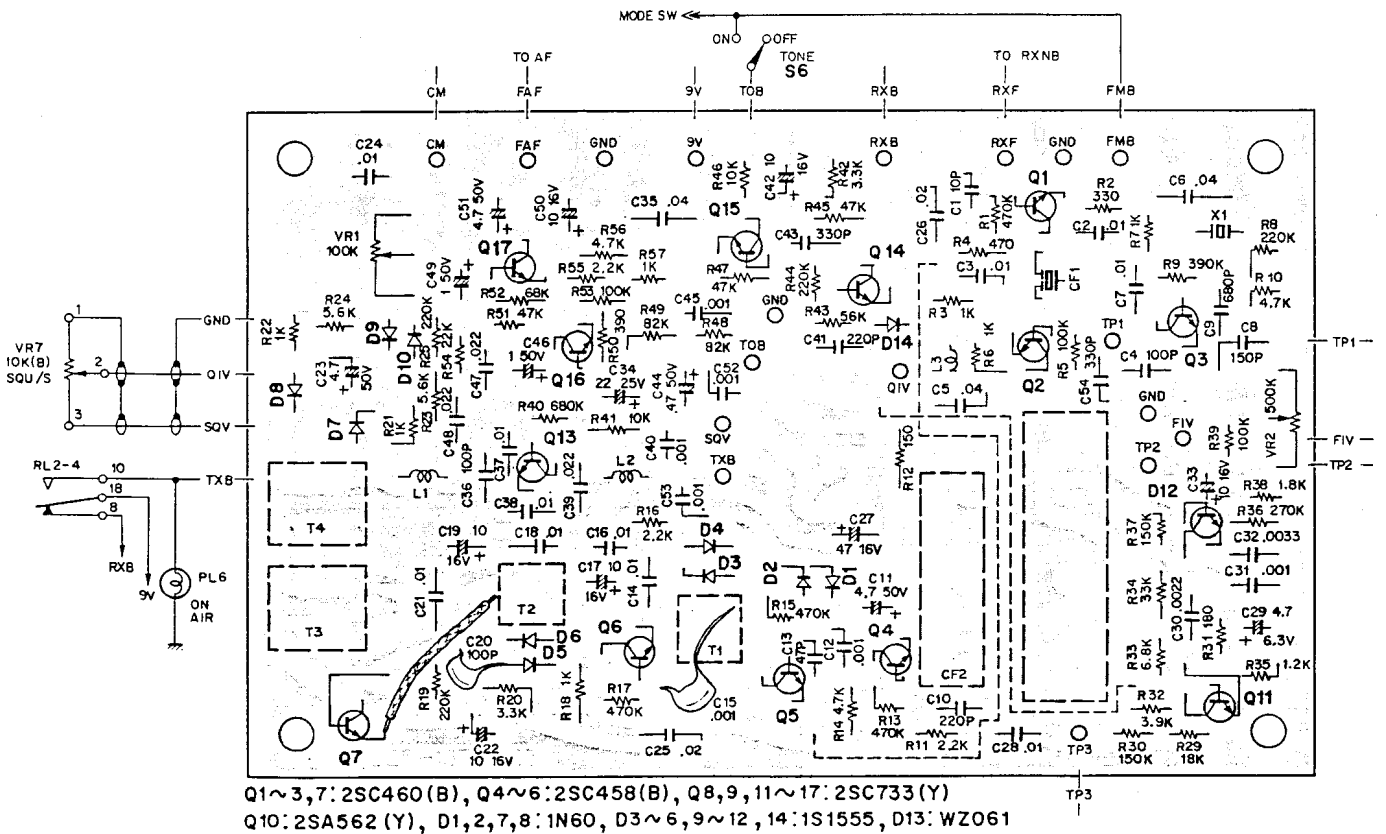

PC BOARD

▼ FINAL (X56-1140-01)

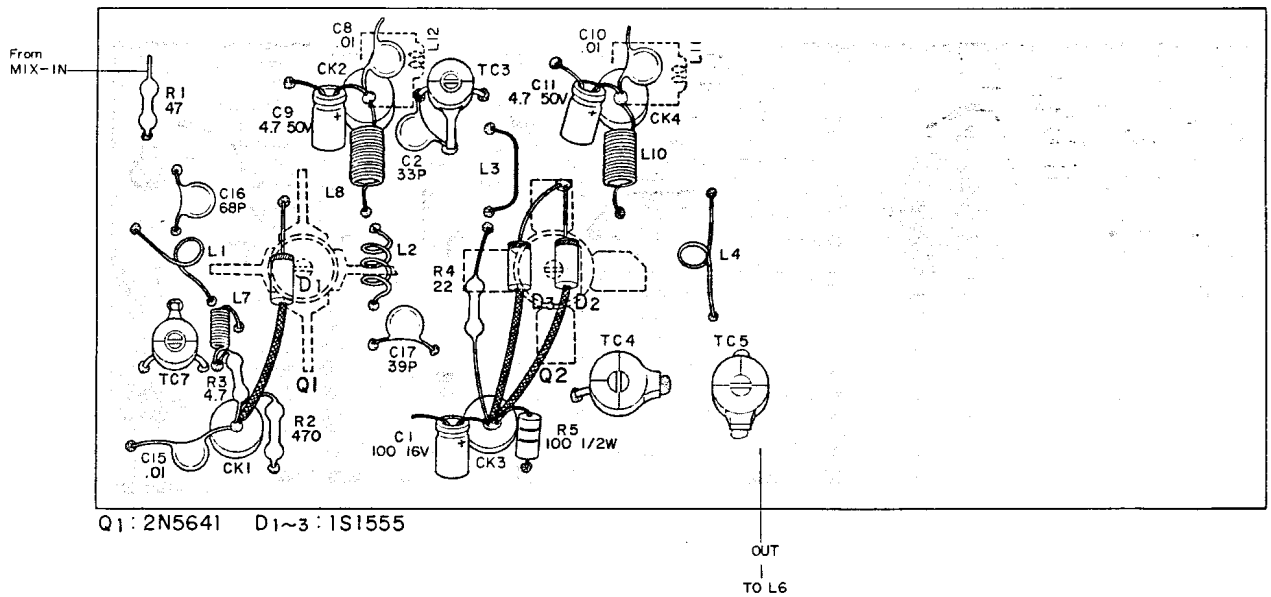

▼ POWER SUPPLY (X43-1120-00)

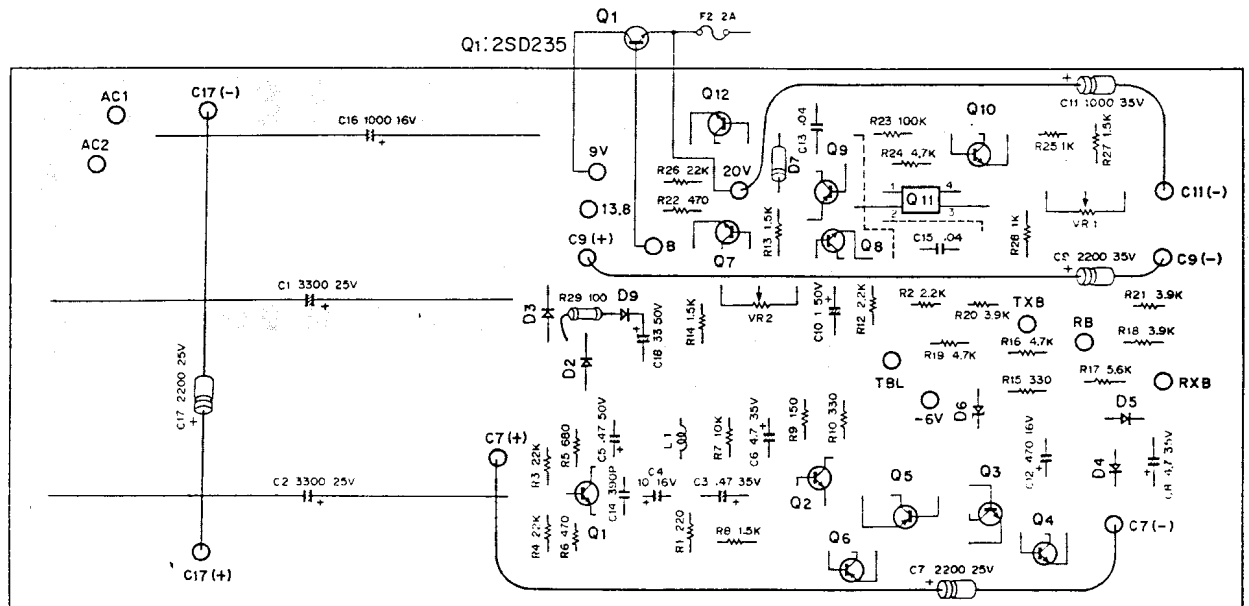

Q1,3,10: 2SC733(Y), Q2,7,8: 2SC734(Y), Q4,12: 2SD235(Y), Q5: 2SB405(R), Q6: 2SA671TD(B), Q9: 2SA495(OorY), Q11: MFC4060A, D1: DS-10BN-L, D2,3: U05B, D4,5,7: V06B, D6: WZ061, D9: 1N60,

Downloaded by

 Amateur Radio Directory

PC BOARD

▼ MARKER unit (X50-1280-00)

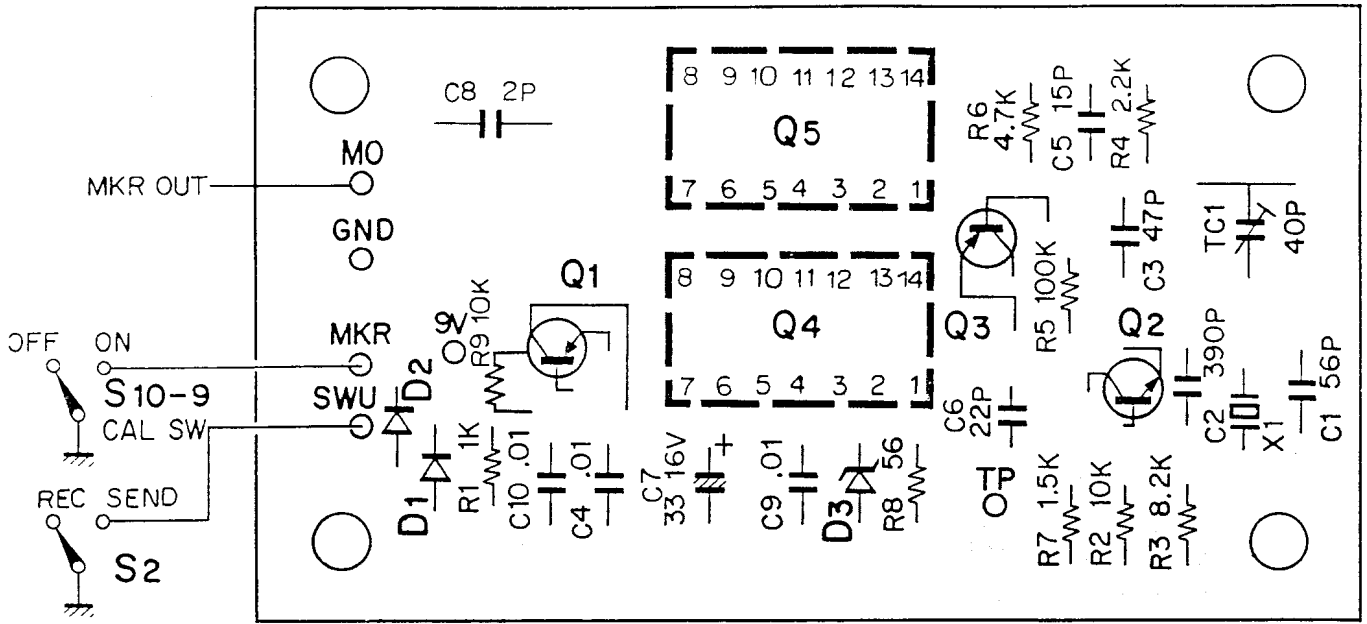

Q1: 2SA562(Y), Q2: 2SC458(B), Q3: 2SA495(Y)
 Q4,5: TD3490BP, D1,2: 1S1555, D3: BZ-052

▼ VFO unit (X40-1080-00)

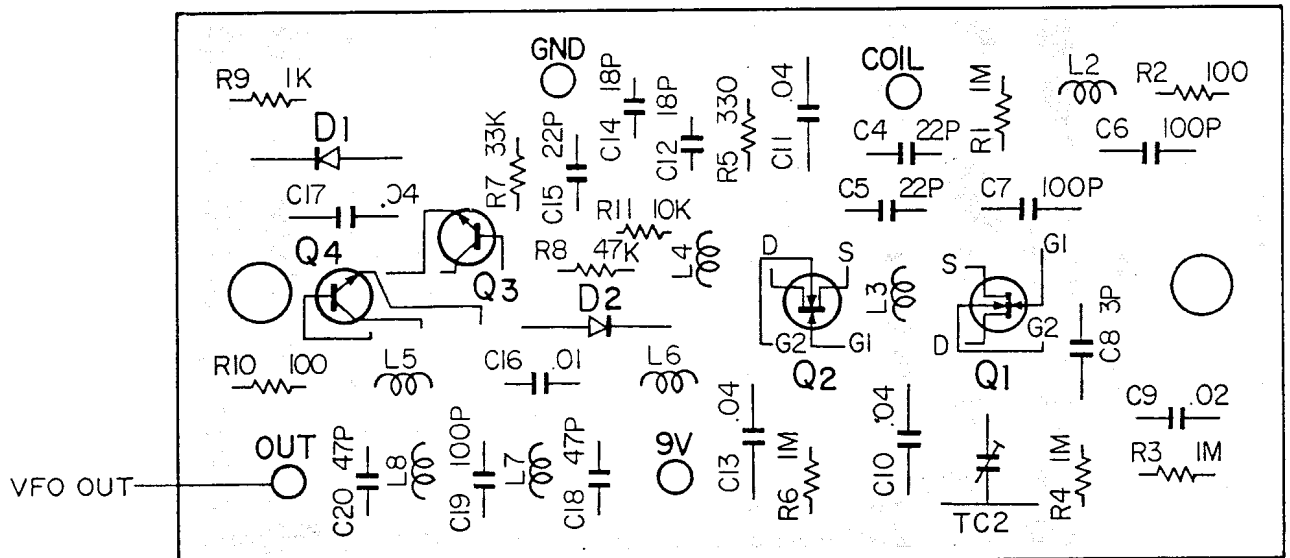

Q1,2: 3SK22(Y) Q3,4: 2SC460(B) D1,2: 1N60

2N5641

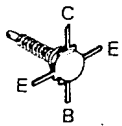

2N5642

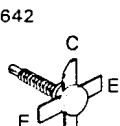

2SA562
 2SA495
 2SC733
 2SC734

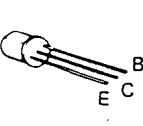

2SD235

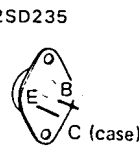

2SB405

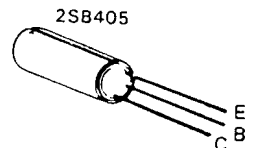

2SA671

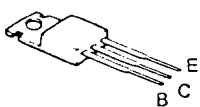

MFC4060A

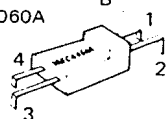

2SC458
 2SC460

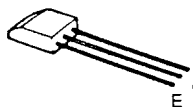

TD3490

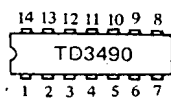

TOP VIEW

3SK22

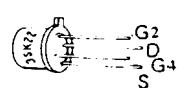

PC BOARD

▼ RX·NB unit (X55-1120-00)

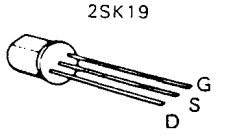
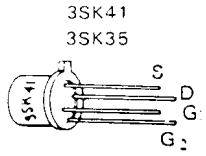
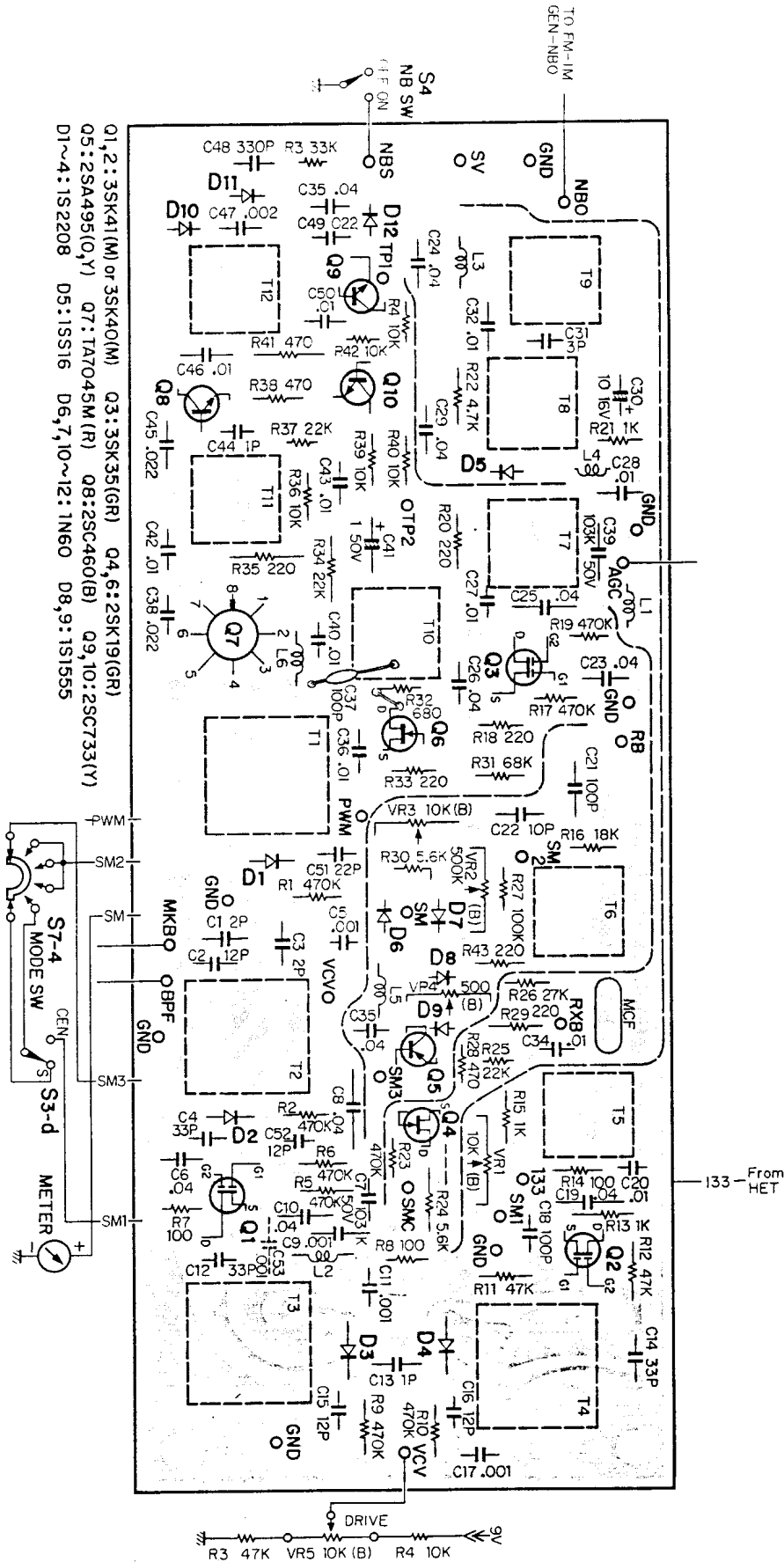

2SA495
2SC733
2SC388

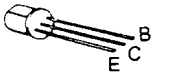

TA7045

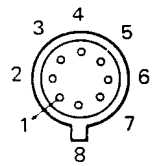

2SC460

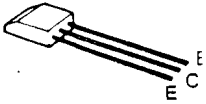

SN76514

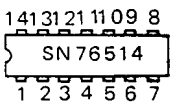

Top view

PC BOARD

▼ HET unit (X50-1300-20): 700A

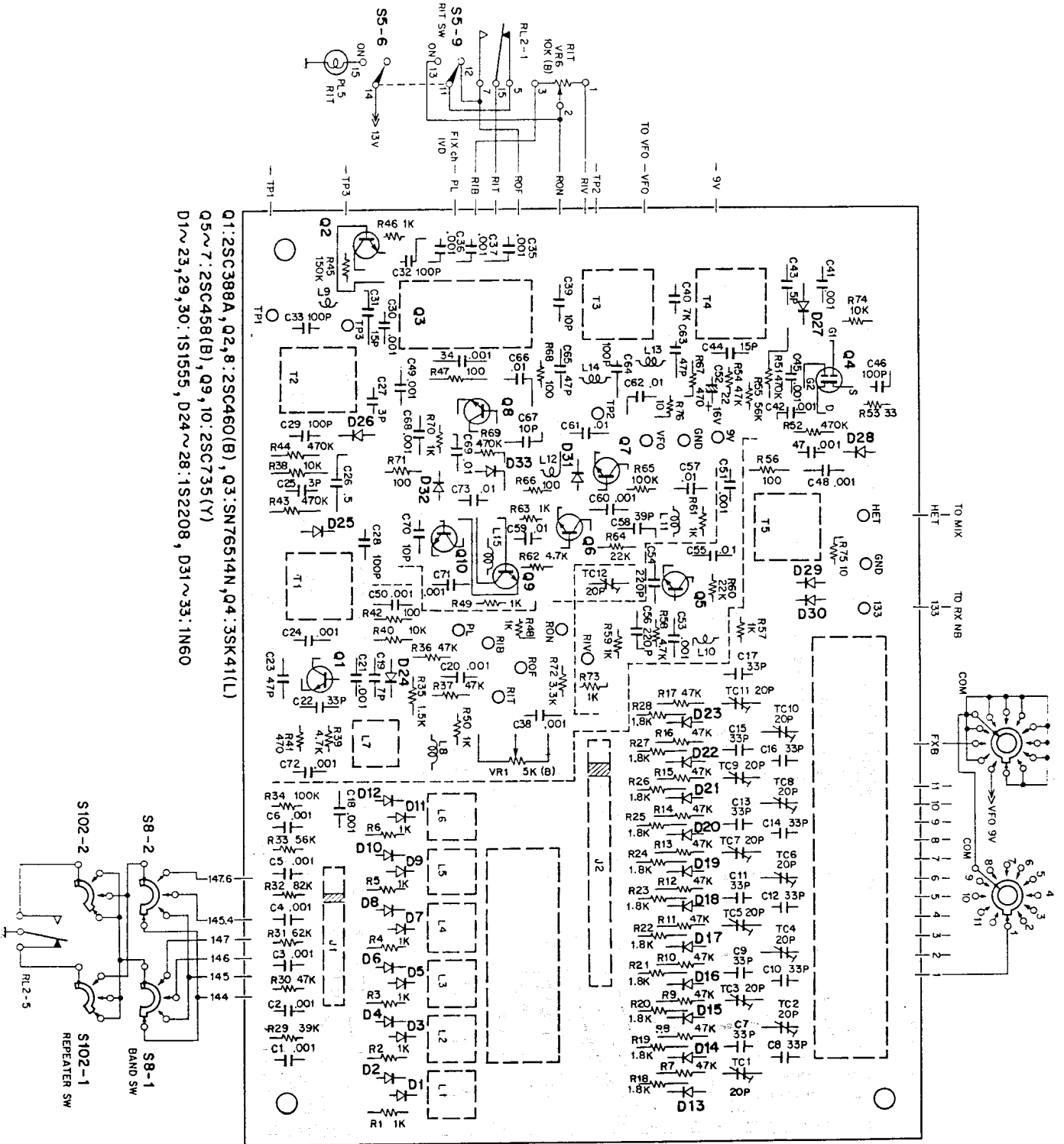

Downloaded by

 Amateur Radio Directory

PC BOARD

▼ HET unit (X50-1170-61): 700G

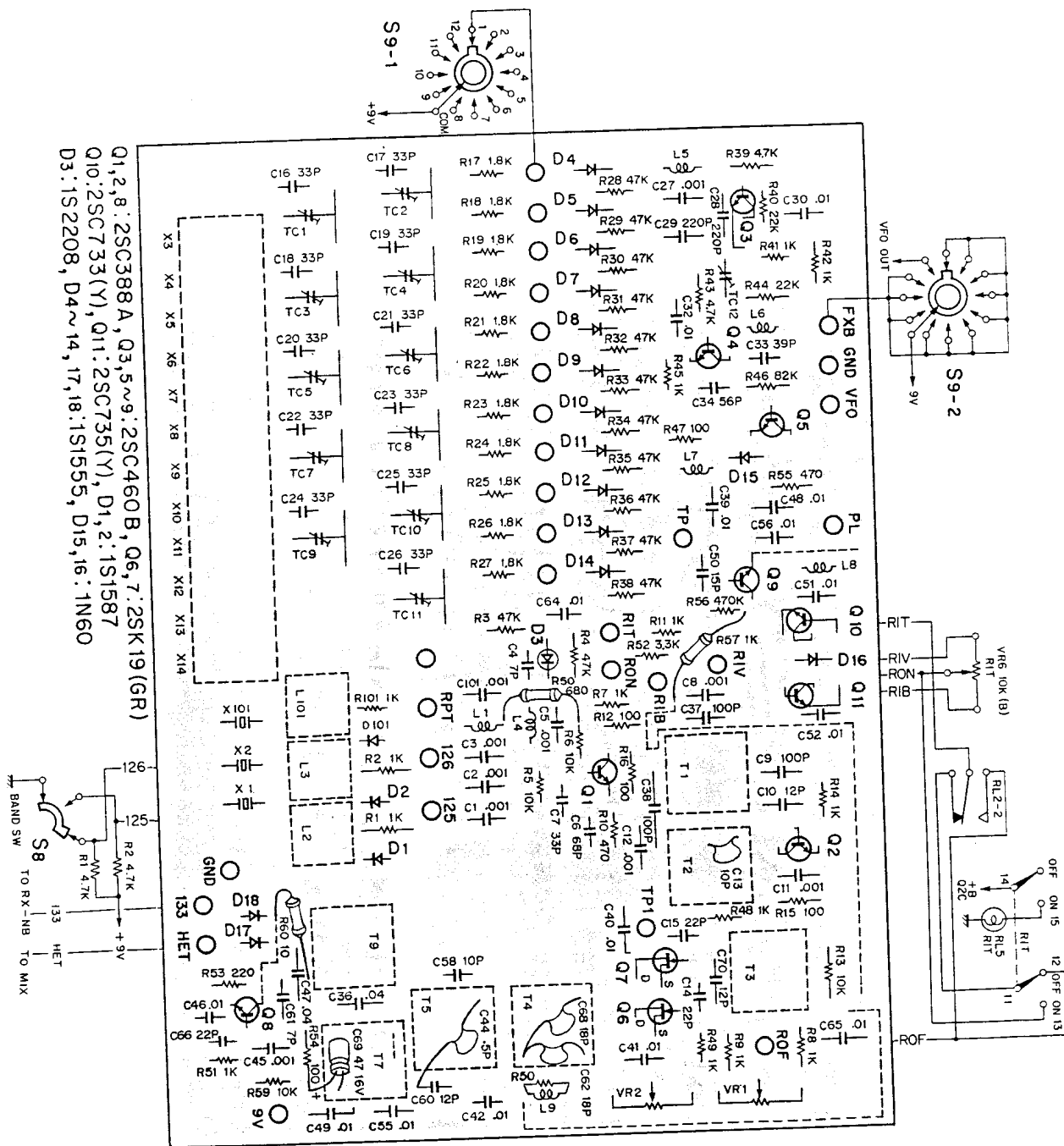

Downloaded by

 Amateur Radio Directory

PC BOARD

▼ MIX (X48-1130-21)

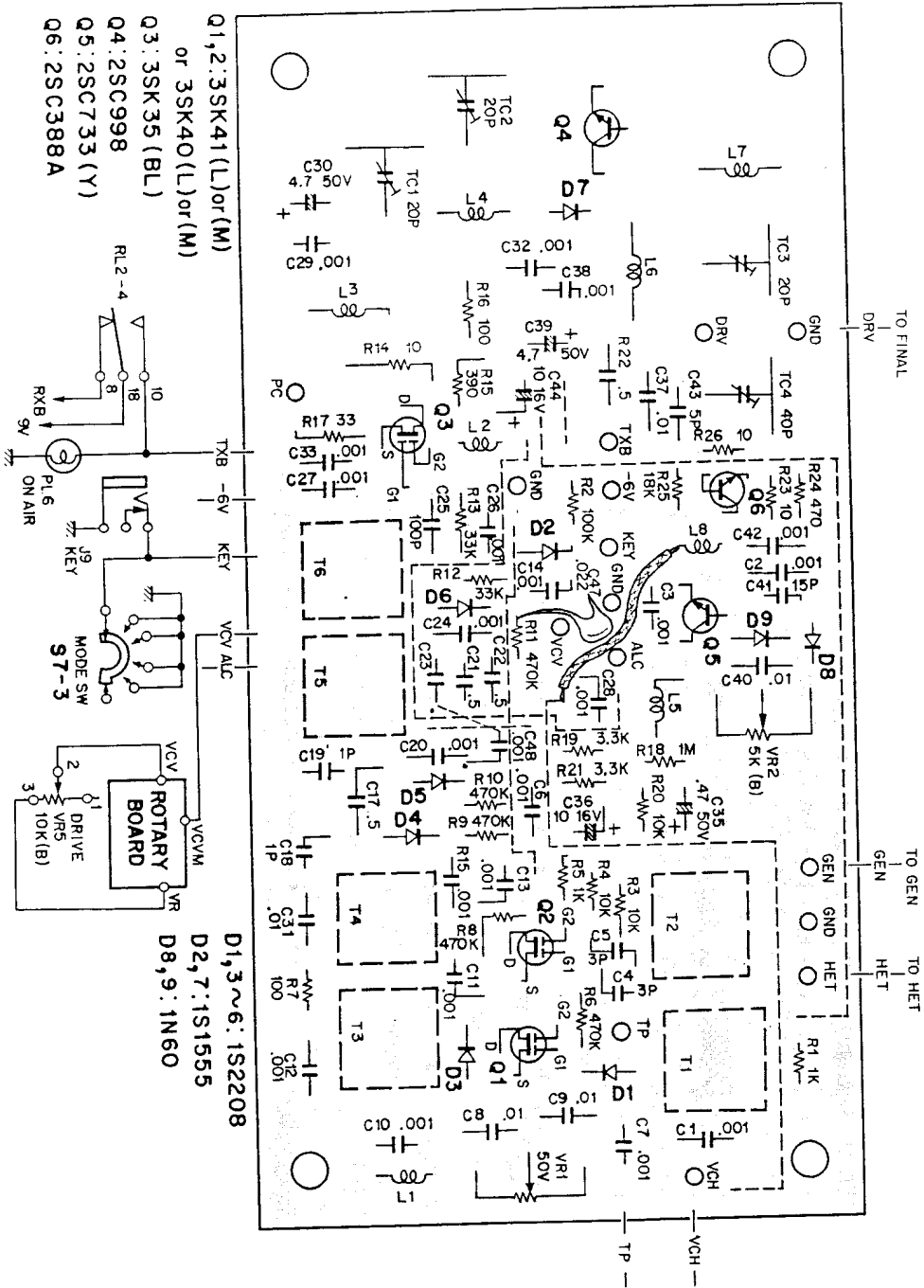

2SC388
2SC733
2SC735



2SC460

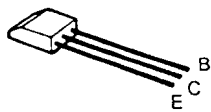

2SK19

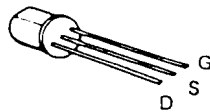

2SC998

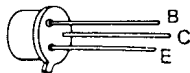

3SK41
3SK35

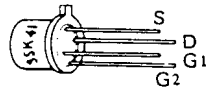

PARTS LIST

Ref No	Parts No.	Description	Re- marks
CAPACITOR			
C1	C90-0187-05	Ceramic 0.0047 μ F	
C2	CK45E1H103P	Ceramic 0.01 μ F	
C101	CK45D1H102M	Ceramic 0.001 μ F	700A
RESISTOR			
R1,2	PD14BY2E472J	Carbon 4.7k Ω \pm 5% 1/4W	700G
R5	PD14BY2E470J	Carbon 47 Ω \pm 5% 1/4W	
R6	PD14BY2E472J	Carbon 4.7k Ω \pm 5% 1/4W	
R7	PD14BY2E331J	Carbon 330 Ω \pm 5% 1/4W	
R8	PD14BY2E561J	Carbon 560 Ω \pm 5% 1/4W	
R9	PD14BY2E471J	Carbon 470 Ω \pm 5% 1/4W	
R101	PD14BY2E223J	Carbon 22k Ω \pm 5% 1/4W	700A
R102	PD14BY2E153J	Carbon 15k Ω \pm 5% 1/4W	700A
R103	PD14BY2E123J	Carbon 12k Ω \pm 5% 1/4W	700A
R104	PD14BY2E822J	Carbon 8.2k Ω \pm 5% 1/4W	700A
R105	PD14BY2E153J	Carbon 15k Ω \pm 5% 1/4W	700A
R106	PD14BY2E392J	Carbon 3.8k Ω \pm 5% 1/4W	700A
R107	PD14BY2E154J	Carbon 150k Ω \pm 5% 1/4W	700A
R108	PD14BY2E124J	Carbon 120k Ω \pm 5% 1/4W	700A
R109	PD14BY2E183J	Carbon 18k Ω \pm 5% 1/4W	700A
R110	PD14BY2E123J	Carbon 12k Ω \pm 5% 1/4W	700A
R111	PD14BY2E102J	Carbon 1k Ω \pm 5% 1/4W	700A
R112,113	PD14BY2E682J	Carbon 6.8k Ω \pm 5% 1/4W	700A
R114	PD14BY2E392J	Carbon 3.9k Ω \pm 5% 1/4W	700A
R115	PD14BY2E682J	Carbon 6.8k Ω \pm 5% 1/4W	700A
R121	PD14BY2E103J	Carbon 6.8k Ω \pm 5% 1/4W	700A
R122	PD14BY2E473J	Carbon 47k Ω \pm 5% 1/4W	700A
SEMICONDUCTOR			
Q1	V04-0046-05	Transistor 2SD235 (Y)	
Q2	V01-0138-05	Transistor 2SA671TD (A)	
Q3	V03-0129-05	Transistor 2SC733 (Y)	
D1,2	V11-0318-05	Diode V06J	
D3	V11-0243-05	Zener diode WZ-061	
D4	V11-0201-05	Zener diode RD7A	
D101 ~ 103	V11-0051-05	Diode 1N60	700A
POTENTIOMETER			
VR1	R01-3015-05	10k Ω (B) AM Car level	
VR2,3	R01-3020-05	10k Ω (A) SSB FM MIC gain	
VR5,6	R03-3055-05	10k Ω (B) Drive RIT	
VR7	R03-3057-05	10k Ω (B) Squelch with switch	
VR8,a,b	R08-9010-05	50k Ω (A), 10k Ω (B) AF-RF GAIN	
VR121	R12-5014-05	100 k Ω (B)	700G
SWITCH/RELAY			
S1	S59-2025-05	Power switch	
S7	S01-3021-05	Rotary (MODE 3-6-5)	
S8	S01-2036-05	Rotary (BAND 2-5-4)	700A
	S01-1042-05	Rotary (BAND 1-4-2)	700G
S9	S01-2021-05	Rotary (Fixed channel 2-2-12)	
S101	S31-2027-05	Slide switch (supply voltage selecting)	
S102	S01-1030-05	Repeater (1-4-3)	700A
RL1	S51-1012-05	Relay	
RL2	S51-6001-15	Relay	
COIL TRANSFORMER			
L1	L40-4711-03	Ferris inductor 470 μ F	
T1	L06-0027-15	Power transformer	
QUARTZ CRYSTAL			
X1	L77-0358-05	125 109 MHz	700A
X2	L77-0359-05	126 109 MHz	700A
X3	L77-0361-05	127 109 MHz	700A
X4	L77-0362-05	128 109 MHz	700A
X5	L77-0501-05	126 509 MHz	700A
X6	L77-0502-05	128 709 MHz	700A

Ref. No.	Parts No.	Description	Re- marks
MISCELLANEOUS			
—	A01-0226-03	Case (A) (upper)	
—	A01-0227-13	Case (B) (lower)	
—	A13-0079-02	Frame (A) (Power supply, VFO)	
—	A13-0080-03	Frame (B) (Marker, AF)	
—	A13-0081-03	Frame (C) (FM-IF)	
—	A13-0082-13	Frame (D) (Right of side board)	
—	A13-0083-13	Frame (E) (MIX, BPF, RXNB)	
—	A21-0240-03	Dressing panel	700A
—	A21-0264-03	Dressing panel	700G
—	A23-0454-03	Rear panel (A)	
—	A23-0467-14	Rear panel (B)	
—	A30-0084-04	Dial back plate	
—	B01-0103-05	Panel escutcheon	
—	B01-0081-13	Escutcheon (A) (Left toward you)	
—	B01-0082-13	Escutcheon (B) (Right toward you)	
—	B07-0108-02	Dial escutcheon	
—	B07-0179-04	Switch grill (700A, 700G for Europe)	
—	B07-0188-04	Switch grill (700G for England)	
—	B10-0140-14	Front glass	
—	B19-0156-04	Filter \times 2	700G
—	B20-0368-03	Dial scale	700A
—	B20-0369-03	Dial scale	
—	B21-3033-04	Dial pointer	
—	B23-3011-04	Indicating plate	
—	B23-9006-04	Knob plate	
—	B30-0007-05	Lamp (dial indication)	
—	B30-0079-05	Lamp \times 4	
—	B31-0232-05	Meter	
—	B40-1339-04	Model name plate	700A
—	B40-1390-04	Model name plate (700G for England)	
—	B40-1391-04	Model name plate (700G for Europe)	700G
—	B41-0208-04	Indicating plate for supply voltage	700G
—	B41-0209-04	Indicating plate for supply voltage	
—	B42-0618-04	Mic adjusting name plate	700A
—	B42-0626-04	FCC plate	700A
—	B43-0239-04	Badge	700G
—	B43-0247-04	Badge	700A
—	B46-0058-00	Warranty card	700A
—	B50-1478-00	Operating manual	700A
—	B50-1520-00	Operating manual (700G for England)	
—	B50-1521-00	Operating manual (700G for Europe)	
—	B58-0213-00	Caution card for supply voltage	700A
—	D21-0341-14	Shaft	
—	D23-0061-04	Bearing	
—	D29-0001-04	Shaft joint	
—	D32-0018-04	Shaft stopper	
—	D32-0075-04	Switch stopper	
—	E01-0903-05	9P MT socket	
—	E05-0901-05	9P MT plug	
—	E06-0403-05	4P Microphone socket	
—	E08-0409-05	4P square socket	
—	E09-0204-05	2P plug	
—	E11-0003-15	Speaker jack	
—	E11-0034-05	Phone jack	
—	E11-0043-05	Key jack	
—	E12-0001-05	Earphone plug	
—	E13-0101-05	1P Pin jack \times 3	
—	E14-0101-05	1P Pin plug \times 4	
—	E15-0038-05	Lamp socket	
—	E22-0207-05	Lug plate 1L2P	700A
—	E22-0405-05	Lug plate 1L4P \times 2	700A
—	E22-0603-05	Lug plate 1L6P	700G
—	E23-0046-04	Terminal	700A
—	E30-0573-05	6P Connector with lead	700A
—	E30-0574-05	12P Connector with lead	700A

PARTS LIST

Ref No	Parts No	Description	Re- marks
—	E33-0009-00	Wire kit	700A
—	E33-0012-00	Wire kit	700G
—	F05-1023-05	Fuse (1A)	700A
—		Fuse (1A) × 2	700G
—	F05-2023-05	Fuse (2A) × 4	700A
—		Fuse (2A) × 2	700G
—	F05-5022-05	Fuse (5A)	
—	F07-0326-04	Shield cover for power supply	
—	F07-0327-04	Transistor cover	
—	F14-0072-04	Socket (blinder) × 2	
—	F15-0164-14	Speaker mask	
—	F15-0165-04	Switch mask	
—	F20-0078-05	Insulator (mica)	
—	G01-0230-04	Coil spring	
—	H01-1527-04	Case (inside)	700A
—	H01-1563-04	Case (inside) (700G for England)	
—	H01-1564-04	Case (inside) (700G for Europe)	
—	H03-0508-04	Case (outside)	700A
—	H03-0523-04	Case (outside) (700G for England)	
—	H03-0524-04	Case (outside) (700G for Europe)	
—	H10-1274-02	Polystyrene foamed fixture (A)	
—	H10-1275-02	Polystyrene foamed fixture (B)	
—	H10-1276-04	Absorbent fixture	
—	H20-0378-04	Protection cover	
—	H25-0007-04	Polyethylene bag	700G
—	H25-0016-00	Polyethylene bag	
—	H25-0036-00	Polyethylene bag	
—	J02-0022-05	Foot 15φ × 4	
—	J02-0049-14	Foot 28φ × 6	
—	J13-0004-05	Fuse holder	
—	J13-0045-05	Fuse holder	
—	J19-0381-04	Meter stopper	
—	J19-0382-04	Socket retainer	
—	J19-0383-04	Lamp retainer	
—	J19-0408-04	Lead wire retainer	
—	J21-0448-04	Speaker retainer	
—	J21-1191-04	PC board retainer	
—	J21-1192-04	Rotary switch retainer	
—	J21-1193-04	Mounting metal	
—	J30-0061-04	Rubber spacer × 2	
—	J31-0110-04	Collar	
—	J32-0188-04	Hexagonal boss (D) (5.5 × 24 mm)	
—	J32-0189-04	Hexagonal boss (A) × 4 (5.5 × 40 mm)	
—	J32-0190-04	Hexagonal boss (B) × 4 (5.5 × 32.5 mm)	
—	J32-1030-14	Round boss × 2	
—	J39-0028-04	Spacer × 2	
—	J59-0001-05	Grommet × 2	
—	J59-0002-05	Plunger × 2	
—	J61-0019-05	Vinyl tie × 30	
—	K01-0055-05	Handle	
—	K20-0130-04	Knob (A) (Main, small)	
—	K20-0131-04	Knob (B) (Main, large)	
—	K21-0279-04	Knob (C) × 6 (RF POWER, Drive, Final, Rit, Squelch, Mode)	
—	K21-0308-04	Knob (G) (AF GAIN)	
—	K21-0309-04	Knob (H) (RF GAIN)	
—	K23-0057-04	Knob (Rubber) × 3	
—	K23-0147-04	Knob (F) × 5	
—	K23-0148-03	Knob (D) (Band)	700G

Ref No	Parts No	Description	Re- marks
—	K23-0149-13	Knob (E) (Fix, CH)	
—	K23-0235-03	Knob (D) (Band)	700A
—	T13-0006-15	Speaker	
—	T91-0029-05	Microphone (700G for England)	
—	T91-0030-05	Microphone (700A, 700G for Europe)	
—	X40-1080-00	VFO unit	
—	X41-1060-00	Switch unit	700A
—	X41-1060-61	Switch unit	700G
—	X42-1050-00	DC cord ass'y	
—	X42-1070-60	Power cord ass'y	700G
—	X42-1080-20	Power cord ass'y	700A
—	X43-1120-00	Power supply unit	
—	X48-1140-20	FM-IF unit	700A
—	X48-1140-61	FM-IF unit	700G
—	X48-1130-21	MIX unit	
—	X49-1060-00	AF unit	
—	X50-1160-00	Carrier unit	
—	X50-1300-20	HET unit	700A
—	X50-1170-61	HET unit	700G
—	X50-1280-00	Marker unit	
—	X51-1090-00	BPF unit	700G
—	X51-1090-21	BPF unit	700A
—	X52-1080-21	Generator unit	
—	X55-1120-00	RX NB unit	
—	X56-1140-01	Final unit	

VFO (X40-1080-00)

Ref. No	Parts No.	Description	Re- marks
CAPACITOR			
C1	CC45CH1H180J	Ceramic 18pF ±5% Tem. compensation	
C2	CC45PG1H220J	Ceramic 22pF ±5% Tem. compensation	
C3	CC45PG1H390J	Ceramic 39pF ±5% Tem. compensation	
C4	CC45PG1H220J	Ceramic 22pF ±5% Tem. compensation	
C5	CC45LG1H220J	Ceramic 22pF ±5% Tem. compensation	
C6.7	CM93F2A101J(DM)	Mica 100pF ±5%	
C8	CC45CH1H030D(Z)	Ceramic 3pF ±0.5pF	
C9	CK45E1H203P	Ceramic 0.02μF +100%, -0%	
C10.11	CK45E1H403P	Ceramic 0.04μF +100%, -0%	
C12	CC45CH1H180J(Z)	Ceramic 18pF ±5%	
C13	CK45E1H403P	Ceramic 0.04μF +100%, -0%	
C14	CC45CH1H180J(Z)	Ceramic 18pF ±5%	
C15	CC45CH1H220J(Z)	Ceramic 22pF ±5%	
C16	CK45E1H103P	Ceramic 0.01μF +100%, -0%	
C17	CK45E1H403P	Ceramic 0.04μF +100%, -0%	
C18	CC45SL1H470J	Ceramic 47pF ±5%	
C19	CC45SL1H101J	Ceramic 100pF ±5%	
C20	CC45SL1H470J	Ceramic 47pF ±5%	
RESISTOR			
R1	PD14CY2E105J	Carbon 1MΩ ±5% 1/4W	
R2	PD14CY2E101J	Carbon 100Ω ±5% 1/4W	
R3.4	PD14CY2E105J	Carbon 1MΩ ±5% 1/4W	
R5	PD14CY2E331J	Carbon 330Ω ±5% 1/4W	
R6	PD14CY2E105J	Carbon 1MΩ ±5% 1/4W	
R7	PD14CY2E333J	Carbon 33kΩ ±5% 1/4W	
R8	PD14CY2E4731	Carbon 47kΩ ±5% 1/4W	
R9	PD14CY2E102J	Carbon 1kΩ ±5% 1/4W	

PARTS LIST

Ref. No.	Parts No.	Description	Re- marks
R10	PD14CY2E101J	Carbon 100Ω ±5% 1/4W	
R11	PD14CY2E103J	Carbon 10kΩ ±5% 1/4W	
SEMICONDUCTOR			
Q1.2	V09-0020-05	FET 3SK22 (Y)	
Q3.4	V03-0079-05	Transistor 2SC460 (B)	
D1.2	V11-0051-05	Diode 1N60	
COIL			
L1	L32-0166-05	Coil (Oscillation)	
L2.3	L40-1021-03	Ferri-inductor 1mH	
L4	L40-2201-03	Ferri-inductor 22μH	
L5.6	L40-1021-03	Ferri-inductor 1mH	
L7.8	L40-4791-02	Ferri-inductor 4.7μH	
VARIABLE CAPACITOR/TRIMMER			
VC1	C01-0177-05	Variable capacitor	
TC1	C03-0001-05	Variable capacitor (Small)	
TC2	C05-0013-15	Trimmer 20pF	
MISCELLANEOUS			
—	A01-0169-13	VFO case	
—	B42-0010-04	Name plate	
—	D22-0011-05	Shaft coupling	
—	E08-0204-05	2P jack	
—	E13-0101-05	1P jack	
—	E22-0207-05	Lug	
—	E23-0015-04	Oval lug terminal × 2	
—	E23-0046-04	Wrapping terminal × 4	
—	F07-0231-24	VFO cover	
—	F10-0249-04	VFO shield plate	
—	F11-0010-04	VFO box (G)	
—	G03-0009-04	Spring	
—	J21-0895-03	VFO variable capacitor retainer	
—	J21-1156-03	VFO mounting fitting	
—	X41-1020-00	Gear unit	

SWITCH (X41-1060-00: 700A, -61: 700G)

Ref No	Parts No.	Description	Re- marks
SWITCH			
S2 ~ 6	S36-2026-15	Lever switch	700A
S2 ~ 5	S36-2026-15	Lever switch	700G
S6	S36-2029-05	Lever switch (non-lock)	700G
MISCELLANEOUS			
—	E23-0046-04	Terminal × 5	
—	E23-0047-04	Terminal × 14	

POWER SUPPLY CORD ASS'Y (X42-1070-60) 700G

Ref No	Parts No.	Description	Re- marks
—	E03-0301-15	Plug	
—	E09-0426-05	4P plug (square)	
—	J61-0014-05	Belt	

POWER SUPPLY CORD ASS'Y (X42-1080-20) 700A

Ref. No.	Parts No.	Description	Re- marks
—	E09-0426-05	4P plug (square)	
—	E30-0181-05	AC cord with plug	
—	J41-0006-00	Cord bushing	

DC CORD ASS'Y (X42-1050-00)

Ref. No.	Parts No.	Description	Re- marks
—	E09-0426-05	4P plug (square)	
—	F05-5022-05	Fuse (5A)	
—	J13-0029-05	Fuse holder	
—	J41-0006-00	Cord bushing	

POWER SOURCE (X43-1120-00)

Ref. No.	Parts No.	Description	Re- marks
CAPACITOR			
C1.2	CE02W1E332	Electrolytic 3300μF 25WV	
C3	CE04W1HR47(RL)	Electrolytic 0.47μF 50WV	
C4	CE04W1C100(RL)	Electrolytic 10μF 50WV	
C5	CE04W1HR47(RL)	Electrolytic 0.47μF 50WV	
C6	CE04W1V4R7(RL)	Electrolytic 4.7μF 35WV	
C7	CE02W1E222	Electrolytic 2200μF 25WV	
C8	CE04W1V4R7(RL)	Electrolytic 4.7μF 35WV	
C9	CE02W1V222	Electrolytic 2200μF 35WV	
C10	CE04W1H010(RL)	Electrolytic 1μF 50WV	
C11	CE02W1V102	Electrolytic 1000μF 35WV	
C12	CE04W1C471(RL)	Electrolytic 470μF 16WV	
C13	CK45F1H403Z	Ceramic 0.04μF +80%, -20%	
C14	CC45SL1H391J	Ceramic 390pF ±5%	
C15	CK45F1H403Z	Ceramic 0.04μF +80%, -20%	
C16	CE02W1C102	Electrolytic 100μF 16WV	
C17	CE02W1E222	Electrolytic 2200μF 25WV	
C18	CE04W1H330(RL)	Electrolytic 33μF 50WV	
CK1 ~ 12	C90-0194-05	Ceramic 0.001μF	
RESISTOR			
R1	PD14CY2E221J	Carbon 220Ω ±5% 1/4W	
R2	PD14CY2E222J	Carbon 2.2kΩ ±5% 1/4W	
R3.4	PD14CY2E223J	Carbon 22kΩ ±5% 1/4W	
R5	PD14CY2E681J	Carbon 680Ω ±5% 1/4W	
R6	PD14CY2E471J	Carbon 470Ω ±5% 1/4W	
R7	PD14CY2E103J	Carbon 10kΩ ±5% 1/4W	
R8	PD14CY2E152J	Carbon 1.5kΩ ±5% 1/4W	
R9	PD14CY2E151J	Carbon 150Ω ±5% 1/4W	
R10	PD14CY2E331J	Carbon 330Ω ±5% 1/4W	
R12	PD14CY2E222J	Carbon 2.2kΩ ±5% 1/4W	
R13.14	PD14CY2E152J	Carbon 1.5kΩ ±5% 1/4W	
R15	PD14CY2E331J	Carbon 330Ω ±5% 1/4W	
R16	PD14CY2E472J	Carbon 4.7kΩ ±5% 1/4W	
R17	PD14CY2E562J	Carbon 5.6kΩ ±5% 1/4W	
R18	PD14CY2E392J	Carbon 3.9kΩ ±5% 1/4W	
R19	PD14CY2E472J	Carbon 4.7kΩ ±5% 1/4W	
R20.21	PD14CY2E392J	Carbon 3.9kΩ ±5% 1/4W	
R22	PD14CY2E471J	Carbon 470Ω ±5% 1/4W	
R23	PD14CY2E104J	Carbon 100kΩ ±5% 1/4W	
R24	PD14CY2E472J	Carbon 4.7kΩ ±5% 1/4W	
R25	PD14CY2E102J	Carbon 1kΩ ±5% 1/4W	
R26	PD14CY2E223J	Carbon 22kΩ ±5% 1/4W	
R27	PD14CY2E152J	Carbon 1.5kΩ ±5% 1/4W	
R28	PD14CY2E102J	Carbon 1kΩ ±5% 1/4W	

PARTS LIST

Ref No	Parts No.	Description	Re- marks
R29	PD14BY2E101J	Carbon 100 Ω \pm 5% 1/4W	
SEMICONDUCTOR			
Q1	V03-0123-05	Transistor 2SC733 (Y)	
Q2	V03-0126-05	Transistor 2SC734 (Y)	
Q3	V03-0123-05	Transistor 2SC733 (Y)	
Q4	V04-0046-05	Transistor 2SD235 (Y)	
Q5	V02-0040-05	Transistor 2SB405 (R)	
Q6	V01-0139-05	Transistor 2SA671TD (B)	
Q7.8	V03-0126-05	Transistor 2SC734 (Y)	
Q9	V01-0037-05	Transistor 2SA495 (Y). (O)	
Q10	V03-0123-05	Transistor 2SC733 (Y)	
Q11	V30-0054-05	IC MFC4060A	
Q12	V04-0046-05	Transistor 2SD235(Y)	
D1	V11-0223-05	Rectifier DS-10B-N-L	
D2.3	V11-0270-05	Diode U05B	
D4.5	V11-0219-05	Diode V06B	
D6	V11-0243-05	Zener diode WZ061	
D7	V11-0219-05	Diode V06B	
D9	V11-0051-05	Diode 1N60	
POTENTIOMETER			
VR1.2	R12-1012-05	1k Ω (B)	
COIL			
L1	L40-1545-06	Ferri-inductor 150mH	
MISCELLANEOUS			
—	E23-0047-04	Wrapping terminal \times 14	
—	E23-0048-04	Wrapping terminal \times 4	
—	F01-0167-04	Heat sink (A)	
—	F01-0168-04	Heat sink (B)	
—	F11-0194-03	Power source shield case	
—	F20-0078-05	Insulating mica	

FM-IF (X48-1140-20: 700A, -61: 700G)

Ref. No.	Parts No.	Description	Re- marks
CAPACITOR			
C1	CC45SL1H100D	Ceramic 10pF \pm 0.5pF	
C2.3	CK45F1H103Z	Ceramic 0.01 μ F +80% -20%	
C4	CC45SL1H101J	Ceramic 100pF \pm 5%	
C5.6	CK45F1H403Z	Ceramic 0.04 μ F +80% -20%	
C7	CK45F1H103Z	Ceramic 0.01 μ F +80% -20%	
C8	CM93D1H151J(DM)	Mica 150pF \pm 5%	
C9	CM93D1H681J(DM)	Mica 680pF \pm 5%	
C10	CC45SL1H221J	Ceramic 220pF \pm 5%	
C11	CE04W1H4R7(RL)	Electrolytic 4.7 μ F 50WV	
C12	CK45D1H102M	Ceramic 0.001 μ F \pm 20%	
C13	CC45SL1H470J	Ceramic 47pF \pm 5%	
C14	CK45F1H103Z	Ceramic 0.01 μ F +80% -20%	
C15	CK45D1H102M	Ceramic 0.001 μ F \pm 20%	
C16	CK45F1H103Z	Ceramic 0.01 μ F +80% -20%	
C17	CE04W1C100(RL)	Electrolytic 10 μ F 16WV	
C18	CK45F1H103Z	Ceramic 0.01 μ F +80% -20%	
C19	CE04W1C100(RL)	Electrolytic 10 μ F 16WV	
C20	CK45SL1H101J	Ceramic 100pF \pm 5%	
C21	CK45F1H103Z	Ceramic 0.01 μ F +80% -20%	
C22	CE04W1C100(RL)	Electrolytic 10 μ F 16WV	
C23	CE04W1H4R7(RL)	Electrolytic 4.7 μ F 50WV	
C24	CK45F1H103Z	Ceramic 0.01 μ F +80% -20%	
C25.26	CK45F1H203Z	Ceramic 0.02 μ F +80 -20%	
C27	CE04W1C470(RL)	Electrolytic 47 μ F 16WV	700A
C28	CK45F1H103Z	Ceramic 0.01 μ F +80% -20%	700A
C29	CE04WQJ4R7(RL)	Electrolytic 4.7 μ F 6.3WV	

Ref No	Parts No	Description	Re- marks
C30	CQ92M1H222K	Mylar 0.0022 μ F \pm 10%	
C31	CQ92M1H102K	Mylar 0.001 μ F \pm 10%	
C32	CQ92M1H332K	Mylar 0.0033 μ F \pm 10%	
C33	CE04W1C100(RL)	Electrolytic 10 μ F 16WV	
C34	CE04W1E220(RL)	Electrolytic 22 μ F 25WV	
C35	CK45F1H403Z	Ceramic 0.04 μ F +80% -20%	
C36	CC45SL1H101J	Ceramic 100pF \pm 5%	
C37.38	CK45F1H103Z	Ceramic 0.01 μ F +80% -20%	
C39	CQ92M1H223K	Ceramic 0.022 μ F \pm 10%	
C40	CK45D1H102M	Ceramic 0.001 μ F \pm 20%	
C41	CC45SL1H221J	Ceramic 220pF \pm 5%	
C42	CE04W1C100(RL)	Electrolytic 10 μ F 16WV	
C43	CC45SL1H331J	Ceramic 330pF \pm 5%	
C44	CE04W1HR47(RL)	Electrolytic 0.47 μ F 50WV	
C45	CK45D1H102M	Ceramic 0.001 μ F \pm 20%	
C46	CE04W1H010(RL)	Electrolytic 1 μ F 50WV	
C47.48	CQ92M1H223K	Mylar 0.022 μ F \pm 10%	
C49	CE04W1H010(RL)	Electrolytic 1 μ F 50WV	
C50	CE04W1C100(RL)	Electrolytic 10 μ F 16WV	
C51	CE04W1H4R7(RL)	Electrolytic 4.7 μ F 50WV	
C52.53	CK45D1H102M	Ceramic 0.001 μ F \pm 20%	700A
RESISTOR			
R1	PD14CY2E474J	Carbon 470k Ω \pm 5% 1/4W	
R2	PD14CY2E331J	Carbon 330 Ω \pm 5% 1/4W	
R3	PD14CY2E102J	Carbon 1k Ω \pm 5% 1/4W	
R4	PD14CY2E471J	Carbon 470 Ω \pm 5% 1/4W	
R5	PD14CY2E104J	Carbon 100k Ω \pm 5% 1/4W	
R6	PD14CY2E102J	Carbon 1k Ω \pm 5% 1/4W	
R7	PD14CY2E102J	Carbon 1k Ω \pm 5% 1/4W	
R8	PD14CY2E224J	Carbon 220k Ω \pm 5% 1/4W	
R9	PD14CY2E394J	Carbon 390k Ω \pm 5% 1/4W	
R10	PD14CY2E472J	Carbon 4.7k Ω \pm 5% 1/4W	
R11	PD14CY2E222J	Carbon 2.2k Ω \pm 5% 1/4W	700A
R12	PD14CY2E151J	Carbon 150 Ω \pm 5% 1/4W	
R13	PD14CY2E474J	Carbon 470k Ω \pm 5% 1/4W	
R14	PD14CY2E472J	Carbon 4.7k Ω \pm 5% 1/4W	
R15	PD14CY2E474J	Carbon 470k Ω \pm 5% 1/4W	
R16	PD14CY2E222J	Carbon 2.2k Ω \pm 5% 1/4W	
R17	PD14CY2E474J	Carbon 470k Ω \pm 5% 1/4W	
R18	PD14CY2E102J	Carbon 1k Ω \pm 5% 1/4W	
R19	PD14CY2E224J	Carbon 220k Ω \pm 5% 1/4W	
R20	PD14CY2E332J	Carbon 3.3k Ω \pm 5% 1/4W	
R21.22	PD14CY2E102J	Carbon 1k Ω \pm 5% 1/4W	
R23.24	PD14CY2E562J	Carbon 5.6k Ω \pm 5% 1/4W	
R25	PD14CY2E224J	Carbon 220k Ω \pm 5% 1/4W	
R26	PD14CY2E154J	Carbon 150k Ω \pm 5% 1/4W	700A
R27	PD14CY2E222J	Carbon 2.2k Ω \pm 5% 1/4W	700A
R28	PD14CY2E681J	Carbon 680 Ω \pm 5% 1/4W	700A
R29	PD14CY2E183J	Carbon 18k Ω \pm 5% 1/4W	
R30	PD14CY2E154J	Carbon 150k Ω \pm 5% 1/4W	
R31	PD14CY2E181J	Carbon 180 Ω \pm 5% 1/4W	
R32	PD14CY2E392J	Carbon 3.9k Ω \pm 5% 1/4W	
R33	PD14CY2E682J	Carbon 6.8k Ω \pm 5% 1/4W	
R34	PD14CY2E333J	Carbon 33k Ω \pm 5% 1/4W	
R35	PD14CY2E122J	Carbon 1.2k Ω \pm 5% 1/4W	
R36	PD14CY2E274J	Carbon 270k Ω \pm 5% 1/4W	
R37	PD14CY2E154J	Carbon 150k Ω \pm 5% 1/4W	
R38	PD14CY2E182J	Carbon 1.8k Ω \pm 5% 1/4W	
R39	PD14CY2E104J	Carbon 100k Ω \pm 5% 1/4W	
R40	PD14CY2E684J	Carbon 680k Ω \pm 5% 1/4W	
R41	PD14CY2E103J	Carbon 10k Ω \pm 5% 1/4W	
R42	PD14CY2E332J	Carbon 3.3k Ω \pm 5% 1/4W	
R43	PD14CY2E563J	Carbon 56k Ω \pm 5% 1/4W	
R44	PD14CY2E224J	Carbon 22k Ω \pm 5% 1/4W	
R45	PD14CY2E473J	Carbon 47k Ω \pm 5% 1/4W	
R46	PD14CY2E103J	Carbon 10k Ω \pm 5% 1/4W	
R47	PD14CY2E473J	Carbon 47k Ω \pm 5% 1/4W	

PARTS LIST

Ref. No.	Parts No.	Description	Re- marks
R48.49	PD14CY2E823J	Carbon 82k Ω \pm 5% 1/4W	
R50	PD14CY2E391J	Carbon 390 Ω \pm 5% 1/4W	
R51	PD14CY2E473J	Carbon 47k Ω \pm 5% 1/4W	
R52	PD14CY2E683J	Carbon 68k Ω \pm 5% 1/4W	
R53	PD14CY2E104J	Carbon 100k Ω \pm 5% 1/4W	
R54	PD14CY2E223J	Carbon 22k Ω \pm 5% 1/4W	
R55	PD14CY2E222J	Carbon 2.2k Ω \pm 5% 1/4W	
R56	PD14CY2E472J	Carbon 4.7k Ω \pm 5% 1/4W	
R57	PD14CY2E102J	Carbon 1k Ω \pm 5% 1/4W	
SEMICONDUCTOR			
Q1~3	V03-0079-05	Transistor 2SC460 (B)	700A 700A
Q4~6	V03-0094-05	Transistor 2SC458 (B)	
Q7	V03-0079-05	Transistor 2SC460 (B)	
Q8.9	V03-0376-05	Transistor 2SC733 (Y)	
Q10	V01-0038-05	Transistor 2SA562 (Y)	
Q11~17	V03-0376-05	Transistor 2SC733 (Y)	
D1.2	V11-0051-05	Diode 1N60	700A 700A
D3~6	V11-0076-05	Diode 1S1555	
D7.8	V11-0051-05	Diode 1N60	
D9.10	V11-0076-05	Diode 1S1555	
D11.12	V11-0076-05	Diode 1S1555	
D13	V11-0243-05	Zener diode WZ-061	
D14	V11-0076-05	Diode 1S1555	
POTENTIOMETER			
VR1	R12-5016-05	100k Ω (B)	
VR2	R12-7013-05	500k Ω (B)	
COIL/TRANSFORMER			
T1.2	L30-0199-05	IFT 455 kHz	
T3	L30-0006-05	Discriminator coil (D)	
T4	L30-0007-05	Discriminator coil (E)	
L1	L40-1045-06	Ferri-inductor 100mH	
L2	L40-6825-04	Ferri-inductor 6.8mH	
L3	L40-1001-03	Ferri-inductor 1mH	
FILTER			
CF1	L72-0015-05	Ceramic filter SFC-10.7MA	
CF2	L72-0037-05	Ceramic filter CFR-455F	
QUARTZ CRYSTAL			
X1	L77-0327-05	10.245 MHz	
MISCELLANEOUS			
---	L79-0034-05	Piezo-electric tuning fork	
---	E18-0307-05	Socket	
---	E23-0047-04	Wrapping terminal \times 18	

MIX (X48-1130-00)

Ref. No.	Parts No.	Description	Re- marks
CAPACITOR			
C1~3	CK45D1H102M	Ceramic 0.001 μ F \pm 20%	
C4.5	CC45SL1H030C	Ceramic 3pF \pm 0.25pF	
C6.7	CK45D1H102M	Ceramic 0.001 μ F \pm 20%	
C8.9	CK45F1H103Z	Ceramic 0.01 μ F \pm 80% - 20%	
C10~15	CK45D1H102M	Ceramic 0.001 μ F \pm 20%	
C17	CC45SL1H0R5C	Ceramic 0.5pF \pm 0.25pF	
C18.19	CC45SL1H010C	Ceramic 1pF \pm 0.25pF	
C20	CK45D1H102M	Ceramic 0.001 μ F \pm 20%	
C21.22	CC45SL1H0R5C	Ceramic 0.5pF \pm 0.25pF	
C24	CK45D1H102M	Ceramic 0.001 μ F \pm 20%	
C25	CC45SL1H101J	Ceramic 100pF \pm 5%	

Ref. No.	Parts No.	Description	Re- marks
C26~29	CK45D1H102M	Ceramic 0.001 μ F \pm 20%	
C30	CE04W1HR47(RL)	Electrolytic 0.47 μ F 50WV	
C31	CK45F1H103Z	Ceramic 0.01 μ F \pm 80% - 20%	
C32.33	CK45D1H102M	Ceramic 0.001 μ F \pm 20%	
C35	CE04W1HR47(RL)	Electrolytic 0.47 μ F 50WV	
C36	CE04W1C100(RL)	Electrolytic 10 μ F 16WV	
C37	CK45F1H103Z	Ceramic 0.01 μ F \pm 80% - 20%	
C38	CK45D1H102M	Ceramic 0.001 μ F \pm 20%	
C39	CE04W1H4R7(RL)	Electrolytic 4.7 μ F 50WV	
C40	CK45F1H103Z	Ceramic 0.01 μ F \pm 80% - 20%	
C41	CC45SL1H150J	Ceramic 15pF \pm 5%	
C42	CK45D1H102M	Ceramic 0.001 μ F \pm 20%	
C43	CC45SL1H050C	Ceramic 5pF \pm 0.25pF	
C44	CE04W1C100(RL)	Electrolytic 10 μ F 16WV	
C45~48	CK45D1H102M	Ceramic 0.001 μ F \pm 20%	
RESISTOR			
R1	PD14CY2E102J	Carbon 1k Ω \pm 5% 1/4W	
R2	PD14CY2E104J	Carbon 100k Ω \pm 5% 1/4W	
R3.4	PD14CY2E103J	Carbon 10k Ω \pm 5% 1/4W	
R5	PD14CY2E104J	Carbon 100k Ω \pm 5% 1/4W	
R6	PD14CY2E474J	Carbon 470k Ω \pm 5% 1/4W	
R7	PD14CY2E101J	Carbon 100 Ω \pm 5% 1/4W	
R8~11	PD14CY2E474J	Carbon 470k Ω \pm 5% 1/4W	
R12.13	PD14CY2E333J	Carbon 33k Ω \pm 5% 1/4W	
R14	PD14CY2E100J	Carbon 10 Ω \pm 5% 1/4W	
R15	PD14CY2E391J	Carbon 390 Ω \pm 5% 1/4W	
R16	PD14CY2E101J	Carbon 100 Ω \pm 5% 1/4W	
R17	PD14CY2E330J	Carbon 33 Ω \pm 5% 1/4W	
R18	PD14CY2E105J	Carbon 1M Ω \pm 5% 1/4W	
R19	PD14CY2E332J	Carbon 3.3k Ω \pm 5% 1/4W	
R20	PD14CY2E103J	Carbon 10k Ω \pm 5% 1/4W	
R21	PD14CY2E332J	Carbon 3.3k Ω \pm 5% 1/4W	
R22.23	PD14CY2E100J	Carbon 10 Ω \pm 5% 1/4W	
R24	PD14CY2E471J	Carbon 470 Ω \pm 5% 1/4W	
R25	PD14CY2E183J	Carbon 18k Ω \pm 5% 1/4W	
R26	PD14CY2E100J	Carbon 10 Ω \pm 5% 1/4W	
SEMICONDUCTOR			
Q1.2	V09-0067-05	FET 3SK41 (L) (M)	
Q3	V09-0034-05	FET 3SK35 (BL)	
Q4	V03-0168-05	Transistor 2SC998	
Q5	V03-0123-05	Transistor 2SC733 (Y)	
Q6	V03-0053-05	Transistor 2SC388A	
D2	V11-0076-05	Diode 1S1555	
D3~6	V11-9898-05	Diode 1S2208	
D7	V11-0076-05	Diode 1S1555	
D8.9	V11-0051-05	Diode 1N60	
POTENTIOMETER			
VR1	R12-0042-05	500 Ω (B)	
VR2	R12-2015-05	5k Ω (B)	
COIL TRANSFORMER			
L1	L33-0220-05	RFC (choke coil) 2.4 μ H	
L2	L40-1001-03	Ferri-inductor 10 μ H	
L3	L34-0353-05	VHF coil	
L4	L34-0442-05	VHF coil	
L5	L40-1001-03	Ferri-inductor 10 μ H	
L6	L34-0448-05	VHF coil	
L7	L34-0352-05	VHF coil	
L8	L40-1001-03	Ferri-inductor 10 μ H	
T2	L30-0264-05	IFT 10.7 MHz	
T3	L31-0322-05	Tuning coil 144 MHz	
T4	L31-0321-05	IFT 144 MHz	
T5	L31-0266-05	IFT 144 MHz	
T6	L31-0323-05	Tuning coil 144 MHz	

PARTS LIST

AF (X49-1060-00)

Ref No	Parts No	Description	Re- marks
TRIMMER			
TC1 ~ 3	C05-0030-15	Ceramic trimmer	20pF
TC4	C05-0015-15	Ceramic trimmer	40pF
MISCELLANEOUS			
—	E23-0047-04	Wrapping terminal	
—	F02-0004-05	Cooler	
CAPACITOR			
C1	CE04W1H010(RL)	Electrolytic	1 μ F 50WV
C2	CE04W1V4R7(RL)	Electrolytic	4.7 μ F 35WV
C3	CE04W1H010(RL)	Electrolytic	1 μ F 50WV
C4	CE04W1V4R7(RL)	Electrolytic	4.7 μ F 35WV
C5	CE04W1H010(RL)	Electrolytic	1 μ F 50WV
C6	CE04W1V4R7(RL)	Electrolytic	4.7 μ F 35WV
C7	CE04W1HR47(RL)	Electrolytic	0.47 μ F 50WV
C8	CQ93M1H332K	Mylar film	0.0033 μ F \pm 10%
C9	CQ93M1H333K	Mylar film	0.033 μ F \pm 10%
C10	CQ93M1H153K	Mylar film	0.015 μ F \pm 10%
C11	CQ93M1H473K	Mylar film	0.047 μ F \pm 10%
C12	CC45SL1H391K	Ceramic	390pF \pm 10%
C13	CE04W1H4R7(RL)	Electrolytic	4.7 μ F 50WV
C14.15	CE04W1C100(RL)	Electrolytic	10 μ F 16WV
C16	CE04W1C470(RL)	Electrolytic	47 μ F 16WV
C17	CE04W1V4R7(RL)	Electrolytic	4.7 μ F 35WV
C18	CQ93M1H103K	Mylar film	0.01 μ F \pm 10%
C19	CE04W1A470(RL)	Electrolytic	47 μ F 10WV
C20	CE04W1E100(RL)	Electrolytic	10 μ F 25WV
C21	CC45SL1H471K	Ceramic	470pF \pm 10%
C22	CE04W1C470(RL)	Electrolytic	47 μ F 16WV
C23	CE04W1C101(RL)	Electrolytic	100 μ F 16WV
C24	CE04W1C330(RL)	Electrolytic	33 μ F 16WV
C25	CE04W1E221(RL)	Electrolytic	220 μ F 25WV
C26.27	CK45F1H403Z	Ceramic	0.04 μ F \pm 80% - 20%
C28	CE04W1C330(RL)	Electrolytic	33 μ F 16WV
C29	CK45F1H403Z	Ceramic	0.04 μ F \pm 80% - 20%
C30	CK45F1H403Z	Ceramic	0.04 μ F \pm 80% - 20%
C31	CK45D1H103M	Ceramic	0.01 μ F \pm 20%
C32	CK45D1H102M	Ceramic	0.001 μ F \pm 20%
C33	CK45F1H403Z	Ceramic	0.04 μ F \pm 80% - 20%
C34	CC45SL1H101K	Ceramic	100pF \pm 10%
RESISTOR			
R1	PD14CY2E103J	Carbon	10k Ω \pm 5% 1/4W
R2	PD14CY2E472J	Carbon	4.7k Ω \pm 5% 1/4W
R3.4	PD14CY2E103J	Carbon	10k Ω \pm 5% 1/4W
R5	PD14CY2E472J	Carbon	4.7k Ω \pm 5% 1/4W
R6.7	PD14CY2E103J	Carbon	10k Ω \pm 5% 1/4W
R8	PD14CY2E472J	Carbon	4.7k Ω \pm 5% 1/4W
R9.10	PD14CY2E103J	Carbon	10k Ω \pm 5% 1/4W
R11.12	PD14CY2E562J	Carbon	5.6k Ω \pm 5% 1/4W
R13	PD14CY2E102J	Carbon	1k Ω \pm 5% 1/4W
R14	PD14CY2E103J	Carbon	10k Ω \pm 5% 1/4W
R15	PD14CY2E823J	Carbon	82k Ω \pm 5% 1/4W
R16	PD14CY2E222J	Carbon	2.2k Ω \pm 5% 1/4W
R17	PD14CY2E223J	Carbon	22k Ω \pm 5% 1/4W
R18	PD14CY2E272J	Carbon	2.7k Ω \pm 5% 1/4W
R19	PD14CY2E221J	Carbon	220 Ω \pm 5% 1/4W
R20	PD14CY2E102J	Carbon	1k Ω \pm 5% 1/4W
R21	PD14CY2E222J	Carbon	2.2k Ω \pm 5% 1/4W
R22	PD14CY2E562J	Carbon	5.6k Ω \pm 5% 1/4W
R23	PD14CY2E471J	Carbon	470 Ω \pm 5% 1/4W
R24	PD14CY2E223J	Carbon	22k Ω \pm 5% 1/4W
R25	PD14CY2E103J	Carbon	10k Ω \pm 5% 1/4W
R26	PD14CY2E102J	Carbon	1k Ω \pm 5% 1/4W
R27	PD14CY2E471J	Carbon	470 Ω \pm 5% 1/4W

Ref No	Parts No	Description	Re- marks
R28	PD14CY2E152J	Carbon	15k Ω \pm 5% 1/4W
R29	PD14CY2E682J	Carbon	6.8k Ω \pm 5% 1/4W
R30	PD14CY2E330J	Carbon	33 Ω \pm 5% 1/4W
R31	PD14CY2E101J	Carbon	100 Ω \pm 5% 1/4W
R32	PD14CY2E221J	Carbon	220 Ω \pm 5% 1/4W
R33.34	R92-0144-05	Metal plate	1 Ω \pm 5% 1W
R35	PD14CY2E471J	Carbon	470 Ω \pm 5% 1/4W
R36	PD14CY2E104J	Carbon	100k Ω \pm 5% 1/4W
R37	PD14CY2E471J	Carbon	470 Ω \pm 5% 1/4W
R38	PD14CY2E180J	Carbon	18 Ω \pm 5% 1/4W
SEMICONDUCTOR			
Q1.2	V03-0123-05	Transistor	2SC733 (O)
Q3	V03-0042-05	Transistor	2SC373
Q4	V03-0126-05	Transistor	2SC734 (Y)
Q5	V03-0169-05	Transistor	2SC1061 (A)
Q6	V01-0138-05	Transistor	2SA671TD (A)
D1 ~ 6	V11-0076-05	Diode	1S1555
D7	V30-0075-05	Diode	M8513A-0
TH1	V22-0008-05	Thermister	SDT-6
COIL			
L1	L33-0025-05	Choke coil	1 μ H
B3	L40-1092-03	Ferri-inductor	
MISCELLANEOUS			
—	E23-0047-04	Wrapping terminal	\times 19
—	F01-0161-04	Heat sink	

CARRIER (X50-1160-00)

Ref. No.	Parts No.	Description	Re- marks
CAPACITOR			
C1	CC45SL1H330J	Ceramic	33pF \pm 5%
C2	CC45SL1H220J	Ceramic	22pF \pm 5%
C3	CC45SL1H330J	Ceramic	33pF \pm 5%
C4	CK45E1H102P	Ceramic	0.001 μ F \pm 100% - 0%
C5.6	CC45SL1H221J	Ceramic	220pF \pm 5%
C7	CC45SL1H050D	Ceramic	5pF \pm 0.5pF
C8	CC45SL1H330J	Ceramic	33pF \pm 5%
C9	CK45F1H403Z	Ceramic	0.04 μ F \pm 80% - 20%
C10	CK45F1H103Z	Ceramic	0.01 μ F \pm 80% - 20%
C11	CK45F1H403Z	Ceramic	0.04 μ F \pm 80% - 20%
C12	CK45E1H102P	Ceramic	0.001 μ F \pm 100% - 0%
RESISTOR			
R1 ~ 3	PD14CY2E473J	Carbon	47k Ω \pm 5% 1/4W
R4	PD14CY2E182J	Carbon	1.8k Ω \pm 5% 1/4W
R5	PD14CY2E393J	Carbon	39k Ω \pm 5% 1/4W
R6	PD14CY2E103J	Carbon	10k Ω \pm 5% 1/4W
R7	PD14CY2E102J	Carbon	1k Ω \pm 5% 1/4W
R8	PD14CY2E473J	Carbon	47k Ω \pm 5% 1/4W
R9	PD14CY2E101J	Carbon	100 Ω \pm 5% 1/4W
R10	PD14CY2E471J	Carbon	470 Ω \pm 5% 1/4W
R11	PD14CY2E224J	Carbon	220k Ω \pm 5% 1/4W
SEMICONDUCTOR			
Q1.2	V03-0079-05	Transistor	2SC460 (B)
Q3	V03-0123-05	Transistor	2SC733 (Y)
D1 ~ 7	V11-0076-05	Diode	1S1555
COIL/TRANSFORMER			
L1 ~ 6	L40-1021-03	Ferri-inductor	
T1	L30-0265-05	IFT	10.7 MHz

PARTS LIST

Ref. No.	Parts No.	Description	Re- marks
TRIMMER			
TC1.2	C05-0013-15	20pF	
TC3	C05-0015-15	40pF	
QUARTZ CRYSTAL			
X1	L77-0355-05	10.6985 MHz	
X2	L77-0356-05	10.7015 MHz	
MISCELLANEOUS			
—	E23-0047-04	Wrapping terminal × 10	

HET (X50-1300-20) 700A

Ref. No.	Parts No.	Description	Re- marks
CAPACITOR			
C1 ~ 6	CK45D1H102M	Ceramic 0.001μF ±20%	
C7 ~ 17	CC45SL1H330J	Ceramic 33pF ±5%	
C18	CK45D1H102M	Ceramic 0.001μF ±20%	
C19	CC45SL1H070D	Ceramic 7pF ±0.5pF	
C20.21	CK45D1H102M	Ceramic 0.001μF ±20%	
C22	CC45SL1H330J	Ceramic 33pF ±5%	
C23	CC45SL1H470J	Ceramic 47pF ±5%	
C24	CK45D1H102M	Ceramic 0.001μF ±20%	
C25	CC45PH1H030D	Ceramic 3pF ±0.5pF	
C26	CC45SL1H0R5C	Ceramic 0.5pF ±0.25pF	
C27	CC45PH1H030D	Ceramic 3pF ±0.5pF	
C28.29	CC45SL1H101J	Ceramic 100pF ±5%	
C30	CK45D1H102M	Ceramic 0.001μF ±20%	
C31	CC45SL1H150J	Ceramic 15pF ±5%	
C32.33	CC45SL1H101J	Ceramic 100pF ±5%	
C34 ~ 38	CK45D1H102M	Ceramic 0.001μF ±20%	
C39	CC45PH1H100D	Ceramic 10pF ±0.5pF	
C40	CC45CH1H070D	Ceramic 7pF ±0.5pF	
C41.42	CK45D1H102M	Ceramic 0.001μF ±20%	
C43	CC45SH1H050D	Ceramic 5pF ±0.5pF	
C44	CC45CH1H150J	Ceramic 15pF ±5%	
C45	CK45D1H102M	Ceramic 0.001μF ±20%	
C46	CC45SL1H101J	Ceramic 100pF ±5%	
C47 ~ 51	CK45D1H102M	Ceramic 0.001μF ±20%	
C52	CE04W1C220(RL)	Electrolytic 22μF 16WV	
C53	CK45D1H102M	Ceramic 0.001μF ±20%	
C54	CC45SL1H221J	Ceramic 220pF ±5%	
C55	CK45F1H103Z	Ceramic 0.01μF -80% -20%	
C56	CC45SL1H221J	Ceramic 220pF ±5%	
C57	CK45F1H103Z	Ceramic 0.01μF -80% -20%	
C58	CC45SL1H390J	Ceramic 39pF ±5%	
C59	CK45F1H103Z	Ceramic 0.01μF -80% -20%	
C60	CK45D1H102M	Ceramic 0.001μF ±20%	
C61.62	CK45F1H103Z	Ceramic 0.01μF -80% -20%	
C63	CC45SL1H470J	Ceramic 47pF ±5%	
C64	CC45SL1H101J	Ceramic 100pF ±5%	
C65	CC45SL1H470J	Ceramic 47pF ±5%	
C66	CK45F1H103Z	Ceramic 0.01μF -80% -20%	
C67	CC45SL1H100D	Ceramic 10pF ±0.5pF	
C68	CK45D1H102M	Ceramic 0.001μF ±20%	
C69.70	CK45F1H103Z	Ceramic 0.01μF -80% -20%	
C71.72	CK45D1H102M	Ceramic 0.001μF ±20%	
C73	CK45F1H103Z	Ceramic 0.01μF -80% -20%	
RESISTOR			
R1 ~ 6	PD14CY2E102J	Carbon 1k! ±5% 1/4W	
R7 ~ 17	PD14CY2E473J	Carbon 47k! ±5% 1/4W	
R18 ~ 28	PD14CY2E182J	Carbon 1.8k! ±5% 1/4W	
R29	PD14CY2E393J	Carbon 39k! ±5% 1/4W	
R30	PD14CY2E473J	Carbon 47k! ±5% 1/4W	
R31	PD14CY2E623J	Carbon 62k! ±5% 1/4W	

Ref. No.	Parts No.	Description	Re- marks
R32	PD14CY2E823J	Carbon 82k! ±5% 1/4W	
R33	PD14CY2E563J	Carbon 56k! ±5% 1/4W	
R34	PD14CY2E104J	Carbon 100k! ±5% 1/4W	
R35	PD14CY2E152J	Carbon 1.5k! ±5% 1/4W	
R36.37	PD14CY2E473J	Carbon 47k! ±5% 1/4W	
R38	PD14CY2E103J	Carbon 10k! ±5% 1/4W	
R39	PD14CY2E472J	Carbon 4.7k! ±5% 1/4W	
R40	PD14CY2E103J	Carbon 10k! ±5% 1/4W	
R41	PD14CY2E471J	Carbon 470! ±5% 1/4W	
R42	PD14CY2E101J	Carbon 100! ±5% 1/4W	
R43.44	PD14CY2E474J	Carbon 470k! ±5% 1/4W	
R45	PD14CY2E154J	Carbon 150k! ±5% 1/4W	
R46	PD14CY2E102J	Carbon 1k! ±5% 1/4W	
R47	PD14CY2E101J	Carbon 100! ±5% 1/4W	
R48 ~ 50	PD14CY2E102J	Carbon 1k! ±5% 1/4W	
R51.52	PD14CY2E474J	Carbon 470k! ±5% 1/4W	
R53	PD14CY2E330J	Carbon 33! ±5% 1/4W	
R54	PD14CY2E473J	Carbon 47k! ±5% 1/4W	
R55	PD14CY2E563J	Carbon 56k! ±5% 1/4W	
R56	PD14CY2E101J	Carbon 100! ±5% 1/4W	
R57	PD14CY2E102J	Carbon 1k! ±5% 1/4W	
R58	PD14CY2E472J	Carbon 4.7k! ±5% 1/4W	
R59	PD14CY2E102J	Carbon 1k! ±5% 1/4W	
R60	PD14CY2E223J	Carbon 22k! ±5% 1/4W	
R61	PD14CY2E102J	Carbon 1k! ±5% 1/4W	
R62	PD14CY2E472J	Carbon 4.7k! ±5% 1/4W	
R63	PD14CY2E102J	Carbon 1k! ±5% 1/4W	
R64	PD14CY2E223J	Carbon 22k! ±5% 1/4W	
R65	PD14CY2E104J	Carbon 100k! ±5% 1/4W	
R66	PD14CY2E101J	Carbon 100! ±5% 1/4W	
R67	PD14CY2E471J	Carbon 470! ±5% 1/4W	
R68	PD14CY2E101J	Carbon 100! ±5% 1/4W	
R69	PD14CY2E474J	Carbon 470k! ±5% 1/4W	
R70	PD14CY2E102J	Carbon 1k! ±5% 1/4W	
R71	PD14CY2E101J	Carbon 100! ±5% 1/4W	
R72	PD14CY2E332J	Carbon 3.3k! ±5% 1/4W	
R73	PD14CY2E102J	Carbon 1k! ±5% 1/4W	
R74	PD14CY2E103J	Carbon 10k! ±5% 1/4W	
R75.76	PD14CY2E100J	Carbon 100! ±5% 1/4W	
SEMICONDUCTOR			
Q1	V03-0053-05	Transistor 2SC388A	
Q2	V03-0079-05	Transistor 2SC460 (B)	
Q3	V30-0153-05	IC SN76514N	
Q4	V09-0057-05	FET 3SK41 (L)	
Q5 ~ 7	V03-0094-05	Transistor 2SC458 (B)	
Q8	V03-0079-05	Transistor 2SC460 (B)	
Q9	V03-0123-05	Transistor 2SC733 (Y)	
Q10	V03-0241-05	Transistor 2SC735 (Y)	
D1 ~ 23	V11-0076-05	Diode 1S1555	
D24 ~ 28	V11-9898-05	Diode 1S2208	
D29.30	V11-0076-05	Diode 1S1555	
D31 ~ 33	V11-0051-05	Diode 1N60	
POTENTIOMETER			
VR1	R12-2014-05	5k! (B)	
COIL/TRANSFORMER			
L1 ~ 7	L34-0437-05	Oscillating coil	
L8	L40-1021-03	Ferri-inductor	
L9	L40-1091-03	Ferri-inductor	
L10	L40-1021-03	Ferri-inductor	
L11	L40-6891-02	Ferri-inductor	
L12	L40-1021-03	Ferri-inductor	
L13.14	L40-4791-02	Ferri-inductor	
L15	L40-1091-03	Ferri-inductor	
T1 ~ 3	L31-0180-05	IFT	

PARTS LIST

Ref No	Parts No	Description	Re- marks
T4	L34-0517-05	Tuning coil	
T5	L31-0516-05	IFT	
TRIMMER			
TC1 ~ 12	C05-0030-15	20pF	
MISCELLANEOUS			
---	E18-0601-05	Socket (crystal) 6P	
---	E18-2401-05	Socket (crystal) 12P	
---	E19-0610-05	Connector (minicon wafer) 6A	
---	E19-1203-05	Connector (minicon wafer) 12A	
---	E23-0047-04	Wrapping terminal x 14	
---	F10-0384-04	Shield plate	

HET (X50-1170-61) 700G

Ref No	Parts No.	Description	Re- marks
CAPACITOR			
C1 ~ 3	CK45B1H102K	Ceramic 0.001 μ F \pm 10%	
C4	CC45SL1H070D	Ceramic 7pF \pm 0.5pF	
C5	CK45B1H102K	Ceramic 0.001 μ F \pm 10%	
C6	CC45SL1H680J	Ceramic 68pF \pm 5%	
C7	CC45SL1H330J	Ceramic 33pF \pm 5%	
C8	CK45B1H102K	Ceramic 0.001 μ F \pm 10%	
C9	CC45SL1H101J	Ceramic 100pF \pm 5%	
C10	CC45SL1H120J	Ceramic 12pF \pm 5%	
C11.12	CK45B1H102K	Ceramic 0.001 μ F \pm 10%	
C13	CC45SL1H100D	Ceramic 10pF \pm 0.5%	
Cq4.15	CC45SL1H220J	Ceramic 22pF \pm 5%	
C16 ~ 26	CC45SL1H330J	Ceramic 33pF \pm 5%	
C27	CK45B1H102K	Ceramic 0.001 μ F \pm 10%	
C28.29	CC45SL1H221J	Ceramic 220pF \pm 5%	
C30	CK45F1H103Z	Ceramic 0.01 μ F \pm 80% - 20%	
C32	CK45F1H103Z	Ceramic 0.01 μ F \pm 80% - 20%	
C33	CC45SL1H390J	Ceramic 39pF \pm 5%	
C34	CC45SL1H560J	Ceramic 56pF \pm 5%	
C36	CK45F1H403Z	Ceramic 0.04 μ F \pm 80% - 20%	
C37.38	CC45SL1H101J	Ceramic 100pF \pm 5%	
C39 ~ 42	CK45F1H103Z	Ceramic 0.01 μ F \pm 80% - 20%	
C44	C90-0231-05	Ceramic 0.5pF	
C45	CK45B1H102K	Ceramic 0.001 μ F \pm 10%	
C46	CK45F1H103Z	Ceramic 0.01 μ F \pm 80% - 20%	
C47	CK45F1H403Z	Ceramic 0.04 μ F \pm 80% - 20%	
C48.49	CK45F1H103Z	Ceramic 0.01 μ F \pm 80% - 20%	
C50	CC45SL1H150J	Ceramic 15pF \pm 5%	
C51.52	CK45F1H103Z	Ceramic 0.01 μ F \pm 80% - 20%	
C55.56	CK45F1H103Z	Ceramic 0.01 μ F \pm 80% - 20%	
C58	CC45RH1H100D	Ceramic 10pF \pm 0.5%	
C60	CC45RH1H120J	Ceramic 12pF \pm 5%	
C61	CC45SL1H070D	Ceramic 7pF \pm 0.5pF	
C62	CC45RH1H180J	Ceramic 18pF \pm 5%	
C64.65	CK45F1H103Z	Ceramic 0.01 μ F \pm 80% - 20%	
C66	CC45SL1H220J	Ceramic 22pF \pm 5%	
C67	CC45SL1H680J	Ceramic 68pF \pm 5%	
C68	CC45RH1H180J	Ceramic 18pF \pm 5%	
C69	CE04W1C470(RL)	Electrolytic 47 μ F 16WV	
C70	CC45SL1H120J	Ceramic 12pF \pm 5%	
C101	CK45B1H102K	Ceramic 0.001 μ F \pm 10%	
RESISTOR			
R1.2	PD14CY2E102J	Carbon 1k Ω \pm 5% 1/4W	
R3.4	PD14CY2E473J	Carbon 47k Ω \pm 5% 1/4W	
R5.6	PD14CY2E103J	Carbon 10k Ω \pm 5% 1/4W	
R7 ~ 9	PD14CY2E102J	Carbon 1k Ω \pm 5% 1/4W	
R10	PD14CY2E471J	Carbon 470 Ω \pm 5% 1/4W	
R11	PD14CY2E102J	Carbon 1k Ω \pm 5% 1/4W	

Ref No	Parts No	Description	Re- marks
R12	PD14CY2E101J	Carbon 100 Ω \pm 5% 1/4W	
R13	PD14CY2E103J	Carbon 10k Ω \pm 5% 1/4W	
R14	PD14CY2E102J	Carbon 1k Ω \pm 5% 1/4W	
R15.16	PD14CY2E101J	Carbon 100 Ω \pm 5% 1/4W	
R17 ~ 27	PD14CY2E182J	Carbon 1.8k Ω \pm 5% 1/4W	
R28 ~ 38	PD14CY2E473J	Carbon 47k Ω \pm 5% 1/4W	
R39	PD14CY2E472J	Carbon 4.7k Ω \pm 5% 1/4W	
R40	PD14CY2E223J	Carbon 22k Ω \pm 5% 1/4W	
R41.42	PD14CY2E102J	Carbon 1k Ω \pm 5% 1/4W	
R43	PD14CY2E472J	Carbon 4.7k Ω \pm 5% 1/4W	
R44	PD14CY2E223J	Carbon 22k Ω \pm 5% 1/4W	
R45	PD14CY2E102J	Carbon 1k Ω \pm 5% 1/4W	
R46	PD14CY2E823J	Carbon 82k Ω \pm 5% 1/4W	
R47	PD14CY2E101J	Carbon 100 Ω \pm 5% 1/4W	
R48.49	PD14CY2E102J	Carbon 1k Ω \pm 5% 1/4W	
R50	PD14CY2E681J	Carbon 680 Ω \pm 5% 1/4W	
R51	PD14CY2E102J	Carbon 1k Ω \pm 5% 1/4W	
R52	PD14CY2E332J	Carbon 3.3k Ω \pm 5% 1/4W	
R53	PD14CY2E221J	Carbon 220 Ω \pm 5% 1/4W	
R54	PD14CY2E101J	Carbon 100 Ω \pm 5% 1/4W	
R55	PD14CY2E471J	Carbon 470 Ω \pm 5% 1/4W	
R56	PD14CY2E474J	Carbon 470k Ω \pm 5% 1/4W	
R57	PD14CY2E102J	Carbon 1k Ω \pm 5% 1/4W	
R59	PD14CY2E103J	Carbon 10k Ω \pm 5% 1/4W	
R60	PD14CY2E100J	Carbon 10 Ω \pm 5% 1/4W	
R101	PD14CY2E102J	Carbon 1k Ω \pm 5% 1/4W	
SEMICONDUCTOR			
Q1.2	V03-0053-05	Transistor 2SC388A	
Q3 ~ 5	V03-0079-05	Transistor 2SC460B	
Q6.7	V09-0012-05	FET 2SK19 (GR)	
Q8	V03-0053-05	Transistor 2SC388A	
Q9	V03-0079-05	Transistor 2SC460B	
Q10	V03-0123-05	Transistor 2SC733 (Y)	
Q11	V03-0241-05	Transistor 2SC735 (Y)	
D1.2	V11-0370-05	Diode 1S1587	
D3	V11-9898-05	Diode 1S2208	
D4 ~ 14	V11-0076-05	Diode 1S1555	
D15.16	V11-0051-05	Diode 1N60	
D17.18	V11-0076-05	Diode 1S1555	
D101	V11-0370-05	Diode 1S1587	
POTENTIOMETER			
VR1	R12-2015-05	5k Ω (B)	
VR2	R12-0042-05	500 Ω (B)	
COIL/TRANSFORMER			
L1	L40-1021-03	Ferri-inductor	
L2.3	L34-0437-05	Oscillating coil 125.126 MHz	
L4	L34-0438-05	Coil 0.9 μ H	
L5	L40-1021-03	Ferri-inductor	
L6	L40-6891-02	Ferri-inductor	
L7	L40-1021-03	Ferri-inductor	
L8	L40-1091-03	Ferri-inductor	
L9	L40-1001-03	Ferri-inductor	
L101	L34-0437-05	Oscillating coil 125.126 MHz	
T1.2	L31-0180-05	IFT 144 MHz	
T3	L30-0268-05	IFT 8.7 MHz	
T4	L31-0321-05	Oscillating coil 144 MHz	
T5	L31-0322-05	Oscillating coil 144 MHz	
T7	L31-0180-05	IFT 144 MHz	
T9	L31-0180-05	IFT 144 MHz	
TRIMMER			
TC1 ~ 11	C05-0013-15	20pF	
TC12	C05-0030-15	20pF	

PARTS LIST

Ref. No.	Parts No.	Description	Re- marks
QUARTZ CRYSTAL			
X1	L77-0358-05	Quartz crystal 125.109-1/3 MHz	
X2	L77-0359-05	Quartz crystal 126.109-1/3 MHz	
X101	L77-0363-05	Quartz crystal 125.509-1/3 MHz	
MISCELLANEOUS			
—	E18-2401-05	Socket (crystal)	
—	E23-0047-04	Wrapping terminal × 34	

MARKER (X50-1280-00)

Ref. No.	Parts No.	Description	Re- marks
CAPACITOR			
C1	CC45CH1H560J	Ceramic 56pF ±5%	
C2	CC45SL1H391J	Ceramic 390pF ±5%	
C3	CC45CH1H470J	Ceramic 47pF ±5%	
C4	CK45F1H103Z	Ceramic 0.01μF +80% - 20%	
C5	CC45CH1H150J	Ceramic 15pF ±5%	
C6	CC45SL1H220J	Ceramic 22pF ±5%	
C7	CE04W1C330(RL)	Ceramic 33pF 16WV	
C8	CC45SL1H020D	Ceramic 2pF ±0.5pF	
C9,10	CK45F1H103Z	Ceramic 0.01μF +80% - 20%	
RESISTOR			
R1	PD14CY2E102J	Carbon 1kΩ ±5% 1/4W	
R2	PD14CY2E103J	Carbon 10kΩ ±5% 1/4W	
R3	PD14CY2E822J	Carbon 8.2kΩ ±5% 1/4W	
R4	PD14CY2E222J	Carbon 2.2kΩ ±5% 1/4W	
R5	PD14CY2E104J	Carbon 100kΩ ±5% 1/4W	
R6	PD14CY2E472J	Carbon 4.7kΩ ±5% 1/4W	
R7	PD14CY2E152J	Carbon 1.5kΩ ±5% 1/4W	
R8	RC05GF2H560J	Carbon 56Ω ±5% 1/W	
R9	PD14CY2E103J	Carbon 10kΩ ±5% 1/4W	
SEMICONDUCTOR			
Q1	V01-0032-05	Transistor 2SA562 (Y)	
Q2	V03-0094-05	Transistor 2SC458 (B)	
Q3	V01-0037-05	Transistor 2SA495 (Y)	
Q4.5	V30-0151-05	IC TD3490BP	
D1.2	V11-0076-05	Diode 1S1555	
D3	V11-0418-05	Zener diode BZ-052	
TRIMMER			
TC1	C05-0015-15	Trimmer	
QUARTZ CRYSTAL			
X1	L77-0482-05	Quartz crystal 10 MHz	
MISCELLANEOUS			
—	E23-0047-04	Wrapping terminal × 6	

BPF (X51-1090-00, -21)

Ref. No.	Parts No.	Description	Re- marks
CAPACITOR			
C1	CE04W1H4R7	Electrolytic 4.7μF 50WV	700A
C2	CC45CH2H030C	Ceramic 3pF ±0.25pF	700G
	CC45CH2H020C	Ceramic 2pF ±0.25pF	
SEMICONDUCTOR			
D1	V11-0278-05	Diode SD82A	

Ref. No.	Parts No.	Description	Re- marks
COIL			
L1	L40-1001-03	Ferri-inductor	
L2	L34-0440-05	Coil (B)	700G
	L34-0562-05	Coil (B)	700A
L3	L34-0441-05	Coil (C)	
VARIABLE CAPACITOR			
VC1	C03-0061-05	Variable capacitor (small)	
MISCELLANEOUS			
J5	E04-0109-15	M type receptacle	
—	F07-0323-14	BPF Shield cover (A)	
—	F07-0324-24	BPF Shield cover (B)	
—	F11-0193-13	BPF Shield case	

GENERATOR (X52-1080-21)

Ref. No.	Parts No.	Description	Re- marks
CAPACITOR			
C1	CC45SL1H101J	Ceramic 100pf ±5%	
C2,3	CQ92M1H223K	Mylar 0.022μF ±10%	
C4	CE04W1A470(RL)	Electrolytic 47μF 10WV	
C5	CE04W1H010(RL)	Electrolytic 1μF 50WV	
C6	CQ92M1H103K	Mylar 0.01μF ±10%	
C7	CE04W1C100(RL)	Electrolytic 10μF 16WV	
C8	CQ92M1H223K	Mylar 0.022μF ±10%	
C9	CE04W1A470(RL)	Electrolytic 47μF 10WV	
C10	CQ92M1H102K	Mylar 0.001μF ±10%	
C11	CE04W1H010(RL)	Electrolytic 1μF 50WV	
C12,13	CE04W1C100(RL)	Electrolytic 10μF 16WV	
C14	C90-0076-05	Tantulum 0.1μF 25WV	
C15	CE04W1A470(RL)	Electrolytic 47μF 10WV	
C16	CK45F1H103Z	Ceramic 0.01μF +80% - 20%	
C17,18	CE04W1A470(RL)	Electrolytic 47μF 10WV	
C19,20	CE04W1H010(RL)	Electrolytic 1μF 50WV	
C21	CQ92M1H103K	Mylar 0.01μF ±10%	
C22	CQ92M1H473K	Mylar 0.047μF ±10%	
C23	CE04W1H010(RL)	Electrolytic 1μF 50WV	
C24	CC45CH1H330J	Ceramic 33pF ±5%	
C25	CC45UJ1H050D	Ceramic 5pF ±0.5pF	
C26	CC45SL1H221J	Ceramic 220pF ±5%	
C27	CK45F1H103Z	Ceramic 0.01μF +80% - 20%	
C28	CC45SL1H221J	Ceramic 220pF ±5%	
C29	CK45F1H103Z	Ceramic 0.01μF +80% - 20%	
C30	CC45SL1H050D	Ceramic 5pF ±0.5pF	
C31~36	CK45F1H103Z	Ceramic 0.01μF +80% - 20%	
C37,38	CE04W1H4R7(RL)	Electrolytic 4.7μF 50WV	
C39	CK45D1H102M	Ceramic 0.001μF ±20%	
C40	C91-0013-05	Ceramic 0.01μF ±10%	
C41	CC45SL1H150J	Ceramic 15pF ±5%	
C42	CC45SL1H100D	Ceramic 10pF ±0.5pF	
C43~45	CK45D1H102M	Ceramic 0.001μF ±20%	
C46,47	CK45F1H403Z	Ceramic 0.04μF +80% - 20%	
C48	CC45SL1H020C	Ceramic 2pF ±0.25pF	
C49	CK45D1H102M	Ceramic 0.001μF ±20%	
C50,51	CK45F1H403Z	Ceramic 0.04μF +80% - 20%	
C52	CK45F1H103Z	Ceramic 0.01μF +80% - 20%	
C53	CC45SL1H220J	Ceramic 22pF ±5%	
C54	CK45F1H103Z	Ceramic 0.01μF +80% - 20%	
C55	CE04W1H010(RL)	Electrolytic 1μF 50WV	
C56	CC45SL1H270J	Ceramic 27pF ±5%	
C57,58	CK45D1H102M	Ceramic 0.001μF ±20%	
C59	CC45SL1H220J	Ceramic 22pF ±5%	
C62~64	CK45F1H103Z	Ceramic 0.01μF +80% - 20%	
C65	CK45D1H102M	Ceramic 0.001μF ±20%	

PARTS LIST

Ref No	Parts No.	Description	Re- marks
C66	CK45F1H103Z	Ceramic 0.01μF ±80% -20%	
C67	CE04W1E330(RL)	Electrolytic 33μF 25WV	
C68	CK45F1H403Z	Ceramic 0.04μF ±80% -20%	
C69	CE04W1H4R7(RL)	Electrolytic 4.7μF 50WV	
C70.71	CK45F1H103Z	Ceramic 0.01μF ±80% -20%	
C72	CE04W1C100(RL)	Electrolytic 10μF 16WV	
C73	CC45SL1H270J	Ceramic 27pF ±5%	
C74	CC45SL1H101J	Ceramic 100pF ±5%	
C75	CK45D1H102M	Ceramic 0.001μF ±20%	
C76	CQ92M1H104K	Mylar 0.1μF ±10%	
C77	C91-0013-05	Ceramic 0.01μF 50WV	
C79	CQ92M1H473K	Mylar 0.047μF ±10%	
C80	CK45F1H403Z	Ceramic 0.04μF ±80% -20%	
C81	CC45SL1H470J	Ceramic 47pF ±5%	
C82	CK45F1H403Z	Ceramic 0.04μF ±80% -20%	
C83	C91-0013-05	Ceramic 0.01μF 50WV	
C84	CC45SL1H070D	Ceramic 7pF ±0.5pF	
C85.86	CK45F1H403Z	Ceramic 0.04μF ±80% -20%	
C87	CE04W1C101(RL)	Electrolytic 100μF 16WV	
C88.89	CC45SL1H100D	Ceramic 10pF ±0.5pF	
C90	CQ92M1H102K	Mylar 0.001μF ±10%	
C91	CK45D1H102M	Ceramic 0.001μF ±20%	
C92	CK45F1H403Z	Ceramic 0.04μF ±80% -20%	
C93	CE04W1H010(RL)	Electrolytic 1μF 50WV	
C94	CK45D1H102M	Ceramic 0.001μF ±20%	
C95	CE04W1H010(RL)	Electrolytic 1μF 50WV	
C96	CE04W1H4R7(RL)	Electrolytic 4.7μF 50WV	
C97	CE04W1H010(RL)	Electrolytic 1μF 50WV	
C98	CK45F1H403Z	Ceramic 0.04μF ±80% -20%	
C99	CC45SL1H470J	Ceramic 47pF ±5%	
C100	CC45SL1H221J	Ceramic 220pF ±5%	
C101	CE04W1H3R3(RL)	Electrolytic 3.3μF 50WV	
C102	CK45F1H403Z	Ceramic 0.04μF ±80% -20%	
C103	CE04W1H010M(BR)	Electrolytic 1μF 50WV	
C104	CK45F1H103Z	Ceramic 0.01μF ±80% -20%	
C105	CE04W1H010(RL)	Electrolytic 1μF 50WV	
C106	C91-0013-05	Ceramic 0.01μF	
C107	CK45F1H403Z	Ceramic 0.04μF ±80% -20%	
C108	CK45F1H223Z	Ceramic 0.022μF ±80% -20%	
RESISTOR			
R1	PD14CY2E681J	Carbon 680Ω ±5% 1/4W	
R2	PD14CY2E471J	Carbon 470Ω ±5% 1/4W	
R3	PD14CY2E103J	Carbon 10kΩ ±5% 1/4W	
R4	PD14CY2E104J	Carbon 100kΩ ±5% 1/4W	
R5	PD14CY2E223J	Carbon 22kΩ ±5% 1/4W	
R6	PD14CY2E562J	Carbon 5.6kΩ ±5% 1/4W	
R7	PD14CY2E102J	Carbon 1kΩ ±5% 1/4W	
R8	PD14CY2E101J	Carbon 100Ω ±5% 1/4W	
R9	PD14CY2E331J	Carbon 330Ω ±5% 1/4W	
R10	PD14CY2E102J	Carbon 1kΩ ±5% 1/4W	
R11	PD14CY2E223J	Carbon 22kΩ ±5% 1/4W	
R12	PD14CY2E331J	Carbon 330Ω ±5% 1/4W	
R13	PD14CY2E272J	Carbon 2.7kΩ ±5% 1/4W	
R14	PD14CY2E154J	Carbon 150kΩ ±5% 1/4W	
R15	PD14CY2E102J	Carbon 1kΩ ±5% 1/4W	
R16	PD14CY2E221J	Carbon 220Ω ±5% 1/4W	
R17	PD14CY2E472J	Carbon 4.7kΩ ±5% 1/4W	
R18	PD14CY2E561J	Carbon 560Ω ±5% 1/4W	
R19	PD14CY2E102J	Carbon 1kΩ ±5% 1/4W	
R20	PD14CY2E221J	Carbon 220Ω ±5% 1/4W	
R21	PD14CY2E333J	Carbon 33kΩ ±5% 1/4W	
R22	PD14CY2E223J	Carbon 22kΩ ±5% 1/4W	
R23	PD14CY2E473J	Carbon 47kΩ ±5% 1/4W	
R24	PD14CY2E223J	Carbon 22kΩ ±5% 1/4W	
R25.26	PD14CY2E102J	Carbon 1kΩ ±5% 1/4W	
R27~29	PD14CY2E473J	Carbon 47kΩ ±5% 1/4W	
R30	PD14CY2E471J	Carbon 470Ω ±5% 1/4W	

Ref No	Parts No	Description	Re- marks
R31	PD14CY2E101J	Carbon 100Ω ±5% 1/4W	
R32	PD14CY2E102J	Carbon 1kΩ ±5% 1/4W	
R33	PD14CY2E682J	Carbon 6.8kΩ ±5% 1/4W	
R34~36	PD14CY2E103J	Carbon 10kΩ ±5% 1/4W	
R37	PD14CY2E333J	Carbon 33kΩ ±5% 1/4W	
R38	PD14CY2E103J	Carbon 10kΩ ±5% 1/4W	
R39~41	PD14CY2E101J	Carbon 100Ω ±5% 1/4W	
R42	PD14CY2E473J	Carbon 47kΩ ±5% 1/4W	
R44	PD14CY2E471J	Carbon 470Ω ±5% 1/4W	
R45	PD14CY2E333J	Carbon 33kΩ ±5% 1/4W	
R46	PD14CY2E102J	Carbon 1kΩ ±5% 1/4W	
R47	PD14CY2E683J	Carbon 68kΩ ±5% 1/4W	
R48	PD14CY2E472J	Carbon 4.7kΩ ±5% 1/4W	
R49	PD14CY2E182J	Carbon 1.8kΩ ±5% 1/4W	
R50	PD14CY2E103J	Carbon 10kΩ ±5% 1/4W	
R56	PD14CY2E152J	Carbon 1.5kΩ ±5% 1/4W	
R57	PD14CY2E473J	Carbon 47kΩ ±5% 1/4W	
R58	PD14CY2E154J	Carbon 150kΩ ±5% 1/4W	
R59	PD14CY2E152J	Carbon 1.5kΩ ±5% 1/4W	
R60	PD14CY2E331J	Carbon 330Ω ±5% 1/4W	
R61	PD14CY2E101J	Carbon 100Ω ±5% 1/4W	
R62	PD14CY2E102J	Carbon 1kΩ ±5% 1/4W	
R63	PD14CY2E103J	Carbon 10kΩ ±5% 1/4W	
R64	PD14CY2E391J	Carbon 390Ω ±5% 1/4W	
R65.66	PD14CY2E473J	Carbon 47kΩ ±5% 1/4W	
R67	PD14CY2E472J	Carbon 4.7kΩ ±5% 1/4W	
R68	PD14CY2E221J	Carbon 220Ω ±5% 1/4W	
R69	PD14CY2E101J	Carbon 100Ω ±5% 1/4W	
R70	PD14CY2E103J	Carbon 10kΩ ±5% 1/4W	
R71	PD14CY2E473J	Carbon 47kΩ ±5% 1/4W	
R72	PD14CY2E221J	Carbon 220Ω ±5% 1/4W	
R73	PD14CY2E101J	Carbon 100Ω ±5% 1/4W	
R74	PD14CY2E104J	Carbon 100kΩ ±5% 1/4W	
R75	PD14CY2E222J	Carbon 2.2kΩ ±5% 1/4W	
R76	PD14CY2E102J	Carbon 1kΩ ±5% 1/4W	
R77	PD14CY2E105J	Carbon 1MΩ ±5% 1/4W	
R79	PD14CY2E103J	Carbon 10kΩ ±5% 1/4W	
R80	PD14CY2E104J	Carbon 100kΩ ±5% 1/4W	
R82	PD14CY2E102J	Carbon 1kΩ ±5% 1/4W	
R83	RC05GF2H155J	Carbon 1.5MΩ ±5% 1/2W	
R84	PD14CY2E103J	Carbon 10kΩ ±5% 1/4W	
R85	PD14CY2E123J	Carbon 12kΩ ±5% 1/4W	
R86	PD14CY2E102J	Carbon 1kΩ ±5% 1/4W	
R87	PD14CY2E101J	Carbon 100Ω ±5% 1/4W	
R88	PD14CY2E103J	Carbon 10kΩ ±5% 1/4W	
R89	PD14CY2E104J	Carbon 100kΩ ±5% 1/4W	
SEMICONDUCTOR			
Q1	V03-0299-05	Transistor 2SC1000 (GR)	
Q2.3	V03-0123-05	Transistor 2SC733 (Y)	
Q4	V30-0039-05	IC TA7061AP	
Q5	V03-0079-05	Transistor 2SC460 (B)	
Q6	V09-0036-05	FET 3SK35 (GR), (BL)	
Q7.8	V03-0079-05	Transistor 2SC460 (B)	
Q9	V09-0036-05	FET 3SK35 (GR), (BL)	
Q11	V09-0036-05	FET 3SK35 (GR), (BL)	
Q12.13	V09-0036-05	FET 3SK35 (GR)	
Q14~16	V03-0123-05	Transistor 2SC733 (Y)	
Q17	V09-0003-05	FET 2SK30 (O)	
D1.2	V11-0076-05	Diode 1S1555	
D3~6	V11-0051-05	Diode 1N60	
D7	V11-0076-05	Diode 1S1555	
D8~14	V11-0370-05	Diode 1S1587	
D15	V11-9898-05	Diode 1S2208	
D16~23	V11-0076-05	Diode 1S1555	
D24.25	V11-0051-05	Diode 1N60	
D26	V11-0076-05	Diode 1S1555	

PARTS LIST

Ref. No.	Parts No.	Description	Re- marks
D27 ~ 30	V11-0051-05	Diode 1N60	
D31	V11-0076-05	Diode 1S1555	
D32	V11-0200-05	Diode V06C	
POTENTIOMETER			
VR1	R12-3025-05	10kΩ (B)	
VR3	R12-2015-05	5kΩ (B)	
VR4	R12-1016-05	3kΩ (B)	
VR5	R12-3025-05	10kΩ (B)	
VR6	R12-0054-05	100Ω (B)	
VR7	R12-1020-05	1kΩ (B)	
COIL/TRANSFORMER			
L1	L40-1045-06	Ferri-inductor 100mH	
L2	L33-0264-05	Choke coil 30μH	
L3	L39-0068-05	Variable inductor 10μH	
L4	L33-0265-05	Choke coil 20μH	
L5,6	L40-1021-03	Ferri-inductor 1μH	
L7	L40-1001-03	Ferri-inductor 10μH	
L8	L40-1021-03	Ferri-inductor 1μH	
L9	L40-1011-03	Ferri-inductor 100μH	
L10	L40-6801-03	Ferri-inductor 68μH	
L11	L40-1021-03	Ferri-inductor 1μH	
L12	L40-1011-03	Ferri-inductor 100μH	
L13 ~ 16	L40-1021-03	Ferri-inductor 1μH	
L17	L40-1011-03	Ferri-inductor 100μH	
L18	L40-1021-03	Ferri-inductor 1μH	
L19	L40-1091-03	Ferri-inductor 1μH	
L20	L40-1021-03	Ferri-inductor 1μH	
T1 ~ 6	L30-0264-05	IFT 10.7 MHz	
TRIMMER			
TC1.2	C05-0030-15	Ceramic trimmer 20pF	
QUARTZ CRYSTAL/FILTER			
X1	L77-0484-05	10.730 MHz	
XF	L71-0022-05	Crystal filter 10.7 MHz	
MISCELLANEOUS			
—	E23-0047-04	Wrapping terminal × 48	
—	F10-0330-04	Shield plate	
—	F10-0334-04	Shield plate (B)	

RX • NB (X55-1120-00)

Ref. No.	Parts No.	Description	Re- marks
CAPACITOR			
C1	CC45SL1H020D	Ceramic 2pF ±0.5pF	
C2	CC45SL1H120J	Ceramic 12pF ±5%	
C3	CC45SL1H020D	Ceramic 2pF ±0.5pF	
C4	CC45SL1H330J	Ceramic 33pF ±5%	
C5	CK45D1H102M	Ceramic 0.001μF ±20%	
C6	CK45F1H403Z	Ceramic 0.04μF +80% - 20%	
C7	C91-0013-05	Ceramic 0.01μF	
C8	CK45F1H403Z	Ceramic 0.04μF +80% - 20%	
C9	CK45D1H102M	Ceramic 0.001μF ±20%	
C10	CK45F1H403Z	Ceramic 0.04μF +80% - 20%	
C11	CK45D1H102M	Ceramic 0.001μF ±20%	
C12	CC45SL1H330J	Ceramic 33pF ±5%	
C13	CC45SL1H010D	Ceramic 1pF ±0.5pF	
C14	CC45SL1H330J	Ceramic 33pF ±5%	
C15, 16	CC45SL1H120J	Ceramic 12pF ±5%	
C17	CK45D1H102M	Ceramic 0.001μF ±20%	
C18	CC45SL1H101J	Ceramic 100pF ±5%	
C19	CK45F1H403Z	Ceramic 0.04μF +80% - 20%	

Ref. No.	Parts No.	Description	Re- marks
C20	CK45F1H103Z	Ceramic 0.01μF +80% - 20%	
C21	CC45SL1H101J	Ceramic 100pF ±5%	
C22	CC45SL1H100D	Ceramic 10pF ±0.5pF	
C23 ~ 26	CK45F1H403Z	Ceramic 0.04μF +80% - 20%	
C27, 28	CK45F1H103Z	Ceramic 0.01μF +80% - 20%	
C29	CK45F1H403Z	Ceramic 0.04μF +80% - 20%	
C30	CE04W1C100(RL)	Electrolytic 10μF 16WV	
C31	CC45SL1H030D	Ceramic 3pF ±0.5pF	
C32 ~ 34	CK45F1H103Z	Ceramic 0.01μF +80% - 20%	
C35	CK45F1H403Z	Ceramic 0.04μF +80% - 20%	
C36	CK45F1H103Z	Ceramic 0.01μF +80% - 20%	
C37	CC45SL1H101J	Ceramic 100pF ±5%	
C38	CK45D1H223M	Ceramic 0.022μF ±20%	
C39	C91-0013-05	Ceramic 0.01μF	
C40	CK45F1H103Z	Ceramic 0.01μF	
C41	CE04W1H010(RL)	Electrolytic 1μF 50WV	
C42, 43	CK45F1H103Z	Ceramic 0.01μF +80% - 20%	
C44	CC45SL1H010D	Ceramic 1pF ±0.5pF	
C45	CK45D1H223M	Ceramic 0.022μF ±20%	
C46	CK45F1H103Z	Ceramic 0.01μF +80% - 20%	
C47	CK45D1H102M	Ceramic 0.001μF ±20%	
C48	CC45SL1H331J	Ceramic 330pF ±5%	
C49	CK45D1H223M	Ceramic 0.022μF ±20%	
C50	CK45F1H103Z	Ceramic 0.01μF +80% - 20%	
C51	CC45SL1H220J	Ceramic 22pF ±5%	
C52	CC45SL1H120J	Ceramic 12pF ±5%	
C53	CK45D1H102M	Ceramic 0.001μF ±20%	
RESISTOR			
R1, 2	PD14CY2E474J	Carbon 470kΩ ±5% 1/4W	
R3	PD14CY2E333J	Carbon 33kΩ ±5% 1/4W	
R4	PD14CY2E103J	Carbon 10kΩ ±5% 1/4W	
R5, 6	PD14CY2E474J	Carbon 470kΩ ±5% 1/4W	
R7, 8	PD14CY2E101J	Carbon 100Ω ±5% 1/4W	
R9, 10	PD14CY2E474J	Carbon 470kΩ ±5% 1/4W	
R11, 12	PD14CY2E473J	Carbon 47kΩ ±5% 1/4W	
R13	PD14CY2E102J	Carbon 1kΩ ±5% 1/4W	
R14	PD14CY2E101J	Carbon 100Ω ±5% 1/4W	
R15	PD14CY2E102J	Carbon 1kΩ ±5% 1/4W	
R16	PD14CY2E183J	Carbon 18kΩ ±5% 1/4W	
R17	PD14CY2E474J	Carbon 470kΩ ±5% 1/4W	
R18	PD14CY2E221J	Carbon 220Ω ±5% 1/4W	
R19	PD14CY2E474J	Carbon 470kΩ ±5% 1/4W	
R20	PD14CY2E221J	Carbon 220Ω ±5% 1/4W	
R21	PD14CY2E102J	Carbon 1kΩ ±5% 1/4W	
R22	PD14CY2E472J	Carbon 4.7kΩ ±5% 1/4W	
R23	PD14CY2E474J	Carbon 470kΩ ±5% 1/4W	
R24	PD14CY2E562J	Carbon 5.6kΩ ±5% 1/4W	
R25	PD14CY2E103J	Carbon 10kΩ ±5% 1/4W	
R26	PD14CY2E123J	Carbon 12kΩ ±5% 1/4W	
R27	PD14CY2E104J	Carbon 100kΩ ±5% 1/4W	
R28	PD14CY2E471J	Carbon 470Ω ±5% 1/4W	
R29	PD14CY2E221J	Carbon 220Ω ±5% 1/4W	
R30	PD14CY2E562J	Carbon 5.6kΩ ±5% 1/4W	
R31	PD14CY2E683J	Carbon 68kΩ ±5% 1/4W	
R32	PD14CY2E681J	Carbon 680Ω ±5% 1/4W	
R33	PD14CY2E221J	Carbon 220Ω ±5% 1/4W	
R34	PD14CY2E223J	Carbon 22kΩ ±5% 1/4W	
R35	PD14CY2E221J	Carbon 220Ω ±5% 1/4W	
R36	PD14CY2E103J	Carbon 10kΩ ±5% 1/4W	
R37	PD14CY2E223J	Carbon 22kΩ ±5% 1/4W	
R38	PD14CY2E471J	Carbon 470Ω ±5% 1/4W	
R39, 40	PD14CY2E103J	Carbon 10kΩ ±5% 1/4W	
R41	PD14CY2E471J	Carbon 470Ω ±5% 1/4W	
R42	PD14CY2E103J	Carbon 10kΩ ±5% 1/4W	
R43	PD14CY2E221J	Carbon 220Ω ±5% 1/4W	

PARTS LIST

Ref No	Parts No	Description	Re- marks
SEMICONDUCTOR			
Q1.2	V09-0069-05	FET 3SK41 (M)	
Q3	V09-0036-05	FET 3SK35 (GR)	
Q4	V09-0012-05	FET 2SK19 (GR)	
Q5	V01-0037-05	Transistor 2SA495 (Y). (O)	
Q6	V09-0012-05	FET 2SK19 (GR)	
Q7	V30-0006-05	IC TA7045M (R)	
Q8	V03-0079-05	Transistor 2SC460 (B)	
Q9.10	V03-0123-05	Transistor 2SC733 (Y)	
D1 ~ 4	V11-9898-05	Diode 1S2208	
D5	V11-0374-05	Diode 1S516	
D6.7	V11-0051-05	Diode 1N60	
D8.9	V11-0076-05	Diode 1S1555	
D10 ~ 12	V11-0051-05	Diode 1N60	
POTENTIOMETER			
VR1	R12-3025-05	10kΩ (B)	
VR2	R12-7013-05	500kΩ (B)	
VR3	R12-3025-05	10kΩ (B)	
VR4	R12-0042-05	500Ω (B)	
COIL/TRANSFORMER			
L1	L40-1021-03	Ferri-inductor	
L2	L33-0220-05	Choke coil 2.4μH	
L3 ~ 6	L40-1021-03	Ferri-inductor	
T1	L31-0320-05	Coil (B) 144 MHz	
T2	L31-0324-05	Coil (C) 144 MHz	
T3	L31-0320-05	Coil (B) 144 MHz	
T4	L31-0324-05	Coil (C) 144 MHz	
T5.6	L30-0265-05	IFT 10.7 MHz	
T7 ~ 9	L30-0264-05	IFT 10.7 MHz	
T10 ~ 12	L30-0265-05	IFT 10.7 MHz	
MISCELLANEOUS			
—	E23-0047-04	Wrapping terminal × 26	
—	F11-0113-04	Shield case × 4	

FINAL (X56-1140-01)

Ref. No.	Parts No.	Description	Re- marks
CAPACITOR			
C1	CE04W1A101(RL)	Electrolytic 100μF 10WV	
C2	CC45SL2H330K	Ceramic 33pF ±10%	
C5.6	CM93D2H220J(DM)	Mica 22pF ±5%	
C8	CK45F1H103Z	Ceramic 0.01μF +80% - 20%	
C9	CE04W1H4R7(RL)	Electrolytic 4.7μF 50WV	
C10	CK45F1H103Z	Ceramic 0.01μF +80% - 20%	
C11	CE04W1H4R7(RL)	Electrolytic 4.7μF 50WV	
C15	CK45E2H103P	Ceramic 0.01μF +100% - 0%	
C16	CC45SL2H680J	Ceramic 68pF ±5%	
C17	CC45SL2H390K	Ceramic 39pF ±10%	
C18	CC45SL2H050D	Ceramic 5pF ±0.5pF	
CK1 ~ 5	C90-0194-05	Ceramic 0.001μF	
RESISTOR			
R1	PD14BY2E470J	Carbon 47Ω ±5% 1/4W	
R2	PD14BY2E471J	Carbon 470Ω ±5% 1/4W	
R3	PD14BY2E4R7J	Carbon 4.7Ω ±5% 1/4W	
R4	PD14BY2E220J	Carbon 22Ω ±5% 1/4W	
R5	RC05GF2H101J	Carbon 100Ω ±5% 1/2W	
SEMICONDUCTOR			
Q1	V11-0315-05	Transistor 2N5641	
Q2	V11-0316-05	Transistor 2N5642	

Ref No	Parts No	Description	Re- marks
D1 ~ 3	V11-0076-05	Diode 1S1555	
COIL			
L1	L34-0432-05	VHF coil (A)	
L2	L34-0433-05	VHF coil (B)	
L3	L34-0435-05	VHF coil (D)	
L4	L34-0444-05	VHF coil (E)	
L6	L31-0325-15	Coil	
L7	L33-0219-05	RFC choke coil	
L8	L33-0222-05	Choke coil	
L10 ~ 12	L33-0222-05	Choke coil	
TRIMMER			
TC3	C05-0029-15	50pF	
TC4.5	C05-0054-05	60pF	
TC7	C05-0029-15	50pF	
MISCELLANEOUS			
—	E23-0001-05	Harmetic terminal × 5	
—	F01-0172-24	Heat sink	
—	F01-0173-13	Heat sink (B)	
—	F11-0196-03	Shield case	
—	G02-0056-04	Earth spring × 2	
—	J31-0109-04	Ring spacer × 4	

Downloaded by

Amateur Radio Directory

Note: The parts asterisked (*) are as for the temperature compensation.

PACKING

Fuse (1A)
(F05-1023-05 × 1: 700A. × 2: 700G)

Fuse (2A)
(F05-2023-05 × 2: 700A. × 1: 700G)

Fuse (5A)
(F05-5013-05)

Pin plug × 2
(E14-0101-05)

AC cord
(X42-1080-20: 700A)
(X42-1070-60: 700G)

DC cord
(X42-1050-00)

Microphone
(T91-0029-05: 700G for England)
(T91-0030-05: 700A, 700G for Europe)

Speaker plug
(E12-0001-05)

Foot × 2
(J02-0049-14)

Screw (4 × 12) × 2
(N30-4012-11)

Protection cover
(H20-0378-04)

Polystyrene foamed fixture (B)
(H10-1275-02)

Absorbent fixture
(H10-1276-04)

Polystyrene foamed fixture
(H10-1274-02)

Case (Inside)
(H01-1527-04: 700A)
(H01-1563-04: 700G for England)
(H01-1564-04: 700G for Europe)

Case (Outside)
(H03-0508-04: 700A)
(H03-0523-04: 700G for England)
(H03-0524-04: 700G for Europe)

Scan by Dan

DISASSEMBLY

1. Separating the upper and lower cases

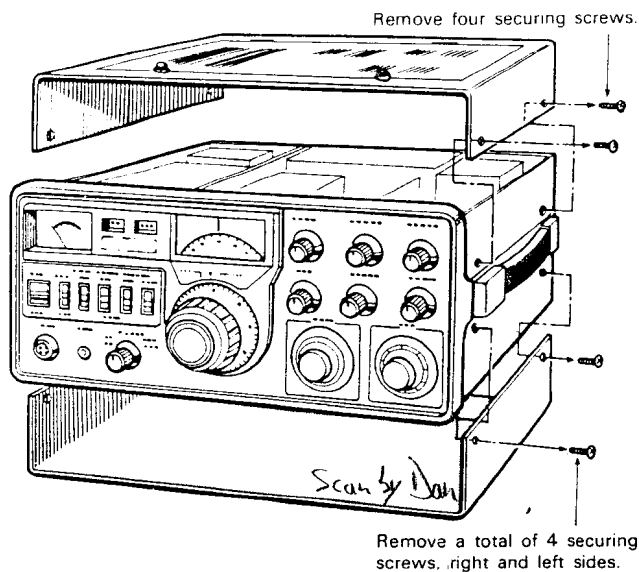
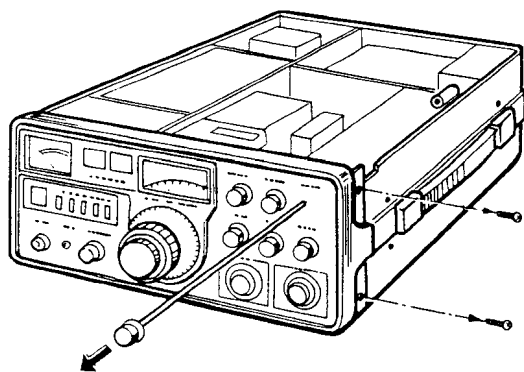

Fig. 1

2. Opening the panel



1. Draw out FINAL shaft. (Do not remove the knob mounted on the coupling showing up on the side of BPF case.)

2. Remove 4 pan-head screws on both sides of the panel. (Remove alternately to preserve symmetry.)

Fig. 2

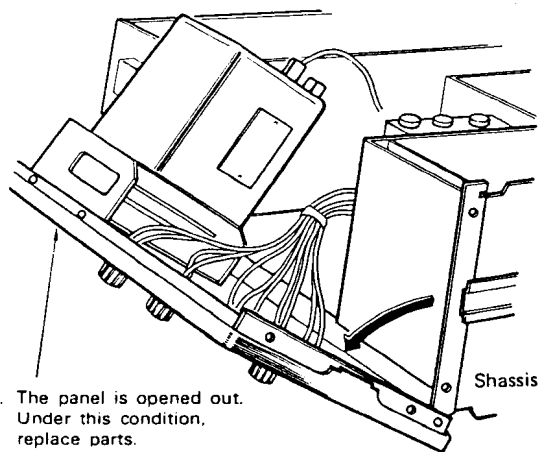

3. The panel is opened out. Under this condition, replace parts.

Fig. 3

3. VFO removal

Procedure

1. Remove the double knob on the panel. At the same time, remove the dial scale, the spring and the knob flange.
2. Remove the 4 screws securing the VFO mounting fixtures on top and bottom of the panel escutcheons.
3. Remove the lamp holder. (The holder may be removed first.)

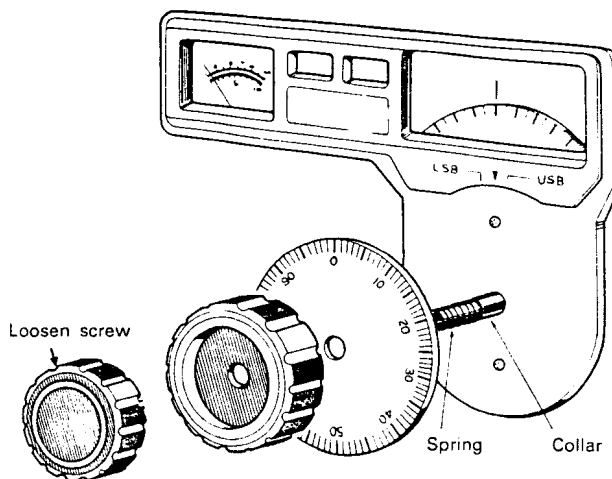

Fig. 4

4. Dial escutcheon replacement

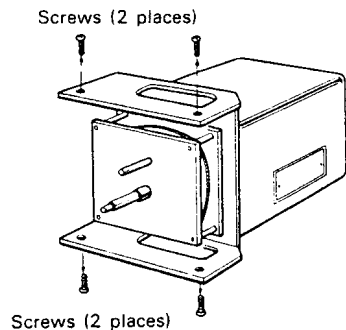

Fig. 5

Remove the double knob and the knob flange on the VFO gear.

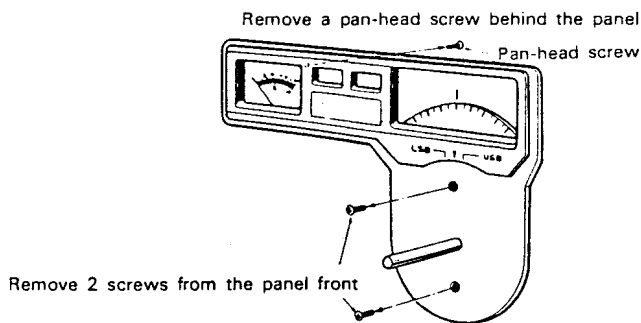
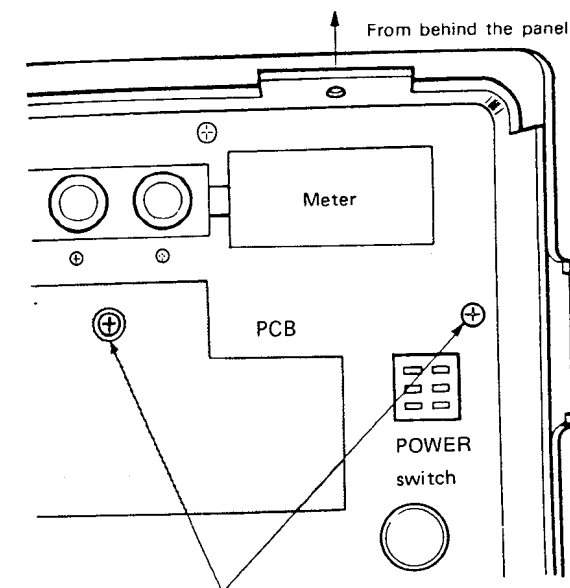

Fig. 6

DISASSEMBLY

5. Replacement of POWER switch and lever switch

- (1) Remove the switch grille.
(Have the meter removed beforehand)



Removing these two screws allows the switch grille to come off.

Fig. 7

(2) Power switch replacement

After removing the switch grille, push the switch out to the front by holding down its mounting fingers.

Lever switch replacement

After removing the switch grille, remove 4 screws securing the switch to the panel.

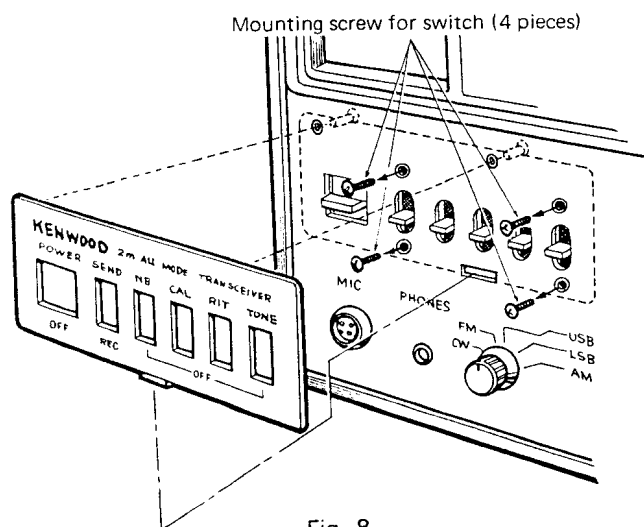

Fig. 8

6. POWER unit removal

Procedure

1. Remove 4 screws securing the top shield cover.
2. Remove 4 hexagonal bosses.
3. Remove one screw securing the side escutcheon (left as viewed from front side). This screw is at the center of the escutcheon.
4. Remove the power source shield case by pulling it upward.

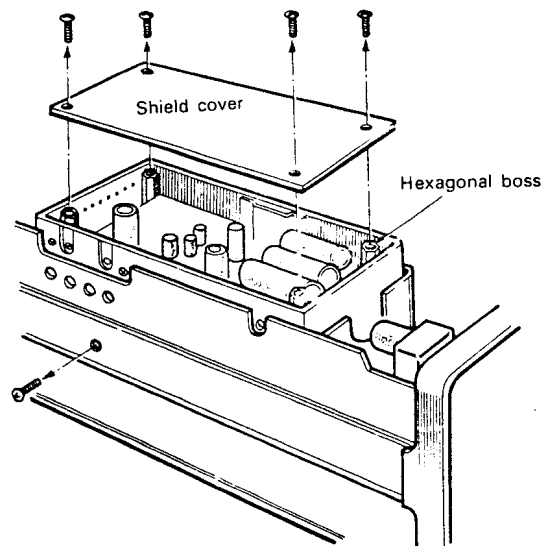

Fig. 9

7. Replacement of the power transformer and the rear terminal parts

Remove the separate part of the rear panel. Removing 2 screws on the rear and 2 on the right side allows this part to come off.

8. FINAL unit replacement

Remove 4 screws securing the final-unit heat sink to the rear panel, and pull out FINAL unit. Parts on the rear panels are to be removed similarly if replacement is required.

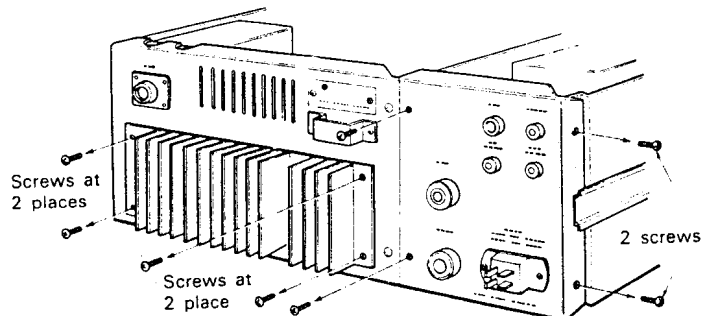

Fig. 10

TROUBLES

Symptom	Condition	Service Point	Possible Cause	Remedy
1. Turning on the power switch has no effect.		1) Fuse 2) Power switch 3) Power supply cord	<input type="radio"/> Blown fuse <input type="radio"/> Defective switch. <input type="radio"/> Broken cord near the plug end.	<input type="radio"/> Replace. Refer to Symptom 2. <input type="radio"/> Check. Repair or replace. <input type="radio"/> Check. Repair or replace.
2. Replacement fuse gets blown off in no time.	Power supply fuse (1A) 20-V circuit (2A)	1) "B" circuit 2) Power supply unit 1) Final unit 2) AF unit	<input type="radio"/> Short circuited to chassis. <input type="radio"/> Defective rectifier. <input type="radio"/> Short circuited AVR <input type="radio"/> Q1 (2N5641) or Q2 (2N5642) is defective. <input type="radio"/> Defective Q5 (2SC1061(A)). <input type="radio"/> Defective Q6 (2SC671(A)).	<input type="radio"/> Check. Repair. <input type="radio"/> Replace. <input type="radio"/> Replace. <input type="radio"/> Replace.
3. No signal reception.	Even noise is not heard. Noise is heard in all modes. Noise is heard on some bands (CW1, SSB, AM). (FM)	1) AF unit 2) Phone jack 3) Speaker connector 1) RX NB unit 2) HET unit 3) IF circuit 4) VFO failure 1) HET unit 2) CARRIER unit 1) FM IF unit	<input type="radio"/> Defective Q5 (2SC1061(A)). <input type="radio"/> Defective Q6 (2SC671(A)). <input type="radio"/> Poor contact in the jack. <input type="radio"/> Poor contact. <input type="radio"/> Mixer failure due to defective Q2 (3SK41). <input type="radio"/> Loss of oscillation. <input type="radio"/> Defective rotary switch. <input type="radio"/> Coil is off adjustment. <input type="radio"/> Q1 (3SK22), Q2 or Q3 (2SC460) is defective. <input type="radio"/> Defective crystal. <input type="radio"/> Defective rotary switch. <input type="radio"/> T1 is mistuned, or Q1 or Q2 (2SC460(B)) is defective. <input type="radio"/> Defective Q3, Q4 or Q5 <input type="radio"/> Defective 10.7 MHz X'tal	<input type="radio"/> Check by disconnecting lead wire from "B" terminal. Replace as necessary. <input type="radio"/> Check and, as necessary, replace. <input type="radio"/> Check for continuity. <input type="radio"/> Repair or replace. <input type="radio"/> Check for continuity. <input type="radio"/> Repair or replace. <input type="radio"/> Check. Replace Q2. <input type="radio"/> Check oscillator voltage. <input type="radio"/> Repair. <input type="radio"/> Replace. <input type="radio"/> Re-adjust or replace. <input type="radio"/> Check output voltage at output and other places. Replace defective transistor. <input type="radio"/> Check oscillator voltage. <input type="radio"/> Replace as necessary. <input type="radio"/> Check and repair or replace. <input type="radio"/> Check output voltage and adjust T1. Check voltage and replace defective transistor. <input type="radio"/> Check, re-adjust or replace. <input type="radio"/> Check. R8 terminal voltage
4. Low sensitivity (poor S/N ratio).	On 2 bands (FM) (SSB, CW, AM)	1) AVR unit 2) RX NB unit 1) FM IF unit 1) GEN unit 2) VFO output too low.	<input type="radio"/> Stabilized voltage too low. <input type="radio"/> Deteriorated Q1 (3SK41). <input type="radio"/> Deteriorated Q2 (3SK41). <input type="radio"/> Defective CF1 or CF2. <input type="radio"/> Deteriorated Q14 or Q15 (3SK35). <input type="radio"/> Trimmer off adjustment. <input type="radio"/> Deteriorated Q1 (3SK22).	<input type="radio"/> Adjust 9-volt voltage. <input type="radio"/> Check voltage- Replace. <input type="radio"/> Check voltage. Replace. <input type="radio"/> Check and replace and necessary. <input type="radio"/> Adjust or replace. <input type="radio"/> Re-adjust or replace. <input type="radio"/> Adjust or replace.
5. "S" meter pointer will not deflect.	"S" meter CENTER meter	1) RX NB unit 2) Sensitivity too low. 3) GEN unit 1) FM IF unit 2) RX NB unit	<input type="radio"/> Improperly set volume. <input type="radio"/> Refer to Symptom 3. <input type="radio"/> AGC circuit not operating properly. <input type="radio"/> Off adjustment VRI, T4. <input type="radio"/> Off adjustment VRI	<input type="radio"/> Adjust. <input type="radio"/> Adjust. <input type="radio"/> Check, adjust or replace. <input type="radio"/> Adjustment <input type="radio"/> Adjustment
6. Distorted output sound	In all modes (FM) (SSB, A1, CW)	1) AF unit 1) FM IF unit 2) RX NB unit 1) GEN unit 2) RX NB unit 3) CAR unit	<input type="radio"/> Defective Q5 (2SC1061) or Q6 (2SA671). <input type="radio"/> Coils off adjustment. <input type="radio"/> Coil off adjustment. <input type="radio"/> Coil off adjustment. <input type="radio"/> Low output due to frequency shift.	<input type="radio"/> Check by disconnecting "B" terminal. Replace as necessary. <input type="radio"/> Check <input type="radio"/> Re-adjust. <input type="radio"/> Re-adjust. <input type="radio"/> Re-adjust. <input type="radio"/> Adjust T1 or TC.

OTING

Symptom	Condition	Service Point	Possible Cause	Remidy
7. RIT setting is off zero point.		1) HET unit	○ VR1 off adjustment.	○ Re-adjust.
8. MARKER unit setting is off zero point.		1) MARKER unit	○ TC1 off adjustment or defective crystal.	○ Adjustment or replace.
9. No CW output.	On all bands	1) Check supply voltage. 2) Voltage is normal or close to normal level. 3) Voltage is too low or down at zero level. 4) FM output is normal.	○ Defective IC ○ BPF unit coil is faulted to chassis. ○ Defective relay contact points. ○ Defective FINAL unit. ○ Defective Q1 (2N5641). ○ Defective Q2 (2N5642). ○ Defective GEN unit. ○ Defective Q9 or Q10 (3SK35). ○ Oscillator failure in CARRIER unit, due to: ○ Defective Q1 or Q2 (2SC460). ○ Defective crystal oscillator ○ Coil mistuned. ○ Defective crystal.	○ Check and repair ○ Check and repair ○ Check for continuity. ○ Replace as necessary. ○ Check and replace. ○ Check and replace. ○ Check and replace. ○ Check some part of CARRIER unit. ○ Check and replace. ○ Check and replace. ○ Adjust. ○ Replace.
	On some bands	1) Failure of heterodyne oscillator. 2) FINAL unit	○ Defective BPF unit.	○ Check and repair.
10. Not enough CW output.	On all bands	1) POWER SUPPLY unit 2) FINAL unit 3) HET unit 4) GEN unit 5) BPF unit	○ Voltage too low. ○ VFO output too low, or VFO oscillation has failed. ○ Not enough drive because of defective 2SC998, 2N5641 or 2N5642. ○ Not enough heterodyne oscillator output. ○ Coil off adjustment. ○ Defective crystal filter. ○ Defective Q7 (2SC460). ○ Defective Q9 (3SK35). ○ Defective Q10 (3SK35). ○ Coil is faulted to chassis or adjacent part.	○ Check 20-volt line. ○ Check and repair. ○ Replace. ○ Check output voltage. ○ Re-adjust. ○ Check the level, and replace as necessary. ○ Check voltage. Replace. ○ Check voltage. Replace. ○ Check voltage. Replace. ○ Check and repair.
11. No SSB output.		1) Microphone 2) GEN unit 3) CAR unit	○ Open in the cord, at or near its plug end. ○ Defective Q1 (2SK30), Q2 (2SC373), or Q3 (2SC733). ○ Defective X1 or X2.	○ Check repair. ○ Check voltage. Replace. ○ Check output voltage.
12. No FM output.		1) GEN unit	○ Defective 10.7-MHz crystal. ○ Defective Q5 (2SC460) or Q6 (3SK35).	○ Check. Replace. ○ Check. Replace.
13. Distorted output sound	(SSB)	1) Drive knob	○ Out of adjustment.	○ Adjust to obtain maximum output level on CW.
	(AM)	1) FINAL unit 1) GEN unit	○ Ruptured capacitor, resulting in abnormal oscillation. ○ VR1 off adjustment.	○ Check on CW. Replace as necessary. ○ Re-adjust.
14. Pointer deflection in RF meter is excessive or insufficient.	2) RX NB unit	1) BPF unit	○ Defective diode. ○ Volume off adjustment.	○ Check. Replace. ○ Re-adjust.

NOTE: With regard to troubles on operation, refer to the troubleshooting of the operating manual.

LEVEL DIAGRAM

RECEIVING LEVEL
(MODE-US8)

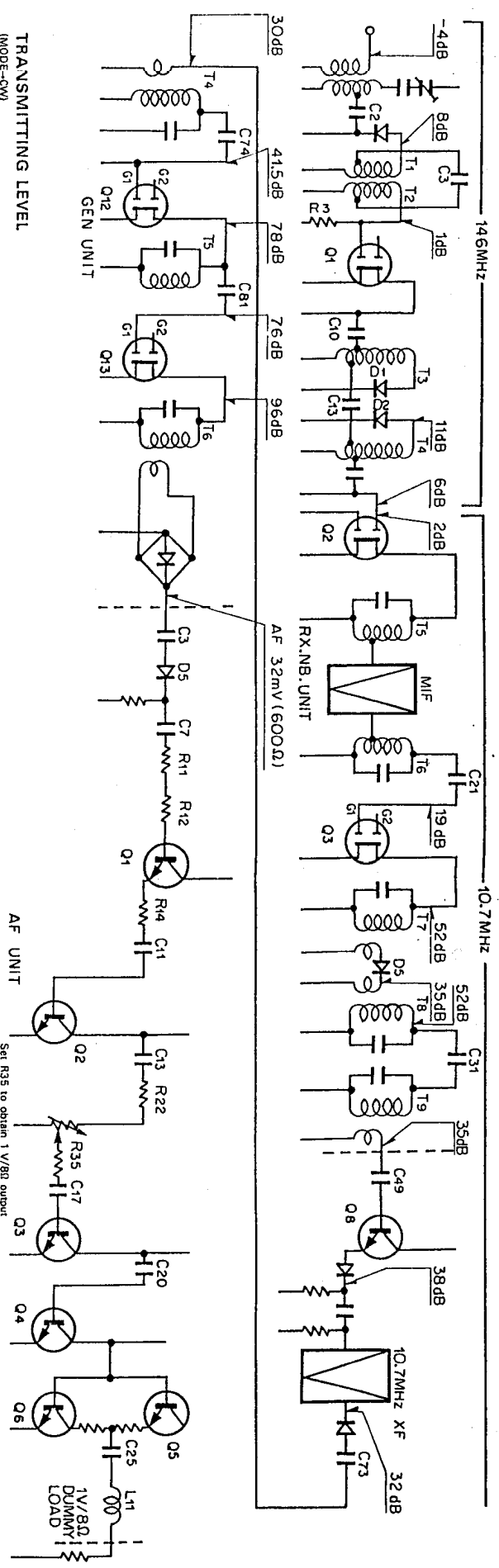

TRANSMITTING LEVEL

(MODE-CW)

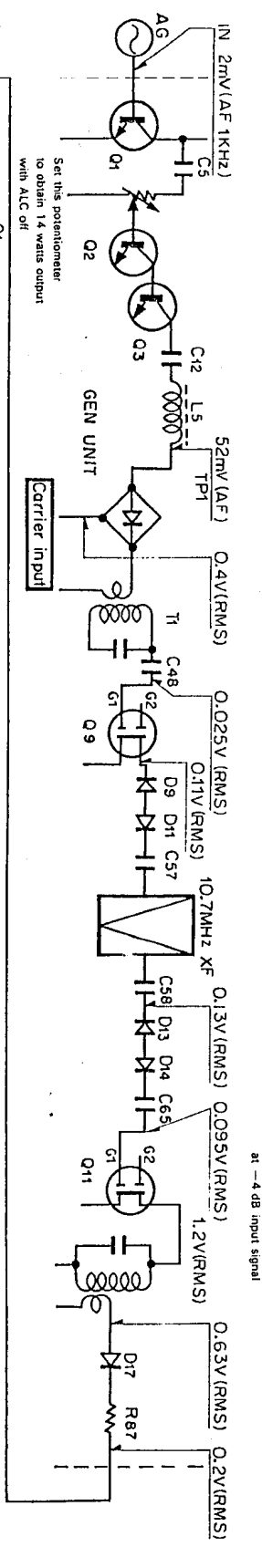

Set this potentiometer to obtain 14 watts output with ALC off

Set R35 to obtain 1 V/80 output at -4 dB input signal

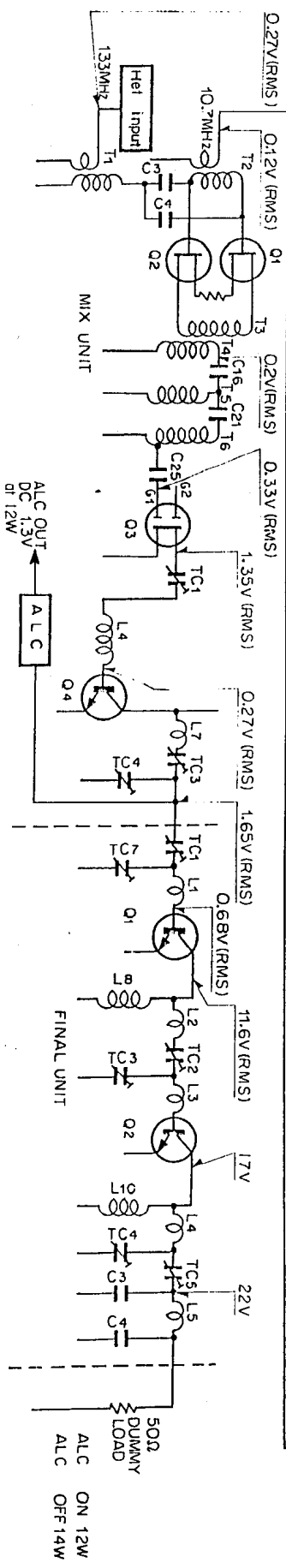

50Ω DUMMY LOAD
ALC ON 12W
ALC OFF 14W

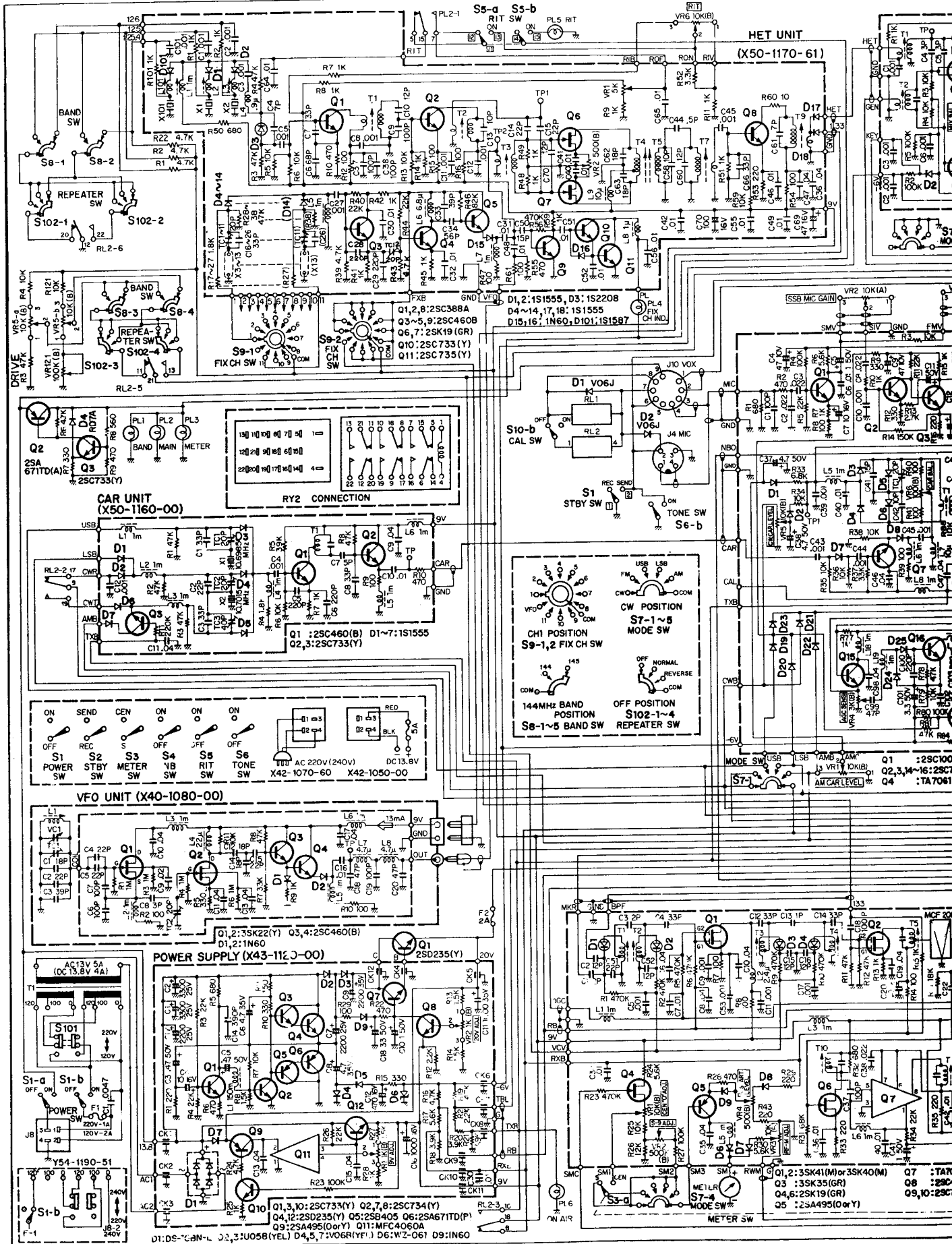

SCHEMATIC DIAGRAM

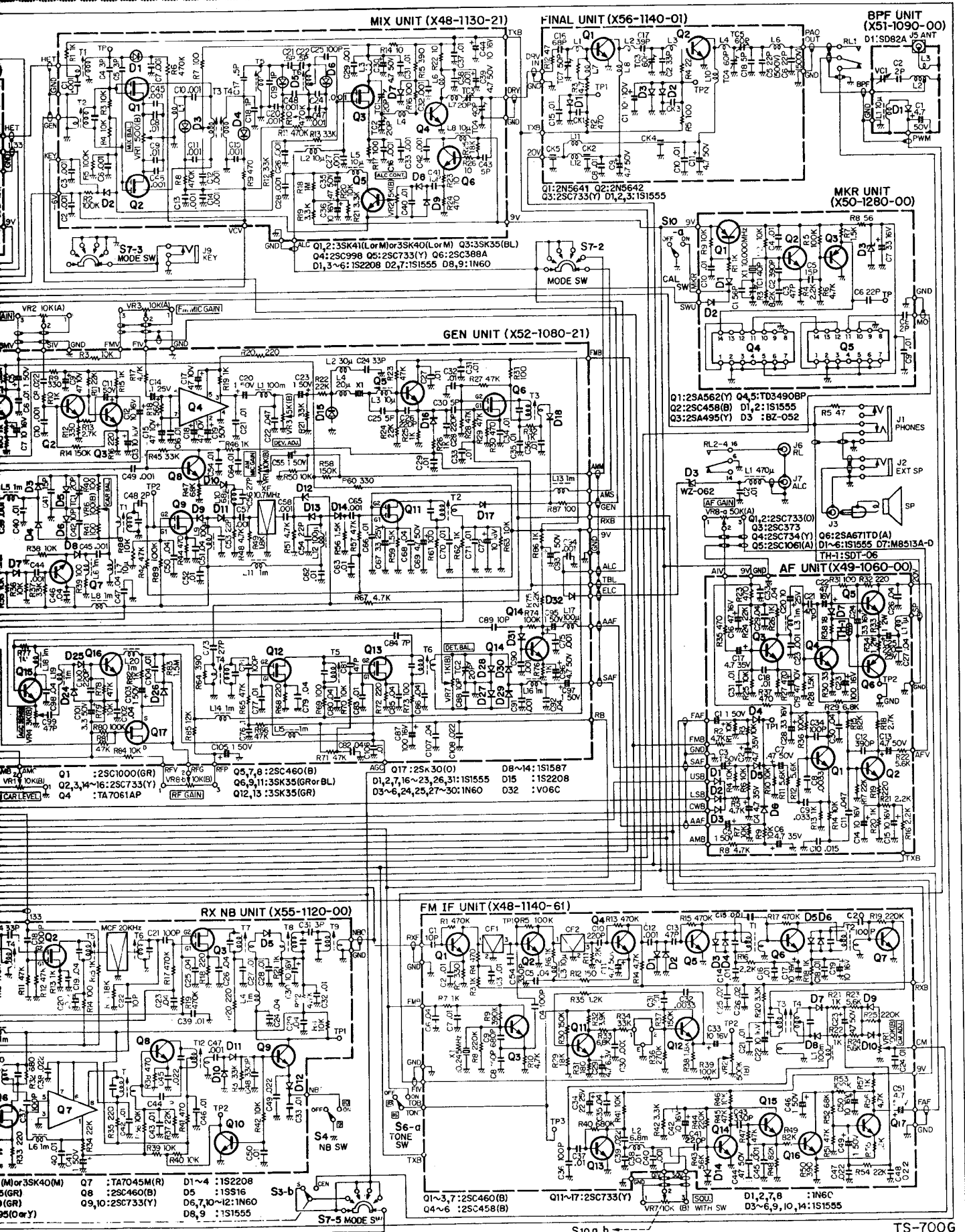

TOP & BOTTOM VIEW OF THE TS-700G

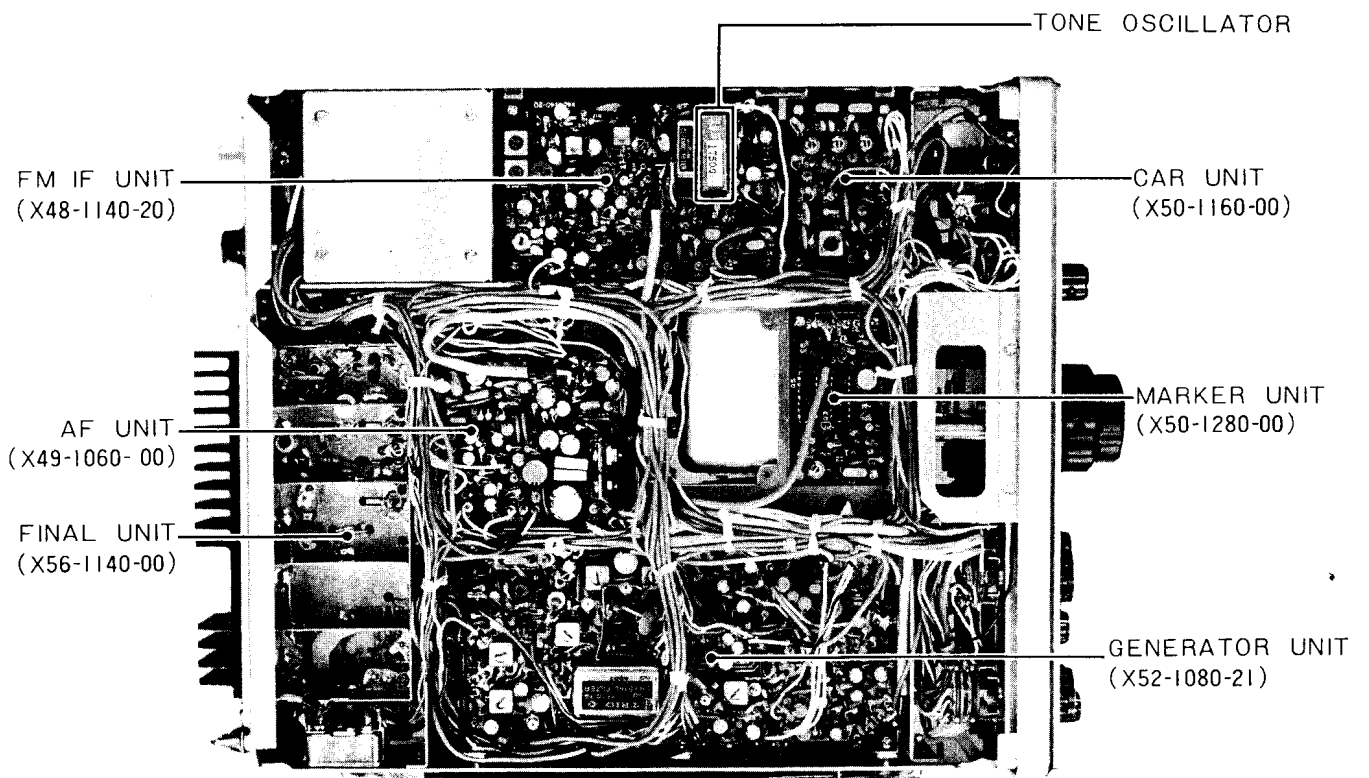
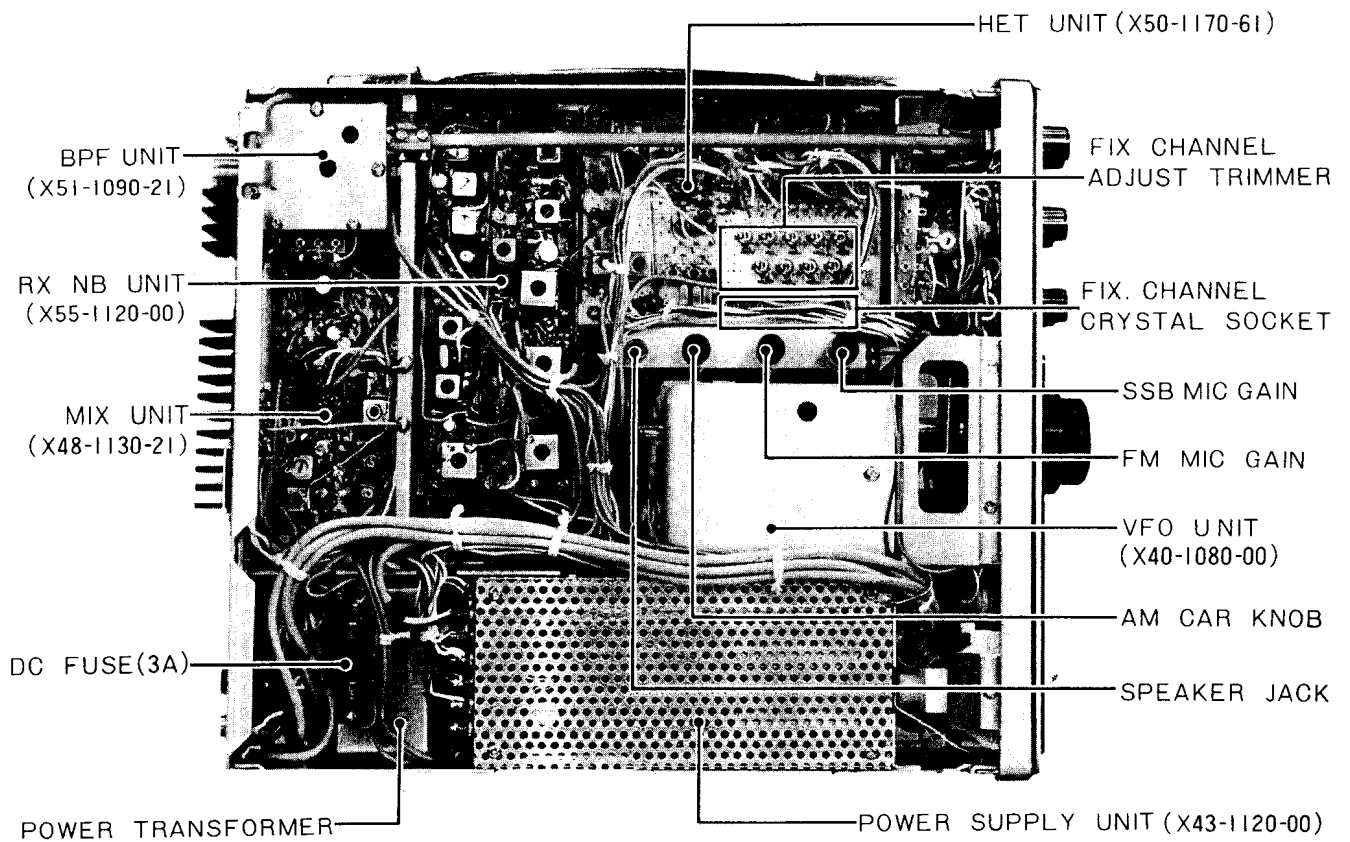

ADJUSTMENTS

TEST EQUIPMENT

1. Frequency counter
Frequency range . . . Up to 150 MHz or more
2. SSG (standard signal generator)
Capable of generating frequencies centering on 144 MHz, variable in amplitude, and also of frequency modulation
Output voltage -10 dB ~ 100 dB
AM 30% modulation (1 kHz)
FM 5 kHz (1 kHz)
3. Oscilloscope
High-sensitivity oscilloscope, synchronizable to external sources.
4. AF VTVM
Frequency range 50 Hz ~ 10 kHz
Input Impedance 1 MΩ minimum or more
Voltage range . . . F.S. = 10mV up to 30 volts
5. RF VTVM
Frequency range 150 MHz or more
For such adjustments not requiring a high degree of precision as those on CAR unit and HET unit, a test circuit arranged as shown in Fig. 11, with a circuit tester, may be used as a substitute.

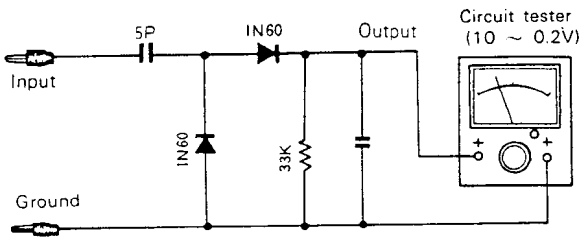

Fig. 11

6. Circuit tester
Input impedance 25 K/V DC or higher
7. Power meter
Capable of measuring up to 20 watts, at 150 MHz.
Input impedance of the meter should be 50 ohms.
8. Linear detector
Frequency range 150 MHz or more
Frequency deviations 20 kHz or more
The detector need not be used where high accuracy of measurement is not required.
9. AG (audio generator)
Output frequencies 50 Hz ~ 10 kHz
Output voltage 1 volt or more
10. AF Dummy load
8 ohms and 5 watts approximately.

GENERAL INFORMATION

1. Have the controls positioned according to Table 1; keep them in the indicated positions at all times unless otherwise instruction is given in the procedure

Control	Position
POWER SWITCH	ON
STANDBY SWITCH	REC
NB SWITCH	OFF
CAL SWITCH	OFF
RIT SWITCH	OFF
DEVIATION SW	WIDE
REPEATER SW	OFF
FIX. CH SWITCH	VFO
RF GAIN	Clockwise end
AF GAIN	Counterclockwise end
SQUELCH	Counterclockwise end

Table 1

2. For the adjusting tools to be used on such as trimmers, a rod made of an insulating material such as bakelite should be made available.
3. When carrying out an adjustment on the receiving section with the use of the SSG, be careful not to turn STBY switch to "SEND" position. This precaution is for protection of the SSG. The safest way is to have the 9-pin plug at the rear face pulled off.
4. When adjusting on the transmitting section, have the power meter connected to this section; this is for protection of the transistors in the final stage.

ADJUSTMENT OF POWER SUPPLY UNIT (X43-1200-00)

Adjust the voltage to the values indicated in Table 2 by referring to Fig. 12. First to be set right is VR1; adjusting this variable resistor will affect VR2. So, be sure to adjust VR2 too after adjusting VR1.

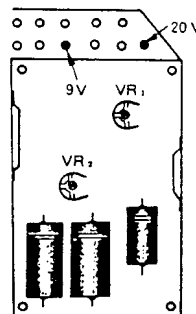

Terminal	ADJ	DC voltage
9	VR1	9V ± 0.1V
20	VR2	21V ± 0V/1V

Table 2

Fig. 12 VFO unit

Downloaded by □

Amateur Radio Directory

Scan by Dan

ADJUSTMENTS

ADJUSTMENT OF CAR UNIT (X50-1160-00)

Hook up the instruments (frequency counter or RF VTVM) as shown in Fig. 13, and adjust to obtain the target values listed in Table 3. When adjusting TC3 (for CW), be sure to have the fixed channel empty.

MODE	STBY	ADJ	OUTPUT RF VOLTAGE OR FREQUENCY
USB	REC	T1	Maximum RF voltage.
USB	REC	TC1	10.6985 MHz
LSB	REC	TC2	10.7015 MHz
CW	SEND	TC3	10.7006 MHz

Table 3

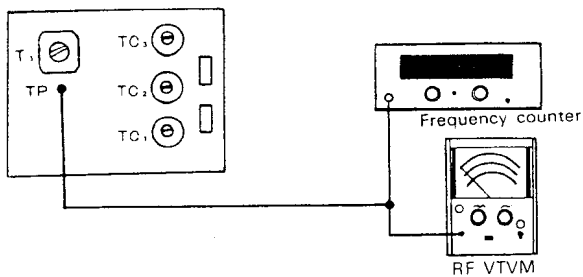

Fig. 13

ADJUSTMENT OF VFO UNIT (X40-1080-00)

Refer to Fig. 14 and Table 4. The dial position "1000" (Table 4) is reached by turning the main dial clockwise and backing it away by one rotation from the stopper point. One rotation corresponds to an interval of 25 kHz. Connect the frequency counter to TP2 terminal of HET unit. The location of this terminal is indicated in Fig. 15.

DIAL	ADJ	OUTPUT FREQUENCY
0	L1	8.200 MHz
1000	TC1	9.200 MHz

Table 4

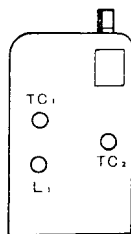
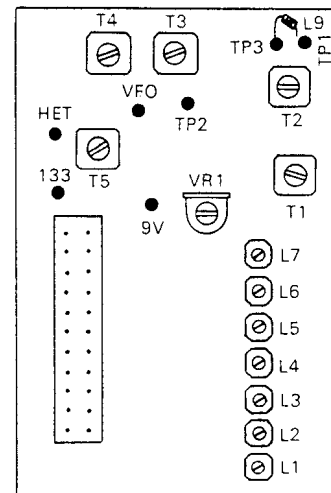
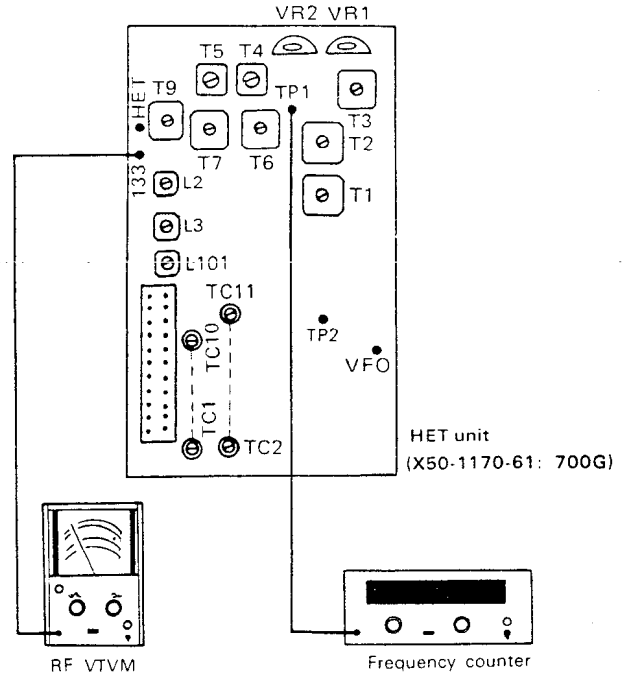

Fig. 14

ADJUSTMENT OF HET UNIT (X50-1300-20) 700A, (X50-1170-61) 700G

Connect the RF VTVM or frequency counter to the HET unit as shown in Fig. 15. With RIT control accurately positioned at "0", the dial at 500 (700A), 0 (700G) position and VR1 (700A), or VR2 (700G) set at its neutral position, adjust according to Table 5.



HET unit (X50-1300-20: 700A)

Fig. 15

Note:

When adjusting L1 ~ 6, VR1, make sure that the VFO output voltage is not applying to the VFO terminal! This can be accomplished by having the FIX CH switch turned to an empty channel position.

FREQUENCY ADJUSTMENT

- Set FIX ch knob to empty position in which a quartz crystal is not located, and connect the frequency counter to TP1. Turn the core of L7 fully clockwise down to the bottom of the coil case. Then turn the core counterclockwise by a revolution.
- Adjust each OSC coil as Table 5. On TS-700A, connect TP3 (lead of L9) with 9V terminal!

ADJUSTMENTS

700A

BAND	COIL	FREQUENCY
144	L1	125 100 MHz±100 Hz
145	L2	126 100 MHz±100 Hz
146	L3	127 100 MHz±100 Hz
147	L4	128 100 MHz±100 Hz
146 REPEATER/REV	L5	126 500 MHz±100 Hz
147 REPEATER/REV	L6	128 700 MHz±100 Hz

700G

BAND	COIL	FREQUENCY
144	L2	125 100 MHz±100 Hz
145	L3	126 100 MHz±100 Hz
145 REPEATER/REV	L101	125 500 MHz±100 Hz

Table 5

3. Check the following frequency at each terminal as Table 6.

BAND	REPEATER SW	ST-BY SW	FREQUENCY
146	NORMAL	REC	127 100 MHz±100 Hz
146	NORMAL	SEND	126 500 MHz±100 Hz
146	REV	REC	126 500 MHz±100 Hz
146	REV	SEND	127 100 MHz±100 Hz
147	NORMAL	REC	128 100 MHz±100 Hz
147	NORMAL	SEND	128 700 MHz±100 Hz
147	REV	REC	128 700 MHz±100 Hz
147	REV	SEND	128 100 MHz±100 Hz

700G

BAND	REPEATER SW	ST-BY SW	FREQUENCY
145	NORMAL	REC	126 100 MHz±100 Hz
145	NORMAL	SEND	125 500 MHz±100 Hz
145	REV	REC	125 500 MHz±100 Hz
145	REV	SEND	126 100 MHz±100 Hz

Table 6

4. Braze each core of the coils, and check frequency shift.

ADJUSTMENT OF OUTPUT LEVEL

- With FIX. ch. knob set to empty channel, connect the RF VTVM to the VFO terminal in HET unit.
In 146 band (700A), 145 band (700G), adjust T1, T2 three or four times for maximum reading on the VTVM. Then adjust T2 carefully so that output in each band reaches same level.
- Connect the RF VTVM to G1 of Q6 or Q7 of HET unit.
In 146 band (700A) 145 band (700G), turn VFO on with VFO scale set to 500 (700A), 0 (700G).

On TS-700G, adjust T3 for maximum reading of RF VTVM, and TC2 of VFO unit so that VTVM indicates 1V.

On TS-700A, connect the VTVM to TP2, and adjust TC2 (in VFO unit) for the reading of 0.3V.

- Connect the RF VTVM to 133 terminal of RX-NB unit, and, on TS-700G, adjust T5 ~ T7, T9 VR2 of HET unit for maximum reading. On TS-700A, adjust T3, T4, T5 for maximum RF VTVM reading.

Then, in 144 band, confirm reading of the VTVM to be 0.3V or more with VFO scale set to 0.

ADJUSTMENT OF FIXED CHANNEL

With the frequency counter connected to TP2 (Fig. 15), adjust each trimmer of a fixed channel to obtain the target value indicated in Table 7.

It should be confirmed that installing crystals performs normal oscillation in all channels and the pilot lamp for the FIX. ch. lights.

In the case of installing crystals, output level can be measured by connecting RF VTVM to 133 terminal of RX-NB unit.

When switching the connection between VFO and FIX. ch. output level difference should be within ±0.2V.

Band 1 (144)	Band 2 (145)	(AM, FM, CW) fo	f _{USB}	f _{LSB}
— 144.00	— 145.00	8.200		
— 144.04	— 145.04	8.240		
— 144.08	— 145.08	8.280		
— 144.12	— 145.12	8.320	8.3215	8.3185
— 144.14	— 145.14	—	8.3415	8.3385
— 144.15	— 145.15	—	8.3515	8.3485
— 144.16	— 145.16	8.360	8.3615	8.4585
— 144.20	— 145.20	8.400	8.4015	8.4985
— 144.24	— 145.24	8.440	8.4415	8.5385
— 144.28	— 145.28	8.480	8.4815	8.5785
— 144.32	— 145.32	8.520	8.5215	8.5185
— 144.36	— 145.36	8.560	8.5615	8.6585
— 144.40	— 145.40	8.600	9.6015	8.5885
— 144.44	— 145.44	8.640	8.6415	8.6385
— 144.48	— 145.48	8.680	8.6815	8.6785
— 144.52	— 145.52	8.720	—	—
— 144.56	— 145.56	8.760	—	—
— 144.60	— 145.60	8.800	—	—
— 144.64	— 145.64	8.840	—	—
— 144.68	— 145.68	8.880	—	—
— 144.72	— 145.72	8.920	—	—
— 144.76	— 145.76	8.960	—	—
— 144.80	— 145.80	9.000	—	—
— 144.84	— 145.84	9.040	—	—
— 144.88	— 145.88	9.080	—	—
— 144.92	— 145.92	9.120	—	—
— 144.96	— 145.96	9.160	—	—
— 145.00	— 146.00	9.200	—	—

Table 7

ADJUSTMENTS

ADJUSTMENT OF THE RECEIVER SECTION

1. AM reception

Cable the equipments as shown in Fig. 17.

Controls of TS-700A or G is set as follows:

MODE AM
 DRIVE : 12 o'clock position accurately (145)
 BAND 146 (700A), 145 (7G)
 DIAL SCALE 500 (700A), 0 (700G)
 AF GAIN: Adjust, from time to time, to read about 0.63V on the AF VTVM.

Adjust the SSG to produce a 146.0 MHz (700A), 145.0 MHz (700G) signal at a level anywhere between 10 and 20 dB and feed this signal into the transceiver through its antenna terminal, as shown.

Decrease the SSG output gradually until AGC disappears. Adjust T4, T5 and T6 (of the GEN unit, Fig. 19), T1, T2, T3, T4, T5, T6, T7, T8 and T9 (of the RX NB unit, Fig. 18) in such a way that the pointer of the AF VTVM will deflect to the farthest possible position on the scale. Hold the SSG output always at such a level as will not cause the "S" meter pointer to deflect.

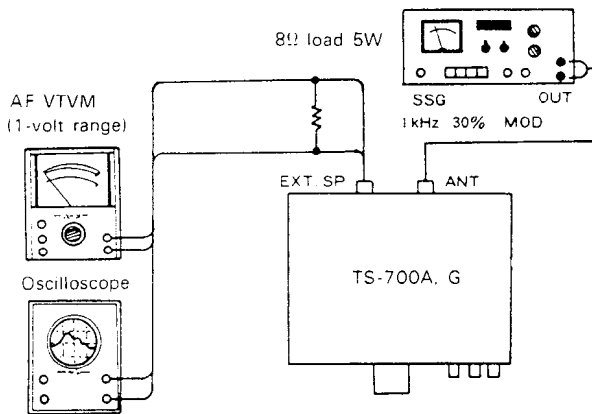

Fig. 17

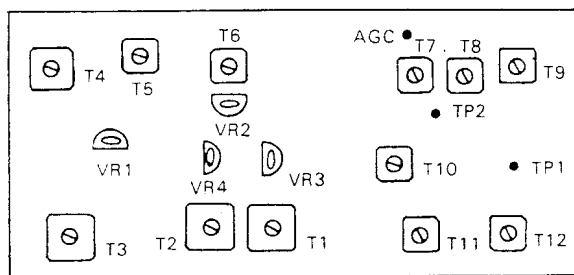

Fig. 18 RX-NB unit

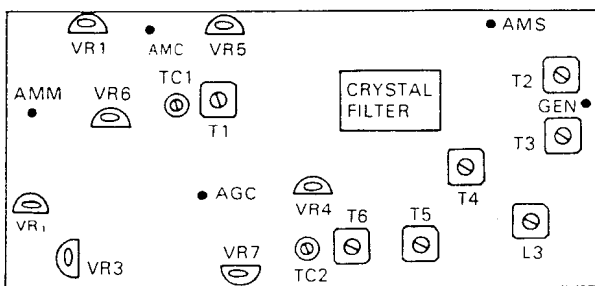

Fig. 19 GEN unit

2. Noise blanker (NB)

- 1) Connect the vacuum-tube voltmeter to TP3 (Fig. 18).
- 2) Set the SSG output (unmodulated to $100\mu\text{V}$ (40 dB), and feed this output signal 146.5 MHz (700A), 145 MHz (700G) into the transceiver set to receive on USB mode.
- 3) Minimize the DC voltage at TP2 by adjusting T8 ~ 10 (Fig. 18).

3. "S" meter

- 1) Adjust VR4 (Fig. 18) to make the pointer of this meter stay at "0" on the scale in the condition of non-reception of the signal.
- 2) Adjust VR4 in GEN unit, so that S meter indicates S-1 at the SSG output of $1\mu\text{V}$
- 3) Set the SSG output (unmodulated to $10\mu\text{V}$ (20 dB), 146.5 MHz (700A), 145 MHz (700G), and feed this signal into the transceiver set to receive on USB mode.
- 4) Adjust VR2 (Fig. 18) to deflect the meter pointer to "9". Repeat the process, step 1) to 3), two or three times.

4. Adjusting procedure for SSB reception (CARRIER balancing)

- 1) Receive a 146.5 MHz (700A), 145 MHz (700G) signal, not modulated, delivered at $10\mu\text{V}$ (20 dB) by the SSG. Have the transceiver set for USB or LSB mode of reception.
- 2) Adjust VR7 and TC2 (Fig. 19) to minimize and equalize the "S" meter deflection for the two sideband signals, USB and LSB

5. Adjusting procedure for FM reception

- 1) Referring to Fig. 17, feed the SSG output of 146.5 MHz (700A), 145 MHz (700G), not modulated, at $10\mu\text{V}$ (20 dB) into the transceiver set for FM mode reception. The input level should be such that the pointer of "S" meter will swing to and stay at the middle position on the scale.
- 2) Change the SSG output signal, making it exhibit a frequency deviation of 1 kHz or 5 kHz. Adjust T3 and T4 (Fig. 20) to obtain the best possible waveform display and to maximize the FM output in each case of frequency deviation

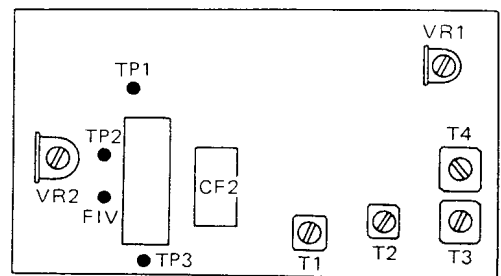

Fig. 20 FM-IF unit
 (X48-1140-20: 700A)
 (X48-1140-61: 700G)

ADJUSTMENTS

6. Adjustment of center meter

- 1) After adjustment of the step (5), set MODE-FM CEN-S switch to CEN position
- 2) Short out SMC terminal of RX•NB unit to GND, and set the center meter indication to center position (RF scale 5) adjusting VR1 (RX•NB unit). Disconnect short-circuited wire between SMC terminal and GND.
- 3) In the case that the center meter indication is off from 5 in on RF scale, adjust T4 in FM-IF unit to obtain center meter indication of 5 on RF scale.
- 4) Applying the signal with 10 μ V (20 dB) at 146.5 MHz (700A) 145 MHz (700G), control VFO knob to show minimum indication.
- 5) Next, adjust VR1 of FM-IF unit to indicate "2" \pm 1.
- 6) Next, make the center meter deflect to plus deflection. And confirm that center meter indication is within 8 \pm 1 on RF scale.

7. Marker unit (X50-1200-00)

Connect the frequency counter as shown in Fig. 21. With CAL control set in ON position, adjust TC1 to read 10 MHz on the counter.

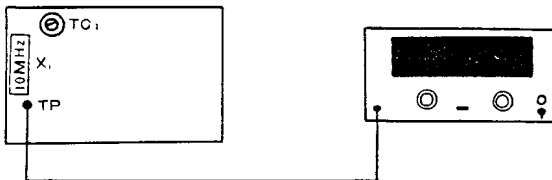

Fig. 21

8. RIT setting

- 1) Have controls set as follows:
 MODE..... USB
 CAL switch..... ON
 RIT..... 0 (Set sharp to this position)
 RIT switch..... ON
 Feed the marker signal (beat signal) into the transceiver.
- 2) Adjust VR1 (of the HET unit, Fig. 15) in such a way that turning off the RIT switch will not affect the beat sound.

9. Main dial

(For more accurate adjustment, refer to Adjustment on VFO unit, page 40)

- 1) Start with the following control settings.
 MODE..... USB
 MAIN DIAL..... (As shown in Fig. 22)
 CAL switch..... ON
- 2) Receive the marker signal. Adjust L1 in such a way that "zero" beat will occur with the sub-dial brought to "0" position.
- 3) With the sub-dial set in "1000" position, adjust TC1. Repeat the process, steps 2) ~ 3), several times.

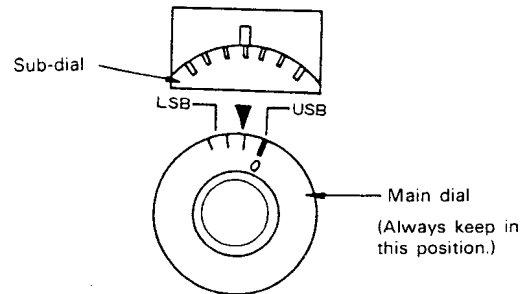

Fig. 22

ADJUSTMENTS

ADJUSTMENT OF THE TRANSMITTING SECTION

1. MIX unit (X48-1080-00)

- 1) Connect the power meter to ANT terminal of the transceiver.
- 2) Have controls set as follows:
 BAND 146 (700A), 145 (700G)
 DRIVE 12 o'clock (145)
 REPEATER SW OFF
 MODE FM
 MAIN DIAL 500 (700A), 0 (700G)
 VR1 Center
 STBY SEND
 VR2 (for ALC) Counterclockwise end
 Have the RF VTVM connected as shown in Fig. 23
 Adjust T1, T3 ~ T6, TC1 ~ TC4 of MIX unit to obtain maximum RF voltage
 (TC3 and TC4 are tentatively adjusted here, and finally adjusted when adjusting the FINAL unit.)

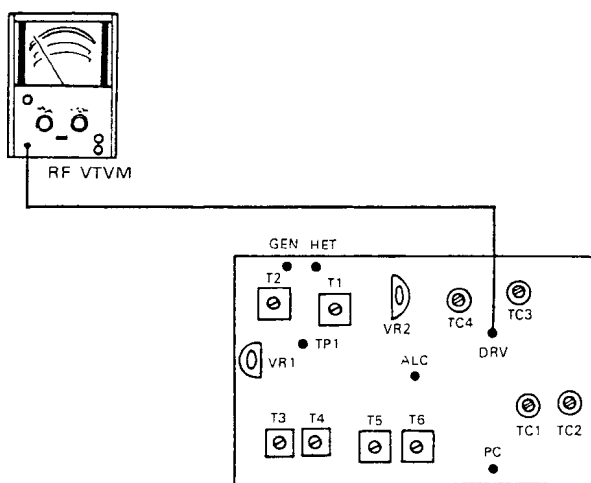

Fig. 23 MIX unit

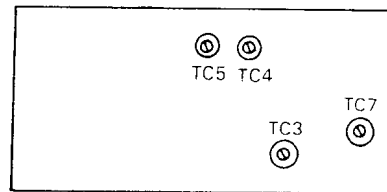

Fig. 24 Final unit

2. FINAL unit (X56-1140-01)

- 1) Connect the power meter to ANT terminal.
- 2) Have controls set as follows:
 BAND 146 (700A), 145 (700G)
 DRIVE 12 o'clock (145)
 REPEATER OFF
 MODE MF
 MAIN DIAL 500 (700A), 0 (700G)
 VR8 (for ALC) Counterclockwise end
 STBY SEND
- 3) Adjust TC3, TC4, TC5 and TC7, shown in Fig. 24, and also TC3 and TC4, shown in Fig. 23, to obtain the largest possible output. (Repeat the foregoing sequence several times, each time adjusting the FINAL control to maximize the output.)

3. ALC adjustment

Note:

This adjustment is to be carried out when the GEN unit, MIX unit and FINAL unit have all been adjusted.

Rotate VR2 (located on the side tag plate of the MIX unit) to its counterclockwise end position; this turns off ALC. Under this condition, check to be sure that an output of at least 13 watts is available. Then reduce the output to 12 watts by adjusting VR2. (Make sure that the ALC voltage is capable of changing between 4 volts and 1.0 volts.)

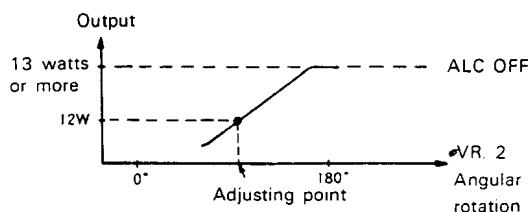

Fig. 25

4. RF meter

- 1) With the transceiver set for FM mode transmission, maximize its output.
- 2) Adjust VR3 (Fig. 18) in such a way that the RF meter pointer will deflect to "8" (RF scale).

5. Adjusting procedure for FM transmission

- 1) Referring to Fig. 19, connect the frequency counter or RF VTVM to the GEN terminal.
- 2) With MODE in FM position and STANDBY (STBY) in SEND position, adjust T3 (Fig. 19) to maximize the RF output voltage.
- 3) Adjust L3 (Fig. 19) to obtain a frequency of 10.700 MHz.
- 4) Referring to Fig. 26, adjust to obtain an AG output of 2 mV and 1.5 kHz.
- 5) Turn FM-MIC-GAIN knobs to center position.
- 6) Adjust VR3 (Fig. 19) for 5 kHz frequency deviation.

ADJUSTMENTS

Note:

Where the linear detector is not available a monitoring receiver may be substituted for it. With such a receiver, the first step is to connect the SSG to it to feed an SSG output with a frequency deviation of 5 kHz; then read the receiver output for reference. The next step is to replace the SSG by the TS-700A or G transceiver being adjusted and change its VR3 in such a way that the monitoring receiver will give an output reading equal in value to the first reading.

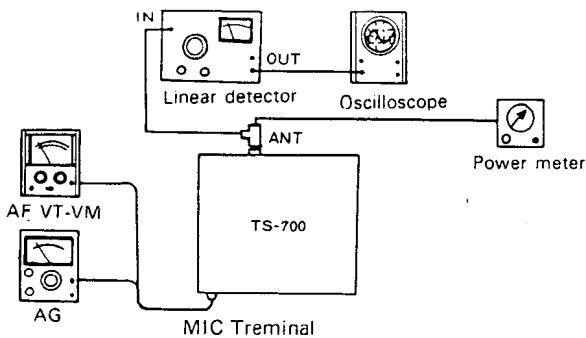

Fig. 26

6. Adjustment of TONE oscillator

- 1) Install a TONE oscillator to FM-IF unit (700A). Set the controls as follows:
 MODE FM
 STBY REC
 TONE ON
 Connect the AF VTVM to FIV terminal of FM-IF unit, referring to Fig. 20, and adjust VR2 for 20 mV reading.
- 2) With STBY set to SEND position, check to be sure that modulating sound can be heard only during 0.5 ~ 1 second from the monitor set, in 700A. The other hand, in 700G turning TONE SW on keeps transmitting and producing modulation sound.

7. Adjusting procedure for CW and AM transmission

- 1) Connect the RF VTVM to the GEN terminal shown in Fig. 19.
- 2) With MODE set in CW position and STBY in SEND position, adjust T1 and T2 (Fig. 19) to maximize the RF voltage as read on the voltmeter.
- 3) With BAND set in 146 (700A), 145 (700G) position and MAIN DIAL in 500 (700A), 0 (700G) position on the scale, maximize the RF output level.
- 4) Adjust VR5 (Fig. 19) to obtain the same output level as the FM output level previously noted.
- 5) With MODE left in AM position, adjust AM CAR VR to obtain a 146 MHz (700A), 145 MHz (700G) output of 2 watts.

- 6) As shown in Fig. 26, connect the AF VTVM and audio generator (AG) to the MIC terminal
- 7) Supply a 1.5 kHz AG output of 2 mV, and adjust VR1 (Fig. 19) so that an AF voltage of 200 mV will be read at the AMM terminal (Fig. 19).

8. Adjustment of CARRIER position

- 1) Produce the largest possible output, with MODE set in CW position, BAND in 146 MHz (700A), 145 MHz (700G) position and MAIN DIAL at 500 (700A), 0 (700G) position.
- 2) With the transceiver set for USB mode transmission, adjust TC1 (of the CAR unit) in such a way that 400 Hz output and 2600 Hz output will both be, about 5 watts the difference being not greater than 1 watt.
- 3) With MODE set in LSB, adjust TC2 in the same way.

9. CARRIER balancing

- 1) With MODE in CW position, produce the largest possible output.
- 2) Switch MODE to USB or LSB position. Connect the RF VTVM to the ANT terminal.
- 3) Adjust TC1 and VR6 (Fig. 19) in such a way as to minimize and equalize the RF voltage read on the voltmeter for USB and LSB modes of transmission.

ADJUSTMENT ON BPF UNIT

(X51-1090-21: 700A, -00: 700G)

This adjustment is to be effected with a standard transmitter (such as TR-7200A or G) connected as shown in Fig. 27. The calibrated and adjusted to produce a 145.0 MHz output of about 10 watts at 50 ohms.

- 1) Referring to Fig. 27, have FINAL set in 146 (700A), 145 (700G) position.
- 2) Reduce the distance between L2 and L3 as much as possible.
- 3) Adjust C2 position and L2 spacing so that the passage loss will be less than 10%, that is will not exceed 1 watt where the standard transmitter, mentioned above, is used in the hook-up illustrated in Fig. 27.

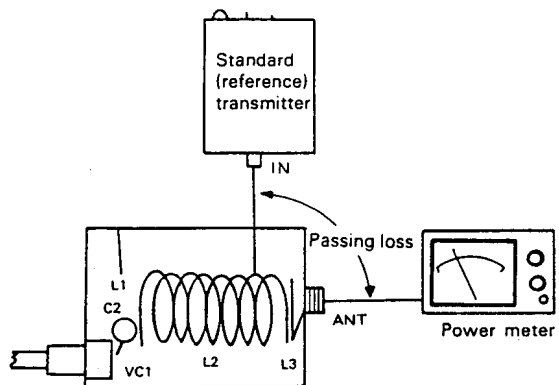

Fig. 27

TRIO-KENWOOD COMMUNICATIONS, INC.

■ 116 EAST ALONDRA BOULEVARD, GARDENA, CALIFORNIA 90248 U.S.A.

TRIO-KENWOOD ELECTRONICS, N.V.

■ HARENSESTEENWEG, 484. 1800 VILVOORDE, BELGIUM.

TRIO-KENWOOD CORPORATION

■ 6-17, 3-CHOME, AOBADAI, MEGURO-KU, TOKYO, JAPAN.

Downloaded by

Amateur Radio Directory

SERVICE MANUAL TS-700A & G SUPPLEMENT

© PRINTED IN JAPAN 1976. 11 B51-0819-00 (G) 1000

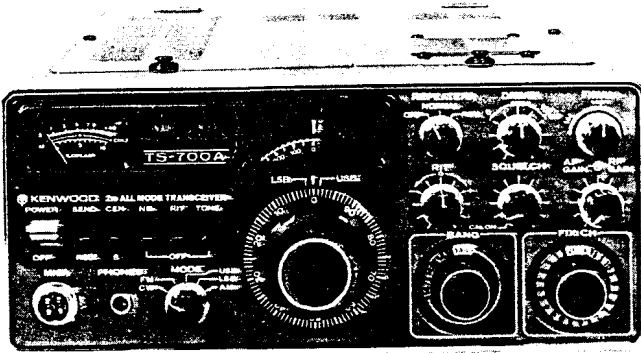

The Power Supply Unit of TS-700A and G, and the HET Unit of TS-700G are improved.

Application: From Serial No. 440000

	New Model	Former Model
Power Supply Unit	<ul style="list-style-type: none"> Unit No. X43-1240-00 AVR IC for 9V line MC1723CL-A A transistor circuit is added for switching the bias of KEY circuit. 	<ul style="list-style-type: none"> Unit No. X43-1120-00 AVR IC for 9V line MFC4060A
HET Unit	<p>(TS-700A's HET Unit is not changed.)</p> <ul style="list-style-type: none"> Unit No. X50-1300-61 A double balanced mixer (SN76514N) is for the balanced mixer to reduce spurious radiation Miniconnectors are used for wiring (Xtal OSC) 	<ul style="list-style-type: none"> Unit No. X50-1170-61 A FET is used for the balanced mixer.

Before Adjustment

Prepare a code of 15 cm long with clips at each end.

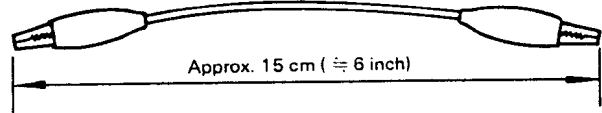

1. Adjustment of the Power Unit (X43-1240-00)

- 1) Connect the tester to the 9V terminal of the Power Supply Unit shown in the Fig. 1 and adjust the VR1 so that the tester indicates 9V.
- 2) Then connect the tester to the 20V terminal, and adjust VR2 (20V adj.) so that the tester indicates 20V.

Caution: The 20V Line is influenced by the adjustment of 9V Line. Therefore, be sure to adjust the voltage of the 20V line.

- 3) Check each terminal voltage

TBL..... $-4.0 \pm 0.3V$ at reception

0 $\pm 0.5V$ at transmission

Make sure the Pilop Lamp of the FIX, CH. switch is off, then place the STBY SWITCH in SEND.

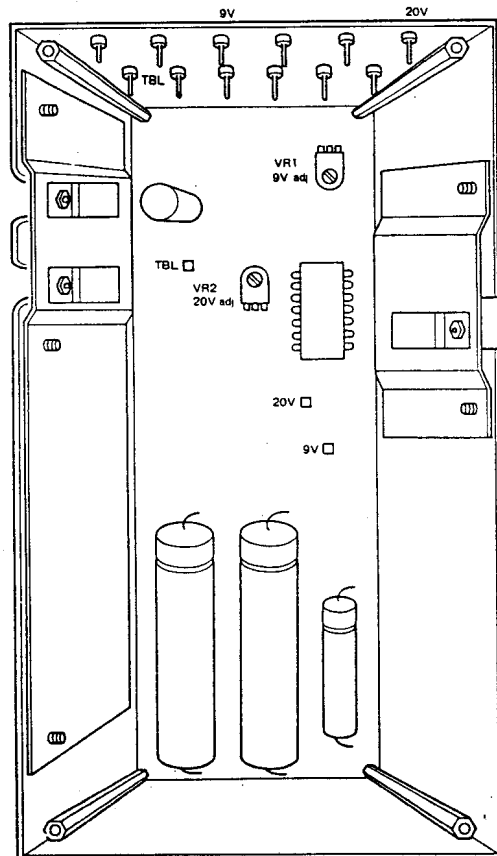
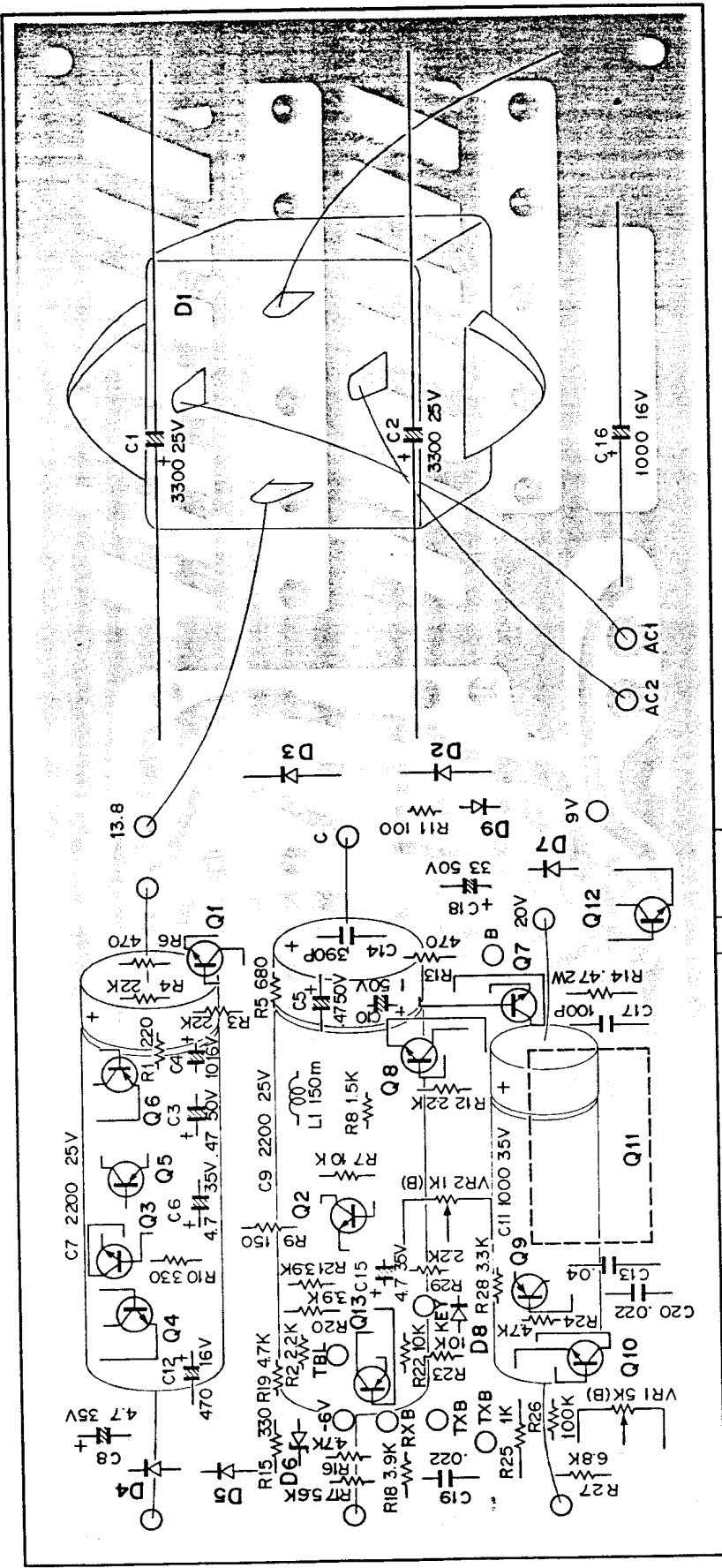
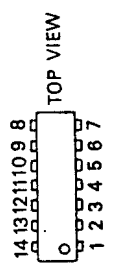

Fig. 1 Power Supply Unit

POWER SUPPLY



MC1723CL-A



25B405(R)



25C734(Y)
25A495(O) or (Y)

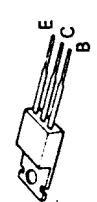

25D235(Y)
25A671TD(B)

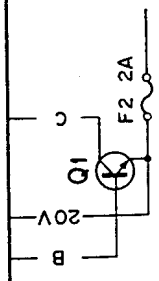
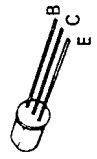

ADJUSTMENTS

2. Adjustment of the HET Unit (TS-700G)

- 1) Connect a RF V.T.V.M. to the TP2 terminal.
- 2) Turn the FIX, CH SWITCH to VFO, and turn the VFO dial to 0.
- 3) Adjust TC2 (VFO Unit) so that the RF V.T.V.M. indicates 0.2V
- 4) Insert the Xtal (8.2 MHz) into the second socket from upside of the FIX, CH Xtal sockets.
- 5) Turn the FIX, CH SWITCH to 11.
- 6) Adjust TC12 of the HET Unit shown in Fig. 2, so that the RF V.T.V.M. indicates 0.3V.
- 7) Turn the FIX, CH SWITCH to 1. (the vacant channel)
- 8) Place the BAND SWITCH in 145.
- 9) Connect the RF V.T.V.M. to TP1. Connect TP3 (the longer one of leads of L9 choke coil) and 9V terminal with the code with clips at each end.
- 10) Adjust T1 and T2 so that the RF V.T.V.M. indicates a maximum value. Repeat this adjustment two or three times.
- 11) Place the BAND SWITCH in 144 or 145 alternately, and adjust T1 so that the RF V.T.V.M. indicates the same level at each band (about 300 mV).
- 12) Then, connect the RF V.T.V.M. to 133 terminal of the RX NB Unit.

- 13) Turn the FX, CH SWITCH to VFO and turn the VFO dial to 0.
- 14) Adjust T3, T4 and T5 in turn so that RF V.T.V.M. indicates a maximum value. Repeat this adjustment two or three times. (the RF V.T.V.M. indicates about 350 mV). Make sure the RF V.T.V.M. indication is more than 270 mV at this time.

3. Tuning the frequency of HET

- 1) Connect a frequency counter to TP1.
- 2) Connect TP3 (the longer one of leads of L9 choke coil) and 9V terminal with the code with clips at each end.
- 3) As shown in the table 1, adjust the frequency of the oscillator by turning each coil.

BAND	COIL	FREQUENCY
144	L1	125.100 MHz \pm 100 Hz
145	L2	126.100 MHz \pm 100 Hz
145 REPEATER/REV	L3	125.500 MHz \pm 100 Hz

Table 1

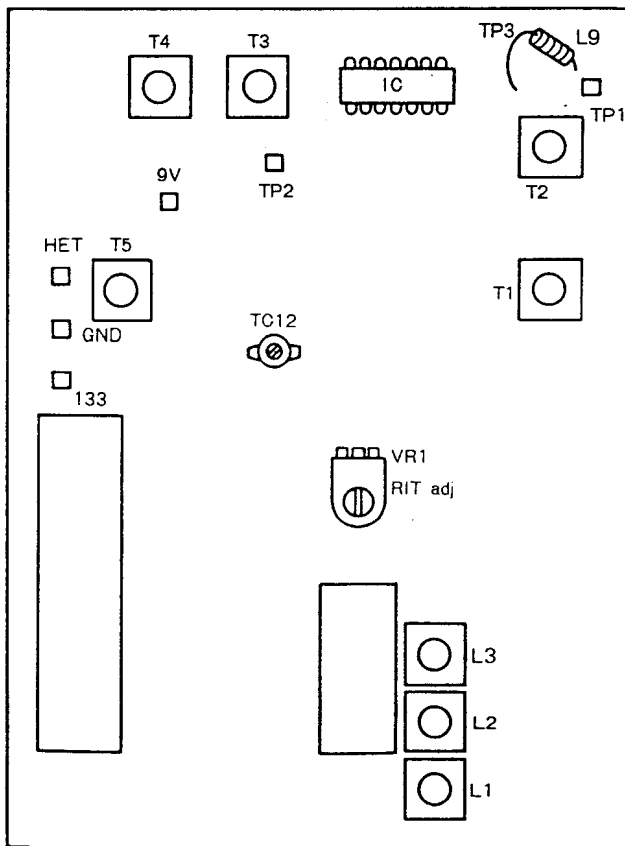
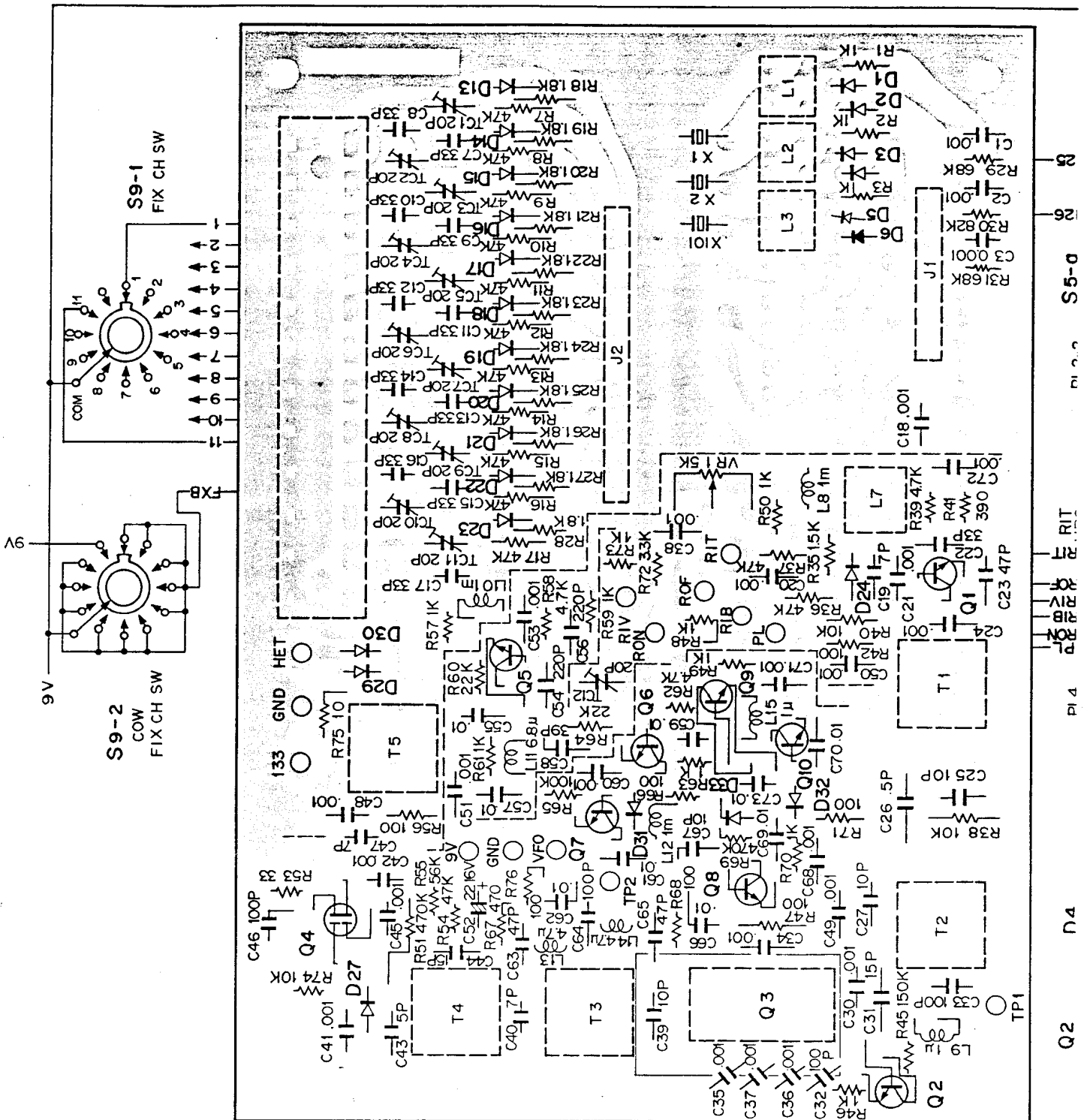

Fig. 2 HET Unit

Downloaded by

 Amateur Radio Directory

HET UNIT (X50)



2SC388(A)
2SC733(Y)
2SC735(Y)

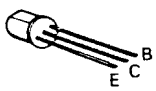

2SC458(B)
2SC460(B)

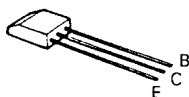

3SK41(L)

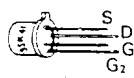

SN76514N

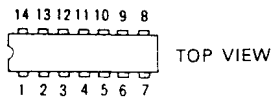

Q2
D4
D5
D6
D7
D8
D9
D10
D11
D12
D13
D14
D15
D16
D17
D18
D19
D20
D21
D22
D23
T1
T2
T3
T4
T5
J1
J2
X1
X2
X10
S5-0
S5-1
S5-2
S5-3
S5-4
S5-5
S5-6
S5-7
S5-8
S5-9
S5-10
S5-11
S5-12
S5-13
S5-14
S5-15
S5-16
S5-17
S5-18
S5-19
S5-20
S5-21
S5-22
S5-23
S5-24
S5-25
S5-26
S5-27
S5-28
S5-29
S5-30
S5-31
S5-32
S5-33
S5-34
S5-35
S5-36
S5-37
S5-38
S5-39
S5-40
S5-41
S5-42
S5-43
S5-44
S5-45
S5-46
S5-47
S5-48
S5-49
S5-50

Scan by [Signature]

1300-61)

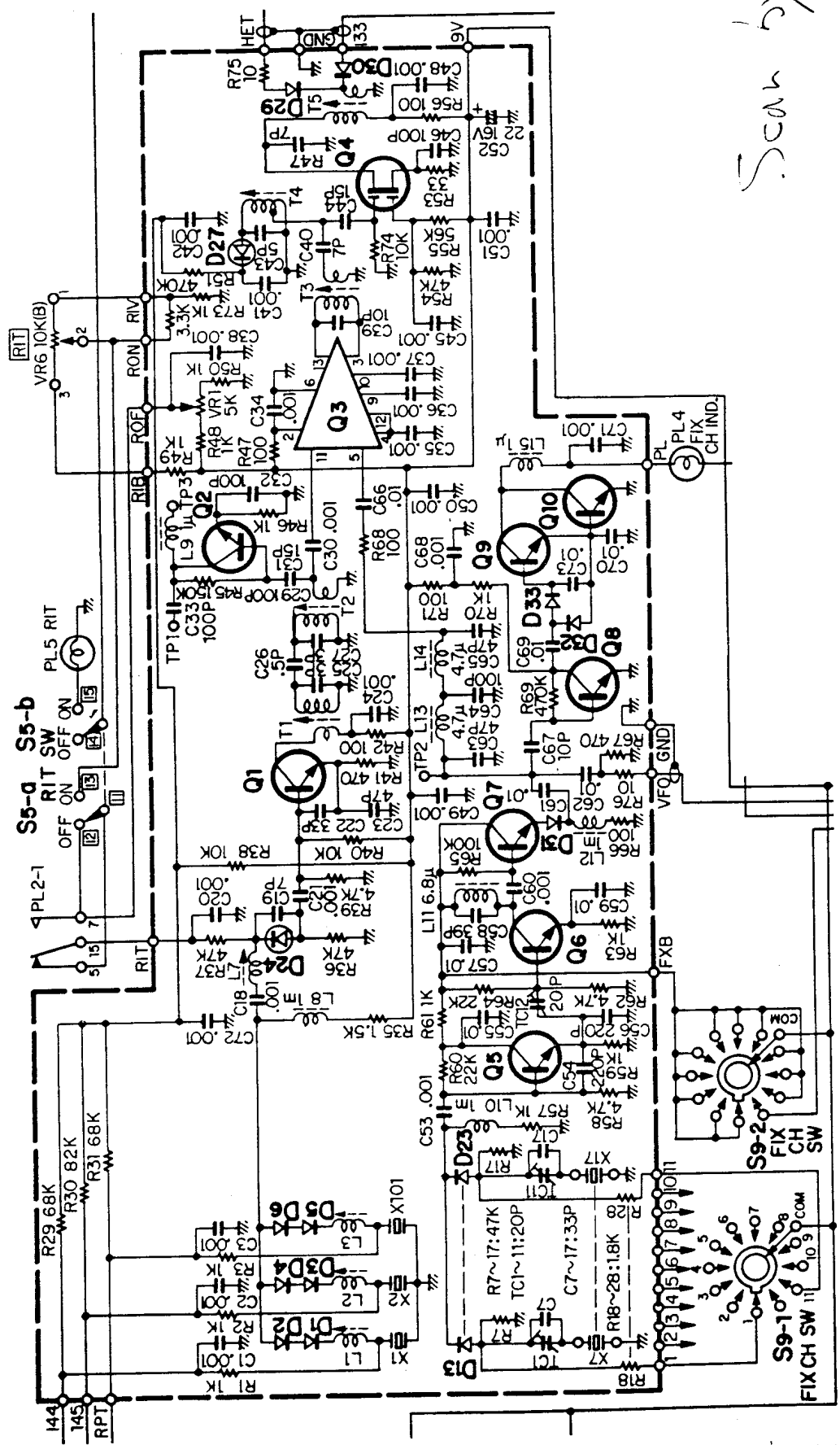
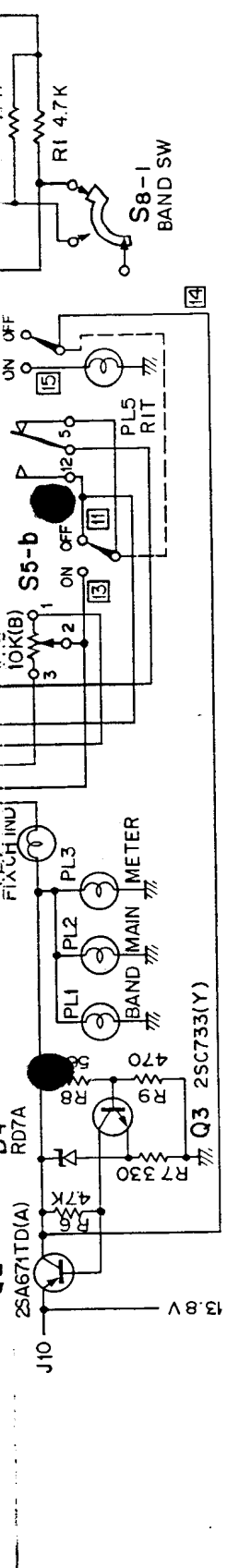

Q1: 2SC388A, Q2, 8: 2SC460(B), Q3: SN76514N, Q4: 3SK41(L), Q5~7: 2SC458(B),
 Q9: 2SC733(Y), Q10: 2SC735(Y), D1~6, 13~23, 29, 30: 1S1555, D24, 27: 1S2208,
 D31~33: 1N60