

# New Life for the AM6154 and AM6155

John, W1AN  
29 July, 2014

There are numerous sources for conversion information and modifications that have been shared over the years for the FAA AM6154 and AM6155 amplifiers which many of us are still using. Someday I may go the route of solid state but I still enjoy working on the familiar older equipment with which I grew up. I will share more recent work and perhaps a few of you will give those amps another few years on the air.

One problem that often rears its ugly head is the HV RF breakdown of the plate line capacitor insulator. This is made of mica or Dupont Kapton. Successful repair methods have been shared by K4HV, WA5VJB, KOTLM, W3RJW and others, and implemented by many, mostly for the 432MHz conversions. In my case, I had two failures on 144MHz and the modification I made is similar to the K4HV method that re-locates the HV feedpoint and choke. My mod locates the feedthru cap and choke to the side of the tube housing.

To start you will need to remove the tube and the screws that hold the tube plate to the plate line. There is the metal bracket to which the end of the Red HV lead is soldered after passing through the inside of the cavity plate line. The plate cap, Kapton or mica insulator is sandwiched between. Once the screws are out you need to pull it away from the cavity while unsoldering at the center pin. It should only require minor tension while applying heat.

Next unsolder the end of the Red HV lead at the HV connector that mates with main chassis. This is at the rear end of the assembly. Do not remove the shrink tubing or wire at the feedthru end.

Now you will need to remove the feedthru cap. I found that you can use a sharp edged small flat screwdriver tapped tangentially against a hex side of the feedthru to loosen it enough so that you can easily unscrew it. Do it counter clockwise! Take your time! Once out, very carefully remove the shrink tube and red lead on the threaded end only.

The next few photos show pretty much all you need to know. Be careful locating the drill for the new feedthru location. Leave clearance so that the mounting nut will lay flat inside. A nut and lockwasher from a 3/8" potentiometer shaft fits the feedthru. Reconnect the red lead and add the choke. I used about 25T of #26 on 0.25" teflon rod. You could probably wind this on a 1W high ohm carbon resistor. Close is good. Less turns would be needed for 220MHz and 432MHz.

I measured the original Kapton insulator to be 0.0025" thick or 2.5 mils. I replaced it with 3.0 mil piece which I obtained directly from Dupont. I did not trust alternate sources. If asked, I have some pieces available for an SASE. After the repair and a tune up, I found that my power out increased by about 40W. On 144MHz I easily get 350W out with 6W input on CW, but I don't like to push it. I believe the original HV straight wire "choke" was robbing some of the efficiency by shunting some of the RF to ground. I haven't test 220MHz or 432MHz yet.



**Drill thru both the aluminum chassis and the plate side of the tube enclosure. Increase to 3/8" for the feedthru cap. Allow clearance on inside for the 3/8 lockwasher and nut.**

**W1AN**

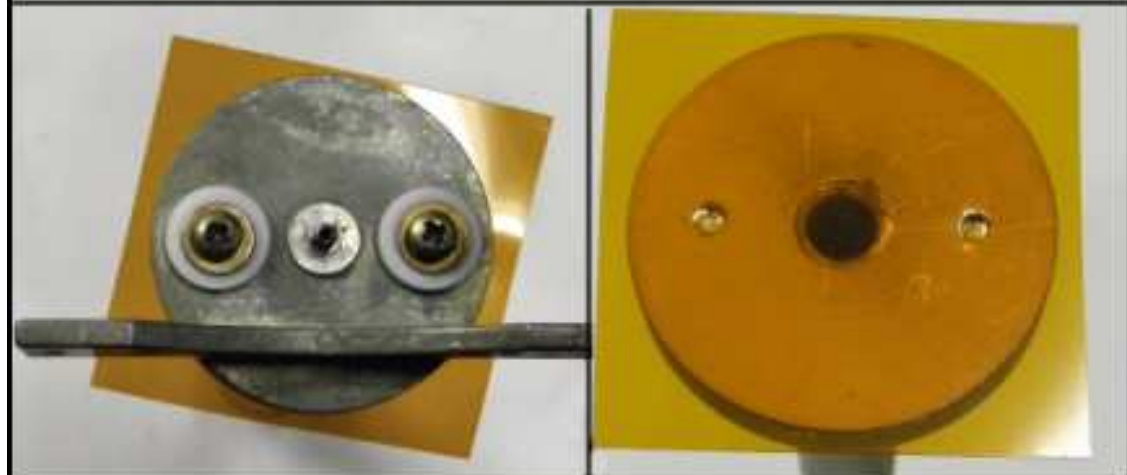
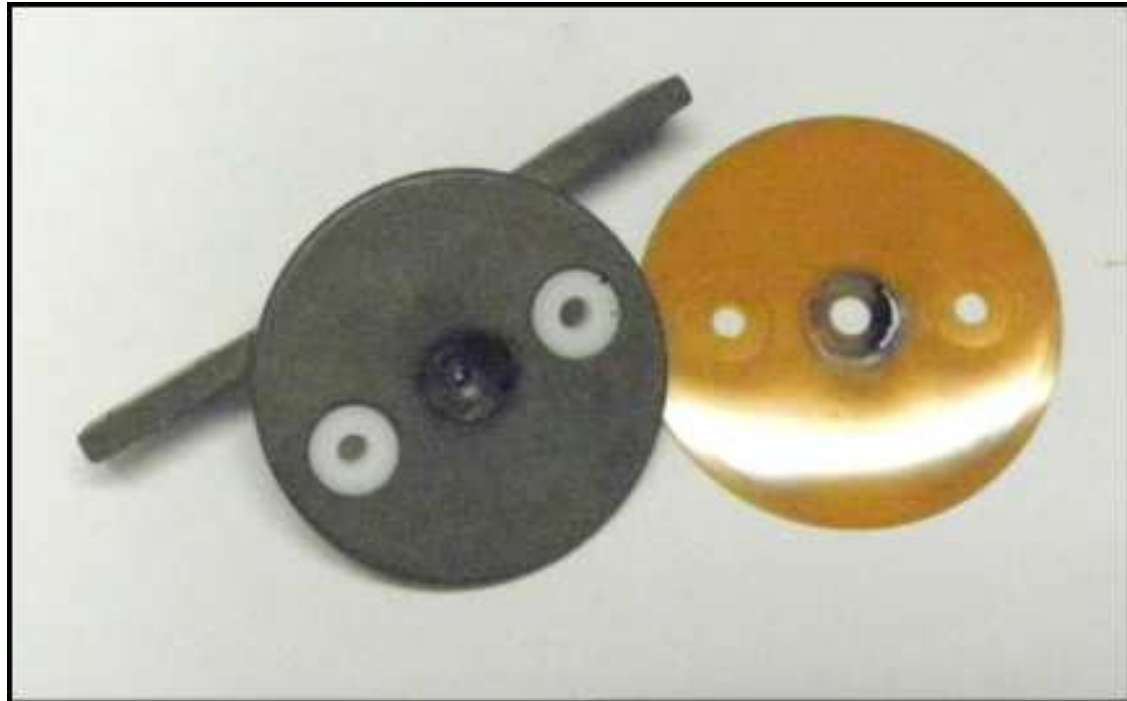

**Damaged insulator replaced by new .003" Kapton. Holes were made using the plate attachment piece as a guide then carefully enlarged with an awl. Small raised "peaks" in the Kapton were removed with a razor blade. The work can be completed without removing the cavity line.**

**W1AN**

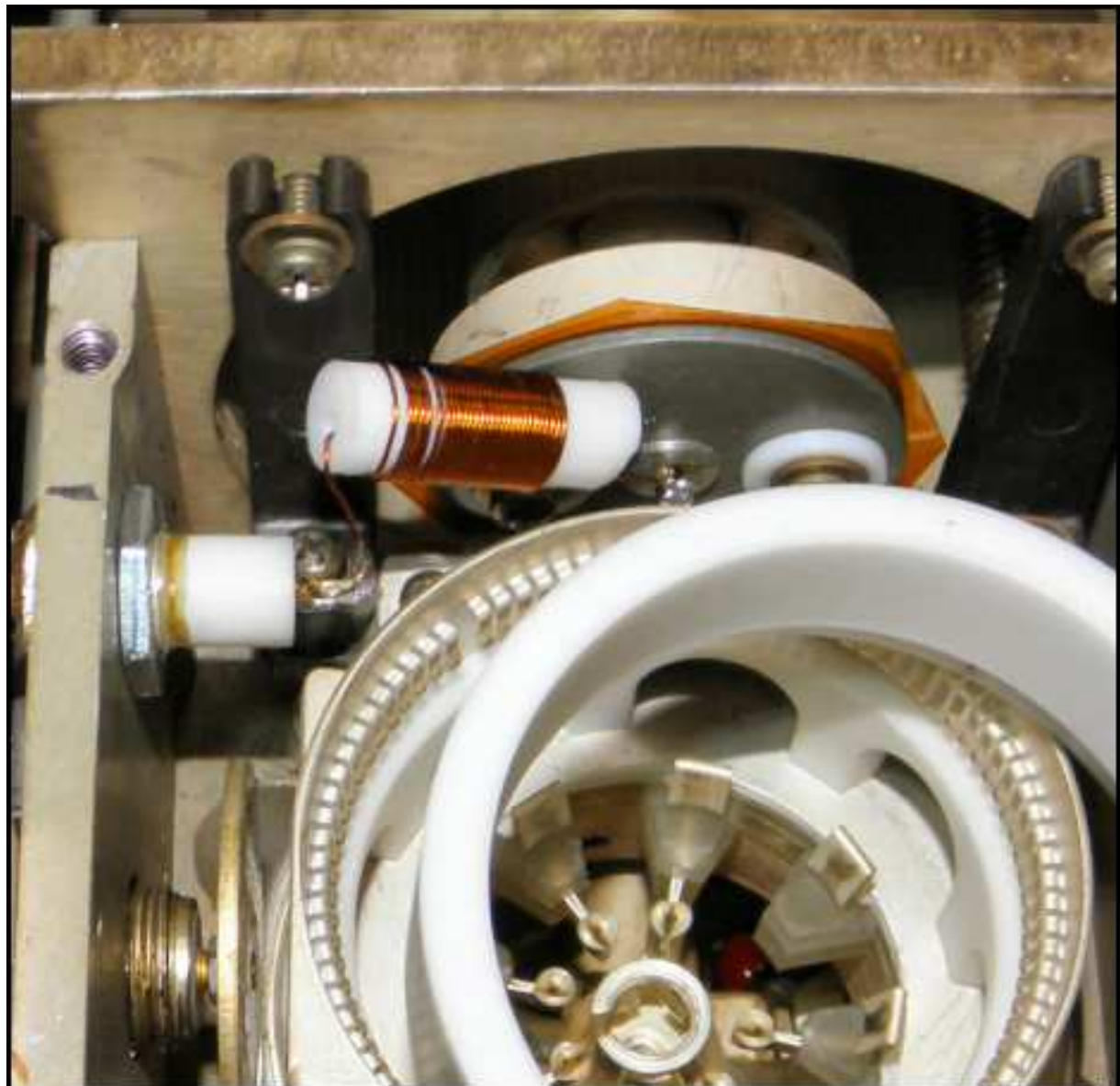

**Plate side of tube enclosure showing new Kapton insulator, relocated feedthru cap and plate choke. Plate choke is wound on piece of teflon rod. New Kapton insulator has no thru hole for plate lead.**

**W1AN**

If you have broken plate line and rod insulating supports you can make a fix from glass epoxy PCB material that has the copper removed. If you do it like the photo you need not fully disassemble the cavity from the tube housing. The tube socket and mounting appear to be adequate. Time will tell.

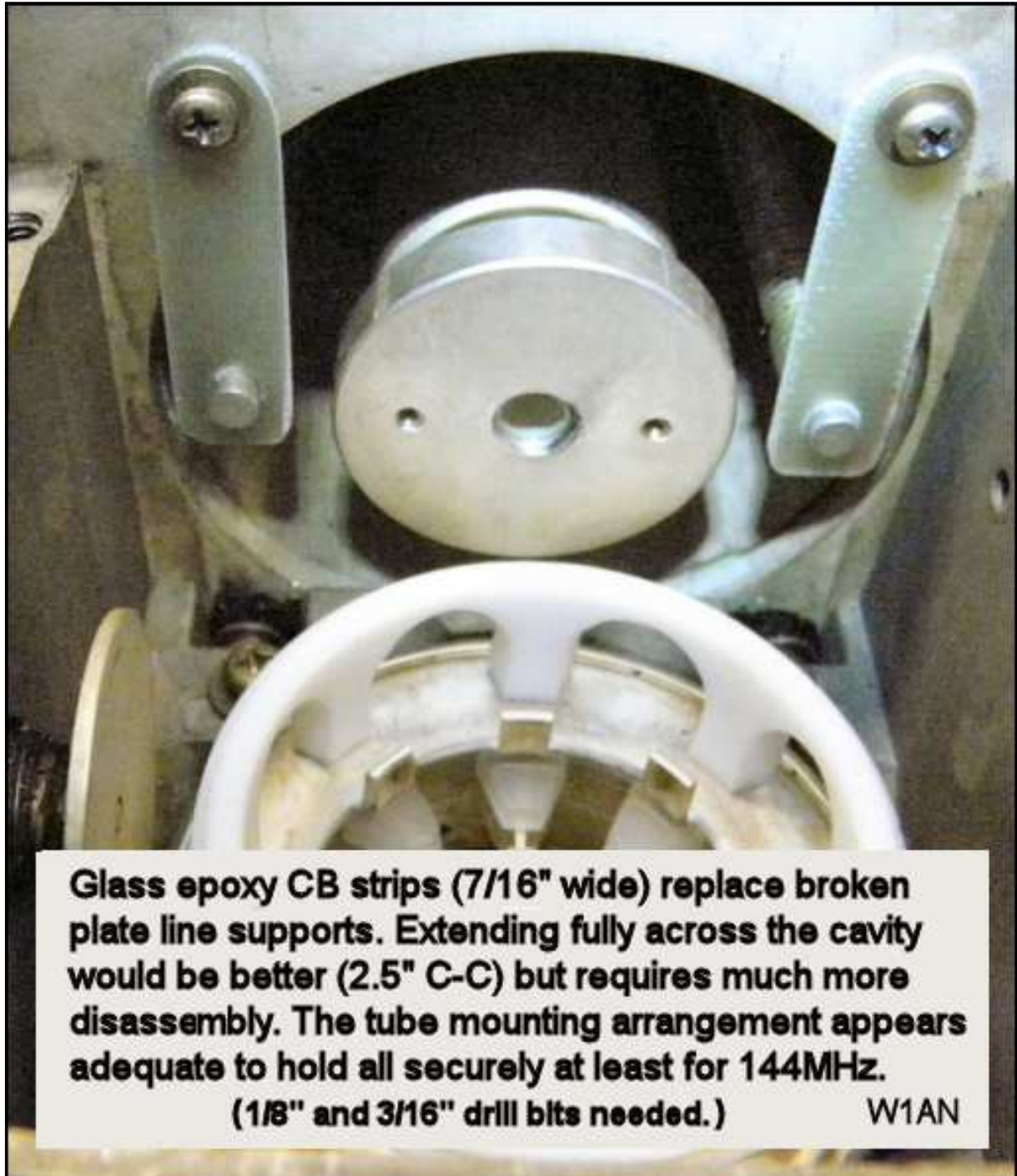

**Glass epoxy CB strips (7/16" wide) replace broken plate line supports. Extending fully across the cavity would be better (2.5" C-C) but requires much more disassembly. The tube mounting arrangement appears adequate to hold all securely at least for 144MHz.**

**(1/8" and 3/16" drill bits needed.)**

**W1AN**

If you want to have the option of using either the original Amperex DX-393 and Eimac 8930 or the Russian 4CX400A, I recommend using the VE2ZAZ bias supply design. I show my version of the circuit board with a way to select the tube bias option. I haven't found any solid state regulators that have a wider voltage range so I think we are stuck with the LM337T. Maximum voltage across it is 40V. I use DIP switches to select the bias range. You could use a pair of 2 pin headers and one push on jumper to achieve the same thing. A DPDT PCB mounted switch would be ideal.

Below I've included below some schematics I edited with changes I have done. By no means is this write up intended to be a complete guide to converting an AM6155/AM6155. There is much more on the web that includes the RF sections, relay keying, and other approaches to accomplish the same. Most of the credit is due the many others over the years that have shared their work.

73, John, W1AN

## Grid Bias Circuit Board for AM6154 and AM6155

With thanks to VE2ZAZ for the original circuit.

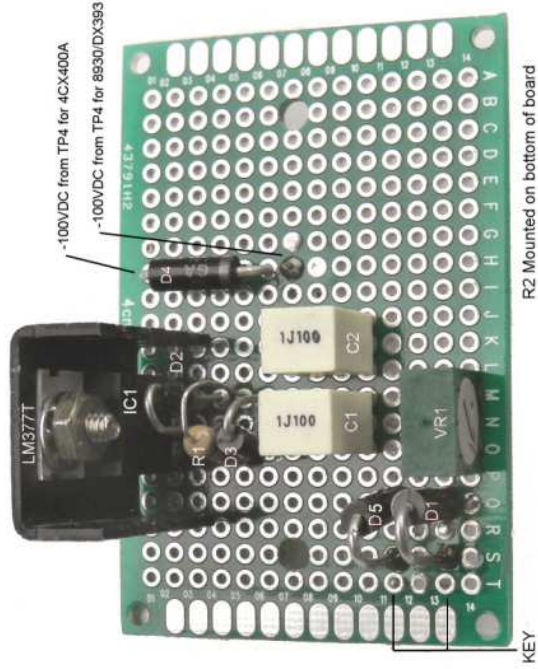
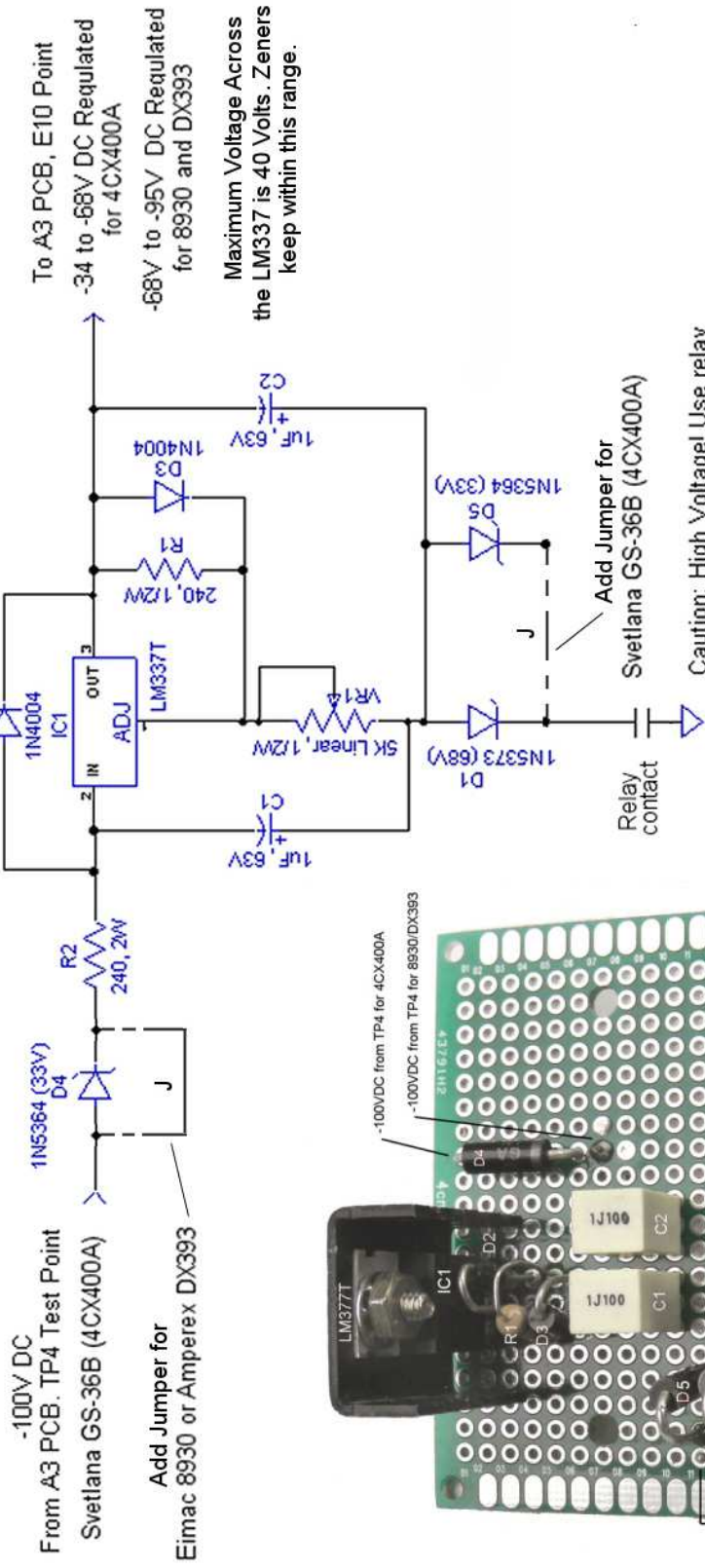

A PCB mounted switch, pin headers or DIP switches can be added to simplify bias selection.



Bias board on carefully located standoffs ready for remounting in P.S. W1AN



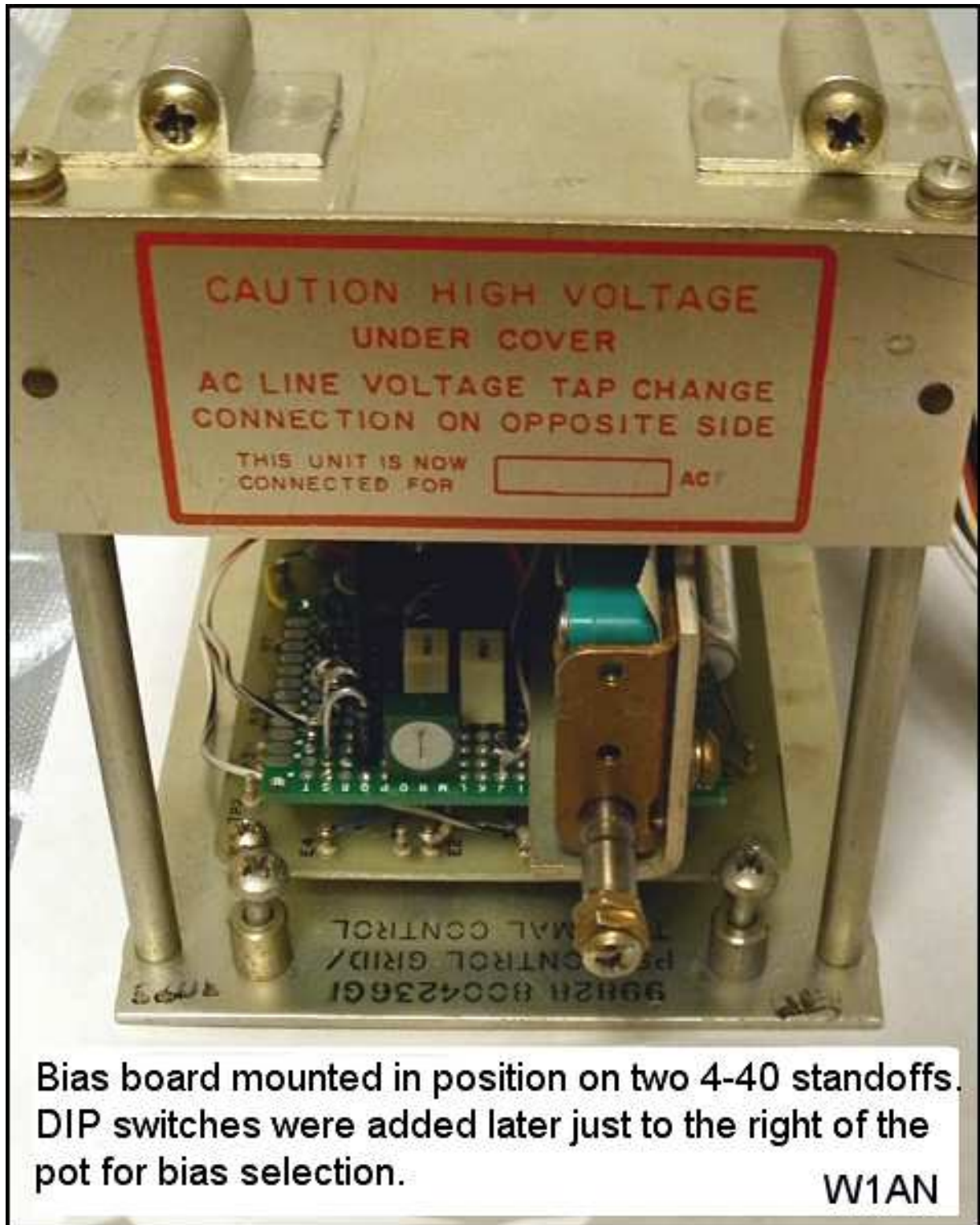

Bias board mounted in position on two 4-40 standoffs. DIP switches were added later just to the right of the pot for bias selection.

W1AN

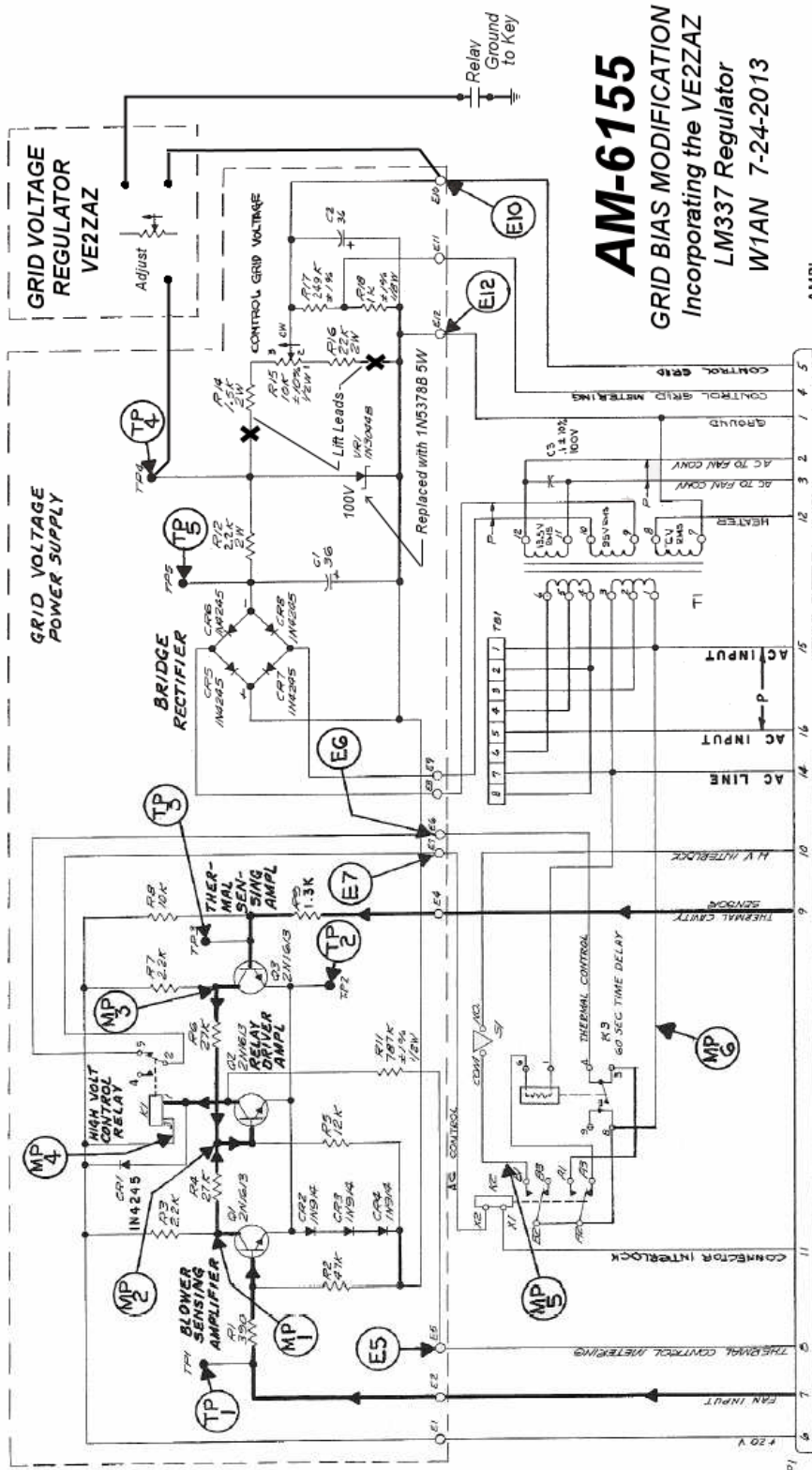

# AM-6155

## GRID BIAS MODIFICATION

### Incorporating the VE2ZAZ

#### LM337 Regulator

#### W1AN 7-24-2013

T.O. 31R2-2GRT-102

AMPL	THERMAL	BLOWER
CUT OUT	3.5 VDC	INOPERATIVE
NORMAL	3.0 VDC	0 VDC
UNKEYED	2.0 VDC	3.0 VDC
KEYED	3.5 VDC	3.5 VDC
-100 VDC	UNKEYED	
-130 VDC	UNKEYED	

- NOTES:
- UNLESS OTHERWISE SPECIFIED: RESISTANCE VALUES ARE IN OHMS ± 5%, 1/4 W. CAPACITANCE VALUES ARE IN MICROFARADS, +30%, -15%, 150 V.
  - ALL VOLTAGE MEASUREMENTS TAKEN WITH A HIGH INPUT IMPEDANCE METER (HP 427) OR EQUIVALENT.
  - REFERENCE DESIGNATIONS ARE ABBREVIATED PREFIX THE DFIG-NATION WITH UNIT NUMBER OR ASSEMBLY DESIGNATION OR BOTH.

Figure 6-27. Power Supply, Control Grid/Thermal Control/AC Control A3, Schematic Diagram

Change to 1N3004-7  
(Lowers screen voltage to ~340V optional)

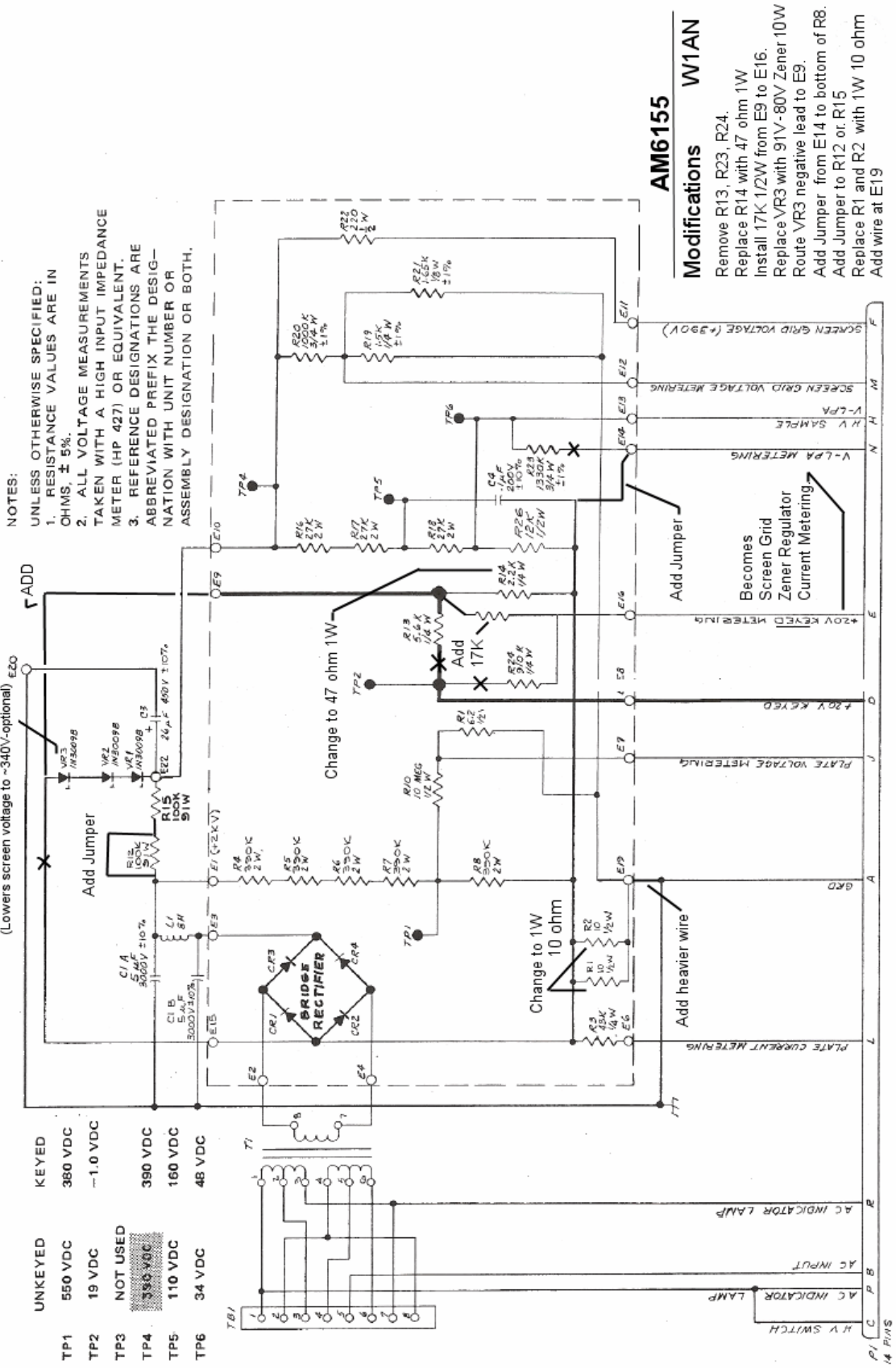

- UNLESS OTHERWISE SPECIFIED:  
 1. RESISTANCE VALUES ARE IN OHMS, ± 5%.  
 2. ALL VOLTAGE MEASUREMENTS TAKEN WITH A HIGH INPUT IMPEDANCE METER (HP 427) OR EQUIVALENT.  
 3. REFERENCE DESIGNATIONS ARE ABBREVIATED PREFIX THE DESIGNATION WITH UNIT NUMBER OR ASSEMBLY DESIGNATION OR BOTH.

UNKEYED	KEYED
TP1 550 VDC	380 VDC
TP2 19 VDC	-1.0 VDC
TP3 NOT USED	
TP4 350 VDC	390 VDC
TP5 110 VDC	160 VDC
TP6 34 VDC	48 VDC

### AM6155 W1AN

- Modifications**
- Remove R13, R23, R24.
  - Replace R14 with 47 ohm 1W
  - Install 17K 1/2W from E9 to E16.
  - Replace VR3 with 91V-80V Zener 10W
  - Route VR3 negative lead to E9.
  - Add Jumper from E14 to bottom of R8.
  - Replace R1 and R2 with 1W 10 ohm
  - Add wire at E19

Add Jumper  
 Becomes  
 Screen Grid  
 Zener Regulator  
 Current Metering

Cut the jumper at S1A-1 that goes and connect to floating end of S1A

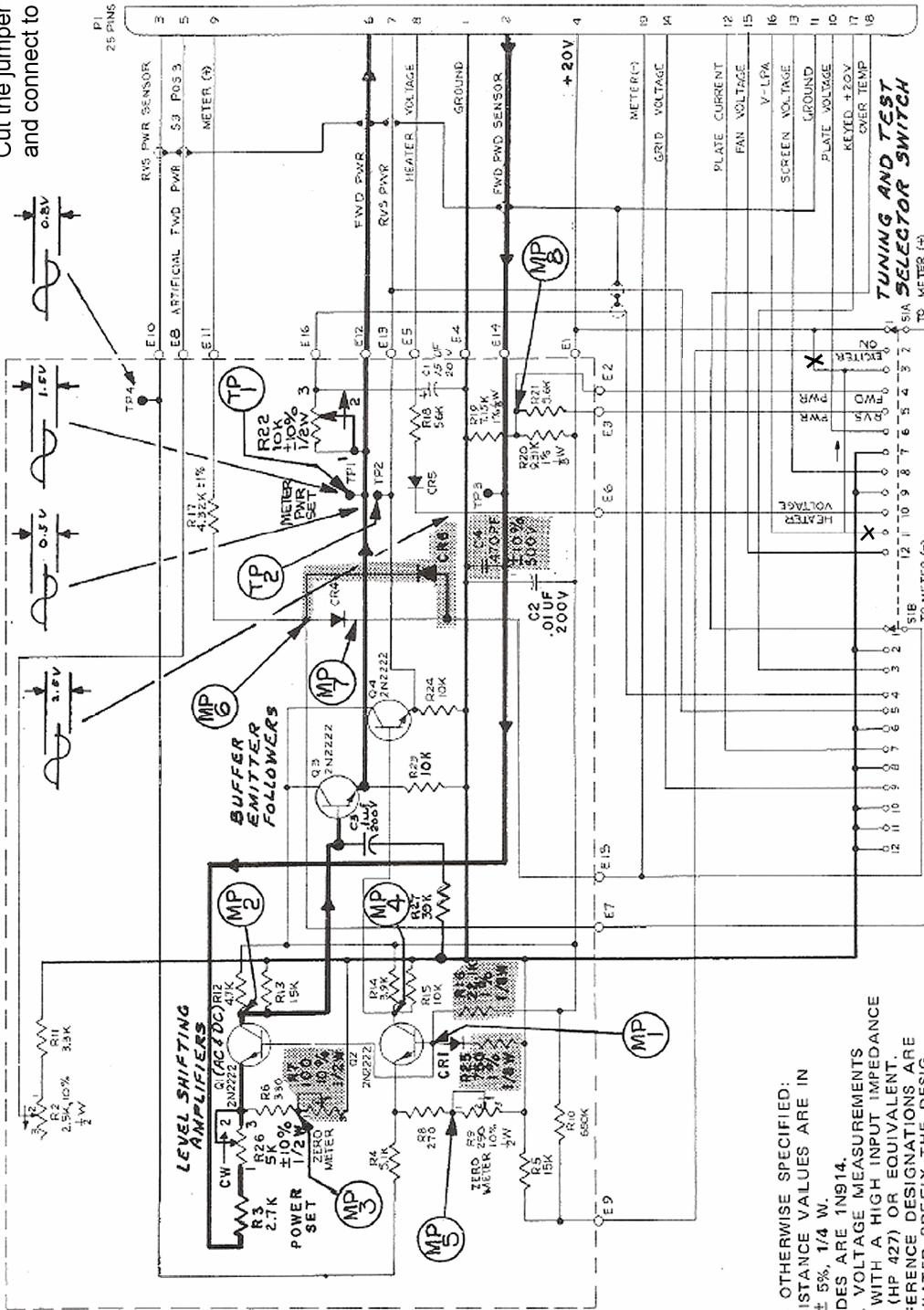

- NOTES:
- UNLESS OTHERWISE SPECIFIED: 1. RESISTANCE VALUES ARE IN OHMS,  $\pm 5\%$ , 1/4 W.
  - DIODES ARE 1N914.
  - ALL VOLTAGE MEASUREMENTS TAKEN WITH A HIGH INPUT IMPEDANCE METER (HP 427) OR EQUIVALENT.
  - REFERENCED DESIGNATIONS ARE ABBREVIATED PREFIX THE DESIGNATION WITH UNIT NUMBER OR ASSEMBLY DESIGNATION OR BOTH

Waveforms: at 1 KHz Remote Modulation input at 0 dbm

**Modifications**

- W1AN 7/26/2013** This list is not yet complete!
- Lift lead on C1.
  - Change R3 to 15K 1/4W.
  - Change R4 to 27K 1/4W.
  - Move CR4 and CR6 to across meter terminals.
  - Change R17 to 10K 10 Tu, 1 Pot for meter adjust. (About 5.32K)
  - Cut the jumper at S1A-1 that goes to S1A-3. Remove wire at S1A-11 and connect to floating end of S1A-3 jumper.

KEYED	UNKEYED
TP1	8.4 VDC
TP2	8.4 VDC
TP3	0 VDC
TP4	0 VDC
KEYED	7.6 VDC
	8.3 VDC
	0 VDC
	-0.3 VDC

Figure 6-31. Buffer Amplifier/Multiplier, Electrical Instrument A5, Schematic Diagram