

DEPARTMENT OF THE ARMY TECHNICAL MANUAL

OPERATOR, ORGANIZATIONAL, FIELD,
AND DEPOT MAINTENANCE MANUAL
ANTENNA GROUP AN/GRA-50

Headquarters, Department of the Army, Washington 25, D. C.

19 July 1961

WARNING

DANGEROUS VOLTAGES EXIST ON THE ANTENNA WHEN IN OPERATION

Before working on any part of the antenna, be sure that all equipment has been disconnected from the power source.

DON'T TAKE CHANCES !

		Paragraph Page
C H A P T E R 1 .	I N T R O D U C T I O N	5
S e c t i o n 1 .	G e n e r a l	3
	S c o p e	1 5
	F o r m s a n d r e c o r d s	2 5
I I .	D e s c r i p t i o n a n d d a t a	5
	P u r p o s e a n d U s e	3 5
	T e c h n i c a l c h a r a c t e r i s t i c s	4 5
	C o m p o n e n t s	5 6
	C o m m o n n a m e s	6 7
	D e s c r i p t i o n	7 7
C H A P T E R 2 .	I N S T A L L A T I O N	8
	U n p a c k i n g	8 8
	C h e c k i n g u n p a c k e d e q u i p m e n t	9 8
	S i t i n g	1 0 8
	I n s t a l l a t i o n	1 1 8
C H A P T E R 3 .	M A I N T E N A N C E	14
S e c t i o n I .	O p e r a t o r ' s m a i n t e n a n c e	14
	S c o p e o f o p e r a t o r ' s m a i n t e n a n c e	12 14
	O p e r a t o r ' s p r e v e n t i v e m a i n t e n a n c e	13 14
	O p e r a t o r ' s v i s u a l i n s p e c t i o n	14 14
I I .	O r g a n i z a t i o n a l a n d f i e l d m a i n t e n a n c e (t h i r d e c h e l o n)	17
	S c o p e o f o r g a n i z a t i o n a l m a i n t e n a n c e	15 17
	T o o l s , m a t e r i a l s , a n d t e s t e q u i p m e n t r e q u i r e d	16 17
	O r g a n i z a t i o n a l p r e v e n t i v e m a i n t e n a n c e	17 17
	T r o u b l e s h o o t i n g	18 17
	R e p a i r o f r f c a b l e (t h i r d e c h e l o n)	19 17
C h a p t e r 4 .	T H E O R Y	19
	A n t e n n a t h e o r y	20 19
	T h e o r y o f a n t e n n a a s s e m b l y	21 19

This reprint includes all changes in effect at the time of publication; changes 3, 5, and 6.

	Paragraph	Page
CHAPTER 5 . SHIPMENT, LIMITED STORAGE, AND DEMOLITION TO PREVENT ENEMY USE		2 1
Section I. Shipment and limited storage		2 1
Disassembly	2 2	2 1
Repacking for shipment or limited storage.	2 3	2 1
II. Demolition of material to prevent enemy use .		2 1
Authority for demolition	2 4	2 1
Methods of destruction	2 5	2 1
APPENDIX		
I. REFERENCE		2 2
II. BASIC ISSUE ITEMS LIST.		2 3
III. MAINTENANCE ALLOCATION CHART		2 5

Changes in force: C 3, C 5, C 6 and C 7

TM 11-5820-467-15
C7

CHANGE }
No. 7 }

HEADQUARTERS
DEPARTMENT OF THE ARMY
Washington, DC, 1 July 1989

**Operator's, Organizational, Direct Support,
General Support, and Depot Maintenance Manual**
ANTENNA GROUP AN/GRA-50
(NSN 5985-00-892-0758)

TM 11-5820-467-15, 19 July 1961, is changed as follows:

Inside front cover. After the inside front cover, add the following warning and first aid safety steps.

FIXED OPERATION WITH LONG RANGE ANTENNAS WARNING

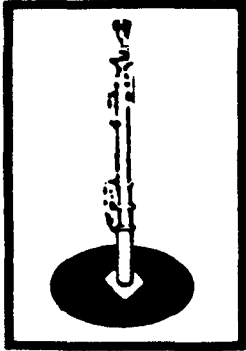

**TELESCOPING
ANTENNA MAST**

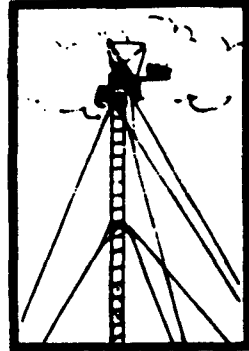

TYPICAL TOWER

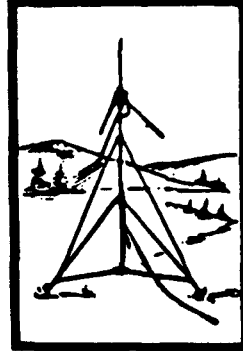

**EXTENDED RANGE
ANTENNA**



DOUBLET ANTENNA

NEVER ERECT THESE LONG RANGE ANTENNAS DIRECTLY UNDER POWERLINES.

IF YOU MUST ERECT THESE LONG RANGE ANTENNAS NEAR POWERLINES, POWERLINE POLES OR TOWERS, OR BUILDINGS WITH OVERHEAD POWERLINE CONNECTIONS, NEVER PUT THE ANTENNA CLOSER THAN TWO TIMES THE ANTENNA HEIGHT FROM THE BASE OF THE POWERLINE, POLE, TOWER OR BUILDINGS.

NEVER ATTEMPT TO ERECT ANY LONG RANGE ANTENNA WITHOUT A FULL TEAM.

BEFORE ERECTING ANY LONG RANGE ANTENNA, INSPECT ALL THE PARTS MAKING UP THE ANTENNA KIT. DO NOT ERECT THE ANTENNA IF ANY PARTS ARE MISSING OR DAMAGED.

DO AS MUCH OF THE ASSEMBLY WORK AS POSSIBLE ON THE GROUND.

WHEN ERECTING THE ANTENNA, ALLOW ONLY TEAM PERSONNEL IN THE ERECTION AREA.

MAKE SURE THAT THE AREA FOR THE ANCHORS IS FIRM. IF THE GROUND IS MARSHY OR SANDY, GET SPECIFIC INSTRUCTIONS FROM YOUR CREW CHIEF OR SUPERVISOR ON HOW TO REINFORCE THE ANCHORS.

WHEN SELECTING LOCATIONS FOR ANCHORS, AVOID TRAVELED AREAS AND ROADS. IF YOU CANNOT AVOID THESE AREAS, GET SPECIFIC INSTRUCTIONS FROM YOUR SUPERVISOR AS TO WHAT CLEARANCE YOUR GUY WIRES AND ROPES MUST HAVE OVER THE TRAVELED AREAS AND ROAD.

CLEARLY MARK ALL GUY WIRES AND ROPES WITH THE WARNING FLAGS OR SIGNS SUPPLIED BY YOUR UNIT. IN AN EMERGENCY, USE STRIPS OF WHITE CLOTH AS WARNING STREAMERS.

IF YOU SUSPECT THAT POWERLINES HAVE MADE ACCIDENTAL CONTACT WITH YOUR ANTENNA, STOP OPERATING, ROPE OFF THE ANTENNA AREA, AND NOTIFY YOUR SUPERIORS.

IF THE WEATHER IN YOUR AREA CAN CAUSE ICE TO FORM ON YOUR LONG RANGE ANTENNA AND ITS GUY WIRES AND ROPES, ADD EXTRA GUYS TO SUPPORT THE SYSTEM. ROPE OFF THE AREA AND POST IT WITH WARNING SIGNS LIKE "BEWARE OF FALLING ICE."

DO NOT TRY TO ERECT ANY ANTENNA DURING AN ELECTRICAL STORM.

KEEP A SHARP EYE ON YOUR ANCHORS AND GUYS. CHECK THEM DAILY AND IMMEDIATELY BEFORE AND AFTER BAD WEATHER.



5

SAFETY STEPS TO FOLLOW IF SOMEONE IS THE VICTIM OF ELECTRICAL SHOCK

1

DO NOT TRY TO PULL OR GRAB THE INDIVIDUAL

2

IF POSSIBLE, TURN OFF THE ELECTRICAL POWER

3

IF YOU CANNOT TURN OFF THE ELECTRICAL POWER, PULL, PUSH, OR LIFT THE PERSON TO SAFETY USING A DRY WOODEN POLE OR A DRY ROPE OR SOME OTHER INSULATING MATERIAL

4

SEND FOR HELP AS SOON AS POSSIBLE

5

AFTER THE INJURED PERSON IS FREE OF CONTACT WITH THE SOURCE OF ELECTRICAL SHOCK, MOVE THE PERSON A SHORT DISTANCE AWAY AND IMMEDIATELY START ARTIFICIAL RESUSCITATION

Page 5. Paragraph 1.1 is superseded as follows:

1.1. Consolidated Index of Army Publications and Blank Forms

Refer to the latest issue of DA Pam 25-30 to determine whether there are new editions, changes or additional publications pertaining to the equipment.

Page 5. Paragraph 2 is superseded as follows:

2. Maintenance Forms, Records and Reports

a. Reports of Maintenance and Unsatisfactory Equipment. Department of the Army forms and procedures used for equipment maintenance will be those prescribed by DA Pam 738-750 as contained in Maintenance Management Update.

b. Report of Item and Packaging Deficiencies. Fill out and forward SF 364 (Report of Discrepancy [ROD]) as prescribed in AR 735-11-2/DLAR 4140.55/SECNAVINST 4355.73B/AFR 400-54/MCO 4430.3J.

c. Transportation Discrepancy Report (TDR) (SF 361). Fill out and forward Transportation Discrepancy Report (TDR) (SF 361) as prescribed in AR 55-38/NAVSUPINST 4610.33C/AFR 75-18/MCO P4610.19D/DLAR 4500.15.

Page 5. Paragraph 2.1 is superseded as follows:

2.1 Reporting Errors and Recommending Improvements

You can help improve this manual. If you find any mistakes or if you know of a way to improve the procedures, please let us know. Mail your letter, DA Form 2028 (Recommended Changes to Publications and Blank Forms), or DA Form 2028-2 located in back of this manual direct to: Commander, US Army Communications-Electronics Command and Fort Monmouth, ATTN: AMSEL-LC-ME-PS, Fort Monmouth, New Jersey 07703-5000.

In either case, a reply will be furnished direct to you.

Page 5. Paragraph 2.3 is superseded as follows:

2.3 Destruction of Army Electronics Material

Destruction of Army electronics material to prevent enemy use shall be in accordance with TM 750-244-2.

Page 5. Paragraph 2.4 is superseded as follows:

2.4 Reporting Equipment Improvement Recommendations (EIR)

If your AN/GRA-50 needs improvement, let us know. Send us an EIR. You, the user, are the only one who can tell us what you don't like about your equipment. Let us know why you don't like the design or performance. Put it on an SF 368 (Product Quality Deficiency Report). Mail it to: Commander, US Army Communications-Electronics Command and Fort Monmouth, ATTN: AMSEL-PA-MA-D, Fort Monmouth, New Jersey 07703-5000. We'll send you a reply.

Page 9. The following note is added after paragraph llb(3):

NOTE

To determine the correct length of antenna wire that is required to obtain the desired corresponding frequency, use the following formula:

$$L (\text{Ant. wire}) = \frac{468}{f(\text{mHz})}$$

This formula should be imprinted on the case of the tape measure as a ready reference and convenience to installation personnel.

Page 14. Paragraph 13.2 is superseded as follows:

13.2. Operator's Daily Preventive Maintenance Checks and Services

B - BEFORE

A - AFTER

W - WEEKLY

ITEM NO.	INTERVAL			ITEM	ITEM TO BE INSPECTED PROCEDURE	EQUIPMENT IS NOT READY/AVAILABLE IF:
	B	A	W			
1	●			Antenna Assembly	Inspect the antenna assembly for completeness (App. II)	
2			●	Antenna Assembly	Inspect the antenna assembly for cleanliness (para. 13.3)	
3			●	RF Cable	Inspect the rf cable for cuts, breaks, and undue strain (fig. 1).	RF cable lacks continuity.
4	●			Antenna Assembly	Check the antenna assembly for normal operation when connected to a transmitter or receiver.	Weak or no transmission or reception.

APPENDIX I REFERENCES

Following is a list of applicable references that are available to the operator and unit repairman of Antenna Group AN/GRA-50.

DA Pam 25-30	Consolidated Index of Army Publications and Blank Forms.
DA Pam 738-750	The Army Maintenance Management System (TAMMS).
TM 11-5820-295-10	Operator's Manual for Radio Set AN/GRC-19 (NSN 5820-00-030-0155).
TM 11-5820-295-20	Organizational Maintenance for Radio Set AN/GRC-19 5820-00-030-0155).
TM 11-5820-467-24P	Organizational, Direct Support and General Support Maintenance Repair Parts and Special Tools Lists (Including Depot Maintenance Repair Parts and Special Tools) for Antenna Group AN/GRA-50 (NSN 5985-00-892-0758).
TM 43-0139	Painting Instructions for Field Use.
TM 750-244-2	Procedures for Destruction of Electronics Material to Prevent Enemy Use (Electronics Command).

By Order of the Secretary of the Army:

Official:

CARL E. VUONO
General, United States Army
Chief of Staff

WILLIAM J. MEEHAN II
Brigadier General, United States Army
The Adjutant General

DISTRIBUTION:

**To be distributed in accordance with DA Form 12-51 Operator, Unit,
and DS/GS requirements for AN/GRA-50.**

CHANGE }
No. 6 }

HEADQUARTERS
DEPARTMENT OF THE ARMY
WASHINGTON, DC, 9 September 1977

**Operator's, Organizational, Direct Support,
General Support, and Depot Maintenance Manual
ANTENNA GROUP AN/GRA-50
(NSN 5985-00-892-0758)**

TM 11-5820-467-15, 19 July 1961, is changed as follows:
The title is changed as shown above.

Page 5. Paragraph 2 is superseded as follows:

2. Forms and Records

a. Reports of Maintenance and Unsatisfactory Equipment. Maintenance forms, records, and reports which are to be used by maintenance personnel at all maintenance levels are listed in and prescribed by TM 38-750.

b. Report of Packaging and Handling Deficiencies. Fill out and forward DD Form 6 (Packaging Improvement Report) as prescribed in AR 700-58/NAVSUPINST 4030.29/AFR 71-13/MCO P4030.29A, and DSAR 4145.8.

c. Discrepancy in Shipment Report (DISREP) (SF 361). Fill out and forward Discrepancy in Shipment Report (DISREP) (SF 361) as prescribed in AR 55-38/NAVSUPINST 4610.33A/AFR 75-18/MCO P4610.19B and DSAR 4500.15.

Paragraph 2.4 is added after paragraph 2.3.

2-4. Reporting Equipment Improvement Recommendations (EIR)

EIR's will be prepared using DA Form 2407 (Maintenance Request). Instructions for preparing EIR's are provided in TM 38-750, The Army Maintenance Management System. EIR's should be mailed direct to Commander, US Army Electronics Command, ATTN: DRSEL-MA-Q, Fort Monmouth, NJ 07703. A reply will be furnished direct to you.

Paragraph 3b, line 7, change "100 watts" to read "500W."

Paragraph 4, line 4, change "100 watts" to read "500 W."

Page 25. Appendix III is superseded as follows:

**APPENDIX III
MAINTENANCE ALLOCATION**

Section 1. INTRODUCTION

1. General

This appendix provides a summary of the maintenance operations for AN/GRA-50. It authorizes categories of maintenance for specific maintenance functions on repairable items and components and the tools and equipment required to perform each function. This appendix may be used as an aid in planning maintenance operations.

2. Maintenance Function

Maintenance functions will be limited to and defined as follows:

a. Inspect. To determine the serviceability of an item by comparing its physical, mechanical, and/or electrical characteristics with established standards through examination.

b. Test. To verify serviceability and to detect incipient failure by measuring the mechanical or electrical characteristics of an item and comparing those characteristics with prescribed standards.

c. Service. Operations required periodically to keep an item in proper operating condition, i.e., to clean (decontaminate), to preserve, to drain, to paint, or to replenish fuel, lubricants, hydraulic fluids, or compressed air supplies.

d. Adjust. To maintain, within prescribed limits, by bringing into proper or exact position, or by setting the operating characteristics to the specified parameters.

e. Align. To adjust specified variable elements of an item to bring about optimum or desired performance.

f. Calibrate. To determine and cause corrections to be made or to be adjusted on instruments or test measuring and diagnostic equipments used in precision measurement. Consists of comparisons of two instruments, one of which is a certified standard of known accuracy, to detect and adjust any discrepancy in the accuracy of the instrument being compared.

g. Install. The act of emplacing, seating, or fixing into position an item, part, module (component or assembly) in a manner to allow the proper functioning of the equipment or system.

h. Replace. The act of substituting a serviceable like type part, subassembly, or module (component or assembly) for an unserviceable counterpart.

i. Repair. The application of maintenance services (inspect, test, service, adjust, align, calibrate, replace) or other maintenance actions (welding, grinding, riveting, straightening, facing, remachining, or resurfacing) to restore serviceability to an item by correcting specific damage, fault, malfunction, or failure in a part, subassembly, module (component or assembly), end item, or system. This function does not include the trial and error replacement of running spare type items such as fuses, lamps, or electron tubes.

j. Overhaul. That maintenance effort (service/action) necessary to restore an item to a completely serviceable/operational condition as prescribed by maintenance standards (i.e., DMWR) in appropriate technical publications. Overhaul is normally the highest degree of maintenance performed by the Army. Overhaul does not normally return an item to like new condition.

k. Rebuild. Consists of those services/actions necessary for the restoration of unserviceable equipment to a like new condition in accordance with original manufacturing standards. Rebuild is the highest degree of materiel maintenance applied to Army equipment. The rebuild operation includes the act of returning to zero there age measurements (hours, miles, etc.) considered in classifying Army equipments/components.

3. Column Entries

a. Column 1, Group Number. Column 1 lists group numbers, the purpose of which is to identify components, assemblies, subassemblies, and modules with the next higher assembly.

b. Column 2, Component/Assembly. Column 2 contains the noun names of components, assemblies, subassemblies, and modules for which maintenance is authorized.

c. Column 3, Maintenance Functions. Column 3 lists the functions to be performed on the item listed in column 2. When items are listed without maintenance functions, it is solely for purpose of having the group numbers in the MAC and RPSTL coincide.

d. Column 4, Maintenance Category. Column 4 Specifies, by the listing of a "work time" figure in the appropriate subcolumn(s), the lowest level of maintenance authorized to perform the function listed in column 3. This figure represents the active time required to perform that maintenance function at the indicated category of maintenance. If the number or complexity of the tasks within the listed maintenance function vary at different maintenance categories, appropriate "work time" figures will be shown for each category. The number of task-hours specified by the "work time" figure represents the average time required to restore an item (assembly, subassembly, component, module, end item or system) to a serviceable condition under typical field operating conditions. This time includes preparation time, troubleshooting

time, and quality assurance/quality control time in addition to the time required to perform the specific tasks identified for the maintenance functions authorized in the maintenance allocation chart. Subcolumns of column 4 are as follows:

- C - Operator/Crew
- O - Organizational
- F - Direct Support
- H - General Support
- D - Depot

e. Column 5, Tools and Equipment. Column 5 specifies by code, those common tool sets (not individual tools) and special tools, test, and support equipment required to perform the designated function.

f. Column 6, Remarks. Column 6 contains an alphabetic code which leads to the remark in section IV, Remarks, which is pertinent to the item opposite the particular code.

4. Tool and Test Equipment Requirements (Sect. III)

a. Tool or Test Equipment Reference Code. The numbers in this column coincide with the

numbers used in the tools and equipment column of the MAC. The numbers indicate the applicable tool or test equipment for the maintenance functions.

b. Maintenance Category. The codes in this column indicate the maintenance category allocated the tool or test equipment.

c. Nomenclature. This column lists the noun name and nomenclature of the tools and test equipment required to perform the maintenance functions.

d. National/NATO Stock Number. This column lists the National/NATO stock number of the specific tool or test equipment.

e. Tool Number. This column lists the manufacturer's part number of the tool followed by the Federal Supply Code for manufacturers (5-digit) in parentheses.

5. Remarks (Sect. IV)

a. Reference Code. This code refers to the appropriate item in section II, column 6.

b. Remarks. This column provides the required explanatory information necessary to clarify items appearing in section II.

SECTION II MAINTENANCE ALLOCATION CHART
FOR

ANTENNA GROUP AN/GRA-50

(1) GROUP NUMBER	(2) COMPONENT/ASSEMBLY	(3) MAINTENANCE FUNCTION	(4) MAINTENANCE CATEGORY					(5) TOOLS AND EQPT.	(6) REMARKS
			C	O	F	H	D		
00	ANTENNA GROUP AN/GRA-	Inspect Service Test Replace Repair	0.1 0.2	0.2 0.2	0.2			1,2 1,2 3,4	A A B C D

SECTION III. TOOL AND TEST EQUIPMENT REQUI
FOR

ANTENNA GROUP AN/GRA-50

DOL OR TEST EQUI REF CODE	MAINTENANCE CATEGORY	NOMENCLATURE	NATIONAL/NATO STOCK NUMBER	TOOL NUMBER
1	O	MULTIMETER AN/UFM-105	6625	
2	O	TOOL KIT, ELECTRONIC EQUIPMENT TK-101/G	5180-00-064-5178	
3	F	TOOL KIT, ELECTRONIC EQUIPMENT TK-105/G	5180-00-610-8177	
4	F	MULTIMETER TS-352/U	6625-00-242-5023	

SECTION IV. REMARKS

ANTENNA GROUP AN/GRA-50

REFERENCE CODE	REMARKS
A	Preventive maintenance.
B	Continuity and leakage tests of cable CG-678/U.
C	Replace components.
D	Repair of RF cable assembly.

By Order of the Secretary of the Army:

BERNARD W. ROGERS
General, United States Army
Chief of Staff

Official:

J.C. PENNINGTON
Brigadier General, United States Army
The Adjutant General

Distribution:

To be distributed in accordance with DA Form 12-51, Operator TM literature requirements for AN/GRA-50.

Change }
No. 5 }

**Operator's Organizational, Direct Support,
General Support, and Depot Maintenance Manual
ANTENNA GROUP AN/GRA-50**

TM 11-5820-467-15, 19 July 1961, is changed as follows:

The title of the manual is changed as shown above.

Page 5. Paragraph 1.1 is superseded by the following:

1.1. Indexes of Publications

a. *DA Pam 310-4*. Refer to the latest issue of DA Pam 310-4 to determine whether there are new editions, changes, or additional publications pertaining to the equipment.

b. *DA Pam 310-7*. Refer to DA Pam 310-7 to determine whether there are modification work orders (MWO's) pertaining to the equipment.

Paragraph 2 is superseded by the following:

2. Forms and Records

a. *Reports of Maintenance and Unsatisfactory Equipment*. Maintenance forms, records, and reports which are to be used by maintenance personnel at all maintenance levels are listed in and prescribed by TM 38-750.

b. *Report of Packaging and Handling Deficiencies*. Fill out and forward DD Form 6 (Report of Packaging and Handling Deficiencies) as prescribed in AR 700-58 (Army)/NAVSUP PUB 378 (Navy)/AFR 71-4 (Air Force)/and MCO P4030.29 (Marine Corps).

c. *Discrepancy in Shipment Report (DISREP) (SF 361)*. Fill out and forward Discrepancy in Shipment Report (DISREP) (SF 361) as prescribed in AR 55-38 (Army)/NAVSUP

PUB 459 (Navy)/AFM 75-34 (Air Force)/and MCO P4610.19 (Marine Corps).

Paragraph 2.1 is added as follows:

2.1. Reporting of Errors

The reporting of errors, omissions, and recommendations for improving this publication by the individual user is encouraged. Reports should be submitted on DA Form 2028, Recommended Changes to Publications, and forwarded direct to Commander, US Army Electronics Command, ATTN: AMSEL-MA-CR, Fort Monmouth, NJ 07703.

2.2. Administrative Storage

For procedures, forms and records, and inspection required for equipment in administrative storage, refer to TM 740-90-1.

2.3. Destruction of Army Materiel to Prevent Enemy Use

For information on this subject, refer to TM 750-244-2.

Paragraph 4, lines 3, 4, and 5. Delete and substitute:

Power handling capability
200 watts, average
(maximum).

Page 6, paragraph 5. Change the heading of paragraph 5 to read:

Components and Dimensions

Add paragraph 5.1 after paragraph 5.

•This Change supersedes C 4, 27 June 1972.

5.1. Items Comprising and Operable Antenna Group AN/GRA-50 (FSN 5985-892-0758).

<i>FSN</i>	<i>Qty</i>	<i>Nomenclature</i>
5995-823-2176	1	Cable Assembly RF CG-678/U (75 ft 3 in.) uses cable RG-58A/U, connector UG- 536/U ea end. (Not in- stalled)
5985-893-1438	2	Halyard MX-2706/G
5970-405-8223	1	Insulator IL-4GRA-4 (Not installed)
5895-896-3179	2	Reeling Machine Cable, Hand RC-432/G (Not installed)
5985-757-2130	2	Wire Assembly, Antenna CX-7303/G (160 ft 0 in.). Note: Stored and used with (but not p/o) Reel RC-432/G (Not installed)

Page 8. Paragraph 9b is superseded by the following:

b. See that the equipment is complete as listed on the packing slip. If a packing slip is not available, check the equipment against paragraph 5 and appendix II.

Page 9, paragraph 11a (2). Add the following data to the chart:

<i>Frequency (mc)</i>	<i>Length of each antenna wire a (ft)</i>
21	11.27
22	10.63
23	10.25
24	9.72
25	9.35
26	9.00
27	8.75
28	8.35
29	8.00
30	7.80

Page 14, paragraph 13.3. Delete the warning notice and substitute the following:

WARNING

The fumes of cleaning compound, Trichloroethane (FSN 6810-292-9625, 1 qt) are toxic. Provide enough ventilation whenever used. Do not use near an open flame. Trichloroethane is not flammable, but exposure to an open flame converts the fumes to a highly toxic and dangerous gas.

Page 17, paragraph 16b(1). Paragraph 16b(1) is superseded by the following:

(1) Cleaning compound, Trichloroethane (FSN 6810-292-9625; (1 qt)). Observe the warning in paragraph 13.3.

Page 22, appendix I. Make the following changes:

Change the title of DA Pam 310-4 to read: Index of Technical Manuals, Technical Bulletins, Supply Manuals (types 7, 8, and 9), Supply Bulletins, and Lubrication Orders.

Change the title of TM 38-750 to read: The Army Maintenance Management System (TAMMS).

Add the following:

TM 740-90-1	Administrative Storage of Equipment,
TM 750-244-2	Procedures for Destruction of Electronics Materiel to Prevent Enemy Use (Electronics Command).
DA Pam 310-7	U.S. Army Equipment Index of Modification Work Orders.

Page 23. Appendix II is superseded by the following:

APPENDIX II

BASIC LIST ITEMS LIST (BIIL) AND ITEMS TROOP INSTALLED OR AUTHORIZED LIST (ITAL)

Section I. INTRODUCTION

1. Scope.

This appendix lists basic issue items and items troop installed or authorized required by the crew/operator for installation, operations, and maintenance of Antenna Group AN/GRA-50.

2. General

This Basic Issue Items and Items Troop Installed or Authorized List is divided into the following sections:

a. Basic Issue Items List - Section II. A list, in alphabetical sequence, of items which are furnished with, and which must be turned in with the end item.

b. Items Troop Installed or Authorized List - Section III. A List, in alphabetical sequence of items which, at the discretion of the unit commander, may accompany the end item, but are not subject to be turned in with the end item.

3. Explanation of Columns.

The following provides an explanation of columns found in the tabular listings:

a. Illustration. This column is divided as follows:

(1) *Figure number.* Indicates the figure number of the illustration in which the item is shown.

(2) *Item number.* Not applicable.

b. Federal Stock Number. Indicates the Federal stock number assigned to the item and will be used for requisitioning purposes.

c. Part Number. Indicates the primary number used by the manufacturer (individual, company, firm, corporation, or Government activity), which controls the design and characteristics of the item by means of its engineering drawings, specifications standards, and inspection requirements, to identify an item or range of items.

d. Federal Supply Code for Manufacturer (FSCM). The FSCM is a 5-digit numeric code to identify the manufacturer, distributor, or Government agency, etc., and is identified in SB 708-42.

e. Description. Indicates the Federal item name and a minimum description required to identify the item.

f. Unit of Measure (U/M). Indicates the standard of basic quantity of the listed item as used in performing the actual maintenance function. This measure is expressed by a two-character alphabetical abbreviation, (e.g., ea, in, pr, etc). When the unit of measure differs from the unit of issue, the lowest unit of issue that will satisfy the required units of measure will be requisitioned.

g. Quantity Furnished with Equipment (Basic Issue Items Only). Indicates the quantity of the basic issue item furnished with the equipment.

h. Quantity Authorized (Items Troop Installed or Authorized Only). Indicates the quantity of the item authorized to be used with the equipment.

Section II. BASIC ISSUE ITEMS LIST

(1) Illustration		(2) Federal stock number	(3) Part number	(4) FSCM	(5) Description Usable on code	(6) Unit of meas	(7) Qty furn with equip
(A) Fig. no.	(B) Item no.						
1		6115-498-3973			BAG, BG-175, F/STORAGE OF ANT. AND COMPONENTS IN USE. (NOT INSTALLED)	EA	1

Section III. ITEMS TROOP INSTALLED OR AUTHORIZED LIST

(1) Federal stock number	(2) Part number	(3) FSCM	(4) Description Usable on code	(5) Unit of meas	(6) Qty auth
5210-897-6077	859-501	03833	TAPE, MEASURING, FEET AND INCHES, MARKED IN FREQ REVERSE SIDE, F/SETTING up ant., (NOT INSTALLED)	ea	1

By Order of the Secretary of the Army:

Official:

VERNE L. BOWERS

*Major General, United States Army
The Adjutant General*

CREIGHTON W. ABRAMS
*General, United States Army
Chief of Staff*

Distribution:

To be distributed in accordance with DA Form 12-51 (qty rqr block No. 45), Operator requirements for AN/GRA-50.

Operator, Organizational, Field and Depot Maintenance Manual
ANTENNA GROUP AN/GRA-50

CHANGE
No. 3

HEADQUARTERS
DEPARTMENT OF THE ARMY
WASHINGTON, D.C., 28 April 1984

TM 11-5820-467-15, 19 July 1961, is changed as follows:

Page 5 (as changed by C 2, 4 Sep 63). Make the following changes:

Add paragraph 1.1 after paragraph 1.

1.1. Index of Publications

Refer to the latest issue of DA Pam 310-4 to determine whether there are new editions, changes, or additional publications pertaining to the equipment. DA Pam 310-4 is an index of current technical manuals, technical bulletins, supply manuals, supply bulletins, lubrication orders, and modification work orders available through publications supply channels. The index lists the individual parts (-10, -20, -35P, etc.) and the latest changes to and revisions of each equipment publication.

Delete paragraph 2 and substitute:

2. Forms and Records

a. Reports of Maintenance and Unsatisfactory Equipment. Use equipment forms and records in accordance with instructions in TM 38-750.

b. Report of Damaged or Improper Shipment. Fill out and forward DD Form 6 (Report of Damaged or Improper Shipment) as prescribed in AR 700-58 (Army) NAVASANDA Publication 378 (Navy), and AFR 71-4 (Air Force).

c. Reporting of Equipment Manual Improvements. The direct reporting, by the individual user, of errors, omissions, and recommendations for improving this manual, is authorized and encouraged. DA Form 2028 (Recommended Changes to DA Technical Manual Parts Lists or Supply Manual 7, 8, or 9) will be used for reporting these improvements. This form will be completed in triplicate using pencil, pen, or typewriter. The original and one copy will be forwarded direct to Commanding Officer, U. S. Army Electronics

Materiel Support Agency, ATTN: SELMS-MP, Fort Monmouth, N. J. 07703. One information copy will be furnished to the individual's immediate supervisor (officer, noncommissioned officer supervisor, etc.).

Page 8. Delete paragraph 9 and substitute:

9. Checking Unpacked Equipment

a. Inspect the equipment for damage incurred during shipment. If the equipment has been damaged, report the damage on DD Form 6 (para. 2).

b. See that the equipment is complete as listed on the packing slip. If a packing slip is not available, check the equipment against the basic issue items list (app. II). Report all discrepancies in accordance with TM 38-750. Shortage of a minor assembly or part that does not affect proper functioning of the equipment should not prevent use of the equipment.

Page 9, paragraph 11b(9). Make the following changes:

Add the following after the last sentence:

Place the antenna as high as possible.

Caution. line 2. Change "6" to: 24.

Page 14 (as changed by C 2, 4 Sep 63). Delete paragraph 13 and substitute:

13. Operator's Preventive Maintenance

Preventive maintenance is the systematic care, servicing, and inspection of equipment to prevent the occurrence of trouble, to reduce downtime, and to assure that the equipment is serviceable.

a. Systematic Care. The procedures given in paragraphs 13.1 and 13.2 cover routine systematic care and cleaning essential to proper up keep and operation of the equipment.

* This change supercedes C 2, 4 September 1963.

b. Preventive Maintenance Checks and Services. The preventive maintenance checks and services chart (para. 13.2) outlines functions to be performed at specific intervals. These checks and services are to maintain Army electronic equipment in a combat serviceable condition; that is, in good general (physical) condition and in good operating condition. To assist operators in maintaining combat serviceability, the chart indicates what to check, how to check, and what the normal conditions are. The References column lists the illustrations, paragraphs, or manuals that contain detailed repair or replacement procedures. If the defect cannot be remedied by the operator, higher echelon maintenance or repair is required. Records and reports of these checks and services must be made in accordance with the requirements

set forth in TM 38-750.

Add paragraphs 13.1, 13.2, and 13.3 after paragraph 13.

13.1. Operator's Preventive Maintenance Checks and Services Periods

Preventive maintenance checks and services on the AN/GRA-50 are required on a daily basis. Paragraph 13.2 specifies services and inspections that must be accomplished daily and under special conditions listed below.

- a. When the antenna is initially installed.
- b. When the antenna is reinstalled after being taken down for any reason.
- c. At least once each week if the antenna is maintained in standby condition.

13.2. Operator's Daily Preventive Maintenance Checks and Services

Sequence No.	Item	Procedure	References
1	Completeness.....	Inspect the antenna assembly for completeness.....	App. II.
2	Cleanliness.....	Inspect the antenna assembly for cleanliness.....	Para. 13.3.
3	Rf cable.....	Inspect the rf cable for cuts, breaks, and undue strain.	Fig. 1.
4	Operational test.....	Check the antenna assembly for normal operation when connected to a transmitter.	Fig. 1.

13.3. Cleaning

Inspect all components. They must be free of dirt, grease, and fungus.

Warning: Cleaning Compound (Federal stock No. 7930-395-9542) is flammable and its fumes are toxic. Do not use near a flame; provide adequate ventilation.

a. Remove grease and fungus from the antenna assembly. Use a cloth dampened (not wet) with cleaning compound.

b. Remove dirt from components with a brush.

Add paragraph 14.1 after paragraph 14.

14.1. Replacing Broken Wire Ends

If the looped end of one of the wires (shown under the outer wingnuts in fig. 5) breaks off, replace it as follows:

a. Loosen the wingnut and remove the broken loop.

b. Unwind all the wire from the reel assembly.

c. Remove the outer wingnut from the reel assembly (fig. 6) and slip off the looped end.

d. Slip the loop under the wingnut (a above) and tighten the nut.

e. Starting with the broken end, rewind the wire onto the reel assembly.

Page 15 (as changed by C 2, 4 Sep 63). Delete figure 8.

Page 16 (as changed by C 2, 4 Sep 63). Delete figure 9.

Page 17 (as changed by C 2, 4 Sep 63). Delete paragraph 17 and substitute:

17. Organizational Preventive Maintenance

a. Preventive maintenance is the systematic care, inspection, and servicing of equipment to maintain it in serviceable condition, prevent breakdowns, and assure maximum operational capability. Preventive maintenance is the responsibility of all echelons concerned with the antenna assembly and includes the inspection, testing, and repair or replacement of components that inspection and tests indicate probably would fail before the next scheduled periodic service. Preventive maintenance checks and services on the antenna assembly at the second echelon level are made at monthly intervals unless otherwise directed by the commanding officer.

b. Maintenance forms and records to be used and maintained on the antenna assembly are specified in TM 38-750.

Add paragraphs 17.1 and 17.2 after paragraph 17.

17.1. Monthly Maintenance

Perform the maintenance functions indicated

17.2. Monthly Preventive Maintenance Checks and Services Chart

Sequence No.	Item	Procedure	References
1	Publications.....	See that all publications are complete, serviceable, and current.	DA Pam 310-4.
2	Modifications.....	Determine whether applicable MWO's have been published. All URGENT MWO's must be applied immediately; all NORMAL MWO's must be scheduled.	DA Pam 310-4 and TM 38-750.
3	Preservation.....	Lower the antenna assembly and check all surfaces for rust and corrosion. Remove rust and corrosion with #000 sandpaper and paint bare spots.	TM 9-213.
4	Reel assembly.....	Check the reel assemblies for smooth operation, and see that the wingnuts are tight.	Fig. 6.
5	Insulator.....	See that the wingnuts and the rf cable on the insulator are tight.	Fig. 5.
6	Canvas items.....	Inspect the canvas items for tears, moisture, and mildew.	Fig. 2.
7	Halyards.....	Inspect halyards for fraying and proper strength...	Fig. 2.

Page 22 (as changed by C 2, 4 Sep 63). Add the following to appendix I:

DA Pam 310-4 Index of Technical Manuals, Technical Bulletins, Supply Manuals (types 4, 6, 7, 8, and 9), Supply Bulletins, Lubrication Orders, and Modification

Work Orders.
 TM 9-213 Painting Instructions for Field use.
 TM 38-750 Army Equipment Record Procedures.

Page 23 (as changed by C 2, 4 Sep 63). Delete appendix II and substitute:

APPENDIX II
BASIC ISSUE ITEM LIST

Section I. INTRODUCTION

1. General

This appendix lists items supplied for initial operation. The list includes tools, parts, and materiel issued as part of the major end item. The list includes all items authorized for basic operator maintenance of the equipment. End items of equipment are issued on the basis of allowance prescribed in equipment authorization tables and other documents that are a basis for requisitioning.

2. Columns

Columns are as follows:

- a. *Federal Stock Number.* This column lists the 11-digit Federal stock number.
- b. *Designation by Model.* Not used.
- c. *Description.* Nomenclature or the standard item name and brief identifying data for each item are listed in this column. When requisitioning, enter the nomenclature and description.

d. *Unit of Issue.* The unit of issue is each, unless otherwise indicated, and is the supply term by which the individual item is counted for procurement, storage, requisitioning, allowances, and issue purposes.

e. *Expendability.* Nonexpendable items are indicated by NX. Expendable items are not noted.

f. *Quantity Authorized.* Under "Items Comprising an Operable Equipment", the column lists the quantity of items supplied for the initial operation of the equipment.

g. *Illustrations.* The numbers in the "Figure No." column refer to the illustrations where the parts are shown.

Section II. FUNCTIONAL PARTS LIST

(1) Source maintenance and recover- ability code	(2) Federal stock No.	(3) Designation by model	(4) Description	(5) Unit of issue	(6) Expend- ability	(7) Quantity au- thorized	(8) (9) Illustrations	
							Figure No.	Item No.
	5985-892-0758		ANTENNA GROUP AN/GRA-50: Provides transmitting and receiving facilities for med power vehicular Radio Set in freq range of 1.5 to 20 mc.			NX	1	
			ITEMS COMPRISING AN OPERABLE EQUIPMENT					
	Ord thru AGC		TECHNICAL MANUAL TM 11-5820-467-15.			2		
	6115-498-3973		BAG BG-175: f/storage of ant and components when not in use. (Not installed.)			1	2	
	5995-823-2176		CABLE ASSEMBLY RF CG-678/U (75 ft 3 in.) uses cable RG-58A/U, connector UG-536/U ea end. (Not installed.)			1	2	
	5985-893-1438		HALYARD MX-2706/G			2	2	
	5970-405-8223		INSULATOR IL-4/GRA-4 (Not installed.)			1	2	
	5895-896-3179		REELING MACHINE, CABLE, HAND RC-432/G (Not installed).			2	2	
	5210-897-6077		TAPE MEASURING: Feet and inches; marked in freq reverse side; f/setting up ant; Arkay No. 859-501 (Not installed).			1	2	
	5985-757-2130		WIRE ASSEMBLY, ANTENNA CX-7303/G (160 ft 0 in.) NOTE: Stored and used with (but not p/o) Reel RC-432/G (Not installed).			2	2	
			RUNNING SPARES AND ACCESSORY ITEMS					
			NO PARTS AUTHORIZED FOR STOCKAGE AT FIRST ECH-ELON.					

By Order of the Secretary of the Army:

EARLE G. WHEELER,
General, United States Army,
Chief of Staff.

Official:

J. C. LAMBERT,
Major General, United States Army,
The Adjutant General.

Distribution:

Active Army:

USASA (2)	Lexington (12), Ft Worth (8)	11-98
CNGB (1)	Tobyhanna (12), Sharpe (3)	11-117
C/COMMEL (7)	Letterkenny (5)	11-155
cofT (1)	Sig Sec, GENDEP (OS) (5)	11-157
CofEngrs (1)	USASCC (4)	11-500
TSG (1)	USA Elct Mat Agcy (9)	(AA-AE) (4)
CofsptS (1)	USASA 1st Fld Sta (5)	11-557
USCONARC (5)	USATC AD (3)	11-587
USAMC (5)	USATC Armor (3)	11-592
USAARMBD (2)	USATC Engr (3)	11-597
USAARTYBD (2)	USATC Inf (3)	17
USAECDA (2)	USASTC (3)	17-100
USACBRCA (1)	WRAMC (1)	19-55
USAMSCDA (2)	Army Pic Cen (2)	19-56
USAOCA (2)	USA Equip Spt Cen (1)	19-57
USAQMCDA (2)	USAERDL (2)	29-1
USATCDA (2)	USA Cold Rgn RE Lab (2)	29-5
USACECDA (1)	Chicago Proc Dist (1)	29-6
USACECDA (Monmouth Ofc) (1)	AMS (1)	29-11
USAADCDA (2)	USATCARC (1)	29-15
USAARMCA (2)	USATCA (1)	29-16
USAAVNCDA (2)	USATCG (1)	29-21
USAARTYCDA (2)	USATCP (1)	29-25
USASWCDA (1)	USAERDLA (White Sands) (13)	29-26
UAECOM (7)	USAELRDL Trp Comd (10)	29-35
USAMICOM (4)	Army Tml (1) except Oakland (5)	29-36
USASMCOM (2)	POE (1)	29-45
ARADCOM (2)	Sig Fld Maint Shops (3)	29-46
ARADCOM Rgn (2)	WSMR (5)	29-51
OS Maj Comd (3)	Units org under fol TOE: (2 copies	29-55
OS Base Comd (2)	each except as indicated)	29-56
LOGCOMD (2)	1-55 5-155 10-105	29-65
MDW (1)	1-75 5-156 10-106	26-75
Armies (2)	1-76 5-157 10-107	29-77
Corps (2)	1-76 5-157 10-107	29-79
USA Corps (3)	1-127 6-501 10-202	30-25
11th Air Assault Div (3)	1-137 7 10-206	37
Instl (2) except Ft Gordon (5)	1-207 7-25 10-445	37-100
Ft Hancock (4), Ft Huachuca (10)	5-25 7-26 10-446	44-235
Ft Monmouth (63)	5-26 7-100 10-500	44-236
Svc Colleges (2)	5-27 8-35 (AA-AD)	44-237
Br Svc Sch (2)	5-112 8-36 11-16	44-500 (AA-AB)
GENDEP (OS) (2)	5-145 8-37 11-57	55-56
Sig Sec. GENDEP (OS) (5)	5-146 8-65 11-85	
Army Dep (2) except Navajo,	5-147 9-22 11-87	
Savanna (5), Sacramento (28)	5-148 10-22 11-97	

NG: State AG (3); units—same as Active Army except allowance is one copy to each unit.

USAR: None.

For explanation of **abbreviations used**, see AR 320-50.

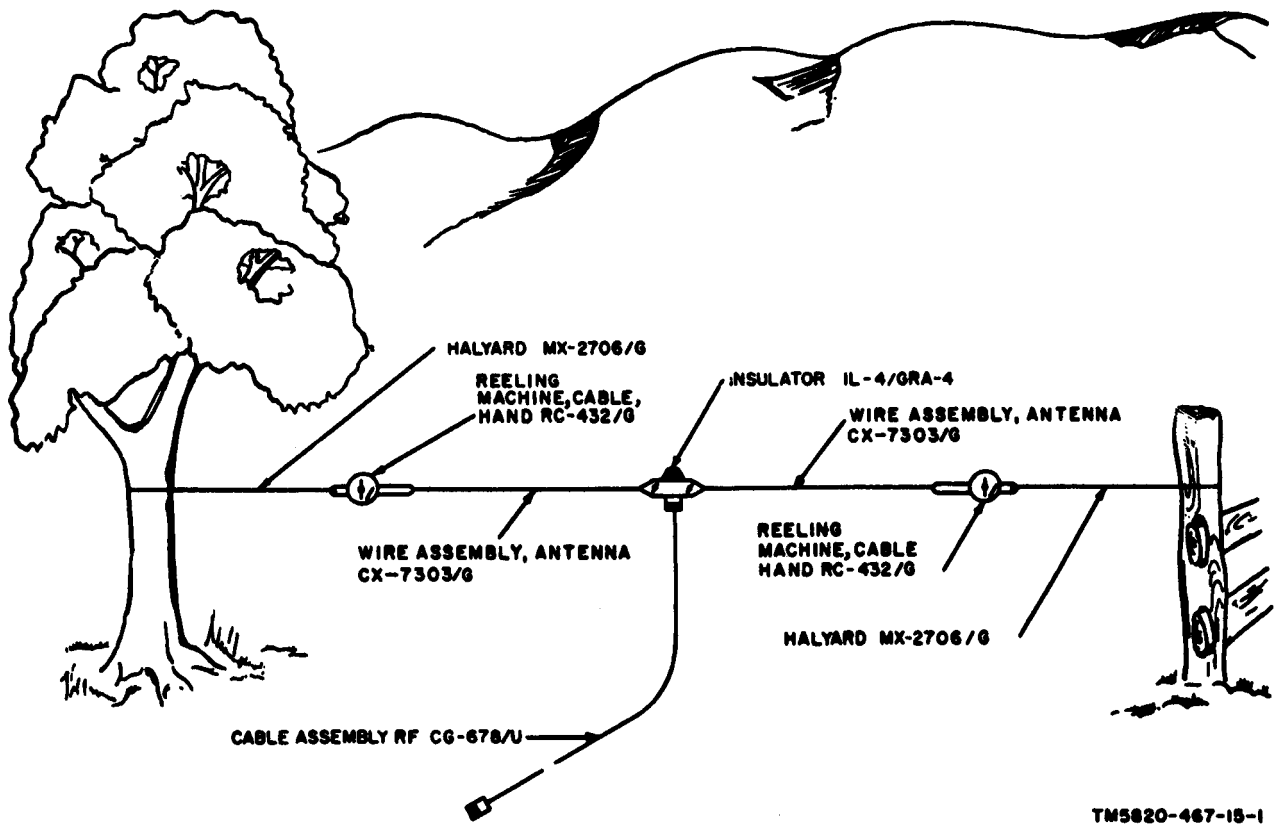

TM5820-467-15-1

Figure 1. Antenna Group AN/GRA-50, typical installation.

CHAPTER 1

INTRODUCTION

Section I. GENERAL

1. Scope

This manual describes Antenna Group AN/GRA-50 (fig. 1) and covers installation, maintenance, and theory of operation.

2. Forms and Records

a. Unsatisfactory Equipment Report.

- (1) Fill out and forward DA Form 468 (Unsatisfactory Equipment Report) to Commanding Officer, U. S. Army Signal Materiel Support Agency, ATTN: SIGMS-ML, Fort Monmouth, N. J., as prescribed in AR 700-38.
- (2) Fill out and forward AF TO Form 29 (Unsatisfactory Report) to the Commander, Air Materiel Command, Wright-Patterson Air Force Base, Ohio, as prescribed in AF TO 00-35D-54.

b. Report of Damaged or Improper Shipment. Fill out and forward DD Form 6

(Report of Damaged or Improper shipment as prescribed in AR 700-58 (Army), Navy Shipping Guide, Article 1850-4 (Navy), and AFR 71-4 (Air Force).

c. Preventive Maintenance Form. Prepare DA Form 11-238 (fig. 8 and 9) (Maintenance Check List for Signal Equipment (Sound Equipment, Radio, Direction Finding, Radar, Carrier, Radiosonde and Television)), in accordance with the instructions on the form.

d. Parts List Form. Forward DA Form 2028 (Recommended Changes to DA Technical Manual Parts Lists or Supply Manual 7, 8, or 9) direct to the Commanding Officer, U. S. Army Signal Materiel Support Agency, ATTN: SIGMS-ML, Fort Monmouth, N. J., with comments on appendixes II and III.

e. Comments on Manual. Forward all other comments on this publication direct to the Commanding Officer, U. S. Army Signal Materiel Support Agency, ATTN: SIGMS-PA2d, Fort Monmouth, N. J.

Section II. DESCRIPTION AND DATA

3. Purpose and Use

a. Purpose. Antenna Group AN/GRA-50 (fig. 1) is a doublet antenna assembly used for the transmission and reception of radio signals between 1.5 and 20 megacycles (mc).

b. Use. Antenna Group AN/GRA-50 is used primarily with Radio Set AN/GRC-19 for greater range and reliability than the standard 15-foot whip antenna provides. It can be used with any radio set that has the

proper frequency range and a transmitter power output of less than 100 watts at an output impedance of approximately 50 ohms.

4. Technical Characteristics

Antenna type Half way doublet.
Frequency range 1.5 to 20 mc.
Power handling
 capability 100 watts (maximum).
Weight 11.75 lb.

5. Components
(fig. 2)

Quantity	Component	Height (in.)	Depth (in.)	Width	Unit weight (lb)
1	Cable Assembly RF CG-678/U			75 ft 3 in. (lg)	2.4
1	Insulator IL-4/GRA-4	2	3-1/2	3-1/2 in.	0.6
2	Reeling Machine, Cable, Hand RC-432/G	2-3/4	4-1/2	12 in.	1
2	Wire Assembly, Antenna CX-7303/G			160 ft (lg)	0.6
1	Bag BG-175	9	8-1/2	9-1/2 in.	2
2	Halyard MX-2706/G		1/8 dia.	75 ft (lg)	1.1
1	Tape, measuring (nonconducting), 156 ft	1-1/4	7	7 in.	2.1
2	Technical Manual TM 11-5820-467-15				

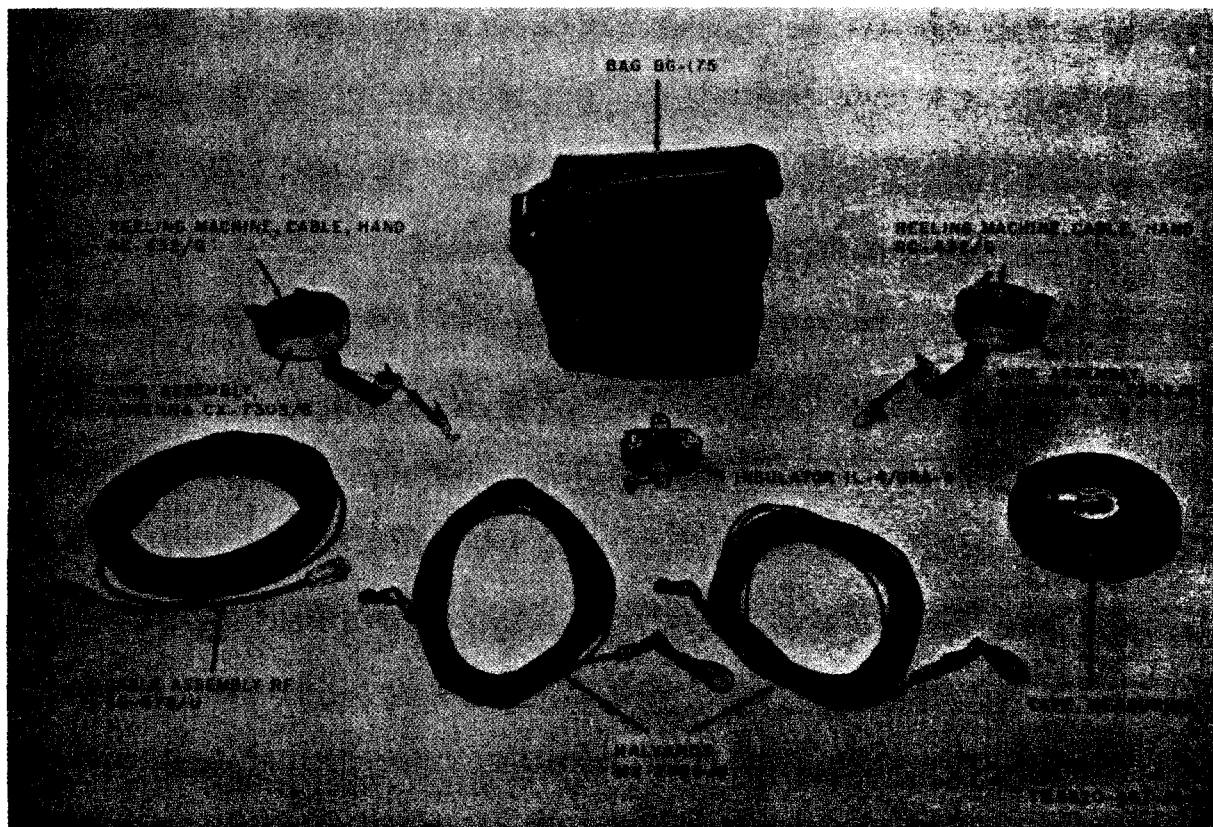

Figure 2. Antenna Group AN/GRA-50, components.

6. Common Names

Nomenclature	Common name
Antenna Group AN/GRA-50	Antenna assembly
Cable Assembly RF CG-678/U	Rf cable
Insulator IL-4/GRA-4	Insulator
Reeling Machine, Cable, Hand	Reel assembly
RC-432/G	
Wire Assembly, Antenna CX-	Antenna wire
7303/G	
Halyard MX-2706/G	Halyard
Tape, measuring (nonconduct-	Tape measure
ing), 156 ft	

7. Description

(fig. 2)

a. Bag BG-175, made of heavy canvas, is used to store all components.

b. Each Reeling Machine, Cable, Hand RC-432/G consists of a reel on which 160 feet of Wire Assembly, Antenna CX-7303/G is wound. A terminal hook on the loose end of Wire Assembly, Antenna CX-7303/G attaches to Insulator IL-4/GRA-4. Halyard MX-2706/G is secured to a small hole in the Reeling Machine, Cable, Hand RC-432/G frame. A spring action handle on the outer flange of the spool facilitates winding.

c. Cable Assembly, RF CG-678/U is 75 feet 3 inches long and consists of cable RG-58A/U with a connector UG-536/U at each end. Cable Assembly RD CG-78/U connects between Insulator IL-4/GRA-4 and the radio set.

d. Insulator IL-4/GRA is a phenolic housing which has two terminals for connection of the antenna wires and a female coaxial fitting for connecting Cable Assembly RF CG-678/U. Insulator IL-4/GRA-4 is installed at the center of the antenna assembly.

e. Halyard MX-2706/G consists of 75 feet of 1/8-inch diameter Dacron rope. A snaphook fastener at one end of the rope connects to Reeling Machine, Cable, Hand RC-432/G, a snaphook fastener and a lead weight is attached to the other end.

f. The tape, measuring (tape measure), made of nonconducting woven fabric, is 156 feet long. It is calibrated on one side in feet and on the other side in frequency. It is used to measure the length of antenna necessary for operation at any given frequency. The tape measure is marked at each 100 kilocycles (kc) from 1.6 to 6 mc, at each 200 kc from 4 to 6 mc, at each 500 kc from 6 to 10 mc, and at each mc from 10 to 20 mc.

CHAPTER 2

INSTALLATION

8. Unpacking

a. Packaging Data. When packed for shipment, the components of the antenna assembly are individually enclosed in polyethylene envelopes and packed in Bag BG-175. Bag BG-175 is enclosed in a moistureproof barrier and sealed in a corrugated fiberboard carton. Packed for shipment, the carton weighs 13 pounds and is 10 inches high, 9 inches deep, and 10 inches wide; its volume is 0.5 cubic feet. A typical shipping carton and its contents are shown in figure 3.

b. Removing contents. To unpack the equipment, proceed as follows:

- (1) Open the carton. Do not cut open the carton, because the equipment may become damaged.
- (2) Open the moistureproof barrier and remove Bag BG-175.
- (3) Open Bag BG-175 and remove its contents.
- (4) Remove the components from the polyethylene envelopes.

9. Checking Unpacked Equipment

a. Inspect the equipment for damage incurred during shipment. If the equipment has been damaged, refer to paragraph 2.

b. See that the equipment is complete as listed on the packing slip. If a packing slip is not available, check the equipment against the table of components (para 5) or basic issue items list (appx II).

10. Siting

a. In areas, such as jungles, where vegetation is very dense, vertical antennas

are inefficient because of the absorption of their radiation by the surrounding growth. The antenna assembly, however, provides more reliable communications than a vertical antenna in dense growth areas.

b. Locate the antenna in a clearing and assemble the antenna with the antenna wire broadside to the direction of the desired station. When communication is desired with two or more stations, orient the antenna assembly so that the antenna wire is broadside to the weakest station.

11. Installation

a. Determining Length of Antenna Wire.

- (1) In the installation procedure in *b* below, use the tape measure to determine the proper length of antenna wire for the desired frequency of operation. Unroll the tape measure to the desired frequency marking and unroll an equal amount of antenna wire from each reel assembly (fig. 4). The length indicated on the tape measure opposite the desired frequency marking is half of the required total antenna length at that frequency.
- (2) The following chart lists the length of each antenna wire (including the reel assembly frame) required for frequencies between 1.5 and 20 mc. When the tape measure is not available, use the chart to determine each antenna wire length. Pace off (one stride is approximately 3feet) the indicated antenna length; make final adjustment by lengthening or shortening the antenna assembly for the best transmitter loading.

Frequency (mc)	Length of each antenna wire ^a (ft)	Frequency (mc)	Length of each antenna wire ^a (ft)	Frequency (mc)	Length of each antenna wire ^a (ft)
1.5	156.0	2.3	101.73	5.4	43.33
1.52	153.94	2.35	99.57	5.6	41.78
1.54	151.94	2.4	97.50	5.8	40.35
1.56	150.0	2.45	95.51	6.0	39.0

Frequency (mc)	Length of each antenna wire* (ft)	Frequency (mc)	Length of each antenna wire (ft)	Frequency (mc)	Length of each antenna wire* (ft)
1.58	148.10	2.5	93.60	6.2	37.74
1.60	146.25	2.55	91.76	6.4	36.56
1.62	144.44	2.6	90.00	6.6	35.45
1.64	142.68	2.65	88.30	6.8	34.41
1.66	140.96	2.7	86.66	7.0	33.42
1.68	139.28	2.75	85.09	7.5	31.20
1.70	137.64	2.8	83.57	8.0	29.25
1.72	136.04	2.85	82.10	8.5	27.52
1.74	134.48	2.9	80.68	9.0	26.0
1.76	132.95	2.95	79.32	9.5	24.63
1.78	131.46	3.0	78.0	10.0	23.40
1.80	130.0	3.1	75.48	10.5	22.29
1.82	128.57	3.2	73.12	11.0	21.27
1.84	127.17	3.3	70.9	12.0	19.51
1.86	125.80	3.4	68.82	13.0	18.0
1.88	124.46	3.5	66.85	14.0	16.71
1.90	123.15	3.6	65.0	15.0	15.60
1.92	121.87	3.7	63.24	16.0	14.62
1.94	120.61	3.8	61.57	17.0	13.76
1.96	119.38	3.9	60.0	18.0	13.0
1.98	118.18	4.0	58.50	19.0	12.31
2.0	117.0	4.2	55.71	20.0	11.7
2.05	114.14	4.4	53.18		
2.1	111.42	4.6	50.86		
2.15	108.83	4.8	48.75		
2.2	106.36	5.0	46.80		
2.25	104.0	5.2	45.0		

Each antenna wire length includes the reel assembly frame.

b. Installation Procedure.

- (1) Connect the antenna wire terminal hooks to the thumb nuts on the opposite ends of the insulator (fig. 5).
- (2) Temporarily fasten the insulator to one of the desired supports.
- (3) Temporarily fasten the free end of the tape measure to the center of the insulator.
- (4) Unwind the tape measure to the length corresponding to the desired frequency.
- (5) Refer to figure 6 and unroll a like amount of wire from each reel assembly as follows:
 - (a) Grasp the reel assembly firmly in one hand and loosen the thumb nut at the center of the reel and the thumb nut on the wire clamp on the reel assembly frame.
 - (b) Move away from the antenna center slowly, keeping the wire taut at all times. Hold your thumb on the wire to prevent backlash.
 - (c) After unwinding the required amount of wire, tighten the thumb nut on the wire clamp.
 - (d) Tighten the thumb nut at the center of the reel.
- (6) Unfasten the tape measure from the insulator, unfasten the insulator from the support, and lay the antenna wires out in a straight line.
- (7) Check the overall length of the two wires plus the insulator and reel assemblies. The overall length will be twice the length indicated on the tape measure for the desired frequency or twice the length obtained from the chart in a (2) above. Adjust the antenna for an exact overall length. Be sure to keep the insulator centered.
- (8) Attach each reel assembly to a halyard saphook fastener (fig. 7).
- (9) Tie the halyards to the best available supports (tree, fence post, vehicle, etc) at a height of 4 feet or higher.

Caution: Allow the antenna assembly to sag at least 6 inches.
- (10) Connect the ends of the rf cable between the insulator connector (fig. 5) and the antenna connector

on the radio set. Shorten or lengthen the antenna assembly a few inches at a time when difficulty in transmitter loading is encountered.

Note. The rf cable should be at right angles to the antenna wires for the first few feet from the connection at the insulator. Lay the rf cable out as straight as possible; do not allow the cable to form loops.

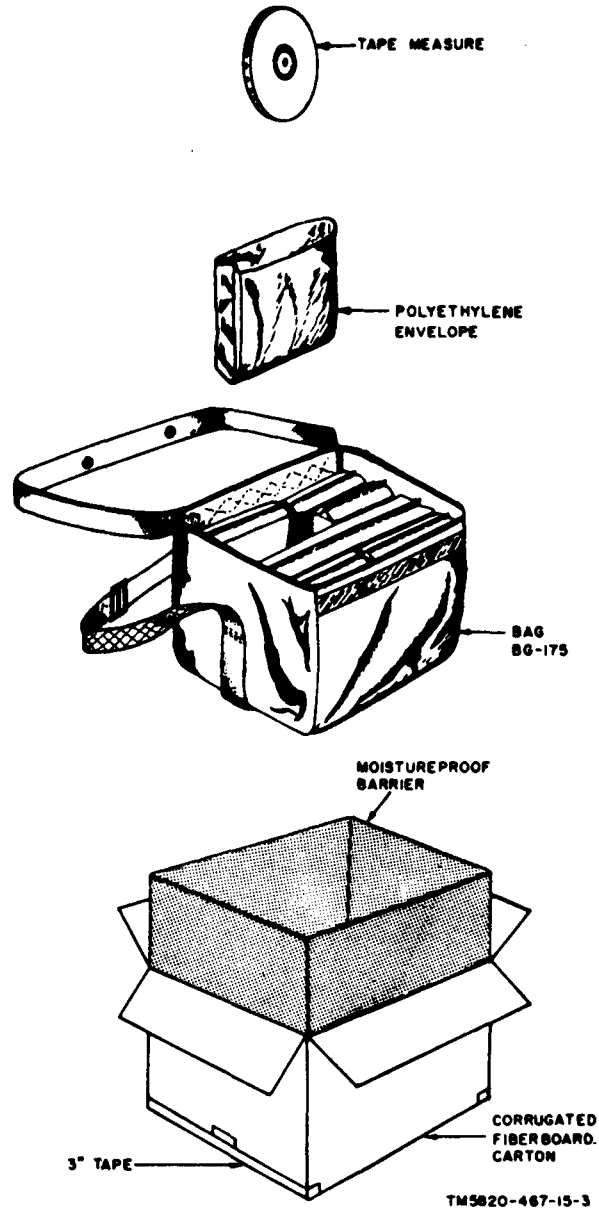

Figure 3. Typical packaging.

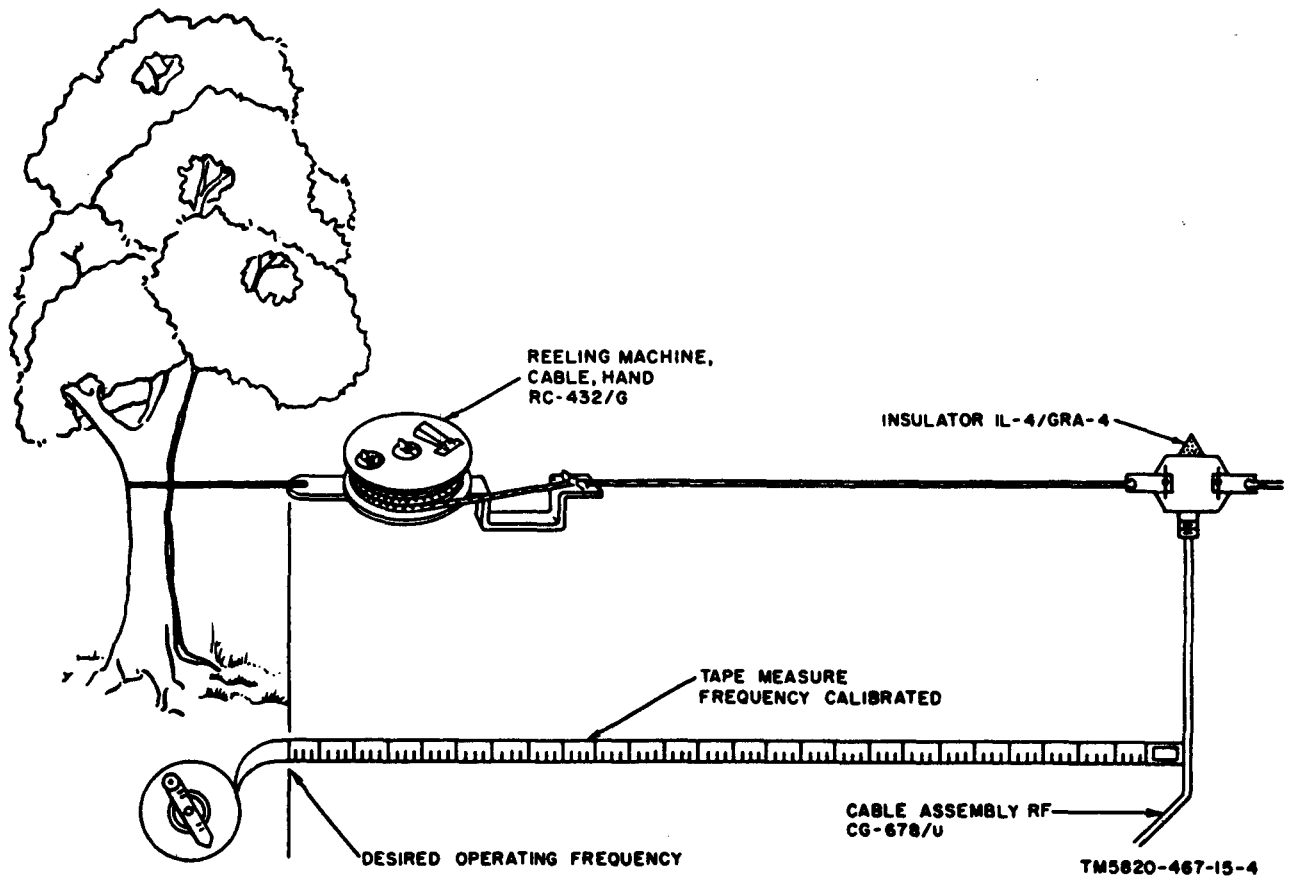

Figure 4. Use of tape measure to determine antenna wire length.



Figure 5. Connecting rf cable to insulator (antenna wires shown connected).

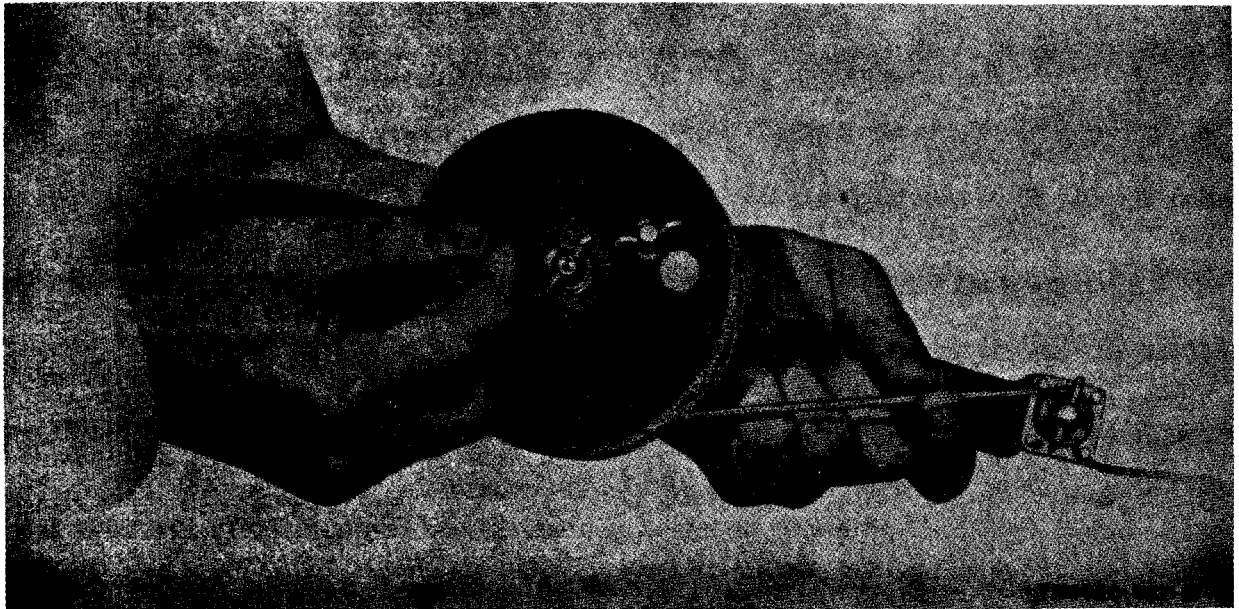

Figure 6. Unwinding antenna wire from reel assembly.



Figure 7. Attaching halyard to reel assembly.

CHAPTER 3

MAINTENANCE

Section I. OPERATOR'S MAINTENANCE

12. Scope of Operator's Maintenance

a. The following is a list of maintenance duties normally performed by the operator of the antenna assembly. Special tools or test equipment is not required.

b. Operator's maintenance for the antenna assembly consists of the following:

- (1) Preventive maintenance (para 13).
- (2) Visual inspection (para 14).

13. Operator's Preventive Maintenance

DA Form 11-238 (fig. 8 and 9) is a preventive maintenance checklist to be used by the operator. Items not applicable to

Antenna Group AN/GRA-50 are lined out in the figures. Instructions for the use of the form appear on the form.

14. Operator's Visual Inspection

When the antenna assembly fails to operate properly, disconnect the radio set from the power source and check the items given below. Do not check any item with the power on.

a. Inspect all electrical connections of the antenna assembly for tightness and corrosion.

b. Inspect the insulator for cracks or chips and dirt.

ADDITIONAL ITEMS FOR 2D AND 3D ECHELON INSPECTIONS		CONDITION
26. INSPECT ANTENNA FOR ECCENTRICITIES, CORROSION, LOOSE FIT, DAMAGED INSULATORS AND REFLECTORS.		✓
27. CHECK FOR NORMAL OPERATION.		✓
28. OPERATOR/INSPECTOR TO REPORT DEFICIENCIES TO SUPERVISOR.		
IF DEFICIENCIES NOTED ARE NOT CORRECTED DURING THE INSPECTION, INDICATE ACTION TAKEN FOR CORRECTION.		

MAINTENANCE CHECK LIST FOR SIGNAL EQUIPMENT SOUND EQUIPMENT, RADIO, DIRECTION FINDING RADAR, CARRIER, RADIOSONDE AND TELEVISION (AR 750-625)			
EQUIPMENT NOMENCLATURE <i>ANTENNA GROUP AN/GRA-50</i>			
EQUIPMENT SERIAL NUMBER <i>32</i>			
INSTRUCTIONS			
This form may be used for a period of one month by using the correct dates and weeks of the month. It is to be used as a Preventive Maintenance check list for Signal equipment in actual use, or for a check on equipment prior to issue.			
1. For detailed Preventive Maintenance instructions see: <ul style="list-style-type: none"> a. The Technical Manual (in TM 11 series) for the equipment. (See DA Pamphlet Number 310-4) b. The Supply Bulletin (SB 11-100 series) for the equipment. (See DA Pamphlet Number 310-4) c. The Department of the Army Lubrication Order. (See DA Pamphlet Number 310-4) 			
2. The following action will be taken by either the Communications Officer/Chief for 1st echelon, or the Inspector for higher echelon: <ul style="list-style-type: none"> a. Enter Equipment Nomenclature and Serial Number. b. Strike out items that do not apply to the equipment. 			
3. Operator/Inspector will enter in the columns entitled CONDITION, on the proper line, a notation regarding the condition, using symbols specified under LEGEND.			
4. After operator completes each daily inspection he will initial over the appropriate dates under "Daily Condition for Month", then return form to his supervisor.			
TYPE OF INSPECTION			
OPERATOR	2/3 ECHELON	DATE	SIGNATURE
✓		1 JULY 1961	<i>Pvt. Raymond Doe</i>
	✓	7 JULY 1961	<i>Sgt. Martin Lee</i>

DA FORM 11-238
MAY 57

REPLACES DA FORMS 11-238, 1 NOV 55; 11-239, 11-244, 11-245, 11-248, 11-249, 11-250, AND 11-281; WHICH ARE OBSOLETE.

LEGEND for marking conditions: Satisfactory, Y. Adjustment, Repair or Replacement required, X. Defect corrected, (X).						DAILY CONDITION FOR MONTH OF JULY 1961																	
NO.	DAILY ITEM	1	2	3	4	5	6	7	8	9	10	11	12	13	14	15	16	20					
		RD	RD	RD	RD	RD	RD	RD	RD	RD	RD	RD	RD	RD	RD	RD	RD	RD	RD ECH-ELON				
1.	COMPLETENESS AND GENERAL CONDITION OF EQUIPMENT. (Transmission, hoodless, carrying cases, wire, cables, microphones, tubes, spare parts, technical manuals).	✓	✓	✓	✓	✓	✓	✓	✓	✓	✓	✓	✓	✓	✓	✓	✓	✓	✓				
2.	CLEAN SURFACES AND INSURE FROM ANTENNA, MOUNTING, POWER, SIGNAL, AND COMMONS PANELS.																						
3.	INSPECT CONTROLS FOR NORMAL OPERATION—POT CONTROLS—SPECIALLY FOR SWICHES OF OUT-GOING SIGNALS CONTROLS.																						
4.	CHECK FOR NORMAL OPERATION OF EQUIPMENT—BE ALERT FOR UNUSUAL OPERATION OR CONDITION.																						
WEEKLY		CONDITION EACH WEEK					20	ADDITIONAL ITEMS FOR 2D AND 3D ECHELON INSPECTIONS										CONDITION					
		1ST	2D	3D	4TH	5TH	RD ECH																
5.	CLEAN AND TIGHTEN EXTERIORS OF CASES, TUBES, MOUNTS, TRANSMISSION LINES.							15.	INSPECT BEARING SURFACES, ACCESSIBLE PLUGS, SWITCHETS, TUGGERS, LEVERS, PUSH, PULL, AND SLIDERS, HUBS, ROLLERS, PULLEY WHEELS.														
6.	INSPECT CASES, MOUNTS, ANTENNA TOWERS AND EXPOSED METAL SURFACES FOR RUST, CORROSION.							16.	INSPECT RELAYS AND CIRCUIT BREAKERS FOR LOOSE MOUNTINGS, BAD CONTACTS, MISALIGNMENT OF CONTACTS AND CRACKS FROM OVERHEATING.														
7.	INSPECT CORDS, CABLE, WIRE, CHECK MOUNTS FOR CUTS, KINKS, BREAKS, FRAYING, UNDOE STRAIN.	✓					✓	17.	INSPECT WINDING SURFACES FOR DIRT, MISALIGNMENT OR PLATES, LOOSE MOUNTINGS, MEASURES.														
8.	CHECK ANTENNA COW WIRES FOR PROPER TENSION OR DAMAGE.	✓					✓	18.	INSPECT RESISTORS, SLIDERS AND INSULATORS FOR CRACKS, SWELLING, DISCOLORING, MOISTURE, DISCOLORATION.														
9.	INSPECT CANVAS AND LEATHER ITEMS FOR MILDEW, TEARS, FRAYING.	✓					✓	19.	CLEAN AND TIGHTEN SWITCHES, TERMINAL BLOCKS, TOWERS, RELAY CASES AND INTERIOR OF CHASSIS AND CASES WHERE ACCESSIBLE.														
10.	INSPECT ACCESSIBLE ITEMS FOR LOOSENESS: SWITCHES, MOUNTS, JACKS, CONNECTORS, RELAYS, TRANSFORMERS, MOTORS, PULLEY WHEELS, TOWERS, ETC.	✓					✓	20.	INSPECT TERMINAL BLOCKS FOR LOOSE CONNECTIONS, CRACKS AND CRACKS.														
11.	CLEAN AND/OR INSPECT AIR FILTERS, CASE DRAIN PLATES, DIAL AND MOTOR WINDOWS.							21.	INSPECT TERMINALS OF LARGE PAGES RELAYS AND RESISTORS FOR DIRT, CORROSION, LOOSE CONTACTS.														
12.	INSPECT STORAGE BATTERIES FOR DIRT, LEAKS, TERMINALS, CRACKS OR WELDS, DAMAGED CASES. INSPECT DRY BATTERIES FOR LEAKAGE.							22.	INSPECT TRANSFORMERS, CHOKES, POTENTIOMETERS AND INDICATORS FOR OVERHEATING AND OIL LEAKAGE.														
ADDITIONAL ITEMS FOR 2D AND 3D ECHELON INSPECTIONS							CONDITION	23.	INSPECT GENERATORS, AMPLIFIERS, SYNCH MOTORS FOR BRUSH WEAR, SPRING TENSION, WIRING AND FITTING OF COMMUTATOR.														
13.	INSPECT CHASSIS AND CASES FOR ABSCISSA OF WEATHER PROOFING—TEARS, FRAYING.							24.	INSPECT BATTERY TRAYS FOR BURN OR GREEN SPOTS.														
14.	CHECK TERMINAL BOX COVERS FOR CRACKS, DIRT, LEAKS, DAMAGED CONTACTS, CRACKS.							25.	INSPECT INTERCONNECT CONTACTS FOR WEAR, WORN OR LOOSE PARTS.														

CONTINUED ON PAGE 4

Figure 9. DA Form 11-238, pages 2 and 3.

Section II. ORGANIZATIONAL AND FIELD MAINTENANCE (THIRD ECHELON)

15. Scope of Organizational Maintenance

The following is a list of maintenance duties performed by organizational maintenance personnel for the antenna assembly. The scope of these instructions has been determined by the available tools, materials, test equipment, spare parts, and the MOS of the repairman.

- a. Preventive maintenance (para 17).
- b. Troubleshooting (para 18).
- c. Replacement of parts (para 19).

16. Tools, Materials, and Test Equipment Required

A list of parts normally stocked for organizational maintenance is contained in TM 11-5820-467-25P. The tools, materials, and test equipment required for organizational maintenance are listed below:

- a. *Tools.* Tool Equipment TE-41.
- b. *Materials.*
 - (1) Cleaning compound (Federal stock No. 7930-395-9542).

(2) Cleaning cloth, lint-free.

(3) Sandpaper No. 000.

c. *Test Equipment.* Multimeter AN/URM-105.

17. Organizational Preventive Maintenance

DA Form 11-238 (fig. 8 and 9) is a preventive maintenance checklist to be used by organizational maintenance personnel. Items not applicable to the equipment are lined out in the figures. Instructions for the use of the form appear on the form.

18. Troubleshooting

a. The troubleshooting chart is for use of second through fifth echelon maintenance personnel. Upon noting a defect in either transmission or reception, shut down the power at the transmitter/receiver, disconnect the rf cable from the transmitter/receiver antenna connector, and perform the appropriate procedure listed in the chart below.

b. *Chart.*

Item	Indication	Probable trouble	Procedure
1	No transmission from associated transmitter and no reception.	Rf cable open or shorted . . .	Check continuity between rf cable and antenna wires. Replace rf cable if open. Remove rf cable completely. Use Multimeter AN/URM-105 to check resistance between center contact and shell of either connector. Replace rf cable if resistance is less than 10 megohm.
2	Weak transmission from associated transmitter and weak reception.	Incorrect installation Leakage path to ground Leakage in rf cable	Check for proper length of antenna at the operating frequency (para 11). Check for foliage in contact with the antenna wires. Remove rf cable completely and check resistance between center contact and shell of either connector. Replace if resistance is less than 10 megohms.

19. Repair of Rf Cable (Third Echelon) (fig. 10)

The only item of the antenna assembly that can be readily repaired is the rf cable (b and c below).

a. *Tools and Test Equipment Required.*

(1) Tool Equipment TE-113.

(2) Multimeter TS-352/U.

b. *Installation of Connector on End of Rf Cable.*

(1) Remove three-quarters of an inch of the rf cable outer jacket.

- (2) Disassemble the UG-536/U and lay out its parts in the order of disassembly.
 - (3) Slide the nut over the rf cable.
 - (4) Slide the washer over the rf cable.
 - (5) Slide the gasket over the rf cable, one-sixth of an inch beyond the edge of the rf cable outer jacket.
 - (6) Slide the flanged sleeve over the copper braid shield.
 - (7) Flare the shield around the flanged sleeve.
 - (8) Remove the excess shield braid so that it is even with the outer edge of the flanged sleeve.
 - (9) Remove three-sixteenths of an inch of insulation from the end of the conductor.
 - (10) Slide the contact over the conductor
- and solder through the hole in the contact. File the soldered area smooth.
 - (11) Insert the cable into the shell.
 - (12) Tighten the nut securely. When the cable and connector are properly assembled, the contact tip should be flush with, or not more than one thirty-second of an inch beneath the edge of the coupling.
 - (13) Use multimeter TS-352/U to check the rf cable for continuity and shorts.
- c. *Replacement of Cable RG58A/U.*
- (1) Measure and cut off 75 feet of cable
 - (2) Install connector UG-536/U to each end of cable RG-58A/U as in *b* above.

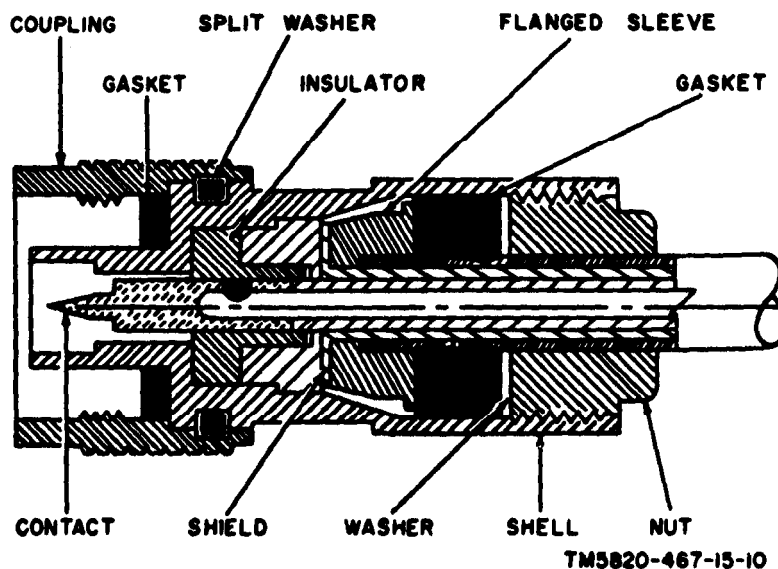

Figure 10. Cross section of rf cable and connector.

CHAPTER 4

THEORY

20. Antenna Theory

The characteristics of transmitting and receiving antennas are similar; a good transmitting antenna is also a good receiving antenna.

a. Basic Half Wave Antenna. During transmission, the rf current in the antenna wire produces a radiated field. During reception, a radiated field from a distant station antenna cuts the antenna wire and causes a current flow in the wire. In a half wave antenna, current is maximum at the center and minimum at the ends, while voltage is minimum at the center and maximum at the ends (fig. 11); therefore, impedance is minimum at the center and maximum at the ends. The impedance at the center of a basic half wave antenna is 72 ohms. The current distribution in the antenna is the same regardless of the amount of current flow; the amplitude of the current at any point on the antenna varies directly with the amplitude of the signal voltage.

b. Directional Pattern.

- (1) Maximum radiation occurs at the center of a half wave antenna, because the current is greatest at that point. Minimum radiation takes place at the ends, because the current is least at the ends. Radiation is at right angles to the plane of the antenna wire and completely encircles the antenna wire. The resulting antenna directional pattern can be compared to a doughnut with the radiator passing through its center. Figure 12 shows a cross section of the doughnut shaped pattern. Although there is no radiation along the direct line

of the antenna axis, there are different amounts of radiation at different angles to the axis. There is little radiation in direction OA, greater radiation in direction OB, and maximum radiation in direction OC.

- (2) That part of the radiation field which travels upward, strikes the ionosphere, and is returned at a considerable distance from the radiating antenna is called a sky-wave. A horizontal half wave antenna is very broadly bidirectional in the horizontal plane. In practice, the antenna is oriented in the direction that provides maximum signal strength.

21. Theory of Antenna Assembly

The antenna assembly is a horizontal center-fed Hertz antenna (doublet). A center-fed Hertz is one-half wavelength long at the operating frequency and is fed at its physical center. The antenna assembly is adjustable and can be used for operating frequencies from 1.5 to 20 mc. It consists of two lengths of wire, each adjustable to a little less than a quarter wavelength at the operating frequency. The transmission line is a low-impedance coaxial cable that connects to the low-impedance point at the center of the antenna assembly. A certain amount of mismatch exists between the rf cable and the antenna, but it is not critical. Current and voltage distribution is the same as that described for a simple half wave antenna (para 20). The formula for determining the actual total length of the antenna assembly required for a particular operating frequency is:

$$\text{Length in feet} = \frac{468}{\text{Frequency in mc.}}$$

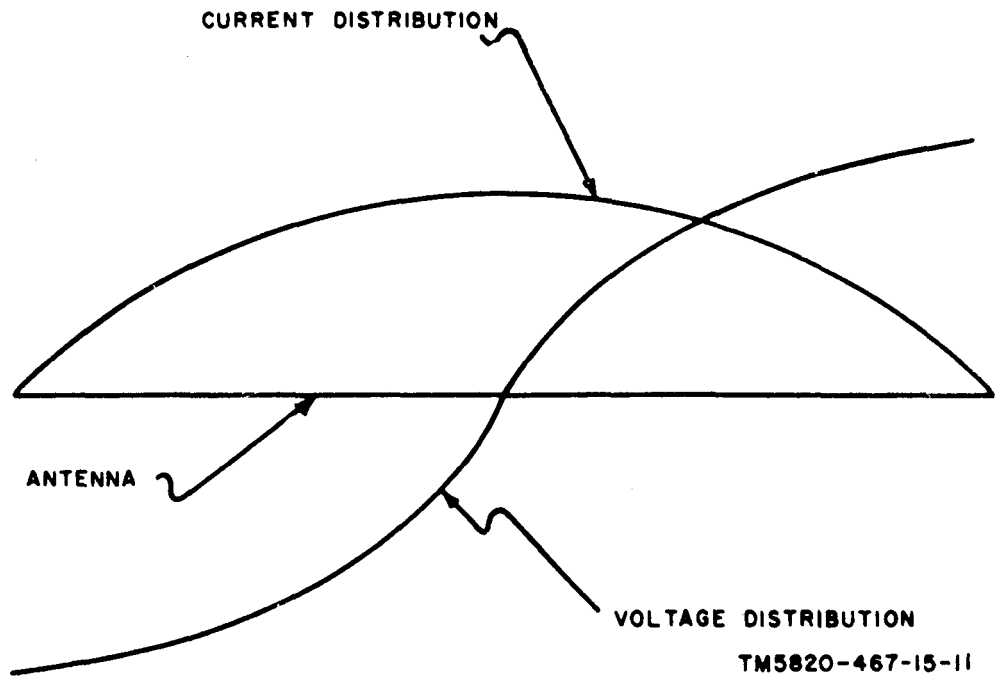

Figure 11. Current and voltage distribution in half wave antenna.

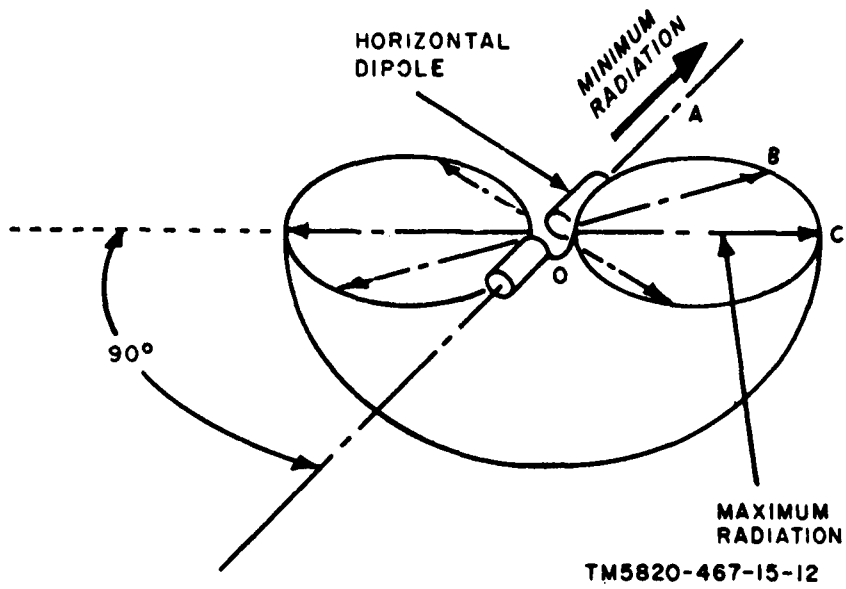

Figure 12. Radiation pattern of half wave antenna.

CHAPTER 5

SHIPMENT, LIMITED STORAGE, AND DEMOLITION TO PREVENT ENEMY USE

Section 1. SHIPMENT AND LIMITED STORAGE

22. Disassembly

Warning: Disconnect the equipment from the power source before performing any disassembly.

Disassemble the antenna assembly as follows:

- a. Disconnect the rf cable from the transmitter.
- b. Release the tied ends of the halyards and lower the antenna slowly; be careful not to damage the insulator.
- c. Unfasten the antenna wire terminations from the insulator and unfasten the reel assemblies from the halyards.
- d. Wind the antenna wire onto each reel assembly; use the index finger and thumb to help make a tight wind (fig. 6).
- e. Unfasten the rf cable connector from the insulator and coil the cable as follows:
 - (1) Make one coil and tie the coil with friction tape.

- (2) Coil the remainder of the cable.
- f. Coil and bind the halyards.

23. Repacking for Shipment or Limited

a. The exact procedure used in packing for shipment or limited storage depends on the material available and the conditions under which the equipment is to be shipped or stored. The information concerning the original packing (para 8) will be helpful.

b. Pack the equipment as follows:

- (1) Place the components in individual plastic bags and store them in Bag BG-175.
- (2) Enclose and seal Bag BG-175 in a moisture proof paper envelope.
- (3) Place the enclosed Bag BG-175 in a suitable carton.
- (4) Place pads inside the carton to hold Bag BG-175 securely in place.
- (5) Close and seal the carton with tape.

Section II. DEMOLITION OF MATERIEL TO PREVENT ENEMY USE

24. Authority for Demolition

The destruction procedures given in paragraph 25 will be used to prevent the enemy from using or salvaging this equipment. Demolition of the equipment will be accomplished only upon the order of the commander.

25. Methods of Destruction

Any or all of the following methods of destruction may be used. The time available will usually be the most important factor to consider in deciding which methods will be used, but the tactical situation must also be considered. If a number of antennas are in use in the same or nearby installations,

it is better to demolish completely the same parts of all the antennas rather than to partially damage all the antennas.

a. *Smash.* Use sledges, axes, crowbars, and any other heavy tools available. First smash the reel assemblies then smash the insulator and the rf cable connectors.

b. *Cut.* Use any available sharp tools to cut the rf cable, the antenna wires, and the halyards in a number of places.

c. *Burn.* Burn as much of the equipment as is flammable. Pour gasoline over the instruction books, the rf cable, the insulator, and the halyards and ignite it.

d. *Disposal.* Bury or scatter all destroyed parts, or throw them into nearby waterways.

APPENDIX I

REFERENCES

Following is a list of applicable references that are available to the operator and unit repairman of Antenna Group AN/GRA-50.

SB 38-100

Preservation, Packaging, and Packing Materials, Supplies, and Equipment Used by the Army.

TM 11-5820-295-10

Operator's Manual: Radio Set AN/GRC-19.

TM 11-5820-295-20

Organizational Maintenance: Radio Set AN/GRC-19.

TM 11-5820-467-25P

Organizational, Field and Depot Maintenance Repair Parts and Special Tool Lists, Antenna Group AN/GRA-50.

APPENDIX II

BASIC ISSUE ITEMS LIST

Section I. INTRODUCTION

1. General

a. This appendix lists items supplied for initial operation. The list includes tools, parts, and material issued as part of the major end item. The list includes all items authorized for basic operator maintenance of the equipment. End items of equipment are issued on the basis of allowances prescribed in equipment authorization tables and other documents that are a basis for requisitioning.

b. The columns are as follows:

- (1) **Source, maintenance, and recoverability code.** Not used.
- (2) **Federal stock number.** This column lists the 11-digit Federal stock number. In the absence of a Federal stock number, an interim number, for example †† L8Ra41C-12 in the description column, indicates that a Federal stock number is being processed for assignment. The L number may be used in emergencies to identify items.
- (3) **Designation by model.** Not used.
- (4) **Description.** Nomenclature or the standard item name and brief identifying data for each item are listed in this column. When requisitioning, enter the nomenclature and description.
- (5) **Unit of issue.** Not used.
- (6) **Expendability.** Nonexpendable items are indicated by NX.
- (7) **Quantity authorized.** This column lists the quantity of items supplied for the initial operation of the equipment.
- (8) **Illustrations. The "Figure No."** column lists the figure for identification of the items.

(1) SOURCE MAINTENANCE AND RECOVERABILITY CODE	(2) FEDERAL STOCK NUMBER	(3) DESIGNATION B. MODEL	(4) DESCRIPTION	(5) UNIT OF ISSUE	(6) EXPENDABILITY	(7) QUANTITY AUTHORIZED	(8) ILLUSTRATIONS	
							(9) FIGURE NO	(10) ITEM NO
			ANTENNA GROUP AN/GRA-50: provides transmitting and receiving facilities for med power vehicular Radio Set in freq range of 1.5 to 20 mc. † † L1Ra15-1				1	
			ITEMS COMPRISING AN OPERABLE EQUIPMENT					
			ANTENNA GROUP AN/GRA-50: (BASIC COMPONENT)			NX	1	
	Ord thru AGC		TECHNICAL MANUAL TM11-5820-467-15				2	
	6115-498-3973		BAG BG-175: f/storage of ant and components when not in use. (Not Installed)				1	2
	5995-823-2176		CABLE ASSEMBLY RF CG-678/U (75 ft 3 in) uses cable RG-58A/U, connector UG-536/U ea end. (Not Installed)				1	2
	5985-893-1438		HALYARD MX-2706/G				2	2
	5970-405-8223		INSULATOR IL-4/GRA-4 (Not Installed)				1	2
			REELING MACHINE, CABLE, HAND RC-432/G † † L1Ra15-4 (Not Installed)				2	2
			TAPE MEASURING: feet and inches; marked in freq reverse side; f/setting up ant; Arkay No. 859-501 † † L1Ra15-11 (Not Installed)				1	2
			WIRE ASSEMBLY, ANTENNA CX-7303/G (160 ft 0 in) NOTE: stored and used with (but not p/o) Reel RC-432/G † † L1Ra15-6 (Not Installed)				2	2
			RUNNING SPARES AND ACCESSORY ITEMS					
			NO PARTS AUTHORIZED FOR STOCKAGE AT FIRST ECHELON					

AN/GRA-50

APPENDIX III

MAINTENANCE ALLOCATION

Section I. MAINTENANCE ALLOCATION

1. General

a. This section assigns maintenance functions and repair operations to be performed by the lowest appropriate maintenance echelon.

b. Columns in the maintenance allocation chart are as follows:

- (1) *Part or component.* This column shows only the nomenclature or standard item name. Components and parts comprising a major end item are listed alphabetically.
- (2) *Maintenance function.* This column indicates the various maintenance functions allocated to the echelon capable of performing the operations.
 - (a) *Service.* To clean and to preserve.
 - (b) *Inspect.* To verify serviceability and to detect incipient electrical or mechanical failure by scrutiny.
 - (c) *Test.* To verify serviceability and to detect incipient electrical or mechanical failure by use of special equipment such as gages, meters, etc.
 - (d) *Replace.* To substitute serviceable assemblies and parts for unserviceable components.
 - (e) *Repair.* To restore an item to serviceable conditions through correction of a specific failure or unserviceable condition. This function includes, but is not limited to, inspecting, cleaning, preserving, adjusting, replacing, welding, riveting, and straightening.
- (3) *1st, 2nd, 3rd, 4th, 5th echelon.* The symbol X indicates the echelon responsible for performing that particular maintenance operation, but does not necessarily indicate that repair parts will be stocked at that

level. Echelons higher than the echelon marked by X are authorized to perform the indicated operation.

- (4) *Tools required.* This column indicates codes assigned to each individual tool equipment, test equipment, and maintenance equipment referenced. The grouping of codes in this column of the maintenance allocation chart indicates the tool, test, and maintenance equipment required to perform the maintenance function.
- (5) *Remarks.* Entries in this column will be utilized when necessary to clarify any of the data cited in the preceding columns.

c. Columns in the allocation of tools for maintenance functions are as follows:

- (1) *Tools required for maintenance functions.* This column lists the tools, test, and maintenance equipment required to perform the maintenance functions.
- (2) *1st, 2d, 3d, 4th, 5th echelon.* The dagger (†) symbol indicates the echelons allocated the facility.
- (3) *Tool code.* This column lists the tool code assigned.

2. Maintenance by Using Organizations

When this equipment is used by signal services organizations organic to theater headquarters or communications zones to provide theater communications, those maintenance functions allocated up to and including fourth echelon are authorized to the organization operating this equipment.

3. Mounting Hardware

The basic entries of the maintenance allocation chart do not include mounting hardware such as screws, nuts, bolts, washers, brackets, clamps, etc.

Section II. MAINTENANCE ALLOCATION CHART

26

(1) PART OR COMPONENT	(2) MAINTENANCE FUNCTION	(3) 1ST ECH	(4) 2ND ECH	(5) 3RD ECH	(6) 4TH ECH	(7) 5TH ECH	(8) TOOLS REQUIRED	(9) REMARKS
ANTENNA GROUP AN/GRA-50	service	X						
	inspect	X						
	test		X				1	Checking cable for leakage and continuity
	repair			X			2	Checking cable for leakage and continuity
CABLE ASSEMBLY WF	repair		X				3	Replacement of components
	repair			X			4	Repair of components
HALYARD MX-2708/G	replace		X				3	
	repair		X				4	Replacement of weight Repair of Halyard
INSULATOR IL-4/GRA-4	replace		X				4	
	repair			X			4	
WHEEL, CABLE	replace		X				4	
	repair			X			4	
WIRE ASSY ANT CX-7503/G	replace		X				4	
	repair			X			4	

Section III. ALLOCATION OF TOOLS FOR MAINTENANCE FUNCTIONS

(1) TOOLS REQUIRED FOR MAINTENANCE FUNCTIONS	(2)	(3)	(4)	(5)	(6)	(7)	(8) REMARKS
	1ST ECH	2ND ECH	3RD ECH	4TH ECH	5TH ECH	TOOL CODE	
AN/GRA-80 (continued)							
MULTIMETER AN/URN-108		†				1	
MULTIMETER TS-352/U			†	†	†	2	
TOOL EQUIPMENT TE-41		†				3	
TOOL EQUIPMENT TE-113			†	†	†	4	

By Order of Secretary of the Army:

G. H. DECKER,
General, United States Army,
Chief of Staff.

Official:

R. V. LEE,
Major General, United States Army,
The Adjutant General.

Distribution:

Active Army:

DASA (5)
USASA (2)
CNGB (1)
Tech Stf, DA (1) except
 CSigo (18)
Tech Stf Bd (1)
USCONARC (5)
USAARTYBD (1)
USAARMBD (2)
USAIB (1)
USARADB (2)
USAABELCTBD (1)
USAAVNBD (1)
USAATBD (1)
ARADCOM (2)
ARADCOM Rgn (2)
OS Maj Comd (3)
OS Base Comd (2)
LOGCOMD (2)
MDW (1)
Armies (2)
Corps (5)
USATC Armor (2)
USATC Engr (2)
USATC FA (2)
USATC Inf (2)
USATC AD (2)
Svc Colleges (2)
Br Svc Sch (2)
GENDEP (2) except
 Atlanta, GENDEP (none)
Sig Sec, GENDEP (5)
Sig Dep (12)
Fort Monmouth (71)
AFSSC (1)

AFIP (1)
WRAMC (1)
Yuma Test Sta (2)
USAEPG (2)
EMC (1)
USACA (3)
USASEA (1)
USA Caribbean Sig Agcy (1)
USA Sig Msl Spt Agcy (13)
USASSA (20)
USASSAMRO (1)
Army Pictorial Cen (2)
USAOMC (3)
USA Trans Tml Comd (1)
 Army Tml (1)
 POE (OS) (1)
 OSA (1)
 AMS (1)
 Sig Fld Maint Show (a)
 JBUSMC (2)
Units org under fol TOE:
 10-105 (2)
 10-106 (2)
 10-107 (2)
 10-445 (2)
 11-7 (2)
 11-16 (2)
 11-57 (2)
 11-98 (2)
 11-117 (2)
 11-155 (2)
 11-500 (AA-AE) (4)
 11-557 (2)
 11-587 (2)
 11-592 (2)
 11-597 (2)

NG: State AG (3) Units - Same as Active Army except allowance is one oopy to each unit.

USAR: None.

For explanation of abbreviations used, see AR 320-50.

