

TM 11-5820-520-10

OPERATOR'S MANUAL

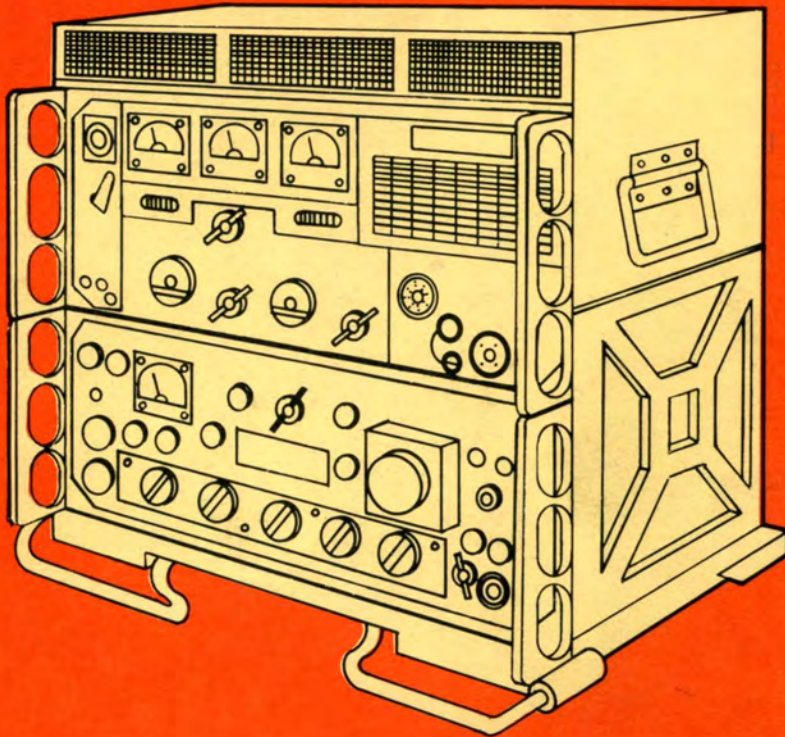

**EQUIPMENT
DESCRIPTION
PAGE 1-3**

**OPERATOR'S
CONTROLS
PAGE 2-1**

**PREVENTIVE
MAINTENANCE
(PMCS)
PAGE 2-16**

**OPERATION
PAGE 2-21**

**TROUBLE-
SHOOTING
PAGE 3-2**

RADIO SETS AN/GRC-106
(NSN 5820-00-402-2263)

AN/GRC-106A
(NSN 5820-00-223-7548)

HEADQUARTERS, DEPARTMENT OF THE ARMY
28 MAY 1984



DANGEROUS VOLTAGES EXIST IN THIS EQUIPMENT

Voltages as high as 128 volts ac, 3,000 volts dc, and 10,000 volts RF are used in the operation of Amplifier, Radio Frequency AM-3349/GRC-106.

**DANGEROUS VOLTAGES EXIST AT THE AM-3349/GRC-106
50-OHM LINE AND WHIP ANTENNA CONNECTORS**

Be careful when working around the antenna or antenna connectors. Radio-frequency voltages as high as 10,000 volts exist at these points. Operator and maintenance personnel should be familiar with the requirements of TB SIG 291 before attempting installation or operation of Radio Set AN/GRC-106(*).

DEATH ON CONTACT

May result if operating personnel fail to observe safety precautions and fail to follow requirements of TB SIG 291.

DON'T TAKE CHANCES!

WARNING

Adequate ventilation should be provided while using TRICHLOROTRIFLUOROETHANE. Prolonged breathing of vapor should be avoided. The solvent should not be used near heat or open flame; the products of decomposition are toxic and irritating. Since TRICHLOROTRIFLUOROETHANE dissolves natural oils, prolonged contact with skin should be avoided. When necessary, use gloves which the solvent cannot penetrate. If the solvent is taken internally, consult a physician immediately.

**WARNING
RADIATION HAZARD**



**RADIOACTIVE MATERIAL
CONTROLLED DISPOSAL REQUIRED
ACCOUNTABILITY NOT REQUIRED**

STD RW-2

Meter, electrical indicating	Ra226	1.0uCi	6625-01-044-1801
Meter, electrical indicating	Ra226	1.0uCi	6625-00-226-5679
Meter, signal level	Ra226	0.6uCi	6625-00-226-5680

Radiation Hazard Information: The following radiation hazard information must be read and understood by all personnel before operating or repairing Radio Sets AN/GRC-106 and AN/GRC-106A. Hazardous radioactive materials are present in the above listed components of the AM-3349/GRC-106 and the RT-662/GRC.

The components are potentially hazardous when broken. See qualified medical personnel and the local Radiological Protection Officer (RPO) immediately, if you are exposed to or cut by broken components. First aid instructions are contained in TB 43-0116, TB 43-0122, AR 385-11.

NEVER place radioactive components in your pocket.

Use extreme care NOT to break radioactive components while handling them.

NEVER remove radioactive components from cartons until you are ready to use them.

If any of these components are broken, notify the local RPO immediately.

The RPO will survey the immediate area for radiological contamination and will supervise the removal of broken components.

The above listed radioactive components will NOT be repaired or disassembled.

WARNING

SERIOUS INJURY OR EVEN DEATH CAN HAPPEN IF THE FOLLOWING ARE NOT CAREFULLY OBSERVED WHEN INSTALLING AND USING THE ANTENNAS USED WITH YOUR RADIO SETS.

**BEFORE ANY
MISSION FIND
OUT**

1. ARE THERE ANY POWERLINES IN YOUR AREA OF OPERATION ?
2. HOW HIGH ARE THESE POWERLINES ?
3. HOW TALL ARE THE POLES OR TOWERS CARRYING POWERLINES ?

MOBILE OPERATION WITH WHIP ANTENNAS



DO NOT STOP YOUR VEHICLE UNDER POWERLINES.

- IF POSSIBLE, TRY TO MAINTAIN MOBILE COMMUNICATIONS WITH YOUR ANTENNA(S) TIED DOWN.
- MAKE SURE AN ANTENNA TIP CAP IS SECURELY TAPED ON THE END OF EACH WHIP ANTENNA.
- DO NOT LEAN AGAINST OR TOUCH A WHIP ANTENNA WHILE THE TRANSMITTER IS ON.
- DURING CROSS-COUNTRY OPERATION, DO NOT ALLOW ANYONE TO STICK AN ARM, LEG OR WEAPON OVER THE SIDES OF THE VEHICLE. IF YOUR ANTENNA ACCIDENTALLY TOUCHES A POWERLINE AND A LEG, ARM OR WEAPON CONTACTS A DAMP BUSH OR THE GROUND, A SERIOUS OR FATAL ACCIDENT CAN HAPPEN.
- IF YOU ARE NOT SURE THAT AN ANTENNA ON YOUR VEHICLE WILL CLEAR A POWERLINE, STOP BEFORE YOU GET CLOSE TO THE POWERLINE AND EITHER CAREFULLY TIE DOWN THE ANTENNA OR REMOVE ANTENNA SECTIONS TO MAKE SURE THAT YOU CAN SAFELY DRIVE UNDER THE POWERLINE.

FIXED OPERATION WITH LONG RANGE ANTENNAS **WARNING**

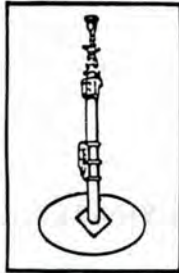

TELESCOPING ANTENNA
MAST



TYPICAL TOWER



EXTENDED RANGE
ANTENNA



DOUBLET ANTENNA

NEVER ERECT THESE LONG RANGE ANTENNAS DIRECTLY UNDER POWER LINES.

IF YOU MUST ERECT THESE LONG RANGE ANTENNAS NEAR POWERLINES, POWERLINE POLES OR TOWERS, OR BUILDINGS WITH OVERHEAD POWERLINE CONNECTIONS, NEVER PUT THE ANTENNA CLOSER THAN TWO TIMES THE ANTENNA HEIGHT FROM THE BASE OF THE POWERLINE, POLE, TOWER OR BUILDINGS. 100 FEET AWAY IS A GOOD SAFE ROUND NUMBER TO REMEMBER.

NEVER ATTEMPT TO ERECT ANY LONG RANGE ANTENNA WITHOUT A FULL TEAM.

BEFORE ERECTING ANY LONG RANGE ANTENNA, INSPECT ALL THE PARTS MAKING UP THE ANTENNA KIT. DO NOT ERECT THE ANTENNA IF ANY PARTS ARE MISSING OR DAMAGED.

DO AS MUCH OF THE ASSEMBLY WORK AS POSSIBLE ON THE GROUND.

WHEN ERECTING THE ANTENNA, ALLOW ONLY TEAM PERSONNEL IN THE ERECTION AREA.

MAKE SURE THAT THE AREA FOR THE ANCHORS IS FIRM. IF THE GROUND IS MARSHY OR SANDY, GET SPECIFIC INSTRUCTIONS FROM YOUR CREW CHIEF OR SUPERVISOR ON HOW TO REINFORCE THE ANCHORS.

WHEN SELECTING LOCATIONS FOR ANCHORS, AVOID TRAVELED AREAS AND ROADS. IF YOU CANNOT AVOID THESE AREAS, GET SPECIFIC INSTRUCTIONS FROM YOUR SUPERVISOR AS TO WHAT CLEARANCE YOUR GUY WIRES AND ROPES MUST HAVE OVER THE TRAVELED AREAS AND ROAD.

CLEARLY MARK ALL GUY WIRES AND ROPES WITH THE WARNING FLAGS OR SIGNS SUPPLIED BY YOUR UNIT. IN AN EMERGENCY, USE STRIPS OF WHITE CLOTH AS WARNING STREAMERS.

IF YOU SUSPECT THAT POWERLINES HAVE MADE ACCIDENTAL CONTACT WITH YOUR ANTENNA, STOP OPERATING, ROPE OFF THE ANTENNA AREA, AND NOTIFY YOUR SUPERIORS.

IF THE WEATHER IN YOUR AREA CAN CAUSE ICE TO FORM ON YOUR LONG RANGE ANTENNA AND ITS GUY WIRES AND ROPES, ADD EXTRA GUYS TO SUPPORT THE SYSTEM. ROPE OFF THE AREA AND POST IT WITH WARNING SIGNS LIKE BEWARE OF FALLING ICE.

DO NOT TRY TO ERECT ANY ANTENNA DURING AN ELECTRICAL STORM.

KEEP A SHARP EYE ON YOUR ANCHORS AND GUYS. CHECK THEM DAILY AND IMMEDIATELY BEFORE AND AFTER BAD WEATHER.



5

SAFETY STEPS TO FOLLOW IF SOMEONE IS THE VICTIM OF ELECTRICAL SHOCK

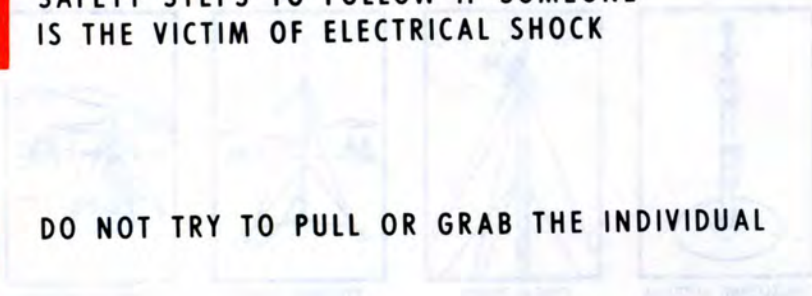

1

DO NOT TRY TO PULL OR GRAB THE INDIVIDUAL

2

IF POSSIBLE , TURN OFF THE ELECTRICAL POWER

3

IF YOU CANNOT TURN OFF THE ELECTRICAL POWER, PULL, PUSH, OR LIFT THE PERSON TO SAFETY USING A WOODEN POLE OR A ROPE OR SOME OTHER INSULATING MATERIAL

4

SEND FOR HELP AS SOON AS POSSIBLE

5

AFTER THE INJURED PERSON IS FREE OF CONTACT WITH THE SOURCE OF ELECTRICAL SHOCK, MOVE THE PERSON A SHORT DISTANCE AWAY AND IMMEDIATELY START ARTIFICIAL RESUSCITATION

**OPERATOR'S MANUAL
RADIO SETS
AN/GRC-106 (NSN 5820-00-402-2263)
AND
AN/GRC-106A (NSN 5820-00-223-7548)**

REPORTING ERRORS AND RECOMMENDING IMPROVEMENTS

You can help improve this manual. If you find any mistakes or if you know of a way to improve the procedures, please let us know. Mail your letter, DA Form 2028 (Recommended Changes to Publications and Blank Forms), or DA 2028-2 located in the back of this manual direct to: Commander, US Army Communications-Electronics Command and Fort Monmouth, ATTN: DRSEL-ME-MP, Fort Monmouth, New Jersey 07703. In either case, a reply will be furnished direct to you.

SUBJECT	PAGE
CHAPTER 1 INTRODUCTION	1-1
Section I General Information	1-1
Scope	1-1
Consolidated Index of Army Publications and Blank Forms	1-1
Maintenance Forms, Records and Reports	1-1
Administrative Storage	1-1
Destruction of Army Electronics Materiel	1-1
Reporting Equipment Improvement Recommendations (EIR)	1-1
Nomenclature Cross Reference List	1-2
List of Abbreviations	1-2
Hand Receipt	1-2
Section II Equipment Description	1-3
Equipment Purpose, Capabilities and Features	1-3
Description of Major Components	1-3
Antenna Description	1-4
Differences Between Models	1-5
Performance Data	1-7
Section III Technical Principles of Operation	1-9

*This manual supersedes TM 11-5820-520-10, 23 November 1982,

SUBJECT	PAGE
CHAPTER 2 OPERATING INSTRUCTIONS	2-0
Section I Description and Use of Operator's Control and Indicators	2-1
Section II Preventive Maintenance Checks and Services (PMCS)	2-16
PMCS Procedures	2-20
PMCS Chart	2-20
Section III Operation Under Usual Conditions	2-21
Assembly and Preparation for Use	2-21
Operating Procedures	2-40
Preparation for Movement	2-45
Section IV Operation Under Unusual Conditions	2-46
Operation in Unusual Weather	2-46
Jamming and ECM Procedures	2-46
Anti-Jamming Procedures	2-47
Destruction to Prevent Enemy Use	2-48
CHAPTER 3 MAINTENANCE INSTRUCTIONS	3-0
Troubleshooting Procedures	3-2
APPENDIX A REFERENCES	A-1
APPENDIX B COMPONENTS OF END ITEM LIST	B-1
APPENDIX C ADDITIONAL AUTHORIZATION LIST (NOT APPLICABLE)	
APPENDIX D EXPENDABLE SUPPLIES AND MATERIALS LIST (NOT APPLICABLE)	
GLOSSARY	Glossary
INDEX	Index-1



FIGURE 1
RADIO SET

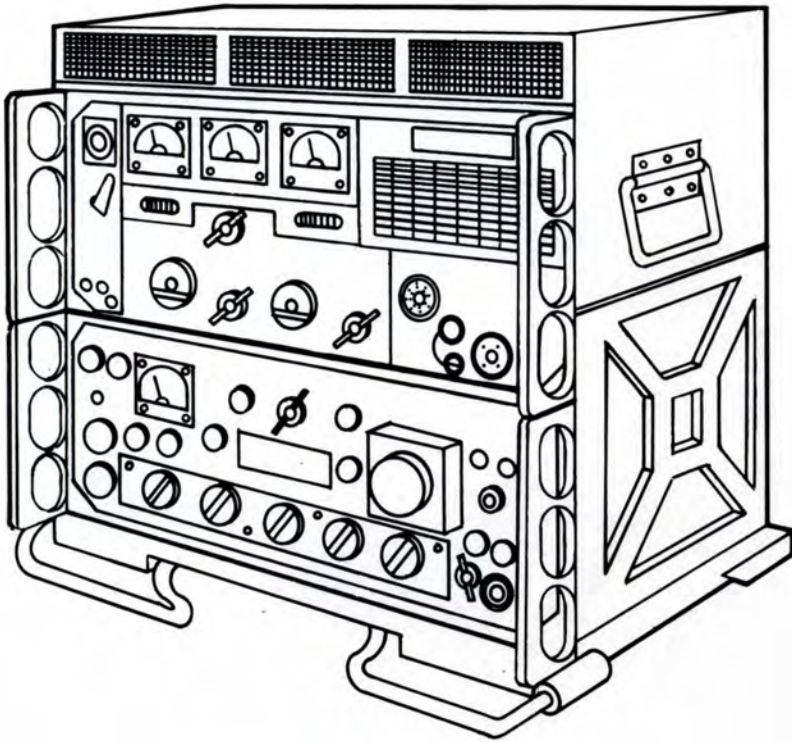

RADIO SET
AN/GRC-106

CHAPTER 1**INTRODUCTION****Section I. GENERAL****1-1. SCOPE**

This manual is for your use in operating Radio Sets AN/GRC-106 and AN/GRC-106A. It gives detailed operating instructions, and will tell you how to set up and maintain the equipment. AN/GRC-106(*) will designate both the AN/GRC-106 and AN/GRC-106A.

1-2. CONSOLIDATED INDEX OF ARMY PUBLICATIONS AND BLANK FORMS

Refer to the latest issue of DA Pam 310-1 to determine whether there are new editions, changes or additional publications pertaining to the equipment.

1-3. MAINTENANCE FORMS, RECORDS AND REPORTS

a. *Reports of Maintenance and Unsatisfactory Equipment.* Department of the Army forms and procedures used for equipment maintenance will be those prescribed by DA Pam 738-750 as contained in Maintenance Management Update.

b. *Report of Packaging and Handling Deficiencies.* Fill out and forward SF 364 (Report of Discrepancy (ROD)) as prescribed in AR 735-11-2/DLAR 4140.55/NAVMATINST 4355.73A/AFR 400-54/MCO 4430.3F.

c. *Discrepancy in Shipment Report (DISREP) (SF 361).* Fill out and forward Discrepancy in Shipment Report (DISREP) (SF 361) as prescribed in AR 55-38/NAVSUPINST 4610.33C/AFR 75-18/MCO P4610.19D/DLAR 4500.15.

1-4. ADMINISTRATIVE STORAGE

Administrative storage of equipment issued to and used by Army activities will have preventive maintenance performed in accordance with the PMCS charts before storing. When removing the equipment from administrative storage the PMCS should be performed to assure operational readiness.

1-5. DESTRUCTION OF ARMY ELECTRONICS MATERIEL

Destruction of Army electronics materiel to prevent enemy use shall be in accordance with TM 750-244-2.

1-6. REPORTING EQUIPMENT IMPROVEMENT RECOMMENDATIONS (EIR)

If your AN/GRC-106 needs improvement, let us know. Send us an EIR. You, the user are the only one who can tell us what you don't like about your equipment. Let us know why you don't like the design. Put it on an SF 368 (Quality Deficiency Report). Mail it to Commander, US Army Communications-Electronics Command and Fort Monmouth, ATTN: DRSEL-ME-MP, Fort Monmouth, New Jersey 07703. We'll send you a reply.

1-7. NOMENCLATURE CROSS-REFERENCE LIST

Common names will be used when the major components of the Radio Set are mentioned in this manual.

COMMON NAME	NOMENCLATURE
Radio Set	AN/GRC-106(*)
RT	Receiver-Transmitter, Radio RT-662/GRC or RT-834/GRC
Amplifier	Amplifier, Radio Frequency AM-3349/GRC-106
RT Mount	Mounting MT-3140/GRC-106
Telegraph Key	Key, Telegraph KY-116/U
Loudspeaker	Dynamic Loudspeaker LS-166/U
Headset	Headset, Electrical H-227/U
Handset	Handset, H-33/(*)PT
Microphone	Microphone, Carbon M-29B/U
Antenna	Antenna Group AN/GRA-50

NOTE

Official nomenclature must be used when filling out report forms or looking up Technical Manuals.

1-8. LIST OF ABBREVIATIONS

Abbreviations are spelled out the first time they appear in this manual. A list of abbreviations commonly used in this manual is provided below.

Amplitude modulation	AM
Antenna	ANT
Beat-frequency oscillator	BFO
Continuous wave	CW
Frequency	FREQ
Frequency-shift-keyed	FSK
Ground	GRD
High voltage	HV
Intermediate frequency	IF
Kilohertz	kHz
Megahertz	MHz
Narrow frequency-shift-keyed	NSK
Power	PWR
Primary	PRIM
Receiver	RCVR
Single-sideband	SSB
Upper-sideband	usb

1-9. HAND RECEIPT

This manual has a companion document with a TM number followed by "-HR" (which stands for Hand Receipt). TM 11-5820-520-10-HR consists of preprinted hand receipts (DA Form 2062) that list end item related equipment (i.e., COEI, BII, and AAL) you must account for. As an aid to property accountability, additional -HR manuals may be requisitioned from The US Army Adjutant General Publications Center, Baltimore, MD, in accordance with the procedures in Chapter 3, AR 310-2, and DA PAM 310-10-2.

Section II. EQUIPMENT DESCRIPTION

1-10. EQUIPMENT PURPOSE, CAPABILITIES, AND FEATURES

Radio Set AN/GRC-106(*) is a high frequency, single-sideband receiving/transmitting set.

It is designed as a mobile radio link in a communications network, can be mounted on a ¼ ton vehicle, or used as a fixed mobile station.

The Radio Set transmits: Upper-sideband (usb) signals.
 Usb compatible amplitude-modulated (AM) signals.
 Continuous Wave (CW) signals.
 Frequency-Shift-Keyed (FSK) signals.
 Narrow Frequency-Shift-Keyed (NSK) signals.

The Radio Set receives: Usb compatible AM signals.
 Conventional double-sideband AM signals.
 Continuous Wave (CW) signals.
 FSK signals.
 NSK signals.

1-11. DESCRIPTION OF MAJOR COMPONENTS

- **Radio Set AN/GRC-106(*)** is made up of a receiver/transmitter RT-662/GRC or RT-834/GRC, and. . .
- **Amplifier AM-3349/GRC-106**, which amplifies signals transmitted using RT-662/GRC or RT-834/GRC.
- All operator's controls, meters, power input and power output connectors are on the front panel.

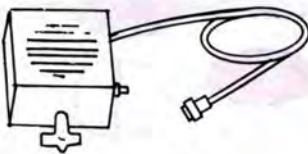
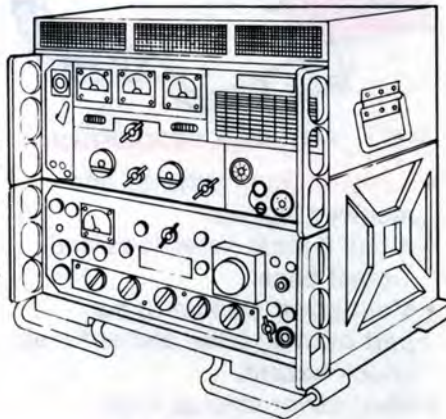

- **Loudspeaker LS-166/U** reproduces audio signals.
- It has a metal case, with connecting cord, housing speaker, matching transformer, and two-position output level switch.

- **Handset H-33(*)/PT** is used to receive and transmit audio signals.
- It has a plastic case with a microphone, earphone, and non-locking push-to-talk switch.

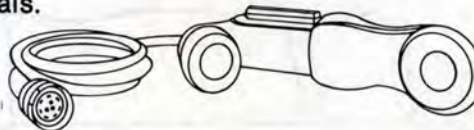



- **Headset** H-227/U reproduces audio signals.
- It has an adjustable headband and two cushioned earpieces with two earphones.

- **Telegraph Key** KY-116/U is used for transmitting Morse Code.
- It is a hand keying device with adjustable metal bank that can be placed around operator's upper leg. It has 4 screws for mechanical adjustments and 2 other screws for connection through Cable CX-1852/U, to Audio on RT-622/GRC.

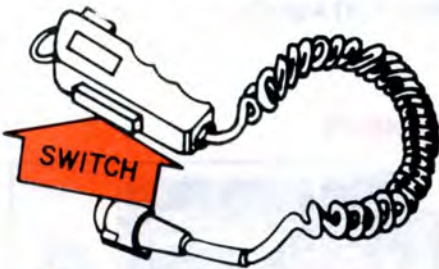

- **Microphone** M-29B/U is used when transmitting voice signals.
- It is a hand-held microphone in a plastic case with a push-to-talk switch.

1-12. ANTENNA DESCRIPTION

- **Whip antenna** radiates and receives signals.
- It has 5 mast sections and 1 mast base.
- Mast cover shields upper part of mast base and reduces shock hazard.
- Mast cover shields mast sections and mast base, reducing shock hazard.
- Mast cover kept in place with a brass antenna sheath clamp.
- Doublet antenna radiates and receives signals.
- Antenna tip is attached to mast section MS-118-A.
- **Canvas bag** CW-206/GR is used to store parts of the whip antenna when they are not being used.

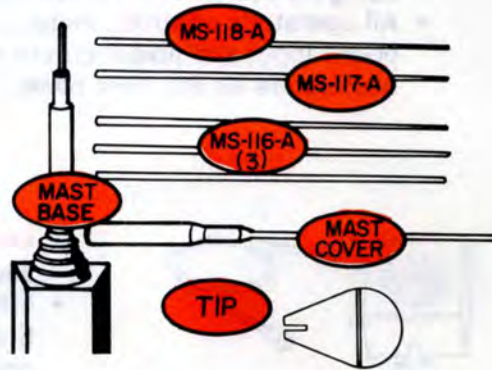

- Mounting equipment MT-3140/GRC-106 is used to stack the amplifier on top of the RT for vehicular installation.

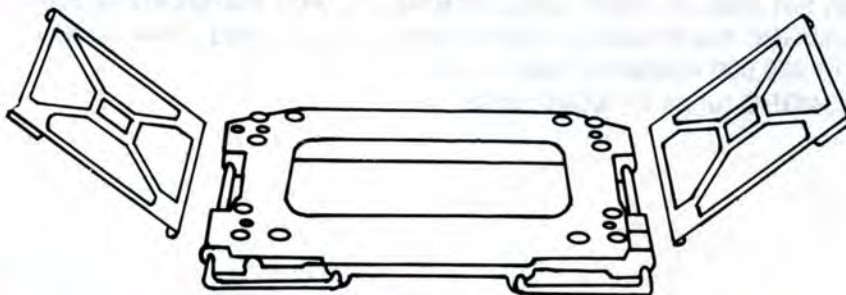

1-13. DIFFERENCES BETWEEN MODELS

- Radio Set AN/GRC-106 uses RT-662/GRC with AM-3349/GRC-106.
- RT-662/GRC has 5 tuning controls which can be used to select any one of 28,000 operating frequencies.
- RT-662/GRC tunes in 1-kHz units.

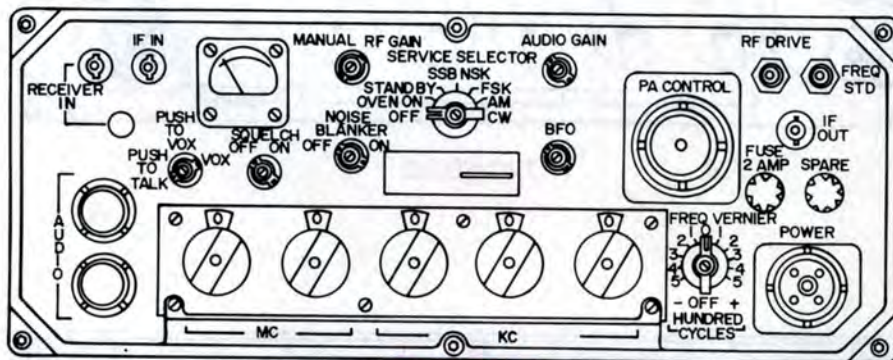

RT-662/GRC

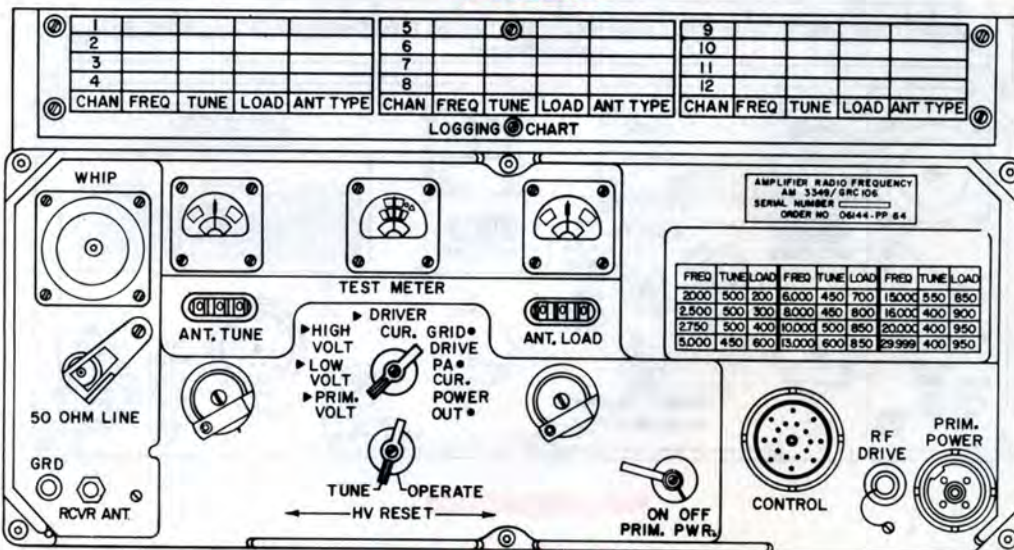

AM-3349/GRC-106

- Radio Set AN/GRC-106 A uses RT-834/GRC with AM-3349/GRC-106.
- RT-834/GRC has 6 tuning controls which can be used to select any one of 280,000 operating frequencies.
- RT-834/GRC tunes in 100-Hz units.

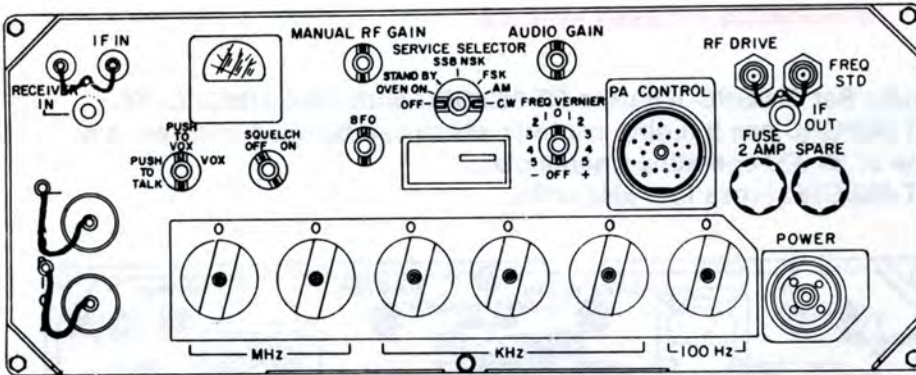

RT-834/GRC

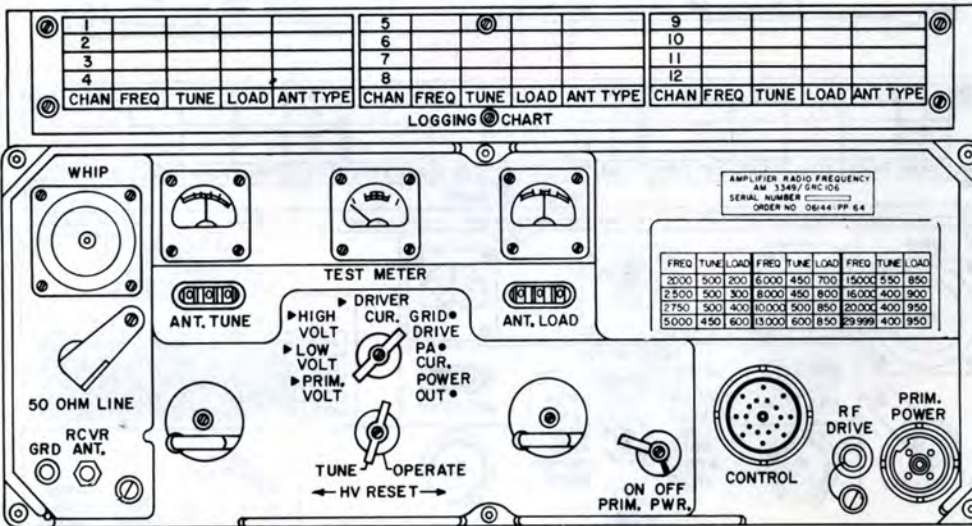

AM-3349/GRC-106

1-14. PERFORMANCE DATA

WEIGHTS and DIMENSIONS

	Height IN. (CM)	Depth IN. (CM)	Width IN. (CM)	Weight LBS. (KG)
RT-662/GRC	7 (17.75)	13 (33)	18 (45.5)	51 (23.5)
RT-834/GRC	7 (17.75)	13 (33)	18 (45.5)	46.5 (21)
AM-3349/GRC-106	9 (22.8)	13 (33)	18 (45.5)	71.5 (32.3)

RT-662/GRC and RT-834/GRC PERFORMANCE DATA

- TYPE OF RECEIVER Superheterodyne with triple conversion.
- BANDWIDTH 3.2 kHz.
- FREQUENCY RANGE 2.0 to 29.999 MHz.
- TYPES OF TRANSMISSION Upper-sideband
 Usb compatible AM
 Continuous Wave
 Frequency-shift-keyed
 Narrow Frequency-shift-keyed.
- TYPES OF RECEPTION Usb signals, usb compatible and conventional double-sideband AM
 Continuous wave
 Frequency-shift-keyed
 Narrow frequency-shift-keyed.
- PRIMARY VOLTAGE 28 volts direct current.

POWER REQUIREMENTS

- OVEN ON 16.2 watts to begin; 2.7 watts after warm up.
- STAND BY 14 watts average.
- SSB NSK 36 watts average to receive, 45 watts average to transmit.
- FSK 36 watts average to receive, 45 watts average to transmit.
- AM 36 watts average to receive, 45 watts average to transmit.
- CW 36 watts average to receive, 45 watts average to transmit.
- RF POWER OUTPUT 0.1 watt peak effective power.

AM-3349/GRC-106 PERFORMANCE DATA

FREQUENCY RANGE 2.0 to 29.999 MHz.
INPUT IMPEDANCE..... 50 ohms.
OUTPUT IMPEDANCE..... Output No. 1...50 ohms.
Output No. 2...to match 15 foot whip antenna.
PRIMARY VOLTAGE 28 volts direct current.

POWER REQUIREMENTS

STAND BY 250 watts average.
OPERATE 250 watts average.
TRANSMIT TWO-TONE 1,000 watts average.
TRANSMIT VOICE 800 watts average.

POWER OUTPUT

CW About 200 watts.
COMPATIBLE AM About 200 watts (with two-tone signal).
SSB VOICE About 200 watts.
FSK OR NSK VOICE About 200 watts.
NSK About 200 watts.
ANTENNA..... 15 foot whip or doublet (50 ohms).
EFFECTIVE RANGE 20 miles planning range (ground wave);
80 miles and farther (skywave); depending on terrain, frequency, antenna, time of day, and atmospheric conditions.

Section III. TECHNICAL PRINCIPLES OF OPERATION

1-15. TRANSMITTING AND RECEIVING SIGNALS - RADIO SET AN/GRC-106(*)

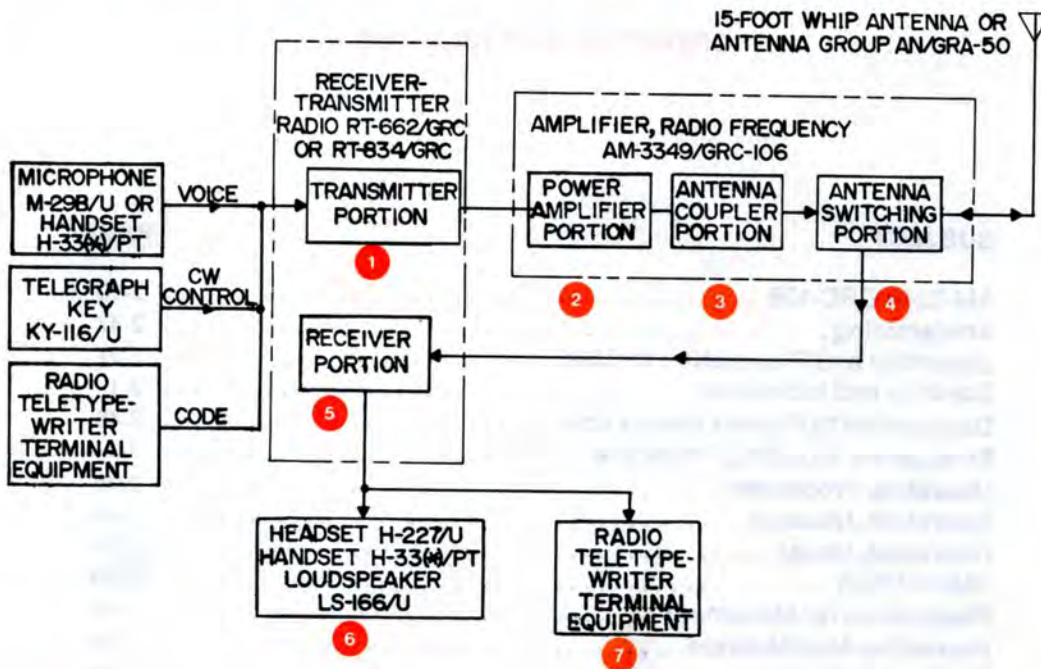

- 1 Voice, cw and code signals are applied to TRANSMITTER PORTION of RT unit, where they are modulated and converted into a Radio Frequency (RF) signal.
- 2 This RF signal is applied to POWER AMPLIFIER PORTION of Amplifier, where its level is raised to a nominal 400 watts peak envelope power (pep).
- 3 It is then applied to ANTENNA COUPLER PORTION, where it is sent through switching and impedance-matching circuits for transmission. The ANTENNA COUPLER PORTION matches the 15-FOOT WHIP ANTENNA or ANTENNA GROUP AN/GRA-50 to POWER AMPLIFIER PORTION to ensure proper power transfer.
- 4 All incoming signals are received by the ANTENNA SWITCHING PORTION of Amplifier . . .
- 5 . . .and applied to RT RECEIVER PORTION.
- 6 Usb, usb compatible am, cw and conventional double-sideband am signals are converted into Intermediate Frequency (IF) signals for monitoring by HEADSET H-227/U, HANDSET H-33(*)/PT or LOUDSPEAKER LS-166/U.
- 7 Fsk or nsk signals are also converted into IF signals and applied to RADIO TELETYPEWRITER TERMINAL EQUIPMENT for transferral to page printers or tape punches for message interpretation.

CHAPTER 2
OPERATING INSTRUCTIONS

SUBJECT	PAGE
AM-3349/GRC-106	2-10
Antijamming	2-47
Assembly and Preparation for Use	2-21
Controls and Indicators	2-1
Destruction to Prevent Enemy Use	2-48
Emergency Stopping Procedure	2-44
Operating Procedure	2-40
Operation, Unusual	2-46
Operation, Usual	2-21
PMCS Chart	2-20
Preparation for Movement	2-45
Preventive Maintenance	2-16
Radio Jamming	2-46
RT-662/GRC and RT-834/GRC	2-1
Starting Procedure	2-32
Stopping Procedure	2-44
To Receive Signals	2-40
To Transmit Signals	2-41
Tuning Procedure	2-34
Warm Up Procedure	2-29

Section I. DESCRIPTION AND USE OF OPERATOR'S CONTROLS AND INDICATORS

2-1. GENERAL

As operator of Radio Set AN/GRC-106(*), you will be working with the following controls and indicators.



To prevent electrical shocks or damage to the equipment, do not operate this radio until you understand the operation and function of all controls, indicators, and connectors.

2-2. RT-662/GRC AND RT-834/GRC

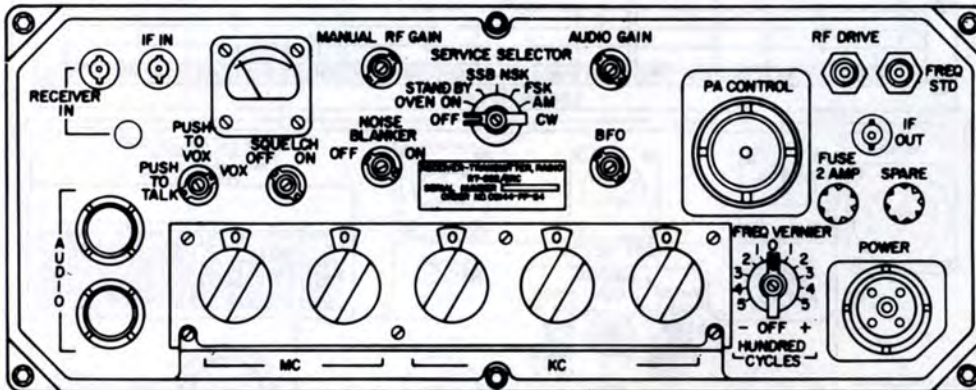

RT-662/GRC

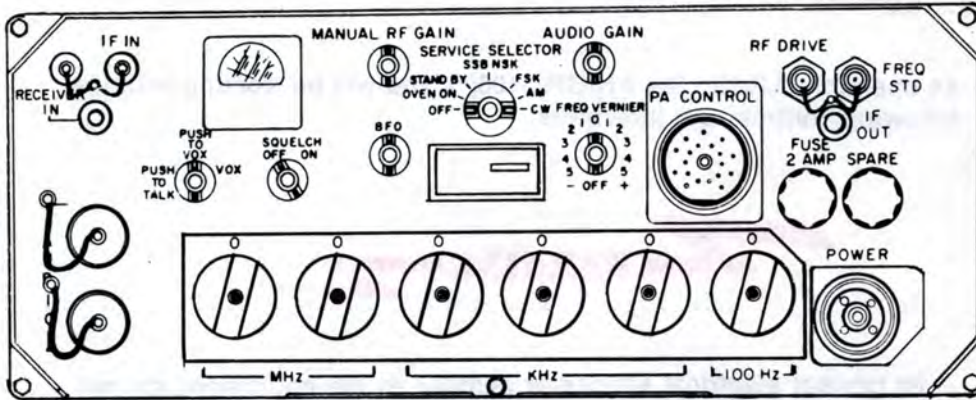

RT-834/GRC

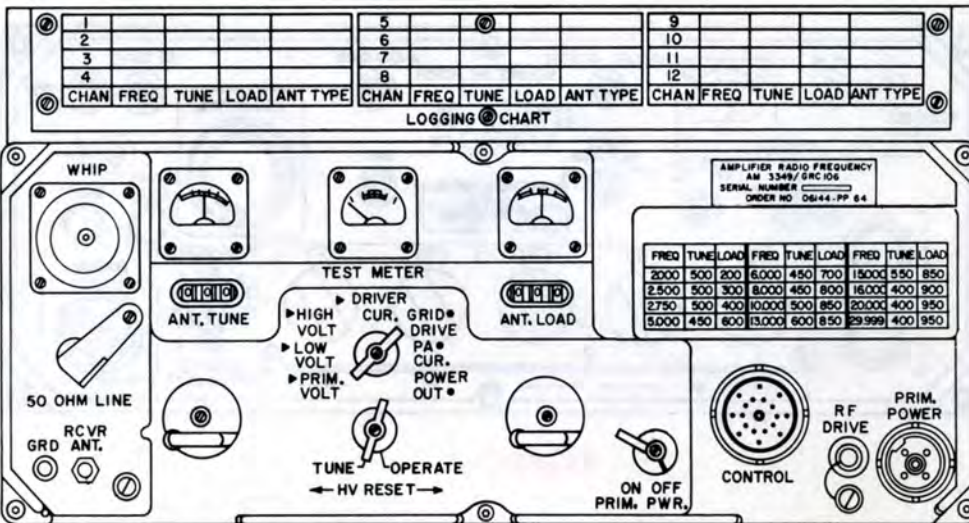

AM-3349/GRC-106

RECEIVER IN

- The RECEIVER IN connection to RCVR ANT. (Receiver Antenna) connection on amplifier uses Cable Assembly, Radio Frequency CG-409/U.

NOTE

The illustrations in this section refer to RT-622/GRC.

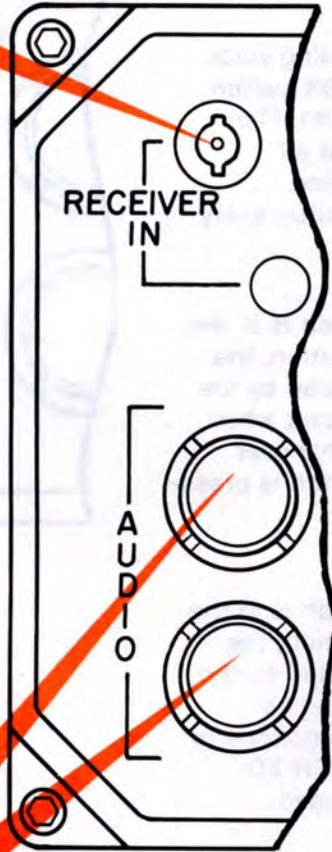

SPRING-LOADED POST

- Connects antenna when RT-662/GRC or RT-834/GRC is used only as receiver.
- Connects signals coming from amplifier to RT.

AUDIO

- Operator connects microphone, handset, headset, loudspeaker or telegraph key to audio receptacles.
- Either top or bottom receptacle can be used.

VOX

- Voice transmission switch that provides vox capability.
- Vox is a way of sending voice signals when the VOX switch is in the **VOX** position. The microphone is live at all times. Operator's voice activates the transmitter every time he speaks.
- When the VOX switch is in the **PUSH TO TALK** position, the transmitter is activated by the microphone or handset when the microphone or handset **PUSH TO TALK** switch is pressed.
- When the VOX switch is in the **PUSH TO VOX** position, the transmitter is activated by the operator's voice when he speaks into the microphone or handset and the **PUSH TO TALK** switch is pressed.

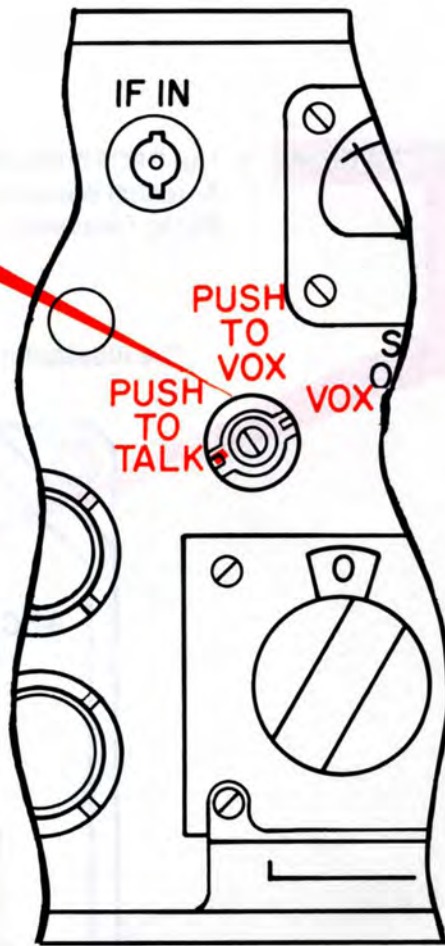

SIGNAL LEVEL METER

- Provides indication of RF power output when transmitting.
- Provides indication of RF input signal level when receiving.

MANUAL RF GAIN

- Adjusts gain of receiver to compensate for weakness of incoming signal.

NOISE BLANKER

- In ON position, reduces static and other man-made interference.

SQUELCH

- In the ON position, removes most receiver background noise when signals are not being received.

NOTE

RT-834/GRC does not have a front panel NOISE BLANKER control.

IF IN

- This connector is for use by maintenance people.

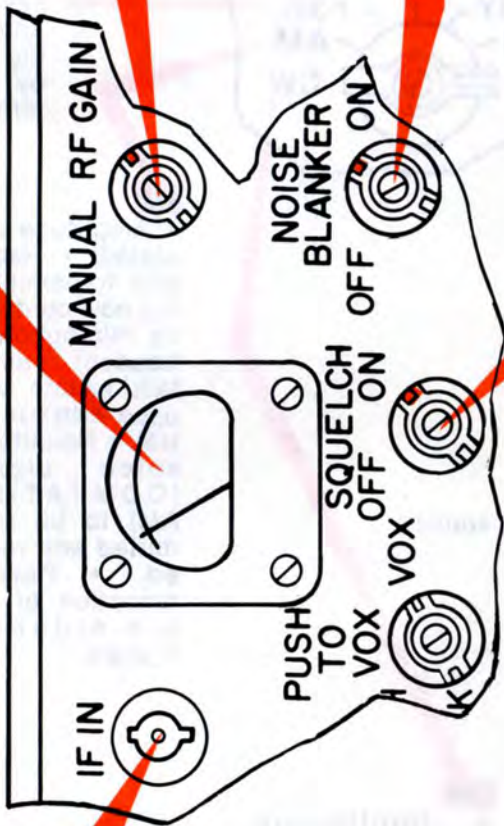

SERVICE SELECTOR

Using the SERVICE SELECTOR switch, the operator selects modes of radio operation.

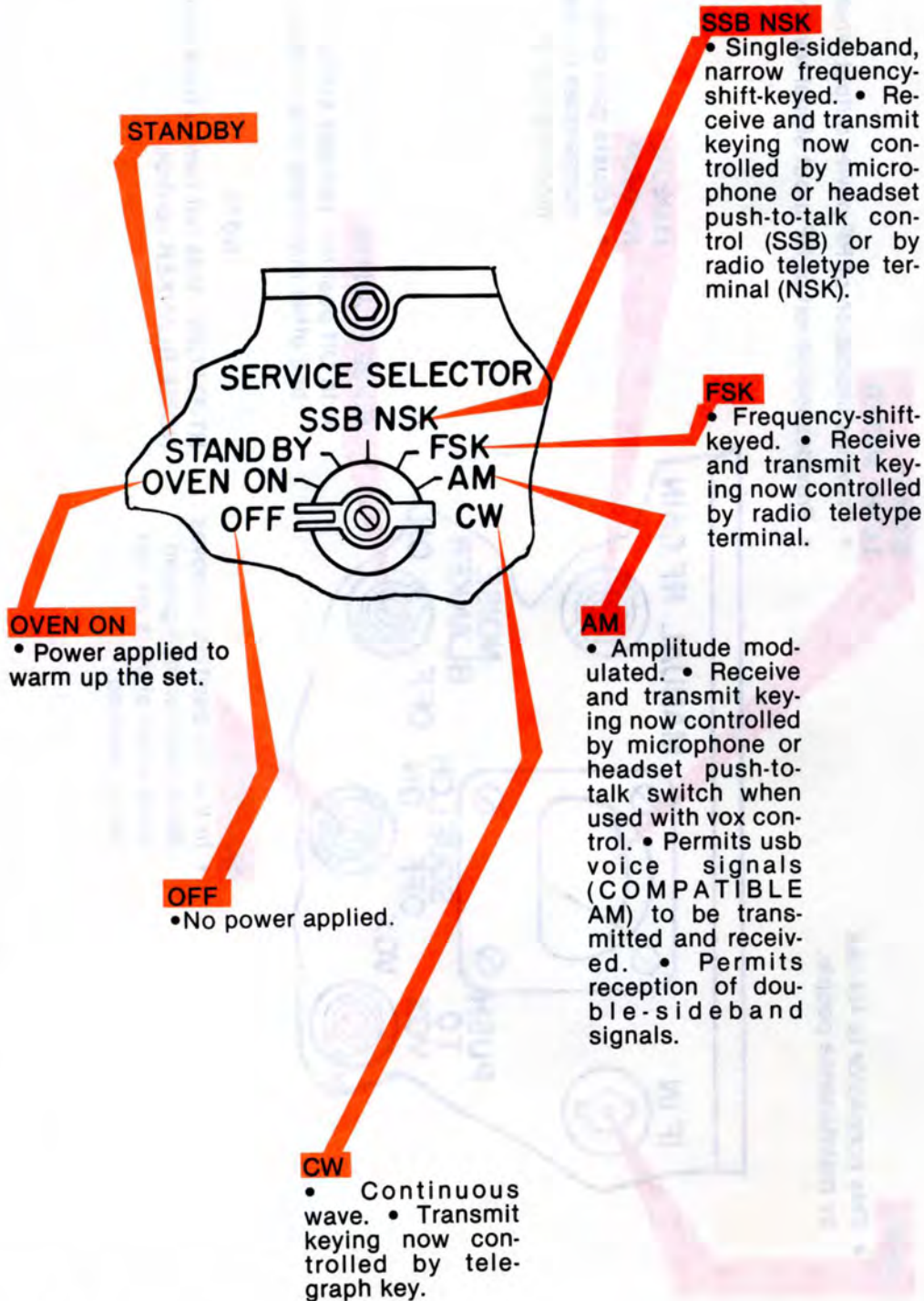

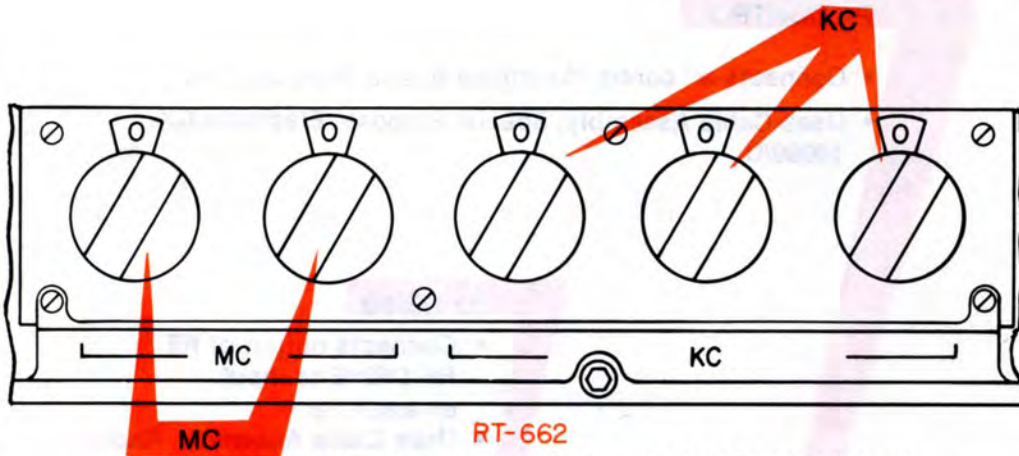

- Operator uses these controls to choose the numbers of the frequency selected.

NOTE

RT-834/GRC has an extra frequency control for selecting 100 Hz digits. It also uses megahertz (MHz) and kilohertz (kHz) instead of megacycle (MC) and kilocycle (KC).

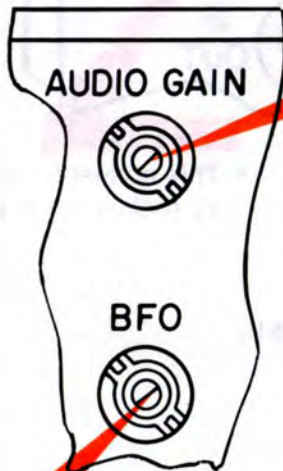

AUDIO GAIN

- Adjusts audio output for comfortable listening level.

BFO

- Beat frequency oscillator control.
- Adjusts CW audio for a comfortable tone.

PA CONTROL

- Connects all control functions to and from amplifier .
- Uses Cable Assembly, Special Purpose, Electrical CX-10099/U.

RF DRIVE

- Connects output of RT RF DRIVE to input on amplifier.
- Uses Cable Assembly, Radio Frequency CG-409H/U.

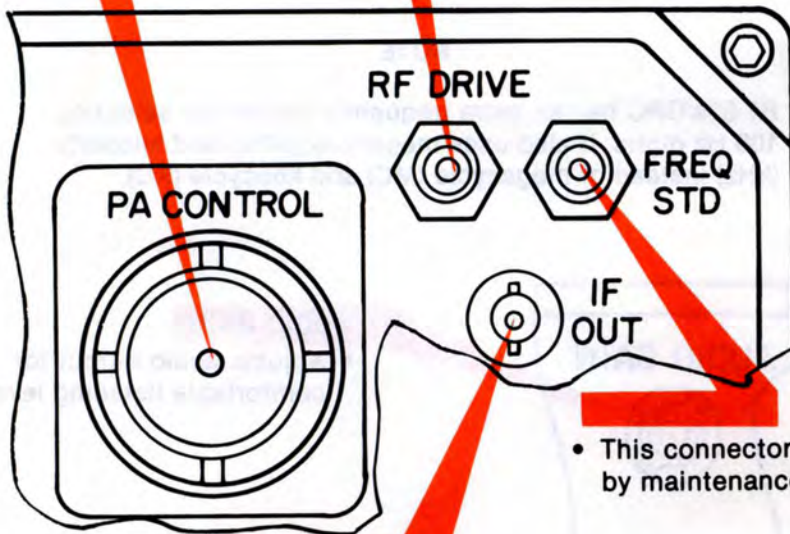

- This connector is used by maintenance people.

IF OUT

- This connector is used by maintenance people.

FUSE

- FUSE 2 AMP protects 28 volt dc input.
- SPARE contains extra 2 AMP fuse.

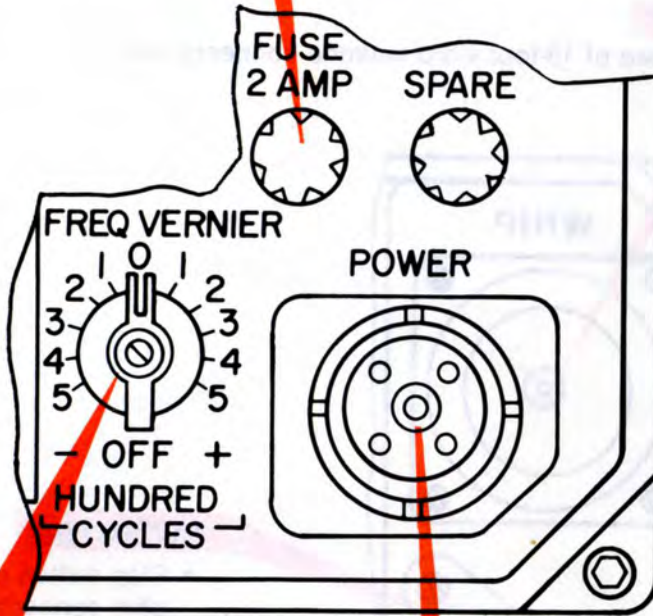

FREQ VERNIER

- Fine tuning control for improving the reception of an incoming signal.

RT-662/GRC

POWER

- Connects 28 volt dc power.
- Uses Cable Assembly, Special Purpose, Electrical CX-10071/U.

WARNING

Be very careful when you are working around these antennas and antenna connectors. High voltages exist at these points.

WHIP

- Lead of 15-foot whip antenna connects here.

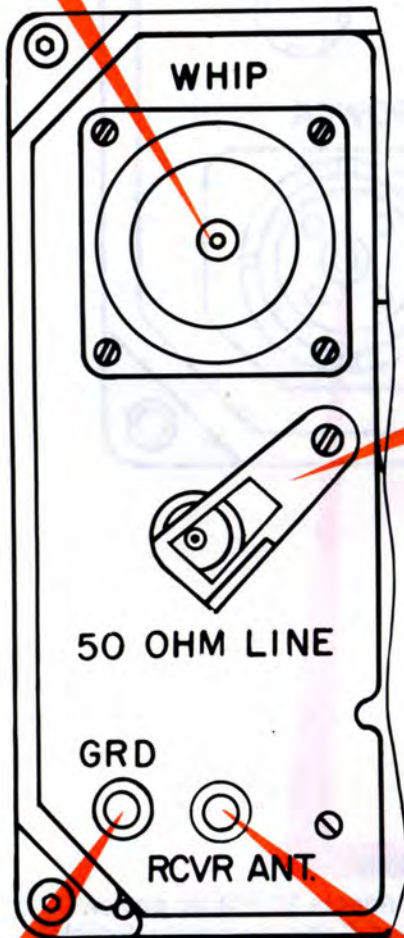

50 OHM LINE

- Flag switch covers 50 ohm connector.
- Connects doublet antenna.

GRD

- Spring-loaded binding post for grounding radio set to vehicle chassis.

RCVR ANT.

- Receiver antenna connector.
- Connects RCVR ANT. output to RECEIVER IN input on RT when radio set is receiving.



ANTENNA TUNE METER

- Shows degree of mistuning between antenna and amplifier.

ANTENNA TUNE COUNTER

- This is set using ANTENNA TUNE control to match setting on ANTENNA TUNING/LOADING CHART.

ANTENNA TUNE CONTROL

- Used with ANTENNA LOAD control to match antenna load to 50 ohm output of amplifier.

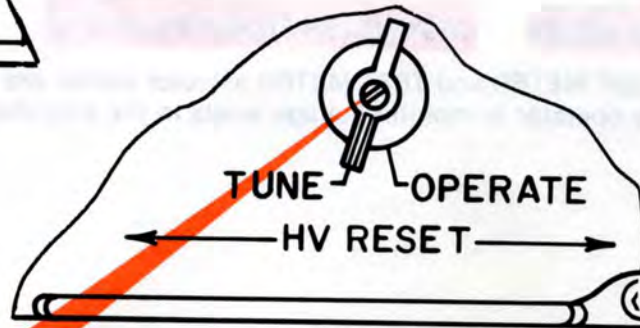

HV RESET

- High voltage reset switch.
- This is an overload relay.
- OPERATE is normal position.
- TUNE position is only used during tuning and loading.

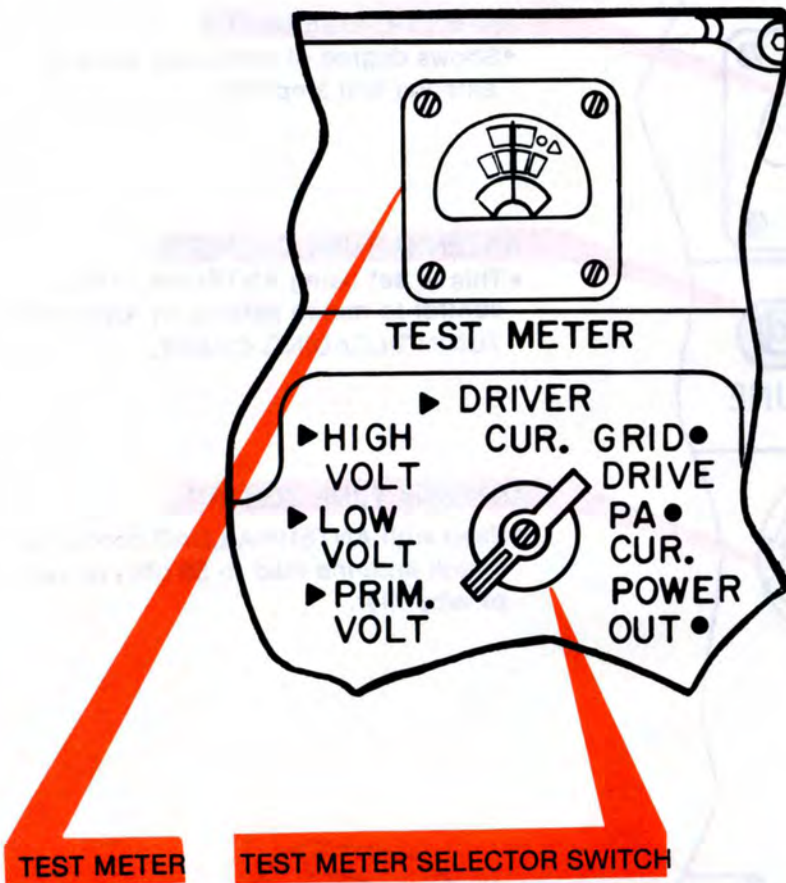

- TEST METER and TEST METER selector switch are used by operator to monitor voltage levels in the amplifier.

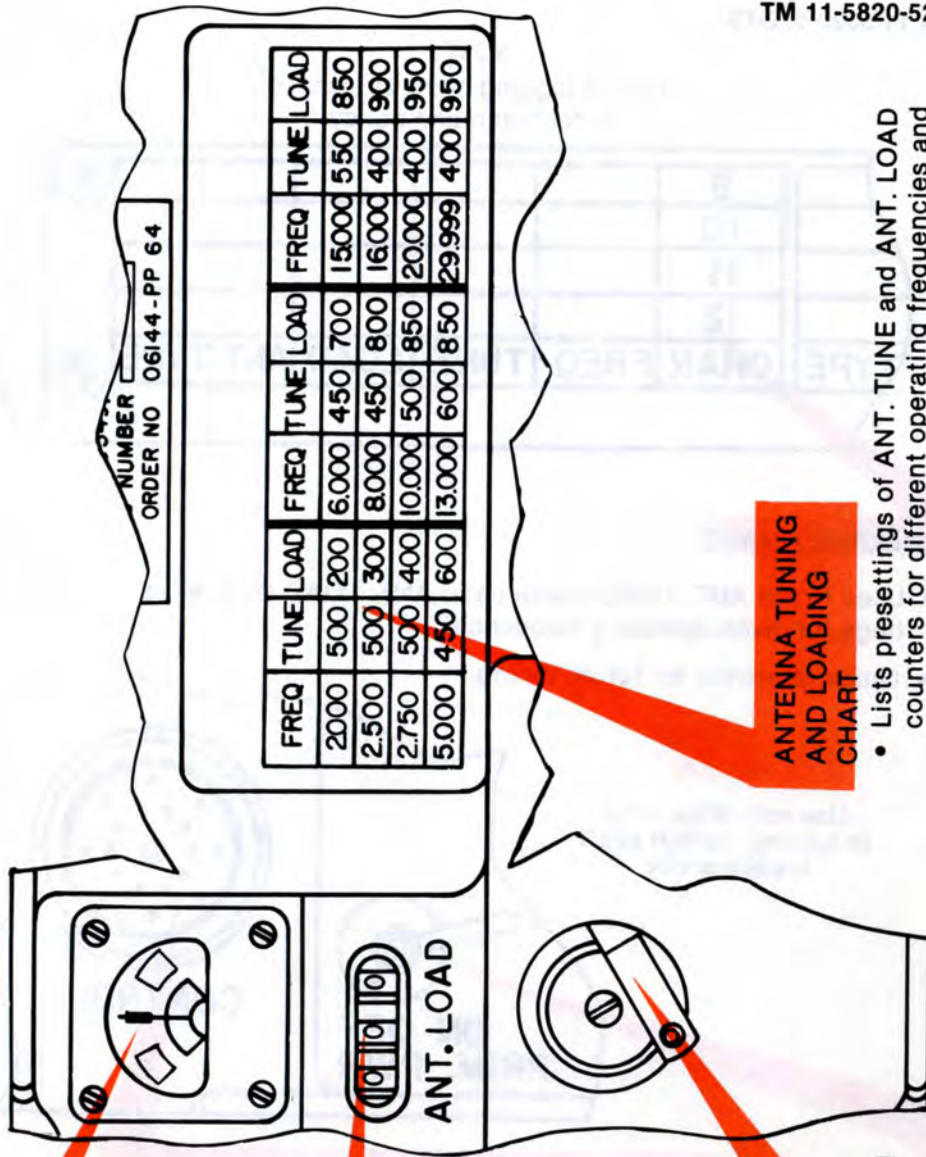

ANTENNA LOAD METER

- Shows degree of mistuning between antenna and amplifier.

ANTENNA LOAD CONTROL

- This is set using ANTENNA LOAD control to match setting on ANTENNA TUNING/LOADING CHART.

ANTENNA TUNE CONTROL

- Used with ANTENNA TUNE control to match antenna load to 50 ohm output of amplifier.

ANTENNA TUNING AND LOADING CHART

- Lists presettings of ANT. TUNE and ANT. LOAD counters for different operating frequencies and types of antennas.

NOTE

Use of logging chart subject to local command policy.

	9					
	10					
	11					
	12					
TYPE	CHAN	FREQ	TUNE	LOAD	ANT	TYPE

LOGGING CHART

- Used to list ANT. TUNE counter and ANT. LOAD counter settings for given operating frequencies.
- Quick reference for future tuning.

CAUTION

Use very little force in turning; switch shaft breaks easily.

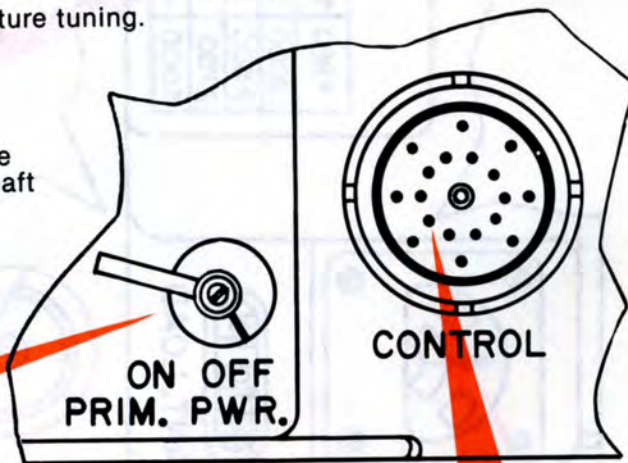

CONTROL

- Connects all controlling functions to and from RT and amplifier PA CONTROL.
- Uses Cable Assembly, Special Purpose, Electrical CX-10099/U.

PRIM. PWR.

- Primary Power Switch.
- Applies primary voltage when RT SERVICE SELECTOR switch is in any position other than OFF or OVEN ON.
- Automatically removes primary power when overloaded.
- To reset, set switch at OFF, then ON.

RF DRIVE

- Radio Frequency Drive Connector.
- Connects RF DRIVE output signals from RT to RF DRIVE amplifier input.
- Uses Cable Assembly, Radio Frequency CG-409H/U.

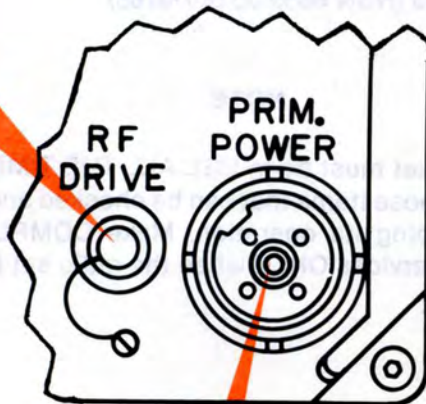

PRIM. POWER

- Primary power connector.
- Connects 28 volt dc power.
- Uses Cable Assembly, Special Purpose, Electrical CX-10071/U.

Section II. PREVENTIVE MAINTENANCE CHECKS AND SERVICES**2-4. PREVENTIVE MAINTENANCE**

Operator's Preventive Maintenance Checks and Services (PMCS) is the required daily and weekly inspection and care of your equipment necessary to keep it in good operating condition.

a. Tools, Materials, and Equipment Required For Maintenance

No tools or equipment are required for operator maintenance. The following cleaning materials will be useful to the operator:

- Lint-free cloths
- Soft bristle brush
- Dishwashing compound or detergent
- Cleaning compound (NSN 6859-00-597-9765)

NOTE

If your radio set must be in **USE ALL THE TIME**, check and service those items that can be checked and serviced without stopping its operation. Make **COMPLETE** checks and services **ONLY** when the radio set is finally **SHUT DOWN**.

b. Routine Checks

Routine services are a collection of checks and observations performed by the operator at all times. Routine services are not listed in the preventive maintenance checks and services table, in order to separate the nonoperational from the operational services.

You should perform the following routines as necessary.

- Clean
- Dust
- Wash
- Check for cut or frayed cables
- Check for dented, bent, or broken components
- Check to see that items not in use are properly stored
- Check for rusting
- Check controls for smooth operation
- Check for completeness and current changes to publications.

- Cover unused receptacles
- Check for loose nuts, bolts, and connectors
- Check that grounds are not damaged and that connections are securely attached
- Check for completeness of equipment

Service the following items:

- Radio antennas
- Radio equipment
- Transmitter heat exchanger

c. Explanation of INTERVAL column of PMCS chart

NOTE

Always keep in mind all WARNINGS and CAUTIONS when PMCS are performed.

WEEKLY - Do your Weekly (W) PMCS to insure that the radio set is functioning properly.

MONTHLY - Do your Monthly (M) PMCS to insure that the radio set is functioning properly.

NOTE

ALL PMCS must be done as regularly scheduled and also under the following conditions:

- Before the radio set is used on a mission.
- When the radio set is first installed.
- When the radio set is re-installed after being removed for any reason.
- When you are operating the radio set for the first time.

**d. Explanation of EQUIPMENT IS NOT READY/AVAILABLE IF:
column of PMCS chart.**

- This column tells the condition under which the equipment cannot perform the assigned mission requirements.

NOTE

The procedures column in your PMCS chart tells you how to perform the required checks and services. Carefully follow these instructions. If tools are needed, or the chart instructions tell you, get organizational maintenance to do the necessary work.

NOTE

If any portion of your radio set fails to operate refer to Chapter 3 under Troubleshooting for possible problems. Report any malfunctions or failures on the proper DA Form 2404 or refer to **DA Pam 738-750**.

DA FORM 2404, EQUIPMENT INSPECTION AND MAINTENANCE WORKSHEET.

EQUIPMENT INSPECTION AND MAINTENANCE WORKSHEET					
For use of this form, see TM 38-750; the proponent agency is the Office of the Deputy Chief of Staff for Logistics					
1. ORGANIZATION B 1/30 FA			2. NOMENCLATURE AND MODEL RADIO SET AN/GRC - 106		
3. REGISTRATION/SERIAL/FSN 523		4a. MILES	b. HOURS	c. ROUNDS FIRED	d. HOT STARTS
				5. DATE	6. TYPE INSPECTION WEEKLY
7. APPLICABLE REFERENCE					
TM NUMBER TM 11-5820-520-10		TM DATE DEC '80		TM NUMBER	TM DATE
<p>INSTRUCTIONS - Perform each check listed in the TM applicable to the inspection performed. Following the sequence listed in pertinent TM, complete form as follows:</p> <p>COLUMN a - Enter TM item number.</p> <p>COLUMN b - Enter the applicable condition status symbol.</p> <p>COLUMN c - Enter deficiencies and shortcomings.</p> <p>COLUMN d - Show corrective action for deficiency or shortcoming listed in Column c.</p> <p>COLUMN e - Individual ascertaining completed corrective action initial in this column.</p>					
ALL INSPECTIONS AND EQUIPMENT CONDITIONS RECORDED ON THIS FORM HAVE BEEN DETERMINED IN ACCORDANCE WITH DIAGNOSTIC PROCEDURES AND STANDARDS IN THE TM CITED HEREON.					
8a. SIGNATURE (Person(s) performing inspection)		b. TIME	9a. SIGNATURE (Maintenance Supervisor)		b. TIME
					10. MANHOURS REQUIRED
ALL INSPECTIONS AND EQUIPMENT CONDITIONS RECORDED ON THIS FORM HAVE BEEN DETERMINED IN ACCORDANCE WITH DIAGNOSTIC PROCEDURES AND STANDARDS IN THE TM CITED HEREON.					
TM ITEM NO.	STATUS	DEFICIENCIES AND SHORTCOMINGS		CORRECTIVE ACTION	INITIAL WHEN CORRECTED
e	b	c		d	e
3		MISSING FUSE		REPLACED FUSE	JL



Table 2-1. PREVENTIVE MAINTENANCE CHECKS AND SERVICES (PMCS)

W - Weekly
M - Monthly

ITEM NO.	INTERVAL		ITEM TO BE INSPECTED PROCEDURE	EQUIPMENT IS NOT READY/AVAILABLE IF
	W	M		
1	●		<p>Antenna Remove the antenna sections and the base from the vehicle. Clean and service the antenna and base.</p>	<p>Equipment will not operate in the required mode and failure prevents performance of mission.</p>
2	●		<p>Radio set AN/GRC-106(*) Operate the equipment as described in Section III, Chapter 2 of this manual.</p>	
3		●	<p>Fuses Check spare fuses for proper quantity, type and value.</p>	
NOTE				
<p>If the equipment has been operated within the last week, weekly requirement Number 2 has been met.</p>				

Section III. OPERATION UNDER USUAL CONDITIONS

2-6. ASSEMBLY AND PREPARATION FOR USE

a. MOUNTING PROCEDURE

- Grasp the release handles on RT Mount and pull them forward from their securing holes while turning them toward the outside of the unit.

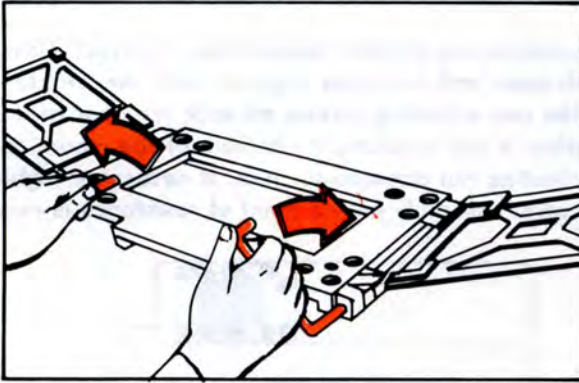
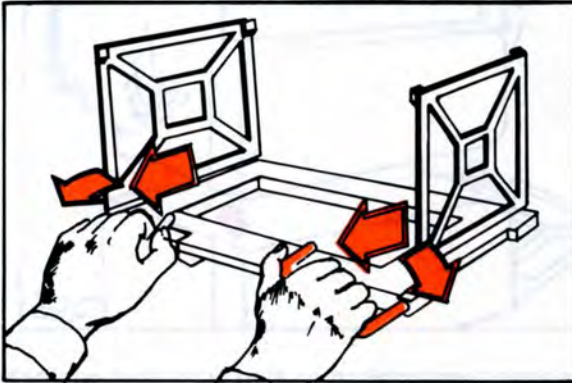

- Position RT on RT Mount so that the cleats on the bottom of the RT unit sit securely in the holes of RT Mount.

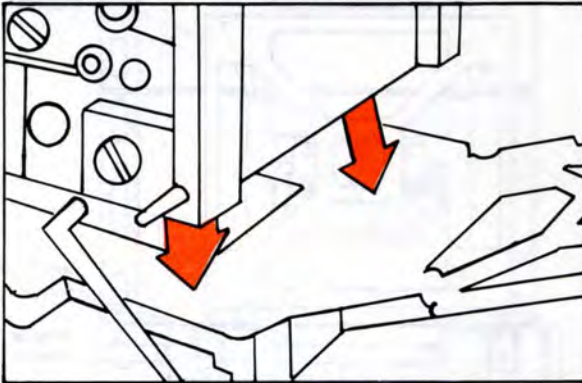
**NOTE**

For installation requiring side-by-side mounting of the RT and Amplifier, two sets of shorter crossbar assemblies and another RT Mount would be needed.

TM 11-5820-520-10

- Position Amplifier on top of the RT or on a separate RT Mount depending on the type of installation you are using. Set the cleats on the bottom of Amplifier into the matching holes on the top of the RT.

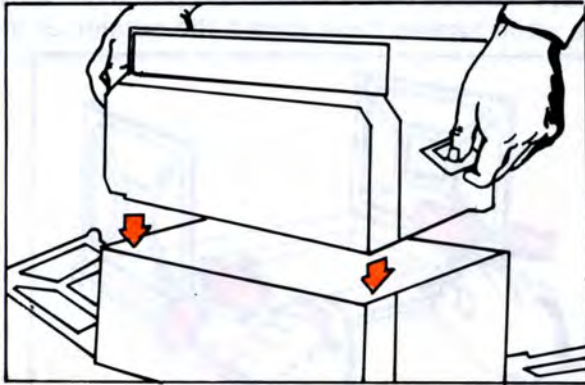

- Position the crossbar assemblies so that they rest against the side of the unit.
- Be sure the tension on the crossbar assemblies is correct. Using one of the 1/2-by 9/16-inch open end wrenches supplied with the Tool Kit-101/G, alternately tighten the two adjusting screws on each crossbar assembly until the respective crossbar is just touching the bottom of the mounting notch. Tighten each adjusting nut one-quarter turn. If necessary, tighten the Allen screws in each pivot assembly until a point of resistance is reached.

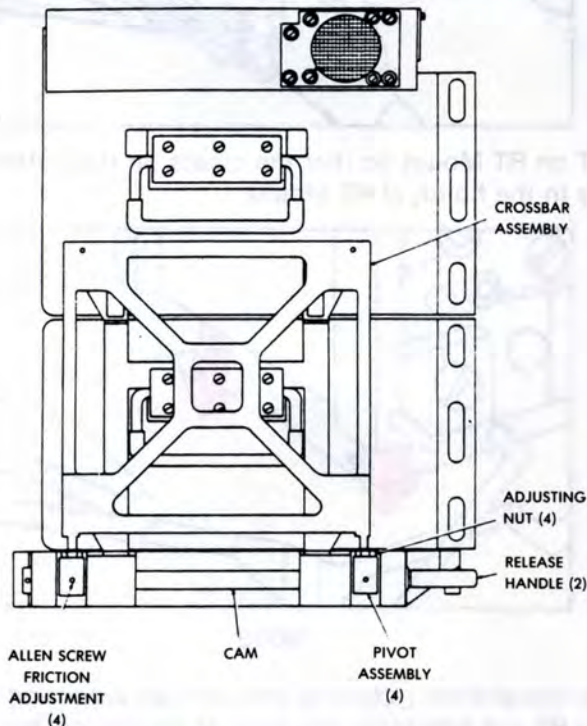

- Radio Set AN/GRC-106(*) is now mounted.

- Grasp the release handles on RT Mount and pull them forward while turning them toward the outside of the unit. Rotate the handles back and push them into the holes in the front of RT Mount. If the tension is correct, no binding will occur and the equipment will be secured on RT Mount.

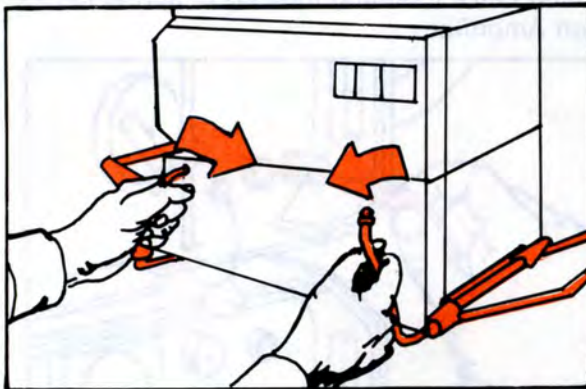
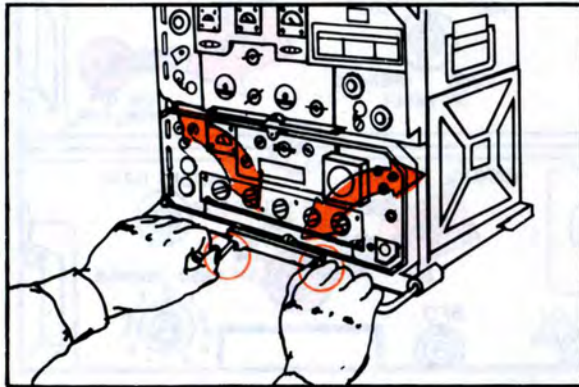

- Radio Set AN/GRC-106(*) is now mounted.

NOTE

Crew is authorized use of Tool Kit-101/G in MAC.



Dangerous voltages exist at the Amplifier 50 OHM LINE and whip antenna connectors. Be very careful when working with the antenna and antenna connectors.

b. GROUNDING AN/GRC-106(*)

- Set Amplifier PRIM. PWR. switch and RT SERVICE SELECTOR switch to OFF.

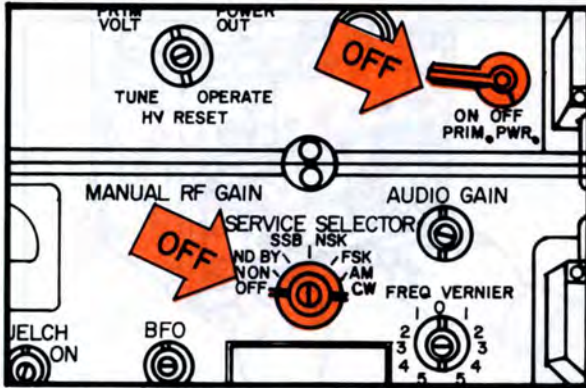

- Connect ground cable (bonding jumper) to spring-loaded ground binding post (GRD) on Amplifier.

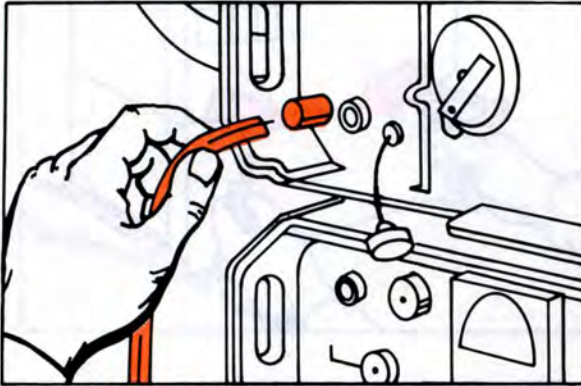

- Connect lug at end of grounding cable to chassis of vehicle.

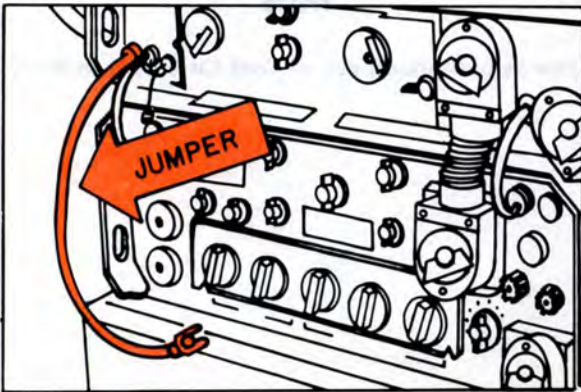

c. CONNECTING ANTENNA

- Make sure Amplifier PRIM. PWR. and RT SERVICE SELECTOR switches are OFF.

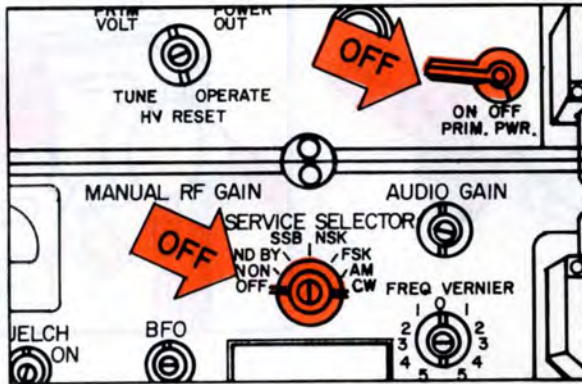

NOTE

Check the overhead area to see that there are no power lines in the immediate area.

- Assemble a 15-foot whip antenna by screwing together three Mast Sections MS-116A. Then screw Mast Section MS-117A into the top of the three MS-116A's just joined. Finally screw Mast Section MS-118A into the top of MS-117A.

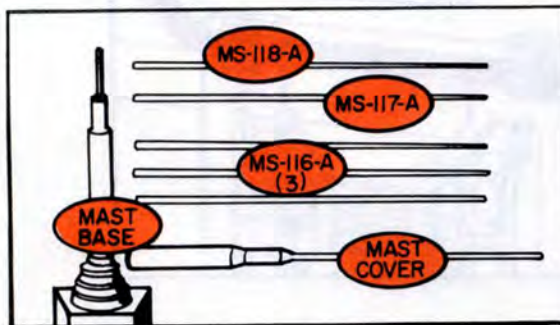

- Slide mast antenna cover over the assembled mast sections and screw into Mast Base AB-652/GR. The Mast Base is mounted to the mast bracket secured to the vehicle.

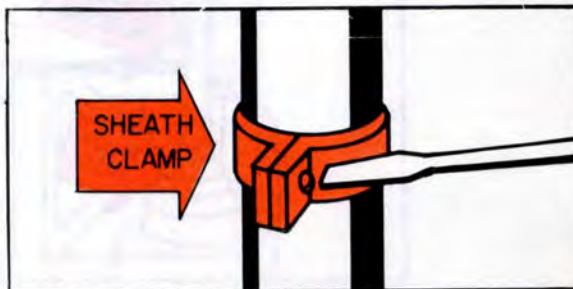

- Keep antenna cover in place by attaching and carefully tightening antenna sheath clamp. The whip antenna is now assembled and installed.

TM 11-5820-520-10

- Connect antenna lead connector to whip antenna terminal on Amplifier. Use electrical lead CX-10171/U.

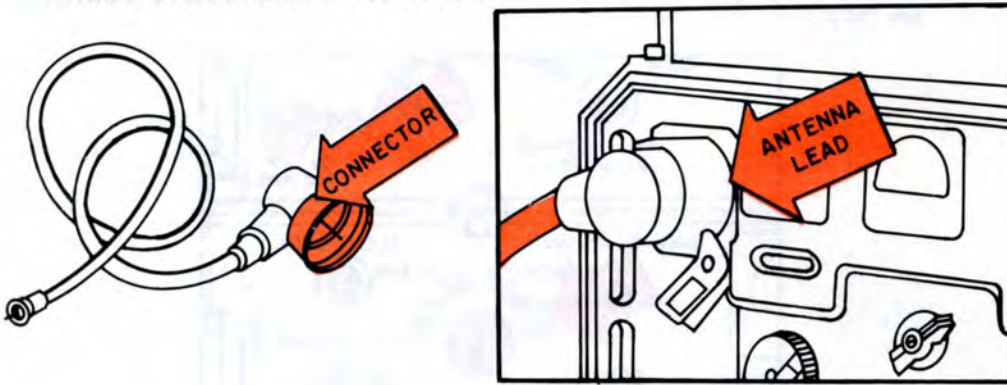

- Thread the antenna lead through insulators on left hand crossbar assembly. Connect the other end to binding post on AB-652/GR. Amplifier is now grounded and the antenna is connected.

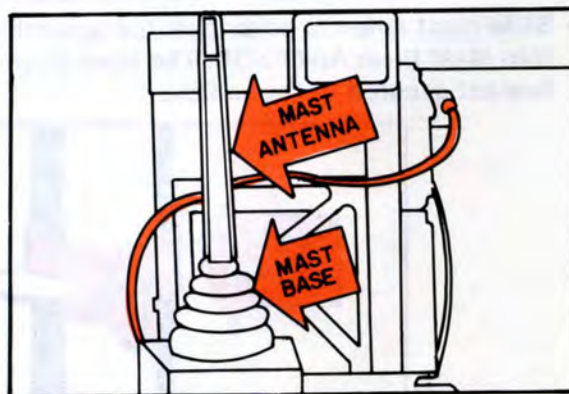
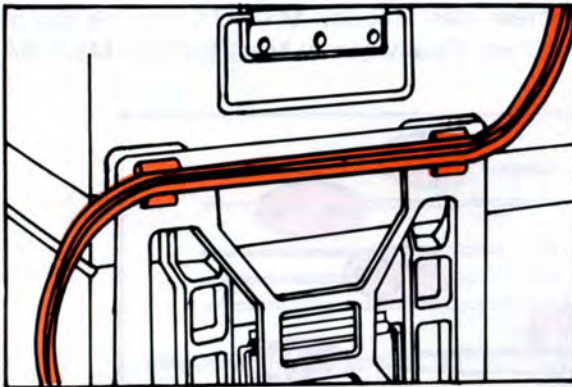

NOTE

To install Antenna Group AN/GRA-50 (Doublet Antenna), refer to TM 11-5820-467-15. Connect the AN/GRA-50 radio frequency (rf) transmission cable to the AM-3349/GRC 50 OHM LINE receptacle.

CAUTION

Before connecting Cable Assembly, Special Purpose, Electrical CX-10071/U to POWER jack on RT, be sure both pins C and D on J24 are grounded. If only one pin has been grounded, the lead between the pin and ground might not handle the load and burn open. If measurements indicate that only one pin is grounded, request a higher category of maintenance to ground the other pin.

d. TYPICAL CONNECTIONS

The figure on the following page is for typical connections of radio sets AN/GRC-106(*).

- Connect one Cable Assembly, Special Purpose, Electrical CX-10071/U to the Amplifier PRIM. PWR. connector and one to the RT POWER connector. Dress these two cables along the vehicle chassis according to the installation unit instructions.
- Cut these cables to the required length. Solder two terminal lugs or a power connector to the cable leads. Connect one terminal lug to the positive center conductor and the other terminal lug to the negative braided loom shield. Connect the terminal lugs or the power connector to the dc source.
- These two CX-10071/U can be connected to a 27-volt dc power source by one of the following methods:
 1. Directly to vehicle battery.
 2. To vehicle battery through Electrical Transient Suppressor, MX-7778/GRC (TM 11-5915-223-12).
 3. To a dc power source, such as PP-4763/GRC (TM 11-5820-765-12).
- Connect one Cable Assembly, Special Purpose, Electrical CX-10099/U to Amplifier CONTROL connector and RT unit PA CONTROL connector by turning screw handle on CX-10099/U to the right until it is firmly attached to the cable connectors.
- Connect one Cable Assembly Radio, Frequency CG-409H/U to Amplifier RF DRIVE connector and RT unit RF DRIVE connector by depressing the coaxial connector on CG-409H/U and turning it to the right. Use this same procedure to connect another CG-409H/U to Amplifier RCVR ANT. connector and RT unit RECEIVER IN connector.

TYPICAL CONNECTIONS OF RADIO SETS AN/GRC-106(*)

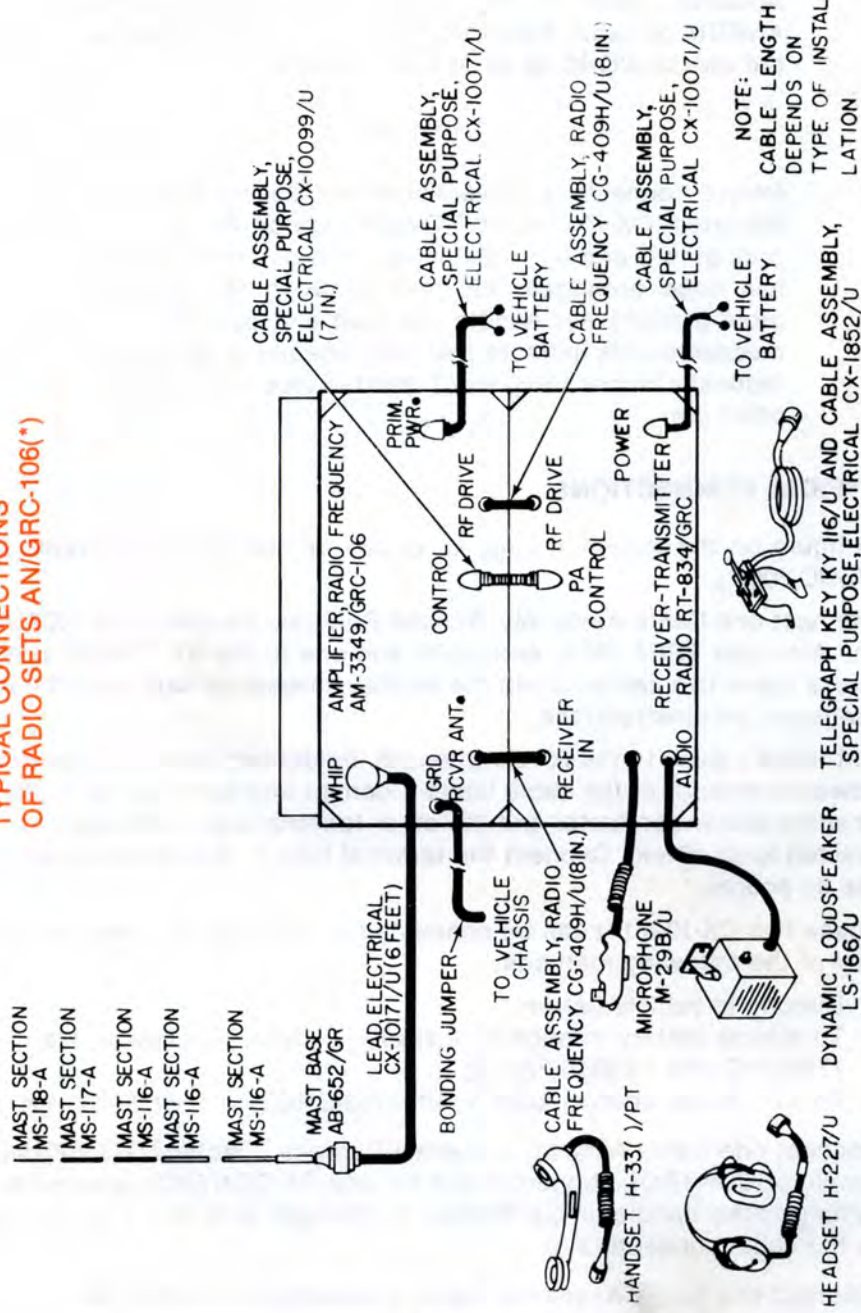

NOTE

To install Antenna Group AN/GRA-50 (Doublet Antenna), refer to TM 11-5820-467-15. Connect the AN/GRA-50 radio frequency (rf) transmission cable to the AM-3349/GRC 50 OHM LINE receptacle.

CAUTION

Before connecting Cable Assembly, Special Purpose, Electrical CX-10071/U to POWER jack on RT, be sure both pins C and D on J24 are grounded. If only one pin has been grounded, the lead between the pin and ground might not handle the load and burn open. If measurements indicate that only one pin is grounded, request a higher category of maintenance to ground the other pin.

d. TYPICAL CONNECTIONS

The figure on the following page is for typical connections of radio sets AN/GRC-106(*).

- Connect one Cable Assembly, Special Purpose, Electrical CX-10071/U to the Amplifier PRIM. PWR. connector and one to the RT POWER connector. Dress these two cables along the vehicle chassis according to the installation unit instructions.
- Cut these cables to the required length. Solder two terminal lugs or a power connector to the cable leads. Connect one terminal lug to the positive center conductor and the other terminal lug to the negative braided loom shield. Connect the terminal lugs or the power connector to the dc source.
- These two CX-10071/U can be connected to a 27-volt dc power source by one of the following methods:
 1. Directly to vehicle battery.
 2. To vehicle battery through Electrical Transient Suppressor, MX-7778/GRC (TM 11-5915-223-12).
 3. To a dc power source, such as PP-4763/GRC (TM 11-5820-765-12).
- Connect one Cable Assembly, Special Purpose, Electrical CX-10099/U to Amplifier CONTROL connector and RT unit PA CONTROL connector by turning screw handle on CX-10099/U to the right until it is firmly attached to the cable connectors.
- Connect one Cable Assembly Radio, Frequency CG-409H/U to Amplifier RF DRIVE connector and RT unit RF DRIVE connector by depressing the coaxial connector on CG-409H/U and turning it to the right. Use this same procedure to connect another CG-409H/U to Amplifier RCVR ANT. connector and RT unit RECEIVER IN connector.

**TYPICAL CONNECTIONS
OF RADIO SETS AN/GRC-106(*)**

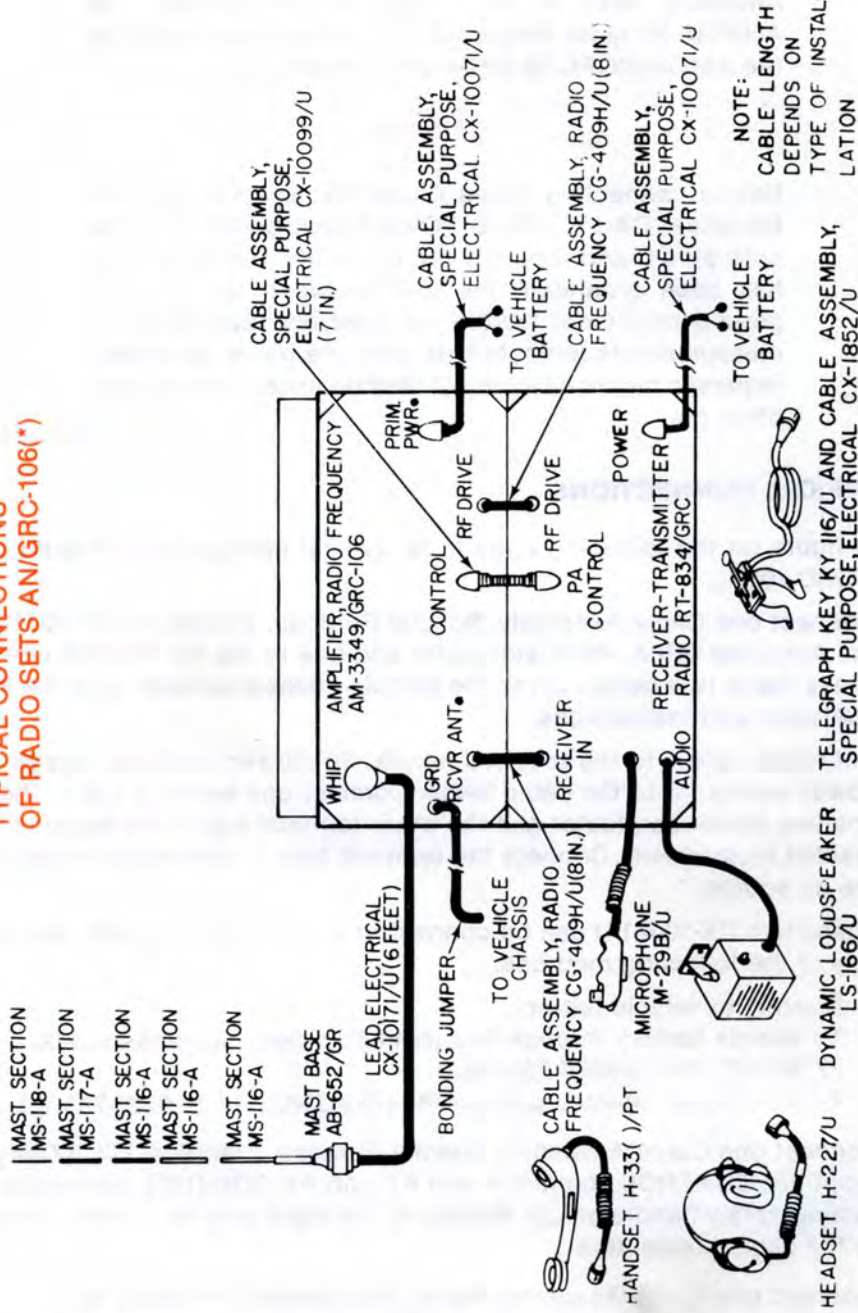

2-6. GENERAL

CAUTION

After taking the following steps, if trouble is experienced, refer to higher maintenance.

Do not use the radio set unless you first have your assigned operating and alternate frequencies. Operate only on frequencies assigned to you. Vehicle engine must be running when operating radio set. Engine speed should be high enough to show the battery is charging while you are transmitting on high power.

CAUTION

To avoid damage to components, do not start vehicle engine while the radio set is on.

2-7. WARM UP PROCEDURE

- Before operating, the radio set should be in a shutdown condition.

THIS PROCEDURE IS FOR THE RT ALONE.

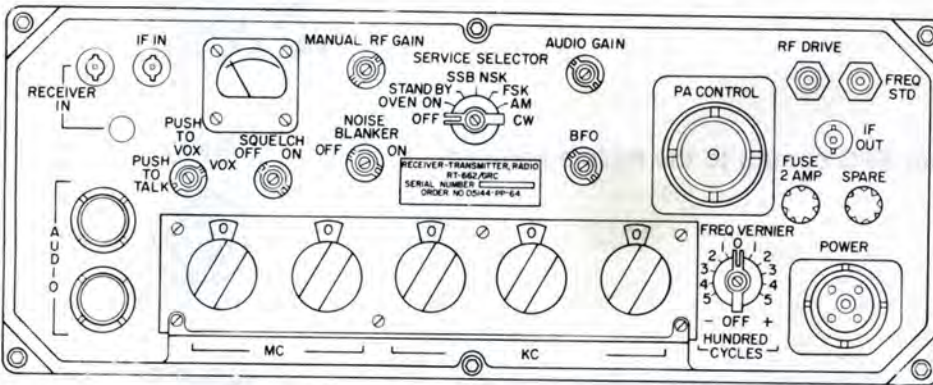

- Turn the SERVICE SELECTOR switch to OVEN ON and wait at least 10 minutes.
- Turn AUDIO GAIN control to the middle position.

AUDIO GAIN



SERVICE SELECTOR



- Turn MANUAL RF GAIN control all the way to the right.
- Turn SQUELCH switch to OFF.

SQUELCH OFF ON



MANUAL RF GAIN



- Turn FREQ VERNIER control to OFF.



- Turn VOX switch to PUSH TO TALK.



- Turn BFO control to the middle position.

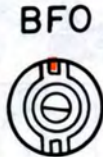

- Turn NOISE BLANKER switch to OFF.

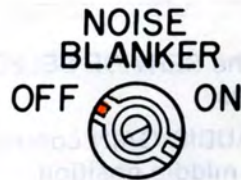

NOTE

This applies to RT-662/GRC only.

THE NEXT PROCEDURE IS FOR THE AMPLIFIER ALONE

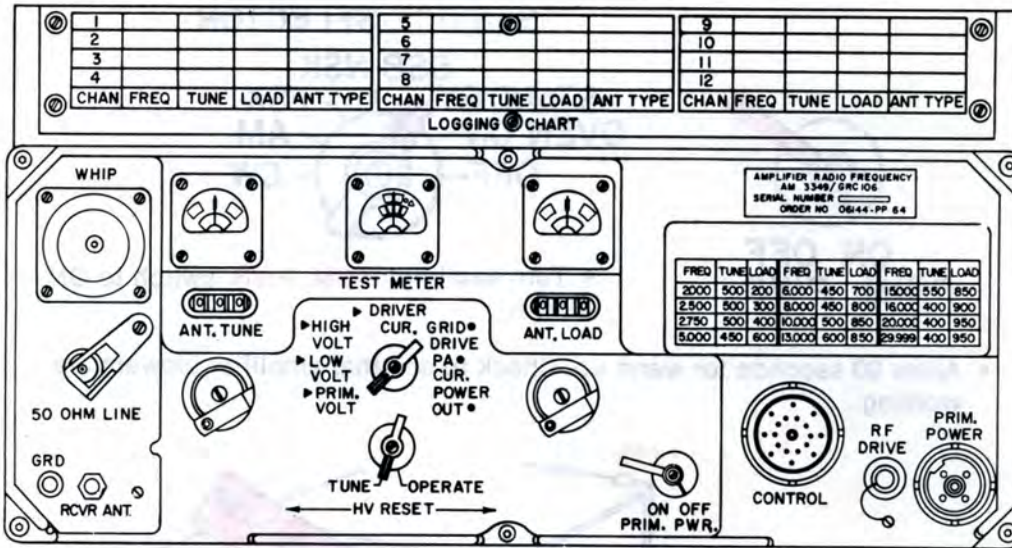

- Turn amplifier HV RESET switch to OPERATE.



NOTE

HV RESET switch must be in OPERATE position whenever radio set is on or off. It can stay in the TUNE position for a maximum of 2 minutes when radio is being tuned.

- Turn amplifier PRIM. PWR. switch to OFF.



2-8. STARTING PROCEDURE

- Turn **RT SERVICE SELECTOR** switch to STAND BY.

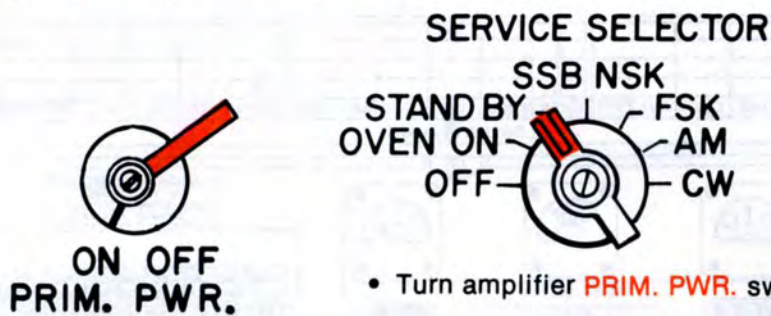

- Turn amplifier **PRIM. PWR.** switch to ON.

- Allow 90 seconds for warm up. Check to see that amplifier blowers are working.

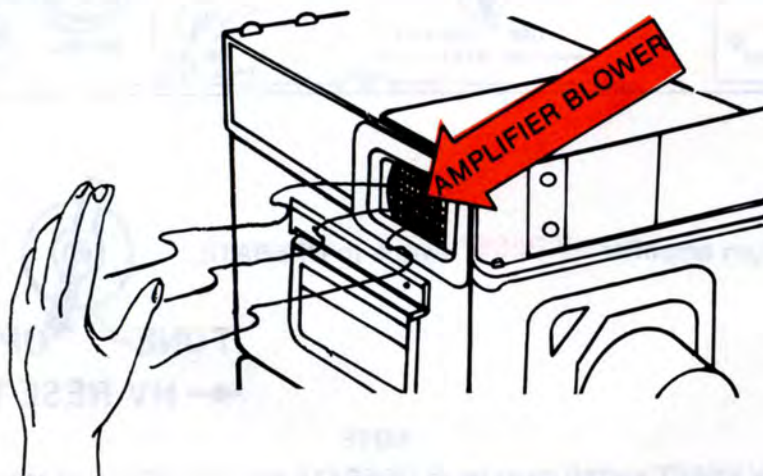

- Check to see that RT signal level meter indicates in extreme right section of meter scale.



NOTE

If indication is not normal,
refer to Chapter 3 under Troubleshooting.

- Turn **RT SERVICE SELECTOR** switch to SSB NSK.



- **RT signal level meter** will return to extreme left section of meter scale.



- Set amplifier **TEST METER** switch to PRIM. VOLT.

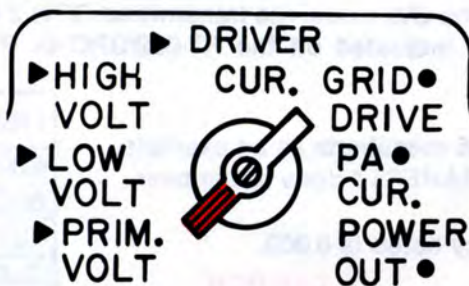

- Check to see that **amplifier TEST METER pointer** indicates within the area of two dark green wedges when RT SERVICE SELECTOR switch is in SSB NSK.



NOTE

If indication is not normal, notify organizational maintenance.

2-9. TUNING PROCEDURE

- Take a look at the ANTENNA TUNING AND LOADING CHART on the right front panel of the amplifier.

FREQ	TUNE	LOAD	FREQ	TUNE	LOAD	FREQ	TUNE	LOAD
2000	500	200	6.000	450	700	15000	550	850
2.500	500	300	8.000	450	800	16.000	400	900
2.750	500	400	10.000	500	850	20.000	400	950
5.000	450	600	13.000	600	850	29.999	400	950

- The chart will give frequencies and initial settings for ANTENNA TUNE and ANTENNA LOAD counters.

NOTE

All operating frequencies do not appear on the chart. Use the settings on the chart which are nearest to the operating frequency you need.

NOTE

When operating in the CW mode, the transmitted RF is 2 kHz higher than the frequency indicated on the RT-662/GRC or RT-834/GRC control panels.

- Using frequency 6.125 megahertz as an example.
- Frequency 6.125 MEGAHERTZ does not appear on the chart.
- The nearest frequency listed is 6.000.

FREQ	TUNE	LOAD
6.000	450	700
8.000	450	800
10.000	500	850
13.000	600	850

CAUTION

When changing the frequency numbers, allow time for the equipment to adjust.

- To the right of frequency listing 6.000 are the beginning ANTENNA TUNE and ANTENNA LOAD settings. For frequency listing 6.000 these would be 450 for ANTENNA TUNE and 700 for ANTENNA LOAD.
- To begin tuning the radio set, set the MEGAHERTZ and KILOHERTZ controls on the RT to 6.125.

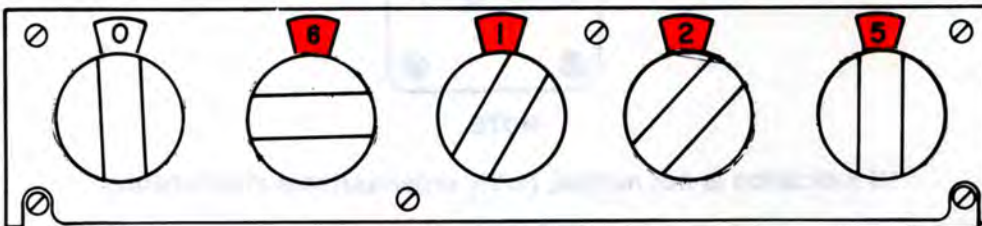

- When the controls are adjusted, the frequency numbers will appear in the windows directly above the controls.

- Check the ANTENNA TUNING AND LOADING CHART on amplifier front right panel for the setting for ANT. TUNE counter.



FREQ	TUNE	LOAD	FREQ	TUNE	LOAD	FREQ	TUNE	LOAD
2000	500	200	6.000	450	700	15000	550	850
2.500	500	300	8.000	450	800	16.000	400	900
2.750	500	400	10.000	500	850	20.000	400	950
5.000	450	600	13.000	600	850	29.999	400	950



ANT. TUNE

- Adjust ANT. TUNE control on amplifier to match numbers in the TUNE column. It appears to the right of the frequency. For frequency 6.125 the number is 450. Swing out lever on ANT. TUNE control wheel and rotate it. Lowest number position on counter spins fastest.



ANTENNA TUNE CONTROL

- Check the ANTENNA TUNING AND LOADING CHART on amplifier front right panel for the setting for ANT. LOAD.

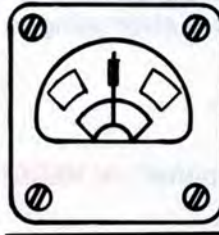

ANT. LOAD

- Adjust ANT. LOAD control on amplifier to match numbers in the load column. It appears to the right of the tune setting and frequency. For frequency 6.125 the number is 700. Swing out lever on ANT. LOAD control wheel and rotate it. Lowest number position on counter spins fastest.



ANTENNA LOAD CONTROL

CAUTION

To prevent damage to equipment during the following steps, be sure antenna is properly attached.



CAUTION

The amplifier HV RESET switch should not stay in TUNE position for longer than 2 minutes. If more than 2 minutes are needed, turn amplifier HV RESET switch to OPERATE and RT SERVICE SELECTOR switch to STAND BY for 5 minutes cooling. After 5 minutes cooling, turn RT SERVICE SELECTOR switch back to its previous position. Turn HV RESET switch to TUNE and continue with the tuning procedure.

CAUTION

To avoid damage to the equipment, read through tuning procedure before attempting to tune antenna.

- Set amplifier HV RESET switch to TUNE.



- Wait for some movement of the indicator on the ANT. TUNE and ANT. LOAD meters. This deflection shows the degree of mistuning between the antenna and the amplifier.
- Amplifier ANT. TUNE and ANT. LOAD meters must both indicate in the center scale for the radio set to be tuned. ANT. TUNE and ANT. LOAD controls work with each other.

CAUTION

Transmitting without the set properly tuned will cause damage to the equipment.

NOTE

Antenna tuning procedure must be followed precisely to ensure finest tuning.

- Select meter that indicates farthest from center and adjust to middle position.
- Now adjust second meter to middle position.

If meter indicates on the left . . .

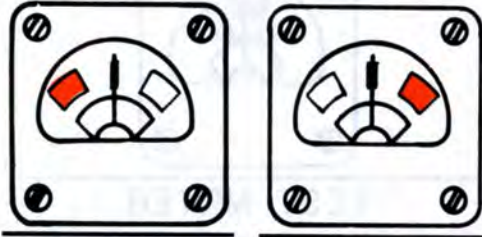

If meter indicates on the right . . .



ANT. TUNE



ANT. LOAD

Turn control to the right.

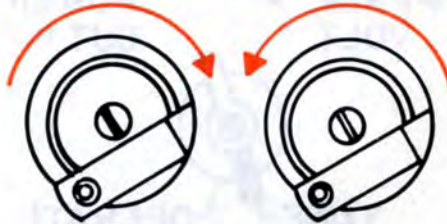

Turn control to the left.

NOTE

This procedure may take many adjustments to complete.

- Continue to alternately adjust meters to middle positions until both indicate center scale at the same time.

NOTE

If indication is not normal, check Troubleshooting Table in Chapter 3.

- Amplifier is tuned when both the ANT. TUNE and ANT. LOAD meters indicate in the center scale at the same time.

- TEST METER should indicate between two dark green wedges.



TEST METER

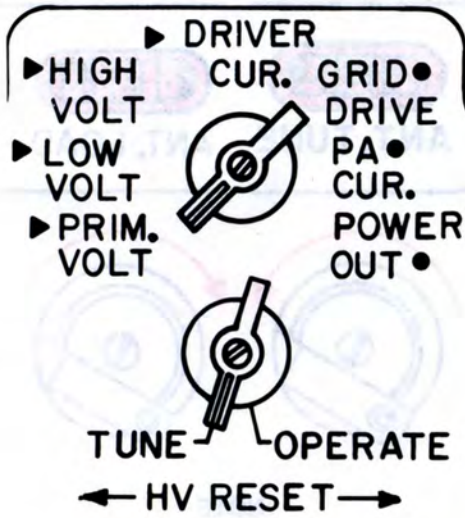

- Turn amplifier TEST METER switch to LOW VOLT. TEST METER pointer should indicate within green section of top scale.
- Turn amplifier TEST METER switch to HIGH VOLT. TEST METER pointer should indicate within green section of top scale.

NOTE

If indication is not normal, check Troubleshooting Table, Chapter 3.

- Turn amplifier TEST METER switch to DRIVER CUR. TEST METER pointer should indicate within the two green wedges of top scale.
- Turn amplifier TEST METER switch to GRID DRIVE. TEST METER pointer should indicate left of gray section of bottom scale.
- Turn amplifier TEST METER switch to PA CUR. TEST METER pointer should indicate left of gray section of bottom scale.
- Turn amplifier TEST METER switch to POWER OUT. TEST METER pointer should indicate left of gray section of bottom scale.
- Turn amplifier HV RESET switch to OPERATE. TEST METER pointer should indicate in extreme left of scale.

2-10. OPERATING PROCEDURE

- First perform the WARM UP procedure and STARTING procedure described in paragraphs 2-7 and 2-8.
- The radio set is now ready to operate.



NOTE

The HV RESET switch must remain in the OPERATE position during radio operation unless the frequency is changed by at least 100 kilohertz for any reason. When this happens, the radio set automatically programs to the new frequency and keeps the amplifier from being keyed. This will alert the operator to set the HV RESET switch back to the TUNE position and reset the ANT. TUNE and ANT. LOAD controls to retune the amplifier to the new frequency.

2-11. TO RECEIVE SIGNALS

- When receiving signals first make sure amplifier HV RESET switch is turned to OPERATE.



- SINGLE-SIDEBAND is the voice mode used to communicate with other SINGLE-SIDE BAND radio sets. To operate in the SINGLE-SIDE BAND voice mode, turn the RT SERVICE SELECTOR switch to SSB NSK.

- COMPATIBLE AM is the voice mode used to communicate with stations using radio sets that are not SINGLE-SIDEBAND radio sets. To operate in the COMPATIBLE AM voice mode, turn the RT SERVICE SELECTOR switch to AM.

THE NEXT PROCEDURE IS FOR THE RECEIVER-TRANSMITTER ALONE.

- Adjust AUDIO GAIN control for comfortable listening level. The operator will hear a decrease in the rushing noise. Do not adjust the volume too low or signals from other stations will not be heard.

AUDIO GAIN



SQUELCH
OFF ON



- Turn SQUELCH switch to ON if the noise level is still too high.

- Turn the MANUAL RF GAIN control to the maximum clockwise position.

MANUAL RF GAIN

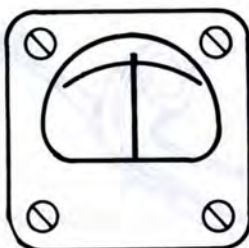

- The signal level meter will indicate the presence of a voice signal. Indicator will go to center of scale when signal is present.

- To get the best reception, adjust the FREQUENCY VERNIER when you hear the distant operator's voice.

FREQ VERNIER

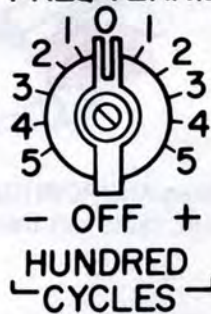

2-12. TO TRANSMIT SIGNALS

- Make sure amplifier HV RESET switch is turned to OPERATE

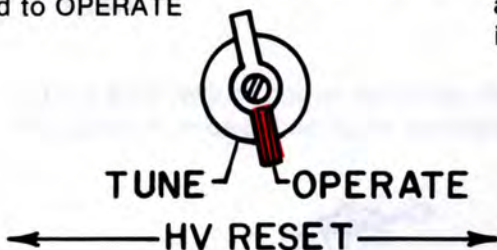

and PRIM. PWR. is ON.



- Turn RT SERVICE SELECTOR switch to desired operate mode SSB NSK, FSK, AM or CW.

- If RT SERVICE SELECTOR switch is turned to SSB NSK or AM, turn VOX switch to desired position.

SERVICE SELECTOR

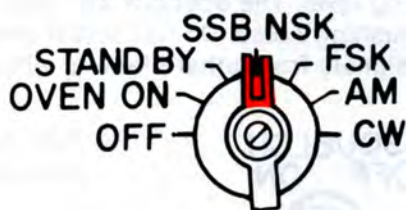

- In VOX position, microphone or handset is live at all times. Operator's voice keys radio set everytime he speaks into MICROPHONE or HANDSET.

- In PUSH TO VOX position, depress and hold MICROPHONE or HANDSET PUSH-TO-TALK switch.

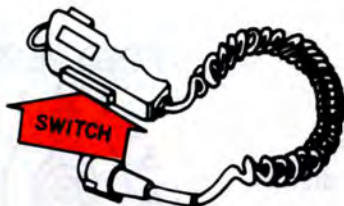
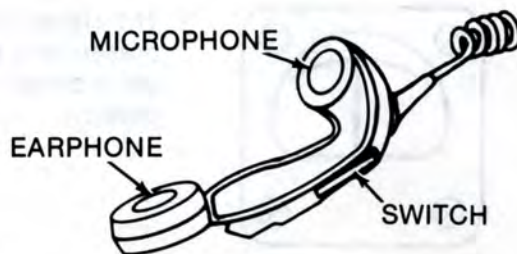

- When MICROPHONE or HANDSET PUSH-TO-TALK switch is depressed and held, radio set transmitter is keyed by operator's voice.

- In PUSH TO TALK position, depress and hold MICROPHONE or HANDSET PUSH-TO-TALK switch to receive reply.



- IF RT SERVICE SELECTOR switch is turned to CW, VOX switch is disabled. Radio set transmitter must be keyed with telegraph key.

TELEGRAPH KEY



- If RT SERVICE SELECTOR switch is turned to FSK, VOX switch is disabled. Radio set transmitter must be keyed by appropriate radio teletypewriter terminal equipment.
- Audio accessories HANDSET, HEADSET, MICROPHONE, TELEGRAPH KEY or LOUDSPEAKER can be connected to either of the two AUDIO RECEPTACLES on RT bottom left panel front.

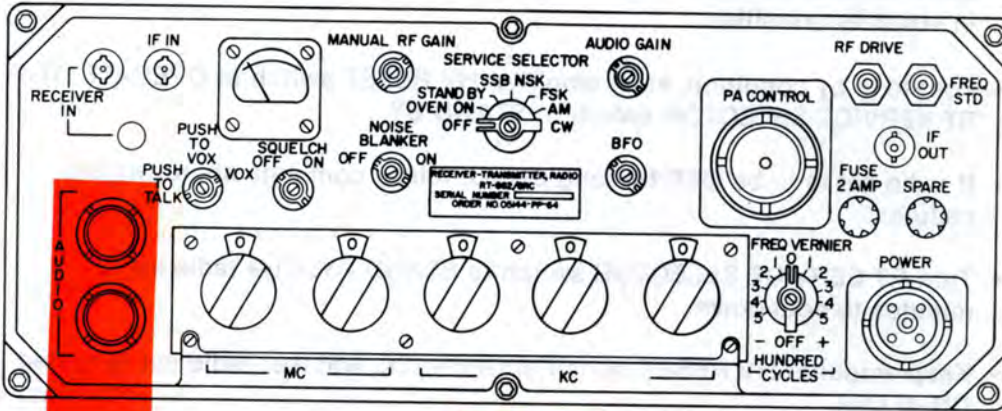

RT-662/GRC



HANDSET



HEADSET



MICROPHONE



TELEGRAPH KEY

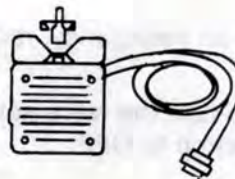

LOUDSPEAKER

2-13. STOPPING PROCEDURE

- Radio set can be put into stand by or shutdown condition. Complete shutdown takes 3 minutes. If radio set is to be off for 1 hour or less, place in stand by condition.
- For stand by condition, keep amplifier HV RESET switch at OPERATE. Turn RT SERVICE SELECTOR switch to STAND BY.
- If radio set is to be OFF for long period, follow complete shutdown procedure:
- Turn RT SERVICE SELECTOR switch to STAND BY. Give radio set 2 minutes to cool down.
- Keep amplifier HV RESET switch at OPERATE, whether radio set is turned ON or OFF.
- Turn amplifier PRIM. PWR. switch to OFF.
- Turn RT SERVICE SELECTOR switch to OFF.

2-14. EMERGENCY STOPPING PROCEDURE

- In an emergency, radio set can be stopped immediately.
- To turn the radio set OFF in an emergency, turn RT SERVICE SELECTOR switch to OFF.

2-15. PREPARATION FOR MOVEMENT

- Make sure antenna is fixed securely to clamp.

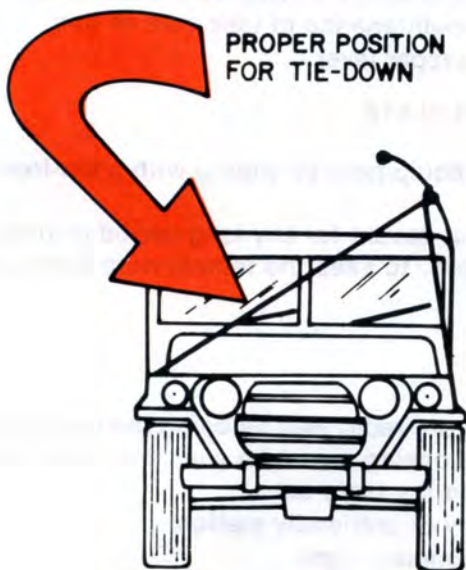

⚡ WARNING ⚡

To avoid a serious or fatal accident when pulling the antenna down, make sure that the tip is above any pedestrian and that it will not swing beyond the side of the vehicle.

Section IV. OPERATION UNDER UNUSUAL CONDITIONS

2-16. OPERATION AT LOW TEMPERATURES

- Keep ice off antennas.
- Do not bend cables or cords suddenly.
- Check to see that ice or snow is not blocking amplifier blower port area.
- Make sure vehicle charging system can maintain a satisfactory battery charging rate.
- Keep radio set front panel controls free of ice.

NOTE

When operating the radio set in cold climates and shutdown is to be for 10 hours or less, set RT SERVICE SELECTOR switch to OVEN ON.

2-17. OPERATION IN DESERT AND DUSTY AREAS

- Keep equipment area as dust free as possible.
- If radio set is constantly exposed to sun, it should be protected with heat reflecting paint. Ask supporting maintenance to take care of this.
- Keep water in vehicle battery at proper level.

2-18. OPERATION IN TROPICAL CLIMATE

- Keep moisture and fungi off the equipment by wiping with a lint-free cloth.
- Do not operate equipment without covers for any long period of time.
- Use the air conditioner, if available, to keep the temperature and humidity down.

2-19. RADIO JAMMING

- It is important to recognize that your radio may be being jammed. Jamming is the transmission of a strong, blocking signal on your frequency, making it hard for you to communicate on the radio set.
- This signal may be from a friendly or unfriendly station.
- First make sure your receiver is working right.
- Disable the antenna by grounding it.

NOTE

As soon as you know your radio is being jammed, tell your supervisor.

2-20. ANTIJAMMING PROCEDURES

To reduce the effects of jamming, try the following:

- Reposition the vehicle on which the radio set is mounted.
- Use a line of trees or a nearby building or some other local obstruction as a screen between you and the possible jamming site.
- Point your vehicle toward the station you are communicating with. Try a few different positions.
- Turn up the level of the RT AUDIO GAIN control. This may raise the level of the signal you want above the level of the jamming signal.
- If it is still too hard to communicate on the radio set, get permission to use another frequency.

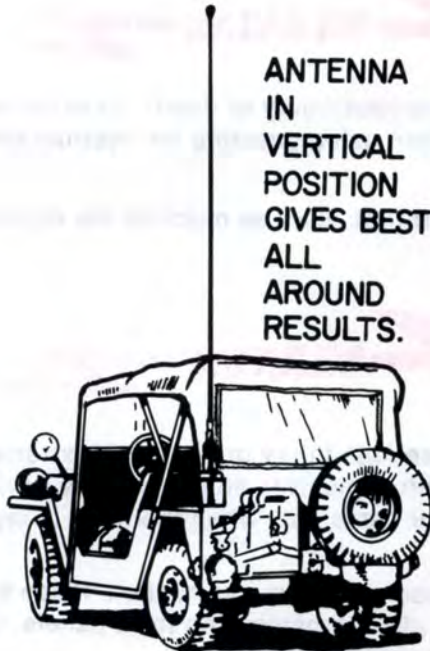

2-21. DESTRUCTION TO PREVENT ENEMY USE

NOTE

Demolition of the equipment will be carried out upon the order of your commander only. The method of destruction is dependent upon the amount of time available. The circumstances will determine the manner in which the equipment will be destroyed.

- If you are pressed for time, smash the right side of the RT-662/GRC or RT-834/GRC with an ax.
- Cut the cables and wires.



To avoid serious injury or death, be extremely careful when using gasoline for destruction.

- The TM is to be burned first. Burn as much of the equipment as possible.



To avoid serious injury or death, be extremely careful with explosives and incendiary devices. Use these items only when the need is urgent.

- Use explosives to cause maximum destruction. Place explosive charges inside the equipment after smashing the front panels. Grenades may be used to destroy small parts and wiring.
- Bury or scatter destroyed parts in slit trenches and foxholes. If near a waterway, throw parts into it.

CHAPTER

MAINTENANCE WITH FORMS

PAGE

SUBJECT

3-1	Cleaning the Radio Set
3-2	Fuse Replacement
3-3	General
3-4	Troubleshooting Procedures
3-5	Troubleshooting Table

CHAPTER 3

MAINTENANCE INSTRUCTIONS

SUBJECT	PAGE
Cleaning the Radio Set	3-1
Fuse Replacement	3-2
General	3-1
Troubleshooting Procedures	3-2
Troubleshooting Table	3-3

3-1. GENERAL

The maintenance duties assigned to you, the operator, are:

- Performing Preventive Maintenance Checks and Services
- Cleaning the radio set
- Fuse replacement
- Troubleshooting



Turn RT SERVICE SELECTOR switch to OFF to avoid injury from dangerous voltages.

- Check to see that the vehicular generating system or external power source is in working order.

3-2. CLEANING THE RADIO SET

- Use soft cloth to remove dust, moisture, and dirt from the outside of the radio set.

CAUTION

Do not press on meter glass. You could damage the meters.

- Make sure all panels, meters, and knobs are clean.
- If dirt is hard to remove, dampen cloth with water or mild soap solution.



Fumes of TRICHLOROTRIFLUOROETHANE are poisonous. Provide adequate ventilation whenever you use TRICHLOROTRIFLUOROETHANE. Do not use solvent near heat or open flame. TRICHLOROTRIFLUOROETHANE will not burn, but heat changes the gas into poisonous, irritating fumes. DO NOT breathe fumes or vapors. TRICHLOROTRIFLUOROETHANE dissolves natural skin oils. DO NOT get solvent on your skin. Use gloves, sleeves and an apron which solvent cannot penetrate. If solvent is taken internally, see a doctor immediately.

- Dampen (do not wet) cloth with trichlorotrifluoroethane to remove grease, fungus, and ground-in dirt from equipment covers.
- Use brush to remove dust or dirt from plugs and jacks.

3-3. FUSE REPLACEMENT

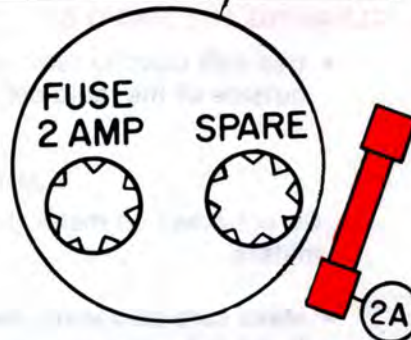
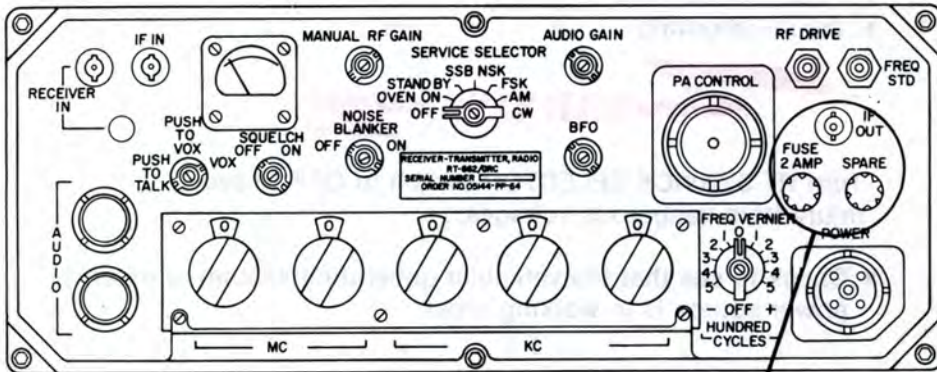

- The next procedure is for the RT alone.
- If fuse is defective, turn RT SERVICE SELECTOR switch to OFF.
- Turn fuse holder counterclockwise and remove defective fuse from the fuse holder.
- Insert replacement fuse from SPARE fuse holder into fuse holder. Replace fuse holder in receptacle and tighten by turning clockwise.

3-4. TROUBLESHOOTING PROCEDURES

The Troubleshooting Table tells you some of the troubles you may find during the operation or maintenance of the radio set. You should perform the test, inspections, and corrective actions in the order listed.

This manual cannot cover all the troubles that may happen, nor all tests, inspections or corrective actions. If a trouble is not listed or it cannot be corrected by performing the corrective actions, notify your supervisor.

TROUBLESHOOTING TABLE

MALFUNCTION

TEST OR INSPECTION

CORRECTIVE ACTION

1. Blower motors in Amplifier do not energize.

Check for faulty seating of connector on CX-10071/U to Amplifier PRIM. POWER receptacle.

Tighten CX-10071/U connector screw handle.

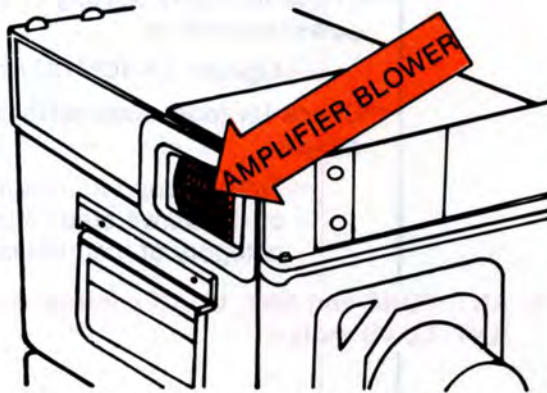

Check for loose connections at vehicle storage battery terminals.

Tighten connections at vehicle storage battery.

Check for faulty seating of connector on CX-10099/U.

Tighten CX-10099/U connector screw handle.

Check for defect in Amplifier.

Turn Amplifier PRIM. PWR. switch to OFF, then immediately back to ON. You should hear the blower motors.

NOTE

If none of the above steps causes the blower motors to energize, higher category of maintenance required.

2. Signal level meter pointer on RT front panel does not move to extreme right side of scale.

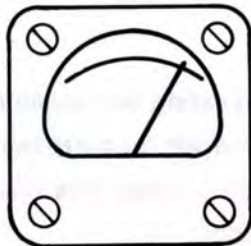

See if the 2 amp fuse on the RT front panel is burned out.

Replace fuse.

TROUBLESHOOTING TABLE - Continued

MALFUNCTION

TEST OR INSPECTION

CORRECTIVE ACTION

Check for faulty seating of connector on CX-10071/U to RT power connector.

Tighten CX-10071/U connector screw handle.

Check for loose connections at vehicle storage battery terminals.

Tighten connections at vehicle storage battery. If none of the above steps causes the pointer to move, higher category of maintenance required.

3. ANT. TUNE and ANT. LOAD controls do not interact with ANT. TUNE and ANT. LOAD meters.

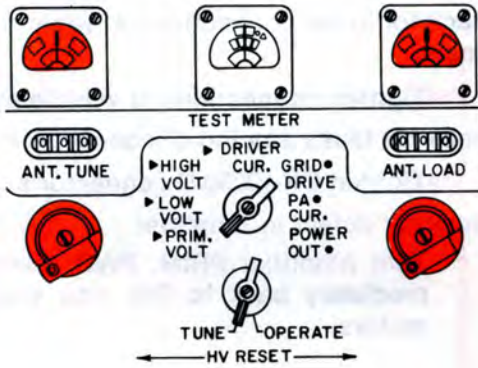

CAUTION

Be sure PRIM. PWR. switch is set to OFF before checking antenna cable CX-10171/U.

Check for faulty seating of connector on CX-10171/U.

Check both ends for corrosion.

4. Test meter pointer does not move within dark green top scale when test meter switch is set at HIGH VOLT.

Check for defect in Amplifier.

Turn HV RESET switch to TUNE, wait 60 seconds, and turn it back to OPERATE. If meter indication is still incorrect, higher category of maintenance required.

APPENDIX A REFERENCES

A-1. INTRODUCTION.

Following is a list of all forms, technical bulletins, and technical manuals referenced in this manual.

A-2. FORMS.

Equipment Inspection and Maintenance Worksheet . . .	DA Form 2404
Quality Deficiency Report	Form SF 368
Recommended Changes to Equipment Technical Manuals	DA Form 2028-2
Recommended Changes to Publications and Blank Forms	DA Form 2028

A-3. TECHNICAL BULLETINS.

Field Instructions for Painting and Preserving Electronics Command Equipment Including Camouflage Pattern Painting of Electrical Equipment Shelters	TB 43-0118
Identification of Radioactive Items in the Army Supply System	TB 43-0116
Instructions for Safe Handling and Identification of U.S. Army Electronics Command Managed Radioactive Items in the Army Supply System	TB 43-0122
Safety Measures to be Observed when installing and using Whip Antennas, Field Type Masts, Towers and Antennas and Metal Poles that are used with Communications, Radar, and Direction Finder Equipment (to 31P5-1-1)	TB SIG 291

A-4. TECHNICAL MANUALS.

Operator and Organizational Maintenance: Multimeter AN/URM-105 and AN/URM-105C Including Multi- meter ME-77/U and ME-77C/U	TM 11-6625-203-12
Operator and Organizational Maintenance Manual: Power Supplies PP-4763/GRC and PP-4763A/GRC . . .	TM 11-5820-765-12
Operator's and Organizational Maintenance Manual Including Repair Parts and Special Tools Lists: Suppressor, Electrical Transient MX-7778/GRC	TM 11-5915-223-12
Operator's, Organizational, Direct Support, General Support, and Depot Maintenance Manual: Antenna Group AN/GRA-50	TM 11-5820-467-15
Radio Set AN/GRC-106(NSN 5820-00-402-2263) and AN/GRC-106A (NSN 5820-00-223-7548)	TM 11-5820-520-10-HR

A-5. MISCELLANEOUS PUBLICATIONS.

Ionization and Radiation Protection	AR 385-11
Consolidated Index of Army Publications and Blank Forms	DA PAM 310-1
The Army Maintenance Management System (TAMMS)	DA PAM 738-750

Equipment Inspector and Maintenance Technician
Quality Control Report
Recommended Changes to Equipment Technical
Manuals
Recommended Changes to Publications and Blank
Forms

A-4. TECHNICAL MATTERS

Field Instructions for Painting and Preserving
Electronic Control Systems Including
Component Pattern Printing of Electrical
Equipment Schematics
Identification of Radioactive Items in the Army
Supply System
Instructions for Safe Handling and Identification of
U.S. Army Electronic Component Manager
Radioactive Items in the Army Supply System
Safety Measures to be Observed when Working with
Using VHF Antennas, Field Type Models, Towers and
Antennas and Metal Poles that are used with
Communications, Radar, and Direction Finding
Equipment (to 5195-1)

A-3. TECHNICAL MANUALS

Operator and Organizational Maintenance Manual
ANURM-105 and ANURM-105C Including Manual
meter ME-710 and ME-710U
Operator and Organizational Maintenance Manual
Power Supplies PA-18VDRG and PA-18VDRG
Operator and Organizational Maintenance Manual
Including Radar Parts and Special Tools List
Suppressor Electrical Element MXTTDRG
Operator, Organizational, Direct Support, General
Support, and Depot Maintenance Manual Antenna
Group ANGRA-63
Radio Set ANARG-100KWH (S20-440) (200) and
ANARG-100A (S20-440) (200)

APPENDIX B**COMPONENTS OF END ITEM AND BASIC ISSUE ITEMS LISTS****INTRODUCTION****B-1. SCOPE.**

This appendix lists components of end item and basic issue items for the AN/GRC-106(*) to help you inventory items required for safe and efficient operation.

B-2. GENERAL.

The Components of End Item and Basic Issue Items Lists are divided into the following sections:

a. Section II. Components of End Item. This listing is for informational purposes only, and is not authority to requisition replacements. These items are part of the end item, but are removed and separately packaged for transportation or shipment. As part of the end item, these items must be with the end item whenever it is issued or transferred between property accounts. Illustrations are furnished to assist you in identifying the items.

b. Section III. Basic Issue Items. Not Applicable.

B-3. EXPLANATION OF COLUMNS.

The following provides an explanation of columns found in the tabular listings:

a. Column (1) - Illustration Number (Illus Number). This column indicates the number of the illustration in which the item is shown.

b. Column (2) - National Stock Number. Indicates the National stock number assigned to the item and will be used for requisitioning purposes.

c. Column (3) - Description. Indicates the National item name and, if required, a minimum description to identify and locate the item. The last line for each item indicates the FSCM (in parentheses) followed by the part number. If item needed differs from different models of this equipment, the model is shown under the "Usable On" heading in this column.

d. Column (4) - Unit of Measure (U/M). Indicates the measure used in performing the actual operational/maintenance function. This measure is expressed by a two-character alphabetical abbreviation (e.g., EA, IN, PR).

e. Column (5) - Quantity required (Qty rqr). Indicates the quantity of the item authorized to be used with/on the equipment.

COMPONENTS OF RADIO SET AN/GRC-106(*)

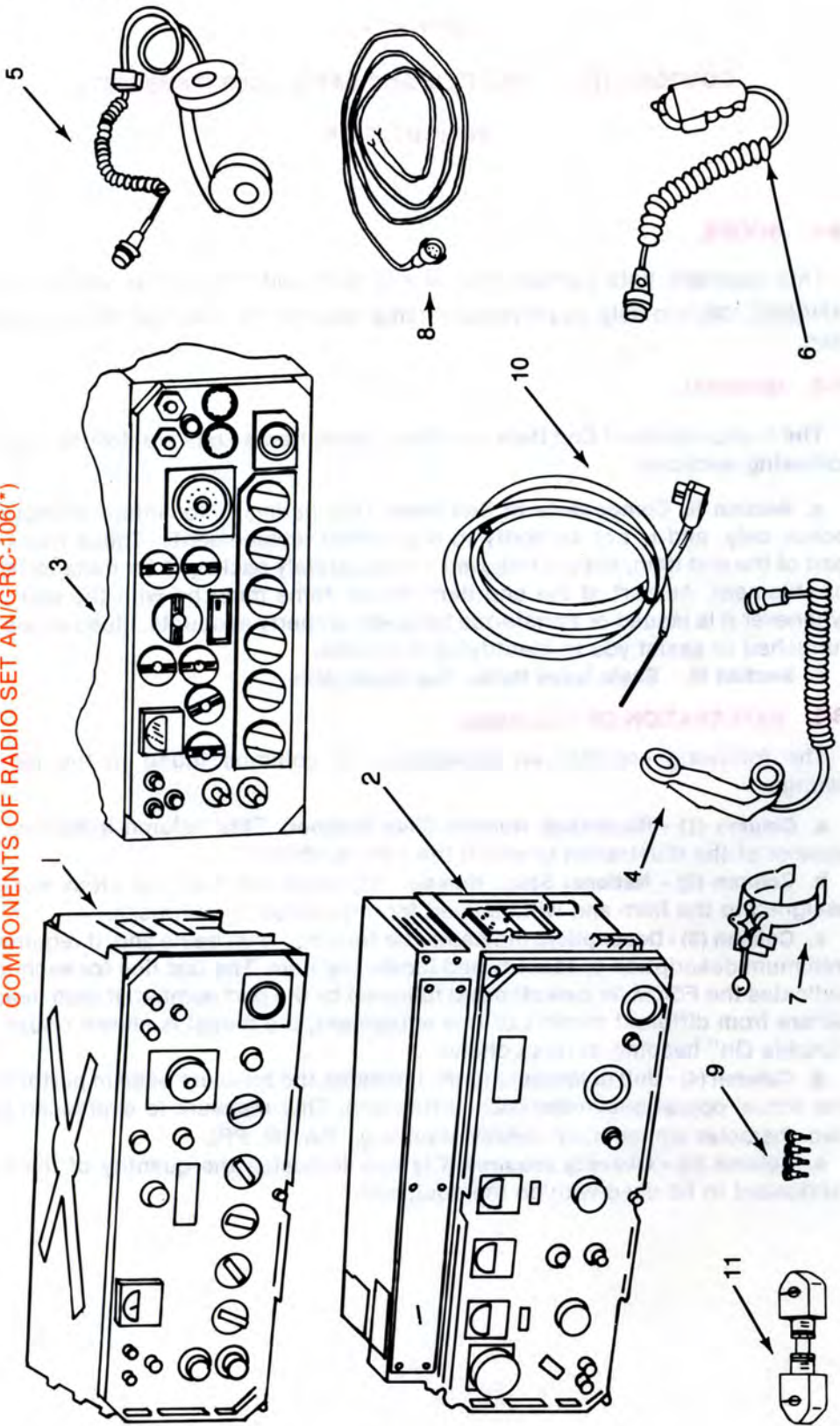

Section II. COMPONENTS OF END ITEM
(3)

(1) Illus. Number	(2) National Stock Number	(3) Description FSCM Usable and Part Number On Code	(4) U/M	(5) Qty. rqr.
1	5820-00-402-2263	RADIO SET AN/GRC-106 CONSISTING OF:	EA	1
2	5820-00-078-4766	RECEIVER-TRANSMITTER RT-662/GRC	EA	1
3	5820-00-078-4771	AMPLIFIER, RF AM-3349/GRC-106	EA	1
4	5820-00-223-7548	RADIO SET AN/GRC-106A CONSISTING OF:	EA	1
5	5820-00-935-0033	RECEIVER-TRANSMITTER RT-834/GRC	EA	1
6	5820-00-078-4771	AMPLIFIER, RF AM-3349/GRC-106	EA	1
7	5965-00-163-9947	PLUS THE FOLLOWING ITEMS:	EA	1
8	5965-00-226-2915	HANDSET H-33(*)/PT	EA	1
9	5965-00-892-0722	HEADSET, ELECTRICAL H-227/U	EA	1
10	5805-00-503-3395	MICROPHONE M-29B/U	EA	1
11	5995-00-177-4501	KEY, TELEGRAPH KY-116/U	EA	1
	5820-00-138-8616	CABLE SPECIAL PURPOSE CX-1852/U	EA	1
	5820-00-089-9656	HARDWARE KIT FOR AN/GRC-106	EA	1
	5995-00-985-7998	GROUNDING KIT	EA	1
	5995-00-985-8005	CABLE, ASSEMBLY, SPECIAL PURPOSE, ELECTRICAL CX-10071/U	EA	2
		CABLE, ASSEMBLY, SPECIAL PURPOSE, ELECTRICAL CX-10099/U	EA	1

COMPONENTS OF RADIO SET AN/GRC-106(*)

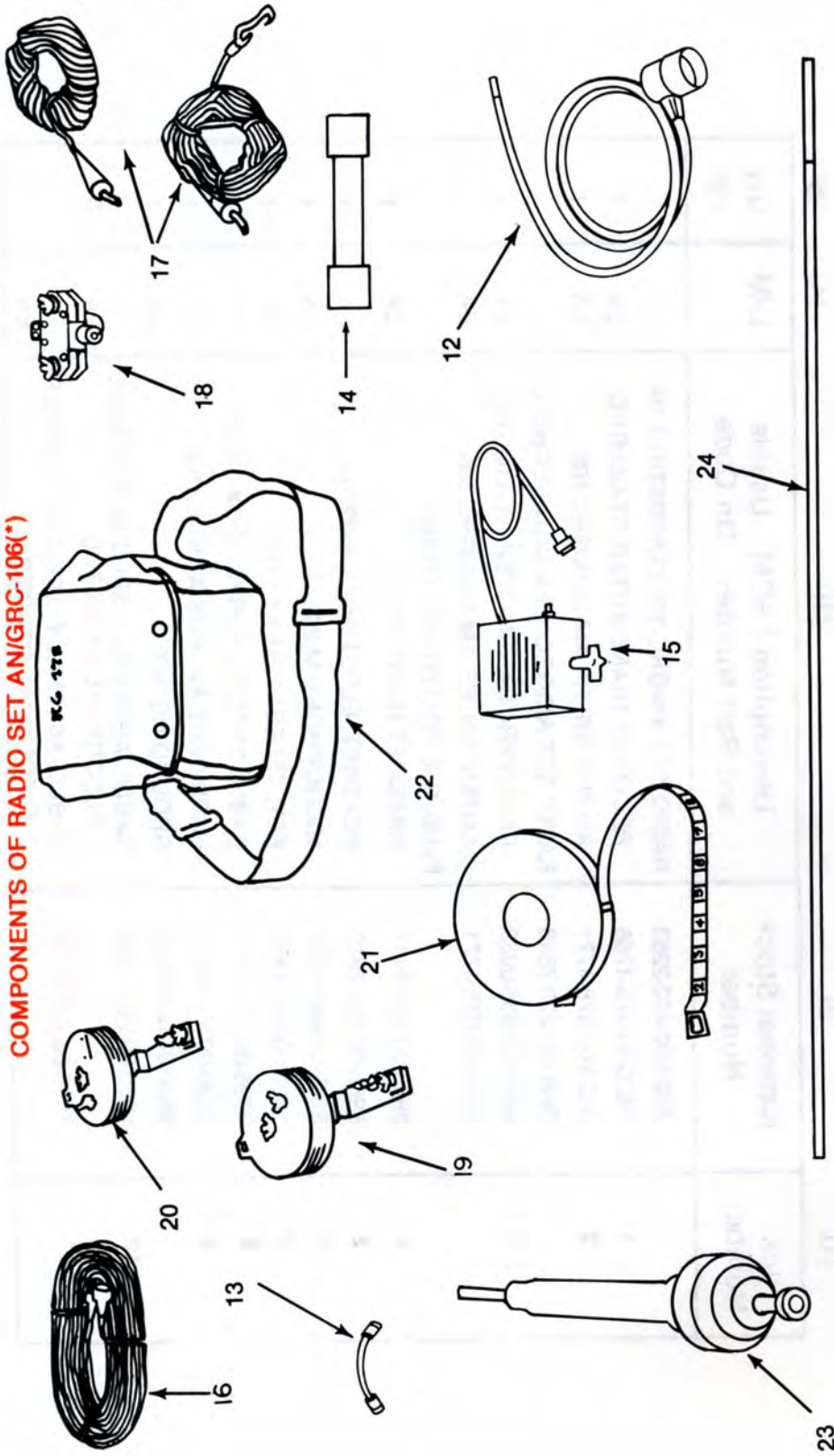

Section II. COMPONENTS OF END ITEM - Continued

(1) Illus. Number	(2) National Stock Number	(3) Description FSCM Usable and Part Number On Code	(4) U/M	(5) Qty. rqr.
12	5995-00-985-8014	LEAD, ELECTRICAL CX-10171/U	EA	1
13	5995-00-578-6353	CABLE ASSEMBLY RADIO, FREQUENCY CG-409/U	EA	2
14	5920-00-280-4960	FUSE 2A 250V F02A250V2A	EA	2
15	5965-00-243-6420	DYNAMIC LOUDSPEAKER LS-166/U	EA	1
	7690-00-620-2110	DECAL	EA	2
16	5985-00-892-0758	ANTENNA GROUP AN/GRA-50 CONSISTING OF:		1
17	5995-00-823-2176	CABLE ASSEMBLY CG-687/U	EA	1
18	5985-00-893-1438	HALYARD MX-2706/G	EA	2
19	5970-00-405-8223	INSULATOR IL-4/GRA-4	EA	1
20	5895-00-896-3179	REELING MACHINE RC-432/G	EA	2
21	5985-00-757-2130	WIRE ASSEMBLY CX-7303/G	EA	2
22	5210-00-897-6077	TAPE, MEASURING	EA	1
	6115-00-498-3973	BAG BG-175	EA	1
23	5820-00-078-4770	WHIP ANTENNA CONSISTING OF:		1
24	5985-00-115-7149	MAST BASE AB-652/GR	EA	1
		MAST SECTION MS-117A	EA	1

COMPONENTS OF RADIO SET AN/GRC-106(*)

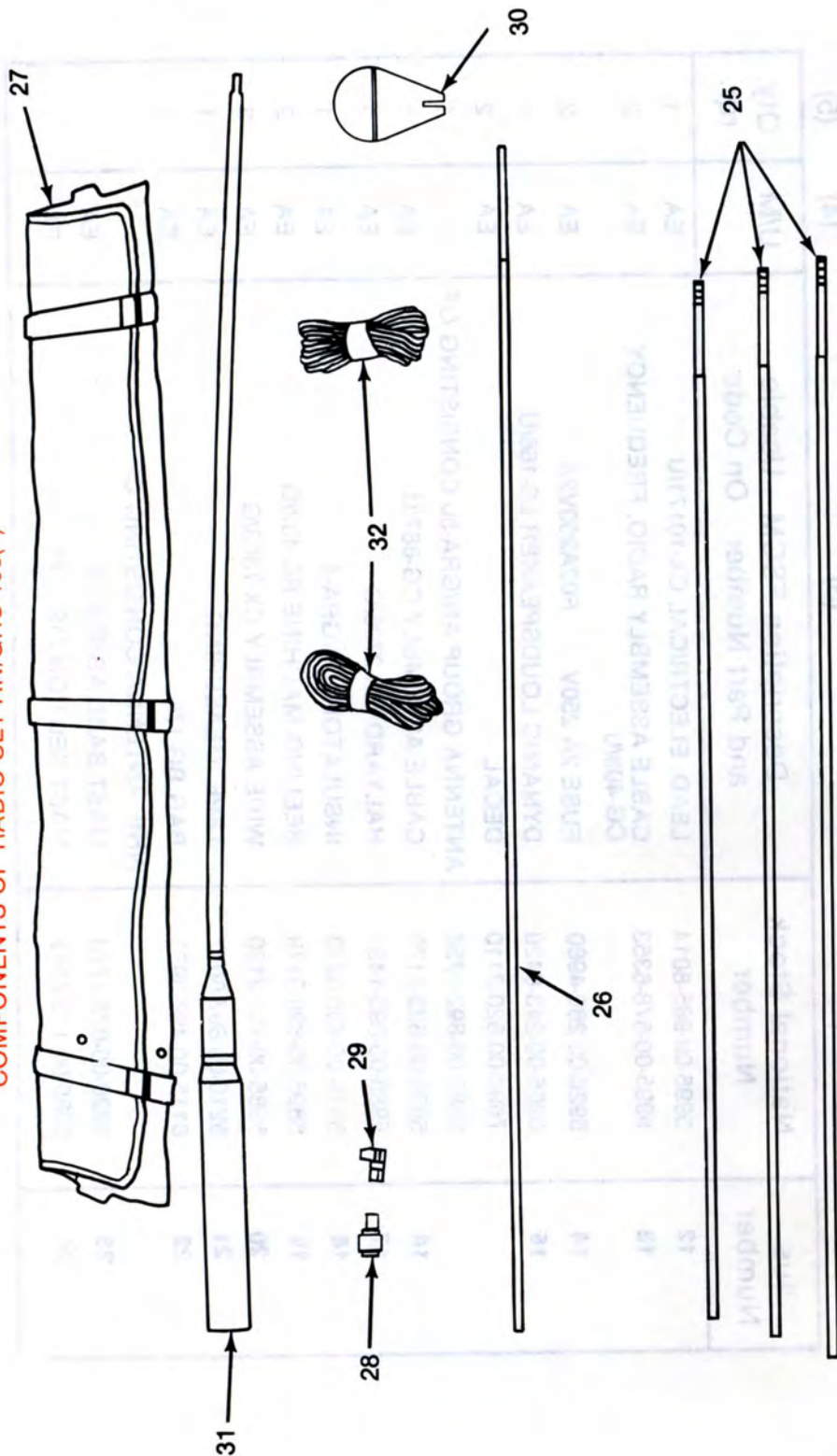

Section II. COMPONENTS OF END ITEM - Continued

(1) Illus. Number	(2) National Stock Number	(3) Description FSCM Usable and Part Number On Code	(4) U/M	(5) Qty. rqr.
25	5985-00-199-8831	MAST SECTION MS-116A	EA	3
26	5985-00-238-7474	MAST SECTION MS-118A	EA	1
27	5820-00-200-2329	BAG CW-206/GR	EA	1
28	5935-00-259-0205	ADAPTER, CONNECTOR UG-201A/U	EA	1*
29	5935-00-847-2600	ADAPTER, CONNECTOR UG-306B/U	EA	1*
30	5985-00-930-7223	ANTENNA TIP ASSEMBLY	EA	1
31	5820-00-078-4769	ANTENNA COVER	EA	1
32	4020-00-073-3276	ROPE	EA	1
33	5820-00-571-1828	CLAMP	EA	1
34	5340-00-694-1071	BRACKET	FT	40'

*as required

B-7/(B-8 blank)

10-10-1984

Principal Index	Principal National Stock	Bicycles	Date	Rate
34	288200 100-5000	QTY 100	10/10/84	1000
35	400000 100-5000	QTY 100	10/10/84	1000
36	288200 100-5000	QTY 100	10/10/84	1000
37	288200 100-5000	QTY 100	10/10/84	1000
38	288200 100-5000	QTY 100	10/10/84	1000
39	288200 100-5000	QTY 100	10/10/84	1000
40	288200 100-5000	QTY 100	10/10/84	1000
41	288200 100-5000	QTY 100	10/10/84	1000
42	288200 100-5000	QTY 100	10/10/84	1000

(1)

(2)

(3)

(4)

(5)

10-10-1984 10-10-1984 10-10-1984 10-10-1984 10-10-1984

GLOSSARY

- Deflection** The movement of an indicator or pointer from the zero reading on a meter.
- Disable** Prevent from working.
- Indicate** Point out or show.
- Interference** Reception of stray or unwanted radio signals.
- Keying** Activating an electronic circuit.
- Radiate** To send out from a center.
- Receptacle** A mounted electrical fitting containing the live parts of a circuit.

the movement of a...
...to the...

...to the...

...to the...

...to the...

...to the...

...to the...

...to the...
...the...

Collection

Books

Index

Reference

Keylog

Program

Research

INDEX

SUBJECT	PAGE
A	
Abbreviations	1-2
Amplifier AM-3349/GRC-106	2-10
Antenna description	1-4
Antenna tuning	2-34
Antijamming procedures	2-47
Assembly and preparation for use	2-21
C	
Cleaning	3-1
Components	1-3
Controls and indicators	2-1
D	
Description and use of operator's controls and indicators	2-1
Description of antenna	1-4
Destruction to prevent enemy use	2-48
Differences between models	1-5
E	
Emergency stopping procedure	2-44
Equipment description	1-3
Equipment purpose, capabilities, and features	1-3
F	
Forms, maintenance	1-1
Fuse replacement	3-2
G	
Grounding	2-24
H	
Hand receipt	1-2

INDEX - Continued

SUBJECT	PAGE
J	
Jamming, radio	2-46
M	
Maintenance	
Forms	1-1
General	3-1
Instructions	3-0
Major components, description	1-3
Model differences	1-5
Mounting procedure	2-21
Movement, preparation for	2-45
N	
Nomenclature, cross-reference list	1-2
O	
Operating instructions	2-1
Operating procedure	2-40
Operation under unusual conditions	2-46
Operation under usual conditions	2-21
P	
Performance data	1-7
Preparation for movement	2-45
Preparation for use	2-21
Preventive maintenance (PMCS)	2-16
Principles of operation, technical	1-9
R	
Radio jamming	2-46
Records, maintenance	1-1
Replacement, fuses	3-2
Reporting, equipment improvement recommendations	1-1
Routine checks	2-16
RT-662/GRC	2-1
RT-834/GRC	2-2

INDEX - Continued

SUBJECT	PAGE
S	
Starting procedure	2-32
Stopping procedure	2-44
Stopping procedure, emergency	2-44
T	
Technical principles of operation	1-9
To receive signals	2-40
To transmit signals	2-41
Troubleshooting	
Procedures	3-2
Table	3-3
Tuning procedure	2-34
U	
Unusual conditions, operation under	2-46
Usual conditions, operation under	2-21
W	
Warm up	2-29

PAGE

SUBJECT

S

3-33	Starting procedure
3-44	Stopping procedure
3-44	Stopping procedure, emergency

T

1-9	Technical principles of operation
3-40	To receive signals
3-41	To transmit signals
3-3	Troubleshooting
3-3	Procedures
3-3	Table
3-34	Tuning procedure

U

3-45	Usual conditions, operation under
3-31	Usual conditions, operation under

W

3-30	Warm up
------	---------

RECOMMENDED CHANGES TO EQUIPMENT TECHNICAL PUBLICATIONS



THEN JOT DOWN THE DOPE ABOUT IT ON THIS FORM. CAREFULLY TEAR IT OUT, FOLD IT AND DROP IT IN THE MAIL.

SOMETHING WRONG WITH THIS PUBLICATION?

FROM (PRINT YOUR UNIT'S COMPLETE ADDRESS):
 Commander
 Stateside Army Depot
 ATTN: AMSTA-US
 Stateside, N.J. 07703

DATE SENT
 10 July 1975

PUBLICATION NUMBER
 TM 11-5840-340-12

PUBLICATION DATE
 23 Jan 74

PUBLICATION TITLE
 Radar Set AN/PRC-76

BE EXACT PIN-POINT WHERE IT IS

PAGE NO.	PARA GRAPH	FIGURE NO.	TABLE NO.
2-25	2-28		
3-10	3-3	3-1	
5-6	5-8		

IN THIS SPACE TELL WHAT IS WRONG AND WHAT SHOULD BE DONE ABOUT IT:

Recommend that the installation antenna alignment procedure be changed throughout to specify a 2° IFF antenna lag rather than 1°.

REASON: Experience has shown that with only a 1° lag, the antenna servo system is too sensitive to wind gusting in excess of 25 knots, and has a tendency to rapidly accelerate and decelerate as it hunts, causing strain to the drive train. Hunting is minimized by adjusting the lag to 2° without degradation of operation.

Item 5, Function column. Change "2 db" to "3db."

REASON: The adjustment procedure the the TRANS POWER FAULT indicator calls for a 3 db (500 watts) adjustment to light the TRANS POWER FAULT indicator.

Add new step f.1 to read, "Replace cover plate removed in step e.1, above."

REASON: To replace the cover plate.

Zone C 3. On J1-2, change "+24 VDC to "+5 VDC."

REASON: This is the output line of the 5 VDC power supply. +24 VDC is the input voltage.

PRINTED NAME GRADE OR TITLE AND TELEPHONE NUMBER
 SSG I. M. DeSpirito 999-1776

SIGN HERE
I. M. DeSpirito

DA FORM 2028-2 JUL 79

PREVIOUS EDITIONS ARE OBSOLETE

IF YOUR OUTFIT WANTS TO KNOW ABOUT YOUR RECOMMENDATION MAKE A CARBON COPY OF THIS AND GIVE IT TO YOUR HEADQUARTERS

REVERSE OF DA FORM 2028-2

UNIT'S ADDRESS

POSTAGE AND FEES PAID
DEPARTMENT OF THE ARMY
DOD 314

U.S. MAIL

57

FILL IN YOUR UNIT'S ADDRESS

FOLD BACK

DEPARTMENT OF THE ARMY

OFFICIAL BUSINESS
PENALTY FOR PRIVATE USE \$300

Commander
US Army Communications-Electronics Command
and Fort Monmouth
ATTN: DRSEL-ME-MP
Fort Monmouth, New Jersey 07703

5-8548 JS 70

TEAR ALONG PERFORATED LINE

RECOMMENDED CHANGES TO EQUIPMENT TECHNICAL PUBLICATIONS



THEN...JOT DOWN THE DOPE ABOUT IT ON THIS FORM. CAREFULLY TEAR IT OUT, FOLD IT AND DROP IT IN THE MAIL.

SOMETHING WRONG WITH THIS PUBLICATION?

FROM: (PRINT YOUR UNIT'S COMPLETE ADDRESS)

DATE SENT

PUBLICATION NUMBER

PUBLICATION DATE

PUBLICATION TITLE

BE EXACT PIN-POINT WHERE IT IS

PAGE NO. PARA-GRAPH FIGURE NO. TABLE NO.

IN THIS SPACE TELL WHAT IS WRONG AND WHAT SHOULD BE DONE ABOUT IT:

TEAR ALONG PERFORATED LINE

PRINTED NAME GRADE OR TITLE AND TELEPHONE NUMBER

SIGN HERE

DA FORM 2028-2 1 JUL 78

PREVIOUS EDITIONS ARE OBSOLETE

P.S.--IF YOUR OUTFIT WANTS TO KNOW ABOUT YOUR RECOMMENDATION MAKE A CARBON COPY OF THIS AND GIVE IT TO YOUR HEADQUARTERS.



FILL IN YOUR UNIT'S ADDRESS

FOLD BACK

DEPARTMENT OF THE ARMY

POSTAGE AND FEES PAID
DEPARTMENT OF THE ARMY
DOD-314



OFFICIAL BUSINESS
PENALTY FOR PRIVATE USE, \$300

Commander
US Army Communications
Electronics Command
ATTN: DRSEL-ME-MP
Fort Monmouth, New Jersey 07703

TEAR ALONG DOTTED LINE

FOLD BACK

RECOMMENDED CHANGES TO EQUIPMENT TECHNICAL PUBLICATIONS



THEN...JOT DOWN THE DOPE ABOUT IT ON THIS FORM. CAREFULLY TEAR IT OUT, FOLD IT AND DROP IT IN THE MAIL.

SOMETHING WRONG WITH THIS PUBLICATION?

FROM: (PRINT YOUR UNIT'S COMPLETE ADDRESS)

DATE SENT

PUBLICATION NUMBER

PUBLICATION DATE

PUBLICATION TITLE

BE EXACT PIN-POINT WHERE IT IS

PAGE NO.	PARA-GRAPH	FIGURE NO.	TABLE NO.

IN THIS SPACE TELL WHAT IS WRONG AND WHAT SHOULD BE DONE ABOUT IT:

TEAR ALONG PERFORATED LINE

PRINTED NAME GRADE OR TITLE AND TELEPHONE NUMBER

SIGN HERE

DA FORM 2028-2
JUL 79

PREVIOUS EDITIONS ARE OBSOLETE

P.S.-IF YOUR OUTFIT WANTS TO KNOW ABOUT YOUR RECOMMENDATION MAKE A CARBON COPY OF THIS AND GIVE IT TO YOUR HEADQUARTERS.

FILL IN YOUR UNIT'S ADDRESS

FOLD BACK

DEPARTMENT OF THE ARMY

POSTAGE AND FEES PAID
DEPARTMENT OF THE ARMY
DOD-314



OFFICIAL BUSINESS
PENALTY FOR PRIVATE USE, \$300

Commander
US Army Communications
Electronics Command
ATTN: DRSEL-ME-MP
Fort Monmouth, New Jersey 07703

TEAR ALONG DOTTED LINE

FOLD BACK

RECOMMENDED CHANGES TO EQUIPMENT TECHNICAL PUBLICATIONS



THEN...JOT DOWN THE DOPE ABOUT IT ON THIS FORM. CAREFULLY TEAR IT OUT, FOLD IT AND DROP IT IN THE MAIL.

SOMETHING WRONG WITH THIS PUBLICATION?

FROM: (PRINT YOUR UNIT'S COMPLETE ADDRESS)

DATE SENT

PUBLICATION NUMBER

PUBLICATION DATE

PUBLICATION TITLE

BE EXACT PIN-POINT WHERE IT IS

PAGE NO.	PARA-GRAPH	FIGURE NO.	TABLE NO.
----------	------------	------------	-----------

IN THIS SPACE TELL WHAT IS WRONG AND WHAT SHOULD BE DONE ABOUT IT:

TEAR ALONG PERFORATED LINE

PRINTED NAME GRADE OR TITLE AND TELEPHONE NUMBER

SIGN HERE

DA FORM 2028-2
1 JUL 78

PREVIOUS EDITIONS ARE OBSOLETE

P.S.-IF YOUR OUTFIT WANTS TO KNOW ABOUT YOUR RECOMMENDATION MAKE A CARBON COPY OF THIS AND GIVE IT TO YOUR HEADQUARTERS.

FILL IN YOUR UNIT'S ADDRESS

FOLD BACK

DEPARTMENT OF THE ARMY

POSTAGE AND FEES PAID
DEPARTMENT OF THE ARMY
DOD-314



OFFICIAL BUSINESS
PENALTY FOR PRIVATE USE, \$300

Commander
US Army Communications
Electronics Command
ATTN: DRSEL-ME-MP
Fort Monmouth, New Jersey 07703

FOLD BACK

TEAR ALONG DOTTED LINE

REVERSE OF DA FORM 2028-2