

**TECHNICAL MANUAL**

**OPERATOR AND ORGANIZATIONAL MAINTENANCE MANUAL,  
INCLUDING REPAIR PARTS AND SPECIAL TOOL LISTS**

**RADIO SET AN/GRC-165  
(NSN 5820-00-935-8038)  
AND  
CONTROL, RADIO SET C-7648/GRC-165  
(NSN 5820-00-931-9139)**

**This copy is a reprint which includes current pages  
from Changes 1 through 4. Title was changed by  
Change 4 as shown above.**

### **WARNING**

**Voltages of up to 1,035 and 230 volts ac and + 800 volts de exists in Receiver Transmitter, Radio RT.-902/grc-165. Be extremely careful not to come in contact with the voltages. DEATH ON CONTACT can result if operating personnel fail to observe safety precautions. DO NOT operate the RT-902/GRC-165 without an RF load: a lethal shock hazard will exist and damage to the equipment can result.**

### **CAUTION**

**Do not make resistance measurements in transistorized circuits of this equipment except as specified: the voltages present in the ohmmeter may destroy transistor.**



**OPERATOR AND ORGANIZATIONAL MAINTENANCE MANUAL,  
 INCLUDING REPAIR PARTS AND SPECIAL TOOL LISTS  
 RADIO SET AN/GRC-165 (NSN 5820-00-935-8038) AND CONTROL, RADIO SET  
 C-7648/GRC-165 (NSN 5820-00-931-9139)**

		Paragraph	Page
CHAPTER	1 INTRODUCTION		
Section	I. General-----	1-1-1-3.4	1-1, 1-2
	II. Description and data -----	1-4-1-11	1-2-1-5
CHAPTER	2. INSTALLATION -----	2-1-2-7	2-1-2-6
CHAPTER	3. OPERATING INSTRUCTIONS		
Section	I. Operator Controls, Indicators, and Connectors -----	3-1-3-4	3-1-3-5
	II. Operation Under Usual Conditions -----	3-5-3-9	3-6,3-7
CHAPTER	4. OPERATOR MAINTENANCE -----	4-1-4-7	4-1,4-2
CHAPTER	5. ORGANIZATION MAINTENANCE		
Section	I. Maintenance -----	5-1-5-8	5-1-5-3
	II. Troubleshooting -----	5-9-5-12	5-6-5-8
CHAPTER	6. SHIPMENT, LIMITED STORAGE, AND DEMOLITION TO PREVENT ENEMY USE		
Section	I. Shipment and limited storage -----	6-1,6-2	6-1
	II. Demolition to prevent enemy use -----	6-3,6-4	6-1
APPENDIX	A. REFERENCES -----		A-1
	B. BASIC ISSUE ITEMS (Deleted)		
	C. MAINTENANCE ALLOCATION		
Section	I. Introduction-----		C-1
	II. Maintenance Allocation Chart for Radio Set AN/GRC-165 -----		C-3
APPENDIX	D. ORGANIZATIONAL MAINTENANCE REPAIR PARTS AND SPECIAL TOOLS-----		D-1
INDEX -----			I-1

**LIST OF ILLUSTRATIONS**

<i>Figure Number</i>	<i>Title</i>	<i>Page</i>
1-1	Radio Set AN/GRC-165, Including Optional Power Cables-----	1-0
1-2	Control, Radio Set C-7648/GRC-165 -----	1-2
2-1	Typical Packaging -----	2-2
2-2	Radio Set AN/GRC-165 and Control Radio Set C-7648/GRC-165 Pictorial Cabling Diagram-----	2-4
2-3	Radio-AN/GRC-165, Typical Trailer Installation -----	2-5
2-4	Typical Dipol Antenna Installation -----	2-7
2-5	Antenna AS-2203/GRC-165-----	2-8
3-1	Receiver-Transmitter, radio RT-902/GRC-165 Front Panel -----	3-2
3-2	Receiver-Transmitter, Radio RT-902/GRC-165 Rear panel -----	3-3
3-3	Coupler, Antenna CU-1782/GRC-165, Front Panel-----	3-4
3-4	Coupler, Antenna CU-1782/GRC-165, Front Panel-----	3-5
3-5	Control, Radio Set C-7648/GRC-165, Front Panel-----	3-5
5-1	Rt Unit, Top View, Location of Lubrication Points -----	5-3
5-2	Rt Unit, Serial Numbers Prior to #1964, Bottom View, Location of Test and Lubrication Points -----	5-4
5-2.1	Rt Unit, Serial Numbers 6407 through 6444, Bottom View, Location of Test and Lubrication points -	5-4.1
5-3	Antenna Coupler, Left Side, Location Lubrication Points-----	5-5
5-4	Antenna Coupler, Right Side, Location of Lubrication Points -----	5-6

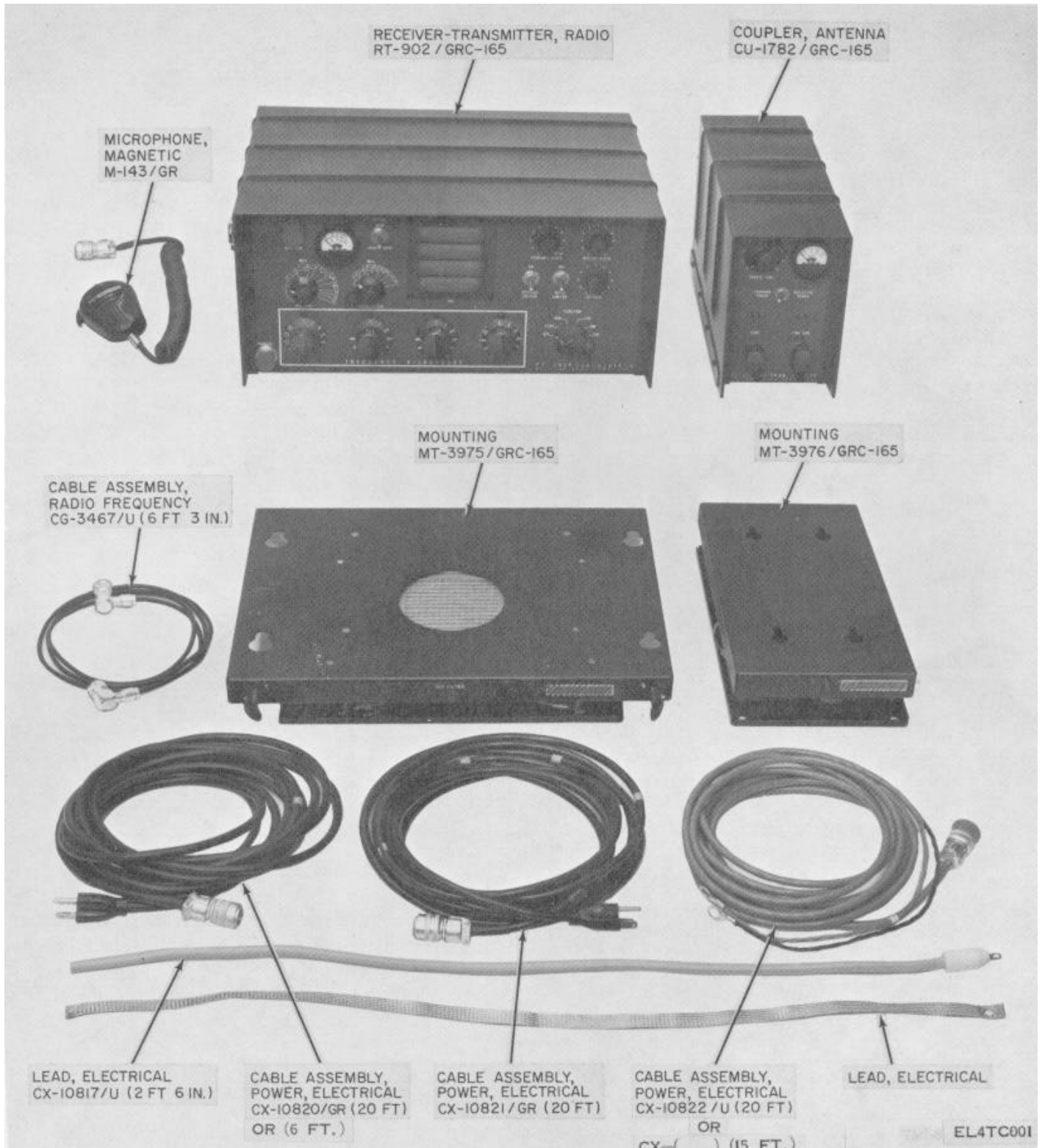

Figure 1-1. Radio Set AN/GRC-165, including optional power cables.

Change 4 1-0

## CHAPTER 1 INTRODUCTION

### Section I. General

#### 1-1. Scope

a. This manual describes Radio Set AN/ GRC-165 (radio set) (fig. 1-1) and Control, Radio Set C-7648/GRC-165 (fig. 1-2), and covers their installation, operation, troubleshooting, and organizational maintenance. It also includes instructions for using the radio set in usual and unusual conditions and for extending the transmission distance beyond the normal range.

b. The maintenance allocation chart appears in appendix C and the repair parts and special tool lists appear in appendix D.

#### NOTE

**Appendix D is current as of 22 May 1970.**

#### 1-2. Indexes of Publications

a. *DA Pam 310-4.* Refer to the latest issue of DA Pam 310-4 to determine whether there are new editions, changes, or additional publications pertaining to the equipment.

b. *DA Pam 310-7.* Refer to the latest issue of DA Pam 310-7 to determine whether there are modification work orders (MWO's) pertaining to the equipment.

#### WARNING

**Voltages of up to 1,035 and 230 volts ac and +800 volts dc exist in Receiver transmitter, Radio RT-902/GRC-165. Be extremely careful not to come in contact with these voltages. DEATH ON CONTACT can result if operating personnel fail to observe safety precautions. DO NOT operate the RT-902/ GRC-165 without an RF load; a lethal shock hazard will exist and damage to the equipment can result.**

#### CAUTION

**Do not make resistance measurements in transistorized circuits of this equipment except as specified; the voltages present in the ohmmeter may destroy transistor.**

#### NOTE

**Throughout this manual references to RT-902/GRC-165 (rt unit) also refers**

**to RT-902A/GRC-165; references to CU1782/GRC-165 (antenna coupler) also refers to CU-1782A/GRC-165; and references to C-7648/GRC-165 (remote control) also refers to C-7648A/GRC-165.**

#### 1-3. Forms and Records

a. *Reports of Maintenance and Unsatisfactory Equipment.* Maintenance forms, records, and reports which are to be used by maintenance personnel at all maintenance levels are listed in and prescribed by TM 38-750.

b. *Report of Packaging and Handling Deficiencies.* Fill out and forward DD Form 6 (Packaging Improvement Report) as prescribed in AR 700-58/NAVSUPINST 4030.29/AFR 7113/MCO P4030.29A, and DLAR 4145.8.

c. *Discrepancy in Shipment Report (DISREP) (SF 361).* Fill out and forward Discrepancy in Shipment Report (DISREP) (SF 361) as prescribed in AR 55-38/NAVSUPINST 4610.33B/AFR 75-18/MCO P4610.19C, and DLAR 4500.15.

##### 1-3.1. Reporting of Errors

The reporting of errors, omissions, and recommendations for improving this publication by the individual user is encouraged. Reports should be submitted on DA Form 2028 (Recommended Changes to Publications and Blank Forms) and forwarded direct to Commander, US Army Electronics Command, ATTN: DRSELMA-Q, Fort Monmouth, New Jersey 07703.

##### 1-3.2. Administrative Storage

Administrative storage of equipment issued to and used by Army activities shall be in accordance with TM 740-90-1.

##### 1-3.3. Destruction of Army Electronics Materiel

Destruction of Army electronics materiel to prevent enemy use shall be in accordance with

**1-3.4. Reporting Equipment Improvement Recommendations (EIR)**

EIR's will be prepared using DA Form 2407 (Maintenance Request). Instructions for preparing EIR's are provided in TM 38-750, The Army Maintenance

Management System. EIR's should be mailed directly to Commander, US Army Electronics Command, ATTN: DRSELMA-Q, Fort Monmouth, New Jersey 07703. A reply will be furnished directly to you.

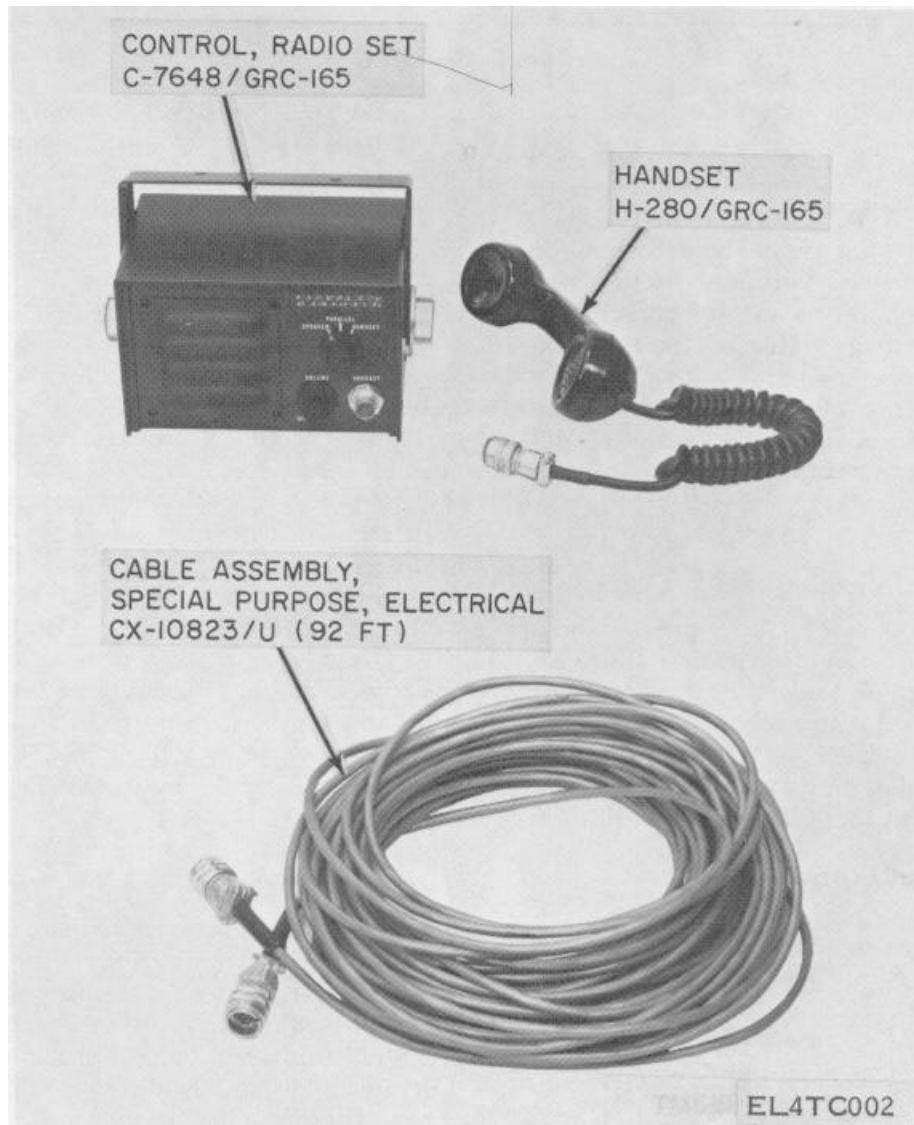

Figure 1-2. Control, Radio Set C-7648/GRC-165.

**Change 4 1-2**

Section II. DESCRIPTION AND DATA

1-4. Purpose and Use

Radio Set AN/GRC-165 is a variable frequency single sideband (Ssb) radio set, capable of transmitting and receiving lower sideband (lsb), upper sideband (Usb), continuous wave (Cw), and amplitude modulation (AM) signals to be used in mobile, transportable, or fixed installations. The radio set can be operated on any frequency assigned in the 2- to 15-megahertz (MHz), high frequency (hf) range, and provides an output of 100-watt peak envelope power. The radio set has been designed for rugged service and has a splashproof case. Compactness, high reliability, and moderate power consumption result from the maximum use of transistors and other solid-state devices. Digital frequency selection

is provided for both receiving and transmitting. When used with Control, Radio Set C7648/GRC165, keying and audio functions of Radio Set AN/GRC165 can be remotely extended to distances of up to 92 feet (29.04 meters) (the length of Cable Assembly, Special Purpose, Electrical C-10823/U) from the radio set.

1-5. Technical Characteristics

The technical characteristics of Receiver Transmitter, Radio RT-902/GRC-165; Coupler, Antenna CU-1782/GRC-165; and Control, Radio Set C-7648/GRC165 are listed in a, b, and c below.

a. Receiver Transmitter, Radio RT-902/GRC-165.

Frequency range.....	2 to 15 MHz.
Resolution .....	kHz digital (13,000 channels).
Frequency stability.....	1 part in 106 per month.
Modulation .....	Amplitude.
Type of transmission.....	Usb, lsb, AM (compatible), and cw.
Power output .....	Ssb: 100-watt peak envelope power. Cw: 100 watts average. AM: 25-watt carrier (nominal).
Range .....	30 miles (42 km).
Transmitter output impedance.....	52 ohms (swr 1.5 to 1, or better).
Carrier suppression.....	—50 db (nominal)
Undesired sideband suppression.....	—50 db.
Harmonic suppression .....	—45 db (nominal).
Intermodulation distortion.....	—35 db (nominal).
Receiver sensitivity (ssb).....	1 microvolt for 10-db signal to noise ratio.
Receiver sensitivity (AM).....	3 microvolts with 30-percent modulation.
Selectivity (ssb) .....	300 to 3,500 Hz, 6 db.
Selectivity (AM).....	11 kHz (nominal).
Audio power output.....	2 watts.
Power consumption (ac):	
Serial numbers prior to #1964.....	115 vac, 4 amperes; 230 vac, 3 amperes, 50 to 60 Hz, single phase.
Serial numbers # 6407 through - 6444.....	115 vac, 2.9 amperes; 230 vac, 1.5 amperes; 50 to 60 Hz, single phase.
Power consumption (dc):	
Serial numbers prior to # 1964	
With Chopper, Electronic CV-2487/URC.....	13.5 vdc, 28 amperes.
With Chopper, Electronic CV-2486/URC.....	26 vdc, 15 amperes.
Serial numbers d 6407 through # 6444	
With Chopper, Electronic CV-2487/URC.....	13.5 vdc, 27 amperes 17
WITH CHOPPER, ELECTRONIC CV-2486/URC .....	27.5 vdc. 13 amperes

b. Coupler, Antenna CU-1782/GRC-165

Power rating .....	150-watt average power.
Input impedance .....	52 ohms.
Swr .....	1.5 to 1, or better.
Matching capability .....	All unbalanced antennas 9 feet or longer.

c. Control Radio Set c-7 7648/GRC 165.

Power output .....	2 watts
Power consumption .....	13.5 vdc, 0.5 ampere.

**1-6. Items Comprising an Operable Equipment**

<i>FSN</i>	<i>Qty</i>	<i>Nomenclature, part No., and mfr. code</i>	<i>Fig. No.</i>
5820-935-8038	---	Radio Set AN/GRC165 (This item is nonexpendable) consisting of:	
5995-022-2742	1	Cable Assembly, Radio Frequency CG-34671U (6 ft 3 in.) -----	1-1
5995-042-5478	1	Cable Assembly, Power, Electrical CX-10820/GR (20 ft) or (6 ft) -----	1-1
5995-022-2741	1	Lead, Electrical CX-10817/U (2 ft 6 in.) -----	1-1
		Lead, Electrical: 162-2175; 14304	
5965-102-3803	1	Microphone, Magnetic M-143/GR	
5820-935-2232	1	Mounting MT-3975/GRC165	
5820-935-2287	1	Mounting MT-3976/GRC-165	
5820-931-9152	1	Receiver-Transmitter, Radio RT-902/GRC165	
5985-931-9128	1	Coupler, Antenna CU-1782/GRC-165 -----	1-1
		The following is also required:	
		Antenna AS-2203/GRC-165 consisting of:	
5985-733-6042	1	Antenna Element AT-1039/U -----	2-5
5985-733-6043	1	Antenna Element AT-104/U -----	2-5
5985-733-6044	1	Antenna Element AT-1041/U -----	2-5
5985-733-6045	1	Antenna Element AT-1042/U -----	2-5
5820-931-9106	1	Base, Antenna Support AB-1082/GRC-165 -----	
		The following is required for remote operation:	
5820-931-9139	1	Control, Radio Set C-7648/GRC-165 including:	
5995-042-5482	1	Cable Assembly, Special Purpose, Electrical CX-10823/U (92 ft) -----	1-2
5965-102-8521	1	Handset H-280/GRC-165 -----	1-2
		The following may be required dependent upon power requirements:	
5820-931-9030	1	Chopper, Electronic CV-2486/URC	
5820-931-9031	1	Chopper, Electronic CV-2487/URC	
5995-422-2743	1	Cable Assembly, Power, Electrical CX-10821/GR (20 ft) -----	1-1
5995-042-5481	1	Cable Assembly, Power, Electrical CX-10822/U (20 ft) (u/w sin 1964 and prior)----	1-1
	1	Cable Assembly, Power, Electrical CX-( ) (15 ft) (u/w s/n 4224 and later)	

**1-6.1. Running Spares**

Deleted.

*NOMENCLATURE*

*Common name*

Cable Assembly, Special, Electrical-----	Remote cable.
CX-10823/U (92 ft).	
Chopper, Electronic CV-2486/URC-----	27.5 volt chopper.
Chopper, Electronic CV-2487/URC-----	13.5-volt chopper.

**1-7. Common Names**

Listed below are nomenclature assignments with common names for the components of Radio Set AN/GRC-165 and Control, Radio Set C-7648/GRC-165.

<i>NOMENCLATURE</i>	<i>Common name</i>
Radio Set AN/GRC165 -----	Radio Set.
Receiver-Transmitter, Radio RT-.902-----	Rt unit.
GRC165	
Coupler, Antenna CU-1782/GRC165 -----	Antenna coupler.
Mounting MT-3975/GRC165 -----	Large mounting.
Mounting MT-3976/GRC165 -----	Small mounting.
Microphone, Magnetic M-143/GR -----	Microphone.
Cable Assembly, RF CG3467/U -----	RF cable.
(6 ft 3 in.).	
Lead, Electrical CX-10817/U-----	Antenna lead-in.
(2 ft 6 in.).	
Cable Assembly, Power, Electrical -----	115-volt ac power
CX-10820/GR (20 ft) -----	cable.
or (6 ft).	
Cable Assembly, Power, Electrical -----	230-volt ac power
CX-10821/GR (20 ft).-----	cable.
Cable Assembly, Power, Electrical -----	Dc power cable.
CX-10822/U (20 ft),	
or CX-( ) (15 ft).	
Lead, electrical -----	Ground strap.
162-2175	
Control, Radio Set C-7648/GRC165 -----	Remote control.
Handset H-280/GRC-165 -----	Handset.

**1-8. Description of Equipment**

a. *Radio Set.* The radio set includes an rt unit, an antenna coupler, a microphone, and interconnecting cables. The radio set, which includes all equipment necessary for operation except an antenna and a primary power supply, provides two-way communication in either mobile or fixed station use. In some radio set applications, the remote control will be used.

(1) The rt unit and the antenna coupler are secured to the large mount and small mount, respectively, which usually are bolted to a vehicular mounting surface. The large mount has a removable air filter through which air is drawn by a fan. This cooling air is forced through the rt unit and exhausted out a port in the rear panel.

(2) Except for the microphone at the rt unit front panel, all cable connections are made at the rear panels. Rear panel connections include the interconnecting transmission line, an antenna lead-in, a dc power cable, and (if used) the remote cable. All operating controls, meters, and speaker are on the front panels of the units, which are housed in hand-portable, splashproof chassis with ruggedized covers.



(3) A power supply, contained in the rt unit, provides all the operating voltages for the radio set and the remote control. Differences in primary power requirements for the radio set are described in paragraph 1-10.

(4) The radio set provides all components necessary for operation from 115 volts ac power except an antenna. If operation from dc power or 230 volts ac power is desired, the additional cable and dc chopper (if required) must be separately requested.

b. *Remote Control.* A complete remote control (fig. 1-2) includes the handset and the remote cable. The remote control, when used, provides remote operation and monitoring of the radio set keying and audio functions. The remote control is contained in a hand-portable, splashproof chassis with a ruggedized cover (painted olive drab). Operating controls, a HANDSET connector, and a speaker are mounted on the front panel. In some vehicle or fixed station installations, the remote control can be secured by an attached swivel mounting bracket and can be tilted to a convenient angle for ease of operation.

**1-9. Additional Equipment Required**

An antenna and a primary power source are not supplied with the radio set but are needed for operation. Although any whip or straight wire antenna 9 to 36 feet in length may be used. Antenna AS-2203/GRC-165 (fig. 2-5) and a dipole antenna are intended for use with the radio set.

antenna are intended for use with the radio set. The primary power source must equal the voltage requirement and exceed the current requirement of the radio set.

**1-10. Power Requirements**

RT units with a 27.5-volt chopper installed, can operate from either 27.5-volt direct current (dc), or 115- or 230-volt alternating current (ac) primary power. Rt units, with a 13.5-volt chopper installed can operate on either 13.5-volt dc, 115volt ac, or 230-volt ac primary power. Rt. units without a chopper can be operated from ac power only.

**1-11. Differences in Models**

Differences in models of the rt unit, antenna coupler, and the control unit are due to various circuit changes. Major impact of the circuit changes is in the area of unit weight (para 2-1) and power consumption (para 1-5). The changes are implemented by serial numbers indicated in the following chart

Nomenclature.	Serial Number Assignments	
	Contract No. DAAB07- 67-C-0529	Contract No. DAAB07- 74-C-0484
RT.-902/GRC-165	1 through 1964	6407 through 6444
CU-1782/GRC-165	1 through 4999	5000 and subsequent
C-7648/GRC-165	1 through	1900 and subsequent

**CHAPTER 2  
INSTALLATION**

**2-1 Unpacking Instructions and Packing Data**

*a. Packing Data.* When packed for shipment, individual components of the radio set are placed in cartons, or plastic containers, which are packed in a wooden shipping crate. The remote control and the handset are packaged and shipped separately in corrugated cartons. A typical shipping crate is shown in figure 2-1.

*b. Dimensions and Weight.* The shipping crate is 22 1/2 inches high by 34 1/2 inches long by 17 1/4 inches wide, weighs 155 pounds, and occupies a volume of 7 3/4 cubic feet. The nominal dimensions and weights of the radio set components and accessories are given in the chart below.

**NOTE**

**Where two values are given for the rt unit in the chart below, the first value applies to unit serial numbers prior to 1964. The values given in parenthesis apply to unit serial numbers : 6407 through : 6444. The first values for the antenna coupler apply to coupler serial numbers prior to # 5000 and the values in parenthesis apply to serial numbers # 5000 and up.**

Item	Dimensions (in.)			Weight (lb.)
	Width	Depth	Height	
Rt. unit -----	18'h	15-3/8	8	59(46 1/2)
Antenna couple-----	5/4	15	8	9(7)
CV-2486/URC-----	4-3/8	4	2-7/8	11
CV-2487/URC-----	4-3/8	4	2-7/8	1 h
Remote control-----	9	7	5 1/4	4
Large mount-----	17	12-3/8	23/4	8
Small mount-----	7	12-3/8	2'A	3

*c. Removal of Contents* (fig. 2-1).The unpacking procedures are given in (1) through (7) below.

- (1) Cut and fold back the metal straps.

**CAUTION**

**Do not attempt to pry off the wooden cover; equipment damage may result.**

- (2) Remove the nails from the wooden cover of the packing case with a nailpuller and lift off the wooden cover.

- (3) Remove the corrugated filler and the corrugated support; then remove the corrugated cardboard fillers.

- (4) Remove the cable assemblies surrounding the corrugated carton.

- (5) With a knife or sharp instrument cut the tape that seals the inner corrugated carton and open the flaps. Remove the filler material that surrounds the equipment.

- (6) Remove the rt unit, the antenna coupler, and the technical manual.

- (7) Remote the rt unit and the antenna coupler from their plastic bags.

**2-2. Checking Unpacked Equipment**

*a.* Inspect the equipment for damage that may have occurred during shipment. If the equipment has been damaged, fill out and forward DD Form 6 (para 1-3b).

*b.* to see that the equipment is complete as listed on the packing slip or as listed in paragraph 1-6. Report all discrepancies in accordance with the instructions given in AR 735-11-2.

*c.* If the equipment has been used or reconditioned, check to see whether it has been changed by a modification work order. If the equipment has been modified, the MWO number will appear on the front panel, or near the nomenclature plate.

**2-3. Radio Set Installation**

Figure 2-2 is a pictorial cabling diagram.

*a. mobile Installation* procedures for mobile application of the radio set are given below. Figure 2-3 shows a typical installation in a trailer.

**NOTE**

**The antenna must be located within 3 feet of the antenna coupler (the antenna coupler is used when the whip antenna is used).**

- (1) Secure the large mount and the small mount to the vehicle or trailer floor.

- (2) Attach and secure the rt. unit and the antenna coupler to their respective mount.

- (3) Attach antenna and connect to antenna coupler using the antenna lead-in.

- (4) Connect RF cable between rt. unit ANTENNA connector (fig. 2-2), and antenna coupler INPUT connector.

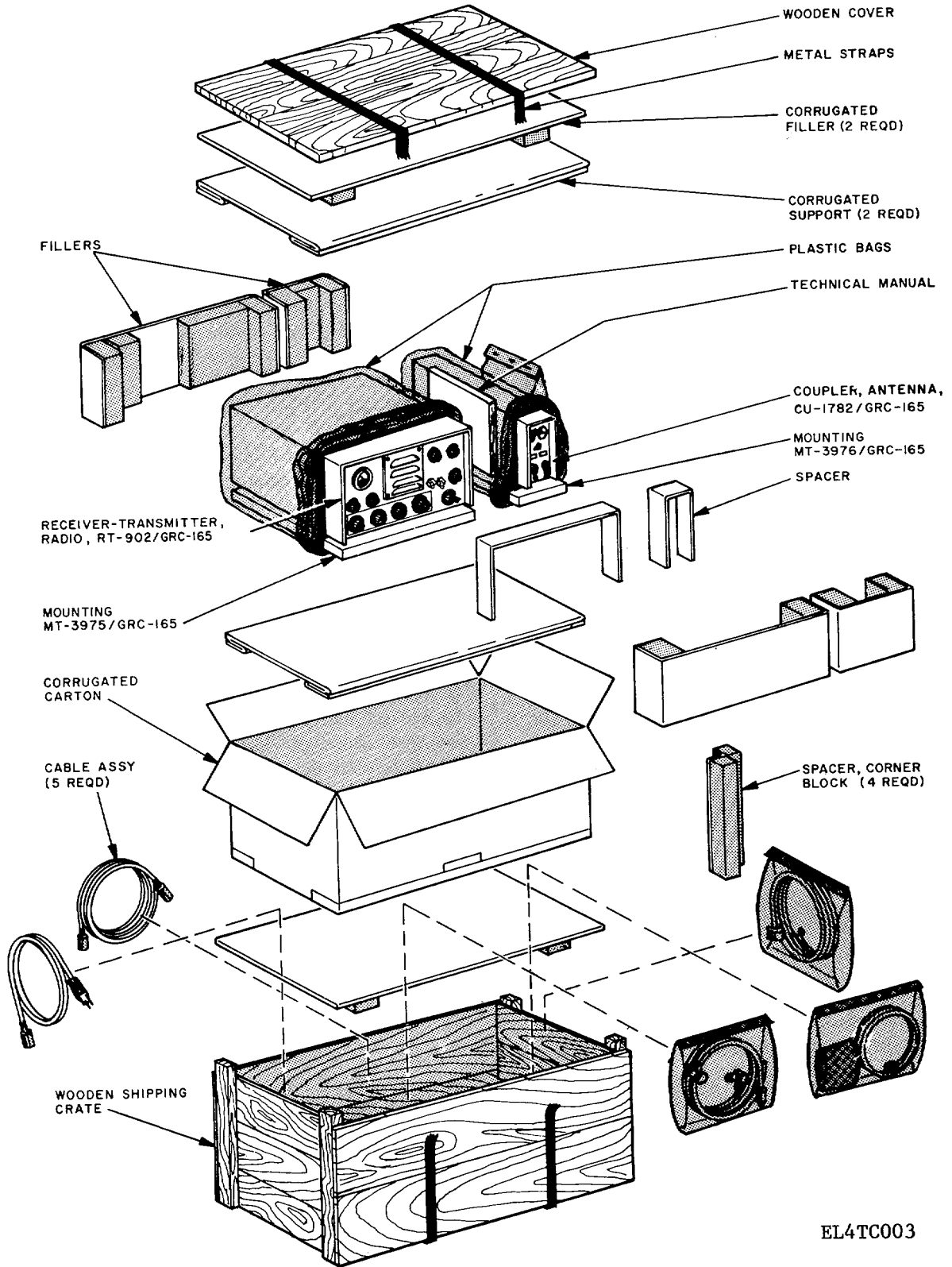

EL4TC003

Figure 2-1. Typical packaging.

(5) Connect braided ground strap between rt. unit GROUND post, and antenna coupler GROUND post.

#### CAUTION

**Set the rt. unit FUNCTION switch to OFF and power selector switch S1 (at rear panel of rt. unit) to DC. Observe polarity of the dc power cable and the power source.**

(6) Connect the dc power cable to the DC connector on the rt unit, and the spade lug to the vehicle battery or generator (red to positive, black to negative).

(7) If the remote control is to be used, connect the remote cable to the REMOTE connector on the rt. unit and to the connector at the rear of the remote control.

(8) Store technical manuals, running spares, and extra cables in a designated or protected place.

*b. Fixed Station Installations.* Installation procedures for fixed station operation are given below.

#### NOTE

**Refer to paragraph 2-4 and figure 2-2. If operation requires the use of the antenna coupler, place it not farther than 3 feet away from the antenna. The rt. unit can be installed at a distance of up to approximately 100 feet (30.5 meters) from the antenna coupler, or approximately 92 feet (29.04 meters) from the remote control; however, best operation is achieved by using the rt. unit mounted next to the antenna coupler, with the remote control located at a convenient distance away (some distance less than the length of the remote cable). The dipole antenna or straight wire antenna is connected direct to the rt. unit.**

(1) Place the rt. unit and the antenna coupler (if the whip antenna or an unbalanced antenna is used) at the desired location. If shock mounting is used, secure the large mount and the small mount and attach the rt. unit and the antenna coupler, respectively.

(2) Connect the antenna to the antenna coupler ANT. connector

(3) Connect the RF cable between the rt. unit ANTENNA connector and the antenna coupler INPUT connector.

(4) Connect the braided ground strap between the rt. unit GROUND post and the antenna coupler GROUND post.

#### CAUTION

**Observe polarity of the power cable and the power source. If operating on ac primary power, make sure that power selector switch S1, at the rear of the rt. unit, is set to the position corresponding to the primary power voltage.**

(5) Connect the dc power cable to the rt. unit DC connector if dc primary power is being used. For ac operation, connect either the 115-volt ac power cable or the 230-volt ac power cable to the rt. unit 115 VAC / 230 VAC connector.

(6) If remote control operation is to be used install the remote cable to the rt. unit REMOTE connector and to the connector at the rear of the remote control.

(7) Store technical manuals. and extra cables in a designated or protected place.

#### 2-4. Siting

*a.* Effective communications and anti jamming require antenna siting. A site is generally best when it is flat, high, and clear. If possible, avoid mountains, hills, heavily wooded areas, and jungles. Obstructions, such as buildings (especially those containing large amounts of metal), trees, or large objects should not be near the antenna.

*b.* The type of surface where the antenna is located and over which radio frequency (RF) energy travels is important. The best surfaces are clay, loam, marsh or swamp, alkali soil, and water (lakes, bays, and oceans). The worst are coral, dry sand, and rock. Dense jungles are especially poor because ground wave range (para 2-5a) will be greatly reduced.

*c.* Communications can usually be established between mountains, hills, and obstructions if there is an unobstructed path direct to the desired remote station. Use this condition to reduce the effects of enemy jamming. Block the jamming signals with an obstruction near the antenna in the direction of the source. If possible, provide an unobstructed path to the desired signal.

*d.* Avoid interference from power and telephone lines, radar sets, and field hospitals. If possible,

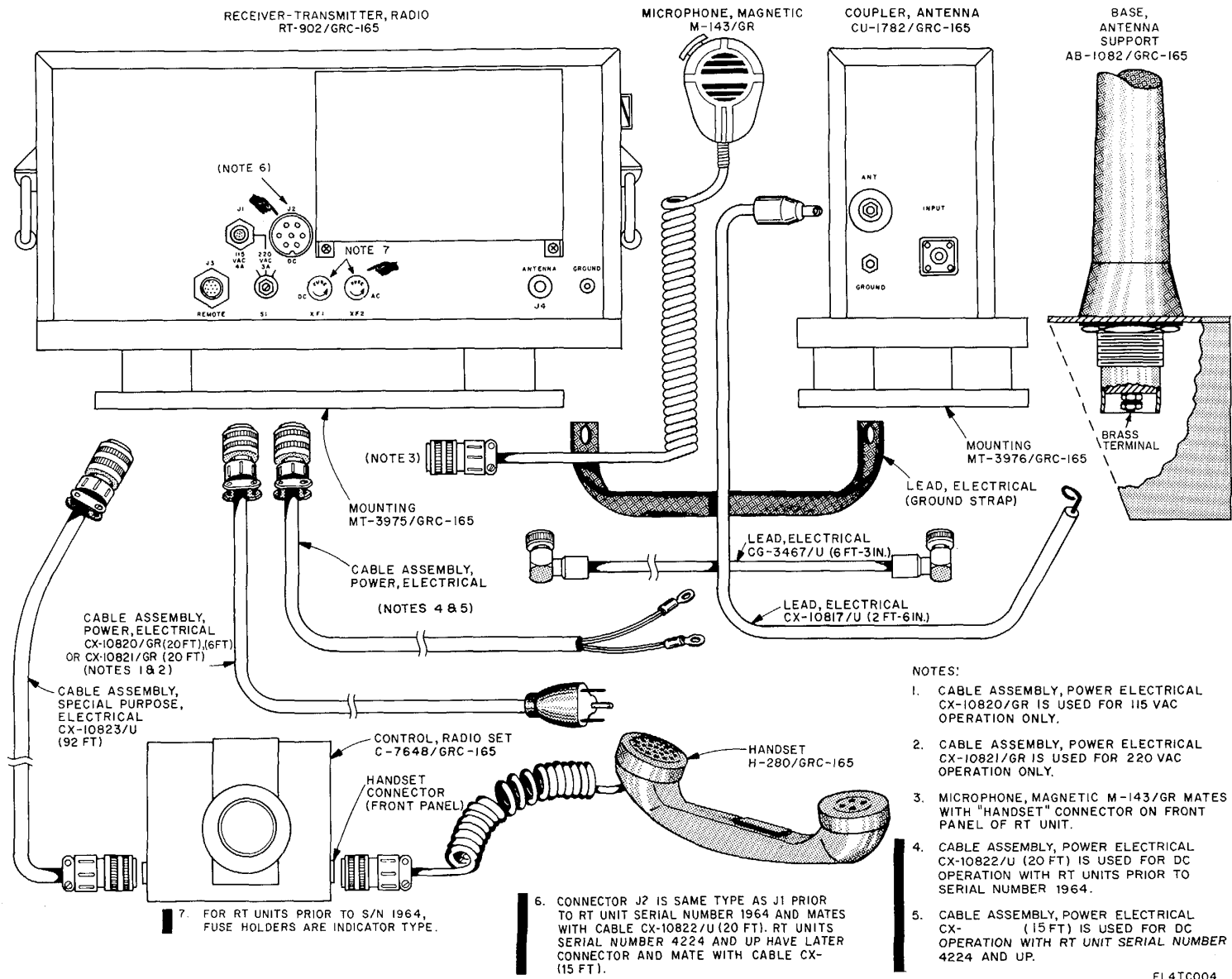
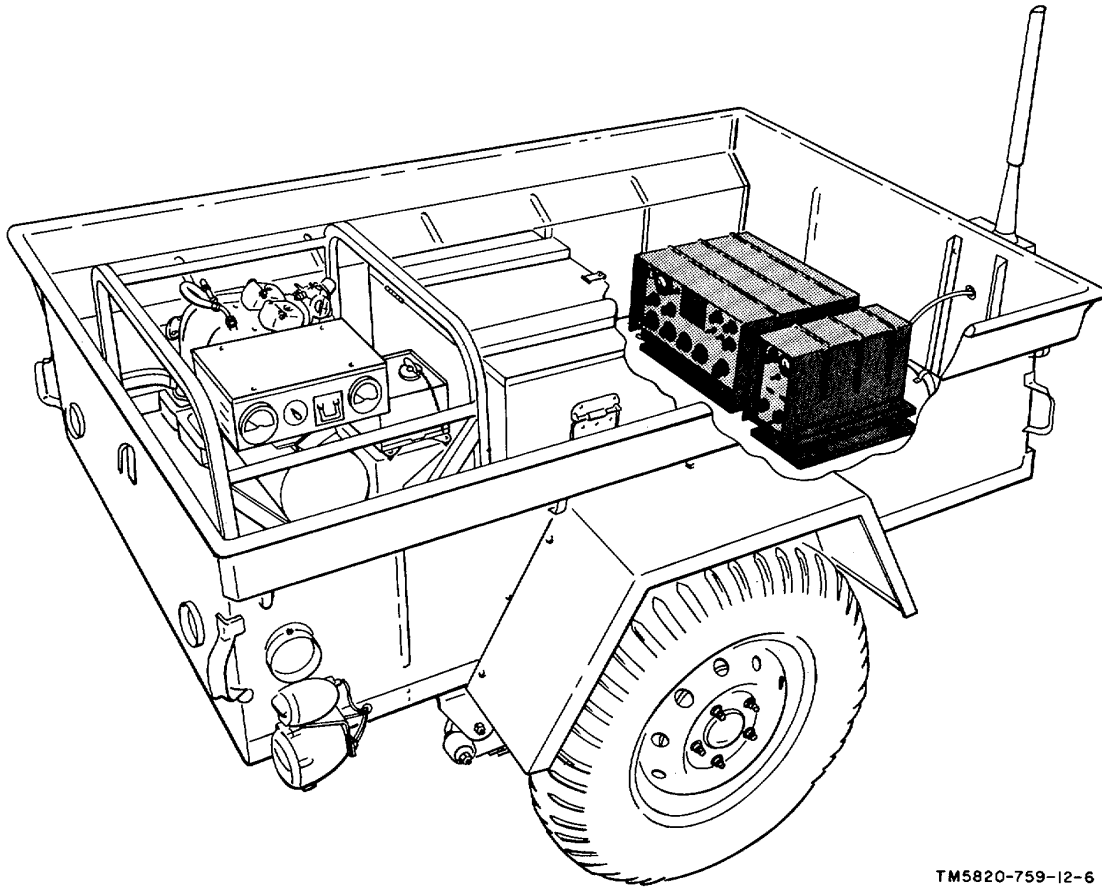

Figure 2-2. Radio Set AN/GRC-165 and Control, Radio Set C-7648/GRC-165 pictorial cabling diagram.



TM5820-759-12-6

Figure 2-3. Radio Set AN/GRC-165, typical trailer installation

try several locations within the general area and select the one that provides best signal reception from the desired stations.

## 2-5. Ranging

a. Under most conditions, a reliable communications range of 30 miles is provided by the radio set. Greater ranges require using the current propagation conditions to their full advantage as well as providing a good antenna and site. Both groundwave propagation and skywave propagation should be used for their advantages, and each should be considered when the operating frequencies are selected.

b. The groundwave propagation range, which is nominally 30 miles, can be increased to 100 miles

by using the lowest available frequency and the longest antenna, such as either a 35-foot whip antenna, or a straight wire antenna. The longwire antenna length is determined by the following equation:

$$\text{Length (in feet)} = \frac{490}{\text{frequency MHz}}$$

c. Skywave propagation refers to RF signals reflected back to the earth from the ionosphere. This enables communications over distances greater than would be possible with groundwave propagation. When using skywave propagation, always start with the highest available frequency and work down the frequency range until contact is made. Since the ionosphere changes with the time of day, daytime frequencies will be higher than

nighttime. Try 9 to 15 MHz in the ,daytime and 6 to 12 MHz during the night.

**2-6. Recognition of Jamming**

It is likely that under real or simulated tactical conditions the rt unit will be jammed by the enemy. Unusual noises or strong interference heard from the rt. unit may be enemy jamming, signals from a friendly station, or noise from a local source, or the rt. unit may be defective. To determine whether the interference is originating in the rt. unit, -disconnect the antenna, or short the ANT terminal to the chassis. If the interference continues, the rt. unit is defective. If the interference disappears, enemy jamming may be present. The jamming signals are typed as continuous wave or modulated. These signals may be intended to block a single frequency (this is called spot jamming), or the enemy may use one or several transmitters to jam or block a band of frequencies (barrage jamming).

**2-7. Antenna Assembly**

Antennas are not supplied with the radio set; however, any straight-wire antenna, 9 feet or longer, can be used. A dipole antenna and a 16foot whip antenna are intended for use with the radio set. Greatest range is provided by the dipole antenna; however, directivity, resonance (operationally limited to one frequency), and erection time usually limit this antenna to specific fixed station functions.

a. *Dipole Antenna.* A dipole antenna is usually erected between two supports as shown in A, figure 2-4. Because of terrain or the availability of only one support, the one-support dipole antenna (inverted V), shown in B, figure 2-4, can be used. Assemble and erect the dipole antenna as follows:

**NOTE**

**Dipole antennas should be erected perpendicular to the direction of communication and connected directly to the rt. unit ANTENNA connector.**

(1) Attach each antenna wire to the dipole fixture.

**CAUTION**

**Damage to the rt unit will result if operation is tried on a frequency other than the resonant frequency of the dipole. If operating frequency is changed, adjust the length of the dipole as described in (2) below.**

(2) Determine the length of each leg from the appropriate formula for the operating frequency of the rt unit.

(a) For the two support (horizontal) dipole:

$$\text{Length of each wire (feet)} = \frac{.234}{\text{frequency (MHz)}}$$

$$\text{Length of each wire (meters)} = \frac{71.3}{\text{frequency (MHz)}}$$

(b) For the inverted V-dipole antenna:

$$\text{Length of each wire (feet)} = \frac{245}{\text{frequency (MHz)}}$$

$$\text{Length of each wire (meters)} = \frac{74.5}{\text{frequency (MHz)}}$$

(3) Connect the dipole antenna lead-in to the rt. unit ANTENNA connector.

(4) Erect the antenna between the supports as follows:

(a) The two-support (horizontal) dipole antenna will be approximately 20 feet, or 6 meters, in height.

(b) The inverted V-dipole antenna connections at end poles should be a minimum of 6 feet, or approximately 1.9 meter, from the ground. The center pole should be one-third of the total length of the antenna wire. Route the lead-in down the pole.

**NOTE**

**Operator and organizational maintenance personnel should be familiar with the requirements of TB SIG 291 before attempting installation and operation of the eqiptnent with a whip antenna.**

b. *Antenna AS-2203/GRC-165 (16-Foot Whip Antenna)* (fig. 2-5). This antenna consists of four 4-foot sections with a support base.

(1) Attach Base, Antenna Support AB-1082/GRC-165 (antenna support), through a 1 13/16-inch hole and secure it with the nut supplied.

(2) Assemble the four antenna sections by screwing them end to end; then screw the whip antenna assembly into the antenna support threads.

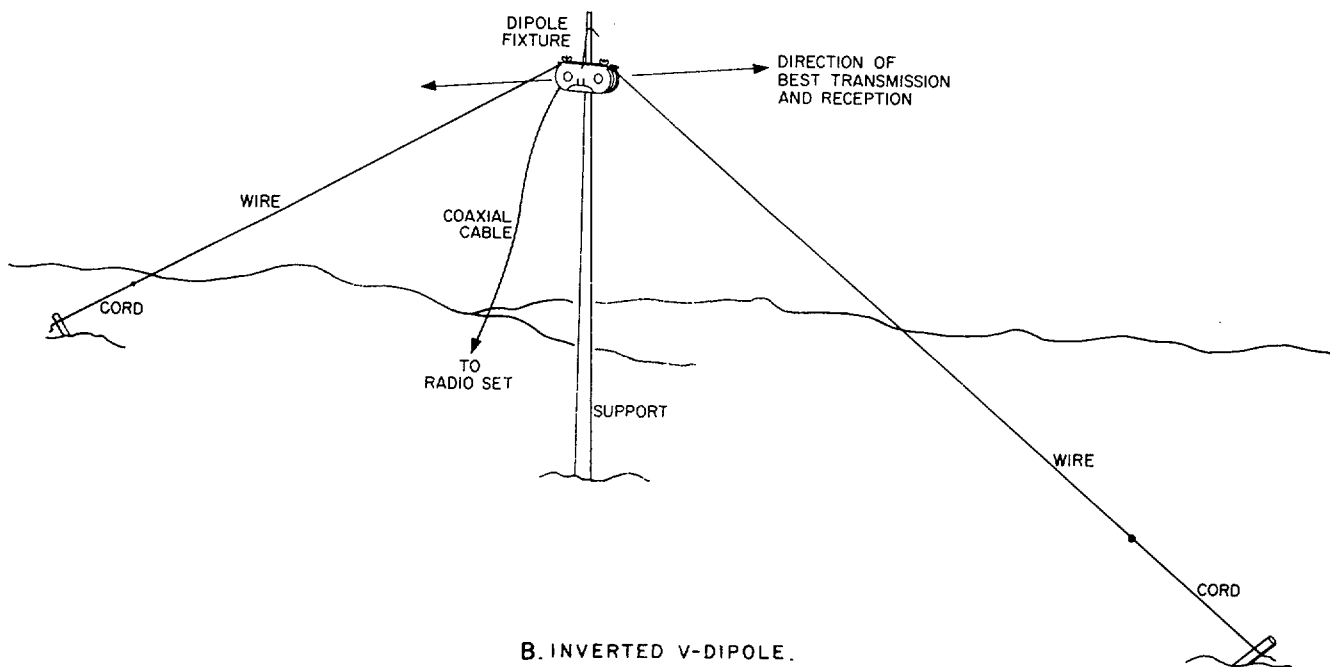
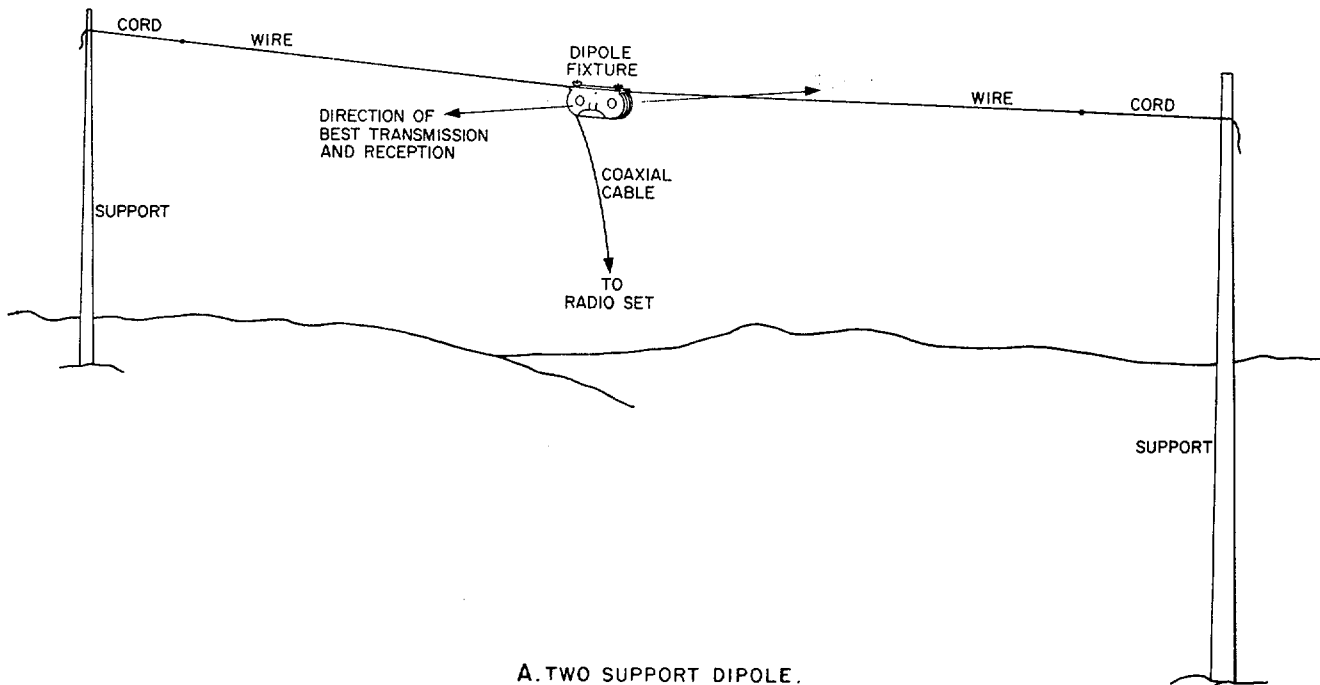

TM5820-759-12-7

Figure 2-4. Typical dipole antenna installation



(3) Connect the antenna lead-in wire to the brass terminal on the antenna support (fig. 2-2).

Use a soldered terminal: be careful to remove all flux with trichloroethane.

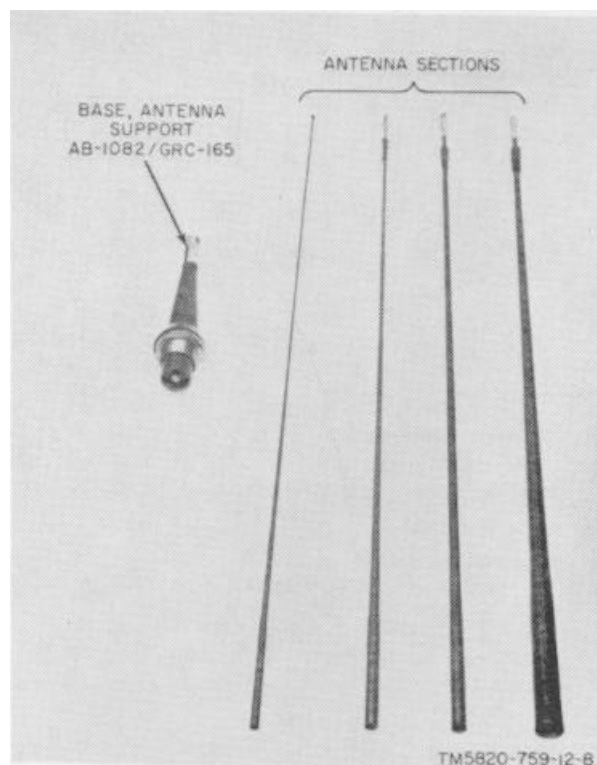

Figure 2-5. Antenna AS-2203/GRC-165.

CHAPTER 3

OPERATING INSTRUCTIONS

Section I. OPERATOR CONTROLS, INDICATORS, AND CONNECTORS

**3-1. General**

This section describes the function of each control, indicator, and connector of the radio set and the remote control. Haphazard operation and improper setting of controls can result in poor operation and possible damage to the equipment. Become familiar with the function of each control before operating the equipment. To prevent damage to the radio set, observe the following precautions:

a. Check to see that switch S1 (at the rear panel of the rt unit) is set at the position corresponding to the voltage of the primary power source being used before primary power is applied.

b. During preliminary tuning, rotate the rt. unit TRANSMIT AUDIO control fully clockwise to TUNE. This action automatically limits the rt. unit power output to 25 watts to prevent damage to the rt. unit and the antenna coupler during tuning.

**3-2. Rt. Unit Controls, Indicators, and Connectors**

The rt. unit operating controls, indicators, and connectors and their function are listed in *a* and *b* below.

a. *RT Unit Front Panel Switches, Controls, Indicators, and Connectors* (fig. 3-1).

-

<i>Control, indicator, or connector</i>	<i>Function</i>														
HANDSET connector.....	Used for local handset, microphone, or hand key connections to rt. unit.														
FREQUENCY KILOCYCLES controls (4).	Select operation frequency in kHz: 1,000, 100-, 10-, and 1-kHz increments. The 1-kHz knob is pulled out for vernier tuning between channels.														
FUNCTION switch.....	<table border="0"> <tr> <td style="text-align: right;"><i>Switch position</i></td> <td style="text-align: left;"><i>Equipment response</i></td> </tr> <tr> <td>OFF -----</td> <td>Disconnects primary power.</td> </tr> <tr> <td>STBY -----</td> <td>Applies power to circuits requiring warm-up before operation.</td> </tr> <tr> <td>USB -----</td> <td> <ul style="list-style-type: none"> <li>a. Applies primary power</li> <li>b. Selects upper sideband.</li> <li>c. Receive and transmit switching are controlled by microphone or handset push-to-talk switch.</li> </ul> </td> </tr> <tr> <td>LSB -----</td> <td> <ul style="list-style-type: none"> <li>a. Applies primary power.</li> <li>b. Selects lower sideband.</li> <li>c. Receive and transmit switching are controlled by microphone or handset push-to-talk switch.</li> </ul> </td> </tr> <tr> <td>AM -----</td> <td> <ul style="list-style-type: none"> <li>a. Applies primary power.</li> <li>b. Selects amplitude modulation.</li> <li>c. Receive and transmit switching are controlled by microphone or handset push-to-talk switch.</li> </ul> </td> </tr> <tr> <td>CW -----</td> <td> <ul style="list-style-type: none"> <li>a. Applies primary power.</li> <li>b. Selects continuous wave operation.</li> <li>c. Transmitter is switched and held on for 1 second by closing hand key, after which it automatically returns to receive if hand key is released.</li> </ul> </td> </tr> </table>	<i>Switch position</i>	<i>Equipment response</i>	OFF -----	Disconnects primary power.	STBY -----	Applies power to circuits requiring warm-up before operation.	USB -----	<ul style="list-style-type: none"> <li>a. Applies primary power</li> <li>b. Selects upper sideband.</li> <li>c. Receive and transmit switching are controlled by microphone or handset push-to-talk switch.</li> </ul>	LSB -----	<ul style="list-style-type: none"> <li>a. Applies primary power.</li> <li>b. Selects lower sideband.</li> <li>c. Receive and transmit switching are controlled by microphone or handset push-to-talk switch.</li> </ul>	AM -----	<ul style="list-style-type: none"> <li>a. Applies primary power.</li> <li>b. Selects amplitude modulation.</li> <li>c. Receive and transmit switching are controlled by microphone or handset push-to-talk switch.</li> </ul>	CW -----	<ul style="list-style-type: none"> <li>a. Applies primary power.</li> <li>b. Selects continuous wave operation.</li> <li>c. Transmitter is switched and held on for 1 second by closing hand key, after which it automatically returns to receive if hand key is released.</li> </ul>
<i>Switch position</i>	<i>Equipment response</i>														
OFF -----	Disconnects primary power.														
STBY -----	Applies power to circuits requiring warm-up before operation.														
USB -----	<ul style="list-style-type: none"> <li>a. Applies primary power</li> <li>b. Selects upper sideband.</li> <li>c. Receive and transmit switching are controlled by microphone or handset push-to-talk switch.</li> </ul>														
LSB -----	<ul style="list-style-type: none"> <li>a. Applies primary power.</li> <li>b. Selects lower sideband.</li> <li>c. Receive and transmit switching are controlled by microphone or handset push-to-talk switch.</li> </ul>														
AM -----	<ul style="list-style-type: none"> <li>a. Applies primary power.</li> <li>b. Selects amplitude modulation.</li> <li>c. Receive and transmit switching are controlled by microphone or handset push-to-talk switch.</li> </ul>														
CW -----	<ul style="list-style-type: none"> <li>a. Applies primary power.</li> <li>b. Selects continuous wave operation.</li> <li>c. Transmitter is switched and held on for 1 second by closing hand key, after which it automatically returns to receive if hand key is released.</li> </ul>														
RF GAIN control -----	Adjusts receiver sensitivity.														
NOISE LIMITED switch -----	Switches noise limited circuitry on and off.														
SPEAKER SWITCH -----	Switches speaker on and off.														
PRESELECTOR control -----	Adjusts tuning of RF amplifier.														
PA TUNE control -----	Adjusts tuning of power amplifier.														
HEADPHONE connector -----	Allows monitoring of audio signals with headphones.														

Control, indicator, or connector	Function	
	Mode	Action
Meter.....	Transmit-----	Indicates transmitter power output.
	Receive -----	Indicates received signal strength.
KEYLINE switch.....	Switch position	Equipment response
	LOCAL -----	Permits local keying at HANDSET connector only.
	LOCAL/REMOTE-----	Allows remote keying (at REMOTE connector) in addition to local keying.
Speaker.....		For monitoring audio signals locally.
RECEIVE AUDIO control.....		Adjusts local received audio level.
TRANSMIT AUDIO control.....		Adjusts transmitter drive level.

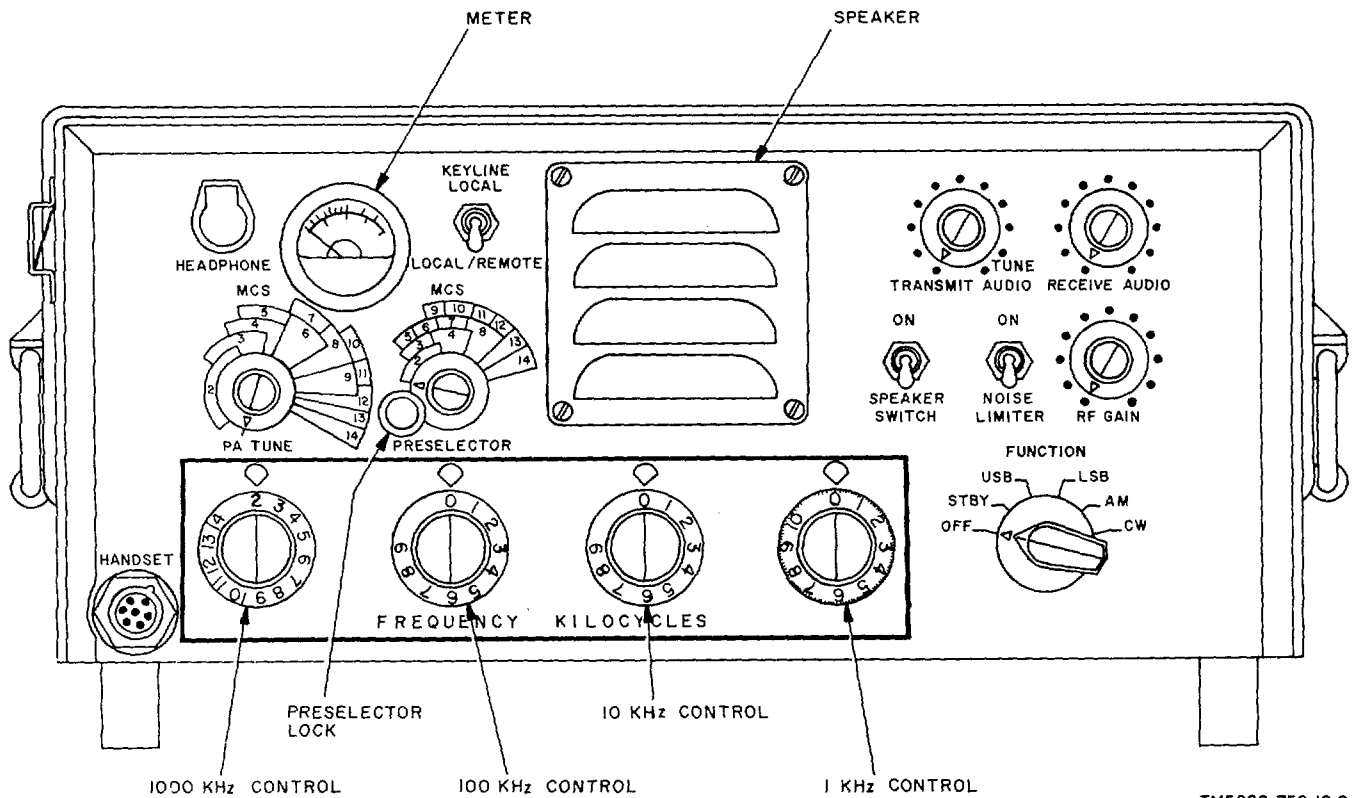
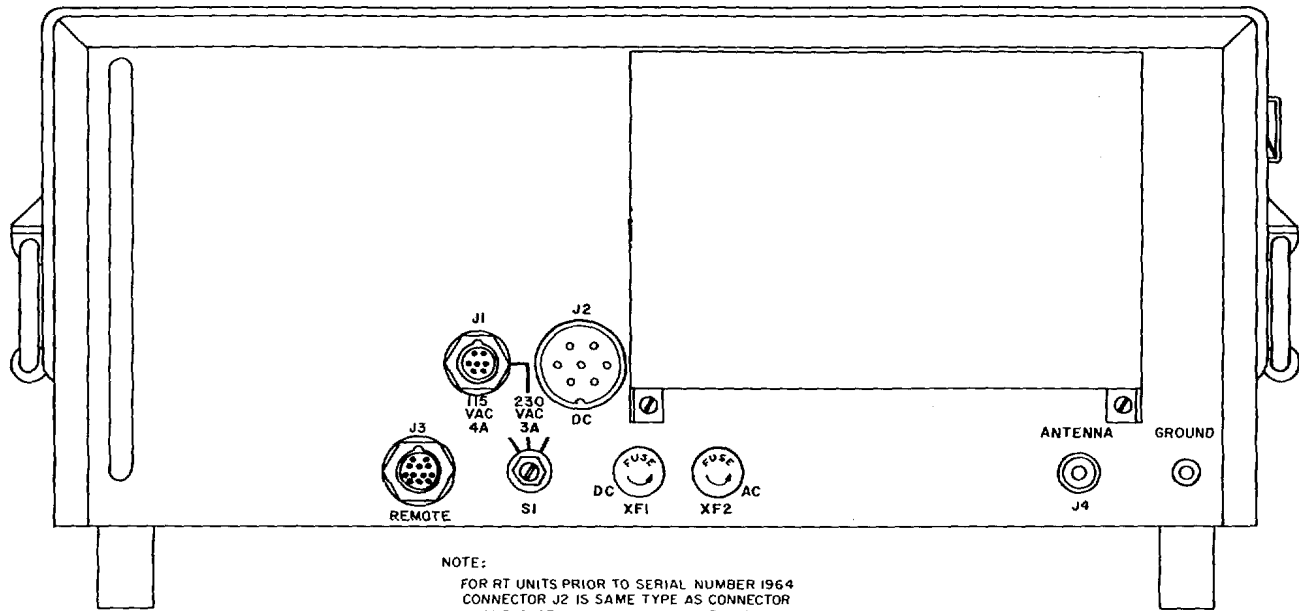

Figure 3-1. Receiver-Transmitter, Radio RT-902/GRC-165 front panel.



EL4TC005

Figure 3-2. Receiver-Transmitter, Radio RT-902/GRC-M5, rear panel

b. Rt. Unit Rear Panel Switch, Indicators, and Connectors (fig. 3-2).

Control, or connector	Function								
REMOTE connector J3.....	Connector for remote cable.								
Power selector switch S1.....	Permits operation on either ac or dc primary power by selecting proper power connector and internal circuitry.								
	<table border="0"> <tr> <td style="text-align: center;"><i>Switch position</i></td> <td style="text-align: center;"><i>Action</i></td> </tr> <tr> <td>115 VAC 4A - .....</td> <td>Permits operation with 115-volt ac power at J1.</td> </tr> <tr> <td>230 VAC 3A .....</td> <td>Permits operation with 230-volt ac power at J1.</td> </tr> <tr> <td>DC .....</td> <td>Permits operation with 13.5- or 27.5-volt dc power at J2. Depending on which dc chopper is installed in rt unit.</td> </tr> </table>	<i>Switch position</i>	<i>Action</i>	115 VAC 4A - .....	Permits operation with 115-volt ac power at J1.	230 VAC 3A .....	Permits operation with 230-volt ac power at J1.	DC .....	Permits operation with 13.5- or 27.5-volt dc power at J2. Depending on which dc chopper is installed in rt unit.
<i>Switch position</i>	<i>Action</i>								
115 VAC 4A - .....	Permits operation with 115-volt ac power at J1.								
230 VAC 3A .....	Permits operation with 230-volt ac power at J1.								
DC .....	Permits operation with 13.5- or 27.5-volt dc power at J2. Depending on which dc chopper is installed in rt unit.								
DC fuse XF1 .....	Dc primary power fuse: 25 amperes (type AGC) for 13.5-volt dc operation, 15 amperes (type AGC) for 27.5-volt dc operation. I								
AC fuse XF2.....	Ac primary power fuse: 4 amperes (type AGC after unit serial number 5139) for 115 volts ac, U 3 amperes (type AGC) for 230 volts ac.								
ANTENNA connector J4.....	Connector for long wire antenna, dipole antenna, or antenna coupler.								
GROUND connector.....	External ground terminal.								
DC connector J2 .....	Dc primary power connector.								
{ 115 VAC/230 VAC connector 11.....	Ac primary power connector.								

**33. Antenna Coupler Switches, Controls Indicators, and Connectors**

connectors of the antenna coupler and their function are listed below.

The operating switches, controls, indicators, and

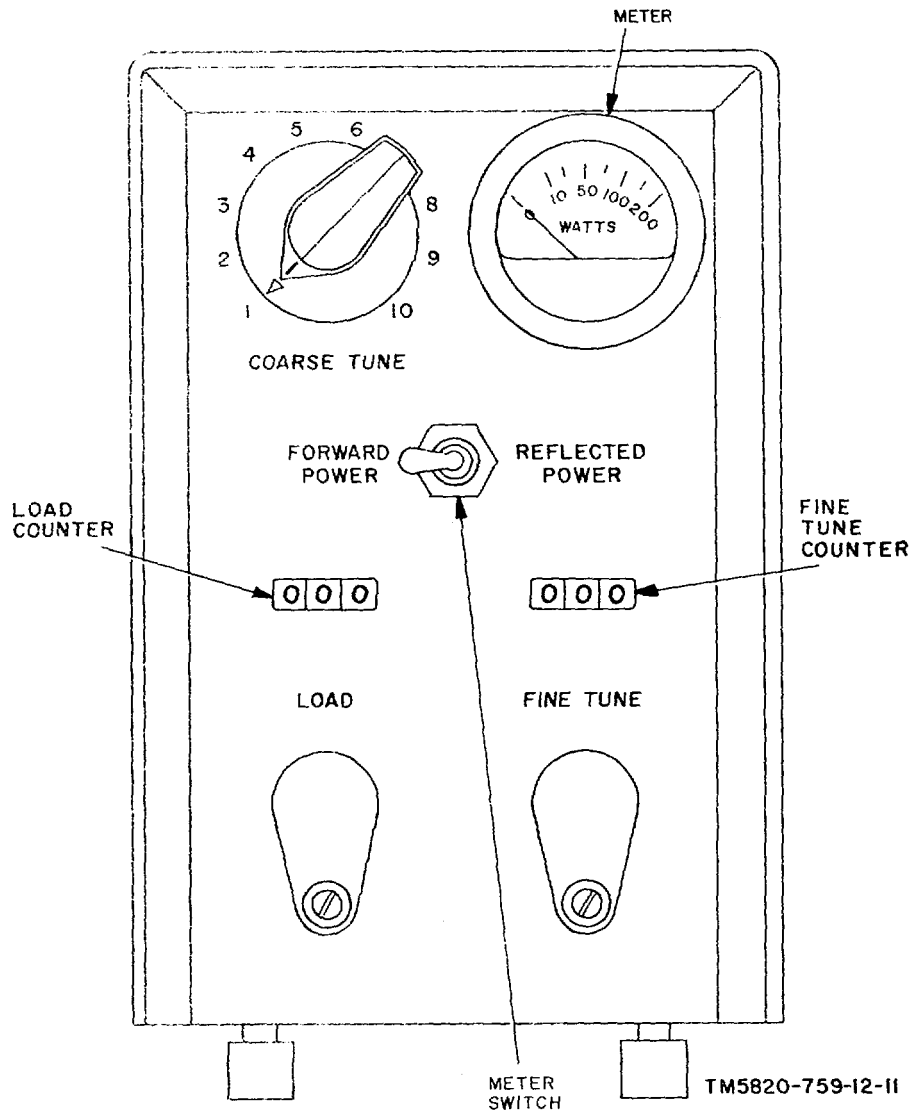

Figure 3-3. Coupler, Antenna CU-1782/GRC-165, front panel

a. Antenna , Coupler Front Panel Switches, Controls, and indicators (fig. 3-3).

Control, indicator, or connector	Function
COURSE TUNE switch.....	Selects a fixed element in matching network.
LOAD control.....	Vernier control for tuning to resonance in matching network.
Load counter.....	Digital readout of LOAD control position.
FINE TUNE control .....	Adjusts matching network to minimize reflected power.
Fine tune counter.....	Digital readout of FINE TUNE control position.
Meter switch .....	Selects meter to indicate forward or reflected power.
Meter.....	Indicates range of forward and reflected power.

b. Antenna coupler rear Panel Connectors (fig. 3-4).

Connectors	Function
INPUT connector .....	Connects rt unit RF cable to antenna coupler.
ANT connector.....	Connects antenna lead-in to antenna coupler.
GROUND connector.....	Connects external ground to antenna coupler.

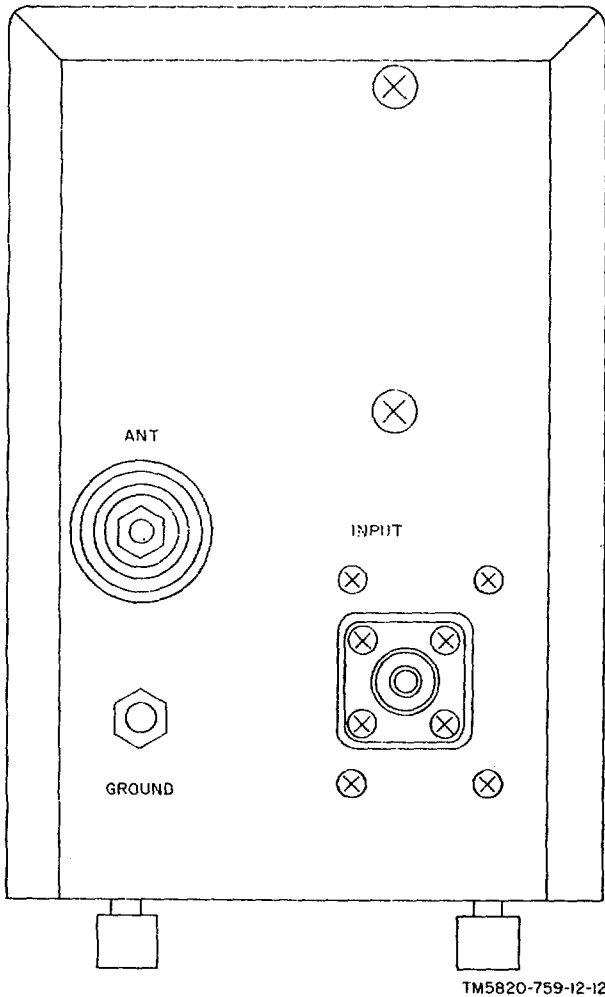

Figure 3-4. Coupler, Antenna CU-17821/ GRC-165, rear panel.

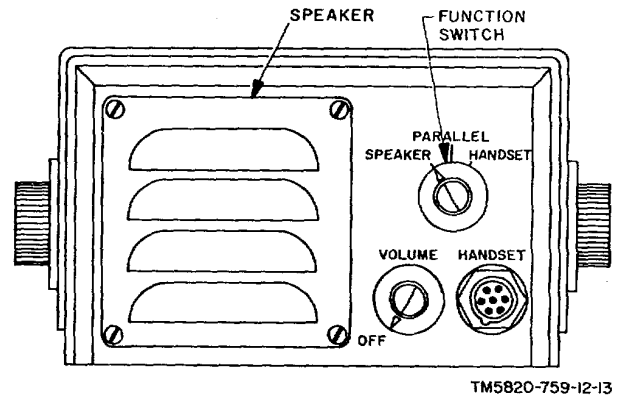

Figure 3-5. Control Radio Set C-7648/ GRC-1i5, front panel.

3-4. Remote Control Switch, Control, Speaker, and Connectors

(fig. 3-5)

The switches, control, speaker, and connectors of the remote control and their function are listed below.

**NOTE**

The connector for the remote cable is located at the rear of the remote control and is not shown in figure 3-5.

Controls, and connectors	Function								
VOLUME control and OFF switch.....	Switches remote control primary power and key line, and controls audio amplifier gain. In OFF position, primary power is switched off and rt unit key line is open.								
HANDSET connector .....	Provides remote handset, microphone, or hand key connections.								
Function switch - .....	<table border="0"> <tr> <td><i>Switch position</i></td> <td><i>Equipment response</i></td> </tr> <tr> <td>SPEAKER -----</td> <td>Allows audio output from rt unit to speaker only.</td> </tr> <tr> <td>HANDSET -----</td> <td>Allows audio output from rt unit to handset only.</td> </tr> <tr> <td>PARALLEL -----</td> <td>Allows audio output from rt unit to both speaker and handset.</td> </tr> </table>	<i>Switch position</i>	<i>Equipment response</i>	SPEAKER -----	Allows audio output from rt unit to speaker only.	HANDSET -----	Allows audio output from rt unit to handset only.	PARALLEL -----	Allows audio output from rt unit to both speaker and handset.
<i>Switch position</i>	<i>Equipment response</i>								
SPEAKER -----	Allows audio output from rt unit to speaker only.								
HANDSET -----	Allows audio output from rt unit to handset only.								
PARALLEL -----	Allows audio output from rt unit to both speaker and handset.								
Speaker .....	For monitoring audio output of rt unit.								
J2 connector (located at rear panel   (not shown)).	Provides connection to remote cable for connecting rt unit to remote control.								

## Section II. OPERATION UNDER USUAL CONDITIONS

### 3-5. Types of Operation

a. The radio set may be operated either locally or remotely using voice or cw modulation. The radio set is capable of transmitting and receiving in the following modes:

- (1) Single sideband, selectable upper (usb) or lower (lsb).
- (2) Amplitude modulation (AM).
- (3) Continuous wave (cew).

b. Procedures for operating the equipment are as follows:

- (1) Preliminary starting procedures (para 3-6).
- (2) Operating instructions (para 3-7).
- (3) Remote control operation (para 3-8).

### 3-6. Preliminary Starting Procedures

#### CAUTION

**Check to see that switch S1 at the rear of the rt unit (fig. 3-2) is set at the correct position for the primary power being used.**

a. Set the FUNCTION switch (fig. 3-1) at STBY. The radio set will stabilize in less than 20 minutes, but can be operated with decreased frequency stability and accuracy within 1 minute.

b. Rotate the TRANSMIT AUDIO control clockwise until it clicks into the TUNE detent.

c. Rotate the RECEIVE AUDIO control fully counterclockwise.

d. Set the SPEAKER SWITCH to the desired position. Tactical conditions may require silence; therefore, the use of a handset or headset would be necessary. Set the SPEAKER SWITCH to the off (down) position to silence the front panel speaker.

e. After warm-up, select the operating frequency with the FREQUENCY KILOCYCLES rotary switches. The frequency is selected from left to right, with the extreme left switch selecting the 1,000-kHz component of the operating frequency, the midleft switch selecting the 100-kHz digit, the midnight switch selecting the 10-kHz digit, and the extreme right switch selecting the 1-kHz digit.

#### WARNING

**Do not operate the radio set in the transmit mode without first connection antenna system. Injury to personnel and damage to equipment may result.**

#### NOTE

**Tuning with RF power will break radio silence.**

1. Rotate the FUNCTION switch to the desired mode of operation.

### 3-7. Operating Instructions

#### a. Receiver Tuning.

(1) If a handset, or a headset with microphone, is used, turn the SPEAKER SWITCH off. U

(2) Set the TRANSMIT AUDIO control fully clockwise to TUNE position.

(3) Set the RF GAIN control fully clockwise.

(4) Adjust the RECEIVE AUDIO for a comfortable listening level.

(5) Set the PRESELECTOR control substantially below the selected operating frequency band and tune clockwise for the first audible noise peak.

If a transmission by another station is being made on the operating frequency, tune clockwise for a peak meter indication. To avoid spurious signals, always tune the PRESELECTOR clockwise from below the operating frequency.

(6) During tuning, and when the received signal indicates an off frequency condition, pull out the extreme right-hand FREQUENCY KILOCYCLES switch knob and vernier tune as a (0 to 10 kHz) variable frequency oscillator. To return to digital frequency selection, rotate the knob while pushing it in toward the panel.

(7) The RF GAIN control normally remains in the fully clockwise position for maximum sensitivity. Reduce the gain when receiving very strong signals, and to reduce background noise, by tuning the control counterclockwise. To reduce background noise between speech syllables, adjust the RF GAIN control to produce approximately a one-half unit (meter indication) fluctuation during reception.

#### b. Transmitter Tuning.

#### CAUTION

**Correct antenna or load must be connected to the rt unit or antenna coupler before tuning or transmitting to prevent damage to parts in the transmitter.**

(1) Turn the TRANSMIT AUDIO control fully clockwise to TUNE; this action limits the transmitter power output to 25 watts.

(2) Preset the PA TUNE control to the operating frequency.

(3) Set the FUNCTION switch to CW.

(4) Plug the microphone or the handset into the HANDSET connector.

(5) Key the transmitter by pressing the microphone or handset push-to-talk switch.

(6) Adjust the PA TUNE control for a maximum indicated power output.

(7) If connected, set the antenna coupler tuning controls to typical settings (Table 3-1 or (a) below) and tune controls (fig. 3-3) as described in (b) through (e) below. Reflected power should be less than 5 percent of the forward power. Retune whenever antenna or operating frequency is changed. Record final settings for future use.

(a) Set controls initially as follows: (see Table 3-1 for whip antenna) COARSE TUNE to 1, FINE TUNE to 360, and LOAD to 900.

(b) Set the power meter switch to REFLECTED POWER.

(c) Key the rt unit transmitter.

(d) Rotate the LOAD control counterclockwise until the power meter displays a null indication. If a null indication is not obtained, return the LOAD control to 900 and advance the COARSE TUNE switch one position.

Repeat the LOAD control tuning procedure until a null is accomplished.

(e) When a null indication is obtained, adjust the LOAD and FINE TUNE controls alternately to minimize reflected power.

(8) Release the microphone switch or hand key. Turn the TRANSMIT AUDIO control fully counterclockwise. While pressing the microphone switch or cw hand key, advance the TRANSMIT AUDIO control until a 25-watt output is indicated on the rt unit meter; then, repeak the PRESELECTOR control for a maximum deflection on the rt unit meter and tighten the control lock.

(9) Advance the TRANSMIT AUDIO control until the power output begins to level off; then, advance the TRANSMIT AUDIO control one dial division further.

**NOTE**

**Do not rotate TRANSMIT AUDIO control beyond this setting, or distortion will result.**

(10) Peak the PA TUNE control for a maximum power output.

(11) Readjust the antenna coupler FINE TUNE and LOAD controls to minimize reflected power.

c. *Operating Procedures.* After receiver and transmitter tuning procedures have been completed,

select the desired mode of operation with the FUNCTION SWITCH. Operation of the radio set is the same in all modes. The rt. unit is always in receive until the transmitter is keyed. Keying is accomplished with the push-to-talk switch on the handset or microphone, or automatically when the cw hand key is closed. In the cw mode, the handset or microphone is unplugged and the hand key connected.

Table 3-1. Typical Control Settings for Antenna Coupler.

Freq. (MHz)	16-Ft Whip Antenna Settings		35-Ft Whip Antenna Settings		
	Coarse Tune	Fine Tune Load	Coarse Tune	Fine Tune	Load
2.0	7	360 290	6	338	103
2.5	6	364 229	5	339	177
3.0	5	363 169	1	339	067
3.5	5	375 336	1	348	278
4.0	5	382 449	1	348	420
4.5	1	374 336	1	347	525
5.1	1	374 447	1	325	621
5.5	1	376 503	1	325	663
6.0	1	386 557	1	335	717
6.5	1	394 603	1	338	775
7.0	1	395 643	2	296	800
7.5	1	395 677	2	292	798
8.0	1	396 707	2	133	857
8.5	1	396 735	4	234	560
9.0	1	396 763	6	254	753
9.5	1	394 792	6	345	795
10.1		1 392	828	6	371
819					
11	1	377 907	5	308	767
12	4	382 682	3	102	691
13	4	369 725	3	348	736
14	4	221 760	3	368	769
14.999	6	400 862	3	382	800

**3-8. Remote Control Operation**

Remote audio and keying functions are provided by the remote control. Operate the radio set remotely as follows:

- a. Tune and operate the radio set (paras 3-6 and 3-7)
- b. Set the rt unit KEYLINE switch to LOCAL/REMOTE.
- c. Connect the remote control to the rt unit through the interconnecting remote cable.
- d. Connect the handset or the microphone to the front panel HANDSET connector on the remote control.

**NOTE**

**If possible, both handsets or microphones connected to the rt unit and the remote control should be of the same type so that the rt unit TRANSMIT**



AUDIO control does not have to be readjusted when operation changes from local to remote.

e. Use the remote control function switch to select HANDSET, SPEAKER, or both (PARALLEL).

f. Adjust the remote control VOLUME control for a comfortable listening level. Audio and keying functions are now accomplished from both the radio set local and remote positions; however, remote keying is discontinued when the rt. unit KEYLINE switch is set to LOCAL, or when the remote control VOLUME control is set to OFF.

### 3-9. Stopping Procedure

The radio set can be placed in standby operation or completely shut down. If the radio set is shut down, the preliminary starting procedures (para 3-6), including warm-up, must be followed to operate the equipment.

a. To place the radio set in standby, rotate the rt. unit FUNCTION switch to STBY.

b. The radio set is shut down by setting the rt unit FUNCTION switch to OFF.

**Change 2 3-8**

CHAPTER 4

OPERATOR MAINTENANCE

**4-1. Scope of Operator Maintenance** The maintenance duties assigned to the operator of the radio set and the remote control are listed below.

- a. Daily preventive maintenance checks and services chart (para 4-3).
- b. Weekly preventive maintenance checks and services chart (para 4-4).
- c. Cleaning (para P5).
- d. Cleaning air filter (para 4-6).
- e. Troubleshooting and repair (para 4-7).

**4-2. Operator Preventive Maintenance**

Preventive maintenance is the systematic care, servicing, and inspection of equipment to prevent the occurrence of trouble, reduce downtime, and assure that the equipment is serviceable.

a. *Systematic Care.* The procedures given in paragraphs 4-3 through 4-6 cover routine systematic care and cleaning essential for proper operation and maintenance of the equipment.

b. *Preventive Maintenance Checks and Services.* The preventive maintenance checks and services charts (paras 4-3 and 4-4) outline functions to be

performed at specific intervals. These checks and services are to maintain Army electronic equipment in combat-serviceable condition; that is, in good operating condition. To assist the operator in maintaining combat serviceability, the chart indicates what to check, how to check, and the normal conditions; the *References* column lists the paragraphs that contain detailed repair or replacement procedures. Where no entry exists in the *References* column, the defect cannot be remedied by the operator; a higher category of maintenance or repair is required. Records and reports of these checks and services must be made in accordance with the requirements set forth in TM 38-750.

c. *Preventive Maintenance Checks and Services Periods.* Preventive maintenance checks and services of the radio set and the remote control are required daily and weekly. Paragraph 4-3 specifies checks and services that must be accomplished daily; paragraph 4-4 specifies checks and services that must be accomplished weekly, or under the special conditions listed in (1), (2), and (3) below:

- (1) When equipment is initially installed.
- (2) When equipment is reinstalled after removal for any reason.
- (3) At least once each week if equipment is maintained in standby condition.

**4-3. Operator daily Preventive Maintenance Checks and Services Chart**

Se- quence No.	Item to be inspected	Procedure	Reference
1	Completeness of radio set and remote control.	Check to see that equipment is complete.	Para 1-6
2	Exterior surfaces .....	Remove dust, dirt, fungus, moisture, and grease from connectors, controls, and equipment exterior surfaces.	Fig. 1-1 and para 4-5.
3	Intercabling and connectors.....  .....	Check all interconnecting cables and connectors for cracks, breaks, cuts, and wear. Report all defects to a higher maintenance category. <b>Caution:</b> Before operating the radio set make sure that an antenna, suitable for transmission, is connected. Check to see that the proper primary power is connected and power switch S1 is set to the correct position.	

**Change 4 4-1**

Se-quence No.	Item to be Inspected	Procedure	Reference
4	Controls .....	Check mechanical action of each control for freedom of external or internal binding during an operational check. Be alert for any unusual indication, and tap controls lightly for evidence of cutout (intermittance).	

**4-4. Operator Weekly Preventive Maintenance Checks and Service Chart**

Se-quence No.	Item to be inspected	Procedure	Reference
1	Mountings .....	Clean and tighten installation hardware and mounts.	Para 4-5.
2	Exterior surfaces.....	Inspect cases and exposed metal surfaces for rust or corrosion.	Para 4-5.
3	Air filter .....	Clean and inspect air filter on large mount.	Para 4-6.

**4-5. Cleaning**

Inspect the exteriors of the rt unit, the antenna coupler, and the remote control. The exterior surfaces should be free of dust, dirt, grease, moisture, fungus, rust, and corrosion.

a. Remove dust, moisture, and loose dirt with a clean, soft cloth.

**WARNING**

**The fumes of trichloroethane are toxic. Provide thorough ventilation whenever used. DO NOT use near an open flame. Trichloroethane is not flammable, but exposure of the fumes to an open flame converts the fumes to highly toxic dangerous gases.**

b. Remove grease, fungus, and ground-in dirt from the equipment covers; use a cloth dampened (but not wet) with Trichloroethane.

c. Remove dust or dirt from plugs and jacks with a brush.

**CAUTION**

**Do not press on the face glass of the meters when cleaning.**

d. Clean the front panels, meters, and control knobs; use a soft, clean cloth. If dirt is difficult to remove, dampen the cloth with water; mild soap may be used for more effective cleaning.

**4-6. Cleaning Air Filter**

a. Remove the filter tray from the base of the large mount.

b. Remove loose dirt by rapping the filter gently on a hard, smooth surface.

**WARNING**

**Compressed cause serious bodily harm. It can also cause mechanical damage to the equipment. Do not use compressed air to dry parts where trichloroethane has been used.**

c. Remove grease-and ground-in dirt by washing in warm water with a mild detergent. Blow dry with a clean air source.

**4-7. Operator Troubleshooting and Repair**

a. *General.* Troubleshooting and repair of the radio set and the remote control by the operator consists of substituting components and checking fuses and cables for proper connections. If a component or interconnecting cable is believed to be defective, substitute a known operational component or cable. If a fuse is believed defective and is to be replaced, follow the procedure in b below.

**CAUTION**

**Do not use fuses rated above the value specified. Damage to the equipment could result.**

b. *Replacement of Fuses.* The primary power fuses (XF1 and XF2) are on the rear panel of the rt. unit. To replace a fuse, turn the power off, and rotate the fuse holder cap approximately one quarter turn counterclockwise and remove it. Separate the blown fuse from the cap and insert a new fuse of the proper type into it. Place the fuse and fuse holder cap into the fuse holder; press and rotate clockwise until the cap is secured within the fuse holder. Power can now be turned on. air is dangerous and can

## CHAPTER 5

## ORGANIZATIONAL MAINTENANCE

## Section I. MAINTENANCE

**5-1. Scope of Organizational Maintenance**

a. This chapter contains instructions covering organizational maintenance of the radio set and the remote control. Included are instructions for preventive and periodic maintenance services and repair functions to be performed by the organizational repairman.

b. Organizational maintenance of the radio set and the remote control includes

- (1) Organizational preventive maintenance (paras 5-3, 5-4, and 5-5).
- (2) Lubrication (para 5-6).
- (3) Touchup painting (para 5-7).
- (4) Cable repair (para 5-8).
- (5) Troubleshooting (para 5-10).
- (6) Tests and adjustments (para 5-11).
- (7) Tube testing (para 5-12).

**5-2. Tools, Materials, and Test Equipment Required**

Tools required for organizational maintenance are contained in Tool kit, Electronic Equipment TK-101/G. The materials and test equipment are listed in *a* and *b* below.

*a. Materials.*

- (1) Cleaning compound, trichloroethane [one quart, Federal Stock Number 6810-292-9625.
- (2) Cleaning cloth.

*b. Test Equipment.*

- (1) Multimeter, AN/URM-105.
- (2) Test Set, Electron Tube, TV-7D/U.
- (3) Dummy Load, Electrical, DA-75/U.

**5-3. Organizational Preventive Maintenance**

a. Organizational preventive maintenance is the systematic care, inspection, and servicing of equipment to maintain it in serviceable condition, prevent breakdowns, and assure maximum operational capability. Preventive maintenance is the responsibility of all categories of maintenance concerned with the equipment, and includes the inspection, testing, and repair or replacement of parts, subassemblies, or units that inspection and tests indicate would probably fail before the next scheduled periodic service. The preventive maintenance checks and services for the radio set and the remote control are made at monthly intervals, unless otherwise directed by the commanding officer.

b. Maintenance forms and records to be used and maintained on this equipment are specified in TM 38-750.

**5-4. Monthly Maintenance**

Perform the maintenance functions indicated in the monthly preventive maintenance checks and services chart (para 5-5) once each month. A month is defined as 30 calendar days of 8-hour-per-day operation. If the equipment is operated 16 hours a day, the monthly preventive maintenance checks and services should be performed at 15-day intervals. Adjustment of the maintenance interval must be made to compensate for any unusual operating conditions. Equipment maintained in a standby (ready for immediate operation) condition must have monthly preventive maintenance checks and services performed on it. Equipment in limited storage (requires service before operation) does not require monthly maintenance.

**5-5. Organizational Monthly Preventive Maintenance Checks and Services Chart**

Se- quence No.	Item to be Inspected	Procedure	Reference
1	Exterior .....	Remove all accumulated rust and corrosion; repair and finish.	Para 5-7.
2	Intercabling and connectors.....	Check for cracks, breaks, cuts and wear; repair as required.	Para 5-8.
3	Antenna terminal.....	Check for good electrical and me- chanical connection. If necessary, remove corrosion and tighten.	
4	Hardware .....	Remove covers and inspect chassis. Tighten or replace loose and missing hardware and remove accumulated dirt. Inspect seating of pluckout items, tubes, fuses, relays, and connectors.	Para 5-11a.
5	Publications .....	Check to see that all publications are complete, serviceable, and current.	DA Pam 310-4.
6	Modifications.....	Check DA Pam 310-7 for applicable MWO's. All new URGENT MWO's must be applied immediately. All MORMAL MWO's must be scheduled.	TM 38-750 and DA Pam 310-7.
7	Deleted.		
8	Lubrication.....Lubricate equipment <sup>1</sup>	Para 5-6.	
9	Pa. Bias .....	Adjust pa. Bias	Para 5-11c.
10	Operational test.....	Perform tests given in paragraph 5-11 after completing starting and operating procedures.	Paras 3-6 through 3-8 and 5-11.

<sup>1</sup>To reach the lubrication point, refer to paragraph 5-11a

**5-6. Lubrication**

Lubricate the radio set during monthly preventive maintenance (para 5-5) at the locations shown in figures 5-1 through 5-4. Use grease, Aircraft (GAI) (FSN 9150-190-0883) for lubrication applications (do not overlubricate). During storage, lubrication is not necessary.

**WARNING**

**HIGH VOLTAGES exist in an operating radio set. Make sure that power to the radio set is turned off before lubricating the radio set.**

**CAUTION**

**Lubricate required items only. Do not lubricate nylon bushings, switches, reduction drives, and the 1A9 assembly capacitor gear train and chain.**

a. *Rt Unit* (figs. 5-1, 5-2 and 5-2.1) In the rt unit, remove the cover (para 5-11a) and the pa. Dust cover (para 5-11a). Lubricate the pa. variable inductor shaft

bearings and roller rod with a very light coating. Replace the pa. dust cover. Pull out the 1-kHz FREQUENCY KILOCYCLES control knob and *lightly* lubricate the exposed shaft. Replace the rt unit cover.

b. *Antenna Coupler* (figs. 5-4 and 5-4). In the antenna coupler, remove the cover (para 5-11a). Lubricate bearings indicated. Lightly lubricate the variable inductor roller rods, and the chain drive for L1 (fine tune inductor). Replace the antenna coupler cover.

**5-7. Touchup Painting**

Remove rust and corrosion from metal surfaces by lightly sanding them with fine sandpaper. Brush two thin coats of primer on the bare metal to protect it from further corrosion. Paint with a matching paint color and type. Refer to the applicable cleaning and refinishing practices specified in TB 746-10.

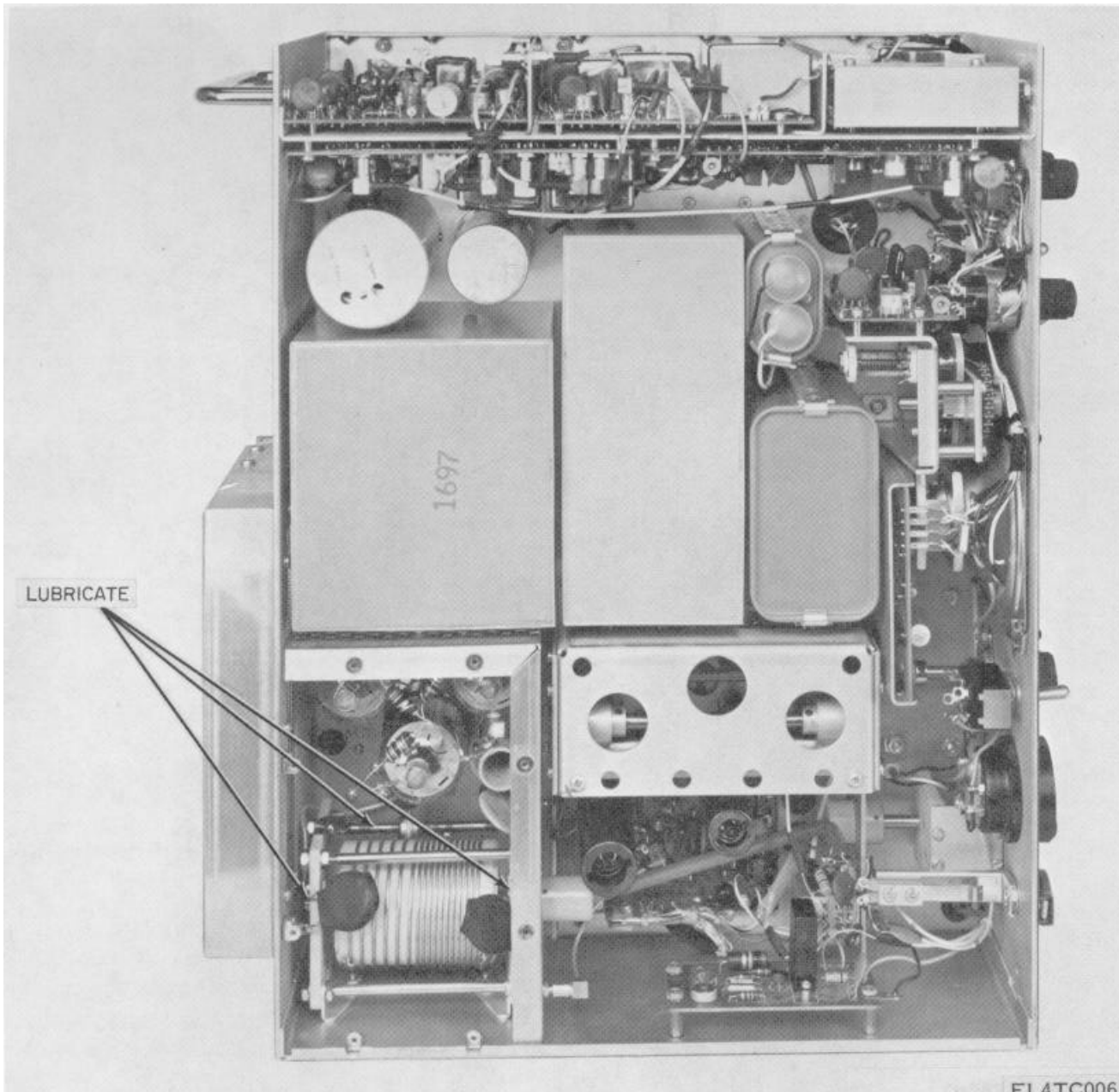

Figure 5-1. Rt unit, top view, location of lubrication points.

### 5-8. Cable Repair

Perform temporary repairs to all wires and cables associated with the radio set. Tape all cuts, kinks, strains, or frays with electrical tape. Repair breaks by splicing. Splicing is accomplished by stripping and soldering color coded wires together and wrapping each

connection with tape. To splice a coaxial cable, solder the inner conductors together and insulate by wrapping with tape. Next, connect the outer braids with a short piece of wire. Lightly solder the braid to the wire, while avoiding excess heat, with a high capacity (100 watt, or larger) iron. Tape the entire splice.

Change 4 5-3

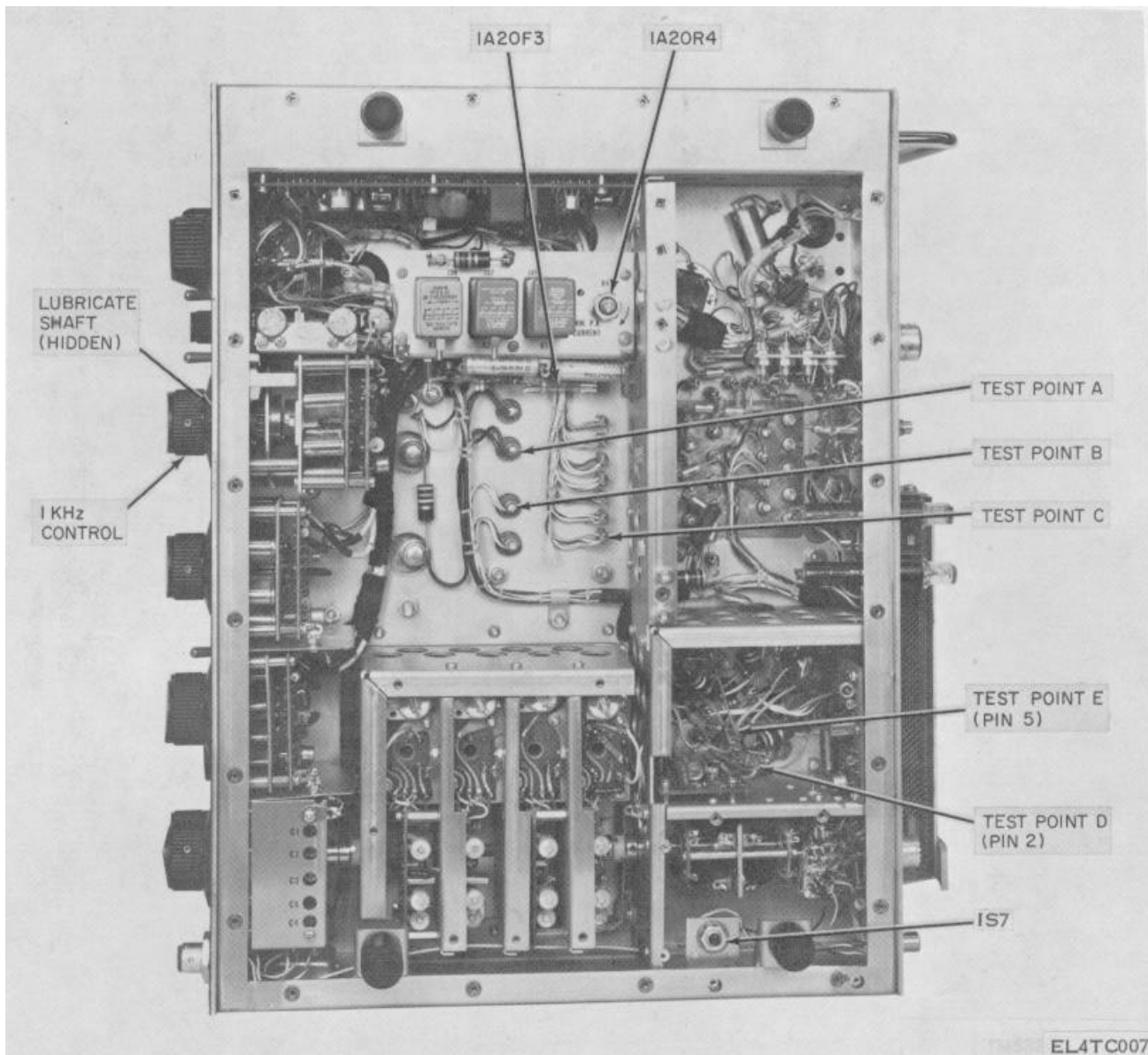

Figure 5-2 Rt unit, serial numbers prior to # 1964, bottom view, location of test and lubrication points.

Change 4 5-4

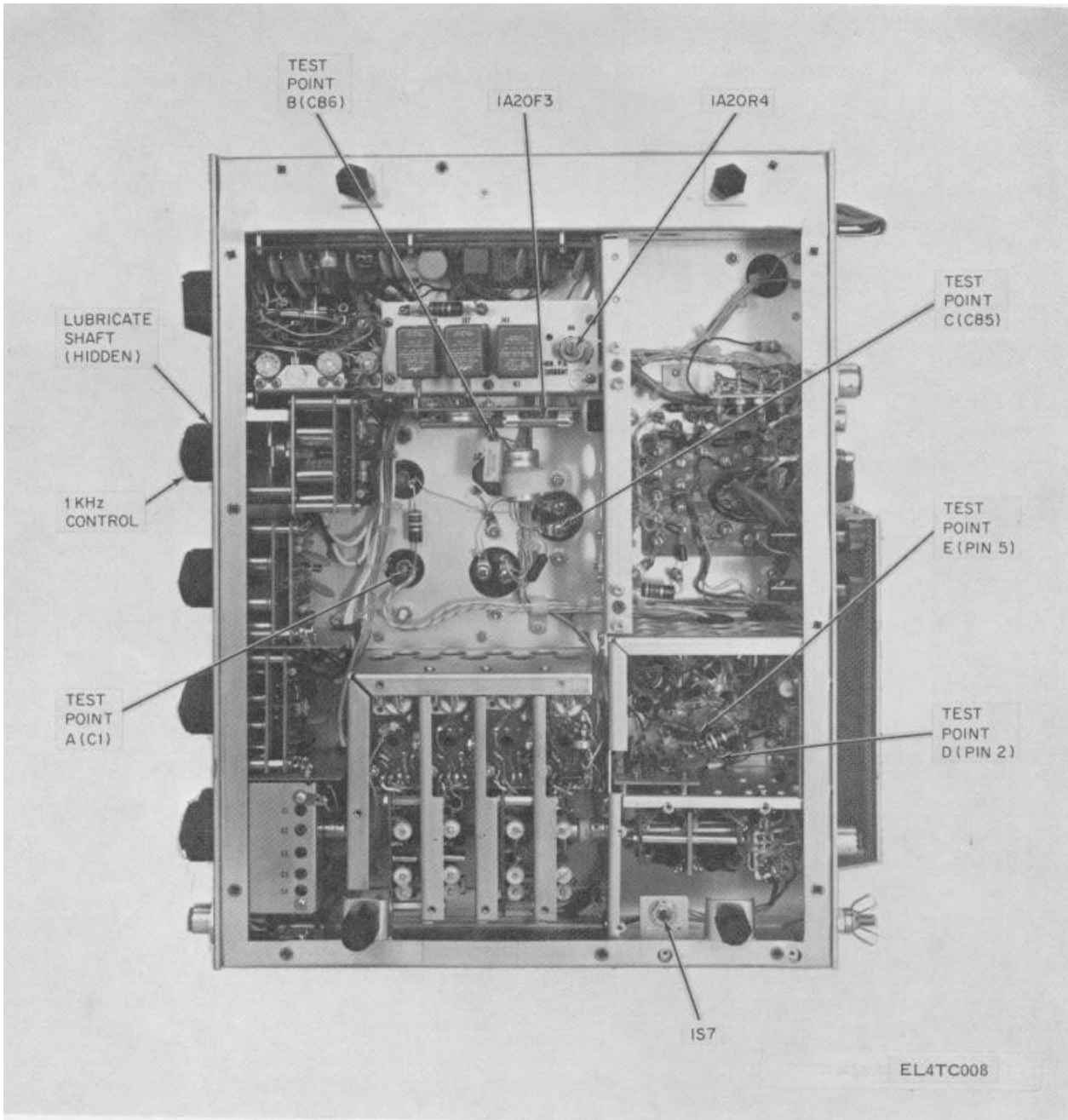

Figure 5-2..1 Rt unit, serial numbers 6407 through 6444, bottom view, location of test and lubrication points.

Change 4 5-4.1



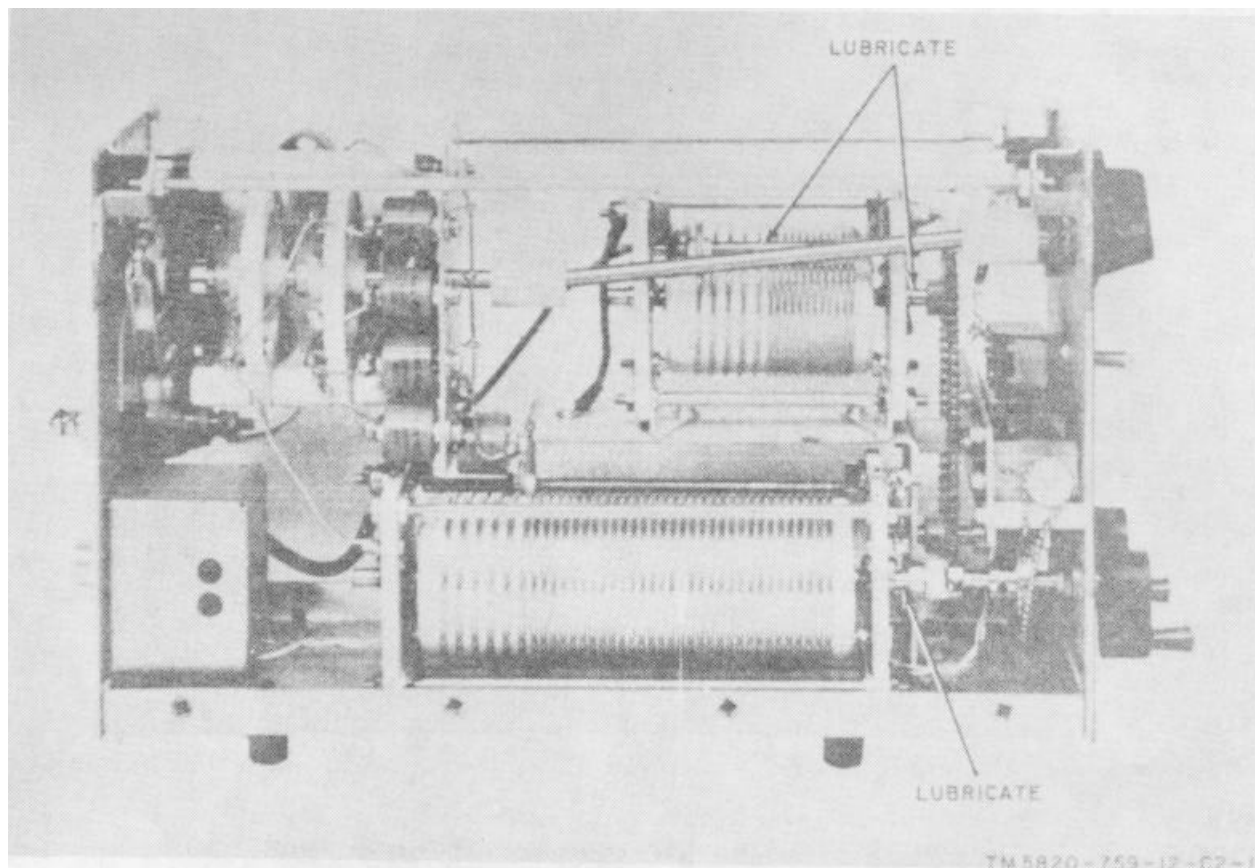

Figure 5-3. Antenna coupler, left side, location of lubrication points.

**Change 2 5-5**

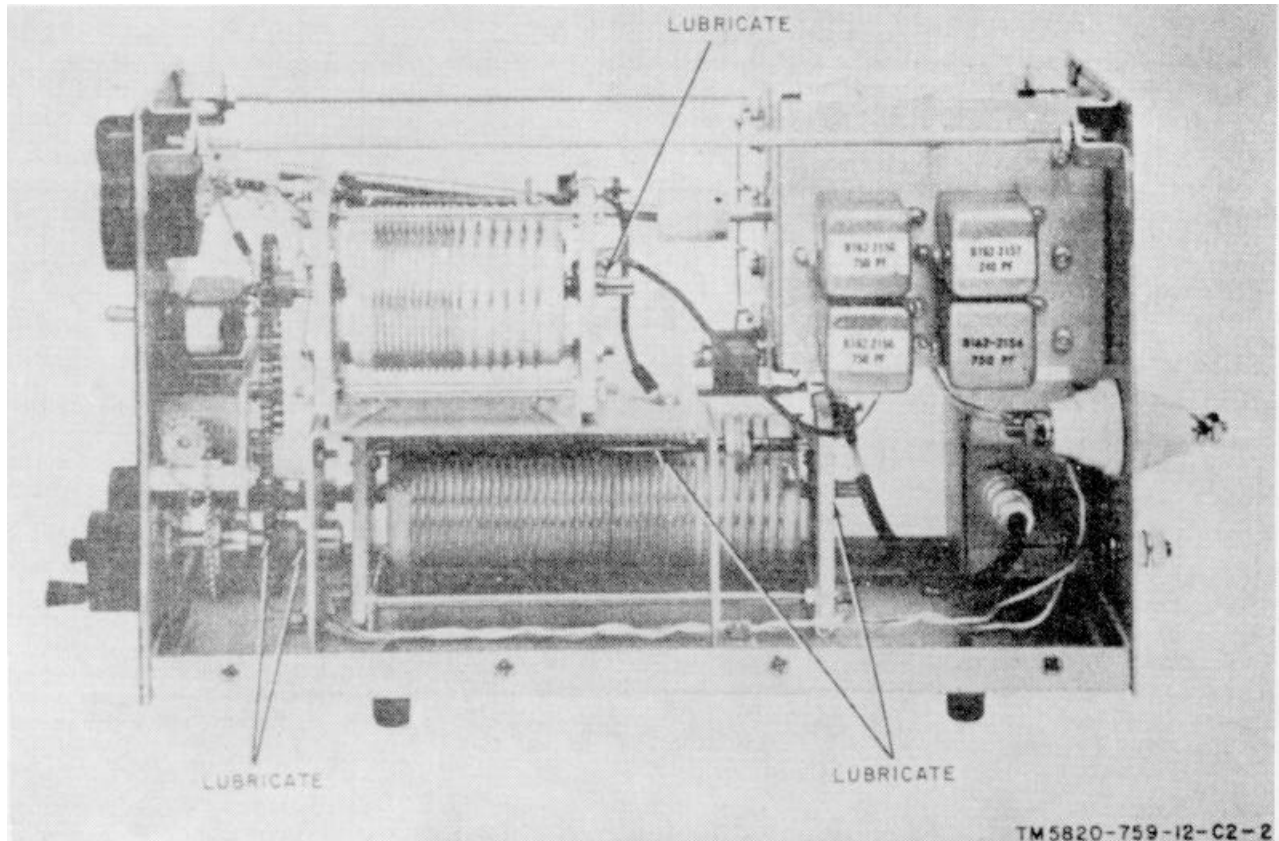

Figure 5-4. Antenna coupler, right side, location of lubrication points.

Section II. TROUBLESHOOTING

5-9. General

Troubleshooting the radio set and the remote control is based on the functional checks contained in the monthly preventive maintenance checks and services chart. To troubleshoot the equipment, perform the procedures given in paragraph 5-5. When an abnormal condition or result occurs, perform the checks and corrective measures given in the troubleshooting chart (para 5-10).

Paragraph 5-12 gives tube checking instructions. If the corrective measures do not correct the trouble, higher category of maintenance is required. To remove the cover and to perform the equipment tests and adjustments used during troubleshooting procedures, refer to the instructions given in paragraph 5-11.

5-10. Organizational troubleshooting chart

Item No	Trouble symptom	Probable trouble	Checks and corrective measures
1	Binding controls.....	Lack of lubrication.....	Lubricate unit (para 5-6). If trouble still exists, higher category of maintenance is required.
2	Rt unit tunes to spurious signals..... ..... .....	PRESELECTOR control requires..... adjustment.	Adjust PRESELECTOR control (para 5-11d). If trouble still exists, higher category of maintenance is required.
3	Transmitter distortion, or short..... power amplifier tube life.	Pa. bias requires adjustment.....	Adjust pa. bias (para 5-11c).

Change 2 5-6

Item No.	Trouble Symptom	Probable trouble	Checks and corrective measure
4	Transmitter has low power output, or is inoperative.	a. Pa. is defective..... b..... Defective rt unit	a. Replace defective tube. b. Replace rt unit. If trouble still exists, higher category of maintenance is required.
5	Transmitter has low power output; receiver lack's sensitivity.	a. Defective tube in RF amplifier ..... b. Defective rt unit .....	a. Replace defective tube. b. Replace rt unit; if trouble still exists, higher category of maintenance is required.
6	Receiver has low sensitivity, or is inoperative.	Defective rt. Unit .....	Replace rt. unit; if trouble still exists, higher category of maintenance is
7	Frequency is unstable, or incorrect....	Defective rt. unit .....	Replace rt. unit; if trouble still exists, higher category of maintenance is required.
8	Antenna coupler is inoperative.....	Antenna coupler is defective.....	Replace antenna coupler; if trouble still exists, higher category of maintenance is required.
9	Remote control is inoperative.....	a. Remote control is defective.....  b. Defective remote cable.....	a. Replace remote control; if trouble still exists, higher category of maintenance is required. b. Replace defective remote cable (para 5-8).
10	Rt unit inoperative. Meter lighted ..... and rear panel fuses check good.	Fuse 1A20F3 blown.....	Replace defective fuse (fig. 5-2, 5-2.1 and para 4-7)

**5-11. Test and Adjustments**

Perform a complete operational test (paras 3-6 and 3-7) and the pa. bias adjustment during the monthly preventive maintenance. While checking for malfunctions, operate the radio set in all modes. Compare the malfunction to the troubleshooting chart. With a fully operational radio set and remote control, conduct the tests given in b below. Removal of the necessary equipment covers is described in a below.

**WARNING**

**High voltages exist in the radio set. Make sure that the power source to the radio set is turned off before removing the covers. Operate the radio set without covers only to perform tests and adjustments (observe safety precautions).**

*a. Cover Removal.*

(1) To reach into the rt unit, remove the 12 screws that hold the cover, and lift it off. Remove the 20 screws (prior to serial number 1964) or 12 screws (serial numbers 6407 through 6444) that secure the edges of the bottom cover and separate it from the rt unit. Remove the eight retaining screws from the pa. dust cover and remove the cover.

(2) To reach into the antenna coupler, remove the eight screws that hold the cover and separate the cover from the unit.

**WARNING**

**HIGH VOLTAGES could cause DEATH ON CONTACT! Voltages up to 1,035 volts dc exist within the rt unit. Follow safe procedures when working near high voltages. Use a well-insulated test probe; hold fingers far back from exposed metal and, if available, wear insulated gloves.**

*b. Power Supply Voltage Measurements (fig. 5-2 and 5-2.1)*

Perform the voltage measurement given in the following chart using the AN/URM-105 Multimeter with power input voltages as close as possible to the nominal voltage requirements The input requirements are: 230 and 115 volts ac; and 13.5 and 27.5 volts dc +-10 percent. Where two values are given in the following steps, the first value applies to rt. unit serial numbers prior to #1964 and the value given in parenthesis applies to unit serial numbers #6407 through #6444. Refer to figure 5-2 for test point location in rt. units prior to #1964 and to figure 5-2.1 for locations in rt. Units # 6407 through #6444.

**WARNING**

**Do not make voltage readings between test point A and ground. Voltages above 1,000 volts could be present. This measurement should be performed by higher category of maintenance personnel.**

Step	Procedure	Acceptable limits
1	Set the rt. unit FUNCTION switch to USB position and unit in receive mode.	
2	Connect the voltmeter positive test probe to test point B and measure +225 (+235) volts dc.	192 to 258 Vdc (200 to 270 Vdc)
3	Connect the voltmeter positive test probe to test point C and measure +12 (+14.6) volts dc.	10.2 to 13.8 Vdc (12.4 to 16.8 Vdc)
4	Connect the voltmeter test probe to test point D and measure 6.3 volts ac.	5.36 to 7.24 Vac
5	Connect the voltmeter negative test probe to test point E and measure -55 volts dc.	-46.8 to - 63.3 Vdc

c. *Pa. Bias Adjustment.*

**NOTE**

**Adjust the pa. bias with the type (ac or de) and voltage of primary power from which the radio set will normally be operated; otherwise, incorrect adjustment may result. However, for test purposes the adjustment should first be made in the test setup.**

(1) Connect the dummy load to ANTENNA connector J4.

(2) Set the FUNCTION switch at either USB or LSD.

(3) Press and hold meter switch 1S7 (fig. 5-2)

(4) Do not speak into the microphone. Adjust pa. bias control 1A20R4 (fig. 5-2) for a meter indication of S9 on the front panel meter.

(5) Release the meter switch and remove the dummy load.

d. *Control Knobs and Control Adjustments.*

(1) Tighten all loose control knobs and make sure that the knobs do not rub against the panel.

2) The PRESELECTOR control adjustment is accomplished by tuning the transmitter for a maximum power output at 8.8 MHz. Tune up from the low frequency end of the PRESELECTOR control until the rt unit meter indicates maximum power; then, loosen the PRESELECTOR control indicator ring set screw. Set the indicator ring to 8.8 MHz and tighten the setscrew.

(3) Adjust the PA TUNE control by rotating it fully counterclockwise. Loosen both setscrews in the indicating ring under the control knob. Position the pointer to the reference mark on the front panel (a line

slightly counterclockwise for the 2 MHz position) and tighten setscrews.

e. *Tightening and Replacement of Hardware.*

(1) Check the exterior of the equipment for loose or missing screws and nuts; replace and tighten where necessary.

(2) Check the security of the equipment to the shock mount.

**5-12. Tube Testing**

When trouble occurs, a tube can be at fault. If tube failure is suspected, remove and check the tube.

**CAUTION**

**Do not rock or try to rotate a tube when removing it from a socket; pull it straight out. Rocking or attempting to rotate a tube can damage the tube socket and tube pins and result in complete failure or intermittent operation of the tube.**

a. *Use of Tube Tester.* Remove and test one tube at a time. Discard a tube only if its defect is obvious, or if the tube tester shows it to be defective. Do not discard a tube that tests at, or near, its minimum test limit on the tube tester. Put back the original tube, or insert a new one if required before testing the next tube.

b. *Tube Substitution Method.* Replace a suspected tube with a known good tube. If the equipment remains inoperative, remove the replacement tube and put back the original tube. Repeat the procedure with each suspected tube until the defective tube is located, or it is determined that faulty operation is not caused by any of the tubes.

CHAPTER 6

SHIPMENT, LIMITED STORAGE, AND DEMOLITION TO PREVENT ENEMY USE

Section I. SHIPMENT AND LIMITED STORAGE

**6-1. Disassembly of Equipment**

The following instructions are recommended as a guide for preparing the radio set for shipment and storage.

- a. Disassemble and remove the antenna and the antenna mounting bracket.
- b. Remove all necessary equipment (headset, microphone, etc.).
- c. Gather technical manuals and running spares.
- d. Disconnect and coil cables.
- e. Remove the rt unit, the antenna coupler, and the remote control (if used).
- f. Remove the shockmount (if used).

**6-2. Repacking for Shipment or Limited Storage**

The specific procedure for repackaging depends on the material available and the conditions under which the equipment will be shipped or stored. Adapt the following procedures whenever circumstances permit.

a. *Material Requirements.* Listed below are the materials required for packaging the radio set. For Federal stock numbers of materials, refer to SB 38-100.

<i>Material</i>	<i>Quantity</i>
Moisture-vaporproof barrier.....	23 sq. ft.
Waterproof tape.....	32 ft.
Fiberboard .....	28 sq. ft.
Filler material .....	5 lb.

b. *Packaging.*

(1) Package technical manuals and spare parts in a close-fitting waterproof bag. Seal it with the tape.

(2) For the radio set, use fiberboard and tape to construct a box 34 1/2 inches long by 22 1/2 inches high by 17 1/4 inches wide, or reuse the shipping container.

(3) For the antenna, use fiberboard and tape to construct a box 50 inches long by 8 inches high by 8 inches wide, or reuse the shipping container.

(4) Place the radio set in the fiberboard box and cushion all sides with pads of filler material.

(5) Insert items from (1) above into the box on top of the radio set. Seal the box.

(6) Place the antenna and the mounting base into the box and secure it at both ends with filler material. Seal the box.

(7) Cover both boxes with a moistureproof barrier.

Section II. DEMOLITION TO PREVENT ENEMY USE

**6-3. Authority for Demolition**

Demolition of the equipment will be accomplished only upon the order of the commander. Use destruction procedures outlined in paragraph 6-4 to prevent further use of the equipment.

**6-4. Methods of Destruction**

Any of the following methods will destroy the equipment. The method used is primarily dependent on the time available, whereas the tactical sit-

uation determines the manner in which the destruction order will be followed.

a. *Smash.* Smash both sides of the rt unit, especially the corner near the power connector (where the frequency standard is housed), the midsection of the antenna coupler, coils, tubes, and meter; use sledges, axes, hammers, or crowbars.

b. *Cut.* Cut cables close to their connectors.

**WARNING**

**Be extremely careful with explosives and**

incendiary devices. Use these items only when the need is urgent.

c. *Burn.* Burn the technical manuals; use gasoline, kerosene, or a flame-thrower.

d. *Explode.* If explosives are necessary, use grenades, TNT, or firearms.

e. *Dispose.* Bury or scatter the destroyed parts in trenches or foxholes, or throw them into streams.

## APPENDIX A

## REFERENCES

---

DA Pam 310-4	Index of Technical Manuals, Technical Bulletins, Supply Manuals (types 7, 8 and 9), Supply Bulletins, and Lubrication Orders.
DA Pam 310-7	US Army Equipment Index of Modification Work Orders.
MWO 11-5820-759-30/1	Modification of Antenna Coupler CU-1782/GRC-165 to Prevent Equipment Damage.
SB 38-100	Preservation, Packaging, and Packing and Marking Materials, Supplies and Equipment Used by the Army.
TB SIG 291	Safety Measures to be Observed When Installing and Using Whip Antennas, Field Type Masts, Towers, Antennas and Metal Poles That are Used With Communication, Radar, and Direction Finder Equipment.
TB 43-0118	Field Instructions for Painting and Preserving Electronics Command Equipment Including Camouflage Pattern Painting of Electrical Equipment Shelters.
TM 11-5820-759-20P	Organizational Maintenance Repair Parts & Special Tools Lists for Radio Set AN/GRC-165 (NSN 5820-00-935-8038).
TM 11-6625-200-15	Operator's, Organizational, DS, GS, and Depot Maintenance Manual: Multimeters ME-26A/U, ME-26B/U, ME-26C/U, and ME-26D/U.
TM 11-6625-203-12	Operator and Organizational Maintenance: Multimeter AN/URM-105 and AN/URM-105C Including Multimeter ME-77/U and ME-77C/U.
TM 11-6625-274-12	Operator's and Organizational Maintenance Manual: Test Sets, Electron Tube TV-7/U, TV-7A/U, TV-7B/U, and TV-7D/U.
TM 11-6625-320-12	Operator's and Organizational Maintenance Manual: Voltmeter, Meter ME-30A/U and Voltmeters, Electronic ME-30B/U, ME-30C/U, and ME-30E/U.
TM 11-6625446-15	Operator's, Organizational, Direct Support, General Support, and Depot Maintenance Manual: Wattmeter AN/URM-120.
TM 38-750	The Army Maintenance Management System (TAMMS).

## APPENDIX C

## MAINTENANCE ALLOCATION

## Section I. INTRODUCTION

**C-1. General**

This appendix provides a summary of the maintenance operations for AN/GRC-165. It authorizes categories of maintenance for specific maintenance functions on repairable items and components and the tools and equipment required to perform each function. This appendix may be used as an aid in planning maintenance operations.

**C-2. Maintenance Function**

Maintenance functions will be limited to and defined as follows:

*a. Inspect.* To determine the serviceability of an item by comparing its physical, mechanical, and/or electrical characteristics with established standards through examination.

*b. Test.* To verify serviceability and to detect incipient failure by measuring the mechanical or electrical characteristics of an item and comparing those characteristics with prescribed standards.

*c. Service.* Operations required periodically to keep an item in proper operating condition, i.e., to clean, preserve, ,paint ,or to replenish fuel /lubricants/hydraulic fluids or compressed air supplies.

*d. Adjust.* Maintain within prescribed limits by bringing into proper or exact position, or by setting the operating characteristics to the specified parameters.

*e. Align.* To adjust specified variable elements of an item to about optimum or desired performance.

*f Calibrate.* To determine and cause corrections to be made or to be adjusted on instruments or test measuring and diagnostic equipment used in precision measurement. Consists of the comparison of two instruments, one of which is a certified standard of known accuracy, to detect and adjust any discrepancy in the accuracy of the instrument being compared.

*g. Install.* The act of emplacing, seating, or fixing into position an item, part, module (component or assembly) in a manner to allow the proper functioning of the equipment/system.

*h. Replace.* The act of substituting a serviceable like type part, subassembly, model (component or assembly) for an unserviceable counterpart.

*l Repair.* The application of maintenance services (inspect, test, service, adjust, align, calibrate, replace) or other maintenance actions (welding, grinding, riveting, straightening, facing, remachining, or resurfacing) to restore serviceability to an item by correcting specific damage, fault, malfunction, or failure in a part, subassembly, module/component/assembly, end item or system.

*j. Overhaul.* That periodic maintenance effort (service/action) necessary to restore an item to a completely serviceable/operational condition as prescribed by maintenance standards (e.g., DMWR) in appropriate technical publications.

Overhaul is normally the highest degree of maintenance performed by the Army. Overhaul does not normally return an item to like-new condition.

*k. Rebuild.* Consists of those services/actions necessary for the restoration of unserviceable equipment to a like-new condition in accordance with original manufacturing standards. Rebuild is the highest degree of materiel maintenance applied to Army equipment. The rebuild operation includes the act of returning to zero those age measurements (hours, miles, etc.) considered in classifying Army equipment/components.

**C-3. Column Entries**

*a. Column 1, Group Number.* Column 1 lists group numbers, the purpose of which is to identify components, assemblies, subassemblies and modules with the next higher assembly.

*b. Column 2, Component/Assembly.* Column 2 contains the noun names of components, assemblies, subassemblies, and modules for which maintenance is authorize



c. *Column 3, Maintenance Functions.* Column 3 lists the functions to be performed on the item listed in column 2. When items are listed without maintenance functions, it is solely for purpose of having the group numbers in the MAC and RPSTL coincide.

d. *Column 4, Maintenance Category.* Column 4 specifies, by the listing of a "worktime" figure in the appropriate subcolumn(s), the lowest level of maintenance authorized to perform the function listed in column 3. This figure represents the active time required to perform that maintenance function at the indicated category of maintenance. If the number or complexity of the tasks within the listed maintenance function vary at different maintenance categories, appropriate "worktime" figures will be shown for each category. The number of task-hours specified by the "worktime" figure represents the average time required to restore an item (assembly, subassembly, component, module, end item or system) to a serviceable condition under typical field operating conditions. This time includes preparation time, troubleshooting time and quality assurance/quality control time in addition to the time required to perform the specific tasks identified for the maintenance functions authorized in the maintenance allocation chart. Subcolumns of column 4 are as follows:

- C-Operator/Crew
- O--Organizational
- F--Direct Support
- H-General Support
- D-Depot

e. *Column 5, Tools and Equipment.* Column 5 specifies by code, those common tool sets (not individual tools) and special tools, test, and support equipment required to perform the designated function.

**C-4. Tool and Test Equipment Requirements (Table 1)**

a. *Tool or Test Equipment Reference Code.* The numbers in this column coincide with the numbers used in the tools and equipment column of the MAC. The numbers indicate the applicable tool or test equipment for the maintenance functions.

b. *Maintenance Category.* The codes in this column indicate the maintenance category allocated the tool or test equipment.

c. *Nomenclature.* This column lists the noun name and nomenclature of the tools and test equipment required to perform the maintenance functions.

d. *National/NATO Stock Number.* This column lists the National/NATO stock number of the specific tool or test equipment.

e. *Tool Number.* This column lists the manufacturer's part number of the tool followed by the Federal Supply Code for manufacturers (5digit) in parentheses

(1) Group Number	(2) Component/Assembly	(3) Maintenance Function	(4) Maintenance Level*					(5) Tools and Equipment
			C	O	F	H	D	
00	RADIO SET AN/GRC-165	Inspect <sup>1</sup> Inspect <sup>2</sup> Inspect <sup>3</sup> Test <sup>4</sup> Test <sup>5</sup> Test <sup>6</sup> Service <sup>7</sup> Service <sup>8</sup> Service <sup>9</sup> Adjust <sup>10</sup> Adjust <sup>11</sup> Adjust <sup>19</sup> Align <sup>12</sup> Install Repair <sup>13</sup> Repair <sup>14</sup> Repair <sup>15</sup> Repair <sup>16</sup> Overhaul Rebuild	0.1	0.2	0.3		2.0	1,3 6 thru 21 6 thru 66
01	Receiver Transmitter RT-902/GRC-165	Inspect <sup>1</sup> Inspect <sup>2</sup> Inspect <sup>3</sup> Test <sup>4</sup> Test <sup>17</sup> Test <sup>6</sup> Service <sup>1</sup> Service <sup>2</sup> Service <sup>18</sup> Service <sup>8</sup> Adjust <sup>9</sup> Adjust <sup>10</sup> Adjust <sup>11</sup> Adjust <sup>19</sup> Align <sup>12</sup> Replace Repair <sup>13</sup> Repair <sup>14</sup> Repair <sup>20</sup> Repair <sup>16</sup> Overhaul Rebuild	0.1	0.2	0.3		2.0	1,3 6 thru 21 6 thru 66
0101	AMPLIFIER, RADIO FREQUENCY MODULE 1A1	Test <sup>21</sup> Test <sup>22</sup> Adjust <sup>11</sup> Adjust <sup>19</sup> Replace Repair Overhaul Rebuild			1.0		1.5	6 thru 21 6 thru 66
					0.5		1.0	
					0.6		2.0	4,5
							4.0	4,5
							8.0	4,5

See footnotes at end of chart

(1) GROUP NUMBER	(2) COMPONENT ASSEMBLY	(3) MAINTENANCE FUNCTION	(4) MAINTENANCE CATEGORY					(5) TOOLS AND EQUIPMENT
			C	O	F	H	D	
0102 through 0119	MODULES 1A2 through 1A19	Test <sup>21</sup>			1.0			6 thru 21
		Test <sup>22</sup>					1.5	6 thru 66
		Adjust <sup>11</sup>			0.5			
		Adjust <sup>19</sup>					1.0	
		Replace			0.6			4,5
		Repair					2.0	4,5
		Overhaul					4.0	4,5
0120 through 0123	SUBASSEMBLIES 1A20 through 1A23	Rebuild					8.0	4,5
		Test <sup>23</sup>			0.5			6 thru 21
		Adjust <sup>24</sup>			0.5			
		Replace			0.3			4,5
		Repair <sup>25</sup>			0.5			4,5
		Overhaul					1.5	4,5
02	COUPLER, ANTENNA CU-1782/GRC-165	Rebuild					3.0	4,5
		Inspect <sup>1</sup>	0.1					
		Inspect <sup>2</sup>		0.2				
		Test <sup>4</sup>	0.2					
		Test					0.8	6 thru 66
		Service <sup>1</sup>	0.1					
		Adjust <sup>9</sup>	0.2					
		Adjust					1.0	
		Replace			0.3			4,5
		Repair <sup>26</sup>			0.2			4,5
		Repair <sup>27</sup>				1.0		4,5
		Repair <sup>16</sup>					2.0	4,5
		Overhaul					4.0	4,5
		Rebuild					8.0	4,5
03	MOUNTINGS MT-3975/GRC AND MT-3976/GRC	Inspect	0.2					
		Test		0.2				6 thru 21
		Service	0.2					
		Replace			0.3			4, 5
		Repair <sup>28</sup>			0.2			2
		Repair <sup>16</sup>				0.4		4,5
		Overhaul					1.0	4,5
Rebuild					2.0	4,5		
04	ANTENNA ASSEMBLY AS-2203/GRC-165	Inspect	0.2					
		Test <sup>4</sup>	0.1					
		Test		0.2				1
		Service	0.2					
		Replace			0.5			2
		Repair <sup>29</sup>			0.	5		2
		Repair					1.0	4,5
		Overhaul					1.5	4,5
		Rebuild					2.0	4,5
05	CABLE ASSEMBLIES	Inspect	0.1					
		Test		0.2				1
		Service	0.1					
		Replace	0.2					
		Repair <sup>30</sup>			0.5			4,5
		Overhaul					1.0	4,5
Rebuild					1.5	4,5		

See footnotes at end of chart.

(1) Group Number	(2) Maintenance Component/Assembly	(3) Maintenance Level* Function	(4)					(5) Tools and Equipment
			C	O	F	H	D	
06 07	HANDSET H-280/GRC-165 MICROPHONE M-143/GR	Inspect Test Replace Repair 31 Repair	0.1 0.1	0.2 0.2	0.5			1 2 4,5
08	CONTROL, RADIO SET C-7648/GRC-165	Inspect 1 Inspect 2 Inspect 3 Test 4 Test 23 Test 6 Service Adjust 32 Adjust 19 Replace Repair 26 Repair Overhaul Rebuild	0.1      0.1	0.2   0.1     0.5 0.2	0.3  0.5   0.4    1.0		1.0     0.6   2.0 4.0	1 6 thru 21 6 thru 66   4,5 4,5 4,5 4,5

- (1) Exterior only.
- (2) Interior, exterior of modules.
- (3) All inspections.
- (4) Limited to operational tests and tube tests.
- (5) Those tests required to locate faulty modules and components mounted on chassis, and modules in RT unit, antenna coupler, and remote control box. Also limited functional tests of these units.
- (6) All tests.
- (7) Interior, where no Removal is required.
- (8) All servicing.
- (9) Operator adjustments only.
- (10) Limited to those adjustments when PA tubes are replaced.
- (11) Those adjustments required when modules are replaced.
- (12) Alignment of modules after repair.
- (13) By replacement of running spares.
- (14) By replacement of cable assemblies and PA tubes.
- (15) By replacement of modules and components mounted on chassis.
- (16) All repairs.
- (17) Those tests required to locate faulty module IA1 through 1A19, components mounted on chassis, and modules 1A20 through 1A23.
- (18) Module service.
- (19) All adjustments.
- (20) By replacement of modules 1A1 through 1A19, and components mounted on chassis and in subassemblies 1A20 through 1A23.
- (21) Those tests required to locate faulty modules.
- (22) Those tests required for module repair.
- (23) Those tests required to locate fault components.
- (24) Those adjustments required after subassembly repair.
- (25) By replacement of faulty components.
- (26) By replacement of cables and knobs.
- (27) By replacement of switches and connectors.
- (28) By replacement of filter.
- (29) By replacement of antenna elements.
- (30) By replacement of connectors.
- (31) By replacement of elements and caps.
- (32) Those adjustments required after replacement of faulty components.

C-5

C-5

**SECTION III TOOL AND TEST EQUIPMENT REQUIREMENTS  
FOR  
RADIO SET AN/GRC-165**

TOOL OR TEST EQUIPMENT REF CODE	MAINTENANCE CATEGORY	NOMENCLATURE	NATIONAL/NATO STOCK NUMBER	TOOL NUMBER
1	0	MULTIMETER AN/URM-105	6625-00-884-1758	
2	0	TOOL KIT, ELECTRONIC EQUIPMENT TK-101/G	5180-00-064-5178	
3	0	TEST SET, ELECTRON TUBE TV-7D/U	6625-00-820-0064	
4	F,H,D	TOOL KIT, ELECTRONIC EQUIPMENT TK-100/G	5180-00-605-0079	
5	F,H,D	TOOL KIT, ELECTRONIC EQUIPMENT TK-105/G	5180-00-610-8177	
6	F,H,D	GENERATOR, SIGNAL AN/GRM-50	6625-00-868-8353	
7	-F,H,D	MULTIMETER ME-26()/U	6625-00-360-2493	
8	F,H,D	DUMMY LOAD, ELECTRICAL DA-75/U	6625-00-177-1639	
9	F,H,D	COUNTER, ELECTRONIC, DIGITAL READOUT AN/USM-207	6625-00-911-6368	
10	F,H,D	VOLTMETER, ELECTRONIC AN/URM-145	6625-00-973-3986	
11	F,H,D	OSCILLOSCOPE AN/USM-281A	6625-00-228-2201	
12	F,H,D	CHARGER, BATTERY PP-1451/G	6130-00-985-8157	
13	F,H,D	POWER SUPPLY PP-3940A/G (2 required at depot)	6130-00-404-1727	
14	F,H,D	CABLE W7 (3 required at depot)	5995-00-070-8747	
15	F,H,D	CONNECTOR UG-273/U	5935-00-149-3534	
16	F,H,D	CABLE W2 CX-10820/GR	5995-00-042-5479	
17	F,H,D	MICROPHONE M-143/GR	5965-00-102-3803	
18	F,H,D	ADAPTER CONNECTOR UG-201A/U (2 ea. required at depot)	5935-00-842-9614	
19	F,H,D	PROBE T-CONNECTOR HP-11042A	6625-00-713-4356	
20	F,H,D	CABLE ASSEMBLY CX-10822/U	5995-00-042-5481	
21	F,H,D	PROBE, SCOPE HP-11047A (MX-6122/U)	6625-00-759-7436	
22	D	RADIO TEST SET AN/GRM-90	6625-00-012-3157	
23	D	TEST SET, RADIO AN/USM-306	6625-00-459-8568	
24	D	GENERATOR, SIGNAL AN/URM-127	6625-00-783-5965	
25	D	TWO-TONE GENERATOR SG-788/U		
26	D	POWER SUPPLY HP-711A		
27	D	POWER SUPPLY HP-723A		
28	D	CABLE W8 H.H. SMITH CO 1537-36		
29	D	CONNECTOR UG-1035	5935-00-856-9441	
30	D	CABLE ASSEMBLY W9 HP-11000OA	5995-00-985-8214	
31	D	ALIGNMENT TOOL DELEVAN 9668		
32	D	CABLE ASSEMBLY CX-10817/U	5995-00-022-2741	
33	D	CONNECTOR UG-274/U	5935-00-666-4876	
34	D	CABLE ASSEMBLY CG-3467/U	5995-00-022-2742	
35	D	ANTENNA AS-2203/GRC-165		
36	D	CONNECTOR UG-255/U	5935-00-149-3914	
37	D	ATTENUATOR, KAY ELECTRIC CO 30-0		
38	D	R.F. BRIDGE GR-1606A		
39	D	ADAPTER, COAXIAL GR-874-QBPA	5935-00-984-5563	
40	D	ADAPTER, COAXIAL GR-874-QUP	5935-00-666-4873	

**TABLE 1. TOOL AND TEST EQUIPMENT REQUIREMENTS  
FOR  
RADIO SET AN/GRC-165**

TOOL OR TEST EQUIPMENT REF CODE	MAINTENANCE CATEGORY	NOMENCLATURE	NATIONAL/NATO STOCK NUMBER	TOOL NUMBER
41	D	ADAPTER, COAXIAL GR-874-QUJ		
42	D	ADAPTER, COAXIAL GR-874-PB58A		
43	D	CABLE ASSEMBLY CX-10823/U	5995-00-042-5482	
44	D	CRYSTAL DETECTOR HP-8471A	5961-00-125-1313	
45	D	TEST SET, RADIO FREQUENCY POWER AN/URM-120	6625-00-813-8430	
46	D	PATCH CORD GR-374-R22A	5995-00-754-8178	
47	D	MULTIMETER ME-30( )/U	6625-00-643-1670	
48	D	CONNECTOR RF 425-0675	5995-00-498-6463	
49	D	LOAD; RF 425-0676	5985-00-239-6102	
50	D	LOAD; RF 425-0677	5985-00-239-6101	
51	D	CONNECTOR; RF 425-0678	5995-00-554-4577	
52	D	LOAD; RF 425-0679	5995-00-498-6464	
53	D	ATTENUATOR; RF 425-0680	5905-00-400-7691	
54	D	LOAD; RF 425-0681	5935-00-401-0654	
55	D	ATTENUATOR; RF 425-0682	5905-00-400-7692	
56	D	CONNECTOR; RF 425-0683	5935-00-192-9627	
57	D	CONNECTOR; RF 425-0684	5935-00-194-2974	
58	D	CONNECTOR; RF 425-0685	5995-00-554-4578	
59	D	ATTENUATOR; RF 425-0686	5915-00-238-9428	
60	D	ATTENUATOR; RF 425-0687	5915-00-401-0655	
61	D	ATTENUATOR; RF 425-0688	5915-00-466-0226	
62	D	ATTENUATOR; RF 425-0689		
63	D	ATTENUATOR; RF 425-0690	5915-00-466-0222	
64	D	ATTENUATOR; RF 425-0691	5915-00-466-0225	
65	D	ATTENUATOR; RF 425-0692	5915-00-466-0224	
66	D	ATTENUATOR; RF 425-0693	5905-00-465-6069	

AMSEL..MA Form 6013  
1 Oct 74

HISA-FM 2881-74

APPENDIX D

ORGANIZATIONAL MAINTENANCE REPAIR PARTS AND SPECIAL TOOLS

Section I. INTRODUCTION

**D-1. Scope**

This appendix lists repair parts and special tools required for the performance of organizational maintenance for Radio Set AN/GRC-165.

cured and stocked and can be assembled by units at indicated maintenance categories.

**D-2. General**

This repair parts and special tools list is divided into the following sections:

a. *Prescribed Load Allowance (PLA)-Section II.* A composite listing of the repair parts, special tools, test and support equipment having quantitative allowances for initial stockage at the organizational level.

b. *Special Tools, Test and Support Equipment for Organizational Maintenance-Section III.* Not applicable.

c. *Repair Parts for Organizational Maintenance - Section IV.* A list of repair parts authorized for the performance of maintenance at the organizational level.

X2- Applies to repair parts which are not stocked. The indicated maintenance category requiring such repair parts will attempt to obtain them through cannibalization; if not obtainable through cannibalization, such repair parts will be requisitioned with supporting justification through normal supply channels.

(2) *Maintenance code column.* The lowest category of maintenance authorized to install the listed item is noted here.

**D-3. Explanation of Columns**

An explanation of the columns is given below.

a. *Source, Maintenance, and Recoverability Codes, Column 1.*

(1) *Source code column.* The selection status and source for the listed item is noted here. Source codes and their explanation are as follows:

Code	Explanation
P-	Applies to repair parts that are stocked in or supplied from the GSA/DSA, or Army supply system, and authorized for use at indicated maintenance categories.
A	Applies to assemblies that are not procured or stocked as such but are made up of two or more units, each of which carry individual stock numbers and descriptions and are pro

Code	Explanation
C.....	Operator/crew
O.....	Organizational maintenance
(3) <i>Recoverability code column.</i> The information in this column indicates whether unserviceable items should be returned for recovery or salvage. Recoverability code is as follows:	

**NOTE**

**When no code is indicated in the recoverability column, the part will be considered expendable.**

Code	Explanation
R-	Applies to repair parts and assemblies which are economically repairable at DSU and GSU activities and normally are furnished by supply on an exchange basis.

b. *Federal Stock Number Column 1.* The Federal stock number for the item is indicated in this column and will be used for requisitioning purposes.

c. *Description Column.* The model designation, sequence number, Federal item name, a five-digit manufacturer's code and a part number are in

cluded in this column. The words "same as" followed by the index number assigned to the item when it first appeared in the list will follow the item name, e.g., "RESISTOR, FIED, COMPOSITIONS: SAME AS A298."

d. *Unit of issue Column.* The unit used as a basis of issue, e.g., ea., pr, ft, yd, etc. is indicated in this column.

e. *Quantity Incorporated in Unit Pack Column 5.* Not applicable.

f. *Quantity Incorporated in Unit Column.* The quantity of repair parts in an assembly is given in this column. Subsequent appearances of the same item in the same assembly are indicated by the letters "REF."

g. *Maintenance Allowances Column.*

(1) The allowance columns are divided into subcolumns. Indicated in each subcolumn opposite the first appearance of each item is the total quantity of items authorized for the number of equipments supported. Subsequent appearances of the same item will have no entry in the allowance columns but will have a reference in the description column to the first appearance of the item. Items authorized for use as required, but not for initial stockage, are identified by an asterisk in the allowance column.

(2) The quantitative allowances for organizational level of maintenance represents one initial prescribed load for a 15-day period for the number of equipments supported. Units and organizations authorized additional prescribed loads will multiply the number of prescribed loads authorized by the quantity of repair parts reflected in the density column to obtain the total quantity of repair parts authorized.

(3) Organizational units providing maintenance for more than 100 of these equipments shall determine the total quantity of parts required by converting the equipment quantity to a decimal factor by placing a decimal point before the next to last digit of the number to indicate hundredths, and multiplying the decimal factor by the parts quantity authorized in the 51-100 allowance column. *Example*, authorized allowance for 51-100 equipments is 40; for 150 equipments multiply 40 by 1.50 or 60 parts required.

(4) Subsequent changes to allowances will be limited as follows: No change in the range of items is authorized. If additional items are considered

necessary, recommendation should be forwarded to Commanding General, U.S. Army Electronics Command, ATTN: AMSEIME-NMP-EM, Fort Monmouth, NJ 07703, for exception or revision to the allowance list. Revisions to the range of items authorized will be made by the USA ECOM National Maintenance Point based upon engineering experience, demand data, or TAERS information.

h. *Illustration Column.*

(1) *Figure number column.* Indicates the figure number of the illustration in which the item is shown.

(2) *Item or symbol number column.* Not applicable.

**D-4. Special Information**

Repair parts mortality is computed from failure rates derived from experience factors with the individual parts in a variety of equipments. Variations in the specific application and periods of use of electronics equipment, the fragility of electronic piece parts, plus intangible material and quality factors intrinsic to the manufacture of electronic parts, do not permit mortality to be based on hours of end item use. However, long periods of continuous use under adverse conditions are likely to increase repair parts mortality.

**D-5. Location of Repair Parts**

This appendix does not contain any cross-reference indexes. In order to locate a repair part, scrutinize the repair parts list until the item is located.

**D-6. Federal Supply Code for Manufacturers**

<i>Code</i>	<i>Manufacturer's Name</i>
14304.....	RF Communications, Inc.
15605.....	Cutler-Hammer, Inc.
42498.....	National Radio Co., Inc.
55938 .....	Raytheon Co.
73734.....	Federal Screw Products, Inc.
75915.....	Littlefuse, Inc.
80131.....	Electronic Ind. Association
81349.....	Military Specifications
88044.....	Aeronautical Standards Group
96906.....	Military Standards
99813.....	Jan Hardware Mfg Co.



SECTION II. PRESCRIBED LOAD ALLOWANCE

(1) FEDERAL STOCK NUMBER	(2) DESCRIPTION  USABLE ON CODE	(3) 15-DAY ORGANIZATIONAL MAINTENANCE ALLOWANCE			
		(a) 1-5	(b) 6-20	(c) 21-50	(d) 51-100
5355-556-0151	KNOB: 55938; 70-2-2G				2
5920-012-0151	FUSE, CARTRIDGE: 81349; F02A32V15A		2	2	3
5920-557-2647	FUSE, CARTRIDGE: 81349; FO2A4R00A		2	2	3
5920-681-4353	FUSE, CARTRIDGE: 75915; 311025		2	2	3
5960-538-2363	ELECTRON TUBE: 80131; 12BY7A	2	2	4	8
5960-548-5068	ELECTRON TUBE: 80131; 6DC6	2	2	4	8
5960-904-9744	ELECTRON TUBE: 80131; 6146B	2	4	11	20
	KNOB: 42498; 7F2L			2	2
	LAMP, INCANDESCENT: 80131; 328		2	2	3

(1)			REPAIR PARTS FOR ORGANIZATIONAL MAINTENANCE						(4)	(5)	(6)	(7)				(8)		
(A)	(B)	(C)	(2) FEDERAL STOCK NUMBER	(3)						UNIT OF ISSUE	QTY INC IN UN PK	QTY INC IN UNIT	15 DAY ORG. MAINT.				(A)	(B)
SRCE CD	MNTC CD	REC CODE		MODEL									(A)	(B)	(C)	(D)	FIGURE NUMBER	ITEM OR SEQ. NO.
				1	2	3	4	5	6				1-5	6-20	21-50	51-100		
P	0	R	5820-935-8038							A001 RADIO SET AN/GRC-165	EA	REF						
A	0	R	5995-042-5481							A008 CABLE ASSEMBLY, POWER, ELECTRICAL CX-10822U (20FT)	EA	1	*	*	*	*	1-1	
X2	0									A019 COUPLER, ANTENNA CU-1782/GRC-165	EA	1						
X2	0									A020 BOLT, SHOULDER: 14304; 425-0037	EA	4						
X2	0		5310-655-6534							A021 NUT, ASSEMBLED WASHER: 73734; 9227	EA	4						
X2	0									A022 BOLT, SHOULDER: 14304; 425-0037 SAME AS A020	EA	REF						
X2	0		5310-655-6534							A023 NUT, ASSEMBLED WASHER: 73734; 9227 SAME AS A021	EA	REF						
X2	0									A024 BOLT, SHOULDER: 14304; 425-0037 SAME AS A020	EA	REF						
X2	0		5310-655-6534							A025 NUT, ASSEMBLED WASHER: 72734; 9227 SAME AS A021	EA	REF						
X2	0									A026 BOLT, SHOULDER: 14304; 425-0037 SAME AS A020	EA	REF						
X2	0		5310-655-6534							A027 NUT, ASSEMBLED WASHER: 73734; 9227 SAME AS A021	EA	REF						
X2	0		5310-969-6959							A029 NUT, ASSEMBLED WASHER: 73734; 9225	EA	7						
X2	0									A030 SCREW, MACHINE: 14304; H0620	EA	2						
X2	0									A031 SCREW, MACHINE: 14304; HC618	EA	6						
X2	0		5310-531-9514							A032 WASHER, FLAT: 88044; AN960C6	EA	11						
X2	0		5340-682-1815							A034 BUMPER, RUBBER: 73734; 1685	EA	4						
X2	0		5340-682-1815							A035 BUMPER, RUBBER: 73734; 1685; SAME AS A034	EA	REF						
X2	0		5340-682-1815							A036 BUMPER, RUBBER: 73734; 1685; SAME AS A034	EA	REF						
X2	0		5340-682-1815							A037 BUMPER, RUBBER: 73734; 1685; SAME AS A034	EA	REF						
X2	0		5330-574-6704							A038 PACKING WITH RETAINER; 15605; 32-341	EA	1						
P	0									A112 CRANK, HAND: 14304; 162-2180	EA	2	*	*	*	*	1-1	
X2	0		5305-543-5832							A113 SETSCREW: 96906; MS51021-11	EA	2						
X2	0									A114 KNOB: 14304; 162-2181	EA	2						
X2	0									A115 SCREW, SHOULDER: 99813; A100152	EA	2						

(1)			REPAIR PARTS FOR ORGANIZATIONAL MAINTENANCE						(4)	(5)	(6)	(7)				(8)		
(A)	(B)	(C)	(2) FEDERAL STOCK NUMBER	(3)						UNIT OF ISSUE	QTY INC IN UN PK	QTY INC IN UNIT	15 DAY ORG. MAINT.				ILLUSTRATIONS	
SRCE CD	MNTC CD	REC CODE		MODEL									(A)	(B)	(C)	(D)	(A)	(B)
			1	2	3	4	5	6	DESCRIPTION			1-5	6-20	21-50	51-100	FIGURE NUMBER	ITEM OR SEQ. NO.	
X2	0								A116 SPACER SLEEVE: 99813; A100172	EA		2						
X2	0								A117 WASHER, FLAT: 99813; A100151	EA		2						
P	0								A118 CRANK HAND: 14304; 162-2180 SAME AS A112	EA		REF				1-1		
X2	0		5305-543-5832						A119 SETSCREW: 96906; YM51021-11 SAME AS A113	EA		REF						
X2	0								A120 KNOB: 14304; 162-2181 SAME AS A114	EA		REF						
X2	0								A121 SCREW, SHOULDER: 99813; DA10152 SAME AS A115	EA		REF						
X2	0								A122 SPACER, SLEEVE: 99813; DA100172 SAME AS A116	EA		REF						
X2	0								A123 WASHER, FLIAT: 99813; DA100151 SAME AS A117	EA		REF						
P	0		5355-942-7240						A147 KNOB: 55938; 70-8WL2G	EA		2	*	8	*	*	1-1	
X2	0								A148 SETSCREW: 96906; MS51021-38	EA		1						
X2	0		5305-551-0156						A149 SETSCREW: 96906; M551021-31	EA		1						
P	0		5995-022-2741						A279 LEAD, ELECTRICAL CX-10817/U (2 FT 6 IN)	EA		1	*	*	*	*	1-1	
P	0								A280 LEAD, ELECTRICAL 14304; 162-2175	EA		1	*	*	*	*	1-1	
X2	0		4130-910-4622						A284 FILTER, AIR CONDITIONING: 14304; MP1187	EA		1						
A	0	R							A286 RECEIVER-TRANSMITTER RADIO RT-902/GRC-165	EA		1						
P			5960-548-5068						A742 ELECTRON TUBE: 80131; 6DC6	EA		1	2	2	4	8		
P			5960-538-2363						A743 ELECTRON TUBE: 80131; 12 BY 7A	EA		1	2	2	4	8		
P	0								B167 DIAL, CONTROL: 14304; 162-0064	EA		1	*	*	*	*	1-1	
X2	0		5305-082-6782						B168 SETSCREW: 96906; MS51021-36	EA		8						
P	0								B169 DIAL, CONTROL: 14304; 162-0065	EA		2	*	*	*	*	1-1	
X7	0		5305-082-6782						B170 SETSCREW: 96906; MS51021-36 SAME AS B168	EA		REF						
P	0								B171 DIAL, CONTROL: 14304; 162-0065 SAME AS B169	EA		REF					1-1	
X2	0		5305-082-6782						B172 SETSCREW: 96906; MS51021-36 SAME AS B168	EA		REF						
P	0								B173 DIAL, CONTROL: 14304; 162-0066	EA		1	*	*	*	*	1-1	

(1)			REPAIR PARTS FOR ORGANIZATIONAL MAINTENANCE						(4)	(5)	(6)	(7) 15 DAY ORG. MAINT.				(8) ILLUSTRATIONS		
(A) SRCE CD	(B) MNTC CD	(C) REC CODE	(2) FEDERAL STOCK NUMBER	(3) MODEL						UNIT OF ISSUE	QTY INC IN UN PK	QTY INC IN UNIT	(A)	(B)	(C)	(D)	(A)	(B)
				1	2	3	4	5	6				DESCRIPTION		1- 5	6- 20	21- 50	51- 100
X2	0		5305-082-6782							B174 SETSCREW: 96906; MS51021-36 SAME AS B168	EA	REF						
P	0									B175 DIAL, CONTROL: 14304; 162-0067	EA	2	*	*	*	*	1-1	
X2	0		5305-800-7261							B176 SETSCREW: 96906; MS51021-9	EA	6						
P	0									B177 DIAL, CONTROL 14304; 162-0067 SAME AS B175	EA	REF						1-1
X2	0		5305-800-7261							B178 SETSCREW: 96906; MS51021-9 SAME AS B176	EA	REF						
X2	0		5305-993-0190							B180 SCREW, MACHINE: 96906; M635206-214	EA	7						
X2	0		5310-515-7999							B181 WASHER, LOCK: 96906; MS35339-40	EA	7						
P			5960-904-9744							B182 ELECTRON TUBE: 80131; 6146B	EA	3	2	4	11	20		
P			5960-904-9744							B183 ELECTRON TUBE: 80131; 6146B SAME AS B182	EA	REF						
P			5960-904-9744							B184 ELECTRON TUBE: 80131; 6146B SAME AS B182	EA	REF						
P	C		5920-012-0151							B222 FUSE, CARTRIDGE 81349; FO2A32V15A	EA	1	*	2	2	3		
P	C		5920-557-2647							B223 FUSE, CARTRIDGE: 81349; FO2A4ROOA	EA	1	*	2	2	3		
X2	0									B330 HOUSING, RECEIVER-TRANSMITTER: 14304; 425-0111	EA	1						
X2	0									B331 SCREW, MACHINE: 73734; 23026	EA	12						
X2	0		5310-782-1349							B332 WASHER, FLAT: 88044; AN960C4	EA	12						
P	0									B335 KNOB: 42498; 7F2L	EA	3	*	*	2	2	1-1	
X2	0		5305-655-9246							B336 SETSCREW: 96906; MS51021-10	EA	11						
P	0									B337 KNOB: 42498; 7F2L SAME AS B335	EA	REF						1-1
X2	0		5305-655-9246							B338 SETSCREW: 96906; MS51021-10 SAME AS B336	EA	REF						
P	0									B339 KNOB: 42498; 7F2L SAME AS B335	EA	REF						1-1
X2	0		5305-655-9246							B340 SETSCREW: 96906; MS51021-10 SAME AS B336	EA	REF						
P	0		5355-942-7240							B341 KNOB: 55938; 70-8WL2G SAME AS A147	EA	REF						1-1
X2	0		5305-655-9246							B342 SETSCREW: 96906; MS51021-10 SAME AS B336	EA	REF						
X2	3		5305-619-4580							B343 SETSCREW: 96906; MS51021-15	EA	1						

(1)			REPAIR PARTS FOR ORGANIZATIONAL MAINTENANCE						(4)	(5)	(6)	(7)				(8)		
(A)	(B)	(C)	(2) FEDERAL STOCK NUMBER	(3)						UNIT OF ISSUE	QTY INC IN UN PK	QTY INC IN UNIT	15 DAY ORG. MAINT.				(A) FIGURE NUMBER	(B) ITEM OR SEQ. NO.
SRCE CD	MNTC CD	REC CODE		MODEL									(A)	(B)	(C)	(D)		
				1	2	3	4	5	6	DESCRIPTION			1- 5	6- 20	21- 50	51- 100		
P	0		5355-556-0151							B344 KNOB: 55938; 70-2-20	EA		2	*	*	*	2	1-1
X2	0		5305-655-9246							B345 SETSCREW: 96906; MS51021-10 SAME AS B336	EA		REF					
P	0		5355-556-0151							B346 KNOB: 55938; 70-2-2G SAME AS B344	EA		REF					1-1
X2	0		5305-655-9246							B347 SETSCREW: 96906; MS51021-10 SAM AS B336	EA		REF					
P	C		5920-681-4353							C755 FUSE, CARTRIDGE: 75915; 311025	EA		1	*	2	2	3	
A	0	R								C827A CABLE ASSEMBLY, SPECIAL PURPOSE CX-10823/U (92 FT)	EA		1					
P	0	R	5965-102-8521							C848 HANDSST H-280/GRC-165	EA		1	*	*	*	*	1-2
P	0	C								C851 KNOB: L2498; 7F2L: SAME AS B335	EA		2					1-1
P	0	C								852 KNOB: 42498; 7F2L SAME AS B335	EA		REF					1-1
A	0	R								C895 ANTENNA AS-2203/GRC-165	EA		REF					2-5
X2	0		5820-931-9106							C900 BASE, ANTENNA AB-1082/GRC-165	EA		1					
P	O									C691A LAMP, INCANDESCENT: 80131; 328	EA		1	*	2	2	3	

INDEX

	Paragraph	Page
Additional equipment required-----	1-9	1-4
Adjustments and tests -----	5-12	5-8
Air filter, cleaning-----	4-6	4-2
Antenna assembly-----	2-7	2-6
Antenna coupler:		
Controls-----	3-3	3-3
Lubrication-----	5-6 <i>b</i>	5-2
Rear panel connectors-----	3-3 <i>b</i>	3-5
Antenna, whip-----	2-7	2-6
Assembly, antenna-----	2-7	2-6
Authority, demolition-----	6-3	6-1
Cable repair-----	5-8	5-3
Characteristics, technical-----	1-5	1-2
Checking unpacked equipment-----	2-22	2-1
Cleaning:		
General-----	4-5	4-2
Air filter-----	4-6	4-2
Common names-----	1-7	1-3
Components, lists-----	1-6	1-3
Connectors:		
Rear panel, rt unit-----	3-2 <i>b</i>	3-3
Rt. unit-----	3-2	3-1
Control adjustments-----	5-11 <i>d</i>	5-8
Damage, improper control settings-----	3-1	3-1
Demolition, authority-----	6-3	6-1
Description:		
Equipment-----	1-8	1-3
Radio set-----	1-8 <i>a</i>	1-3
Remote control-----	1-8 <i>b</i>	1-4
Destruction, methods-----	6-4	6-1
Dimensions and Weight-----	2-1 <i>b</i>	2-1
Dipole antenna-----	2-7 <i>a</i>	2-6
Disassembly, equipment-----	6-1	6-1
Discrepancy, shipment report-----	1-3 <i>c</i>	1-2
Equipment:		
Description-----	1-8	1-3
Disassembly-----	6-1	6-1
Required, additional 1-----	1-9	1-4
Fixed station installation-----	2-3 <i>b</i>	2-3
Forms and records-----	1-3	1-2
Groundwave propagation range-----	2-5 <i>b</i>	2-5
Handling deficiencies, report-----	1-3 <i>b</i>	1-2
Hardware, tightening-----	5-11 <i>e</i>	5-8
Improper control settings, damage-----	3-1	3-1
Indexes, publications-----	1-2	1-2
Indicators, rt unit-----	3-2	3-1
Installation:		
Fixed station-----	2-3 <i>b</i>	2-3
Mobile 2-3 <i>a</i> -----	2-3 <i>a</i>	2-1
Radio set-----	2-3	2-1
Instructions, operating-----	3-7	3-6
Jamming, recognition-----	2-6	2-6

	Paragraph	Page
Limited storage-----	6-2	6-1
List, components-----	1-6	1-3
Lubrication -----	5-6	5-2
Maintenance, report -----	1-3a	1-2
Methods, destruction -----	6-4	6-1
Mobile installation -----	2-3a	2-1
Monthly:		
Maintenance-----	5-4	5-1
Preventive maintenance checks and services chart -----	5-5	5-2
Names, common -----	1-7	1-3
Operation,:		
Instructions -----	3-7	3-6
Procedures -----	3-7c	3-7
Operation:		
Remote control -----	3-8	3-7
Types-----	3-5	3-6
Operator:		
Daily preventive maintenance checks and services chart -----	4-3	4-1
Weekly preventive maintenance checks and services chart-----	4-4	4-2
Organizational:		
Monthly preventive maintenance checks and services chart-----	5-5	5-2
Troubleshooting chart -----	5-10	5-6
Pa. bias adjustment -----	5-11	5-8
Packaging:		
Deficiencies, report-----	1-3b	1-2
Data -----	2-1a	2-1
Painting, touchup-----	5-7	5-2
Power requirements-----	1-10	1-4
Power supply voltage measurements-----	5-11b	5-3
Preliminary starting procedures-----	3-6	3-6
Preventive maintenance, operator (See Operator.)		
Publications, indexes -----	1-2	1-2
Radio set installation-----	2-3	2-1
Ranging-----	2-5	2-5
Rear panel controls, rt unit-----	3-2b	3-3
Receiver tuning-----	3-7	3-6
Recognition, jamming -----	2-6	26
Records, forms -----	1-3	1-2
Remote control:		
Connectors -----	3-4	3-5
Operation -----	3-8	3-7
Removal, contents-----	2-1c	2-1
Repacking, shipment -----	6-2	6-1
Repair and troubleshooting -----	4-7	4-2
Repair, cable -----	5-8	5-3
Replacement:		
Fuses -----	4-7	4-2
Hardware-----	5-11a	5-8
Report:		
Equipment manual improvements -----	1-3b	1-2
Packaging and handling deficiencies -----	1-3d	1-2
Unsatisfactory equipment -----	1-3a	1-2
Requirements, power-----	1-10	1-4
Rt unit:		
Cover removal -----	5-11a	5-7
Front panel switches, controls, indicators, and connectors-----	3-2a	3-1
Lubrication-----	5-6a	5-2
Rear panel switch, indicators, and connectors -----	3-2b	3-3
Scope -----	1-1	1-1
Siting -----	2-4	2-3
Skywave propagation-----	2-5c	2-5
Starting procedures -----	3-6	3-6

	<b>Paragraph</b>	<b>Page</b>
Stopping procedures-----	3-9	3-7
Technical characteristics-----	1-5	1-2
Test and adjustments -----	11	5-7
Tightening control knobs -----	5-11 <i>d</i>	5-8
Tools, materials, test equipment required -----	5-2-	5-1
Touchup painting -----	5-7	5-2
Transmitter tuning-----	3-7 <i>b</i>	3-6
Troubleshooting and repair -----	4-7	4-2
Tube testing_-----	5-12	5-8
Types, operation -----	3-5	3-6
Unpacked equipment, checking -------	2-2	2-1
Unpacking instructions -----	2-1	2-1
Weekly preventive maintenance -----	4-4	4-2
Weight and dimensions _-----	2-1 <i>b</i>	2-1
Whip antenna -----	2-7	2-6



By Order of the Secretary of the Army:

W. C. WESTMORELAND,  
*General, United States Army,*  
*Chief of Staff*

Official:

KENNETH G. WICKHAM,  
*Major General, United States Army,*  
*The Adjutant General*

Distribution:

*Active Army:*

USASA (2)  
 CNGB (1)  
 Dir. of Trans (1)  
 CofEngrs (1)  
 TSG (1)  
 CofSptS (1)  
 ACSC-E (2)  
 USAMB (10)  
 USAARENBD (2)  
 USACDCCEA (1)  
 USACDCCEA  
     Ft Huachuca (1)  
 USCONARC (2)  
 USAMC (1)  
 USAMICON (2)  
 USAECOM (2)  
 ARADCOM (2)  
 OS Maj Comd (2)  
 USACDCEC (10)  
 USASTRATCOM (10)  
 USASTRATCOM-EUR (100)  
 USAESC (70)  
 USATECOM (2)  
 USAREUR (25)  
 Armies (1) except  
     7th USA (25)

Sig FLDMS (2)  
 Army Depots (1) except  
     LBAD (10)  
     SAAD (15)  
     TOAD (14)  
     LEAD(7)  
     ATAD(10)  
 Svc Colleges (1)  
 Gen. Dep. (1)  
 Sig Sec Gen. Dep. (6)  
 Sig Dep. (6)  
 USACRREL (2)  
 WSMR (2)  
 Fort Carson (5)  
 USAERDAA (2)  
 USAERDAW (2)  
 Units org under fol TOE:  
     (2 copies each)  
     11-158  
     11-302  
     11-303  
     11-367  
     11-368  
     11-500(AA-AC)  
     29-134

NG: None.

USAR: None.

For explanations of abbreviations used, see AR 310-50.

RECOMMENDED CHANGES TO EQUIPMENT TECHNICAL PUBLICATIONS



THEN... JOT DOWN THE DOPE ABOUT IT ON THIS FORM, CAREFULLY TEAR IT OUT, FOLD IT AND DROP IT IN THE MAIL!

**SOMETHING WRONG WITH THIS PUBLICATION?**

FROM: (PRINT YOUR UNIT'S COMPLETE ADDRESS)

DATE SENT

PUBLICATION NUMBER	PUBLICATION DATE	PUBLICATION TITLE
--------------------	------------------	-------------------

BE EXACT... PIN-POINT WHERE IT IS				IN THIS SPACE TELL WHAT IS WRONG AND WHAT SHOULD BE DONE ABOUT IT:
PAGE NO.	PARA-GRAPH	FIGURE NO.	TABLE NO.	

PRINTED NAME, GRADE OR TITLE, AND TELEPHONE NUMBER

SIGN HERE:

TEAR ALONG PERFORATED LINE

DA FORM 2028-2  
JUL 79

PREVIOUS EDITIONS ARE OBSOLETE.

P.S.—IF YOUR OUTFIT WANTS TO KNOW ABOUT YOUR RECOMMENDATION MAKE A CARBON COPY OF THIS AND GIVE IT TO YOUR HEADQUARTERS.

