

TM 11-5820-453-10

DEPARTMENT OF THE ARMY TECHNICAL MANUAL

OPERATOR'S MANUAL

RADIO SETS AN/GRC-87 AND AN/VRC-34



*HEADQUARTERS, DEPARTMENT OF THE ARMY
10 MAY 1963*

WARNING

HIGH VOLTAGE

is used on this equipment

DEATH ON CONTACT

may result if safety precautions
are not observed.

DANGEROUS VOLTAGES ARE PRESENT AT THE FOLLOWING EQUIPMENT:

Receiver-Transmitter RT-77 (*) /GRC-9	425 to 580 volts dc
Dynamotor-Power Supply DY-88/GRC-9	580 volts dc
Dynamotor-Power Supply DY-105 (*) /GRC-9X.....	580 volts dc
Generator, Direct Current G-43/G	425 volts dc

Change }
No. 2 }

HEADQUARTERS
DEPARTMENT OF THE ARMY
Washington, D. C., 23 November 1978

**Operator's Manual
RADIO SETS AN/GRC-87 AND AN/VRC 34**

TM 11-5820 453-10, 10 May 1963, is changed as follows:
Page 3. Paragraph 2 is superseded as follows:

2. Indexes of Publications

a. *DA Pam 310-4.* Refer to the latest issue of DA Pam 310-4 to determine whether there are new editions, changes, or additional publications pertaining to the equipment.

b. *DA Pam 310-7.* Refer to DA Pam 310-7 to determine whether there are modification work orders (MWO's) pertaining to the equipment.

Paragraph 2.1 is superseded as follows:

2.1. Forms and Records

a. *Reports of Maintenance and Unsatisfactory Equipment.* Maintenance forms, records, and reports which are to be used by maintenance personnel at all maintenance levels are listed in and prescribed by TM 38-750.

b. *Report of Packaging and Handling Deficiencies.* Fill out and forward DD Form 6 (Report of Packaging and Handling Deficiencies)

prescribed in AR 700-58 (Army) / NAVSUP PUB 378 (Navy) / AFR 71-4 (Air Force) / and MCO P4030.29 (Marine Corps).

c. *Discrepancy in Shipment Report (DISREP) (SF 361).* Fill out and forward Discrepancy in Shipment Report (DISREP) (SF 361) as prescribed in AR 55-38 (Army) / NAVSUP PUB 459 (Navy) / AFM 75-34 (Air Force) / and MCO P4610.19 (Marine Corps).

Paragraph 2.2 is added after paragraph 2.1.

2.2. Reporting of Equipment Publication Improvements

The reporting of errors, omissions, and recommendations for improving this publication by the individual user is encouraged. Reports should be submitted on DA Form 2028, Recommended Changes to Publications, and forwarded direct to Commander, US Army Electronics Command, ATTN: AMSEL-MA-C Fort Monmouth, NJ 07703.

Page 9. Paragraph 5 is superseded as follows:

This publication has been printed by the UNITED STATES ARMY PUBLICATIONS DISTRIBUTION CENTER, ST. LOUIS, MISSOURI, to meet your needs on a timely basis.

**5. Items Comprising Operable Radio Sets AN/GRC-87 (FSN 5820-543-1997)
and AN/VRC-34 (FSN 5820-543-1996)**

<i>FSN</i>	<i>Quantity</i>	<i>Nomenclature, part No. and mfr code</i>
<i>AN/GRC-87 AN/VRC-34</i>		
NOTE		
The part number is followed by the applicable 5-digit Federal supply code for manufacturers (FSCM) identified in SB 708-42 and used to identify manufacturer, distributor, or government agency, etc.		
5820-243-0432	1	Antenna, AT-101/GRC-9: fixed type; 8 sect; 4.3 to 12 MHz freq. range; 107 ft 6 in. lg o/a (Stored on RL-29 when not in use) (Not installed)
5820-243-1413	1	Antenna AT-102/GRC-9: fixed type; 9 sect; 2 to 4.3 MHz 137 ft lg o/a w/provisions for shorting as required (Stored on RL-29 when not in use) (Not installed) (Not mounted)
6135-669-6632	1	Battery, Dry BA-317/U: Stored in Bag CW-140/GRC-9 (Not installed)
OR		
6135-120-1007	1	Battery, Dry BA-48: Stored in Bag CW-140/GRC-9
NOTE		
Dry batteries shown are used with the equipment but are not considered part of the equipment. They will not be preshipped automatically but are to be requisitioned in quantities necessary for the particular organization in accordance with SB 11-6		
5995-196-9564	1	1 Cord Assembly CD-307-B: (65 in.) 22 awg; 5 ft 10-13/32 in. lg o/a MIL-C-3884; type ne COS-2(22) MS-35760; 96906 (Stored in accessories bag) (Not installed)
5995-164-6457	2	1 Cord assembly, CD-1086 (7 ft): MIL-C-3432 SC-D-22829;80063 (Stored in accessories bag) (Not installed)
5995-162-6946	1	Cord Assembly, CD-119 (36 in): 18 awg; 3 ft 2 in. lg o/a; SC-C-26551; 80063 (Stored in accessories bag) (Not installed) (Not mounted)
5820-237-7321	1	Counterpoise CP-12: radial type; SC-D-1038F; 80063 (Stored on RL-29 when not in use) (Not installed)
5820-224-4885	1	Counterpoise CP-13; radial type; SC-D-1038; 80063 (Stored on RL-29 when not in use) (Not installed)
6125-635-3770	1	1 Dynamotor, Power Supply DY-105/GRC-9X, DY-105A/GRC-9X, DY-105B/GRC-9X; for 24v DC input operation only; SC-DL-177015; 80063 (For 6v or 12v installation substitute Dynamotor Power Supply DY-88/GRC-9 for Dynamotor Power Supply DY-105/GRC-9X, DY-105A/GRC-9X, DY-105B/GRC-9X) (Not mounted)
6125-321-5928	1	1 Dynamotor, Power Supply DY-88/GRC-9 for 6v, 12v or 24v, DC input operation (For 6v or 12v installation may be issued in lieu of DY-105/GRC-9X when DY-105A/GRC-9X is not available for issue) (Not installed) (Not mounted)
6115-501-0611	1	Generator, G-43/G: Hand gen; power output, 425v at 115 ma, 105v at 32 ma 6.3v at 2.5 amp, 1.4v at 0.456 amp, HV-8% variance, LV 2% variance, 50-70 rpm: SM-D-202177; 80063 (Stored in BAG CW-420/G when not in use) (Not installed)
5975-197-4252	1	Guy GY-12: ant. mast guy; 20 ft lg; SC-D-1072; 80063 (Stored in accessories bag) (Not installed)
5975-199-5072	1	Guy GY-42: used w/mast sect; 2 lgth 20 ft lg, SC-D-15884; 80063 (Stored in accessories bag) (Not installed)
5820-493-9361	1	Halyard, M-378: braided cotton; 9/16 in. dia, 80 ft lg: (Stored in accessories bag) (Not installed)
5820-408-3197	1	Halyard, M-379: in braided cotton, 9/64 in. dia 10 ft lg; SC-C-35483; 80063 (Stored in accessories bag) (Not installed)
5965-162-7931	1	1 Headset, electrical H-16/U magnetic, 8000 ohm impedance, SC-D-14618; 80063 (Stored in accessories bag) (Not installed)
5805-171-3370	1	1 Key J-45: 5½ in. lg x 4¼ in. wd x 6 in. h; SC-D-1059; 80063 (Stored in accessories bag) (Not installed)
5965-665-0590	1	1 Loudspeaker LS-203/U: LS-7A; blast proof type; PM field, 8 ohm voice coil, SC-DL-6420; 80063 (Stored in accessories bag) (Not installed)
5820-503-2953	1	1 Mast Base MP-65-B: SC-D-2071; 80063 (Stored in accessories bag) (Not installed)
5820-199-8131	3	3 Mast Section MS-116A: 39½ in lg x 0.393 in. dia; SC-DL-100588-MS1164; 80063 (Stored in accessories bag CW-119/G) (Not installed)
5820-199-8843	1	1 Mast Section MS-117A: 39½ in. lg x 0.373 in. dia; SC-D-12521; 80063 (Stored in accessories bag CW-419/G) (Not installed)
5820-199-8841	1	1 Mast Section MS-118A: 39½ in x 0.246 in. dia; SC-D-12521; 80063 (Stored in accessories bag CW-419/G) (Not installed)

5. Items Comprising Operable Radio Sets AN/GRC-87(FSN 5820-543-1997) and AN/VRC-34 (FSN 58205431996)-Continued

<i>FSN</i>	<i>Quantity</i>	<i>Nomenclature, part No. and mfr code</i>
AN/GRC-87AN/VRC-86		
6625-701-9103	1	1 Meter Field Strength ME-61/GRC: 6 in. lg x 5½ in. w x 5 in h o/a (Stored in accessories bag) (Not installed)
5965-646-4678	1	1 Microphone, Carbon M-52/U: 40-1000 ohms at 1000 Hz; MIL-M-1119313; 81349; w/an end No. 4 (Stored in accessories bag) (Not installed)
5820-196-9041	1	1 Receiver-Transmitter RT-77/GRC-9, RT-77A/GRC-9: vehicular, transportable; xmtr output 2S w cw, 8.5 phone; 2 to 12 MHz in 3 bands; 16½ in lg x 12½ in w x 8 in. h o/a; Sig Spec No. 271-3213; SC-DL-S7596; 80063 (Not installed)
8130-355-7616	1	1 Reel RL-28: for Guy-11 Guy 12; 6½, in Lg x 2¾ in w x 0.747 in. thk; SC-D-1064; 80063 (Stored in accessories bag) (Not installed)
5820-030-2969	3	3 Reel RL-29: for sig counterpoise CP-12 and CP-13; 11½ in lg x 5½ in. w; SC-D-1040; 80063 (Stored in accessories bag) (Not installed)
4020-240-2145	25	25 Rope RP-5: cotton core, 12 strands 3/16 in die 255 lbs min breaking strength (Stored in accessories bag) (Not installed)
4130-223-4612	4	4 Stake, Guy GP-27B: anchors guy; 7 9/16 in lg x 5/16 in dia No. SC-D-1063; 80063 (Stored in accessories bag) (Not installed)
6145-160-S114	10	10 Wire W-128: Single No. 14 AWG cond, stranded, forty-one No. 30 AWG strands (Stored in accessories bag) (Not installed)
GROUP I		
DYNAMOTOR, POWER SUPPLY DY-88/GRC-9		
5995-280-4264	1	1 Cable Assembly, Special Purpose, Electrical CX-2031A/U (8 ft) uses cord CO-212 (Not installed)
6125-219-9988	1	1 Hardware Kit: for mtg DY-88/GRC-9 to vehicle (in cloth bag)
GROUP III		
DYNAMOTOR, POWER SUPPLY		
DY-105/GRC-9X; DY-105A/GRC-9X; DY-105B/GRC-9X		
6125-324-9039	1	1 Hardware Kit: f/mtg Dynamotor-Power Supply to vehicle; c/o lockwasher, nut, bolts in cloth bag; Amictool No. 25095 (in cloth bag)
5995-280-4264	1	1 Cable Assembly Special Purpose, Electrical: CX-2031A/U: (8 ft) uses cordage CO-212 (Not installed)
GROUP III		
RECEIVER TRANSMITTER RT-77/GRC-9; RT-77A/GRC-9		
5995-170-6877	1	1 Cable Assembly Special Purpose, Electrical: Interconnects Rec-xmtr; 23-1/8 in. Lg approx SC-C-3SS01 (installed in equip)
6135-271-0407	1	1 Battery Dry, BA-1293/U: grid bias fv6 p/o rec (Not installed) (Not mounted)
5820-537-3904	1	1 Receiver, Radio: part of RT-77/GRC-9; RT-77A/GRC-9; 10-1/2 in lg x 5-1/8 in. h x 6-1/2 in. d o/a (Installed in case)
5825-309-3200	1	1 Transmitter, Radio: part of RT-77/GRC-9; RT-77A/GRC-9; 10 5/8 in. Lg x 10 3/8 in. wd x 6 1/2 in. d o/a (installed in case)

Paragraph 5.1 is added after paragraph 5.

5.1. Running Spares

<i>FSN</i>	<i>Quantity</i>	<i>Nomenclature, part No. and mfr code</i> <i>RUNNING SPARE ITEMS</i>
5820-243-0432	1	Antenna, AT-101/GRC-9: Fixed type; 8 sect; 4 3 to 12 MHz freq range; 107 ft 6 in. lg o/a (Stored in bag CS419)
5820-199-8131	3	Mast Section MS-116A: 39 1/2 in. lg x 0.393 in. dia; SC-DL-100588; 80063 (Stored in bag CW 419/G)
5820-199-8843	1	Mast Section MS-117A: 39 1/2 in. lg x 0.373 in. dia; SC-D-12S21; 80063 (Stored in bag CW 419/G)
5820-199-8841	1	Mast Section MS-118A: 39 1/2 in. lg x 0.246 in. dia; SC-D-12S21; 80063 (Stored in bag CW 419/G)
RADIO SET AN/VRC-34		
5820-199-8131	3	Mast Section MS-116A: 39 1/2 in. lg x 0.393 in. dia; SC-DL-100588; 80063 (Stored in bag CW419/G)
5820-199-8843	1	Mast Section MS-117A: 39 1/2 in lg x 0.373 in. dia; SC-D-12S21; 80063 (Stored in bag CW419/G)
5820-199-8841	1	Mast Section MS-118A: 39 1/2 in. lg x 0.246 in. dia; SC-D-12S21; 80063 (Stored in bag CW4 19/G)
DYNAMOTOR, POWER SUPPLY DY-88/GRC-9		
5920-280-8604	5	Fuse, Cartridge: 2 amp MIL type FO8G2R00B OR
5920-280-3171	3	Fuse, Cartridge: 5 amp F08DS R00A.
5920-280-3157	3	Fuse, Cartridge: 10 amp 32v; Buss type MDR-10-D-E
5920-399-7760	3	Fuse, Cartridge: 20 amp 32v; Buss type MDR-20-D-E
5920-280-3177	3	Fuse, Cartridge: 30 amp 32v; Buss type MDR-30-D-E
DYNAMOTOR, POWER SUPPLY DY-105/GRC-9X; DY-105A/GRC-9X; DY-105B/GRC-9X		
5920-142-7346	4	Fuse, Cartridge: 3 amp Buss type AGU-3
5920-280-3157	4	Fuse, Cartridge: 10 amp MIL type F07A10R0B RECEIVER, RADIO (FSN5820-S37-3904)
6240-155-8683	1	Lamp, Incandescent: 2v, 0.06 amp min bayonet base; GE No. S-49 TRANSMITTER, RADIO (FSN 5825-309-3200)
6240-155-8683	1	Lamp, Incandescent: 2 v, 0.06 amp min bayonet base; GE S-49
6240-299-6970	1	Lamp, Glow: GE No. NE-47

APPENDIX II BASIC ISSUE ITEMS LIST

Section 1. INTRODUCTION

1. Scope

This appendix lists basic issue items required by the crew/operator for operation, and maintenance of Radio Sets AN/GRC-87 and AN/VRC-34.

2. General

This basic issue items list is a list, in alphabetical sequence, of items which are furnished with, and which must be turned in with the end item.

3. Explanation of Columns

The following provides an explanation of columns found in the tabular listings:

a. Illustration. This column is divided follows:

(1) *Figure number.* Indicates the figure number of the illustration in which the item is shown.

(2) *Item number.* Not applicable.

b. Federal Stock Number. Indicates the Federal stock number assigned to the item and will be used for requisitioning purposes.

c. Part Number. Indicates the primary number used by the manufacturer (individual, company, firm, corporation, or Government activity). which controls the design and characteristics of the item by means of its engineering drawings, specifications standards, and inspection requirements, to identify an item or range of items.

d. Federal SUPPY Code for Manufacturer (FSCM). The FSCM is a 5-digit numeric code used to identify the manufacturer, distributor, or Government agency, etc., and is identified in SH 708 42.

e. Description. Indicates the Federal item name and a minimum description required to identify the item.

f. Unit of Measure (U/M). Indicates the standard of basic quantity of the listed item as used in performing the actual maintenance function. This measure is expressed by a two-character alphabetical abbreviation, (e.g., ea. in., pr, etc.). When the unit of measure differs from the unit of issue, the lowest unit of issue that will satisfy the required units of measure will be requisitioned.

g. Quantity Furnished with Equipment (Basic Issue Items Only). Indicates the quantity of the basic issue item furnished with the equipment.

4. Special Information

Usable on codes are included in column 5. Uncoded items are applicable to all models. Identification of the usable on codes are as follows:

<i>Code</i>	<i>Used on</i>
1	AN/GRC-87
2	AN/VRC-34

Section II. BASIC ISSUE ITEMS LIST

(1) Illustration		(2)	(3)	(4)	(5)	(6)	(7)
(A) Fig. No.	(B) Item No.	Federal stock number	Part number	FSC M	Description Usable on code	Unit of meas.	Qty furn with equip
1,2		5820-308-5817			BAG CW-140/GRC-9: for carrying Receiver and Transmitter RT-77/GR-9 wp canvas; 14 in. lg x 14 in w x (Not installed) (Not mounted)	EA	1
1,2		5820-690-8541	SC-DL-31963	80063	BAG, COTTON DUCK, CW-419/GRC-9: 65-1/2 in. lg x 33 in. w w/approx. dim opened; 4 flap type and fixed type pockets (Replaces Roll BG-174 in AN/ GRC-9) (Not installed) (Not mounted)	EA	1
1		6115-709-0463	SC-DL-17336	80063	BAG,CW-420/G: for generator 1 15 1/2 in. lg x 6 1/2 in. w x 11 3/4 in. h o/a olive drab water repellent (Not mounted)	EA	1
1		5820-701-9097	SC-DL-74923	80063	BOX BX-53 D: (Stores in Bag CW-140/GRC-9 (Not installed)	EA	1
1		5820-129-9666		80063	BRACKET FT-515: used to mount Insulator IN-127: 6 1/2in. lg x 1 in. wd x 1/8 in. thk (Stored in accessories bag) (Not installed)	EA	1
1		5965-243-0207	MIL-H-11190	81349	COVER, MICROPHONE CW-292-W: 1.218 in. lg x 0.671 in. h x 0.605 in. dia; polyethylene (Stored in accessories bag)	EA	1
1		5970-227-8226	SC-DL-35528	80063	INSULATOR IN-127: cylindrical molded phenolic; 12-21/ 32 in. lg, (Stored In accessories bag) (Not installed)	EA	1
1		5970-197-3576	SC-D-1134	80063	INSULATOR, STRAIN IN-86: Stored in accessories bag (Not installed)	EA	1
		5820-128-2207	SC-C-20701		MOUNTING MT-350/GRC-9: 16-5/8 in. lg x 11-9/16 in. w x 1-5/8 in. h (Not installed)	EA	1
3		5820-545-8234	SC-D-35818	80063	GROUP III RECEIVER TRANSMITTER RT-77/GRC-9; RT-77A/GRC-9 CABINET: houses rec end xmtr; 15-1/2 in. lg x 10-1/2in.wd x 4 9/32 in. h approx o/a (Not installed)	EA	1
3		5820-691-2059			PANEL, COVER CW-109/GRC: water tight metal cover f/RT-77(*)/GRC-9; 11-1/2 in. lg x 16 1/2 in. wd w/3 in. fl (Mounted in equip)	EA	1
		5970-197-3576	SC-1134		RUNNING SPARE ITEMS RADIO SET AN/GRC-87 AND AN/VRC-34 INSULATOR, STRAIN IN-86: (Stored in Bag CW-419/G)	EA	2

By Order of the Secretary of the Army:

CREIGHTON W. ABRAMS
General, United States Army
Chief of Staff

Official:

VERNE L. BOWERS
Major General, United States Army
The Adjutant General

Distribution:

To be distributed in accordance with DA Form 12-51 operator maintenance requirements for AN/GRC 87 and AH/VRC 34.

U.S. GOVERNMENT PRINTING OFFICE: 1973-7681 11/685

HEADQUARTERS

DEPARTMENT OF THE ARMY

Washington, D. C., 16 November 1967

CHANGE }
No. 1 }

OPERATOR'S MANUAL

RADIO SETS AN/GRC 87 and AN/VRC 34

TM 11-5820-453-10, 10 May 1963, is changed as follows:

Page 3. Make the following changes:

Delete paragraph 2 and substitute:

2. Index of Publications

Refer to the latest issue of DA Pam 310-4 to determine whether there are new editions, changes, or additional publications pertaining to the equipment.

Add paragraph 2.1 after paragraph 2.

2.1 Forms and Records

a. *Reports of Maintenance and Unsatisfactory Equipment.* Use equipment forms and records in accordance with instructions in TM 38-750.

b. *Report of Packaging and Handling Deficiencies.* Fill out and forward DD Form 6 (Report of Packaging and Handling Deficiencies) as prescribed in AR 700-58 (Army), NAVSUP

Publication 378 (Navy) AFR 71-4 (Air Force), and MCOP4610-5 (Marine Corps).

c. *Discrepancy in Shipment Report (DISREP) (SF 361).* Fill out and forward Discrepancy in Shipment Report (DISREP) (SF 361) as prescribed in AR 55-38 (Army), NAVSUP Pub 459 (Navy), AFM 75-34 (Air Force), and MCO4610.19 (Marine Corps).

d. *Reports of Equipment Manual Improvements.* Reporting of errors, omissions, and recommendations for improving this publication by the individual user is encouraged. Reports should be submitted on DA Form 2028 (Recommended Changes to DA Publications) and forwarded direct to Commanding General, U. S. Army Electronics Command, ATTN: AMSEL. NMP-CR, Fort Monmouth, N.J., 07703.

Page 44. Delete appendix I and substitute:

This publication has been printed by the UNITED STATES ARMY PUBLICATIONS CENTER, ST. LOUIS, MISSOURI, to meet your needs on a timely basis.

**APPENDIX I
REFERENCES**

DA Pam 310-4	Index of Technical Manuals, Technical Bulletins, Supply Manuals (types 7, 8 and 9), Supply Bulletins, and Lubrication Order
DA Pam	Index of Modification Work Orders
TB SIG 109	Headset H-16/U
TB SIG 330	Microphone M-52/U and M-52A/U
TM 10-500-10	Airdrop of Supplies and Equipment: Rigging 1/4-ton Utility Trucks
TM 11-5070	Power Supplies P-327/GRC-9Y, PP-327A/GRC-9Y, and PP-327B/GRC-9Y
TM 11-5122	Direct Current Generator G-43/G
TM 11-5820-479-12P	Operator and Organizational Maintenance Repair Parts and Special Tools List and Maintenance Allocation Chart: Mast Base MP-65, MP-65A and MP-65B
TM 11-5965-212-15P	Operator, Organizational, Field and Depot Maintenance Repair Parts and Special Tools List and Maintenance Allocation Chart: Microphone M-52/U and M-52A/U
TM 11-5965-213-15P	Maintenance Repair Parts and Special Tools List and Maintenance Allocation Chart for Permanent Magnet Loudspeaker LS-203/U (including LS-7 and LS-7A)
TM 11-5965-267-15P	Operator, Organizational, Field and Depot Maintenance Repair Parts and Special Tool List: Headset, Electrical H-16/U
TM 38-750	Army Equipment Record Procedures

Page 46, appendix II, section II. Add the following item in the columns indicated below:

FEDERAL STOCK NUMBER column:
5820-701-9097

DESIGNATION BY MODEL column, subcolumn 1 and 2:

DESCRIPTION column: BOX BX-53-D: Sig
dwg SC-DL-74923

Note: Stored in Bag CW-140/GRC-9
(Not Installed)

QTY AUTH column: 1

By Order of the Secretary of the Army:

HAROLD K. JOHNSON
General, United States Army
Chief of Staff

Official: _____

KENNETH G. WICKHAM
Major General, United States Army,
The Adjutant General.

Distribution:

To be distributed in accordance with DA Form 12-51 (Unclas) requirements for Organizational maintenance, AN/GRC-87 and AN/VRC-34 Radio Sets.



RADIO SETS AN/GRC-87 AND AN/VRC-34

		Paragraph	Page
CHAPTER 1.	INTRODUCTION		
Section I.	General		
	Scope.....	1	3
	Forms and records	2	3
II.	Description and data.....		
	Purpose and use	3	3
	Technical characteristics.....	4	8
	Table of components	5	9
	Description.....	6	13
	Additional equipment required	7	14
	Differences in models	8	17
CHAPTER 2.	OPERATING INSTRUCTIONS		
Section I.	Operator's controls and indicators		
	Transmitter subassembly of RT-77 (*)/GRC-9.....	9	18
	Receiver subassembly of RT-77 (*)/GRC-9	10	22
	Dynamotor-Power Supply DY-88/GRC-9.....	11	23
	Dynamotor-Power Supply DY-105 (*)/GRC-9X.....	12	24
	Meter, Field Strength ME-61/GRC	13	25
II.	Operation under usual conditions		
	Types of operation.....	14	26
	Power supply preliminary starting procedure.....	15	26
	Receiver-transmitter starting procedure.....	16	27
	Receiver operation.....	17	27
	Transmitter dial setting procedure.....	18	28
	Transmitter operation	19	30
	Net operation.....	20	33
	Antijamming	21	33
	Stopping procedure.....	22	33

*This manual supersedes so much of TM 11-263, 20 June 1956¹ including C1, 15 October 1957; C2, 29 April 1960; C3, 15 November 1960; C4, 21 December 1961; C5, 23 November 1962, and C6, 17 April 1963, as pertain to the operation of subject equipment.

	Paragraph	Page
III.	Operation under unusual conditions	
	General	23 34
	Operation in arctic climates	24 34
	Operation in tropical climates	25 34
	Operation in desert climates	26 34
CHAPTER 3.	MAINTENANCE INSTRUCTIONS	
	Scope of maintenance	27 35
	Tools required for maintenance	28 35
	Preventive maintenance.....	29 35
	Maintenance service and inspection periods.....	30 35
	Daily maintenance service and inspection chart	31 36
	Cleaning.....	32 41
	Removal and replacement procedures.....	33 42
CHAPTER 4.	AUXILIARY EQUIPMENT	
	Purpose of auxiliary equipment.....	34 43
	Power Unit PE-162-(*)	35 43
	Power Supply PP-327(*)/GRC-9Y	36 43
CHAPTER 5.	DEMOLITION OF MATERIAL TO PREVENT ENEMY USE	
	Authority for demolition	37 43
	Methods of destruction	38 43
APPENDIX I.	REFERENCES	44
II.	BASIC ISSUES ITEMS LIST	45

CHAPTER 1

INTRODUCTION

Section I. GENERAL

1. Scope

a. This manual describes Radio Sets AN/GRC-87 and AN/VRC-34 (fig 1 and 2) and covers operation and operator's maintenance. It includes operation under usual and unusual conditions, cleaning and inspection of the equipment, and replacement of parts available to first echelon maintenance.

b. Official nomenclature followed by (*) is used to indicate all models of the equipment item covered in this manual. Thus, Receiver-Transmitter RT-77 (*)/GRC-9 represents Receiver-Transmitters RT-77/GRC-9 and RT77A/GRC-9; Dynamotor-Power Supply DY105 (*)/GRC-9X (power supplies) represents Dynamotor-Power Supplies DY-105/GRC-9X, DY-105A/GRC-9X, and DY-105B/GRC-9X; Power Units PE-162-(*) represents PE-162A, PE-162-B, and PE-162-C; Power Supply PP-327 (*)/GRC-9Y represents Power Supplies PP-327/GRC-9Y, PP-327A/GRC-9Y, and PP-327B/GRC-9Y.

2. Forms and Records

a. *Report of Maintenance and Unsatisfactory Equipment.* Use equipment forms and records in

accordance with instructions in TM 38-750.

b. *Report of Damaged or Improper Shipment.* Fill out and forward DD Form 6 (Report of Damaged or Improper Shipment), as prescribed in AR 700-58 (Army), NAVSAN-DA Publication 378 (Navy), and AFR 71-4 (Air Force).

c. *Comments on Manual.* Forward all comments on this publication direct to: Commanding Officer, U. S. Army Electronics Material Support Agency, ATTN: SELMS-MP, Fort Monmouth, New Jersey, (DA Form 1598 (Record of Comments on Publications), DA Form 2496 (Disposition Form), or letter may be used.)

d. *Index of Publications.* Refer to the latest issue of DA PAM 310-4 to determine whether there are new editions, changes, or additional publications pertaining to your equipment. Department of the Army Pamphlet No. 310-4 is a current index of Technical Manuals, Technical Bulletins, Supply Bulletins, Lubrication Orders, and Modification Work Orders that are available through publications supply channels. The index lists the individual parts (-10, -20, -35P, etc.) and the latest changes to and revisions of each equipment publication.

Section II. DESCRIPTION AND DATA

3. Purpose and Use

a. The radio sets covered in this manual provide low-power, short-range (10- to 30-mile) communications capable of transmitting and receiving radio signals in the frequency range of 2 to 12 megacycles (mc). Each radio set can transmit and receive (not simultaneously) continuous-wave (cw), modulated continuous-wave (mcw), and amplitude-

modulated (am.) radio signals.

b. The AN/GRC-87 (fig. 1) may be used for ground (man-transportable) or vehicular installations. The radio set may be operated as an isolated unit or in a net group.

c. The AN/VRC-34 (fig. 2) is installed and operated in a vehicle and may be operated as an isolated unit or in a net group

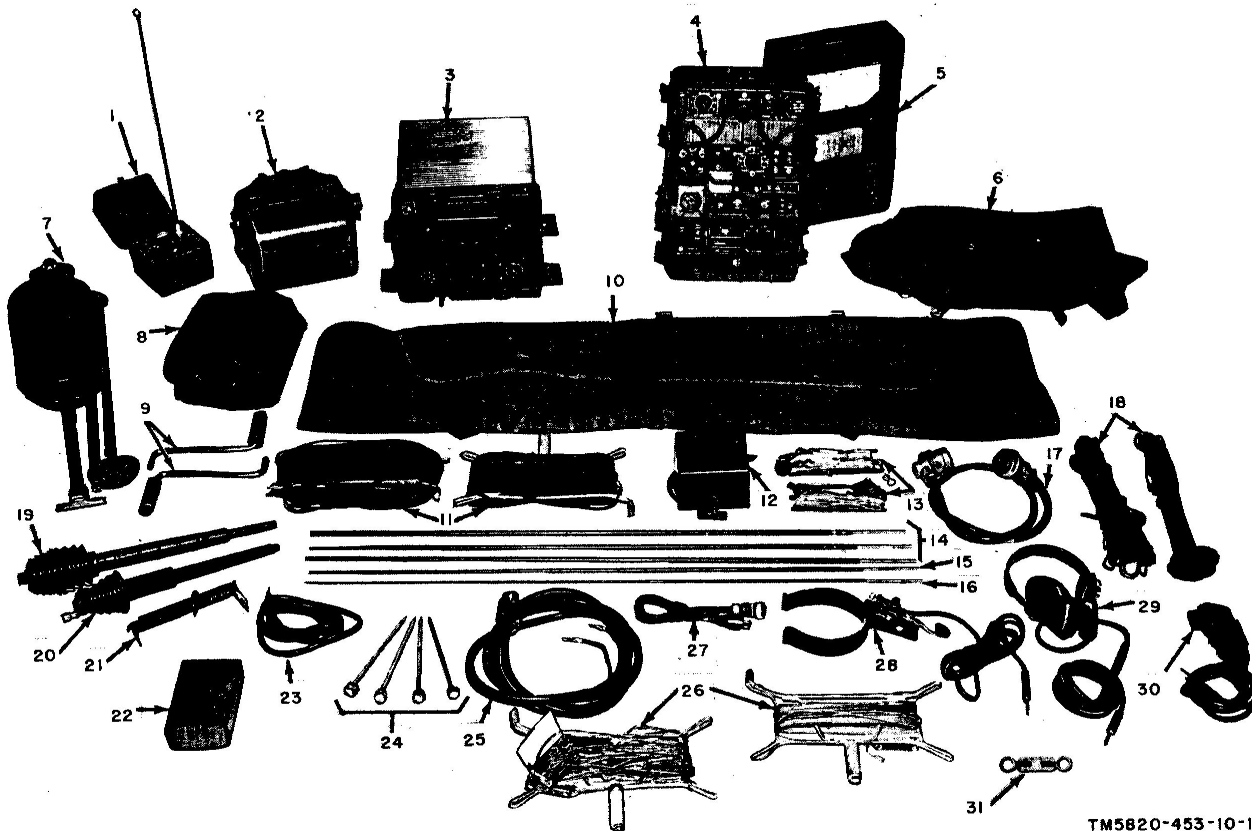

TM5820-453-10-14

Figure 1. Radio Set AN/GRC-87.

- 1 Meter, Field Strength ME-61/GRC
- 2 Generator, Direct Current G-43/G
- 3 Dynamotor-Power Supply DY-105 (*) GRC-9X (or DY-88/GRC-9)
- 4 Receiver-Transmitter RT-77 (*) /GRC-9 and Mounting MT-350/GRC-9 (hidden)
- 5 Panel Cover CW-109/GRC-9
- 6 Bag CW-140/GRC-9
- 7 Tripod MT-1643/U (p/o G-43/G)
- 8 Bag, Cotton Duck CW-420/G
- 9 Crank, Hand GC-7 (p/o G-43/G)
- 10 Bag, Cotton Duck CW-419/GRC-9
- 11 Counterpoise CP-12 and CP-13
- 12 Loudspeaker LS-203/U (or LS-7A)
- 13 Guy GY-12 and GY-42
- 14 Mast Sections MS-116A
- 15 Mast Section ME-117A
- 16 Mast Section MS-118A
- 17 Cord CD-1086
- 18 Halyard M-378 and M-379
- 19 Mast Base MP-65-B
- 20 Insulator IN-127
- 21 Bracket FT-515
- 22 Battery, Dry BA-317/U
- 23 Wire W-128
- 24 Stake, Guy GP-27B
- 25 Cable Assembly, Special Purpose, Electrical CX-2031A/U
- 26 Antennas AT-101/GRC-9 and AT-102/GRC-9
- 27 Cord CD-1119
- 28 Key J-45
- 29 Headset H-16/U
- 30 Microphone, Carbon M-52/U
- 31 Insulator, Strain IN-86

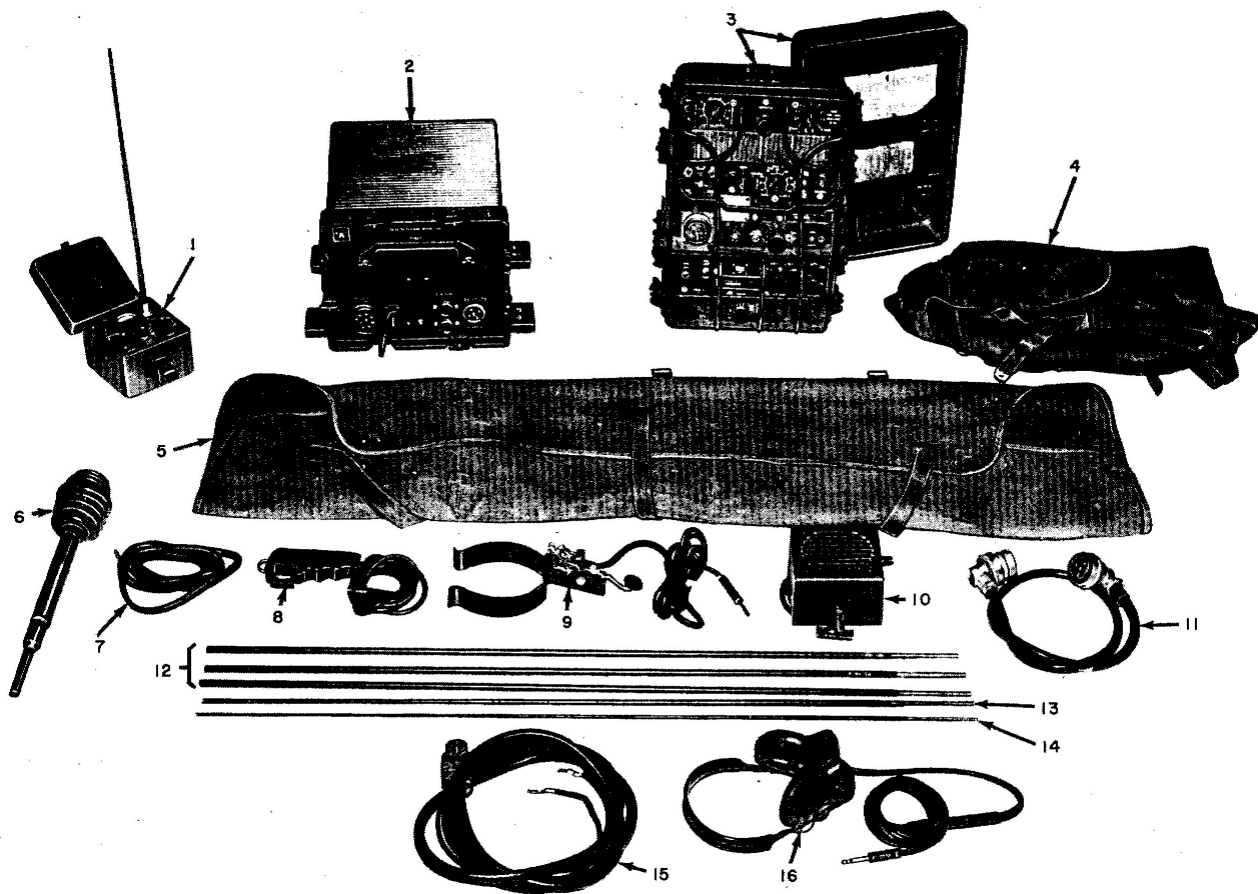

Figure 2. Radio Set AN/VRC-84.

TM5820-453-10-15

- 1 Meter, Field Strength ME-61/GRC
- 2 Dynamotor-Power Supply DY-105 (*) GRC-9X (or DY-88/GRC-9)
- 3 Receiver-Transmitter RT-77 (*) /GRC-9 and Panel Cover CW-109/GRC and
Mounting MT-350/GRC-9 (hidden)
- 4 Bag CW-140/GRC-9
- 5 Bag, Cotton Duck CW-419/GRC-9
- 6 Mast Base MP-65-B
- 7 Wire W-128
- 8 Microphone, Carbon M-52/U
- 9 Key J-45
- 10 Loudspeaker LS-203/U (or LS-7A)
- 11 Cord Assembly CD-1086
- 12 Mast Sections MS-116A
- 13 Mast Section MS-117A
- 14 Mast Section MS-118A
- 15 Cable Assembly, Special Purpose, Electrical CX-2031A/U
- 16 Headset H-16/U

4. Technical Characteristics

a. Receiver-Transmitter RT-77 (*) /GRC-9.

Frequency range:

Band 1	6.6 to 12mc.
Band 2	3.6 to 6 mc.
Band 3	2.0 to 3.6mc.

Transmitter:

Type of modulation	Amplitude .
Type of transmission	Cw, mcw, and am. (voice).
Type of control.....	Crystal or master-oscillator power amplifier.

Distance range:

Cw signals:

Ground operation	30 miles. ¹
Vehicular operation	15 miles. ¹

Mcw signals

Ground operation	20 miles. ¹
Vehicular operation	10 miles. ¹

Am. signal:

Ground operation	15 miles. ¹
Vehicular operation	10 miles. ¹

Power output:

Cw operation	15 watts, depending on frequency, antenna, and power supply.
Am. (voice) or mcw operation	7 watts, depending on frequency, antenna and power supply

Antennas:

Ground operation	Whip or long wire.
Vehicle operation	Whip.

Number of tubes 5.

Receiver:

Receiver type	Am, superheterodyne.
Types of signals received	Cw, mew, and am. (voice).
Intermediate frequency	456 kc.
Method of calibration	Built-in crystal frequency calibrator.
Calibration points	Every 200 kc.
Number of tubes.....	7.
Antenna	Same as transmitter.

Power supply:

Vehicle installation (AN/GRC-87 and AN/VRC-34) Dynamotor-Power Supply DY-88/GRC-9 (used with a 6-, 12-, or 24-volt vehicle battery) or Dynamotor-Power Supply DY-105 (*) /GRC-9X (used with a 24-volt vehicle battery).

Ground (man-transportable)

installation (AN/GRC-87) Generator, Direct Current G-43/G and Battery, Dry BA-317/U.

b. Dynamotor-Power Supply DY-88/GRC-9.

Supply requirements:

Transmitter operation (high or low power):

6-volt vehicle battery,	high power	22.2 amperes;
	low power	20 amperes.
12-volt vehicle battery,	high power	12.2 amperes;
	low power	11.1 amperes.
24-volt vehicle battery,	high power	6.7 amperes;
	low power	6.1 amperes.

¹ These values are approximations, since the range will vary considerably with terrain, frequency, and atmospheric conditions.

Receiver operation (standby):

6-volt vehicle battery	1.25 amperes.
12-volt vehicle battery	0.8 amperes.
24-volt vehicle battery	0.6 amperes.

Output power:

Transmitter pa screen and plate power	580 volts dc at 0.1 ampere.
Transmitter filaments	6.3 volts dc at 2 amperes.
Receiver and low level tr ansmitter screen and plate power	105 volts dc at 0.045 ampere.
Receiver filaments	1.4 volts dc at 0.5 ampere.
Keying relay	6.3 volts dc at 0.575 ampere.
Standby receiver plates	105 volts dc at 0.017 ampere.

c. *Dynamotor-Power Supply DY-105(*)/GRC-9X.*

Supply requirements:

Transmitter operation (high and low power), 24-volt vehicle battery, high power	6.7 amperes;
low power	6.1 amperes.
Receiver operation (standby), 24-volt vehicle battery	0.6 amperes.

Output power:

Transmitter pa screen and power plate	580 volts dc at 0.1 ampere.
Transmitter filaments	6.3 volts dc at 2 amperes
Receiver and low level transmitter screen and plate power	105 volts dc at 0.045 ampere.
Receiver filaments	1.4 volts dc at 0.5 ampere.
Keying relay	6.3 volts dc at 0.575 ampere.
Standby receiver plates	105 volts dc at 0.017 ampere.

d. *Generator, Direct Current G-43/G.*

Supply requirements Hand-operated.

Full-load output:

Transmitter output:	
Plate power	425 volts at 0.115 ampere.
Filament power	6.3 volts at 2.5 ampere.
Receiver output:	
Plate power	105 volts at 0.032 ampere
Filament power	1.4 volts at 0.465 ampere.

Total power output	85 watts (approximate).
Cranking speed	50 to 70 rpm

e. *Meter, Field Strength ME-61/GRC.*

Frequency range:

Band 3	1.5 to 4 mc.
Band 2	4 to 10 mc.
Band 1	0 to 24 mc.

5. Table of Components

The components of the AN/GRC-87 and the AN/VRC-34 are listed in the basic issue items

list (appx II) and illustrated in figures 1 and 2

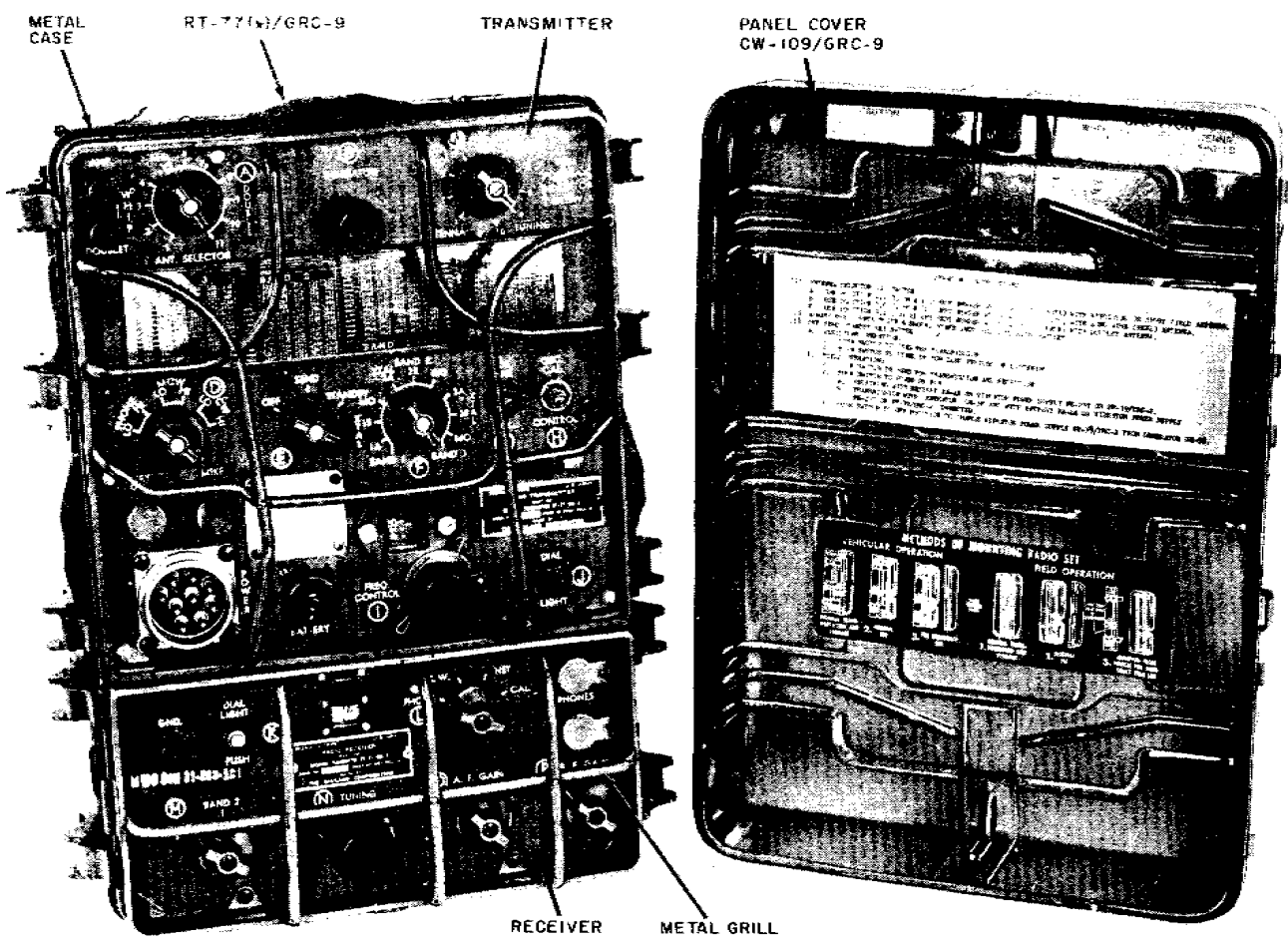
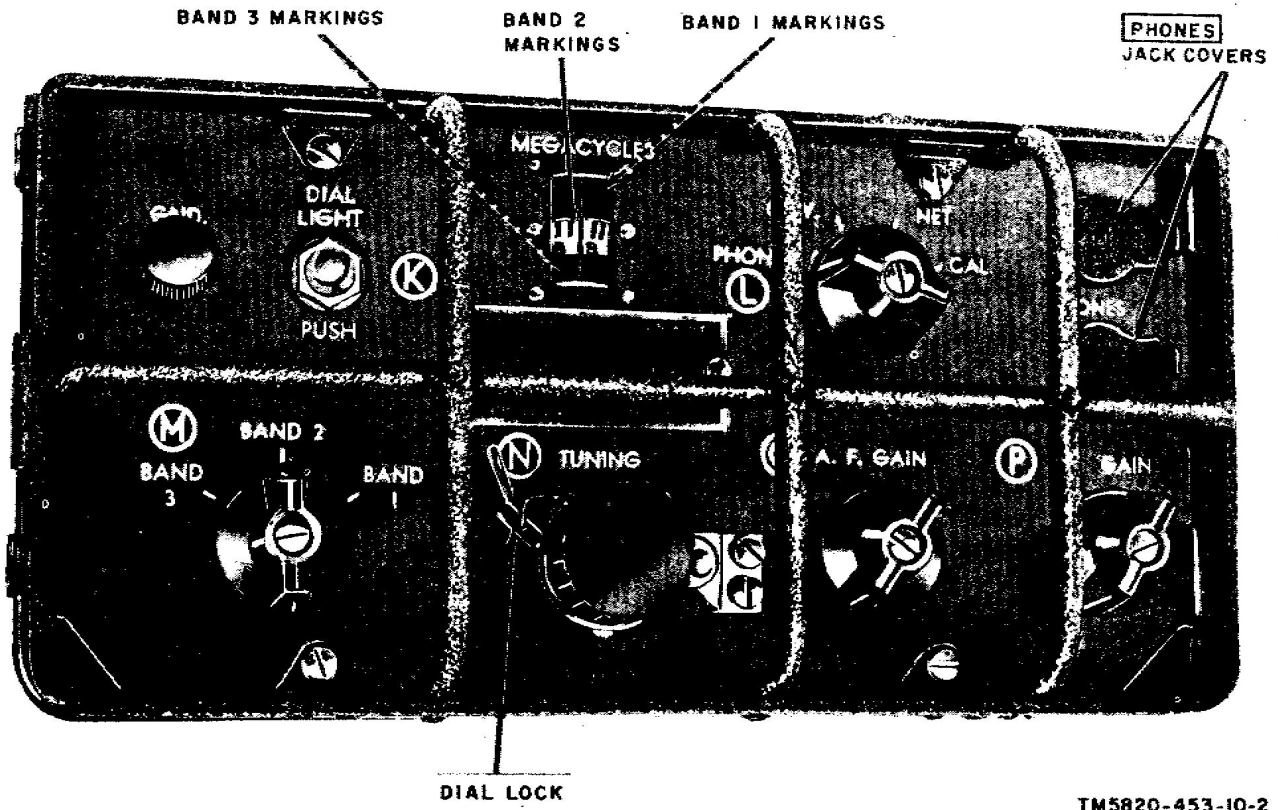

Figure 3. Receiver-Transmitter RT-77/GRC-9 and Panel Cover CW-109/GRC



TM5820-453-10-2

Figure 4. RT-77/GRC-9, receiver subassembly.

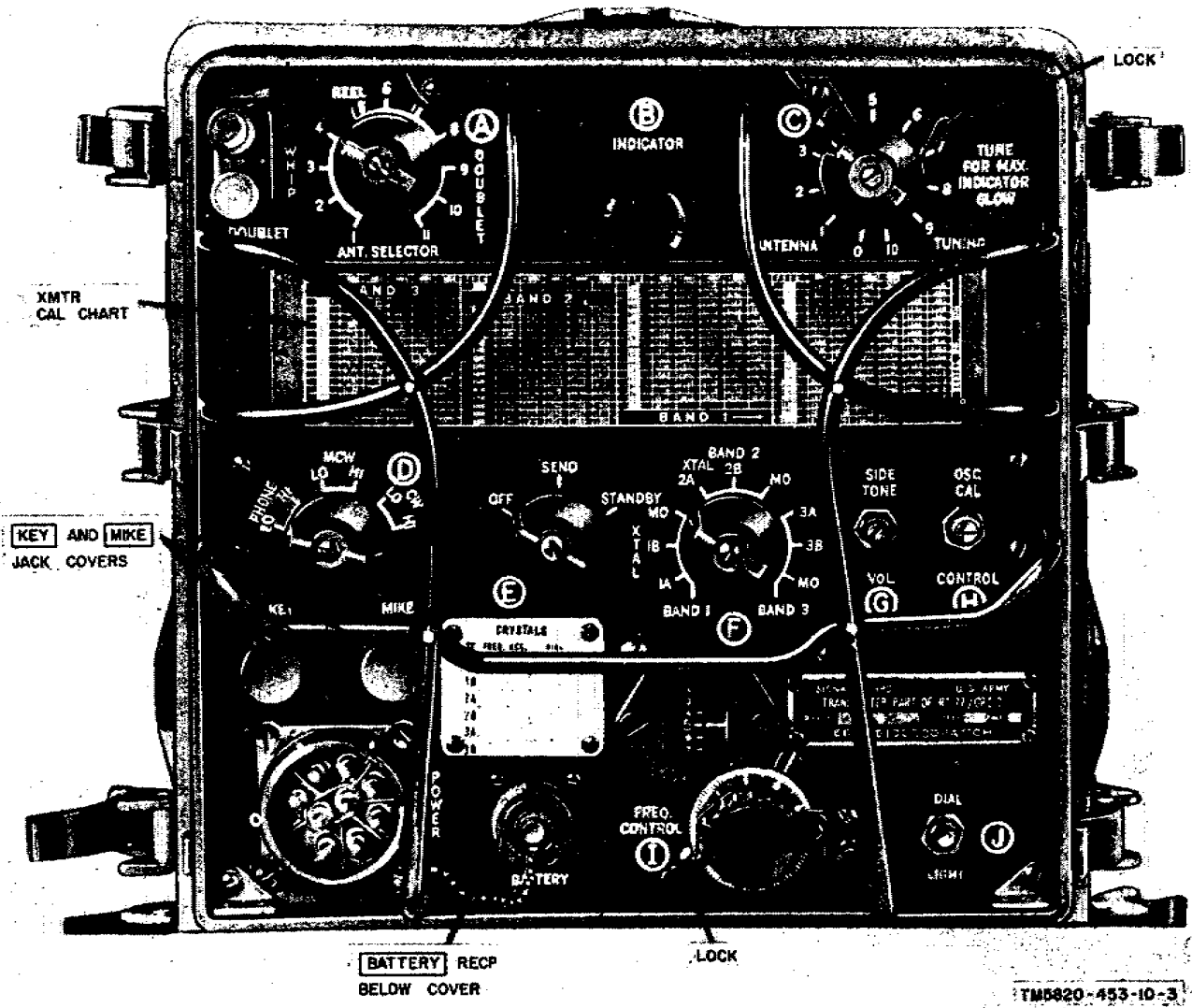

Figure 5. RT-77/GRC-9, transmitter subassembly.

6. Description

a. RT-77()/GRC-9.* The RT-77(*)-GRC-9 (fig. 3) is common to both the AN/GRC-87 and the AN/VRC-34. It consists of a receiver (fig. 4) and a transmitter (fig. 5) subassembly mounted in a metal case, which has a removable waterproof dust cover (CW-109/GRC-9). A metal grill protects the controls, binding posts, and connectors on the front panel of the subassemblies. The following items are located at the rear of the receiver-transmitter subassemblies.

- (1) Interconnecting power cable and connectors.
- (2) IMPEDANCE control on the receiver subassembly.

b. Power Supplies. The various power supplies of the radio sets are described below:

- (1) Dynamotor-Power Supplies DY-88/GRC-9 and DY-105(*)/GRC-9 (fig. 6 and 7) are part of the AN/GRC-87 and the AN/VRC-34. They are mounted in reinforced waterproof covers equipped with shock-mounted fittings through which bolts can be passed for vehicular mounting.
- (2) Generator, Direct Current G-43/G (generator) consists of a generator unit, handcranks (GC-7), and a tripod (MT-1643/U). The generator unit is housed and shock-mounted

in a waterproof aluminum case. The tripod attaches to the bottom of the aluminum case and has two tubular legs and one rectangular leg that has a seat attached to it. For further information refer to TM 11-5122.

c. Antennas. The antennas of the radio sets are described below:

- (1) The AT-101/GRC-9 (part of the long-wire antenna) (fig. 1) is part of the AN/GRC-87. It is made of stranded copper wire, 107½ feet long, and is sectionalized by eight ceramic insulators and eight sets of jumpers.
- (2) The AT-102/GRC-9 (part of the long-wire antenna) (fig. 1) is part of the AN/GRC-87. It is made of stranded copper wire, 137 feet long, and is sectionalized by eight ceramic insulators and eight sets of jumpers.
- (3) Mast Sections MS-116A, MS-117A, and MS-118A are part of the AN/GRC-87 and the AN/VRC-34. These mast sections are part of a whip antenna and are made of metal tubing with threaded ends.

d. Field Strength Meter. Meter, Field Strength ME-61/GRC (fig. 8) is part of the AN/GRC-87 and AN/VRC-34. It is portable and is housed in a metal case, which is waterproof when the cover is closed.

7. Additional Equipment Required

The following equipment is not supplied as part of, but is needed for use with, the radio sets:

a. Vehicular Storage Battery. A 6-, 12-, or 24-volt battery is required for use with Dynamotor-Power Supply DY-88/GRC-9 and a 24-volt battery is required for use with Dynamotor-Power Supply DY-105 (*) /GRC-9.

b. Frame FM-85. A frame mounting such as FM-85 is required for vertical mounting of the RT-

77(*)/GRC-9 in a vehicle.

c. Mast Bracket MP-50. The mast bracket is required when the radio set is mounted in a vehicle and Mast Base MP-65-B is to be used.

d. Oscillating Crystals. Crystal Unit CR-8/U, covering a frequency range from 1,000 kilocycles (kc) to 6,000 kc, is required when the transmitter of the RT-77 (*) /GRC-9 is crystal-controlled. (Stock numbers of the available crystals are listed in SB 11-474.)

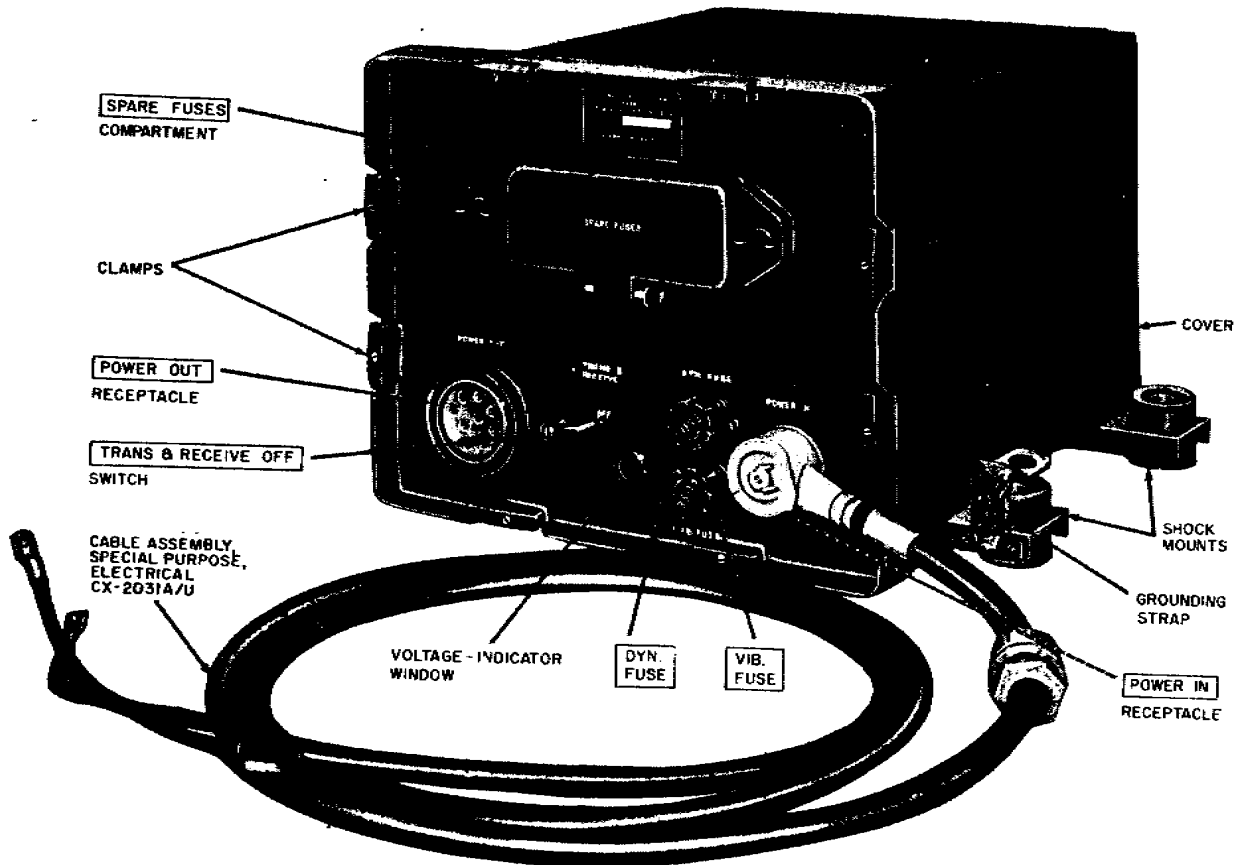

Figure 6. Dynamotor-Power Supply DY-88/GRC-9

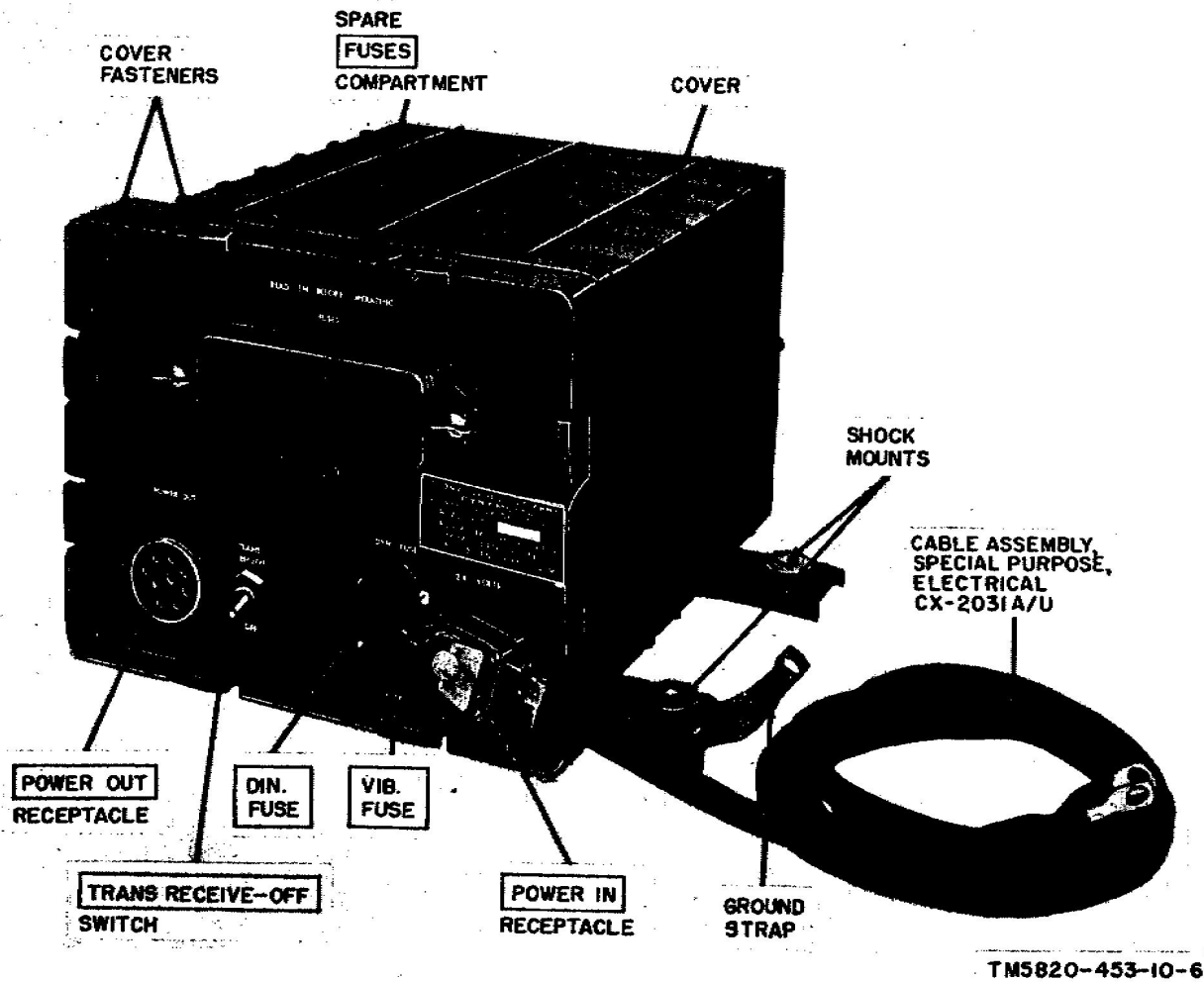

Figure 7. Dynamotor-Power Supply DY-105/GRC-9X.

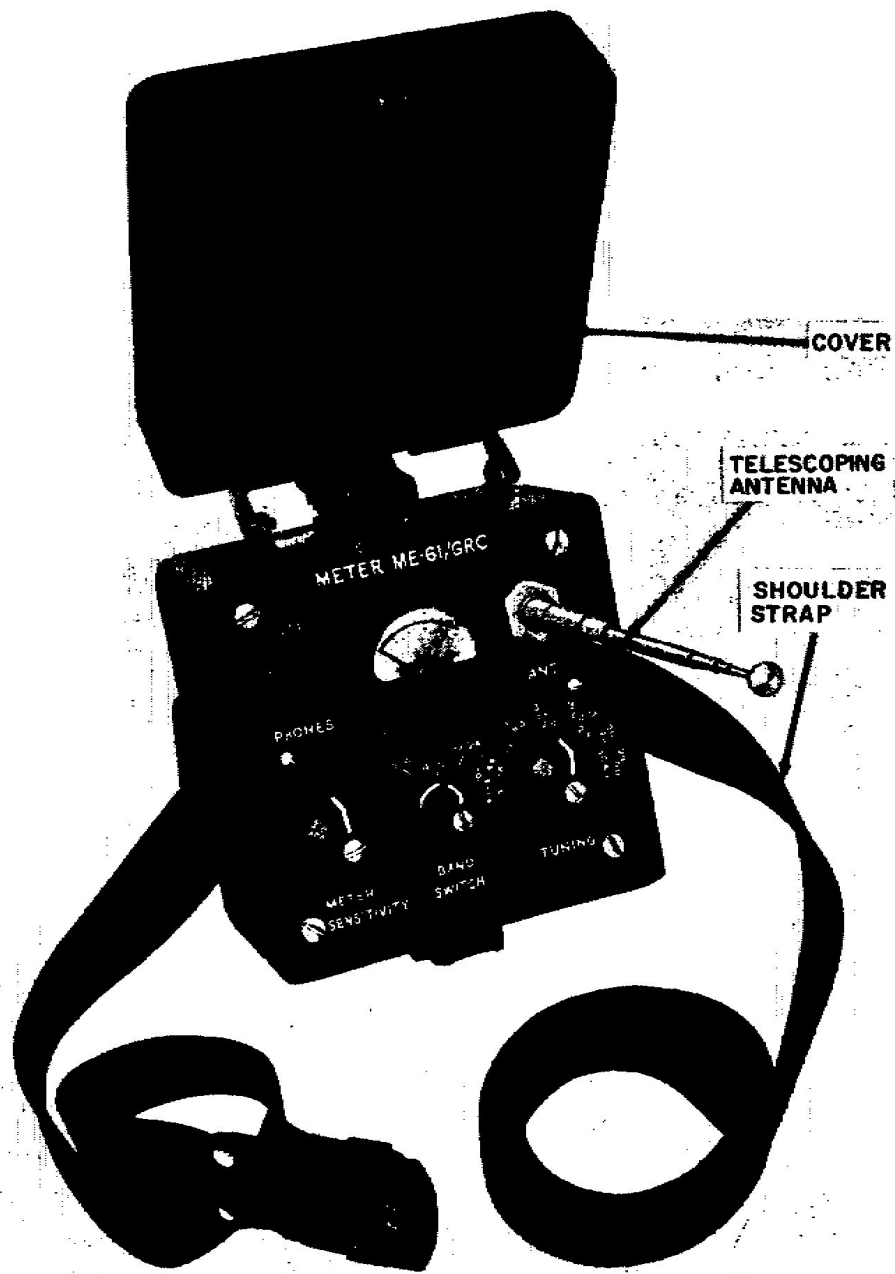

Figure 8. Meter, Field Strength ME-61/GRC.

8. Differences in Models

a. Radio Set AN/GRC-87 is similar to Radio set AN/VRC-34 except for power supplies and antennas issued and certain modifications to improve operational features. The differences are listed below:

b. Receiver-Transmitter RT-77 (*) /GRC-9. The models of the RT-77 (*) /GRC-9 (receiver-transmitter) are similar in appearance, purpose, and operation, but differ as follows:

- (1) The RT-77/GRC-9 has a wired-in type of bias cell, and the RT-77A/ GRC-9 has a

new type of cell holder that permits the use of a plug-in bias cell battery (BA-1293/U).

- (2) A lock is provided on some models to prevent control C (fig. 9), on the front panel of the transmitter subassembly, from detuning the radio set.
- (3) The various models have some small changes in component values and circuit configurations

c. Dynamotor-Power Supply DY-105(*)/GRC-9. All models of the DY-105(*)/GRC-9X are similar in appearance, purpose, and operation; however, minor part-value differences exist.

Control or indicator	Panel letter	Function
Oscillator-band switch	(F)	Nine-position rotary switch. <i>Sw pos</i> <i>Action</i> BAND 1 (6.6 to 12 mc) XTAL A Crystal A of BAND 1 controls the oscillator frequency. XTAL B Crystal B of Band 1 controls the oscillator frequency. MO Tuned circuit of BAND 1 controls the oscillator frequency. BAND 2 (3.6 to 6.6 mc) XTAL A Crystal A of BAND 2 controls the oscillator frequency. XTAL B Crystal B of BAND 2 controls the oscillator frequency. MO Tuned circuit of BAND 2 controls the oscillator frequency. BAND 3 (2 to 3.6mc) XTAL A Crystal A of BAND 3 controls the oscillator frequency. XTAL B Crystal B of BAND 3 controls the oscillator frequency. MO Tuned circuit of BAND 3 controls the oscillator frequency.
SIDE TONE VOL. control	(G)	Adjusts audio level sidetone heard at the headset or loudspeaker.
OSC. CAL CONTROL.....	(H)	Calibration adjustment for transmitter tuning.
FREQ. CONTROL.....	(I)	Tunes transmitter to the desired operation frequency (dial numbers appear in dial window and represent calibration chart settings for the desired frequency).
DIAL LIGHT SWITCH.....	(J)	When depressed, illuminates dial window.
KEY jack.....		Permits the use of a key for CW and MCW operation.
MIKE jack.....		Permits the use of a microphone to control modulation during PHONE operation

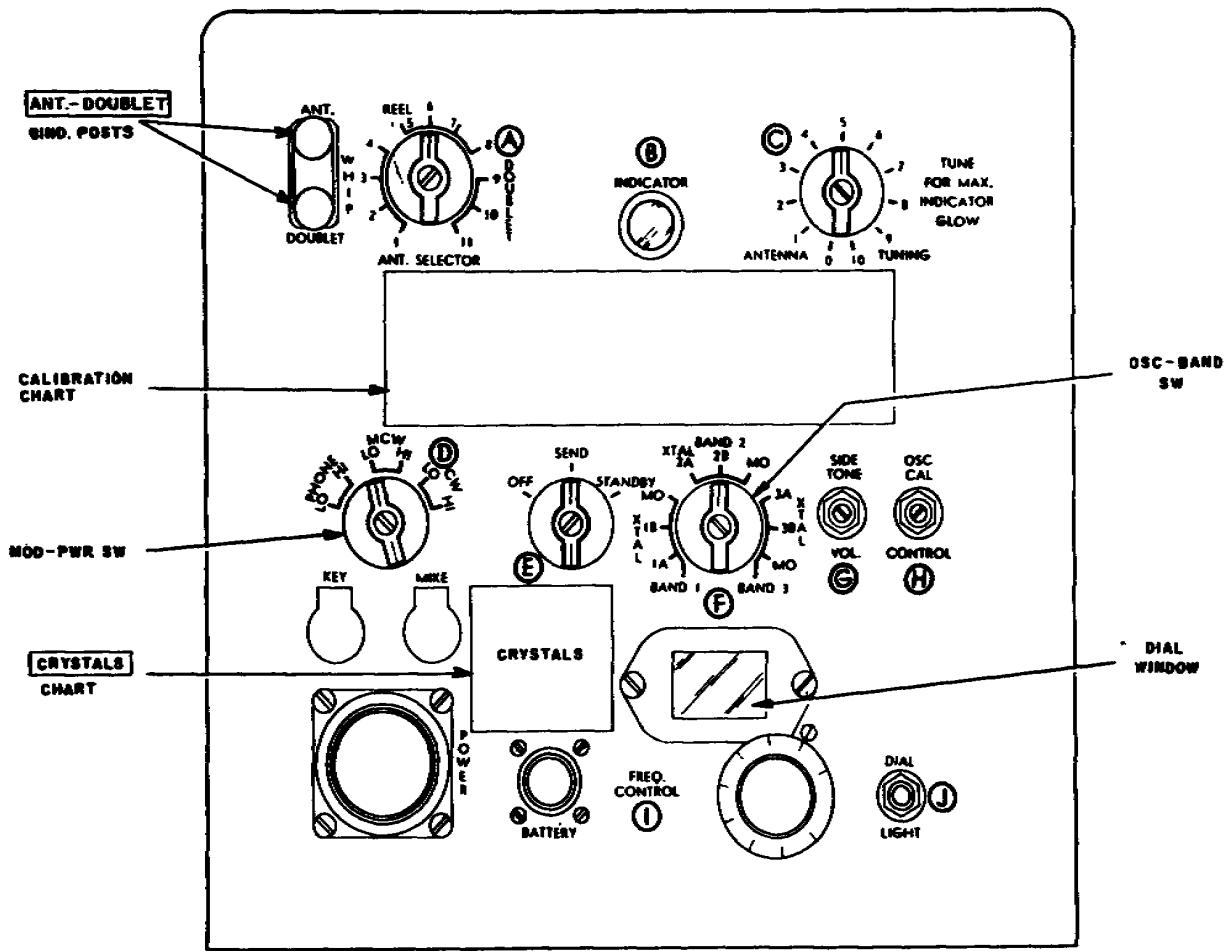
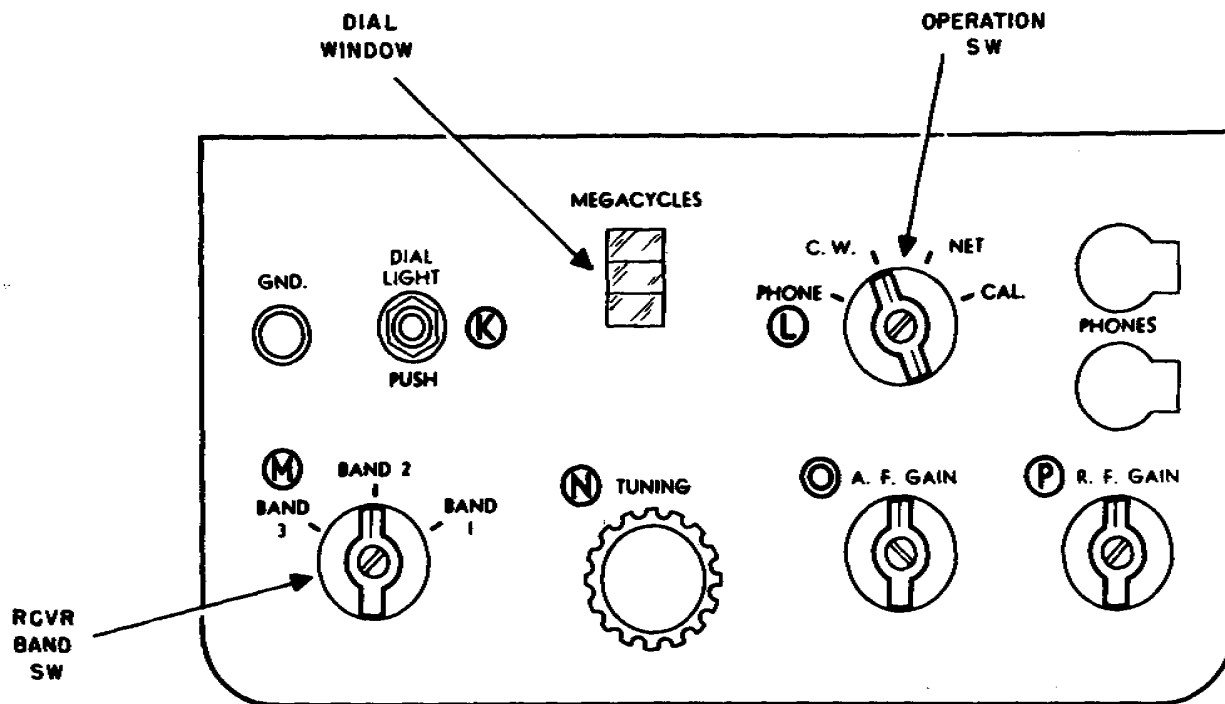

Figure 9. RT-77 (*)/GRC-9, transmitter subassembly, front panel.



TM5820-453-10-10

Figure 10. RT-77(*)/GRC-9, receiver subassembly, front panel.

10. Receiver Subassembly of RT-77 (*)/GRC-9
(fig. 10)

Control or indicator	Panel letter	Function
DIAL LIGHT-PUSH switch	(K)	When depressed, illuminates dial window.
Operation switch	(L)	Four-position switch. <i>Sw pos</i> <i>Action</i>
		PHONE C. W. Allows voice and mcw reception. Allows cw reception by automatically turning on the bfo stage.
		NET Allows alignment of transmitter to the desired distant station.
		CAL. Allows the receiver to be calibrated.
Receiver band switch.	(M)	Three-position switch <i>Sw pos</i> <i>Action</i>
		BAND 1 6.6- to 12-mc frequency range (dial marks 60 kc apart).
		BAND 2 3.6- to 6.6-mc frequency range (dial marks 20 kc apart).
		BAND 3 2.0- to 3.6-mc frequency range (dial marks 20 kc apart).
Tuning control.....	(N)	Tunes the receiver and controls the operation of the calibration dial. Dial numerals are in megacycles.
A. F. GAIN control	(O)	Adjusts the audio signal level heard at the headset or loudspeaker.
R. F. GAIN control	(P)	Adjusts the receiver gain.
PHONES jacks.....		Each jack serves the following purpose: 1. A headset or loudspeaker connection to the audio output. 2. Completes filament circuit when headset or loudspeaker is plugged into either jack.
IMPEDANCE switch (rear).....		Two-position switch that controls the audio output impedance. <i>Sw pos</i> <i>Action</i>
		260 Permits a headset of 260 ohms impedance to be used for reception.
		4000 Permits Loudspeaker LS-203/U and Headset H-16/U to be used for reception.
		.

11. Dynamotor Power Supply DY-88/GRC-9
(fig. 11)

Control or indicator	Function
TRANS AND RECEIVE-OFF switch	Two-position switch. <i>Sw pos</i> OFF TRANS AND RECEIVE The marking 6V, 12V, or 24V that appears in the window indicates that the DY-88/GRC-9 is set to operate from a vehicle battery of that voltage rating. Houses the dynamotor protecting fuse. Houses the vibrator protecting fuse. Contains the spare fuses for the dynamotor and vibrator sections.
Voltage-indicator window	
DYN. FUSE assembly	
VIB. FUSE assembly	
SPARE FUSES receptacle	

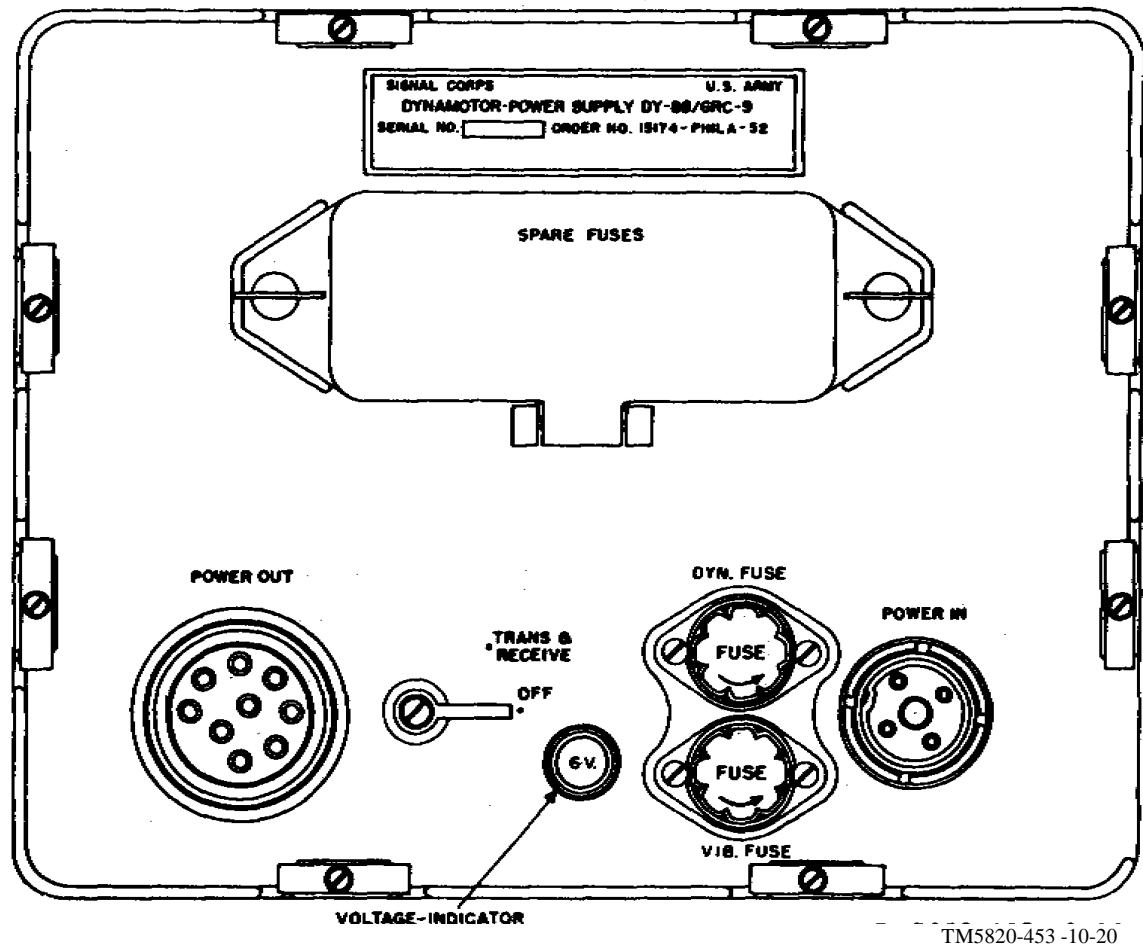

TM5820-453 -10-20

Figure 11. DY-88/GRC-9, front panel.

13. Meter, Field Strength ME -6 1/GRC
(fig. 13)

Control or indicator	Function
BAND SWITCH.....	Three-position switch. <i>Sw pos</i> 15-4 14-10 0-24 Action Frequency range of 1.5 to 4 mc is selected. Frequency range of 4 to 10 mc is selected. Frequency range of 10 to 24 mc is selected.
TUNING control.....	Allows continuous tuning of field strength meter for the selected BAND SWITCH position.
Meter	Gives indication of radiation from transmitting antennas.
Meter	Adjusts the signal level indication of the panel meter on the field strength meter.
PHONES jack	Permits a headset to be placed across the audio output for monitoring modulation.
ANT	Telescoping antenna for reception of transmitted frequencies.

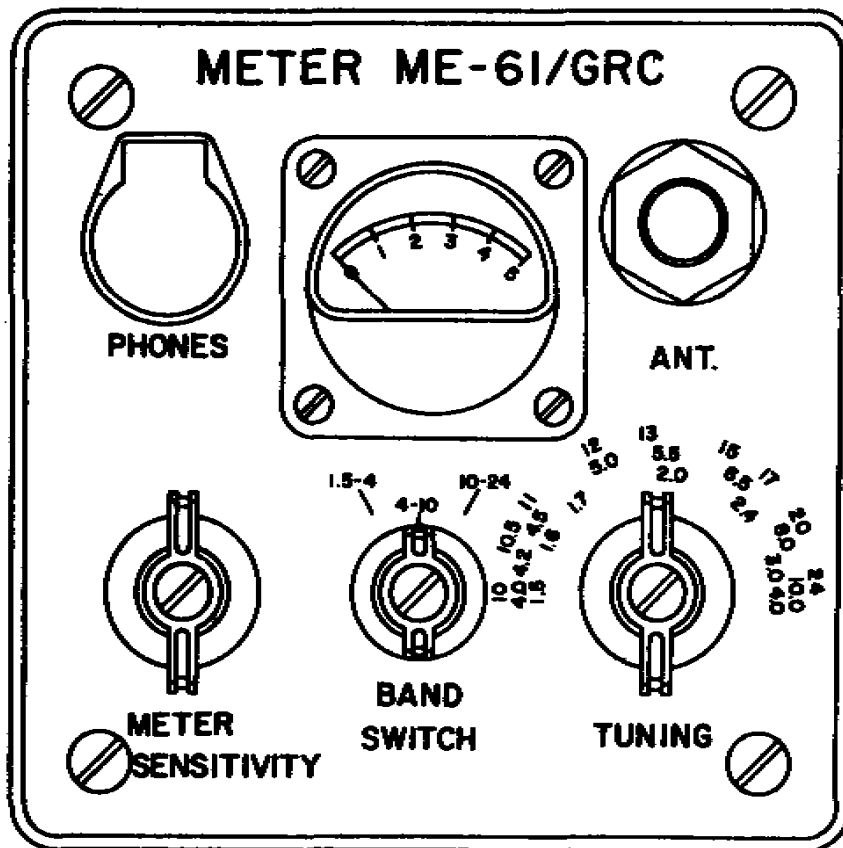

TM5820-453-10-18

Figure 13. ME-61/GRC, front panel.

Section II. OPERATION UNDER USUAL CONDITIONS

14. Types of Operation

a. Radio Sets AN-GRC/87 and AN/VRC- can be voice, continuous-wave (cw), or modulated continuous-wave (mew) operated. The AN/GRC-87 provides operation for ground and vehicular installations; the AN/ VRC-34 provides operation for vehicular installations.

b. The operational procedure will vary with the type of power supply used. To operate the equipment for the particular mode of operation required, perform the following procedures:

- (1) Power supply preliminary starting procedures (para 15).
- (2) Receiver-transmitter starting procedure (para 16).
- (3) Receiver operation (para 17).
- (4) Transmitter dial setting procedure (para 18).
- (5) Transmitter operation (para 19).

15. Power Supply Preliminary Starting Procedure

Choose the applicable power supply preliminary procedure listed below.

a. *DY-88/GRC-9.* Perform the preliminary operations listed below before starting the equipment (para 16) .

- (1) Turn the TRANS & RECEIVE-OFF switch to OFF.
- (2) Check to see whether the voltage that appears in the voltage-indicator window agrees with the voltage of the vehicular battery. If it does not agree, request the unit repairman (or higher echelon) to correct the setting of the input voltage selector switch.
- (3) Check the DYN. FUSE and the VIB. FUSE for the applicable fuse rating as indicated in the chart below:

Vehicular battery (volts)	DYN. FUSE (amperes)	VIB. FUSE (amperes)
6	30	5
12	20	2 (slo blo type)
24	10	2 (slo blo type)

- (4) Operate the TRANS & RECEIVE OFF switch to TRANS & RECEIVE.(3)
- (5) Operate control (E) on the RT-77 (*) /GRC-9 to STANDBY and place one hand on the power supply case; vibrations will be felt.

(6) Operate control (E) on the RT- (*) /GRC-9 to SEND; a steady hum from the power supply will be heard.

(7) Perform the procedure given in paragraph 16.

b. *DY-105(*)/GRC-9X.* Perform the preliminary operations listed below before starting the equipment (para 16).

- (1) Operate the TRANS RECEIVE-OFF switch to OFF.
- (2) Check the DYN. FUSE for a 10- rating, and the VIB. FUSE for a 3-ampere rating.
- (3) Operate the TRANS RECEIVE-OFF switch to TRANS RECEIVE.
- (4) Operate control (E) on the RT- (*) /GRC-9 to STANDBY and place one hand on the power supply case; vibrations will be felt.
- (5) Operate control (E) on the RT- to SEND; a steady hum from the power supply will be heard.
- (6) Perform the procedures given in paragraph 16.

c. *Generator, Direct Current G-43/G.*

- (1) Two operators are required when the G-43/G is used to operate the RT-77(*) /GRC-9 One operator operates the receiver-transmitter. The other operator rotates the handcranks at approximately 1 revolution per second in the direction of the arrow stamped on the generator housing.

Caution: Do not turn the handcranks in the opposite direction; this action will cause damage to the generator.

- (2) The generator will supply power (when the generator handcranks are rotated) to the receiver and transmitter when control (E) on the RT- (*) /GRC-9 is set to SEND. If control (E) is set to STANDBY, then power will only be supplied to the receiver.
- (3) If the BA-317/U (dry battery) and the G-43/G are required to supply power to the RT-77(*)/GR~9, then set control (E) to STANDBY. It will be necessary to rotate the generator handcranks during transmission but not during reception. If control (E) is set to SEND, then power will be supplied to the transmitter only.

(4) Follow the procedure given in paragraph 16.

16. Receiver-Transmitter Starting Procedure

Refer to paragraph 15 before starting the procedures given below.

a. Operate control (E) to OFF.

b. Check to see whether the headset or the loudspeaker is plugged into the PHONES jack on the receiver (the receiver filaments will not light unless a headset or a loudspeaker is plugged into the PHONES jack).

c. Check to see whether the microphone or key is plugged into the MIKE and KEY jacks.

d. Check for the correct connections on the binding posts for the antenna in use. Operate control (A) to the applicable position (refer to the chart below).

Antenna type	Control (A) position	Binding post connections
Whip	WHIP 1, 2, 3 or 4.....	ANT. and GND.
Long-Wire	REEL 5, 6, 7, or 8.....	ANT. and GND.
Doublet.....	DOUBLET: 9, 10, or 11	ANT. and DOUBLET.

e. Adjust A.F. GAIN control (O) and R.F. GAIN control (P) maximum clockwise.

17. Receiver Operation

Refer to paragraphs 15 and 16 before starting this procedure; allow approximately 15minutes for equipment warmup.

a. *Calibrating.*

- (1) Operate control (L) to CAL. and control (E) to STANDBY.
- (2) Operate control (D) to PHONE HI.
- (3) Operate control (M) to the band position corresponding to the operating frequency.
- (4) Rotate control (N) to the 200-kc crystal checkpoint nearest the operating frequency.
- (5) Adjust control (O) to midposition and control (P) maximum clockwise.
- (6) Adjust control (N) for a zero beat. The receiver is now calibrated to the crystal checkpoint.

b. *Receiver Tuning.* Refer to the chart below for the applicable control position or adjustment of the desired type of reception.

Control	Control setting for type of reception		
	Voice	Mew	Cw
(E)	STANDBY	STANDBY	STANDBY.
(L)	PHONE	PHONE	C.W.
(M)	Adjust to band position nearest operating frequency	Same as for <i>Voice</i> .	Same as for <i>Voice</i> .
(N)	Adjust to indicate the operating frequency.	Same as for <i>Voice</i> .	Operate control slightly to the left or right of operating frequency to obtain audible tone.
(O)	Adjust for comfortable listening level.	Same as for <i>Voice</i> .	Same as for <i>Voice</i> .
(P)	Adjust for maximum signal level..	Same as for <i>Voice</i> .	Same as for <i>Voice</i> .

18. Transmitter Dial Setting

Procedure

a. General. Prior to operation, **FREQ. CONTROL (I)** on the transmitter subassembly of the RT-77(*)/GRC-9 (fig. 9) must be adjusted for transmission on the assigned operating frequency. Adjustment of **FREQ. CON-** controls the dial settings of two dials which are illustrated for *typical* settings in figure 15. The dial numbers *do not* represent numerical values of operating frequencies; they are used only to facilitate dial setting procedures when the transmitter is being arranged for operation at a particular frequency. Dial setting numbers are obtained from the dial calibration chart that is located on the front panel of each transmitter. A *typical* chart is illustrated in figure 14. Three possible procedures can be used to determine proper dial settings for the assigned operating frequency:

- (1) If the assigned operating frequency is within band 1, 2, or 3 (2 to 11.7 mc) and can be *evenly* divided by 100, follow the procedures in b below.
- (2) If the assigned operating frequency is within band 2 (2 to 3.6 mc) or band 3 (3.6 to 6.6 mc) and can be *evenly* divided by 20, or if the assigned frequency is within band 1 (6.6 to 11.95 mc) and can be *evenly* divided by 50, follow the procedures in c below.
- (3) If the assigned operating frequency *does not* meet the criteria specified in either (1) or (2) above, follow the procedures in d below.

Note: Examples in the procedures of b, c, and d below reflect use of the *typical* dial calibration chart illustrated in figure 14. However, data (dial-setting numbers) in the calibration charts will differ for each transmitter. Therefore, when using these procedures to determine dial settings for a specific transmitter, use the dial calibration chart located on the front panel of the transmitter.

b. Procedure 1.

- (1) Select, from the **FREQ** column of the chart, the number that corresponds with the assigned operating frequency. *For example, assume that the assigned operating frequency is 3,100 kc (BAND 1); then select 3100.*

- (2) Select, the number that is adjacent (on the right-hand side to the number selected in 1) above. (This number is the required transmitter dial setting for the assigned operating frequency. *For the given example, the dial setting number is 2310.*

c. Procedure 2.

- (1) Select, from the **FREQ** column of the chart, a number which is *numerically* closest to *but less than* the assigned operating frequency. *For example, assume that the assigned operating frequency is 5,540 kc (BAND 2); then, select 5500.*
- (2) Select, from the top row of one of the five columns on the right-hand side of the **FREQ** column, a number that is equal to the difference between the assigned operating frequency and the number selected in (1) above. *For the given example select 40.*
- (3) Select the number that appears at the intersection of the *row* for the number selected in (1) above and the *column* for the number selected in (2) above. This number is the required transmitter dial setting for the assigned operating frequency. *For the given example, the dial setting number is 2284.*

d. Procedure 3. When an assigned operating frequency requires the use of dial setting numbers (for adjustment of **FREQ. CONTROL I**) which cannot be obtained directly from the dial calibration chart (as in *a* or *b* above), required dial settings must be *interpolated* as described in (1) through (9) below.

Note: Terms such as **Di**, **Fo**, **Fb**, **Db**, **Da**, and **Kc** will be designated to represent specific numbers that will be selected during the following procedures. The numbers selected will be used in the equation provided at the end of these procedures. Therefore, keep a record of each number (and its designated term) obtained while performing the procedures.

- (1) Designate the assigned operating frequency as **Fo**. *For example, assume that the assigned operating frequency is 9238.5 kc (BAND 1); then, $Fo = 9238.5$.*
- (2) Select, from the **FREQ** column of the chart, a number which is *numerically* closest to *but less than* the assigned operating frequency. *For the given example, select 9000.*

- (3) Select, from the top row of one of the five columns on the right-hand side of the **FREQ** column, a number *which* when added to the number selected in (2) above, will be numerically closest to but less than the assigned operating frequency. *For the given example select 200, since $9000 + 200 = 9200$ and this number is numerically closest to, but less than, the assigned operating frequency of 9,288.5.*
- (4) Designate the sum of the numbers selected in (2) and (3) above as **Fb**. *For the given example $Fb = 9,200$.*
- (5) Select the number that appears at the intersection of the row for the number selected in (2) above and the column for the number selected in (3) above. Designate this number as **Db**. *For the given example, select 1911; then $Db = 1911$.*
- (6) Select, from the top row of one of the five columns on the right-hand side of the **FREQ** column, a number which when added to the number selected in (2), above, will be numerically closest to but greater than the assigned operating frequency. *For the given example select 250, since $9000 + 250 = 9250$ and this number is numerically closest to but greater than the assigned operating frequency of 9,288.5.*
- (7) Select the number that appears at the intersection of the *row* for the number selected in (2) above and the *column* for the number selected in (6) above. Designate this number as **Da**. *For the given example, select 1932; then $Da = 1932$.*
- (8) Use one of the following procedures to select a number that will represent the term **Kc**:
- (a) If the assigned operating frequency is within band 2 (2 to 3.6 mc) or band 3 (3.6 to 6.6 me), $Kc = 20$.

- (b) If the assigned operating frequency is within band 1 (6.6 to 11.7 me), $Kc = 50$.
Note: For the given example $Kc = 60$.
- (9) Substitute, in the following equation, the numbers selected for **Fo**, **Fb**, **Db**, **Da**, and **Kc** and perform the required computation to find **Di**.

Note: Di is the interpolated dial setting for the transmitter.

Fo is the assigned operating frequency in kilocycles.

Fb is a frequency that is listed in the dial calibration chart and is numerically closest to but less than the assigned operating frequency.

Db is a number in -the dial calibration chart which represents a transmitter dial setting for a frequency listed in the chart that numerically is closest to but less than the assigned operating frequency.

Da is a number in the dial calibration chart which represents a transmitter dial setting for a frequency listed in the chart that is numerically closest to but more than the assigned operating frequency.

Kc is the kilocycle separation between the **Kc** columns on the dial calibration chart.

$$\begin{aligned}
 Di &= \frac{(Fo - Fb) \times (Da - Db) + Db}{Kc} \\
 &= \frac{(9238.5 - 9200) \times (1932 - 1911) + 1911}{50} \\
 &= \frac{(38.5) \times (21) + 1911}{50} \\
 &= \frac{808.5 + 1911}{50} \\
 &= 16.17 + 1911 \\
 &= 1927.17
 \end{aligned}$$

Note: Do not use numbers to the right of the decimal; therefore, $Di = 1927$.

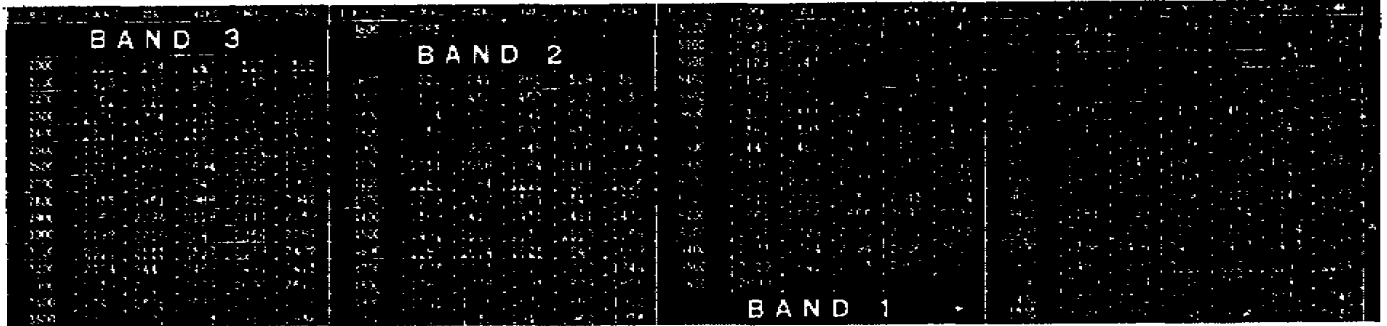

Figure 14. Typical transmitter dial calibration chart.

TM5820-453-10-7

19. Transmitter Operation

Refer to paragraphs 15 and 16 before starting this procedure. Allow 15 minutes for equipment warmup.

a. Calibrating.

- (1) Calibrate the receiver (pare 17).
- (2) Set control (F) to MO for the band associated with the operating frequency.
- (3) Set control (I) to indicate the proper dial setting (pare 18) for the calibration check frequency (pare 17).
- (4) Set control (L) to NET and control (D) to MC W or CW. (Calibration is not possible in the PHONE position.)

- (5) Set control (E) to SEND except when the power source is the G -43 /g and BA-317/U; then, set (E) to STANDBY.
 - (6) Set controls (O) and (P) to their midpositions.
 - (7) Adjust the control (EI) until zero beat is heard from the headset or loudspeaker.
 - (8) The transmitter is now calibrated on this band. If other bands are to be used, repeat the procedure given in (1) through (7) above for each band.
- b. Tuning. Refer to the following chart for the applicable control setting for the type of transmission required.

Control or indicator	Control setting for type of transmission		
	Voice	Mew	Cw
(E)	Set to SEND (set to STANDBY if G 43/G and BA-317/U are the power source).	Same as for <i>Voice</i> .	Same as for <i>Voice</i>
(F)	Set to the required MO or XTAL. position for the applicable band of operation.	Same as for <i>Voice</i>	Same as for <i>Voice</i> .
(D)	Set to PHONE-HI	Set to MCW HI.	Set to C.W. HI
(I)	Adjust to indicate dial setting for the required frequency (pare 18).	Same as for <i>Voice</i> .	Same as for <i>Voice</i>
(J)	Depress control if dial setting illumination is required (microphone switch must be depressed).	Depress control if dial setting illumination is required	Same as for Mew..
(A)	Set to highest numbered position for type of antenna used (pare 16).	Same as for <i>Voice</i> .	Same as for <i>Voice</i> .
(B)	Align red dots	Same as for <i>Voice</i> .	Same as for <i>Voice</i> .
(L)	Set to PHONE.	Same as for <i>Voice</i> .	Set to CW HI.

Control or indicator	Control setting for type of transmission		
	Voice	Mew	Cw
Microphone (M-52/U) or key (J-45)	<p>Depress the microphone switch and perform the following:</p> <ol style="list-style-type: none"> (1) Adjust control (C) until INDICATOR (B) glows at maximum. If INDICATOR (B) does not glow, set control (A) to the next lower number until maximum glow is indicated. (2) Depress microphone button; wait 2 seconds, and speak into microphone. Establish communication. 	<p>Close key and perform the following:</p> <ol style="list-style-type: none"> (1) Same as for <i>Voice</i>. (2) Key transmitter and establish communication 	<p>Close key and perform the following:</p> <ol style="list-style-type: none"> (1) Same as for <i>Voice</i>. (2) Same as for <i>Mcw</i>.
Meter, Field Strength ME-61/GRC.	<p>The ME-61/GRC is used when a more accurate tuning indication than INDICATOR (B) is required. Follow procedures indicated below after the above tuning steps have been completed:</p> <ol style="list-style-type: none"> (1) Extend ME-61/GRC telescoping antenna (fig. 8). (2) Set ME-61/GRC B A N D SWITCH (fig. 13) to range of required frequency. (3) Depress microphone switch and place ME-61/GRC just close enough to the radiating (rf field) antenna to cause an indication on the ME-61/GRC. <i>Warning:</i> Do not touch transmitting antenna with ME 61/GRC telescoping antenna; serious rf burns and equipment damage may occur. (4) Adjust t h e ME-61/GRC TUNING control (fig. 13) for maximum indication (if necessary, reduce the meter indication by adjusting the ME-61/GRC METER SENSITIVITY control (fig. 13) (5) Adjust transmitter control (C) for maximum indication on ME-61/GRC. (6) Plug headset into PHONES jack of ME-61/GRC to monitor the modulated signal. (7) Release microphone switch. (8) Establish communications 	Same as for <i>Voice</i> .	Same as for <i>Voice</i> .

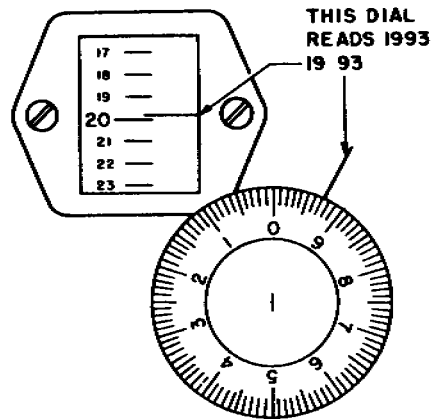
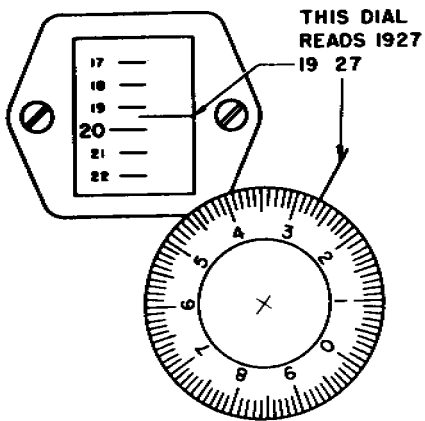
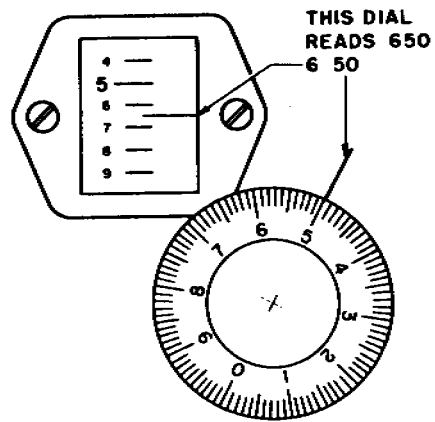
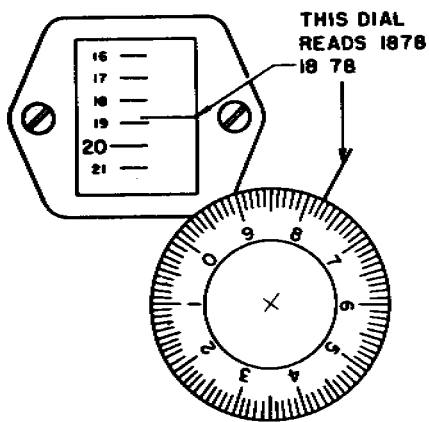
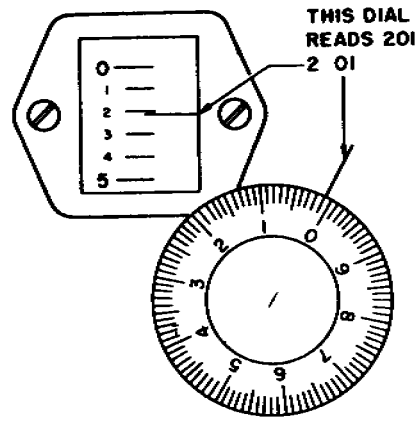
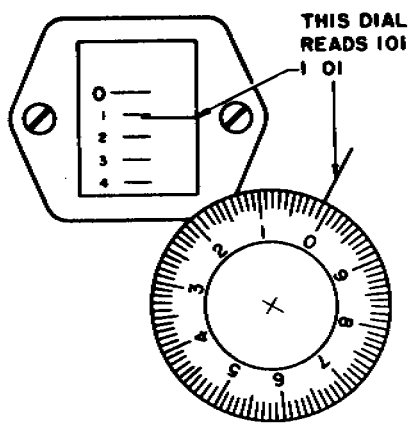

TM5820-453-10-12- 12

Figure 15 Typical transmitter dial settings

20. Net Operation

In net operation, all transmitters and receivers are tuned to the same frequency as determined by the net-control station. All operators in the net will tune their radio sets as directed below.

a. The net-control station operator will perform the procedures outlined in paragraphs 16 through 19 and transmit a continuous signal at the net operating frequency.

b. Each station operator will conduct the following tuning procedure:

- (1) Set control (E) to SEND except when the power supply consists of the G-43/G and the BA-317/U; then, set it to STANDBY.
- (2) Set control (L) to C.W.
- (3) Adjust control (N) to obtain a zero beat with the net-control station signal.
- (4) Set control (L) to NET.
- (5) Set control (D) to CW LO.
- (6) Set control (I) to indicate the dial setting for the net-control station frequency (pare 18).
- (7) Adjust control (H) to obtain a zero beat.
- (8) Adjust control (C) (only a slight adjustment is necessary) for a maximum glow on INDICATOR (B) or for a maximum indication on the ME-61/ GRC.
- (9) Adjust controls (D) and (I) as required (pare 17, 18, and 19).

21. Antijamming

When it is known, under real or simulated tactical conditions, that the receiver is being jammed, the

operator will promptly notify the immediate superior officer and continue to operate the equipment. To provide maximum intelligibility of jammed signals, follow the procedure given below:

a. Rotate control (N) several degrees on either side of the desired signal; this action may cause some separation of the desired signal and the jamming signal.

b. Vary R.F. GAIN control (P); this action may reduce the jamming signal enough to permit the desired signal to be heard.

c. Vary A.F. GAIN control (O); this action may raise the level of the desired signal enough to be heard.

d. If the procedures given above do not provide enough signal separation for operation, change to the authorized alternate frequency and alternate the call sign.

22. Stopping Procedure

a. Turn control (E) to OFF.

b. Turn off the applicable power supply as follows:

- (1) *Dynamotor-Power Supply DY-88/ GRC-9.* Operate the TRANS & RECEIVE-OFF switch to OFF.
- (2) *Dynamotor-Power Supply DY105(*)/ GRC-9X.* Operate the TRANS RECEIVE-OFF switch to OFF.
- (3) Generator, Direct Current G-43/G. Stop turning the handcranks.

Section III. OPERATION UNDER UNUSUAL CONDITIONS

23. General

The radio equipment may have to be operated in regions where extreme cold, heat, humidity or other moisture, or sand conditions prevail. Although every precaution is taken in the design of the equipment to maintain its technical characteristics over a wide temperature and humidity range, adverse conditions may cause poor transmission and reception unless additional precautions are taken. Paragraphs 24, 25, and 26 provide procedures that minimize the effects of these unusual climatic conditions.

24. Operation in Arctic Climates

Subzero temperature and climatic conditions associated with cold weather affect the efficient operation of the system. Observe the following instructions and precautions when operating under such unusual conditions:

- a.* Keep the equipment warm and dry.
- b.* Avoid the excessive use of lubricants.
- c.* When the equipment that has been exposed to the cold is brought into a warm room, moisture will form and remain on the equipment until it reaches room temperature. This may cause a change in the operating characteristics. When the equipment reaches room temperature, dry it thoroughly.

25. Operation in Tropical Climates

When operating in tropical climates, the equipment may be installed in tents, huts, or, when necessary, in underground dugouts. If the equipment is installed in dugouts or in swampy areas, moisture conditions are more acute than normal. The high relative humidity causes condensation to form on the equipment. To minimize this condition, provide the best possible ventilation and dry the equipment thoroughly. Place lighted electric light bulbs near the equipment to aid in preventing condensation from forming.

26. Operation in Desert Climates

- a.* The main problem that arises with equipment operation in desert areas is the large amount of sand, dust, or dirt that enters the moving parts.
- b.* Be careful to keep the equipment as free from dirt as possible. Make frequent maintenance checks.
- c.* Never tie power cords or other wiring connections to the inside or the outside of tents. Desert areas are subject to sudden wind squalls which may jerk connections loose or break the lines.
- d.* A drop in temperature during the night often causes condensation on the equipment the following day; dry the equipment thoroughly.

CHAPTER 3 MAINTENANCE INSTRUCTIONS

27. Scope of Maintenance

The maintenance duties assigned to the operator of Radio Sets AN/GRC-87 and AN/VRC- are listed below, together with a reference to the paragraph covering the specific maintenance function.

- a. Daily maintenance service and inspection (para 31).
- b. Cleaning (para 32).
- c. Repairs.
 - (1) Replacement of receiver dial lamp (para 33a).
 - (2) Replacement of transmitter dial lamp (para 33b).
 - (3) Replacement of INDICATOR (B) lamp (para 33c).
 - (4) Replacement of panel fuses (para 33d).

28. Tools Required For Maintenance

The duties assigned do not require tools or test equipment other than those issued with the radio set.

29. Preventive Maintenance

Preventive maintenance is the systematic care, servicing, and inspection of equipment to prevent the occurrence of trouble, to reduce downtime, and to assure that the equipment is serviceable.

a. *Systematic Care.* The procedures given in paragraphs 30, 31, and 32 cover systematic care essential to proper upkeep and operation of the equipment. The cleaning operations (para 32) should be performed once a day. If the equipment is not used daily, however, the cleaning operations must be performed before operation, or once a week while the equipment is kept in *standby* condition. The other items must be checked before the equipment is placed in operation after any extended shutdown, during operation, or after it is turned off, as specified in the applicable paragraph.

b. *Maintenance Service and Inspection.* The maintenance service and inspection chart (para 31)

outlines inspections to be made at specific intervals. These inspections are made to maintain combat serviceability; that is, to make sure that the equipment is in good general (physical) condition, in good operating condition, and likely to remain combat serviceable. To assist operators in maintaining combat serviceability, the chart indicates what to inspect, how to inspect, and what the normal conditions are; the References column lists the paragraph that contains additional information. If the defect cannot be remedied by the operator, higher echelon maintenance or repair is required. Records and reports of these inspections must be made in accordance with TM 38-750.

30. Maintenance Service and Inspection Periods

a. Maintenance service and inspections of the AN/GRC-87 and AN/VRC-34 are required on a daily basis.

b. Paragraph 31 specifies services and inspections that must be made daily and under the special conditions listed below.

- (1) *In vehicular installations.*
 - (a) Before the vehicle starts on a mission.
 - (b) When the equipment is initially installed.
 - (c) When the equipment is reinstalled after removal for any reason.
 - (d) At least once each week if the equipment is maintained in standby condition.
- (2) *In transportable and mobile installations.*
 - (a) When the equipment is initially installed.
 - (b) When the equipment is reinstalled after removal for any reason.
 - (c) At least once each week if the equipment is maintained in standby condition.

31. Daily Maintenance Service and Inspection Chart

Item No.	Procedure										
	Item	Normal Condition or result	References								
1	<p>SET: Inspect the equipment for:</p> <p>a. Completeness.</p> <p>b. Cleanliness (service).</p> <p>c. Waterproofing.</p>	<p>a. Equipment must be complete and installed for operation.</p> <p>b. Units must be clean and dry, free of grease, dirt, rust, corrosion, and fungus.</p> <p>c. Waterproof gaskets (exterior) are in good condition.</p>	<p>a. Appx II.</p> <p>b. Pars 32.</p> <p>c. None.</p>								
2	<p>PUBLICATIONS: check to see that the pertinent publication is available.</p>	<p>Operator's manual is complete and in usable condition.</p>	<p>Appx I.</p>								
4	<p>LUBRICATION: Check lubrication on the equipment</p>	<p>Mechanisms should not show signs of overlubrication or underlubrication</p>	<p>Para 29b.</p>								
5	<p>CONNECTIONS: Inspect the following:</p> <p>a. Cords, connections, cables, and wires.</p> <p>b. Telegraph key, headset, loudspeaker, and microphone.</p>	<p>a. Cords, cables, and wires are free from cuts, breaks, fraying, deterioration, kinks, and strain.</p> <p>b. Plugs and sockets are clean, intact, and not loose-fitting. Microphone and telegraph key are connected to the proper jacks on the transmitter. Headset and loudspeaker are connected to the proper jack on the receiver.</p>	<p>a. None.</p> <p>b. Para 32.</p>								
6	<p>MOUNTING: Inspect seating and stability of mountings. Check for loose or missing hardware.</p>	<p>Mounting shows no evidence of weakness or deformity. All bolts, nuts, and washers are present and properly tightened.</p>	<p>None.</p>								
8	<p>FUSES: Check for proper fuses.</p> <p>a. Dynamotor-Power Supply DY-88/GRC-9</p> <p>b. Dynamotor-Power Supply DY-105 (*)/GRC-9X.</p>	<p>The fuses in use, and the spares, are of the values indicated in chart below:</p> <table border="1" style="width: 100%; border-collapse: collapse;"> <tr> <td style="width: 50%; text-align: center;">DYN. FUSE^a (amperes)</td> <td style="width: 50%; text-align: center;">VIB. FUSE^a (amperes)</td> </tr> <tr> <td style="text-align: center;">30 (6-volt battery)</td> <td style="text-align: center;">5</td> </tr> <tr> <td style="text-align: center;">20 (12-volt battery)</td> <td style="text-align: center;">2 (slo blo type)</td> </tr> <tr> <td style="text-align: center;">10 (24-volt battery)</td> <td style="text-align: center;">2 (slo blo type)</td> </tr> </table> <p>a 1 each spare is located in the spare FUSES compartment.</p> <p>b DY-105(*)/GRC-9X front panel: 1 ea 10-amp fuse (DYN. FUSE) and 1 ea 3-amp fuse (VIB. FUSE) in use. 1 ea 10-amp and 1 ea 3-amp fuse in spare FUSES compartment.</p>	DYN. FUSE ^a (amperes)	VIB. FUSE ^a (amperes)	30 (6-volt battery)	5	20 (12-volt battery)	2 (slo blo type)	10 (24-volt battery)	2 (slo blo type)	<p>Para 33d.</p>
DYN. FUSE ^a (amperes)	VIB. FUSE ^a (amperes)										
30 (6-volt battery)	5										
20 (12-volt battery)	2 (slo blo type)										
10 (24-volt battery)	2 (slo blo type)										

Item No.	Procedure		
	Item	Normal Condition or result	References
10	KNOBS, DIALS, and SWITCHES: Check for proper mechanical action by setting each control to each of its positions	Action is positive without backlash, or scraping. <i>Note:</i> Knobs that require frequent tightening should have setscrews replaced.	None.
11	ANTENNA: Inspect the installed antenna (whip or long-wire)	Antenna is complete, guy wires (if required) are correctly installed, and insulators are free from cracks, dirt, and fungus.	None.
12	OPERATIONAL PRESET; POWER SUPPLY: Set the controls of the applicable power supply. a. DY-88/GRC-9 TRANS & RECEIVE-OFF: OFF. b. DY-105(*)/GRC-9X TRANS. RECEIVE-OFF: OFF. c. G-43/G: Do not turn handcranks.	a. All controls must be set properly. b. All controls must be set properly c. All controls must be set properly.	a. None. b. None. c. None.
13	OPERATIONAL PRESET; RECEIVER-TRANSMITTER: Set the controls of the receiver-transmitter: (E) OFF (A): WHIP, REEL (long-wire) or DOUBLET (set to indicate the antenna in use). (O): Maximum clockwise. (P): Maximum clockwise.	All controls must be set properly.	None.
14	START; POWER SUPPLY: Set the controls of the applicable power supply. a. DY-88/GRC-9: Set power switch to TRANS & RECEIVE. b. DY-105 (*) /GRC-9X: Set power switch to TRANS RECEIVE. c. G-43/G: Do not turn handcranks.	All controls are set properly	a. None. b. None. c. None.
15	START; RECEIVER-TRANSMITTER: Set the controls of the receiver-transmitter: (E): STANDBY (D): PHONE HI (F): Set to desired band (BAND 1, 2, or 3) and oscillator operation (XTAL or MO). (I): Set to indicate required frequency (M): Set to indicate required band (K): Depress the control and then release it.	If the DY-88/GRC-9 or the DY-105(*)/GRC-9X is used (as a power supply); vibrations should be felt on power supply case. The receiver dial light will be lighted when control (K) is depressed, and noise output is heard from the headset and speaker. If the G-43/G is used (as the power supply), turn the handcranks; the receiver dial light will light when control (K) is depressed. Noise output is heard from the headset or loudspeaker. <i>Note:</i> If BA-317/U is used with the G-43/G, turn the handcranks only when transmitting (control (E) at STANDBY).	Para 18 and 33a

Item No.	Procedure		
	Item	Normal Condition or result	References
16	<p>CALIBRATE THE RECEIVER:</p> <p>a. Set control (L) to CAL.</p> <p>b. Set control (L) to the 200-kc checkpoint nearest the required frequency.</p> <p>c. Adjust control (N) to zero beat.</p>	<p>a. Control (L) is set properly.</p> <p>b. A tone is heard from the headset and loudspeaker</p> <p>c. Control (N) is adjusted for zero beat.</p>	<p>a. None.</p> <p>b. None.</p> <p>c. None.</p>
17	<p>CALIBRATE THE TRANSMITTER: The receiver must be calibrated before performing the procedures given below.</p> <p>a. Set control (F) to MO for the required band of operation.</p> <p>b. Determine the dial setting from the calibration chart, using the receiver checkpoint frequency, and set control (I) to indicate that dial setting.</p> <p>c. Set control (L) to NET.</p> <p>d. Set control (D) to CW or MCW.</p> <p>e. Set control (E) to SEND when the power supply is the G-43/G combined with the BA-317/U; then, set it to STANDBY.</p> <p>f. Adjust control (H) to zero beat.</p>	<p>a. Control (F) is set to MO on the required band of operation.</p> <p>b. Control (I) is set properly.</p> <p>c. Sidetone is silenced.</p> <p>d. Control (D) is set properly.</p> <p>e. Control (E) is set properly.</p> <p>f. Control (H) is adjusted for zero beat.</p>	<p>a. None.</p> <p>b. Para 18.</p> <p>c. None.</p> <p>d. None.</p> <p>e. None.</p> <p>f. None.</p>
18	<p>VOICE OPERATION:</p> <p>a. Set control (D) to PHONE HI.</p> <p>b. Set control (L) to PHONE.</p>	<p>a. Control (D) is set properly.</p> <p>b. Noise or voice signals are heard in the headset or loudspeaker.</p>	<p>a. None.</p> <p>b. None.</p>
<p>WARNING: THE FOLLOWING PROCEDURES REQUIRE THE BREAKING OF RADIO SILENCE. THIS MANUAL DOES NOT AUTHORIZE THE BREAKING OF RADIO SILENCE IMPOSED BY ANY COMMAND. UNAUTHORIZED VIOLATION OF RADIO SILENCE COULD RESULT IN COURTS MARTIAL OR POSSIBLY DEATH FROM A HOSTILE FORCE.</p>			
	<p>c. Set control (I) to indicate the dial setting for the authorized testing or operating frequency.</p> <p>d. Set control (N) to indicate authorized testing or operating frequency</p> <p>e. Set control (E) as follows:</p> <p>(1) Set to SEND for operation with DY-88/GRC-9 DY-105 (*)/GRC-9X, or G-43/G (turn handeranks).</p> <p>(2) Set to STANDBY for operation with G-43/G and BA-317/U. Turn handcranks only when transmitting</p> <p>f. Depress microphone switch and adjust control (C) for maximum indication on INDICATOR (B) or ME-61/GRC.</p>	<p>c. Control (I) is set to indicate</p> <p>d. Control (N) is set to indicate operating frequency.</p> <p>e. Control (E) is set properly.</p> <p>f. INDICATOR (B) or ME-61/GRC indicates maximum.</p>	<p>c. Para 18.</p> <p>d. None.</p> <p>e. Para 33c</p> <p>f. None.</p>

Item No.	Procedure		
	Item	Normal Condition or result	References
	<p><i>g.</i> Speak into microphone (microphone switch is depressed), establish communications, and vary control (G) through its entire range.</p> <p><i>Note</i> Wait 2 seconds after microphone button is depressed before starting to speak</p> <p><i>h.</i> Depress microphone button and control (J) . Release microphone button and control (J).</p> <p><i>i.</i> Depress and release control (K).</p> <p><i>j.</i> During reception, vary control through its entire range.</p> <p><i>k.</i> During reception, vary control through its entire range</p>	<p><i>g.</i> Communication is established and sidetone level changes from zero to maximum as control (G) is varied.</p> <p><i>h.</i> Transmitter dial light will light when control (J) is depressed and will extinguish when the microphone button or control (J) is released.</p> <p><i>i.</i> Receiver dial light will light when control (K) is depressed and extinguish when it is released.</p> <p><i>j.</i> Audio level changes from zero to maximum as control (O) is varied.</p> <p><i>k.</i> Signal level changes from zero to maximum as control (P) is varied.</p>	<p><i>g.</i> None.</p> <p><i>h.</i> Para 33<i>b.</i></p> <p><i>i.</i> Para 33<i>a.</i></p> <p><i>j.</i> None.</p> <p><i>k.</i> None.</p>
19	<p>CW OPERATION:</p> <p><i>a.</i> Set control (D) to CW HI.</p> <p><i>b.</i> Set control (L) to C.W.</p> <p><i>c.</i> Set control (I) to indicate dial setting for authorized testing or operating frequency.</p> <p><i>d.</i> Set control (N) to indicate authorized testing or operating frequency.</p> <p><i>e.</i> Set control (E) as follows: (1) Set to SEND for operation with DY-88/GRC-9, DY-(*)/GRC-9X, or G-43/G (turn handcranks). (2) Set to STANDBY for operation with G-43/G and BA-317/U. Turn handcranks only when transmitting.</p> <p><i>f.</i> Close key (J-45) and adjust control (C) for maximum indication on INDICATOR (B) or ME-61/GRC. Release key.</p> <p><i>g.</i> Key transmitter and establish communication with authorized distant station.</p> <p><i>h.</i> During transmission, vary control (G) through its entire range.</p> <p><i>i.</i> During reception. vary control (O) through its entire range.</p> <p><i>j.</i> During reception, vary control (P) through its entire range.</p>	<p><i>a.</i> Control (D) is set properly.</p> <p><i>b.</i> Control (L) is set properly and noise or cw signals are heard in headset or loudspeaker.</p> <p><i>c.</i> Control (I) is set to indicate proper dial setting.</p> <p><i>d.</i> Control ((N)) is set to indicate the proper frequency.</p> <p><i>e.</i> Control (E) is set properly.</p> <p><i>f.</i> INDICATOR (B) or ME-61/GRC indicates maximum.</p> <p><i>g.</i> Communication is established</p> <p><i>h..</i> Sidetone level varies from zero to maximum.</p> <p><i>i.</i> Audio level changes from zero to maximum.</p> <p><i>j.</i> Signal level varies from zero to maximum.</p>	<p><i>a.</i> None.</p> <p><i>b.</i> None.</p> <p><i>c.</i> Para 18.</p> <p><i>d.</i> None.</p> <p><i>e.</i> None.</p> <p><i>f.</i> Para 33<i>c</i></p> <p><i>g.</i> None</p> <p><i>h.</i> None.</p> <p><i>i.</i> None</p> <p><i>j.</i> None.</p>

Item No.	Procedure		
	Item	Normal Condition or result	References
20	<p>MCW OPERATION:</p> <p><i>a.</i> Set control (D) to MCW HI</p> <p><i>b.</i> Set control (L) to PHONE</p> <p><i>c.</i> Set control (I) to indicate dial setting for the authorized testing or operating frequency (par 18).</p> <p><i>d.</i> Set control (N) to indicate the authorized testing or operating frequency.</p> <p><i>e.</i> Set control (E) as follows: (1) Set to SEND OR operation with DY-105 (*) /GRC-9X, or G-43/G (turn handcranks). (2) Set to STANDBY for operation with G-43/G and BA-317/U. Turn handcranks only when transmitting.</p> <p><i>f.</i> Close key (J -45 and adjust control (C) for maximum indication on INDICATOR B or ME-61/GRC. Release key.</p> <p><i>g.</i> Key transmitter and establish communication with authorized distant station</p> <p><i>h.</i> During signal transmission, vary control (G) through its entire range.</p> <p><i>i.</i> During reception, vary control (O) through its entire range.</p> <p><i>j.</i> During reception, vary control (P) through its entire range</p> <p><i>k.</i> Depress and release controls. (J) and (K).</p>	<p><i>a.</i> Control (D) is set properly</p> <p><i>b.</i> Noise or mew signals are heard in headset or loudspeaker.</p> <p><i>c.</i> Control (I) is set properly.</p> <p><i>d.</i> Control (N) is set properly.</p> <p><i>e.</i> Control (E) is set properly</p> <p><i>f.</i> INDICATOR (B) or ME-61/GRC</p> <p><i>g.</i> Communication is established</p> <p><i>h.</i> Sidetone level varies from zero to maximum.</p> <p><i>i.</i> Audio level varies from zero to maximum</p> <p><i>j.</i> Signal level varies from zero to maximum.</p> <p><i>k.</i> Dial lamps light and extinguish</p>	<p><i>a.</i> None.</p> <p><i>b.</i> None.</p> <p><i>c.</i> Para 18.</p> <p><i>d.</i> None.</p> <p><i>e.</i> None</p> <p><i>f.</i> Para 33c.</p> <p><i>g.</i> None.</p> <p><i>h.</i> None</p> <p><i>i.</i> None.</p> <p><i>j.</i> None.</p> <p><i>k.</i> Para 33a and b</p>

32. Cleaning

Inspect the exteriors of the receiver-transmitter and the power supply in use. The exterior surfaces should be free of dust, grease, and fungus.

a. Remove dust and loose dirt with a clean soft cloth.

Warning: Cleaning compound is flammable and its fumes are toxic. Provide adequate ventilation. Do not use near a flame.

b. Remove grease, fungus, ground-in dirt from the cases; use a cloth dampened (not wet) with Cleaning Compound (Federal stock No. 7930-395-9542).

c. Remove dust or dirt from plugs and jacks with a brush.

d. Clean the front panels and control knobs; use a soft clean cloth. If difficulty in removing dirt occurs, dampen the cloth with water; mild soap may be used to make the cleaning more effective.

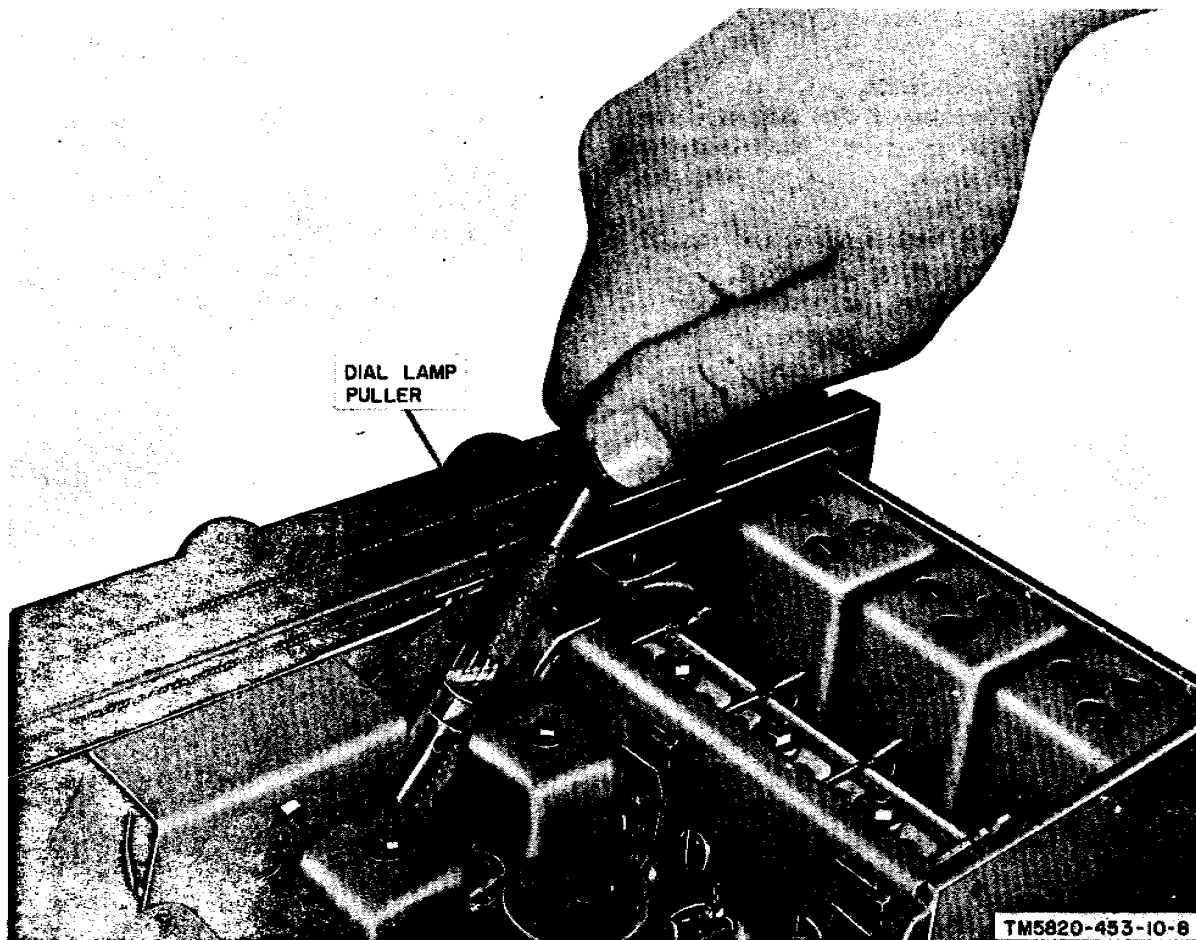

Figure 16. Receiver dial lamp removal

33. Removal and Replacement Procedures

a. Receiver Dial Lamp.

- (1) Release the latches that hold the receiver in place.
- (2) Slide the receiver partially out of its case to expose the defective lamp.
- (3) Press in on dial lamp; using the dial lamp puller (fig. 16), twist it counterclockwise to unlock.
- (4) Pull the defective dial lamp out and replace it with a new one (push the lamp in and turn it clockwise to lock).
- (5) Slide the receiver back into place and relatch it.

b. Transmitter Dial Lamp.

- (1) Remove the two screws that hold the dial window in place. Note that the left-hand screw is longer than the right-hand one.
- (2) Remove the dial window and gasket to expose defective dial lamp.
- (3) Press in on dial lamp and twist it counterclockwise to unlock.

- (4) Pull the defective dial lamp out through the opening and replace it with a new one (push the lamp in and twist it clockwise to lock).
- (5) Replace the dial window and gasket.
- (6) Replace the two screws that hold the dial window and gasket in place.

c. INDICATOR (B) Lamp.

- (1) Unscrew the indicator lens and expose the defective lamp.
- (2) Press in on the lamp and twist it counterclockwise to unlock.
- (3) Pull out the defective lamp and replace it with a new one (push the lamp in and twist it clockwise to lock).
- (4) Screw the indicator lens into place.

d. Panel Fuses.

- (1) Unscrew the fuse cap and remove the defective fuse.
- (2) Insert a new fuse of the correct value into the fuseholder, and screw on the fuse cap.

CHAPTER 4 AUXILIARY EQUIPMENT

34. Purpose of Auxiliary Equipment

Power Unit PE-162-(*) (pare 35) and Power Supply PP-327(*)/GRC-9Y (pare 36) are used as auxiliary equipment to extend the ground (man-transportable) operation of the AN/GRC-87 for semipermanent installations.

35. Power Unit PE-162-(*)

When required, this power unit can be used in place of Generator, Direct Current G -43/G in ground (man-transportable) operations. The PE-162-(*) is a lightweight, electric gener-

ator (gasoline-driven type) that is manually started. It is designed to supply 7- and 550- do at a power output of 150 watts. For additional information and operating instructions refer to TM 11-971.

36. Power Supply PP-327 (*)/GRC-9Y

When required, this power supply is used in place of Generator, Direct Current G 43/G when an input source 115- or 230-volts ac is available for ground (man-transportable) operations. For additional information and operating instructions refer to TM 11-5070.

CHAPTER 5 DEMOLITION OF MATERIEL TO PREVENT ENEMY USE

37. Authority for Demolition

Demolition of the equipment will be accomplished only upon the order of the commander. The destruction procedures outlined in paragraph 35 will be used to prevent further use of the equipment.

38. Methods of Destruction

Use any of the following methods to destroy the equipment.

a. Smash. Smash the controls, tubes, coils, switches, capacitors, and transformers; use

axes, handaxes, pickaxes, hammers, or crowbars.

b. Cut. Cut the connecting cables; use axes, handaxes, or machetes.

c. Burn. Burn cords and technical manuals; use gasoline, kerosene, oil, flamethrowers, or incendiary grenades.

d. Bend. Bend panel and cabinet.

e. Explode. If explosives are necessary, use firearms, grenades, or TNT.

f. Dispose. Bury or scatter the destroyed parts in slit trenches, foxholes, or throw them into streams.

APPENDIX I REFERENCES

DA PAM 310-4	Index of Technical Manuals, Technical Bulletins, Lubrication Orders, and Modification Work Orders.
SB 11-182	Dynamotor power supply DY-105()/GRC-9X.
SB 11-265	Replacement of Battery BA-48 by Battery BA-317/U.
SB 11-474	Cross-Reference Type Number to Federal Stock Number.
SB 11-501	Conversion of Radio Set AN/GRC-9 (*) to Radio Set AN/GRC-87 (ground version) and AN/GRC-9 (*) to Radio Set AN/GRC-87
TB SIG 109	Headset H-16/U.
TB SIG 330	Microphone M-52/U and M-52A/U.
TM 10-500-10-2-3	Air delivery of supplies and equipment: Rigging AN/GRC-87 and AN/VRC-18 Radio Set mounted in M38A1 1/4-ton utility truck on combat-expendable platform.
TM10-500-10A-3	Air delivery of supplies and equipment: Rigging AN/GRC-87 and AN/VRC-18 Radio Sets mounted in M38A1 i/4-ton utility truck.
TM11-971	Power Units PE-162-A, PE-162-B, and PE-162-C.
TM 11-5070	Power Supplies PP-327/GRC-9Y, PP-327A/GRC-9Y, and PP-327B/GRC-9Y.
TM 11-5122	Direct Current Generator G-43/G.
TM 11-5820-453-20	Organizational Maintenance Manual: Radio Set AN/GRC-87; AN/VRC-34.
TM 11-5820-79-12P	Operator and Organizational Maintenance Repair Parts and Special Tools List and Maintenance Allocation Chart: Mast Base MP-65, MP-65A, and MP-65B.
TM 11-5965-212-15P	Operator, Organizational, Field and Depot Maintenance Repair Parts and Special Tools List and Maintenance Allocation Chart: Micro phone M-52/U and M-52A/U.
TM 11-5965-213-15P	Maintenance Repair Parts and Special Tools List and Maintenance Allocation Chart for Permanent Magnet Loudspeaker LS-203/U (including LS-7 and LS-7A).
TM 11-5965-267-15P	Operator, Organizational, Field and Depot Maintenance Repair Parts and Special Tools List: Headset, Electrical H-16/U.
TM 38-750	The Army Equipment Record System and Procedures.

APPENDIX II BASIC ISSUE ITEMS LIST

Section I. INTRODUCTION

1. General

a. This appendix lists items supplied for initial operation and for running spares. The list includes tools, parts, and material issued as part of the major end item. The list includes all items authorized for basic operator maintenance of the equipment. End items of equipment are issued on the basis of allowances prescribed in equipment authorization tables and other documents that are a basis for requisitioning.

b. Columns are as follows:

- (1) *Source, maintenance, and recoverability code.* Not used.
- (2) *Federal stock number.* This column lists the 11-digit Federal stock number.
- (3) *Designation by model.* The dagger (†) indicates the equipment in which the part is used and further, by its position, designates the quantity used in each equipment where the quantity varies
- (4) *Description.* Nomenclature or the standard item name and brief identifying data for each item are listed in this column. When requisitioning, enter the nomenclature and description.
- (5) *Unit of issue.* The unit of issue is each unless otherwise indicated and is the supply term by which the individual item is counted for procurement, storage, requisitioning, allowances, and issue purposes.
- (6) *Expendability.* Nonexpendable items are indicated by NX.
- (7) *Quantity authorized.* Under "Items Comprising an Operable Equipment," the column lists the quantity of items supplied for the initial operation of the equipment. Under "Running Spare Items" the quantities listed are those issued initially With the equipment as spare parts. The quantities are authorized to be kept on hand by the operator for maintenance of the equipment.
- (8) *Illustrations.* The *Item No.* column lists the reference designations that appear on the part in the equipment. These same designations are also used on any illustrations of the equipment. The numbers in the *Figure No.* column refer to the illustrations where the part is shown.

2. Batteries

Dry batteries shown are used with the equipment but are not considered part of the equipment. They will not be preshipped automatically but are to be requisitioned in quantities necessary for the particular organization, *in accordance with SB 11-6.*

SECTION II FUNCTIONAL PARTS LIST (AN/GRC-87) (AN/VRC-34)

FEDERAL STOCK NUMBER	DESIGNATION BY MODEL	DESCRIPTION	UNIT OF ISSUE	EXP	QTY AUTH	ILLUSTRATION	
						FIGURE NO	ITEM NO.
5820-543-1997		RADIO SET AN/GRC-87: ground version, 2 to 12 mc frequency range; 3 bands; 6 channels		NX			
5820-543-1996		RADIO SET AN/VRC-34: vehicular version, 2 to 12 mc frequency range; 3 bands, 6 channels		NX			
		ITEMS COMPRISING AN OPERABLE EQUIPMENT					
		NOTE: MODEL COLUMN 1 REFERS TO AN/GRC-87, COLUMN 2 REFERS TO AN/GRC-34					
Ord thru AGC		TECHNICAL MANUAL TM 11-5820-453-10			2		
5820-243-0432	†	ANTENNA, AT-101/GRC-9; fixed type; 8 sect; 4.3 to 12 mc freq range; 107 ft 6 in lg o/a (NOTE: stored on RL-29 when not in use) (Not installed)		NX	1		
5820-243-1413	†	ANTENNA AT-102/GRC-9; fixed type 9 sect; 2 to 4.3 c; 137 ft lg o/a w/provisions for shorting as required (NOTE: stored on RL-29 when not in use) (Not installed) (Not mounted)		NX	1		
5820-308-5817	†	BAG CW-140/GRC-9; for carrying Receiver and Transmitter RT-77/GRC-9 wp canvas; 14 in lg x 14 in x 16 in h (Not installed) (Not mounted)			1		
5820-690-8541	† †	BAG, COTTON DUCK, CW-419/GRC-9 65-1/2 in lg by 33 in w w/approx dim opened; 4 flap type and fixed type pockets; Sig dwg SC-DL-31963 (Note: Replaces Roll BG-174 in AN/GRC-9) (Not installed) (Not mounted)		NX	1		
6115-709-0463	†	BAG, CW-420/G: for generator: 15-1/2 in lg x 6-1/2 in w x 11-3/4 in h o/a olive drab water repellent Sig dwg No . SC DL-17336 (Not mounted)			1		
6135-669-6632	†	BATTERY, DRY BA-317/U: NOTE: Stored in Bag CW-140/GRC-9 (Not installed)			1		
		OR					
6135-120-1007	†	BRACKET, DRY BA-48: NOTE: Stored in Bag CW-140/GRC-9			1		
5820-129-9666	†	BRACKET, FT-515: used to mount insulator in 127 6-1/2 in lg x 1 in wd x 1/8 in thk; Sig dwg SC-D-19573 NOTE; Stored in accessories Bag (Not installed)			1	5	
		OR					

FEDERAL STOCK NUMBER	DESIGNATION BY MODEL	DESCRIPTION	UNIT OF ISSUE	EXP	QTY AUTH	ILLUSTRATION	
						FIGURE NO.	ITEM NO.
5995-196-9564	†	AN/GRC-87 AND AN/VRC-34 (CONTINUED) CORD ASSEMBLY CD-307-B: (65 IN) 22 awg; 5 ft 10-13/32 in lg o/a MIL-C-3884; type ne COS-2(22) MIL-STD MS-35760 Note: Stored in accessories bag (Not installed)	1				
5995-164-6457	†	CORD ASSEMBLY, CD-106 (7 ft): MIL-C-3432 Sig dwg SC-D-22829 Note: Stored in accessories bag (Not installed)			2		
5995-162-6946	†		CORD ASSEMBLY, CD-119 (36 in): 18 awg; 3 ft 2 in lg o/a ; Sig dwg SC-C-26551 Note: Stored in accessories bag (Not installed) (Not mounted)			1	
5820-237-7321	†	COUNTERPOISE CP-12: radial type; Sig dwg SC-D-1038F: (Note: Stored on RL-29 when not in use) (Not installed)		NX	1		
5820-224-4885	†	COUNTERPOISE CP-13: radial type Sig dwg SC-D-1038; (Note: Stored on RL-29 when not in ue) (Not installed)		NX	1		
5965-243-0207	† †	COVER, MICROPHONE CW-292-W: 1.218 in lg x 0.671 in h 0.605 in dia; polethylene spec MIL-H_11190 Note: Stored in accessories bag			1		
6125-635-3770	† †	DYNAMOTOR, POWER SUPPLY DY-105/GRC-9X, DY-105A/GRC-9X, DY-105B/GRC-9X; for 24 v DC input operation only; Sig dwg SC-DL-177015 Note: For 6v or 12V intallation substitute Dynamotor Power Supply DY-88/GRC-9 for Dynamotor Power Supply DY-105/GRC-9X, DY-105A/GRC-9X, DY-105B/GRC-9X (Not mounted)		NX	1		
6125-321-5928	† †	DYNAMOTOR, POWER SUPPLY DY-88/GRC-9: for 6v, 12v or 24v, DC input operation: Note: for 6v or 12 v installation may be issued in lieu of DY-105/GRC-9X when DY-105A/GRC-9X is not available for issue (Not installed) (Not mounted)		NX	1		
6115-501-0611	†	GENERATOR, G-43/G: hand gen; power output, 425 v at 115 ma, 105v at 32 ma, 6.3 v at 2.5 amp, 1.4v at 0.465 amp, HV-8% variance, LV 2T variance, 50-70 rpm; Sig dwg SM-D-202177 Note: Stored in Bac CW-420/G when not in use (Not installed)		NX	1		
AN/GRC-87; AN/VRC-34							

FEDERAL STOCK NUMBER	DESIGNATION BY MODEL	DESCRIPTION	UNIT OF ISSUE	EXP	QTY AUTH NO.	ILLUSTRATION	
						FIGURE NO.	ITEM NO.
		AN/GRC-87; AN/VRC-34 (CONTINUED)					
5975-197-4252	†	GUY GY-12: ant mast guy; 20 ft lg; Sig dwg SC-D-1072 NOTE: Stored in accessories bag (Not installed)			1		
5975-199-5072	†	GUY GY-42: used w/mast sect; 2 lgth 20 ft lg; Sig dwg SC-D-15884 NOTE: Stored in accessories bag (Not installed)			1		
5820-493-9361	†	HALYARD, M-378: braided cotton; 9/16 in dia, 80 ft lg; NOTE: stored in accessories bag (Not installed)			1		
5820-408-3197	†	HALYARD M-379: in braided cotton, 9/64 in dia 10 ft 6 in lg; Sig dwg SC-C-35483 NOTE: Stored in accessories bag (Not installed)			1		
5965-162-7931	† †	HEADSET, ELECTRICAL H-16/U magnetic, 8000 ohm impedance, Sig dwg SC-D-14618 NOTE: Stored in accessories bag (Not installed)		NX	1		
5970-227-8226	†	INSULATOR IN-127: cylindrical; molded phenolic; 12-21/32 in lg; Sig dwg SC-DL-35528 NOTE: Stored in accessories bag (Not installed)			1		
5970-197-3576	† †	INSULATOR, STRAIN IN-86: Sig dwg SC-D-1134 NOTE: Stored in accessories bag (Not installed)			1		
5805-171-3370	† †	KEY J-45: 5-1/2 in lg x 4-1/4 in wd x 6 in h Sig dwg SC-D-1059 NOTE: Stored in accessories bag (Not installed)			1		
5965-280-3800	† †	LOUDSPEAKER LS-203/U: LS-7A; blast proof type; PM field, 8 ohm voice coil, Sig dwg SC-DL-6420 NOTE: Stored in accessories bag (Not installed)		NX	1		
5820-503-2953	† †	MAST BASE MP-65-B: Sig dwg SC-D-20718 NOTE: Stored in accessories bag (Not installed)		NX	1		
5820-199-8131	† †	MAST SECTION MS-116A: 39-1/2 in lg x 0.393 dia; Sig SC-DL-100588-MS116A NOTE: Stored in accessories bag CW-419/G (Not installed)			3	23	
5820-199-8843	† †	MAST SECTION MS-117A: 39-1/2 in lg x 0.373 dia; Sig dwg SC-D-12521 NOTE: Stored in accessories bag CW-419/G (Not installed)			1	23	
5820-199-8841	† †	MAST SECTION MS-118A: 39-1/2 in x 0.246 in dia; Sig dwg SC-D-12521 NOTE: Stored in accessories bag CW-419/G (Not installed)			1	23	
AN/GRC-87; AN/VRC-34							

FEDERAL STOCK NUMBER	DESIGNATION BY MODEL	DESCRIPTION	UNIT OF ISSUE	EXP	QTY AUTH NO.	ILLUSTRATION	
						FIGURE NO.	ITEM NO.
6625-701-9103	† †	AN/GRC-87; AN/VRC-34 (CONTINUED) METER FIELD STRENGTH ME-61/GRC: 6 in lg x 5-1/2 in w x 5 in h o/a NOTE: Stored in accessories bag (Not installed)		1		C3	
5965-646-4678	† †	MICROPHONE, CARBON M-52/U: 40 to 1000 ohms at 1000 cps: MIL Spec No. MIL-M-11193B w/anend No. 4. NOTE: Stored in accessories bag (Not installed)		NX	1		
5820-128-2207	† †	MOUNTING MT-350/GRC-9: 16-5/8 in lg x 11-9/16 in w x 1-5/8 in h; Sig dwg SC-C-20701 (Not installed)			1		
5820-196-9041	† †	RECEIVER-TRANSMITTER RT-77/GRC-9, RT-77A/GRC-9: vehicular transportable; xmtr output 25 w cw, 8.5 phone; 2 to 12 mc in 3 bands; 16-1/2 in lg x 12-1/2 in w x 8 in h o/a; Sig Spec No. 271-3213; Sig dwg SC-DL-57596 (Not installed)		NX	1		
8130-355-7616	†	REEL RL-28: for Guy-11 Guy 12; 6-1/2 in lg x 2-3/4 in w x 0.747 in thk; Sig dwg SC-D-1064 NOTE: Stored in accessories bag (Not installed)			1		
5820-030-2969	†	REEL RL-29: for sig counterpoise CP-12 and CP-13; 11-1/2 in lg x 5-1/2 in w Sig dwg SC-D-1040 NOTE: Stored in accessories bag (Not installed)			3		
4020-240-2145	† †	ROPE RP-5; cotton core, 12 strands 3/16 in dia 255 lbs min braking strength; NOTE: Stored in accessories bag (Not installed)	ft		25		
4130-223-4612	†	STAKE, GUY GP-27B: anchors guy; 7-9/16 in lg x 5/16 in dia Sig dwg No. SC-D-1063 NOTE: Stored in accessories bag (Not installed)			4		
6145-160-5114	† †	WIRE W-128: single No. 14 AWG cond, stranded, forty-one No. 30 AWG strands NOTE: Stored in accessories bag (Not installed)	ft		10		
		GROUP I DYNAMOTOR, POWER SUPPLY DY-88/GRC-9 DYNAMOTOR, POWER SUPPLY DY-88/GRC-9 (BASIC COMPONENT) (Not installed)		NX	1		
AN/GRC-87; AN/VRC-							

FEDERAL STOCK NUMBER	DESIGNATION BY MODEL	DESCRIPTION	UNIT OF ISSUE	EXP	QTY AUTH NO.	FIGURE NO.	ITEM NO.
5995-280-4264		AN/GRC-87; AN/VRC-34 (continue) CABLE ASSEMBLY, SPECIAL PURPOSE, ELECTRICAL CX-2031A/U (8 ft) uses cord CO-212 (Not installed)			1		
6125-219-9988		HARDWARE KIT: for mtg DY-88/GRC-9 to vehicle (in cloth bag) GROUP II DYNAMOTOR, POWER SUPPLY DY-105/GRC-9X; DY-105A/GRC-9; DY-105B/GRC-9X			1		
		DYNAMOTOR, POWER SUPPLY DY-105/GRC-9X; DY-105A/GRC-9X; DY-105B/ GRC-9X; (BASIC COMPONENT) (Not installed)			1		
		HARDWARE KIT: f/mtg Dynamotor-Power Supply tp vehicle; c/o lockwashers, nuts, bolts in cloth bag: Amitool No. 25095 (in cloth bag)			1		
5995-280-4264		CABLE ASSEMBLY SPECIAL PURPOSE, ELECTRICAL: CX-2031A/U: (8 ft) uses cordage CO-212 (Not installed) GROUP III RECEIVER TRANSMITTER RT-77/GRC-9; RT-77A/GRC-9			1		
5995-170-6877		CABLE ASSEMBLY SPECIAL PURPOSE ELECTRICAL: interconnects Rec-xmtr; 23-1/8 in 1g approx SC-C-35501 (Installed in equip)			1		
5820-545-8234		CABINET houses rec and xmtr; 15-1/2 in 1g x 10-1/2 in wd x 4-9/32 in d approx o/a Sig dwg SC-D-35818 (Not installed)			1		
6135-271-0407		BATTERY DRY, BA-1293/u: grid bias fv6 p/o rec (Not installed) (Not mounted)			1		
5820-691-2059		PANEL, COVER CW-109/GRC: water tight metal covr f/RT-77(*)/GRC-9; 11-1/2 in 1g x 16-1/2 in wd w/3 in fl (Mounted in equip)		1			
5820-537-3904		RECEIVER, RADIO: part of RT-77/GRC-9; RT-77A/GRC-9; 10-1/2 IN 1G x 5-1/8 in h x 6-1/2 in d o/a (installed in case)		1			
5825-309-3200		TRANSMITTER, RADIO: part of RT-77/GRC-9; RT-77A/GRC-9; 10-5/8 in 1g x 10-3/8 in wd x 6-1/2 in d o/a (installed in case)		1			
AN/GRC-87; AN/VRC-34							

FEDERAL STOCK NUMBER	DESIGNATION BY MODEL	DESCRIPTION	UNIT OF ABILITY	EXP	QTY AUTH NO.	ILLUSTRATION	
						FIGURE NO.	ITEM
5920142-7346		AN/GRC-87; AN/VRC-34 (continued) DYNAMOTOR, POWER SUPPLY DY-105/GRC-9X; DY-105A/GRC-9X; DY-105B/GRC-9X FUSE, CARTRIDGE: 3 amp; Buss type AGU-3; (NOTE: Stored in spare fuse holder on frt panel) (Not mounted)	st		4		
5920-280-3157		FUSE, CARTRIDGE: 10 amp MIL type FO7A10ROB: (NOTE: Stored in spare fuse holder mtd on frt panel) (Not mounted)			4		
6240-155-8683		RECEIVER, RADIO (FSN 5820-537-3904) NOTE: The following item is stored in Box BX-53-D LAMP, INCANDESCENT: 2V, 0.06 amp min bayonet base; GE No. S-49 (Not mounted)			1		
6240-155-8683		TRANSMITTER, RADIO (FSN 5825-309-3200) NOTE: The following items are stored in Box BX-53-D LAMP, INCANDESCENT: 2v, 0.06 amp min bayonet base; GE S49 (Not mounted)			1		
6240-299-6970		LAMP, GLOW: GE No. NE-47 (Not mounted)			1		

By Order of the Secretary of the Army:

EARLE G. WHEELER,
General, United States Army,
Chief of Staff.

Official:

J. C. LAMBERT,
Major General, United States Army,
The Adjutant General.

Distribution:

<i>Active Army:</i>	USA Elet Mat Agcy (25)	5-501	11-167
DASA (6)	Chicago Proc Dist (1)	5-600	11-500 (AA-AC)
USASA (2)	USASCC (4)	5-605	(RM-RU)
CNGB (1)	USARCARIB Sig Agcy (1)	5-627	11-557
CofEngrs (1)	Sig Fld Maint Shops (3)	6-401	11-587
TSG (1)	CofSptsS (1)	6-501	11-592
CSigO (7)	Def Comms Agcy (1)	6-535	11-597
CofT (1)	Units org under fol TOE:	6-536	11-608
USA CD Agcy (1)	(2 copies each UNOINDC)	6-537	17
USCONARC (5)	1-7	7	17-51
USAMC (5)	1-17	7-31	19-2
USAECOM (5)	1-67	7-32	19-35
USAMICOM (4)	1-127	8-15	19-36
ARADCOM (2)	1-137	8-16	19-37
ARADCOM Rgn (2)	5-5	8-17	19-55
OS Maj Comd (3)	5-6	8-18	19-56
OS Base Comd (2)	5-15	8-35	19-57
LOGCOMD	(2) 5-16	8-36	29-1
MDW (1)	5-17	8-137	29-7
Armies (2)	5-25	9-9	29-21
Corps (2)	5-26	9-12	29-56
USA Corps	(3) 5-35	9-47	33-105
Instls (2) except	5-36	9-65	33-106
Fort Monmouth	(63) 5-37	9-66	33-107
USATC AD (2)	5-38	9-86	37
USATC Armor (2)	5-45	9-87	39-51
USATC Engr (2)	5-46	9-117	44-2
USATC Inf (2)	5-47	9-197	44-12
USASTC (2)	5-49	9-227	44-57
Svc Colleges (2)	5-52	9-500 (AA-AC)	44-235
Br Svc Sch (2)	5-54	10-22	44-236
CENDEP (OS) (2)	5-97	10-202	44-237
Sig Dep (OS) (12)	5-112	10-206	44-435
Army Dep (2) except	5-114	10-445	44-436
Fort Worth Army Dep (8)	5-115	10-446	44-437
Lexington Army Dep (12)	5-116	10-449	44-445
Sacramento Army Dep (28)	5-117	10-536	44-446
Tobyhanna Army Dep (12)	5-118	11-5	44-447
Sig Sec. GENDEP (OS) (5)	5-124	11-7	44-448
USA Elct RD Actv (Ft Huachuca)(2)	5-145	11-16	44-500 (AA-AB)
USA Elct RD Actv (White Sands)(13)	5-146	11-55	44-535
WRAMC (1)	5-155	11-57	44-536
Army Pictorial Cen (2)	5-156	11-96	44-537
USA MOB Spt. Cen (1)	5-237	11-97	44-545
Trans Tm1 Comd (1)	5-278	11-98	44-546
Army Tm1 (1)	5-327	11-117	44-547
POE (1)	5-278	11-155	44-548
USAOSA (1)	5-327	11-157	52-2
AFIP (1)	5-348	11-165	57
AMS (1)	5-500 (AA-AD)	11-166	

NG: State AG (3); Units-Same as Active Army except allowance is one copy for each unit. *USAR*: None.
For explanation of abbreviations used, see AR 320-50.

RECOMMENDED CHANGES TO EQUIPMENT TECHNICAL PUBLICATIONS



THEN...JOT DOWN THE
DOPE ABOUT IT ON THIS FORM.
CAREFULLY TEAR IT OUT, FOLD IT
AND DROP IT IN THE MAIL.

SOMETHING WRONG WITH PUBLICATION

FROM: (PRINT YOUR UNIT'S COMPLETE ADDRESS)

DATE SENT

PUBLICATION NUMBER

PUBLICATION DATE

PUBLICATION TITLE

BE EXACT PIN-POINT WHERE IT IS

PAGE NO.	PARA-GRAPH	FIGURE NO.	TABLE NO.
----------	------------	------------	-----------

IN THIS SPACE, TELL WHAT IS WRONG
AND WHAT SHOULD BE DONE ABOUT IT.

TEAR ALONG PERFORATED LINE

PRINTED NAME, GRADE OR TITLE AND TELEPHONE NUMBER

SIGN HERE

THE METRIC SYSTEM AND EQUIVALENTS

WEIGHT MEASURE

1 Centimeter = 10 Millimeters = 0.01 Meters = 0.3937 Inches
 1 Meter = 100 Centimeters = 1000 Millimeters = 39.37 Inches
 1 Kilometer = 1000 Meters = 0.621 Miles

WEIGHTS

1 Gram = 0.001 Kilograms = 1000 Milligrams = 0.035 Ounces
 1 Kilogram = 1000 Grams = 2.2 lb.
 1 Metric Ton = 1000 Kilograms = 1 Megagram = 1.1 Short Tons

LIQUID MEASURE

1 Milliliter = 0.001 Liters = 0.0338 Fluid Ounces
 1 Liter = 1000 Milliliters = 33.82 Fluid Ounces

SQUARE MEASURE

1 Sq. Centimeter = 100 Sq. Millimeters = 0.155 Sq. Inches
 1 Sq. Meter = 10,000 Sq. Centimeters = 10.76 Sq. Feet
 1 Sq. Kilometer = 1,000,000 Sq. Meters = 0.386 Sq. Miles

CUBIC MEASURE

1 Cu. Centimeter = 1000 Cu. Millimeters = 0.06 Cu. Inches
 1 Cu. Meter = 1,000,000 Cu. Centimeters = 35.31 Cu. Feet

TEMPERATURE

$5/9(^{\circ}\text{F} - 32) = ^{\circ}\text{C}$
 212° Fahrenheit is equivalent to 100° Celsius
 90° Fahrenheit is equivalent to 32.2° Celsius
 32° Fahrenheit is equivalent to 0° Celsius
 $9/5^{\circ}\text{C} + 32 = ^{\circ}\text{F}$

APPROXIMATE CONVERSION FACTORS

TO CHANGE	TO	MULTIPLY BY
Inches	Centimeters	2.540
Feet	Meters	0.305
Yards	Meters	0.914
Miles	Kilometers	1.609
Square Inches	Square Centimeters	6.451
Square Feet	Square Meters	0.093
Square Yards	Square Meters	0.836
Square Miles	Square Kilometers	2.590
Acres	Square Hectometers	0.405
Cubic Feet	Cubic Meters	0.028
Cubic Yards	Cubic Meters	0.765
Fluid Ounces	Milliliters	29.573
its	Liters	0.473
arts	Liters	0.946
allons	Liters	3.785
Ounces	Grams	28.349
Pounds	Kilograms	0.454
Short Tons	Metric Tons	0.907
Pound-Feet	Newton-Meters	1.356
Pounds per Square Inch	Kilopascals	6.895
Miles per Gallon	Kilometers per Liter	0.425
Miles per Hour	Kilometers per Hour	1.609

TO CHANGE	TO	MULTIPLY BY
Centimeters	Inches	0.394
Meters	Feet	3.280
Meters	Yards	1.094
Kilometers	Miles	0.621
Square Centimeters	Square Inches	0.155
Square Meters	Square Feet	10.764
Square Meters	Square Yards	1.196
Square Kilometers	Square Miles	0.386
Square Hectometers	Acres	2.471
Cubic Meters	Cubic Feet	35.315
Cubic Meters	Cubic Yards	1.308
Milliliters	Fluid Ounces	0.034
Liters	Pints	2.113
Liters	Quarts	1.057
ers	Gallons	0.264
ms	Ounces	0.035
ograms	Pounds	2.205
Metric Tons	Short Tons	1.102
Newton-Meters	Pounds-Feet	0.738
Kilopascals	Pounds per Square Inch	0.145
ometers per Liter	Miles per Gallon	2.354
ometers per Hour	Miles per Hour	0.621



