

**TM 11-5820-919-12**

**TECHNICAL MANUAL**

**OPERATOR'S AND ORGANIZATIONAL  
MAINTENANCE MANUAL**

**RADIO SET AN/PRC-104(A)  
(NSN 5820-01-141-7953)**

**HEADQUARTERS, DEPARTMENT OF THE ARMY**

**15 JANUARY 1986**



**5**

**SAFETY STEPS TO FOLLOW IF SOMEONE IS THE VICTIM OF ELECTRICAL SHOCK**

**1**

**DO NOT TRY TO PULL OR GRAB THE INDIVIDUAL**

**2**

**IF POSSIBLE, TURN OFF THE ELECTRICAL POWER**

**3**

**IF YOU CANNOT TURN OFF THE ELECTRICAL POWER, PULL, PUSH OR LIFT THE PERSON TO SAFETY USING A DRY WOODEN POLE OR A DRY ROPE OR SOME OTHER INSULATING MATERIAL**

**4**

**SEND FOR HELP AS SOON AS POSSIBLE**

**5**

**AFTER THE INJURED PERSON IS FREE OF CONTACT WITH THE SOURCE OF ELECTRICAL SHOCK, MOVE THE PERSON A SHORT DISTANCE AWAY AND IMMEDIATELY START ARTIFICIAL RESUSCITATION**

**WARNING**

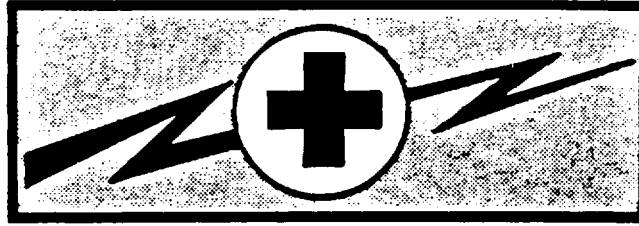

**HIGH VOLTAGE**

is used in the operation of this equipment

**DEATH ON CONTACT**

may result if personnel fail to observe safety precautions

Never work on electronic equipment unless there is another person nearby who is familiar with the operation and hazards of the equipment and who is competent in administering first aid. When the technician is aided by operators, he must warn them about dangerous areas.

Whenever possible, the power supply to the equipment must be shut off before beginning work on the equipment. Take particular care to ground every capacitor likely to hold a dangerous potential. When working inside the equipment, after the power has been turned off, always ground every part before touching it.

Be careful not to contact high-voltage connections or 115 volt ac input connections when installing or operating this equipment.

Whenever the nature of the operation permits, keep one hand away from the equipment to reduce the hazard of current flowing through the body.

Warning: Do not be misled by the term "low voltage." Potentials as low as 50 volts may cause death under adverse conditions.

For Artificial Respiration, refer to FM 21-11.

## SAFETY SUMMARY

The following are general safety precautions that are not related to any specific procedures and therefore do not appear elsewhere in this publication. These are recommended precautions that personnel must understand and apply during many phases of operation and maintenance.

### KEEP AWAY FROM LIVE CIRCUITS

Operating personnel must at all times observe all safety regulations. Unless specifically directed in this manual, do not replace components or make adjustments inside the equipment with any power supply turned on. Under certain conditions, dangerous potentials may exist in the power supplies when the power control is in the off position. To avoid casualties, always remove power and discharge and ground a circuit before touching it.

### DO NOT SERVICE OR ADJUST ALONE

Under no circumstances should any person reach into or enter the enclosure for the purpose of servicing or adjusting the equipment except in the presence of someone who is capable of rendering aid.

### RESUSCITATION

#### FIRST AID

Each person engaged in electrical operations will be trained in first aid, particularly in the technique of mouth to mouth resuscitation and closed chest heart massage (FM 21-11).

The following warnings appear in this volume, and are repeated here for emphasis.

#### WARNING

A 3-wire (line, neutral, and safety ground) AC line power connections is required when operating the equipment. If a 3-wire safety grounded AC power receptacle is not available, a separate ground wire must be installed from the chassis ground to an earth ground. Without an adequate ground, the equipment chassis and frame will float to a dangerously high potential.

#### WARNING

Lethal voltage is used in the operational checkout of this unit. Death on contact may result if personnel fail to observe the following safety precautions. Remove watches and rings and exercise extreme caution when working inside the equipment throughout the remainder of this procedure.

**WARNING**

Prior to performing the following functions all electrical power is to be removed from the system. External power disconnected and a "MAINTENANCE IN PROGRESS" tag attached or power switches will be locked out to prevent inadvertent energizing of the system.

**WARNING**

Lifting heavy equipment incorrectly can cause serious injury. Do not try to lift more than 35 pounds by yourself. Get a helper. Bend legs while lifting. Don't support heavy weight with your back.

**WARNING**

Adequate ventilation should be provided while using TRICHLOROTRIFLUOROETHANE.

Prolonged breathing of vapor should be avoided. The solvent should not be used near heat or open flame, the products of decomposition are toxic and irritating. Since TRICHLOROTRIFLUOROETHANE dissolves natural oils, prolonged contact with skin should be avoided. When necessary use gloves which the solvent cannot penetrate. If the solvent is taken internally, consult a physician.

Compressed air shall not be used for cleaning purposes except where reduced to less than 29 psi and then only with effective chip guarding and personnel protective equipment. Do not use compressed air to dry parts when TRICHLOROTRIFLUOROETHANE has been used.

Compressed air is dangerous and can cause serious bodily harm if protective means or methods are not observed to prevent chip or particle (of whatever size) from being blown into the eyes or unbroken skin of the operator or other personnel.

**D**

**SAFETY SUMMARY**

The following warnings and cautions appear within the text or illustrations of this manual. The warnings or cautions include a paragraph, figure or table reference to where they appear in text or illustrations.

**CAUTION**

Press relief valve button to equalize pressure before unlatching transit case. (1-25)

**WARNING**

Do not store or transport batteries in the closed transit case, or in a closed environment, for extended periods after they are activated (filled with electrolyte). An explosive mixture of hydrogen and air may result. (1-25, 1-31)

**WARNING**

Be extremely careful with incendiary devices and explosives. Use these items only when other means are not adequate. (1-34)

**WARNING**

Ensure work area is free from open flame, sparks, high voltage, and high rf, and that area is well ventilated.

**WARNING**

Personnel filling the batteries or otherwise handling the electrolyte should read the precautions outlined below to assure maximum safety and prevent injury which may result from accidental spillage of electrolyte. The electrolyte (a strong solution of potassium hydroxide) is alkaline and corrosive. It should be handled with care. If neglected, the electrolyte will cause serious burns when it is permitted to come in contact with the eyes or skin. Alkali-proof apron, rubber gloves, and splash-proof goggles or face mask are recommended for personnel engaged in the handling of the electrolyte.

Ordinarily, no trace of the alkaline electrolyte appears on the outside of the case of filled cells. However, personnel working with the batteries should wash their hands thoroughly after handling them. If the electrolyte is accidentally spilled it can be readily neutralized and washed away.

**ANTIDOTES, INTERNAL**

Give large quantities of water and a weak acid solution such as vinegar, lemon juice, or orange juice, followed with one of the following: white of egg, olive oil, starch water, mineral oil, or melted butter. Obtain medical attention at once.

**ANTIDOTES, EXTERNAL**

For the skin. Wash the affected area with large quantities of water. Neutralize with vinegar, lemon juice, or 5-percent acetic acid and wash with water. Obtain medical attention at once.

For the eyes: Flush thoroughly with water. Follow with saturated solution of boric acid. Use this first-aid treatment until medical aid can be summoned.

**SAFETY SUMMARY (Continued)****CAUTION**

Do not charge or discharge battery without a battery restrainer (such as filament-reinforced adhesive tape) or permanent damage will result to the battery from expansion.

**WARNING**

While charging, the battery voltage should not be allowed to exceed 31v during 400-milliampere charging rate, or 32v during 100-milliampere charging rate. If charging is continued above 31v or 32v respectively, it will cause excessive gassing, loss of electrolyte, and impaired battery life.

**CAUTION**

If there are gross differences in charging states between cells, the charging procedure will damage the charged cells.

**CAUTION**

Ensure that filling vent-well of each cell is clean and free of dirt, and do not allow any dirt to enter the cell (during the filling operation).

**CAUTION**

After filling, the dry-charge storage battery may evidence swelling perpendicular to the electrode face. The swelling may cause difficulties in subsequent cell replacement into the battery case. If excessive, it may also impair cell performance and sometimes cause cell cases to crack. To avoid swelling, the cells should be kept restrained with filament-reinforced adhesive tape at all times.

**WARNING**

Electrolyte will splash if the filling bottle is not firmly seated in vent-well, or if the filling bottle is squeezed too rapidly.

**WARNING**

As soon as the electrolyte (KOH) is added to the cells, they must be handled as fully charged cells; therefore exercise extreme care to avoid shorting the cells with any metallic object or other conductive material.

**WARNING**

While charging the battery voltage should not be allowed to exceed 32v during 100-milliampere charging rate. If charging is continued above 32v, it will cause excessive gassing, loss of electrolyte, and impaired battery life.

**F**

**SAFETY STATEMENT FOR BATTERY BA-5590/U****INTRODUCTION**

The purpose of this statement is to identify safety features and precautionary procedures to be followed by personnel using Battery BA-5590/U.

**DESCRIPTION**

The BA-5590/U primary battery is a high-energy power source that contains lithium metal, sulfur dioxide, and organic solvents under pressure (30-60 psia at 700F) in hermetically sealed stainless steel cells. The contents are potentially flammable and/or noxious. Dimensions are 4.40 x 2.45 x 5.00 inches. Weight is 2.5 pounds.

**SAFETY FEATURES**

The BA-5590/U battery can be electrically arranged to provide 12 or 24 volts. This dual voltage capability is achieved through the use of a specially designed connector which makes the proper voltage connection upon mating with the equipment.

The battery is protected by a 3.2 ampere slow blow replaceable fuse in each 12 volt section to protect against excessive currents or external short circuits which could lead to overheating, cell venting, or rupture. This fuse should not be bypassed or replaced with a higher rated fuse.

Each cell (ten per BA-5590/U) is designed with a venting device which releases internal cell pressure to ambient pressure if the internal pressure exceeds 350-450 psia. Venting will occur when pressures become excessive due to cells which have overheated (200-220<sup>0</sup>F) and serves to prevent the cell from rupturing. If a cell vents, sulfur dioxide gas will be released, which is a noxious eye and respiratory irritant. Irritation will occur long before toxic concentrations are reached and serves as an indication of its (SO<sub>2</sub>) presence. This battery contains no radioactive material.

**WARNING**

DO NOT USE unauthorized batteries or damaged batteries, and dispose of any batteries showing signs of damage.

**WARNING**

DO NOT USE lithium batteries in parallel circuitry unless the batteries or equipment are diode protected.

**G**



## PRECAUTIONS

**Storage:** Bulk storage of BA-5590/U batteries should be in a well ventilated, cool temperature facility. Refrigeration is not required. Battery life decreases with storage time and with increasing temperature. For this reason temperatures above 1300F should be avoided if possible.

**Handling:** The BA-5590/U battery contains pressurized cells similar to aerosol cans. Therefore, under no circumstances should the battery be deliberately opened, crushed, punctured, disassembled or otherwise mutilated. Rupture of the cell could occur.

The BA-5590/U battery should not be heated or incinerated, as overheating may produce internal pressure at a rate in excess of the venting capacity and could result in a cell or battery rupturing.

Under no condition should the batteries be recharged. Such action could lead to venting, rupturing, or rupturing with fire.

**Transportation:** Shipment of the BA-5590/U battery is regulated by the Department of Transportation in their Exemption 7052 and by the Department of the Army in TM 38-250.

## CAUTION

**Disposal:** Batteries are considered hazardous waste. Contact local property disposal officer for disposal instructions.

**Overheating:** In the unlikely event that an equipment operator detects the battery compartment becoming unduly hot, hears cells venting (hissing sound) or smells the irritating sulfur dioxide, he should immediately do the following:

1. Turn off equipment.
2. Remove equipment or leave immediate area of equipment and do not approach for 12 hours.
3. Carefully remove the battery from the equipment and place away from area of operation, after 12 hours.

**Fire:** In the event there are fires in which lithium batteries are involved, they are generally extinguishable with water in sufficient amounts so as to "flood" the burning materials. This will not only tend to cut off air access to the fire, but will cool down the batteries and surrounding combustibles so that cell venting and burning are minimized. If many cells have ruptured, lithium metal may be exposed. Burning lithium metal may respond satisfactorily to treatment with water. However, if not, efforts should be aimed at preventing the spread of the fire to other combustibles while letting the lithium metal burn itself out. Carbon dioxide extinguishers will not extinguish burning lithium metal but will extinguish other combustible materials within or near the battery.

**Voltage Delay:** If there is a delay in the operation of the equipment that exceeds two minutes, the battery should be replaced.

**Remove** the battery when the equipment does not operate properly and replace with a new battery.

**Battery Removal:** When equipment will not be used within 30 days, the battery should be removed from the equipment.

I/(J blank)

Technical Manual  
 No. 11-5820-919-12

HEADQUARTERS  
 DEPARTMENT OF THE ARMY  
 Washington, DC, 15 January 1986

**OPERATOR'S AND ORGANIZATIONAL  
 MAINTENANCE MANUAL**

**RADIO SET  
 AN/PRC-104A  
 (NSN 5820-01-141-7953)**

**REPORTING OF ERRORS AND RECOMMENDING IMPROVEMENTS**

You can help improve this manual. If you find any mistakes or if you know of a way to improve the procedures, please let us know. Mail your letter, DA Form 2028 (Recommended Changes to Publications and Blank Forms), or DA Form 2028-2 located in the back of this manual direct to: Commander, US Army Communications-Electronics Command and Fort Monmouth, ATTN: AMSELME-MP, Fort Monmouth, NJ 07703-5007. A reply will be furnished to you.

**TABLE OF CONTENTS**

Section		Page
	WARNINGS .....	A through E
	SAFETY STATEMENT FOR BATTERY BA-5590/U.....	G through I
0	GENERAL.....	0-1
0-1	Scope .....	0-1
0-2	Consolidated Index of Army Publications and Blank Forms .....	0-1
0-3	Maintenance Forms, Records and Reports .....	0-1
0-4	Reporting Equipment Improvement Recommendations .....	0-1
0-5	Administrative Storage .....	0-1
0-6	Destruction of Army Electronics Materiel .....	0-1

Section	Page
LIST OF ILLUSTRATIONS .....	vii
LIST OF TABLES .....	viii
<b>CHAPTER 1 GENERAL INFORMATION</b>	
<b>I GENERAL INFORMATION .....</b>	<b>1-1</b>
1-1 Scope of Technical Manual .....	1-1
1-5 Equipment Description.....	1-1
1-6 Introduction .....	1-1
1-8 Relationship of AN/PRC-104 Equipments .....	1-2
1-9 Radio Set .....	1-2
1-10 Manpack Operation .....	1-2
1-11 Battery Pack.....	1-2
1-13 Fixed-Site Operation.....	1-2
1-15 Reference Data.....	1-7
1-17 Technical Characteristics.....	1-7
1-18 Equipment Supplied.....	1-7
1-19 Equipment Not Supplied .....	1-7
1-20 Support Equipment .....	1-7
1-21 List of Publications.....	1-7
<b>II PREPARATION FOR USE .....</b>	<b>1-14</b>
1-22 Transportation and Storage .....	1-14
1-24 Installation and Setup .....	1-14
1-26 Initial Checkout .....	1-14
1-28 Preliminary Setup.....	1-14
1-29 Test Procedure .....	1-14
1-30 Disassembly and Packup .....	1-16
<b>III DEMOLITION TO PREVENT ENEMY USE .....</b>	<b>1-17</b>
1-32 General .....	1-17
<b>CHAPTER 2 OPERATION INSTRUCTIONS</b>	
2-1 Introduction .....	2-1
<b>I CONTROLS AND INDICATORS.....</b>	<b>2-1</b>
2-3 General .....	2-1
2-5 Controls and Indicators.....	2-1
2-6 Receiver/Exciter.....	2-1
2-7 Amplifier/Coupler .....	2-1

**TABLE OF CONTENTS (Continued)**

<b>Section</b>		<b>Page</b>
2-8	Audible Indicators .....	2-1
2-10	Low Battery Indicator .....	2-1
2-11	Power Output Indicator .....	2-1
2-12	Tuning Indicator .....	2-1
2-13	No-Tune Indicator .....	2-3
2-14	Indicator .....	2-3
2-15	Bypass .....	2-4
<b>II</b>	<b>OPERATING CONSIDERATIONS .....</b>	<b>2-5</b>
2-16	General .....	2-5
2-18	Optimizing Communication with the AN/PRC-104.....	2-5
2-21	Antenna Selection.....	2-5
2-26	Frequency Selection .....	2-7
2-30	Site Selection .....	2-7
2-33	Modes of Operation .....	2-7
2-35	Normal Communications .....	2-7
2-36	Radio Silence.....	2-7
2-37	Data Communication .....	2-7
2-38	Telegraph Communications .....	2-8
2-39	Data Transceive .....	2-8
<b>CHAPTER 3 THEORY OF OPERATION</b>		
3-1	Introduction .....	3-1
<b>I</b>	<b>OVERALL FUNCTIONAL DESCRIPTION .....</b>	<b>3-1</b>
3-3	General .....	3-1
3-5	Radio Set Functional Description .....	3-1
3-8	Transmit Operation .....	3-1
3-9	Receive Operation .....	3-1
3-10	Control Panel .....	3-1
3-11	Synthesizer .....	3-3
3-12	Demodulator .....	3-3
3-13	Power Amplifier.....	3-3
3-14	Harmonic Filter .....	3-3
3-15	Antenna Tuner .....	3-3
3-16	Power Supply.....	3-3
<b>II</b>	<b>FUNCTIONAL BLOCK DIAGRAM .....</b>	<b>3-5</b>
3-17	General .....	3-5
3-19	Control Panel .....	3-5
3-20	Frequency Selection.....	3-5
3-21	Operational Mode .....	3-5

**TABLE OF CONTENTS (Continued)**

<b>Section</b>		<b>Page</b>
	3-23 Sideband Selection .....	3-5
	3-24 Volume Control .....	3-5
	3-25 Panel Illumination.....	3-5
	3-26 Audio Filtering .....	3-5
	3-27 Power Supply.....	3-5
	3-28 Synthesizer.....	3-5
	3-31 Modulator/Demodulator .....	3-7
	3-35 Power Amplifier.....	3-10
	3-36 Harmonic Filter.....	3-11
	3-37 Antenna Tuner .....	3-11
 <b>CHAPTER 4 MAINTENANCE INSTRUCTIONS</b> 		
	4-1 Introduction.....	4-1
<b>I</b>	<b>PREVENTIVE MAINTENANCE</b> .....	<b>4-1</b>
	4-3 General .....	4-1
	4-5 Periodic Checks and Services .....	4-1
	4-6 Daily Checks and Services.....	4-1
	4-7 Weekly Checks and Services .....	4-1
	4-8 Quarterly Checks and Services.....	4-1
	4-9 Cleaning .....	4-1
	4-11 Corrosion Control .....	4-1
<b>II</b>	<b>TROUBLESHOOTING</b> .....	<b>4-3</b>
	4-13 General .....	4-3
	4-15 Use of Audible Tones.....	4-3
	4-16 Performance Test.....	4-3
<b>III</b>	<b>REPAIR</b> .....	<b>4-11</b>
	4-19 General .....	4-11
	4-21 Removal .....	4-11
	4-22 Replacement .....	4-11

TABLE OF CONTENTS (Continued)

Section		Page
	<b>APPENDIX I. LIST OF ABBREVIATIONS</b>	A1-1
	<b>APPENDIX II. PROPAGATION OF RADIO WAVES</b>	
A2-1	General .....	A2-1
A2-3	Radio Waves .....	A2-1
A2-5	Ground Wave .....	A2-1
	A2-6    Surface Wave .....	A2-1
	A2-7    Direct Wave .....	A2-1
A2-8	Skywave .....	A2-1
A2-9	Maximum Usable Frequency.....	A2-1
A2-10	Frequency of Optimum Transmission (FOT) .....	A2-1
A2-11	Multi-Skip Phenomenon .....	A2-1
A2-12	HF Band Segments.....	A2-1
	A2-13    2 Thru 5 MHz .....	A2-2
	A2-14    5 Thru 10 MHz .....	A2-2
	A2-15    10 Thru 15 MHz .....	A2-2
	A2-16    15 Thru 25 MHz .....	A2-2
	A2-17    25 Thru 30 MHz .....	A2-4
A2-18	Situational Examples.....	A2-4
A2-20	Situation I .....	A2-4
	A2-21    Scenario.....	A2-4
	A2-22    Recommendation.....	A2-4
A2-23	Situation 2 .....	A2-4
	A2-24    Scenario.....	A2-4
	A2-25    Recommendation.....	A2-4
	<b>APPENDIX III DIPOLE ANTENNA KIT</b>	
A3-1	General .....	A3-1
A3-4	Slant Wire Antenna .....	A3-1
A3-5	Dipole Antenna.....	A3-3

TABLE OF CONTENTS (Continued)

Appendix

A	References .....	A-1
B	Maintenance Allocation .....	B-1
C	Components of End Item List.....	C-1
D	Additional Authorization List .....	D-1
E	Expendable Supplies and Materials List .....	E-1

<b>ALPHABETICAL INDEX.....</b>	<b>Index-1</b>
--------------------------------	----------------



## LIST OF ILLUSTRATIONS

Figure	Title	Page
1-0	Radio Set AN/PRC-104.....	1-0
1-1	Radio Set AN/PRC-104 Equipment Supplied (2 Sheets).....	1-3
1-2	Relationship of Radio Set AN/PRC-104 Equipments.....	1-5
1-3	Manpack Operation.....	1-6
1-4	Radio Set Installation and Setup.....	1-15
2-1	AN/PRC-104 Controls and Indicators.....	2-2
2-2	Antennas for Use With the Radio Set.....	2-6
3-1	Radio Set System Block Diagram.....	3-2
3-2	Radio Set Simplified Block Diagram.....	3-4
3-3	Control Panel Pictorial Block Diagram.....	3-6
3-4	Power Supply Block Diagram.....	3-7
3-5	Synthesizer Block Diagram.....	3-8
3-6	Modulator/Demodulator Block Diagram.....	3-9
3-7	Power Amplifier Block Diagram.....	3-10
3-8	Harmonic Filter Block Diagram.....	3-11
3-9	Antenna Tuner Block Diagram.....	3-11
4-1	Operator's Radio Set Performance Test With Audible Tones.....	4-5
4-2	Organizational Radio Set Performance Test Setup.....	4-7
4-3	Organizational Radio Set Performance Test.....	4-9
4-4	Battery Pack.....	4-12
4-5	Battery Pack Component Location.....	4-14
4-6	Battery Charger Cable.....	4-21
A2-1	Ground Wave Propagation.....	A2-2
A2-2	Skywave Propagation.....	A2-2
A2-3	Relative Skip Distance for Two Different Frequencies.....	A2-3
A2-4	Short Range (Less Than 100 Miles) HF Communications Effectiveness.....	A2-5
A2-5	Intermediate Range (100-500 Miles) HF Communications Effectiveness.....	A2-6
A2-6	Site Selection, Situation 2.....	A2-7
A3-1	Dipole Antenna Kit.....	A3-1
A3-2	Slant Wire Antenna.....	A3-4
A3-3	Two-Support Dipole Antenna.....	A3-5
A3-4	Sloping Dipole Antenna.....	A3-5
A3-5	Inverted-V Dipole Antenna.....	A3-6
A3-6	Attaching Antenna Wires to Dipole Fixture.....	A3-6
A3-7	Antennas for Use With Radio Set.....	A3-7

LIST OF TABLES

Table	Title	Page
1-1	Technical Characteristics .....	1-8
1-2	Equipment Supplied .....	1-10
1-3	Equipment Not Supplied.....	1-12
1-4	Test Equipment .....	1-12
1-5	List of Publications .....	1-13
2-1	Receiver/Exciter Controls and Indicators .....	2-3
2-2	Amplifier/Coupler Controls and Indicators.....	2-4
4-1	Daily Checks and Services.....	4-2
4-2	Weekly Checks and Services.....	4-2
4-3	Fault Indication by Audible Tones .....	4-4
4-4	Filling Kit.....	4-17
A3-1	Antenna Length Chart .....	A3-2

**SECTION 0****GENERAL**

---

0-1. SCOPE. This manual covers Radio Set AN/PRC-104(A). This manual provides instructions for general support maintenance. Throughout this manual AN/PRC-104 should be AN/PRC-104(A).

0-2. CONSOLIDATED INDEX OF ARMY PUBLICATIONS AND BLANK FORMS. Refer to the latest issue of DA Pam 310-1 to determine whether there are new editions, changes or additional publications pertaining to the equipment.

0-3. MAINTENANCE FORMS, RECORDS, AND REPORTS

a. *Reports of Maintenance and Unsatisfactory Equipment.* Department of the Army forms and procedures used for equipment maintenance will be those prescribed by DA Pam 738-750 as contained in Maintenance Management Update.

b. *Report of Packaging and Handling Deficiencies.* Fill out and forward SF 364 (Report of Discrepancy (ROD)) as prescribed in AR 735-11-2/DLAR 4140.55/NAVMATINST 4355.74A/AFR-400-54/MCO 4430.3F.

c. Discrepancy in Shipment Report (DISREP) (SF 361). Fill out and forward Discrepancy in Shipment Report (DISREP) (SF 361) as prescribed in AR 55-38/NAVSUPINST 4610.33C/AFR 75-18/MCO P4610.19/DLAR 4500.15.

0-4. REPORTING EQUIPMENT IMPROVEMENT RECOMMENDATIONS (EIR). If your Radio Set AN/PRC-104(A) needs improvement, let us know. Send us an EIR. You, the user, are the only one who can tell us why you don't like the design. Put it on an SF 368 (Quality Deficiency Report). Mail it to Commander, US Army Communications-Electronics Command and Fort Monmouth, ATTN: AMSEL-ME-MP, Fort Monmouth, New Jersey 07703-5007. We'll send you a reply.

0-5. ADMINISTRATIVE STORAGE. Administrative Storage of equipment issued to and used by Army activities will have preventive maintenance performed in accordance with the PMCS charts before storing. When removing the equipment from administrative storage the PMCS should be performed to assure operational readiness. Disassembly and repacking of equipment for shipment or limited storage are covered in TM 740-90-1.

0-6. DESTRUCTION OF ARMY ELECTRONICS MATERIEL. Destruction of Army electronics materiel to prevent enemy use shall be in accordance with TM 750-244-2.

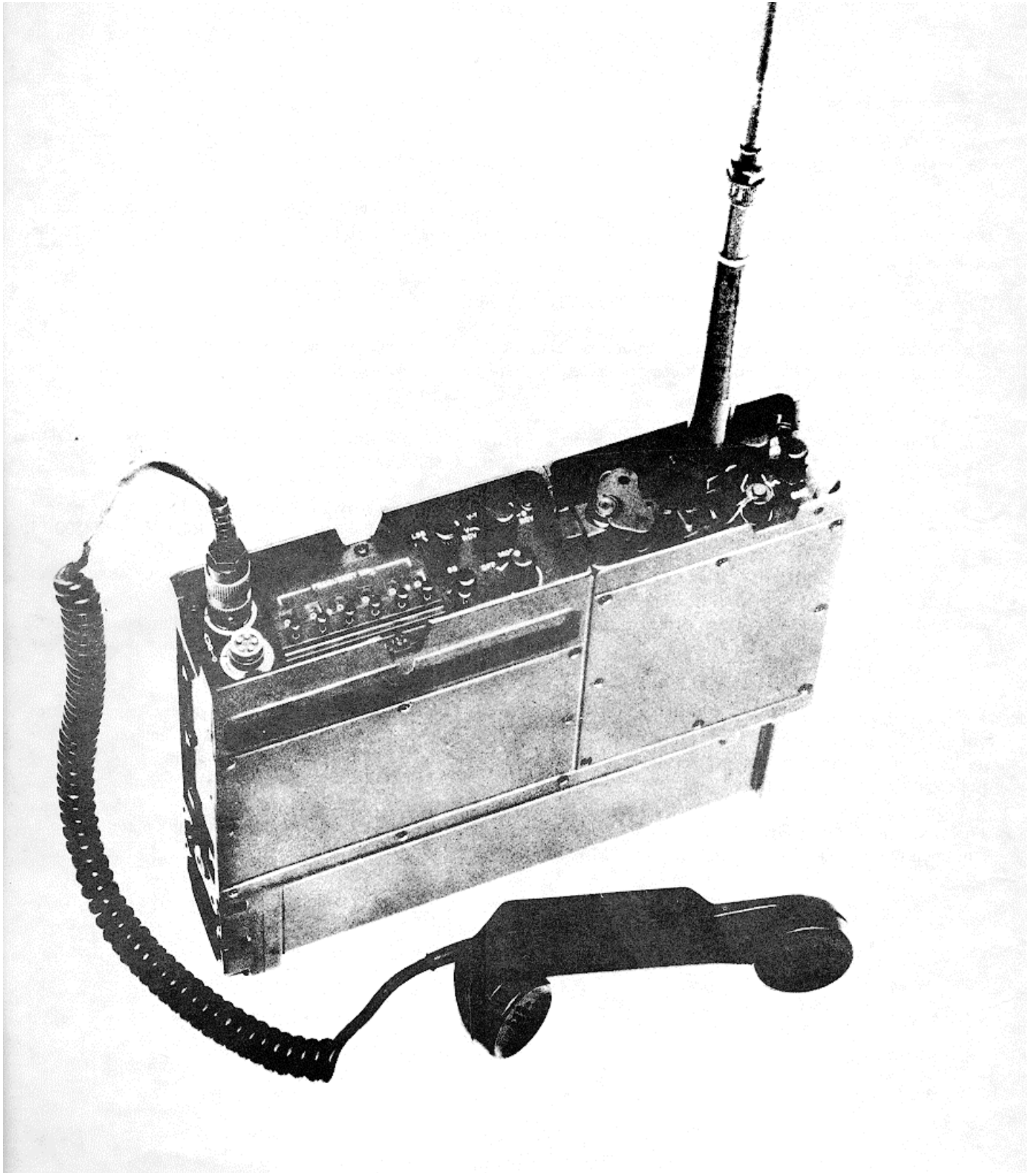

Figure 1-0. Radio Set AN/PRC-104

## CHAPTER 1

### GENERAL INFORMATION

#### SECTION I

### GENERAL INFORMATION

#### 1-1. SCOPE OF THE TECHNICAL MANUAL.

**1-2.** This technical manual provides operator's and organizational maintenance information covering Radio Set AN/PRC-104 (radio set). The information includes operating instructions, installation and setup, theory of operation and maintenance data. Additionally, the propagation of radio waves in the high frequency (hf) radio spectrum is discussed relative to optimizing communications with this radio set. Complete coverage for Battery Case CY-7875/ PRC-104 (battery pack) is provided in this manual, because the battery pack is maintained entirely at the organizational level.

**1-3.** Complete coverage of the radio set, including Receiver-Transmitter RT-1209/URC (receiver/ exciter) and Radio Frequency Amplifier AN1-6874/ PRC-104 (amplifier/coupler), for field and depot levels of maintenance is provided in the following manuals:

1. General Support Maintenance Manual TM 11-5820-919-40-1. Contains reference data, theory of operation and disassembly and reassembly for the complete radio set. It also provides test troubleshooting, alignment and repair data for the radio set and the receiver/exciter and amplifier/coupler units necessary to replace unit components and modules.

2. General Support Maintenance Manual TM 11-5820-919-40-2. Contains maintenance prints for the radio set, units and modules.

Maintenance prints include all schematics; power distribution; component location; test and alignment setup; performance test and alignment required for complete field maintenance of the radio set.

3. Rebuild Standards RS-07748A-50/4. Contains depot-unique repair and rebuild data for the radio set that is not covered in the field maintenance manuals.

4. Repair Parts and Special Tools List TM 11-5820-919-24P. Contains complete parts ordering data for all levels of radio set maintenance.

**1-4.** Chapter 1 of this technical manual provides general reference data and information on the physical aspects and technical characteristics of the radio set. It also covers setup, initial checkout, and demolition to prevent enemy use. Chapter 2 contains operating instructions, and also discusses various operating environments for optimizing communication. Chapter 3 provides system and functional theory of operation. Chapter 4 contains maintenance instructions including preventive maintenance, troubleshooting, and repair down to replacement of units and accessories. Appendix I, at the back of this manual, contains a list of abbreviations used. Appendix II provides a discussion of hf radio wave propagation and gives Situational examples for optimizing communications. Appendix III provides instructions for use of the dipole antenna kit.

#### 1-5. EQUIPMENT DESCRIPTION.

**1-6. INTRODUCTION.** The AN/PRC-104 is a state-of-the-art lightweight radio transceiver that operates in the high frequency (hf) and upper part of the low frequency (lf) portions of the radio spectrum.

The receiver/transmitter circuits can be tuned to any frequency between 2.0000 and 29.9999 MHz in 100 Hz increments, making it possible to tune up to 280,000 separate frequencies. The radio set operates in the upper sideband (USB) or lower sideband (LSB) modes for voice communications, CW for Morse code, or frequency shift keying (FSK) for transmission of teletype or other data. In the man-pack configuration the radio set is designed to be carried and operated by one man or, with the proper accessories, can be configured for vehicular or fixed station use.

**1-7.** The control panel has been human-engineered for ease of operation making it possible to adjust all controls even while wearing heavy gloves. Unlike older similar radio sets, there are no front panel meters or indicator lights on the AN/PRC-104. All functions which formerly required these types of indicators (antenna tuning, battery condition, etc.) are monitored by the radio itself and communicated to the operator as special tones in the handset. This feature is particularly useful during tactical black-out operations. The superior design and innovative features of the AN/PRC-104 radio set now make it possible to maintain a reliable long-range communications link using lightweight, portable equipment that can be operated by personnel with a minimum of training.

### **1-8. RELATIONSHIP OF AN/PRC-104 EQUIPMENTS (Figures 1-1 and 1-2).**

**1-9. Radio Set.** The Radio Set AN/PRC-104 (radio set) consists of three units: low-power Receiver Transmitter RT-1209/URC (receiver/exciter), 20-watt Radio Frequency Amplifier AM-6874/PRC-104 (amplifier/coupler), and Battery Case CY-7875/PRC104 (battery pack). Quick-disconnect latches secure the receiver/exciter to the amplifier/coupler, and each is latched to one end of the battery pack. When latched together, the receiver/exciter is electrically interconnected with the amplifier/coupler via a built-in connector; the battery pack power is connected to the amplifier/coupler. All operator controls and connections are located on the receiver/exciter front panel, except for the antenna select switch and antenna connections which are on the amplifier/coupler front panel. The receiver/exciter and amplifier/coupler units are constructed on a die-cast aluminum housing, the battery pack housing is tough plastic. Watertight seals for the covers and panels make the three units watertight, submersible, and capable of rough handling and abuse of any field environment. The unit circuits are modular for ease of repair. The total weight of the assembled AN/PRC-104 (three units with battery) is 14 pounds, making a lightweight and easily carried package.

**1-10. Manpack Operation.** The basic Manpack configuration consists of the radio set (three units), a whip antenna and an audio input/output device. Antenna AT-217A/PRC is a 10-foot standard whip antenna that screws into Spring Section Antenna AB129PR shock mount which in turn screws into the antenna mount on the amplifier/coupler. The whip

antenna will be adequate for most short range requirements (less than 10 miles). Two standard input/output devices come with the radio set: Handset H-189/GR (handset) and Telegraph Key KY-872/ PRC-104. These are attached to either of the two AUDIO connectors on the receiver/exciter. The radio transmitter (exciter) is enabled (keyed) by the handset push-to-talk (PTT) button or depressing the telegraph key to contact. The receiver is operative only when the transmitter is disabled, therefore, communication is on a one-way reversible (half duplex) basis. The radio set with whip and handset weighs 15.7 pounds.

**1-11. Battery Pack.** The radio set operates from a nominal 28-volt dc battery pack, with acceptable voltage input between 20 and 32 vdc. The battery pack consists of 16 silver-zinc storage battery cells, inside the battery case. It is normally latched to the other two units, but may also be connected to the amplifier/coupler via the 3-foot Electrical Power Cable Assembly CX-13031/PRC-f04 (battery extender cable). This connection permits the battery pack to be carried by the operator under the protection of cold weather clothing to extend battery operating life. Normal life of the battery pack is approximately 16 hours of operation, assuming 10 percent transmit time. The silver-zinc battery pack is charged using Battery Charger PP-6241/t' via the battery charger cable, Electrical Power Cable Assembly CX-13032/PRC-104. For maintenance or operation of the radio set without the battery pack, a dc power source can be connected to the amplifier/coupler via the bench test cable, Electrical Power Cable Assembly CX-13030/PRC-104.

**1-12.** In the manpack configuration, the radio set and accessories are carried in the military standard ALICE backpack (All-Purpose Lightweight Individual Carrying Equipment). The backpack may be used to carry spare battery packs and other accessories.

**1-13. Fixed-Site Operation.** When the tactical situation permits, the effective range of the AN/PRC104 may be extended by utilizing Antenna AS-2259/ GR, the 15-foot near-vertical incidence Skywave (N) antenna, or a simple half-wave dipole. Two-foot long Radio Frequency Cable Assembly CG-3815/ \_antenna base cable) is used to connect the N-VIS Antenna Base AB-1241/PRC-104 to the BNC jack of the amplifier/coupler.

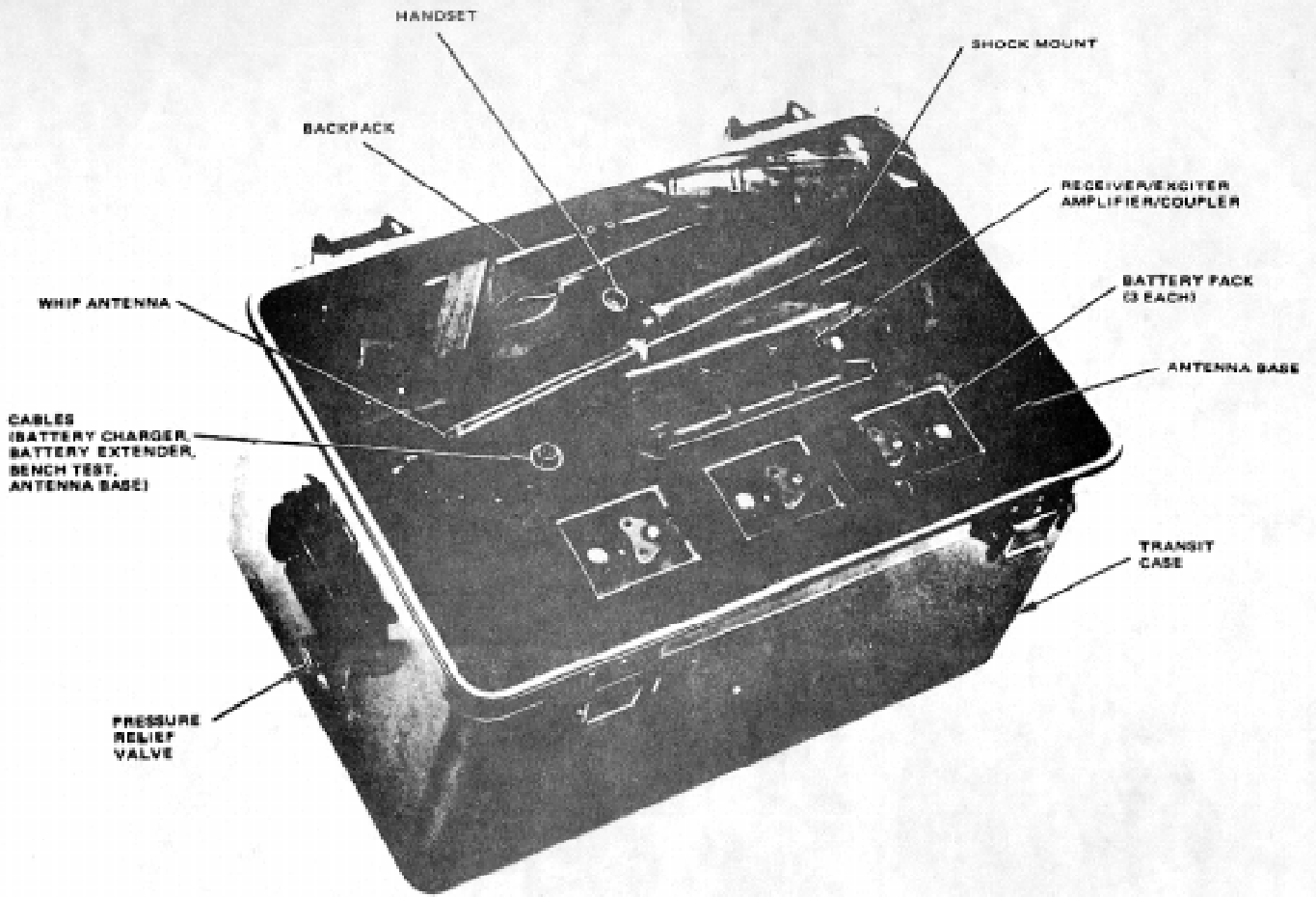

Figure 1-1. Radio Set AN/PRC-104 Equipment Supplied (Sheet 1 of 2)

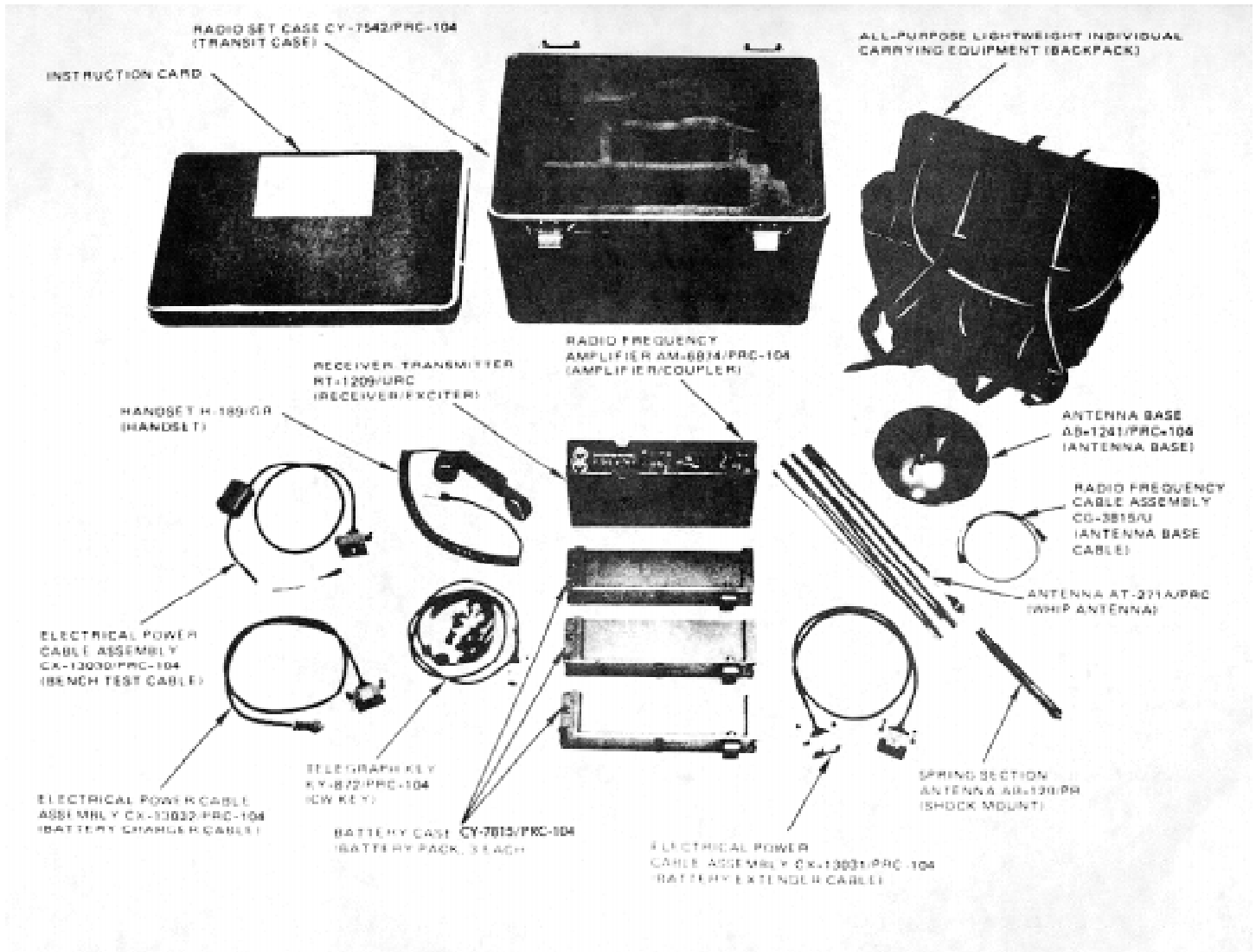
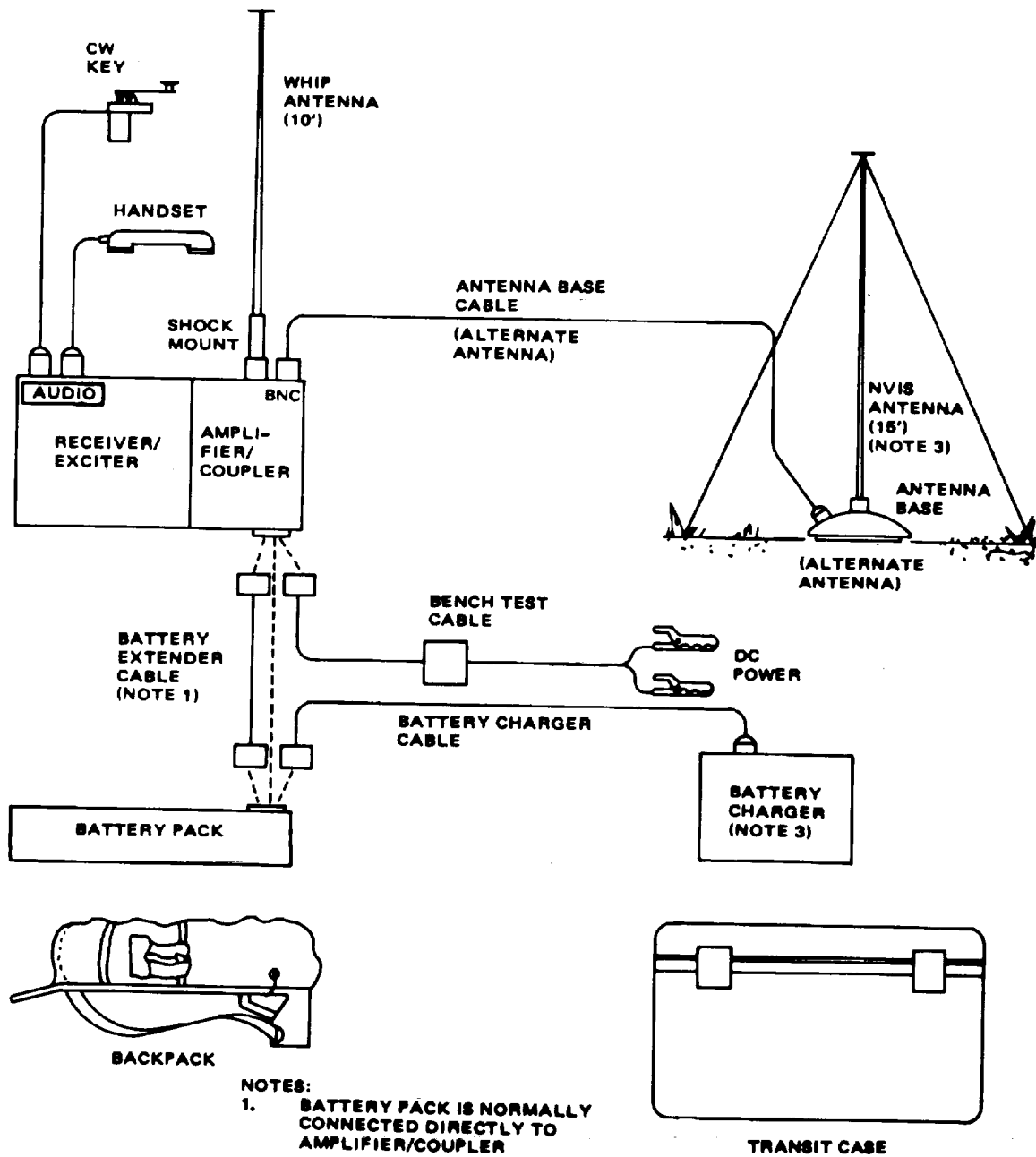

Figure 1-1. Radio Set AN/PRC-104 Equipment Supplied (Sheet 2 of 2)





- NOTES:**
1. BATTERY PACK IS NORMALLY CONNECTED DIRECTLY TO AMPLIFIER/COUPLER
  2. EQUIPMENT IS IDENTIFIED BY COMMON NAMES. FOR FULL NOMENCLATURE SEE TABLES 1-2 AND 1-3, AND FIG. 1-1.
  3. NOT INCLUDED IN TRANSIT CASE.

Figure 1-2. Relationship of Radio Set AN/PRC-104 Equipments



*Figure 1-3. Manpack Operation*  
1-6

**1-14.** The radio set and accessory equipments are supplied and transported in Radio Set Case CY-8291/PRC-104 (transit case). All accessories, except the NVIS antenna and the battery charger, are supplied as standard equipment in the transit case, together with the radio set.

**1-15. REFERENCE DATA.**

**1-16.** The following paragraphs provide the reference data for the radio set and accessory equipment.

**1-17. TECHNICAL CHARACTERISTICS.**

Technical characteristics for the radio set are listed in table 1-1.

**1-18. EQUIPMENT SUPPLIED.** The radio set and accessory equipment that are supplied in the transit case are listed in table 1-2 and shown in figure 1-1.

**1-19. EQUIPMENT NOT SUPPLIED.** Table 1-3 lists the equipment that may be used with the radio TM 11-5820-919-12

set, but is not supplied in the transit case.

**1-20. SUPPORT EQUIPMENT.** The test equipment required to perform organizational maintenance of the radio set is listed in table 1-4. Equivalent test equipment may be used.

**NOTE**

Use only test equipment that is properly calibrated. Failure to do so may provide erroneous and misleading performance or fault indications.

**1-21. LIST OF PUBLICATIONS.** Table 1-5 lists the current publications applicable to the radio set. Publication numbers beginning with TM are for Marine Corps technical manuals; those beginning with TO are for Air Force technical orders. Joint service publications carry both TM and TO publication numbers.

TABLE 1-1. TECHNICAL CHARACTERISTICS

Characteristic	Description
<b>RADIO SET AN/PRC-104 (Radio Set)</b>	
Frequency Range increments	2.0000 to 29.9999 MHz in. 0.0001 MHz (100 Hz)
Frequency Accuracy	(280,000 possible frequency settings) + 1 ppm for -51 °F (-46 °C) to +160 °F (+71°C) (+2 to 30 Hz of setting) from 2 to 30 MHz respectively.
Operating Modes	<ul style="list-style-type: none"> <li>- Single sideband (selectable USB or LSB)</li> <li>- Voice/cw (Morse or burst cw at 300 wpm)</li> <li>- Data (FSK or DPSK up to 2400 bps) compatible with 75 baud military teletype</li> <li>- Receive only (inhibits transmit operation)</li> </ul>
Audio Input Impedance and Level	150 ohms, -56 dbm (voice) 600 ohms, 0 dbm (data)
RF Output Power	20w (PEP), 0.25w (PEP) exciter output
RF Output Impedance due to antenna short or open	50-ohms, unbalanced. Output protected to infinite VSWR
Antenna Tuning (typical)	Automatic to 1.5:1 VSWR (3 seconds tuning time,
Power Requirements	20.0 to 32.0 vdc; 3.5 amp at 24.0 vdc for transmit; 200 ma for receive
Operating Temperature Range	-51 °F (-46 °C) to +160 °F (+71 °C)
Environmental	Meets applicable provisions of MIL-STD-810B
Mean Time Between Failure (MTBF)	2500 hours (demonstrated per MIL-STD-785)
Mean Time to Repair (MTTR)	15 minutes (module replacement)
Dimensions	12-1/2" x 10 1/2" x 2 5/8" (31.75 cm x 26.67 cm x 6.66 cm) DxWxH
Weight	14 pounds (6.36 kg), including 4.8 AH silver-zinc battery (without accessories).

TABLE 1-1. TECHNICAL CHARACTERISTICS (Continued)

Characteristic	Description
<b>RECEIVER</b>	
Sensitivity	
SSB, CW, FSK Selectivity	0.7iuv for 10 db SINAD 2.5 kHz Bandwidth at -3 db
SSB	6 kHz Bandwidth at -60 db
Image Rejection	70 db
I.F. Rejection	60 db
Audio Output	25 mw into 500fl (nominal)
Audio Distortion Desensitization (signal to degrade SINAD 3 db)	5% at 5 mw, 350 to 3000 Hz +2.5% to -29 dbm; +10% to -15 dbm; +50% to + 17 dbm
<b>TRANSMITTER</b>	
RF Output Power	0.25w (PEP) for RT-1209, 20w +2 db (PEP or average) with AM-6874
Duty Cycle	1 minute continuous keydown
Intermodulation Distortion (IMD)	9:1 transmit/receive ratio -25 db (two equal tones at rated output power)
Harmonic Radiation	-50 db
Carrier Suppression	-42 db
Unwanted Sideband Suppression	-45 db
All Other Spurious	-45 to -60 db
<b>BATTERY PACK</b>	
Batteries	Primary, Lithium or Storage, NICAD

TABLE 1-2. EQUIPMENT SUPPLIED

Nomenclature	Manufacturer's Part Number	Common Name	Overall Dimensions	Weight
Case, Radio SET CY-8291/PRC-104A		transit case	14.5 in. (36.83 cm) wide 15.25 in. (38.74 cm) high 22.0 in. (55.88 cm) long	28.0 lb (12.70 kg)
Radio Set AN/PRC-104A	75502A0050	radio set	12.5 in. (31.75 cm) wide 10.5 in. (26.67 cm) high 2.62 in. (6.66 cm) deep	14 lb (6.36 kg) (3 units, including battery)
Receiver-Transmitter RT-1209/URC	75502A0150	receiver/exciter	7.25 in. (18.42 cm) wide 7.25 in. (18.42 cm) high 2.62 in. (6.66 cm) deep	5.9 lb (2.68 kg)
Amplifier, Radio Frequency AM-6874/PRC-104	755002A0550	amplifier/coupler	5.25 in. (13.34 cm) wide 7.25 in. (18.42 cm) high 2.62 in. (6.66 cm) deep	4.1 lb (1.86 kg)
Case, Battery CY-7875/PRC-104A	battery pack	12.5 in.	4.0 lb (31.75 cm) wide 3.25 in. (8.26 cm) high 3.25 in. (8.26 cm) deep	(1.81 kg) (including battery)
Storage Battery, Lithium or NICAD		battery		
Cable Assembly, Power, Electrical CX-13030/PRC-104	755002A1255	bench test cable	48.0 in. (121.92 cm) long	
Cable Assembly, Power, Electrical CX-13031/PRC-104	755002A1260	battery extender cable	48.0 in. (121.92 cm) long	
Cable Assembly, Power, Electrical CX-13032/PRC-104	755002A1250	batters charger cable	48.0 in. (121.92 cm) long	
		<b>1-10</b>		

TABLE 1-2. EQUIPMENT SUPPLIED (Continued)

Nomenclature	Manufacturer's Part Number	Common Name	Overall Dimensions	Weight
Cable Assembly, Radio Frequency CG- 3815/U	755002A7114-1	antenna base cable	24.0 in (60.96 cm) long	...
Antenna, Spring Section AB- 129/PR	SC-D-20938	shock mount	...	...
Antenna AT-271A/PRC	SM-D-182392	whip antenna	10 ft (3.048 m) long	0.7 lb0 (0.32 kg)
Bas, Antenna AB-1241/PRC-104	755002A0900	antenna base	...	...
Handset H-189/CR	4139440-1	handset	...	1.0 lb (0.45 kg)
Key, Telegraph KY-872/PRC- 104	755002A1000	CW key	...	...
Card, Instruction	755002A0057	instruction card	...	...
ALICE (All-Purpose Lightweight Individual Carrying Equipment)		backpack	...	4.0 lb (1.81 kg)
Field Pack	4100050-17	field pack	...	...
Frame, Shelf, Pack	4100050-18	frame shelf	...	...
Strap, Frame Assembly	4100050-16	frame strap	...	...
Strap Webbing	4100050-10	webbing strap	...	...

**TABLE 1-3. EQUIPMENT NOT SUPPLIED**

Nomenclature	Common Name	Purpose
Antenna AS-2259/GR	NVIS antenna	Alternate antenna
Charger, Battery PP-6241/U	battery charger	Charge the battery pack

**TABLE 1-4. TEST EQUIPMENT**

Name	Designation	Item Parameters	Quantity
*VTVM	AN/USM-116	voltage and current measurement	1
*Signal Generator, RF	AN/USM-323	2 - 30 MHz, -110 to +20 db	1
*Watt Meter, RF	AN/URM-203	2 - 30 MHz, 20w ± 20db	1
*Dummy Load, Electrical	DA-371-U	0 - 100 w (de-5 GHz)	1
Battery Charger	PP-6241/U	400 ma max at +31v, 100 ma max at +32v (for silver-zinc batteries)	1

\*Not required for Air Force organizational maintenance.  
 \*\*Dummy load is used as termination for the watt meter.



TABLE 1-5. LIST OF PUBLICATIONS

Title	Publication Number
Radio Set AN/PRC-104(A)	
Operator's and Organizational Maintenance Manual	TM 11-5820-919-12
General Support Maintenance Manual	TM 11-5820-919-40-1
General Support Maintenance Manual	TM 11-5820-919-40-2
Rebuild Standards	RS-07748A-50/4
Repair Parts and Special Tools List	TM 11-5820-919-24P
Antenna AS-2259/GR and Antenna-to-Antenna Base Adapter MX-9313/GR	TM 11-5985-379-14&P
1-13	

## SECTION II

### PREPARATION FOR USE

#### 1-22. TRANSPORTATION AND STORAGE (Figure 1-1).

1-23. The radio set and standard accessories are contained, transported and stored in Radio Set Case CY-8291/PRC-104 (transit case). The transit case should normally be kept closed. To unpack the equipment, unfasten the four latches and remove the transit case cover. Each of the individual pieces of equipment fit in a molded space, as shown in figure 1-1. Check that the equipment is complete and inspect the equipment for any damage incurred during shipment.

#### 1-24. INSTALLATION AND SETUP (Figure 1-4).

1-25. Installation and setup of the radio set is accomplished as follows.

#### CAUTION

Press relief valve button to equalize pressure before unlatching transit case.

1. Unfasten the 4 latches securing the cover to the transit case and remove cover
2. Remove the receiver/exciter - amplifier/ coupler combination from the transit case
3. Remove one of the three (3) battery packs from the transit case. For initial battery filling, refer to paragraph 4-36. For battery charging, refer to paragraph 4-42.

#### WARNING

Do not store or transport batteries in the closed transit case, or in a closed environment for extended after they are activated (filled with electrolyte). An explosive mixture of hydrogen and air may result.

4. Attach the activated battery pack to the bottom of the receiver/exciter amplifier/coupler units using the latches.

5. Remove the whip antenna from the transit case and assemble.

6. Attach the whip antenna to antenna shock mount.

7. Attach the antenna shock mount (with whip antenna attached) to the amplifier/coupler antenna socket. The radio is now ready for initial checkout.

#### 1-26. INITIAL CHECKOUT.

1-27. Perform the following test procedure for initial checkout of the radio set in an operating environment. If any of the results are abnormal refer to the troubleshooting procedure in chapter 4. Refer to figure 2-1 for location of controls and indicators.

#### 1-28. PRELIMINARY SETUP.

1. Connect a handset to the radio set.
2. Set the radio set controls as follows.
  - a. MODE to V-TR
  - b. ANT/SEL to whip connection position
  - c. FREQUENCY-KHZ to 02,221.2 (USB)
  - d. VOLUME - Desired listening level. (If a clicking sound is heard, this indicates that the battery voltage is low (20 or less) and should be replaced or recharged. Refer to paragraph 4-42.

#### 1-29. TEST PROCEDURE.

1. Momentarily press the handset PTT switch. Verify that the handset emits a 1-kHz sidetone which terminates in less than 12 seconds. This indicates the automatic antenna tuner is operating normally. Failure of the antenna to tune properly is indicated by continuous, rapid beeping in the handset (fault tone)

2. Transmit, using a handset. If possible, communicate with base station at this test frequency. Presence of a sidetone indicates transmission is

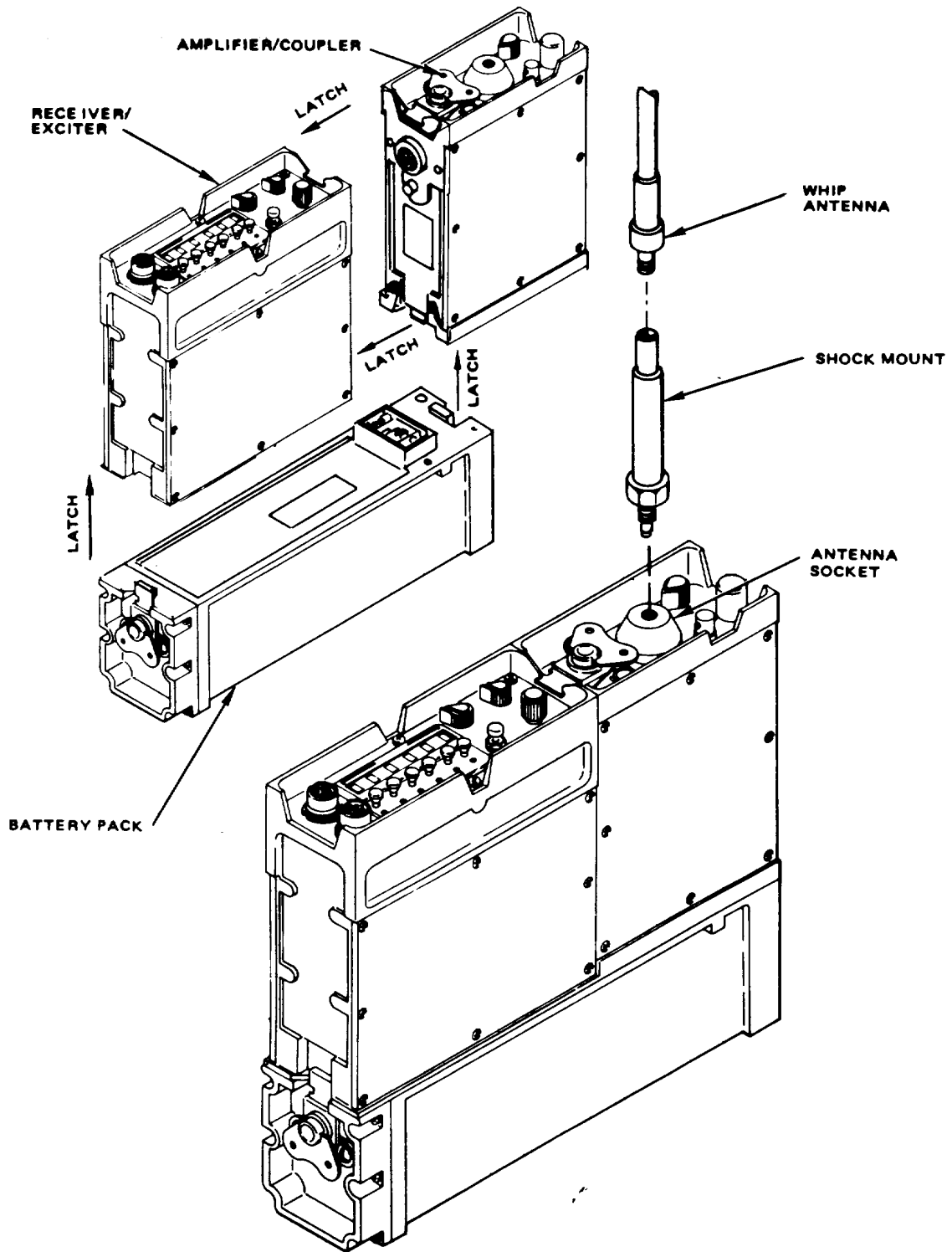

Figure 1-4. Radio Set Installation and Setup

satisfactory. If fault tone occurs, refer to the radio troubleshooting procedure in chapter 4.

3 Repeat steps 1 and 2 for the other test frequencies listed below

3,334.3 kHz LSB  
6,665.6 kHz USB  
8,889.8 kHz LSB  
15,554.5 kHz USB  
27,78.7 kHz LSB

4. Select a frequent for the time standard broadcast multiples of 5.000 N1Hz. eg 5 10, 15, 20, 25 \fs18 Hz). For this test. one frequency may he better than another depending on the time of day and location Some may not work at all, so try several if necessary, to get a good signal.

5. Monitor the time standard broadcast and switch sidebands Verify that the pitch of the audible signals does not change indicating the frequency accuracy of the radio set is within specifications

6 Turn the radio off Test is complete.

**1-30. DISASSEMBLY AND PACKUP.**

**1-31.** To transport the radio set, place all equipment (except activated batteries) back in the transit case (fig 1-1) as follows

**WARNING**

Do not store or transport batteries for an extended period in the transit case, or in a closed environment, after they are activated (filled with electrolyte). An explosive mixture of hydrogen and air may result.

1. Remove the antenna and shock mount from the radio set.

2. Remove the antenna shock mount from the antenna and place in the space provided in the transit case.

3. Fold the antenna and place in the space provided in the transit case.

4. Remove the activated battery packs and transport separately from the transit case. Only battery packs that are not activated may be placed in the transit case.

5. Place the receiver/exciter and amplifier/coupler combination in the transit case.

6. Place all other accessories in the transit case.

7. Replace the transit case cover and fasten the four latches.

**SECTION III****DEMOLITION TO PREVENT ENEMY USE****1-32. GENERAL.**

1-33. When capture or abandonment of the radio set to an enemy is imminent, the responsible unit commander will make the decision to either destroy the equipment or render it inoperative and issue orders which cover the desired extent of destruction.

**1-34.** When authorized, use any of the following methods to destroy the radio set:

1. Smash. Smash the controls, and minor components, use sledges, axes, hand axes, pickaxes, hammers, or crowbars.

2. Cut. Cut all power cables; use axes, hand axes, or machetes.

3. Bend. Bend the panel and cabinet.

**WARNING**

Be extremely careful with incendiary devices and explosives. Use these items only when other means are not adequate.

4. Burn. Burn cables, cords and technical manuals, use gasoline, kerosene, oil, flame-throwers, or incendiary grenades.

5. Explode. If explosives are necessary, use firearms, grenades.

6. Dispose. Bury or scatter the destroyed parts in slit trenches or foxholes, or throw them into nearby streams.

## CHAPTER 2

## OPERATING INSTRUCTIONS

## 2-1. INTRODUCTION.

**2-2.** This chapter contains the necessary information for operation of the radio set. It also discusses operating considerations essential for achieving optimum results in various operating environments. Section I contains the controls and indicators for the receiver/exciter and amplifier/coupler units, including

the audible indicators used for determining the operational condition of the radio. Section II contains information for selecting the proper antenna, frequency, mode, and site to achieve best communication at any time and place. Additional information in support of this section is contained in Appendix II which discusses the propagation of radio waves and develops some situational examples for optimizing communication with the radio set.

## SECTION I

## CONTROLS AND INDICATORS

## 2-3. GENERAL.

**2-4.** This section describes the controls and indicators contained on the receiver/exciter and amplifier/coupler units. It also discusses the audible indicators, as heard in the handset, which tell about the operational condition of the radio set.

## 2-5. CONTROLS AND INDICATORS.

**2-6. RECEIVER/EXCITER.** The controls, indicators, and connectors of the receiver/exciter (fig 2-1) are listed in table 2-1.

**2-7. AMPLIFIER/COUPLER.** The controls, indicators and connectors of the amplifier/coupler (fig 2-1) are listed in table 2-2.

## 2-8. AUDIBLE INDICATORS.

**2-9.** Five distinctive audio signals in the handset are provided to tell the trained operator much about the operational condition of the radio set. Additionally, the audio signals can be used to effect a bypass mode of operation when the antenna VSWR is less than 1.5:1.

**2-10. LOW BATTERY INDICATOR.** A repetitive clicking sound indicates that the battery voltage has fallen to less than 20 volts and that the battery is nearly exhausted. The clicking sound will first be heard during a tune-up or voice transmission, and will stop when the PTT switch is released and the radio reverts to the receive conditions, where the battery drain is a minimum. At this point, the battery retains enough charge to permit about 1 hour of receive operation, with five or six very brief voice transmissions during the hour. When the battery voltage falls low enough that the clicking sound is heard continuously in the receive mode, the battery must be replaced or recharged.

**2-11. POWER OUTPUT INDICATOR.** If, while transmitting, the operator hears his voice in the handset earpiece, he is hearing what is called sidetone. The presence of sidetone guarantees that the radio set is actually generating an rf signal and that the power output is within 3 db (50%) of the normal limits. The absence of sidetone means the handset or radio set is defective.

**2-12. TUNING INDICATOR.** If the ANT SEL switch is in the BNC or whip position and the radio has just been turned on, the tuning operation will begin the first time the PTT switch is pressed. A continuous 1-kHz tone will be heard in the handset during the tuning operation. The PTT switch may be released until the tuning operation is complete. When the tone ceases, an increase in receiver noise level (static) indicates that the antenna has been matched and that the radio is now receiving atmospheric noise. If the tone ceases but the receiver noise level does not

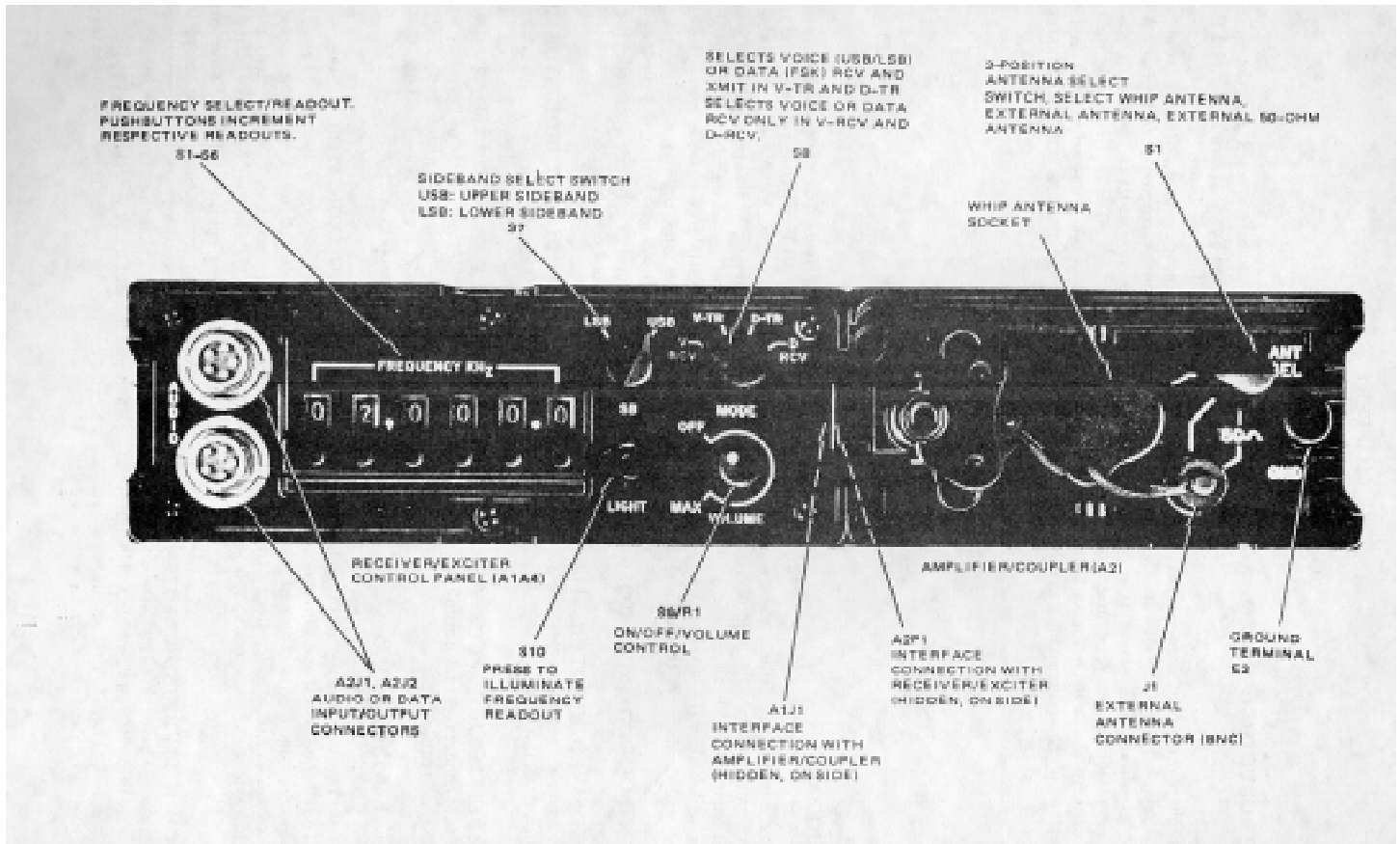

Figure 2-1. AN/PRC-104 Controls and Indicators

**TABLE 2-1. RECEIVER/EXCITER CONTROLS AND INDICATORS**

**NOTE**

Prefix reference designators with AI

Control/Indicator	Reference Designator	Function
AUDIO connector	A4A2J1, A4A2J2	Interface connection with input/output devices
FREQUENCY-KHZ switch	A4S1-A4S6	Selects 1 of 280,000 discrete frequencies between 2- and 29.9999-MHz
SB switch	A4S7	Selects either USB (upper sideband) or LSB (lower sideband) operation
MODE switch	A4S8	Selects four modes of operation:  V-RCV - Voice and cw receive only  V-TR - Voice and cw transmit and receive  D-TR - Data transmit and receive  D-RCV - Data receive only
VOLUME OFF/MAX switch control	A4S9/R1	Turns power on or off and adjusts the audio level; OFF removes power; MAX indicates maximum audio level
LIGHT switch	A4S10	Illuminates FREQUENCY-KHZ readouts (with red light) when pressed
Connector	J1	Interface connection with amplifier/coupler

increase, the antenna is open, shorted or otherwise faulty.

**2-13. NO-TUNE INDICATOR.** If the tuning tone continues for a very long time (8 thru 12 seconds) and a beeping sound is heard after the tuning tone stops the tuner has failed to tune and a tune-fault has occurred. (The beeping tune-fault tone will also be heard if the operator selects a frequency below 2 MHz). Turn the radio off and then back on and momentarily press the PTT switch to start a second attempt at tuning. If a second tune fault occurs, the antenna is open or shorted or possibly not suitable for the frequency in use. If all connections to the antenna are tight, no shorts are evident, and the antenna is

free of obstructions, adjust the antenna length, clear the tune fault and attempt a retune. If all efforts to tune fail, the antenna tuner is defective. If a spare amplifier/coupler assembly is not available and communication is essential, refer to paragraph 2-15 on use of the bypass mode.

**2-14. VSWR INDICATOR.** If the antenna or its immediate environment is disturbed during a transmission, its impedance will change and a high vswr (unmatched) condition will occur. The antenna tuner will measure the vswr at the beginning of the next transmission and will retune if the impedance change is permanent. A short beep at the beginning of a transmission indicates a previous momentary high



vswr condition but no permanent change and no retune. A permanent change in antenna impedance will cause a retune when the PTT switch is pressed.

**2-15. BYPASS MODE.** The antenna tuner is extremely efficient but some losses are inevitable . The bypass mode (ANT SEL switch set 50 position and antenna connected to the BNC connector) can be used to provide 10 to 20 percent more rf power to the antenna when the antenna VSWR is less than 1.5:1 (33 thru 75 ohms). The bypass mode can be very useful if

the antenna in use cannot be matched by the antenna tuner, or if the tuner module is faulty. When operating in the bypass mode, the presence of sidetone provides assurance that the rf is being generated and made available to the antenna. If a short beep is heard at the beginning of each transmission, the antenna vswr is worse than 4:1, but may still provide useful communications. If the antenna length, or height above ground, or coax feed line can be adjusted to reduce the antenna vswr, the beep will cease, and communications will be very nearly optimum for that particular set of conditions.

**TABLE 2-2. AMPLIFIER/COUPLER CONTROLS AND INDICATORS**

**NOTE**

Prefix reference designators with A2

Control/Indicator	Reference Designator	Function
Socket connector	P1	Interface connection with receiver/exciter
Antenna socket	...	Screw-in connection for shock mount of whip antenna
ANT SEL switch	SI	Selects whip socket either through antenna tuner, or BNC connector through antenna tuner, or BNC connector with antenna tuner bypassed (50 f impedance antennas only)
BNC connector	J1	Provides BNC connection to compatible antennas other than the whip
GND terminal	E3	Ground point for counterpoise or earth ground

SECTION II

OPERATING CONSIDERATIONS

2-16. GENERAL.

2-17. This section provides information to assist the operator in selecting the proper antenna, frequency, mode, and site for achieving best communication with this radio set. Refer to Appendix II for information on propagation of radio waves and some situational examples for optimizing radio communication.

2-18. OPTIMIZING COMMUNICATION WITH THE AN/PRC-104.

2-19. The readability and effectiveness of radio communications in the high frequency (HF) range is dependent on several factors..

1. Type of antenna used
2. Operating frequency selected
3. Terrain around transmitting site
4. Time of day'
5. Geographic location and distance between stations
6. Atmospheric conditions
7. The effects of the ionosphere on radio waves

2-20. The radio operator can control, to some degree, only the first four or five of these factors. The others affect propagation characteristics and background interference, and are beyond operator control. The antenna and frequency are the most important factors under operator control, and should be selected to best suit the propagation characteristics and distance of the link. Several frequencies will probably have been assigned from upper echelon. They will have been selected in various portions of the band in order to allow a frequency change when propagation conditions change.

2-21. ANTENNA SELECTION (Figure 2-2).

2-22. The field environment, tactical situation, and range required determine the antenna selection. If the radio set is to be used while on the move (manpack operation), the whip antenna supplied with the antenna is used. For most short range requirements using ground wave, the whip antenna will be satisfactory up to 10 miles over land. However, over sea water, this antenna will provide reliable communications up to 100 miles.

2-23. If the tactical situation permits, a simple half-wave dipole or the Near Vertical Incidence Skywave (NVIS) twin dipole antenna can be used between 2 and 12 to extend the range of the radio considerably )by utilizing the "skip" phenomenon. In this mold the radio waves are bounced off the ionosphere and back to the earth's surface providing coverage to 300 miles or more. The twin dipole may' )be used at frequencies above 12 NMHz, but automatic tuning may not work at all frequencies. The nature of the dipole or NV'IS antenna optimizes the skip effect but final results depend on existing propagation characteristics.

2-24. When using an antenna that has directional characteristics, try to orient the antenna so it is most sensitive in the direction toward the other station. For example, a dipole antenna is most effective in a direction perpendicular to the wire. The NVIS antenna is omri-directional (same sensitivity in all directions), so orientation of the antenna is not important.

2-25. A list of standard and alternate antennas that can be used with the AN/PRC-104, with the major characteristics of each, is shown below.

WHIP ANTENNA	Omnidirectional (360 degree radiation pattern)
	Easily and quickly assembled and erected
	Excellent portability Very poor gain; limited range (<10 mi) over land, even in hill terrain. Range may be better under good propagation conditions.
NEAR VERTICAL INCIDENCE SKYWAVE (NVIS)	Omnidirectional
	Requires fairly large clear area 60 feet square) for proper erection
	Good gain; extended range (0 to 300 miles)
HALF-WAVE DIPOLE	Bidirectional (perpendicular to wire)
	Good portability

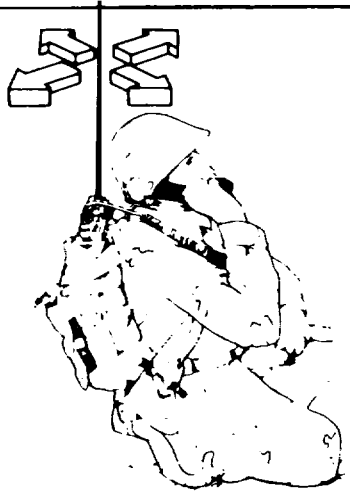
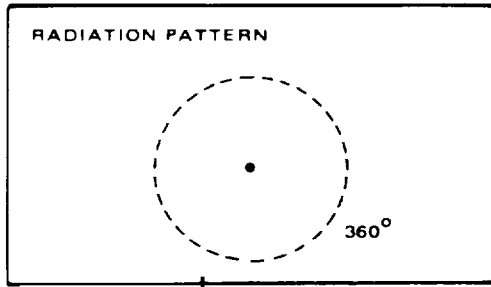

A. WHIP

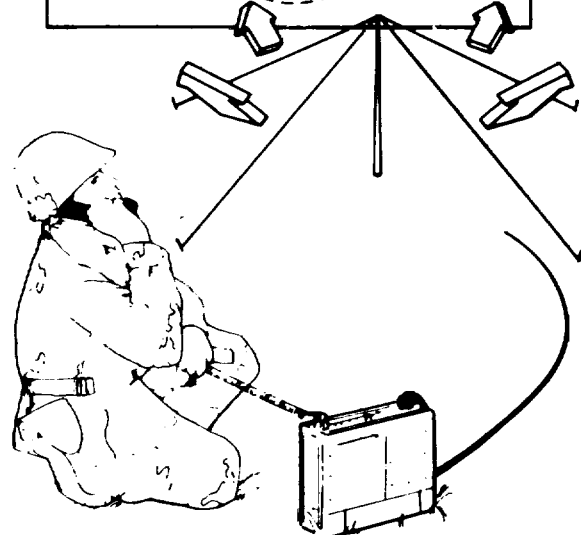
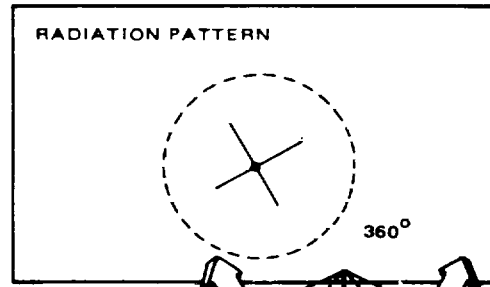

B. NEAR VERTICAL INCIDENT SKY WAVE (NVIS)

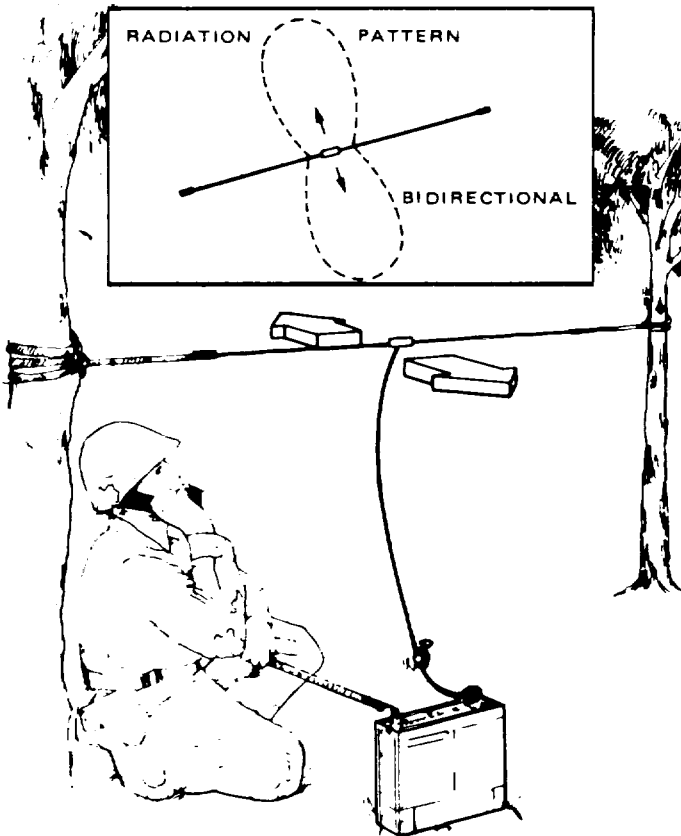
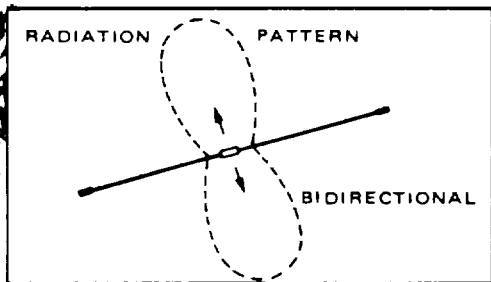

HALF-WAVE DIPOLE

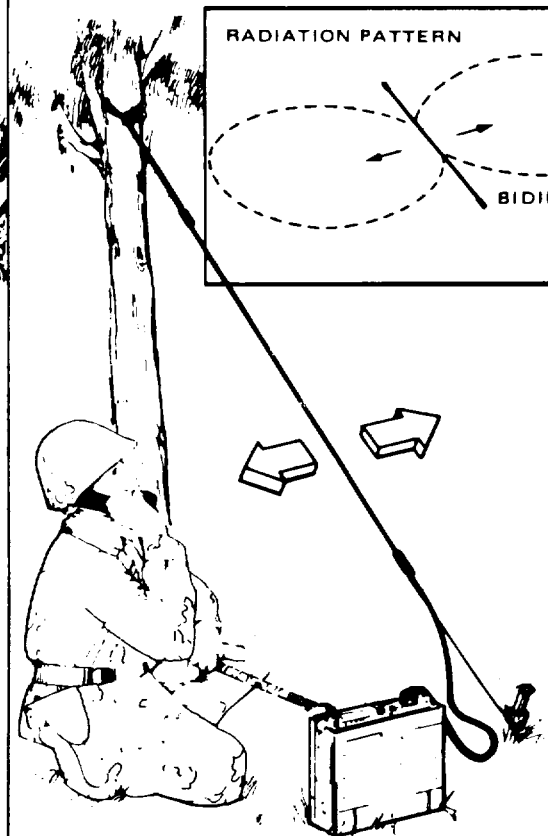
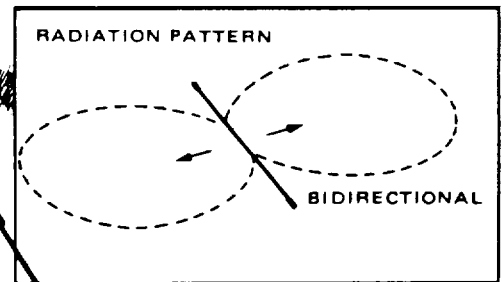

D. QUARTER-WAVE SLANT WIRE

Figure 2-2. Antennas for Use With the Radio Set

Quickly assemble and erected  
requires two vertical supports  
(trees, etc.)

Good gain extended range (0 to  
300 miles and beyond)

QUARTER WAVE SLANT WIRE Basically bi-directional  
Good portability  
Quickly assembled and erected  
requires only one vertical support  
Fair gain ; moderately extended  
range (to 1000 miles)

**2-26. FREQUENCY SELECTION.**

**2-27.** The primary considerations when selecting an operating frequency are the distance between the sending and receiving stations, and the time of day. Refer to Appendix II, figures A24 and A25 which relate the relative effective loss of communications for four sub-band segments to the time of day. These figures are based on average propagation characteristics for the sub-bands and are intended for use only as a general guide. For detailed frequency planning over a specific time period, propagation prediction charts are available from several government agencies. ("Intermediate and Short Distance Sky-Wave Propagation Charts", Headquarters U.S. Army Communications Electronics Engineering Installation Agency, Ft. Huachuca, Arizona 8.5613)

**2-28.** Another consideration in selecting an operating frequency is the atmospheric condition. If rain or other precipitation is present, signals at the lower end of the hf band may be degraded by atmospheric noise while the higher frequencies will be affected to a lesser degree. Therefore, higher frequencies will provide more effective communications in inclement weather.

**2-29.** The most useful phenomenon in radio wave propagation is the "skip" effect. This effect occurs because the layers of the ionosphere become ionized by the ultraviolet radiation of the sun. This level of ionization determines the highest frequency for skip over a given distance. Generally, the higher the ionization level, the higher the frequency that can be used in "skip" mode and therefore the broader the range of frequencies available for use.

**2-30 SITE SELECTION.**

**2-31.** Site selection is particularly important for short-range, ground wave communications. The existing tactical situation will determine how much of a selection is available. Generally, the best communications will be obtained if the transmitting site is clear of all obstructions, located in an area with good ground conductivity (wet or plowed ground) and as high above ground as possible. Several locations in the same general vicinity should be checked as possible sites. A slight change in antenna location can make a substantial difference in effectiveness.

**2-32.** Avoid areas near sources of electrical interference such as power lines, radar sets, field hospitals with X-ray machines, etc. Also avoid large structures having metallic content bridges, tanks, steel reinforced buildings, etc. If enemy jamming is a possibility, the site should be selected so that a large object or terrain feature is situated between the radio and the jamming source. This minimizes the effects of the jamming station and makes it more difficult to locate your transmitter using direction finding equipment.

**2-33. MODES OF OPERATION.**

**2-34.** The radio set mode of operation is dependent upon tactical requirements. The following conditions are examples of the types of conditions which may be encountered.

**2-35. NORMAL COMMUNICATIONS.** For two-way communications under normal circumstances, the radio set should be operated on R. This selection permits the radio to transmit and receive voice (or cw) communications on any of the 280,000 frequency settings.

**2-36. RADIO SILENCE.** When field conditions require that no radio transmissions be made, the mode selected should be V-RCV or DRC,V. These modes render the radio set passive and inhibit the modulator in order to prevent transmission. When V-RCV is selected, the radio set receives voice (or cw) but cannot transmit. When DRC: is selected, the radio set receives data information but does not transmit data.

**2-37. Data Communication.** When field conditions require transmitting and receiving data, the radio set mode selected is D-TR. This Mode permits two-way

## TM 11-5820-919-12

communication of code data or teletype (TTY) between field sites.

**2-38. Telegraph Communications.** When conditions require the use of Morse code communication (cw), the radio set is operated in the V-TR mode for two-way communication. In this mode, the telegrapher's key must be utilized in conjunction with a headset or

headset for reception.

**2-39. Data Transceiver** When data communication is desired, the output of a data coding device (such as a modem or TTY converter) may be connected to the audio connector on the receiver/exciter control panel. The radio set is then used to transmit and receive coded data.

## CHAPTER 3

### THEORY OF OPERATION

#### 3-1. INTRODUCTION.

**3-2.** This chapter contains the functional theory of operation of the radio set. The information is provided to enable the operators and organizational maintenance personnel to understand the overall function and capabilities of the radio set. Section I

contains the overall functional description of the radio set for transmit and receive operation, followed by a brief description of each module. It supports the operator's and organizational level of maintenance for unit replacement. Section II contains a functional block description of each of the seven radio set modules to provide a more detailed level of understanding of the radio set operation.

### SECTION I

#### OVERALL FUNCTIONAL DESCRIPTION

#### 3-3. GENERAL.

**3-4.** This section describes the overall function of the radio set, and discusses the transmit and receive operation at the module level. It also briefly discusses the function of each module.

#### 3-5. RADIO SET FUNCTIONAL DESCRIPTION.

**3-6.** The radio set is a 2- thru 30-MHz single sideband (SSB) transceiver with a transmitter output of 20 watts. Operation can be either voice, cw, or coded data (depending on the audio device used) with automatic antenna tuning. There are three levels of frequency conversion between audio and rf in both transmit and receive with two stages of intermediate frequency (if.) amplification and filtering. The radio set consists of seven functional modules. Five of the modules are housed in the receiver/exciter unit:

1. Control Panel
2. Synthesizer
3. Modulator/Demodulator
4. Harmonic Filter
5. Power Supply

**3-7.** Two functional modules are housed in the amplifier/coupler unit:

1. Power amplifier
2. Antenna tuner

**3-8. TRANSMIT OPERATION** (Figure 3-1). Input

audio signals are routed through the control panel to the modulator/demodulator. The Xmt Audio mixes with the three LO signals sent from the synthesizer to produce a single sideband Xmt RF output. The low power Xmt RF is amplified in the power amplifier and routed through the harmonic filter to remove transmitter harmonics. The filtered Xmt RF is then applied to the antenna, via the antenna tuner for impedance matching.

**3-9. RECEIVE OPERATION.** The Rcv RF signal from the antenna is routed back through the antenna tuner and is filtered by the harmonic filters to remove spurious signals. The Rcv RF is then routed to the modulator/demodulator where it mixes with the three LO signals sent from the synthesizer to produce the Rcv Audio output. The Rcv Audio is then routed through the control panel to the handset.

**3-10. CONTROL PANEL** (Figure 3-2). The receiver/exciter control panel provides operational control of the radio set. It couples voice or CW key from the audio devices in use by the operator, and has controls for selection of frequency, volume, mode, and sideband (SB), and illumination of frequency readouts. Frequency Select and Sideband Select signals are routed to the synthesizer, and the Frequency Select signal also to the antenna tuner. Filter Select signals are routed to the harmonic filter. Volume control, mode select and Xmt Audio are applied to, and Rcv Audio is received from, the modulator/d -modulator. The control panel also

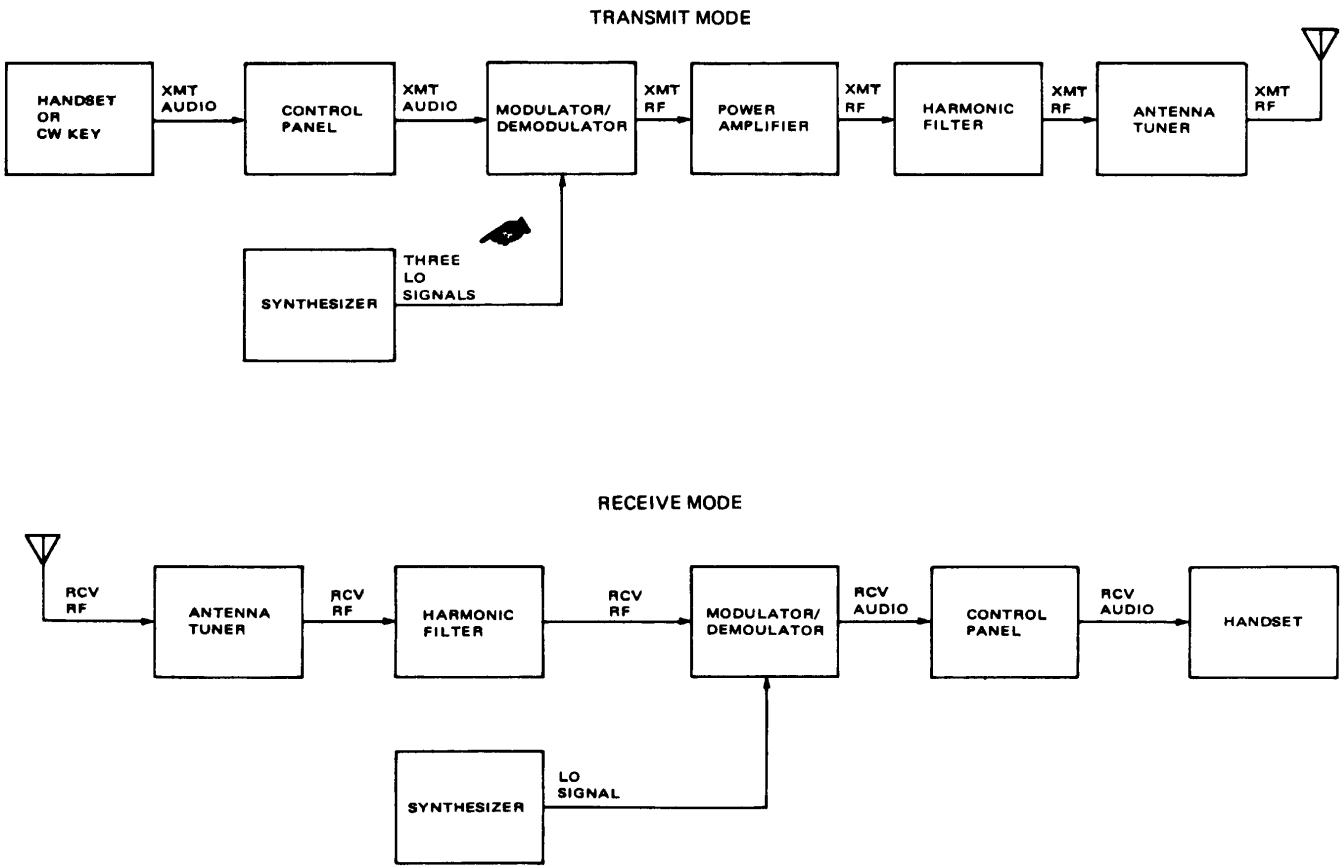

Figure 3-1. Radio Set System Block Diagram

switches on +28v battery power (+28w On), via the volume control, for use by various modules.

**3-11. SYNTHESIZER.** The synthesizer generates 5 MHz, 70 or 80 MHz, and 77 thru 105 MHz LO signals. These LOs are used by the modulator/demodulator to produce the radio frequency in Xmt, or demodulate rf in Rcv. If the operator selects LSB, 80 MHz is routed to the modulator/demodulator. If USB is selected, 70 MHz is chosen. Frequency Select signals from the control panel determine the frequency between 77 and 105 MHz. Which goes to the modulator/demodulator. A 1kHz signal is routed to the modulator/demodulator for use in fault indication signals and cw operation.

**3-12. MODULATOR/DEMODULATOR.** The modulator/demodulator converts the voice or cw (Xmt Audio) to two intermediate frequencies (if.) and the radio frequency (Xmt RF). It uses the 5, 70 or 80 MHz and 77 thru 105 MHz LO signals from the synthesizer for this purpose. In receive operation, the same circuits extract the voice or cw (Rcv Audio) from the receive radio frequency (Rcv RF). In addition, the modulator/demodulator contains alarm generator circuits which produce audio signals to alert the operator as follows.

1. Battery power is low.
2. A tune fault condition exists.
3. An antenna tune cycle is in progress.

**3-13. POWER AMPLIFIER.** During transmit operation, the power amplifier boosts the Xmt RF from the modulator/demodulator to 20 watts. In receive operation, the amplification circuits are bypassed. In Xmt, rf is then routed to the harmonic filter.

**3-14. HARMONIC FILTER.** The harmonic filter removes undesirable spurious signals during Rcv and transmitter harmonics during Xmt. The specific filter frequency range is determined by the Frequency Select signal from the control panel. The Xmt/Rcv RF path to the antenna tuner is the same for both.

**3-15. ANTENNA TUNER.** The antenna tuner automatically matches antenna impedance to the radio set at the selected frequency.

**3-16. POWER SUPPLY.** +28v On from the control panel is routed to the power supply. It produces and distributes regulated +6.5v and +12.5v to the other modules.



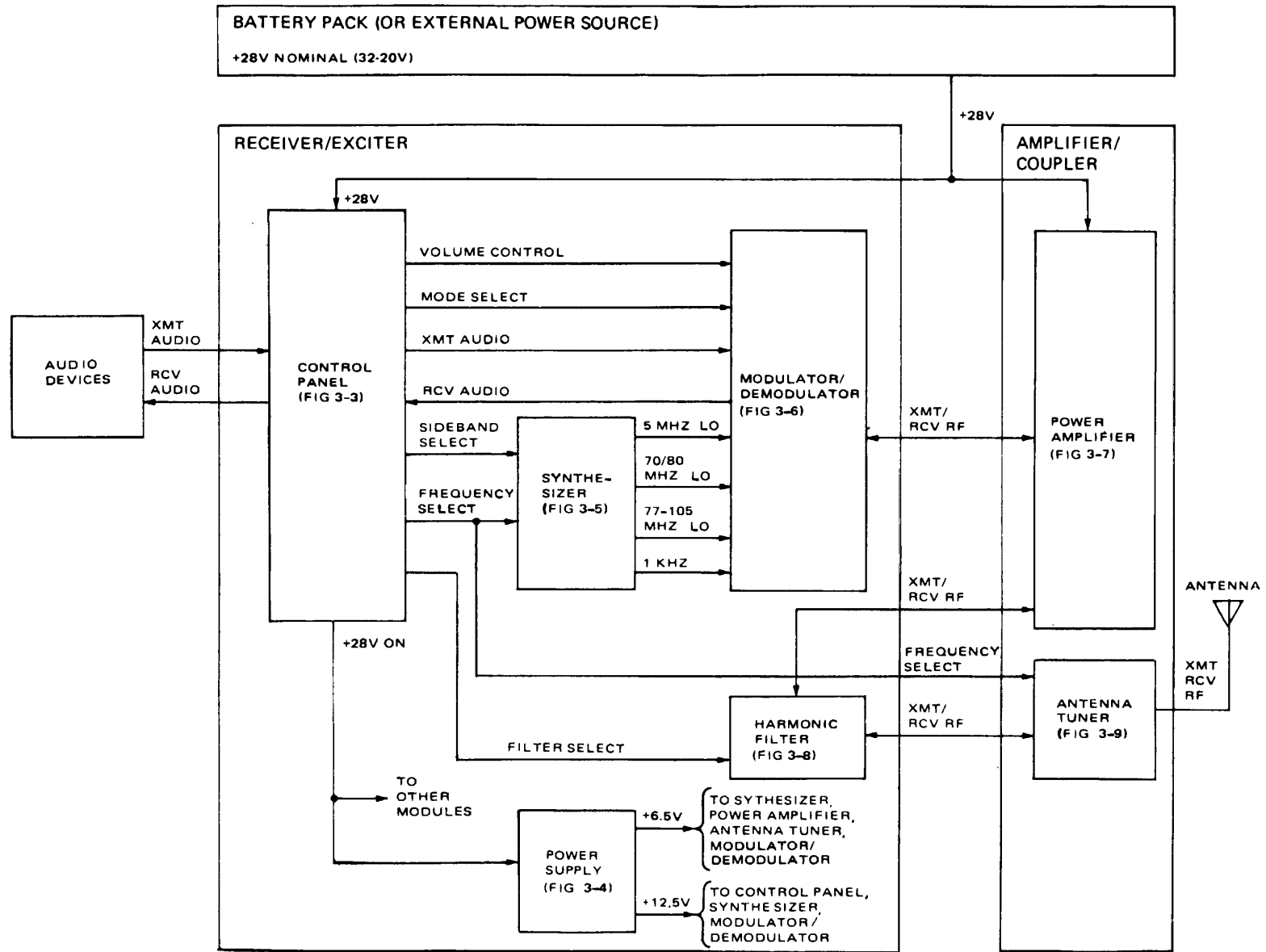

Figure 3-2. Radio Set Simplified Block Diagram

## SECTION II

## FUNCTIONAL BLOCK DESCRIPTION

**3-17. GENERAL.**

**3-18.** This section contains a functional block description of the seven modules within the radio set.

**NOTE**

Although the modules are not replaceable at organizational maintenance level, this description is provided to help better understand the operation of the radio set.

**3-19. CONTROL PANEL (Figure 3-3).** The control panel is a removable module which contains all of the operational controls, and the audio interface connectors and filters for the radio set. The operational controls and audio filtering are discussed below.

**3-20. Frequency Selection.** Selection of the operating frequency is accomplished by setting the six FREQUENCY-KHZ pushbutton switches to the desired frequency (2.0000 thru 29.9999 MHz). The resultant binary-coded decimal (BCD) Frequency Select and Filter Select signals are used to establish frequency control of the radio set. Frequency selection is performed in 10-MHz, 1-MHz, 100-kHz, 10-kHz, 1-kHz and 100-Hz increments.

**3-21. Operational Mode.** The MODE switch selects one of the following four modes of operation: V-RCV --  
Voice and cw receive only

V-TB - Voice and cw key transmit/receive  
V-TR - - Data transmit/receive  
V-RCV- Data receive only

**3-22.** The Mode Select signals from the MODE switch are routed to the modulator/demodulator to activate solid state switches which place the radio set in the selected operating mode. In V-RCV mode, the radio set operates as a receiver only with the modulator (transmit) inhibited. In the V-TR mode, either transmit or receive operations are possible using voice or cw signals. Pushing the PTT on the handset or pressing the cw telegrapher's key sends a Xmt Enable to the modulator/demodulator, which puts the radio in transmit mode. The same features (receive only, transmit/receive) are available for data D-TR and D-RCV communication, except that the signal bypasses the volume control, the output level becomes fixed, and the input impedance is increased to

match standard data systems.

**3-23. Sideband Selection.** Either low or upper sideband operation can be selected by placing the SB switch in LSB or USB, respectively. The resultant Sideband Select signal from the SB switch causes the synthesizer to route either 70 MHz (USB) or 80 MHz (LSB) to the modulator/demodulator.

**3-24. Volume Control.** The VOLUME OFF/MAX control is a conventional on-off switch and potentiometer combination. The on-off switch connects +28v On to the modules in the radio set. The potentiometer controls the level of audio signals input to the audio amplifier in the modulator/demodulator.

**3-25. Panel Illumination.** The LIGHT switch, when pressed, illuminates the FREQUENCY-KHZ readouts on the control panel with red light.

**3-26. Audio Filtering.** The Audio to or from the audio devices is filtered both in receive and transmit modes. This prevents Xmt RF from being picked up by the cables leading to the audio devices and being sent back into the radio set.

**3-27. POWER SUPPLY (Figure 3-4).** The power supply converts +28v On from the control panel to +12.5 and +6.5v. This is done by two down switchers (transistorized regulating circuits). An overload latch shuts the down switchers off if an excessive load (a short circuit, for example) is present at the output. The +6.5v goes to the antenna tuner, power amplifier, modulator/demodulator, and synthesizer. The +12.5v goes to the control panel, synthesizer, and modulator/demodulator. These voltages are regulated.

**3-28. SYNTHESIZER (Figure 3-5).** The synthesizer generates three sinusoidal LO signals which are used by the modulator/demodulator. All of the frequencies generated by the synthesizer are referenced to a temperature-compensated crystal oscillator (TCXO), which is the frequency standard for the radio set. Because the TCXO is temperature-compensated over a -46 to +71 °C range, the Xmt RB" frequency will not

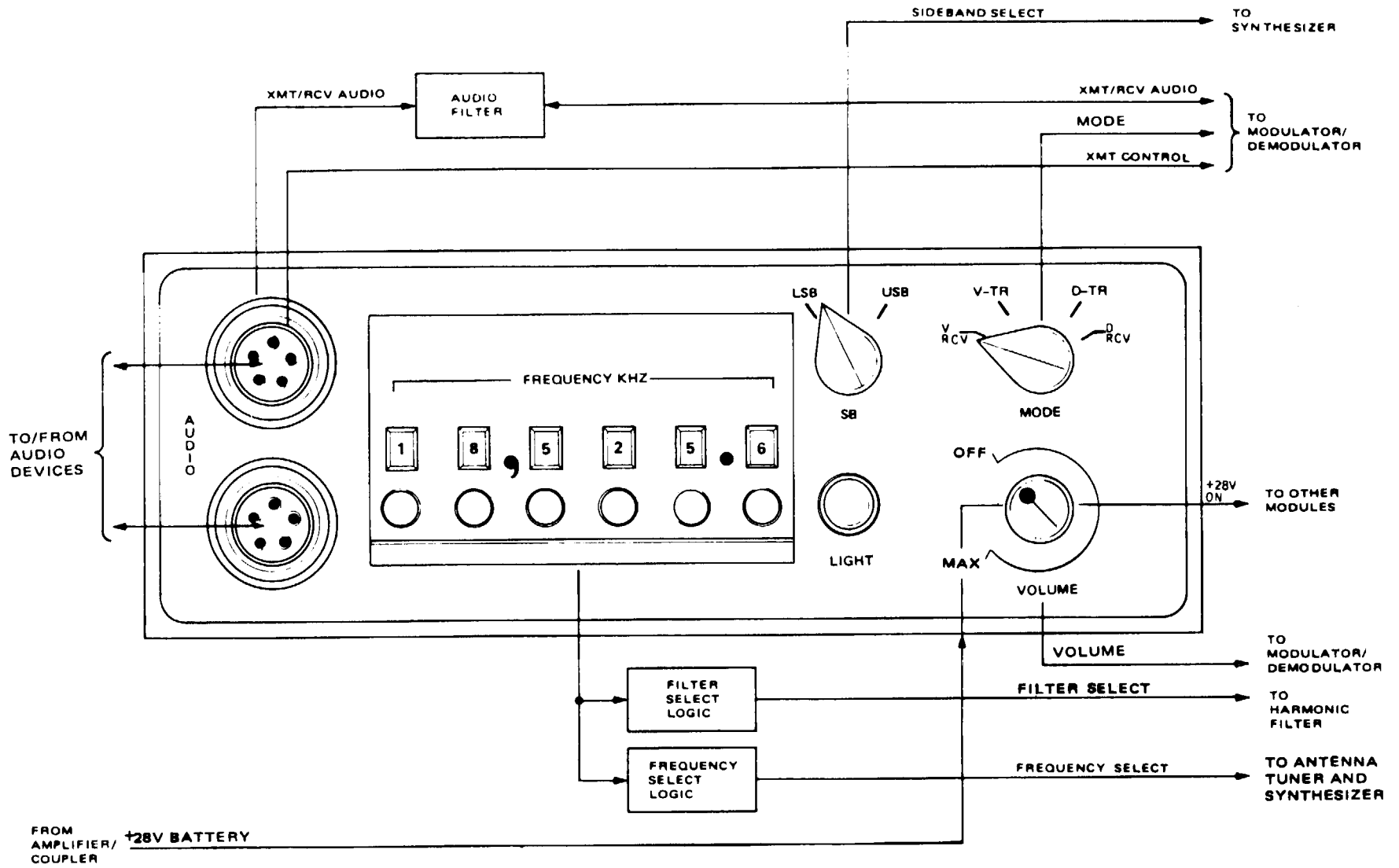

Figure 3-3. Control Panel Pictorial Block Diagram

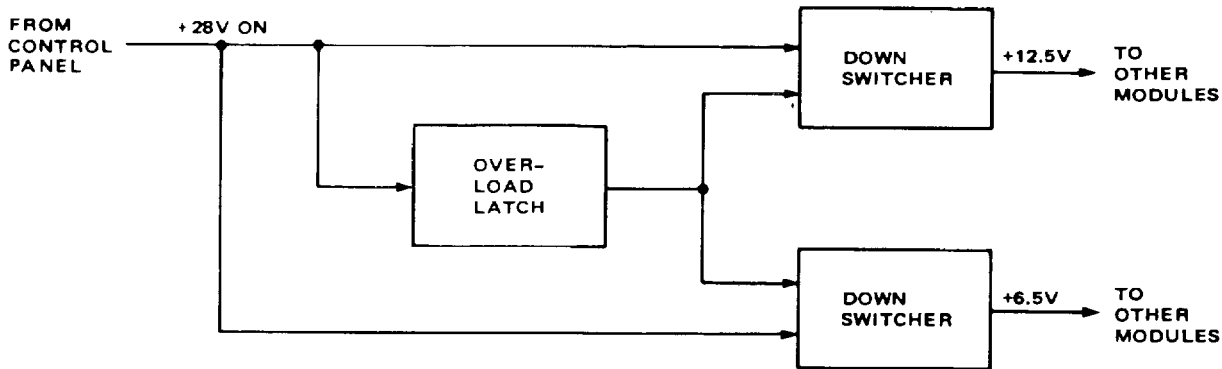

Figure 3-4. Power Supply Block Diagram

shaft noticeable with temperature. The TCXO outputs 5MHz LO goes to a frequency divider where it is divided to 10 kHz. The 1 kHz frequency is used by the modulator/demodulator for cw key operation or for fault indication signals 3-29. The 5 MHz LO is also applied to a frequency multiplier which generates 70 and 80 MHz harmonics. The harmonics are filtered by 70 and 80-MHz bandpass filters and routed to the limiter. The Sideband Select signal is applied to the limiter. If the sideband select switch is set to LSB, then the limiter sends 80 MHz LO to the modulator/demodulator. If USB is selected, the limiter sends 70 MHz LO to the modulator/demodulator.

**3-30.** The Frequency Select from the control panel determines the output of the 77-105 MHz LO signal using a dual phase-locked loop. A dual loop is faster than a single loop phase locking system. A voltage (2.64 thru 9v) from the phase-locked loop tunes the voltage-controlled oscillator (VCO) to a higher or lower frequency. The 77-105 MHz LO signal is divided in the dual phase-locked loop according to the Frequency Select setting until it is 10 kHz. It is compared against the 10 kHz from the frequency divider to provide the locking action. If the divided 77-105 MHz LO is above or below 10 kHz, the VCO's output is automatically adjusted.

**3-31. MODULATOR/DEMULATOR (Figure 3-6)**  
The modulator/demodulator performs frequency conversion for both transmit and receive operation. The audio control hybrid contains control circuits, while the three converters perform the frequency conversion. The hybrid outputs the Xmt/Rev Control signal which determines whether the radio set is in transmit or receive operation.

**3-32.** The hybrid accepts signals from other modules in the radio set and generates the following alarm signals: (1) Low Battery Indicator (2) Tune In Progress and (3) Tune Fault. The Low Battery Indicator is set off if the +28v On from the control panel drops below +20v. The Tune In Progress indicates that the antenna tuner is automatically matching the antenna to the radio set at the selected frequency. The Alarm signal is routed from the alarm circuits to the audio circuits to develop audible tones which are applied to the Rev Audio:

1. When battery power drops below +20v, a clicking sound is heard in the handset.

2. If the antenna fails to complete a tune cycle within 12 seconds, a repetitive beeping 1-kHz tone will be heard in the handset (Tune Fault).

The tone will also be heard if a frequency below 2 MHz is selected.

3. During the time that the antenna tuner is in a tune cycle, a steady, low-volume (1-kHz) tone is heard in the handset (Tune In Progress).

**3-33.** The audio circuits control the level of the transmit signal and the gain of the receive signal. The mode signal from the control panel inhibits transmit operation if V\_RCV is selected. The 1 kHz from the synthesizer is switched on and off by the cw key. In transmit operation, the Xmt Audio Frequency is routed from the audio control hybrid to the third converter, it mixes with either 70 or 80 MHz, depending on the sideband selection (80 MHz for LSB, 70 MHz for USB)

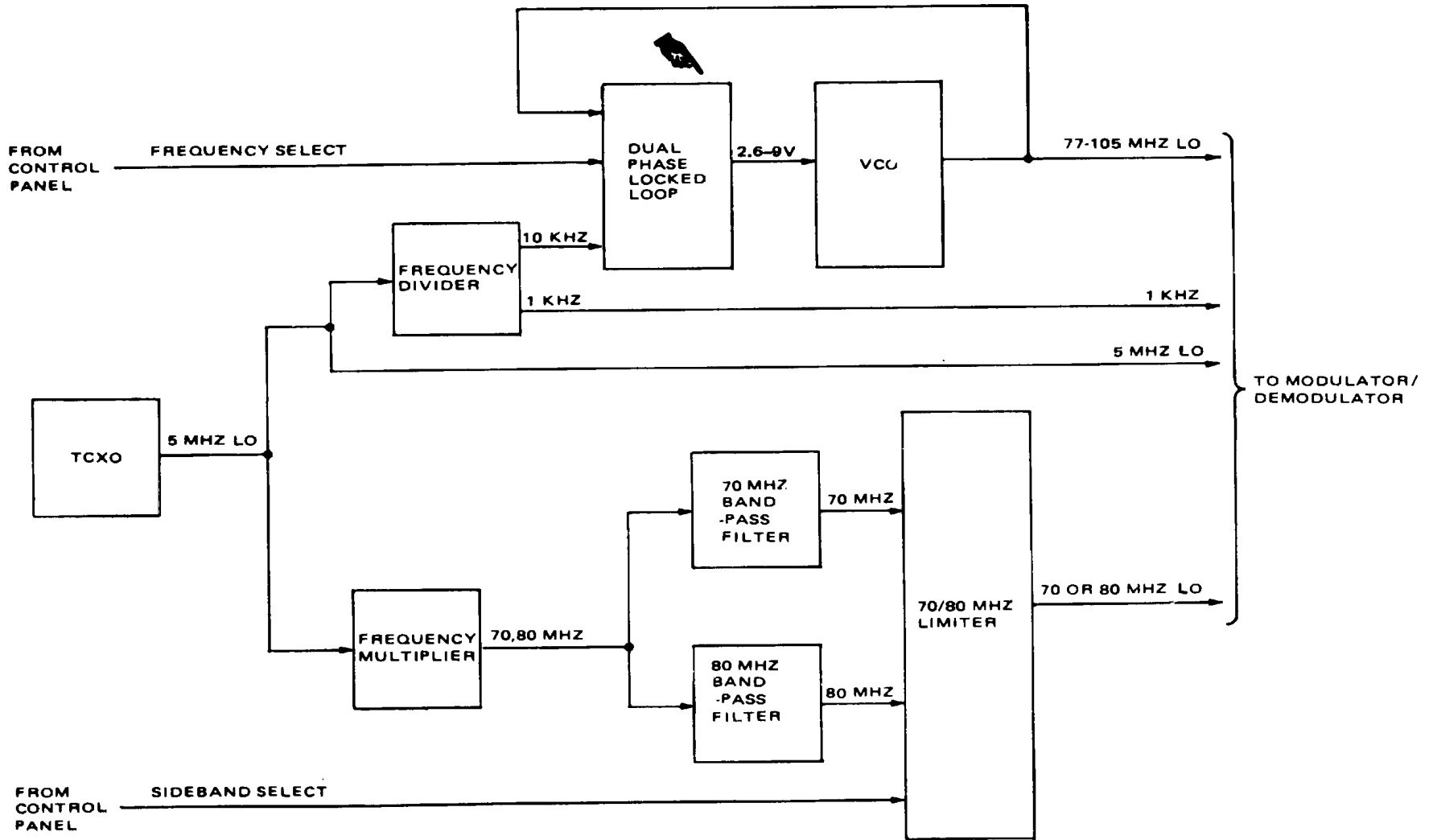

Figure 3-5. Synthesizer Block Diagram

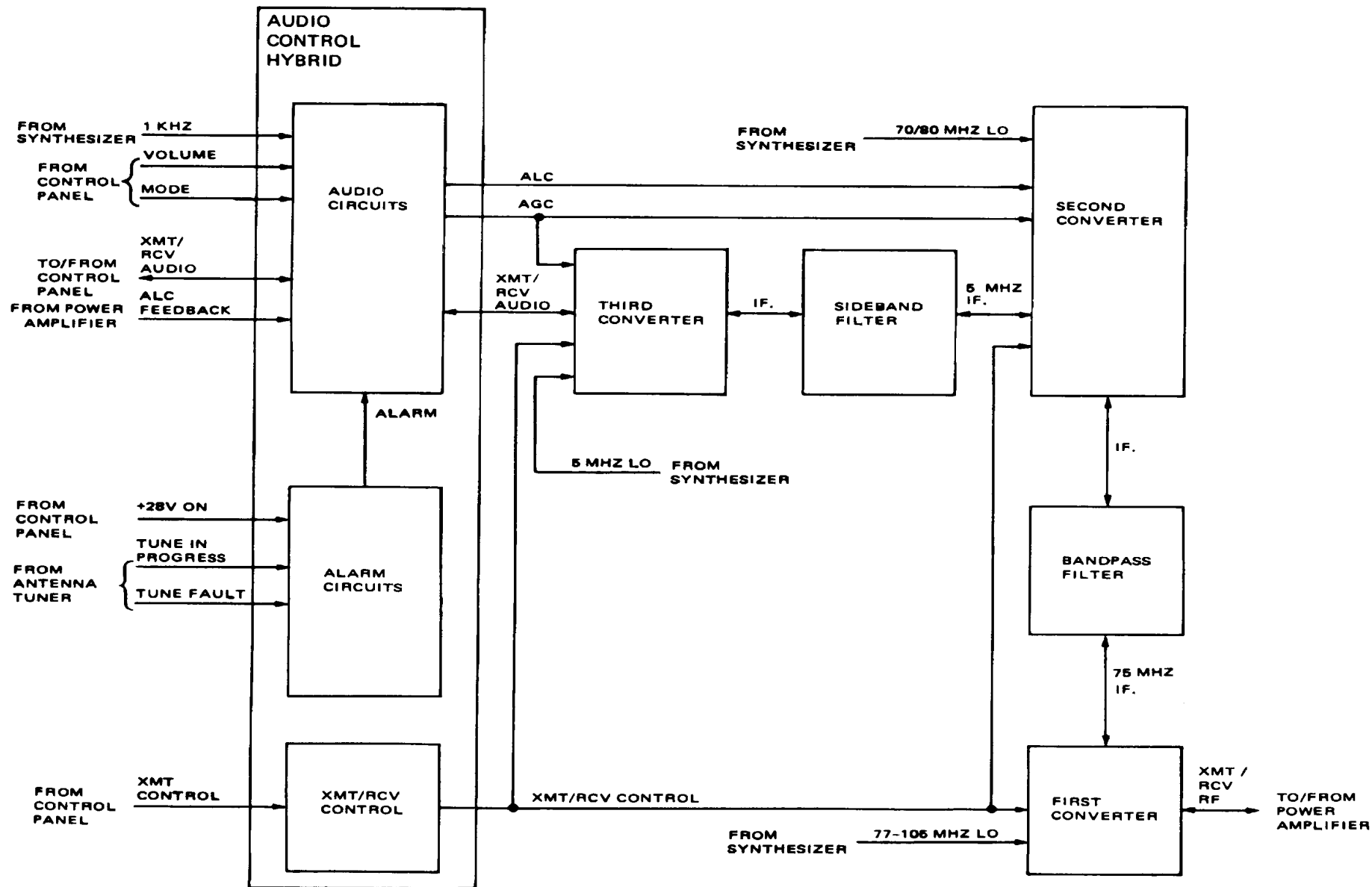

Figure 3-6. Modulator/Demodulator Block Diagram

from the second converter. With USB selected, the upper if product is passed [80 MHz 5 MHz Xmt Audio] the first converter then mixed the bandpass filter if. with a specific frequency between 77 and 105 MHz (75 MHz + Xmt RF frequency). The specific mixing frequency is determined at the control panel, made in the synthesizer and precalculated to produce the desired Xmt RF. For example, with 5 MHz and USB selected at the control panel, the LO is 80 MHz and the Xmt RF is {80 MHz 70MHz Xmt Audio } or 5 MHz + Xmt Audio.

**3-34.** In receive operation, the flow direction is reverse. The same circuits are used. Except that certain amplifiers are switched into and out of the system. The Rcv RF mixes with three 77 105 MHz LO in the first converter to create upper and lower if products...The upper if product is filtered out at filter FL1. The lower product (75 MHz if) is passed to the second converter where it mixes with either 70 (USB) or 80 MHz (LSB). The 5 MHz if, product is passed through filter FL2 while the upper if. Product is filtered out. The 5-MHz if, is mixed with 5 MHz in the third converter to create the Rcv Audio. The level of the receive signal is controlled at the second and third converters by the hybrid audio

circuits via the automatic gain control signal.

**3-35 POWER AMPLIFIER (Figure 3-7)** The power amplifier boosts the 0.30-watt output from the modulator/demodulator to provide 20-watt (normal) rf power at the antenna. The Xmt RF is preamplified to 2 watts in the output stage. It is then amplified to about 27 watts in the output stage. (About 7 watts is lost in the filter and antenna tuner.) The DC-DC converter provides the +30.5v Regulated voltage for the output stage. The tuner dc source generates +16v Regulated for use by the antenna tuner during impedance matching. This is triggered by the Tune In Progress signal from the antenna tuner. The tuner dc source compensates for changes in battery voltage and temperature. The power monitor circuits use the vswr signal from the harmonic filter to protect the power amplifier. If the antenna is badly matched to the radio set power reflects back at the power reflects back at the power amplifier. This could cause damage. When a poor match occurs, the power monitor disables the driver tuning (Tune Check Enable) and sends ALC Feedback signal to the modulator/demodulator. The ALC controls the rf power output level of the receiver/exciter in transmit operation.

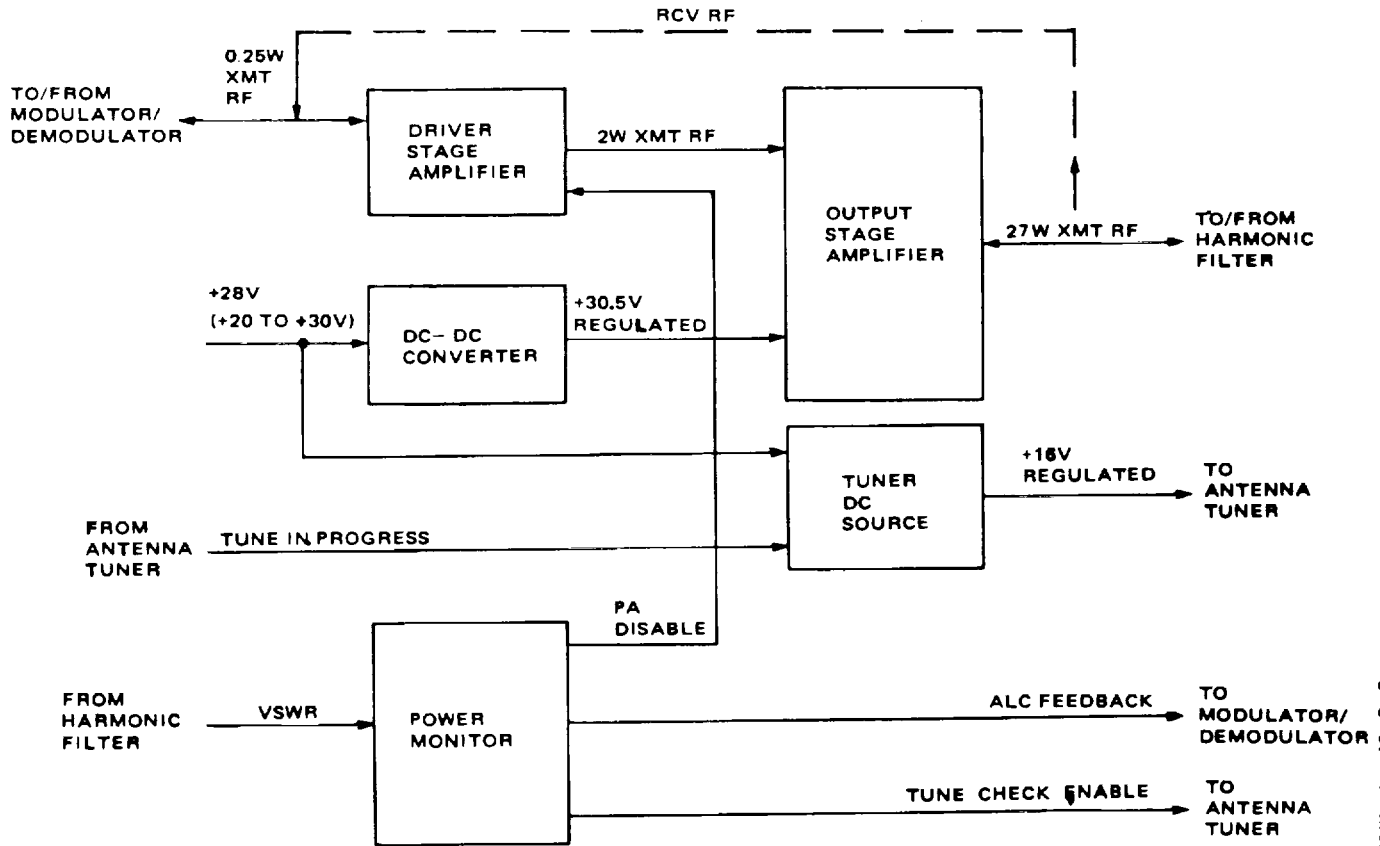

Figure 3-7. Power Amplifier Block Diagram

**3-36. HARMONIC FILTER (Figure 3-8).** The harmonic filter suppresses transmitter harmonics and noise levels outside of the selected frequency band. To do this, the Xmt/Rcv must pass through the bandpass and pass filter. The Filter select signal, from the control pilot panel energizes one of the six filter select relays which switches itches the associated filter into the circuit. The filters are passive and are used in both transmitter and receiver modes. The rf detector circuits monitor the amount of power point to and returning from the antenna (vswr). The signal is applied to the power amplifier.

tuner automatically transforms the antenna impedance (reactive/resistive) to 50 ohms. This is done by using an adjustable L-C network. The antenna tuner is normally off, and the L-C network is held in place by magnetic latching relays. The antenna tuner becomes operational whenever. (1) the radio is turned on, (2) the MODE switch is changed from V-RCV to V-TR or D-RCV to D-TR, or (3) the frequency is changed. This causes a tune start signal to be applied to the L-C control from the control panel.

**3-37. ANTENNA TUNER (Figure 3-9).** The antenna

Figure 3-8. Harmonic Filter Block Diagram

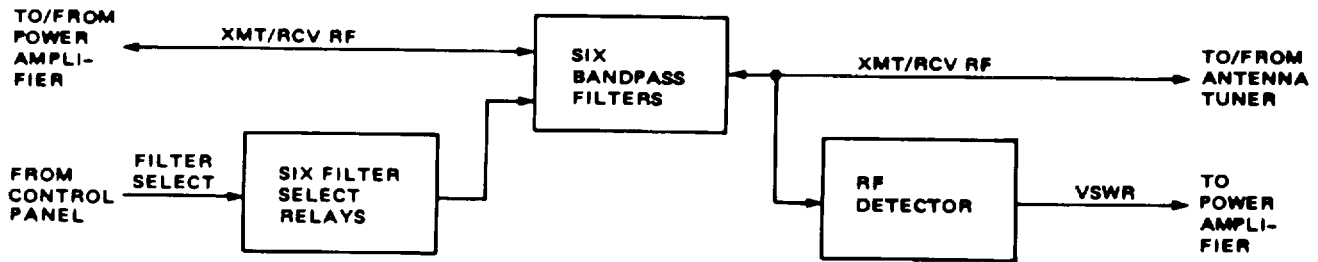

Figure 3-8. Harmonic Filter Block Diagram

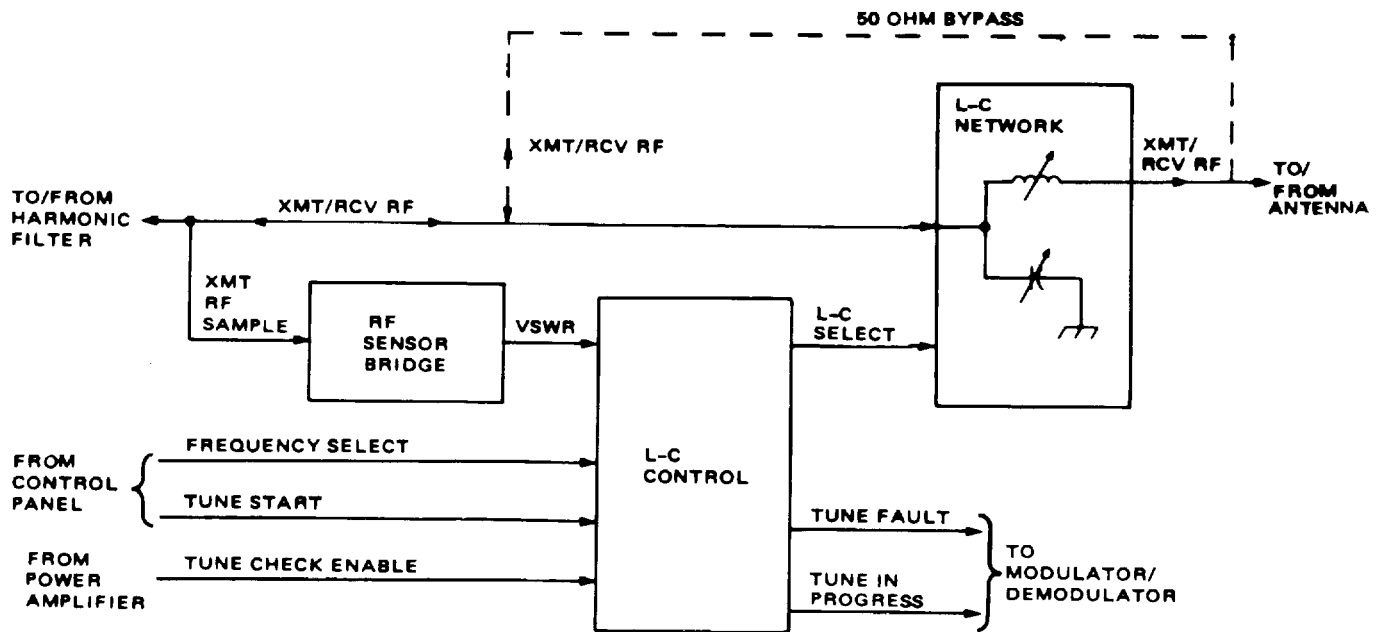

Figure 3-9. Antenna Tuner Block Diagram

**3-38.** When a tune start is generated, the L-C control resets the L-C network to zero. This means that there will be no inductors or capacitors in the Xmt/Rev RF pathway. When the operator transmits the rf sensor bridge samples the Xmt RF and produces a Vswr signal. In addition, a Tune In Progress signal is sent to the modulator/demodulator. The L-C control uses the Vswr and the Frequency Select signals to adjust the L-C network to its correct value via the L-C select signals. If a Tune Check Enable is routed from the power amplifier during transmission, the antenna tuner will recheck its

tune and perform a retune if necessary.

**3-39.** If the tuning cycle takes too long (over 12 seconds) the L-C control will output a Tune Fault signal. This means that either the selected antenna is not within the tuning range of the antenna tuner, or that the module could be faulty. A Tune Fault signal is sent immediately y should a frequency below 2MHz be



## CHAPTER 4

### MAINTENANCE INSTRUCTIONS

#### 4-1. INTRODUCTION.

4-2. This chapter contains preventive maintenance, troubleshooting, and repair instructions for the radio set. Preventive maintenance includes periodic checks and services and cleaning. Troubleshooting includes the radio set performance test and fault isolation using

audible tones. Repair includes removal and replacement instructions for the radio set units and accessories. This chapter also includes complete coverage of the battery pack, because all maintenance is performed at operator and organizational levels.

### SECTION I

#### PREVENTIVE MAINTENANCE

#### 4-3. GENERAL.

4-4. Preventive maintenance is the systematic inspection and servicing of the radio set to prevent equipment failure, reduce downtime, and assure that the radio set is serviceable. This section contains daily, weekly, and quarterly checks and services; cleaning instructions and corrosion control instructions.

#### 4-5. PERIODIC CHECKS AND SERVICES

**4-6. DAILY CHECKS AND SERVICES.** Table 4-1 contains the checks and services to be performed on a daily basis.

**4-7. WEEKLY CHECKS AND SERVICES.** Table 4-2 contains the checks and services to be performed on a weekly basis.

#### 4-8. QUARTERLY CHECKS AND SERVICES.

Quarterly checks and services consist of performing the radio set performance test contained in figure 4-2. For Air Force maintenance perform the audible tone performance test contained in figure 4-1.

#### 4-9. CLEANING.

4-10. Cleaning of the radio set is to be performed when necessary, as follows:

1. Remove dirt, dust, grease, or other debris from external surfaces as follows:
  - a. Remove dust and loose dirt with a cloth or brush.

- b. Wash surface with a cloth or brush moistened in soapy water.

- c. Rinse with a clean cloth moistened in clear water.

- d. Dry, using a soft lint-free cloth.

2. Remove dust and dirt from connectors and pins with a soft bristle brush.

3. All battery pack maintenance information is contained in section IV.

#### 4-11. CORROSION CONTROL.

**4-12.** The following maintenance actions are performed when necessary for prevention and control of corrosion and fungus on the radio set.

1. Separate the three units (receiver/exciter, amplifier/coupler, and battery pack) from the radio set and inspect the exterior of each unit for corrosion and fungus (particularly around the controls, connectors, and latches).

2. Remove all corrosion and fungus with a cloth and/or brush moistened in cleaning solvent.

3. Repaint all treated areas immediately upon removal of corrosion to alleviate reoccurrence of corrosion build-up.

**TABLE 4-1. DAILY CHECKS AND SERVICES**

Check	Item to be Inspected	Procedure
1	Completeness	Check to see the radio set is complete, and that all hardware is present and properly fastened
2	Exterior Surfaces	Remove dust, (dirt, or other debris
3	Controls	Check each control for proper mechanical action
4	Battery	Check battery pack for leakage or corrosion
5	Operation	Perform initial checkout described in chapter I

**TABLE 4-2. WEEKLY CHECKS AND SERVICES**

Check	Item to be Inspected	Procedure
5	Operation	Perform initial checkout described in chapter I
1	Battery Condition	Remove battery pack cover and check for corrosion or leakage. Clean or replace as required (refer to section IV)
2.	Connectors	Check all connectors for debris, damage, or corrosion. Refer to higher level of maintenance as required
3.	Antenna	Check for breaks or strain. Repair or replace as required

## SECTION II

## TROUBLESHOOTING

**4-13. GENERAL.**

**4-14.** Operator and organizational troubleshooting is limited to isolating a fault to a replaceable unit or accessory. Fault isolation at this level may be accomplished using operational indications and distinct audible tones produced within the radio set. This section covers the use of the audible tones, as heard in the handset, for fault indication and isolation by the operator. It also contains the radio set performance test for complete fault isolation to the faulty unit at the organizational level.

**4-15. USE OF AUDIBLE TONES.** Audible tones are provided to indicate that the following basic operational conditions exist:

1. Normal Condition. Receiver noise in handset at turn-on, low volume sidetone when transmitting into an antenna or 50 ohm load.

2. Tuning. A brief (1.5 to 12-second) tone (tune-up tone) while the antenna tuner performs a tune cycle.

3. Tune Fault. A beep sound (tune tone) indicating that a tuning fault exists.

4. Battery Low. A clicking sound indicating battery voltage is low.

**4-16. PERFORMANCE TEST.** Performance tests are provided for the operator's and organizational level. The meaning of the various audible tones available to the radio set operator for fault indication and isolation is described in table 4-3.

**4-17.** An operator's radio set performance test flowchart using only audible tones, without test equipment, is contained in figure 4-1.

**4-18.** Organizational level radio set performance test setup and test flowchart are contained in figures 4-2 and 4-3. Air Force organizational maintenance uses the audible tones performance test in figure 4-1.

TABLE 4-3. FAULT INDICATION BY AU'DIBLE TONES

Item	Symptom	Probable Cause
1	No receiver noise at ;;turn-on	<ul style="list-style-type: none"> <li>a. Dead battery (refer to section IV)</li> <li>b. Receiver/exciter faulty</li> </ul>
2.	Clicking sound	Battery low (refer to section IV)
3.	No tune-up tone	<ul style="list-style-type: none"> <li>a. Amplifier/coupler faulty</li> <li>b. Receiver/exciter faulty</li> </ul>
4..	Tune fault tone.	<ul style="list-style-type: none"> <li>a. Amplifier/coupler faulty</li> <li>b. Antenna connection bad</li> </ul>
5.	Tune fault tone at turn-on	Receiver/exciter faulty or frequency selected is lower than 2 MHz
6.	No transmit b.	<ul style="list-style-type: none"> <li>a. Receiver/exciter faulty</li> <li>Amplifier/coupler faulty</li> </ul>
7.	No receiver audio	<ul style="list-style-type: none"> <li>a. Volume too low</li> <li>b. Antenna connection bad</li> <li>c. Receiver/exciter faulty</li> <li>d. Amplifier/coupler faulty</li> </ul>

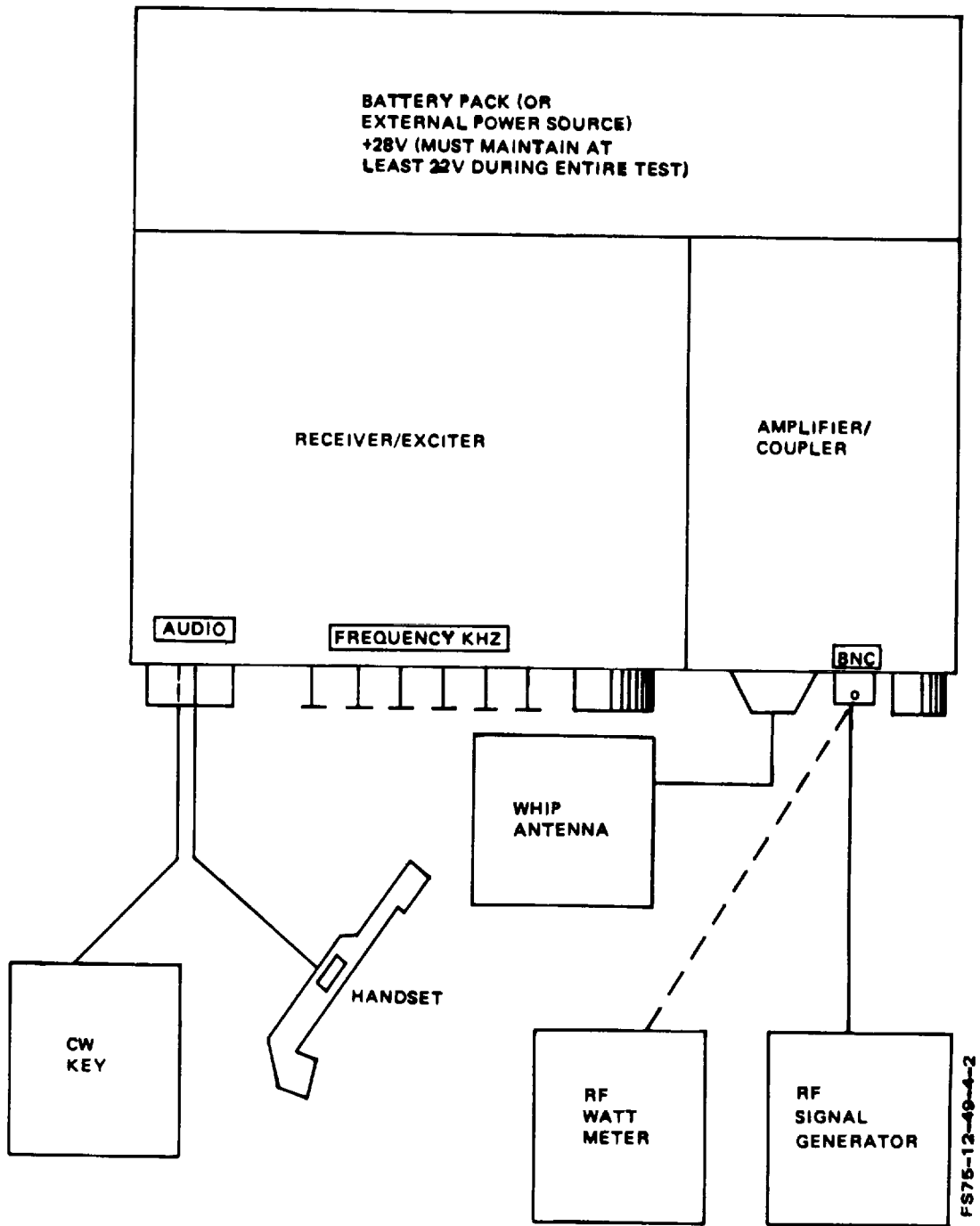

Figure 4-2. Organizational Radio Set Performance Test Setup

**SECTION III****REPAIR****4-19. GENERAL.**

**4-20.** This section covers repair at the operator and organizational maintenance levels. which consists of removing and an(d replacing radio set units and exchanging accessories Further repair requires higher levels of maintenance

**4-21. REMOVAL.** Unit and accessory removal (fig 1-4) is accomplished as follows:

- 1 Remove ( the antenna or antenna cable and audio , is required
2. Unfasten the 2 latches securing the battery pack to the receiver\exciter and amplifier/coupler combination, and remove battery pack.
3. Lathe receiver/exciter and amplifier/coupler combination) on a flat surface.

4. Unfasten the front latch and then the rear latch securing the receiver/exciter and amplifier/coupler together.

5. Carefully separate the two assemblies to prevent damaging the connector.

**4-22. REPLACEMENT.** Unit and accessory replacement is accomplished as follows:

1. Secure the receiver/exciter and amplifier/coupler assemblies together and fasten the latches.
2. Secure the battery pack to the receiver/exciter and amplifier/coupler combination and fasten the latches.
3. Reconnect the antenna and audio accessories.

**4-11/(4-12 blank)**

## APPENDIX I

## LIST OF ABBREVIATIONS

	<b>A</b>	LO	Local Oscillator
AGC	Automatic Gain Control	LSB	Lower Sideband
ALC	Automatic Level Control	LUF	Lowest Usable Frequency
		<b>M</b>	
AM	Amplitude Modulator	MHz	One Million Hertz
ANT SEL	Antenna Select	MUF	Maximum Usable Frequency
	<b>B</b>		
BCD	Binary Coded Decimal		
		<b>N</b>	
		NVIS	Near Vertical Incidence Skywave
	<b>C</b>		
cw	Continuous Wave		
		<b>P</b>	
		PEP	Peak-Envelope-Power
	<b>D</b>	PTT	Push-to-Talk
DC	Direct Current		
		<b>R</b>	
D-RCV	Data Receive	Rcv (RCV)	Receive
D-TR	Data Transceiver (transmit/ receive)	rf (RF)	Radio Frequency
		<b>S</b>	
	<b>F</b>	SB	Sideband
FOT	Frequency of Optimum Transmission or Optimum Traffic Frequency	SINAD	Signal Noise and Distortion
		SSB	Single Sideband
		<b>T</b>	
FREQ.	Frequency	TCXO	Temperature Compensated Crystal Oscillator
FSK	Frequency Shift Keying	TTY	Teletype
	<b>H</b>		
hf	High Frequency		
Hz	Hertz	USB	Upper Sideband
if.	Intermediate frequency		
		<b>V</b>	
	<b>K</b>	VCO	Voltage Control Oscillator
kHz	One Thousand Hertz	V-TR	Voice Transceiver (Transmit/ Receive)
KOH	Potassium Hydroxide		
	<b>L</b>	<b>X</b>	
		Xmt (XMT)	Transmit

## APPENDIX II

## PROPAGATION OF RADIO WAVES

**A2-1. GENERAL.**

**A2-2.** This appendix provides information on propagation of radio wave, in the high frequency hf band used by the radio set. The data and illustrations are based on average propagation characteristics of various hf band segments and indicate relative effectiveness during the day and night. They are to be used only as a general guide. Also discussed are two situation examples for optimizing communications.

**A2-3. RADIO WAVES.**

**A2-4.** Radio waves in the 2 thru 30 MHz region of the electromagnetic spectrum are propagated in two ways: the ground wave and the sky wave.

**A2-5. GROUND WAVE (Figure A2-1).** There are two types of ground waves which exist in various magnitudes depending on the frequency, type of antenna and terrain conditions.

**A2-6. Surface Wave.** This electromagnetic wave travels directly along the earth's surface and is dependent on the ground conductivity. Because ground conductivity is generally quite poor, unless propagated over water, this wave is rapidly attenuated. This attenuation is particularly pronounced at frequencies greater than 3 MHz making it unreliable for low-power communication networks beyond about 10 miles. Although attenuation is greater as frequency increases, better efficiency of the whip antenna and a drop in atmospheric noise favor the use of higher frequencies for links dependent on surface wave.

**A2-7. Direct Wave.** This is the "line-of-sight" wave which exists at all frequencies. The range of this wave is limited by the horizon. The direct wave is utilized most frequently for short range communication.

**A2-8 SKYWAVE (Figure A2-2).** Skywaves (ionospheric waves) are basically direct waves that have been reflected (skipped) back to earth by the ionosphere. The ionosphere exists at altitudes between 30 and 300 miles and consists of several layers of ionized gases. These gases are ionized by several factors, the primary of which is ultraviolet radiation; the greater the level of ionization the more reflective the ionosphere will be. The ultraviolet radiation level is directly proportional to the amount of sunspot activity and is predictable with a high degree of accuracy. This reflective power of the

ionosphere makes it possible to communicate over great distances using hf radio transmissions.

**A2-9. MAXIMUM USABLE FREQUENCY.** At any given time for a predetermined path length (skip distance there will exist a 'Maximum Usable Frequency,' MUF. This MUF is the highest frequency, radio wave that all be reflected back to earth in a specified geographical region for that path length. The MUF is a predictable number and is available in the form of propagation prediction charts. A sample of a propagation prediction chart is shown in figure A2-3. The MUF is highest at noon or early afternoon and drops to its lowest in the early morning hours. The MUF is lower on short paths and higher on long paths.

**A2-10. FREQUENCY OF OPTIMUM TRANSMISSION (FOT).** If the MUF is known, the best frequency selection would be one that is sufficiently close to the MUF to be reflected but not so close that it is affected by minor changes in ionospheric density. This is around 85 percent of the MUF. (Example: if MUF is 10 MHz, optimum frequency will be  $8.5 \times 10$  MHz or 8.5 MHz.) This frequency is called the Frequency of Optimum Transmission (FOT) and is commonly referred to as the Optimum Traffic Frequency.

**A2-11. MULTI-SKIP PHENOMENON.** There will be instances when the skywave is reflected between the ionosphere and the earth surface several times. This multi-skip phenomenon occurs quite frequently making global communications possible in the hf band. In addition to multi-skip there also exists a multipath propagation characteristic. If this occurs, two waves that took different paths will reach the receiver simultaneously. Depending on their relative phases, the signal strength will be enhanced or reduced. If the two waves are of equal amplitude and phase shifted 180 degrees, total cancellation will result and the received signal will fade out. Operating near the FOT will minimize multipath degradation.

**A2-12. HF BAND SEGMENTS.** The following is a breakdown of the hf band and a general description of the behavior of each segment. There will be exceptions but the descriptions will hold true in most cases. Figures A2-4 and A2-5 show relative



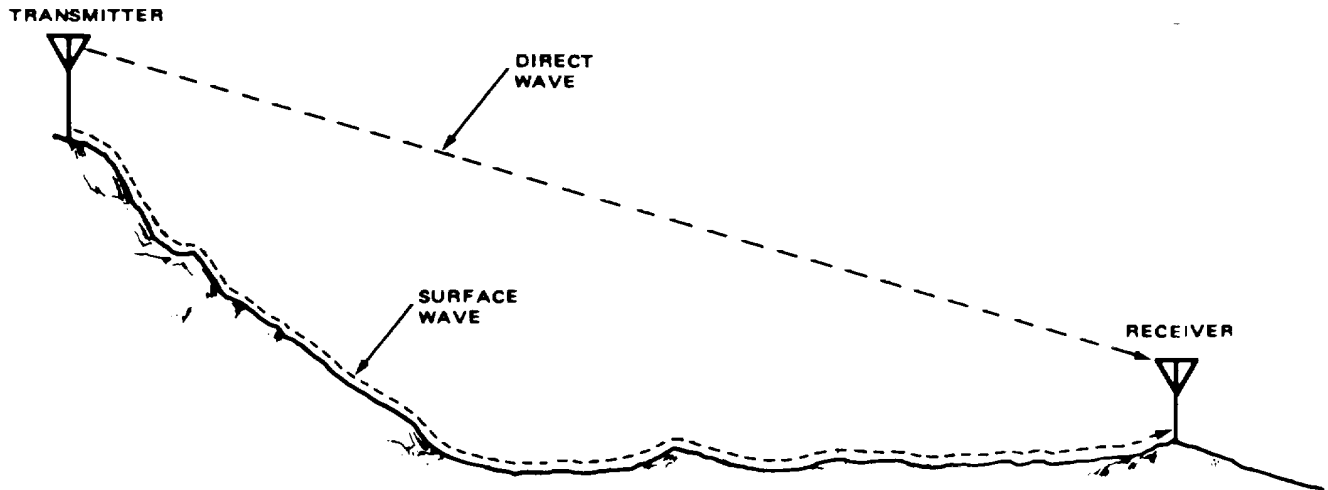

Figure A2-1. Ground Wave Propagation

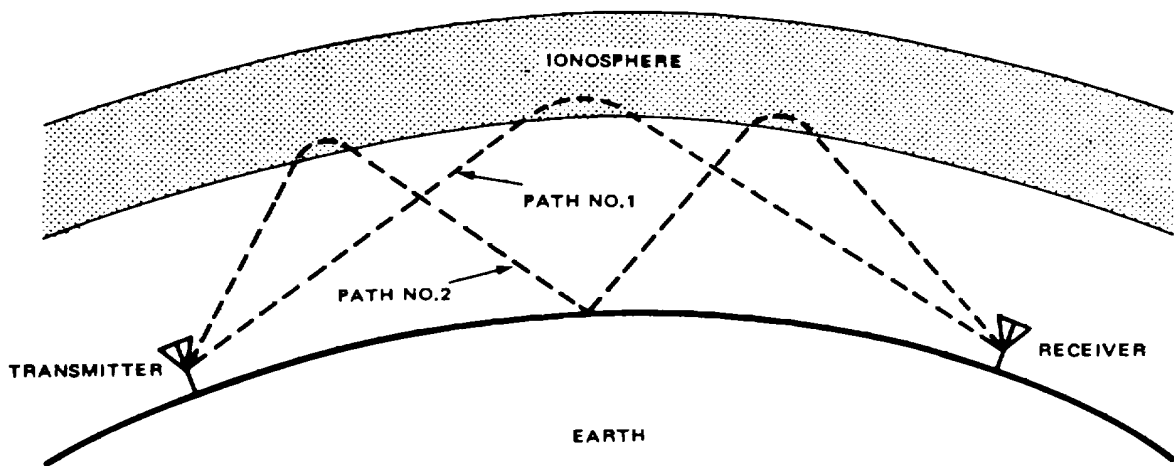

Figure A2-2. Skywave Propagation

effectiveness of different segments depending on the time (less than 100 miles and between 100-500 miles, respectively).

**A2-13. 2 thru 5 MHz.** This band is useful during daylight hours for intermediate and short-range skywave communications and good for long range (several thousand miles) during the light. The static level is highest during the summer.

**A2-14. 5 thru 10 MHz.** This band is similar to the 2 thru 5 MHz and except long-range communication is possible) during daylight hours under good conditions (high sunspot activity). The signals follow the darkness path best and during winter it is possible to

communicate with stations on the other side of the world. The winter months are better than the summer months because of the high summer static level especially in equatorial parts of the world.

**A2-15. 10 thru 15 MHz.** This band is the best choice for reliable intermediate and long range communication during all propagation conditions. During very low levels of sunspot activity, the band will not be useful at night but improves greatly at dawn and holds up well until dusk.

**A2-16. 15 thru 25 MHz.** This band is highly variable and quite dependent on sunspot activity. When conditions are good, it will be useful during day and

TYPICAL PROPAGATION PREDICTION CHART

TIME OF DAY (LOCAL)	D1		D2	
	MUF	FOT	MUF	FOT
0001	5.3	4.6	7.0	5.7
0002	4.9	3.8	6.5	4.9
0003	4.7	3.5	6.1	4.7
0004	4.6	3.5	6.1	4.6

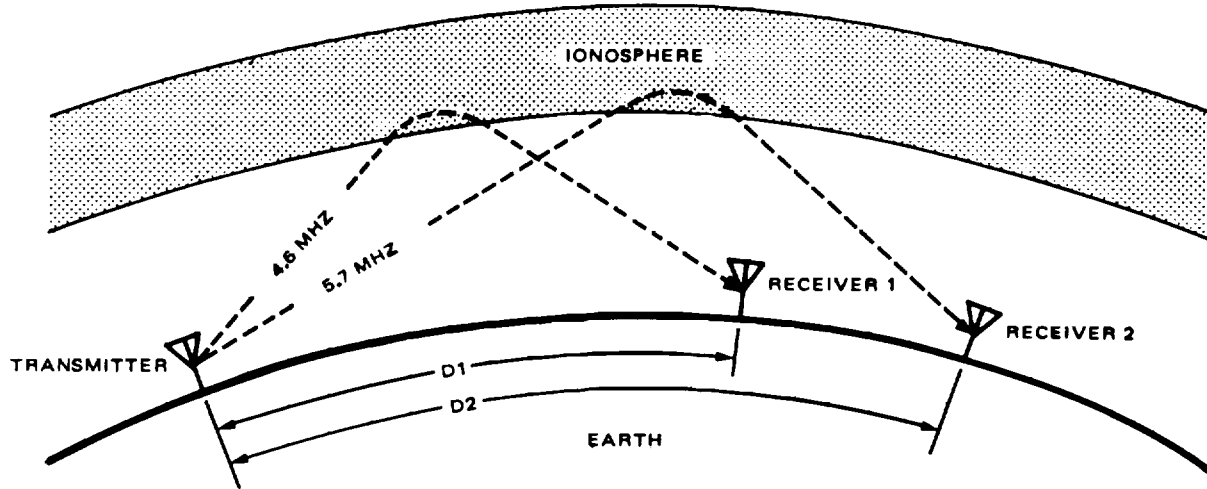

Figure A2-3. Relative Skip Distance for Two Different Frequencies

early night but if sunspot conditions are poor. It may not be usable at all. This band is suitable for short range (less than 10 miles) surface wave communication using a whip antenna.

**A2-17. 25 thru 30 MHz.** This band is useful as a very short range (several thousand miles) communications during good propagation condition. It is generally unusable for intermediate range communication.

**A2-18. SITUATIONAL EXAMPLES.**

**A2-19.** The following examples demonstrate several different situations that might occur when attempting to establish a communications link. These examples will help clarify the information on optimizing communication.

**A2-20. SITUATION 1.**

**A2-21. Scenario.** You are under enemy fire and cannot move without great risk. It is 1400 hours local time and you are trying to contact your Tactical Operation Center (10 miles south) to request air support. Your available frequencies are 2.138, 5.672, 9.193, 11.272 and 16.385 MHz.

**A2-22. Recommendation.** The tactical situation only permits the use of the whip antenna. Since the station with whom you want to communicate is only 10 miles south, the whip antenna will be adequate. Considering this to be short range surface wave, the best frequency selection would be a high one, in this case either 16.385 or 11.272

**A2-23. SITUATION 2.**

**A2-4**

**A2-24. Scenario (Figure A2-6).** Your squad must set up an observation post (OP) as part of a road surveillance team. You are required to check in with your headquarters (50 miles east) once every hour. Your OP is in a mountainous region and a large mountain is located between you and your headquarters (see figure A2-6). Your frequency possibilities are the same as in situation 1.

**A2-25. Recommendation.** Your OP is selected to give you a clear view of the area while camouflaging your position with the mountain as a background. Your radio location is selected to provide a clear path to your headquarters while shielding your transmissions from the enemy to reduce the possibility of being located with radio direction finding equipment. Because you will be maintaining a fixed location for an extended period of time, you may use any antenna you wish. The best choice would be the N<sub>1</sub> antenna. Your headquarters is only 50 miles east, however there is a large mountain blocking direct waves. The NVIS, with a very high angle of radiation, will bounce off the ionosphere and over the mountain. Your transmissions might be copied by the enemy but your shielded location will minimize the chances of being located. As the day progresses, you will want to change frequency in order to optimize communications. The following recommendation should ensure constant communications.

0001 to 0500 (dawn)	2.138 or 5.672 MHz
0500 to 1200	5.672 or 9.913 MHz
1200 to 2000 (dusk)	9.913 or 11.721 MHz
2000 to 2400	5.672 or 9.913 MHz

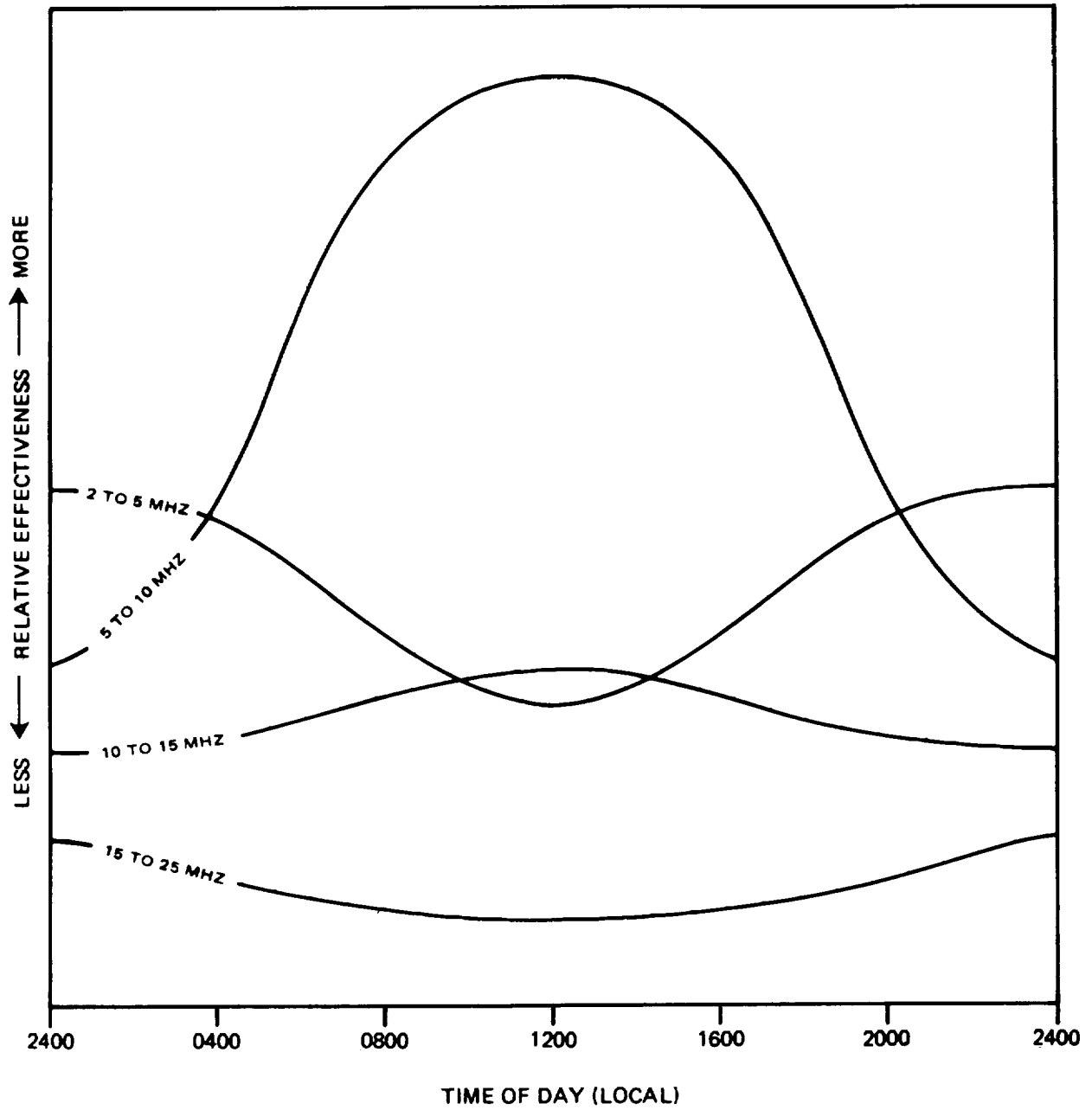

Figure A2-4. Short Range (Less Than 100 Miles) HF Communications Effectiveness

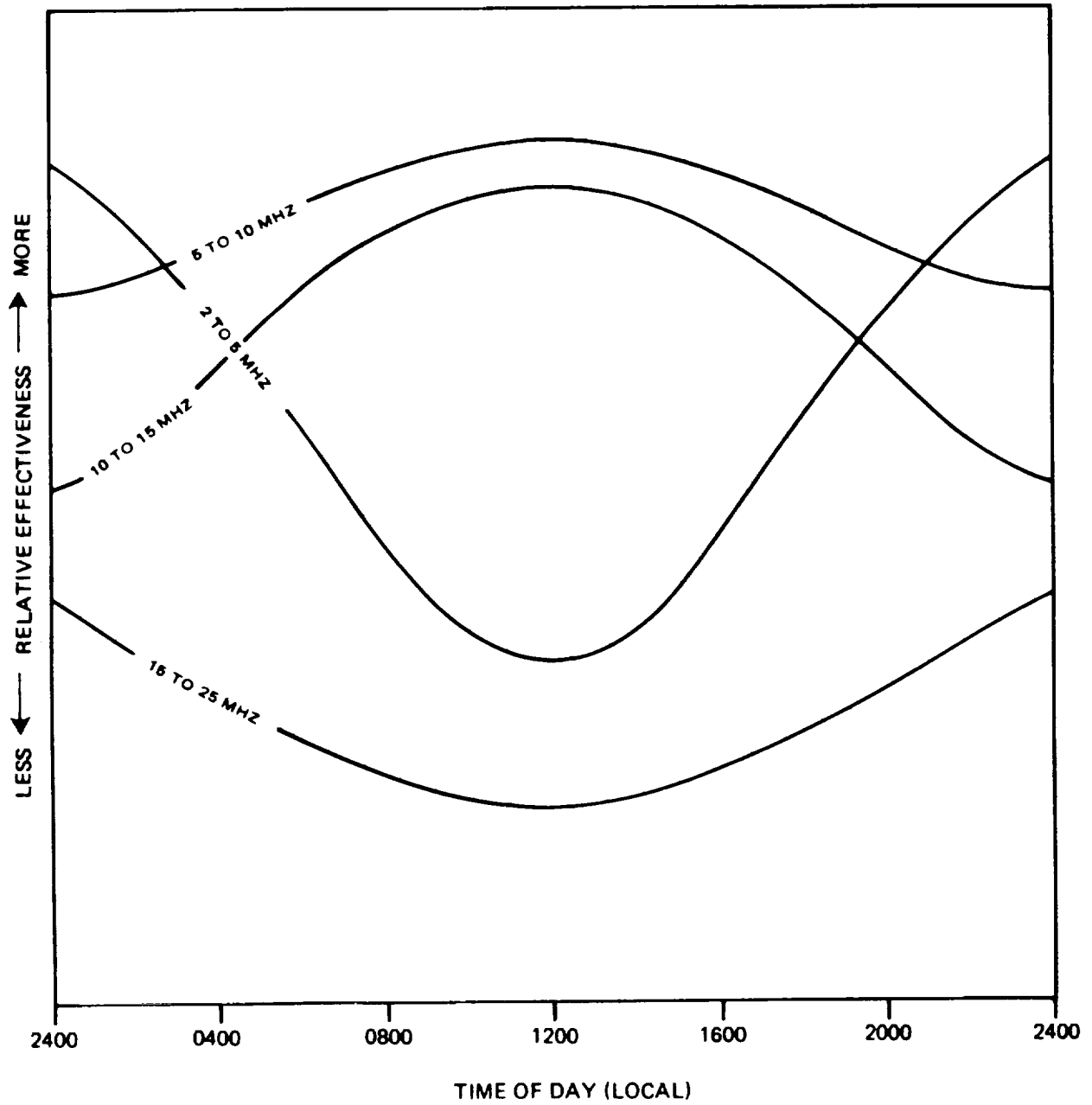

Figure A2-5. Intermediate Range (100-500 miles HF Communications Effectiveness

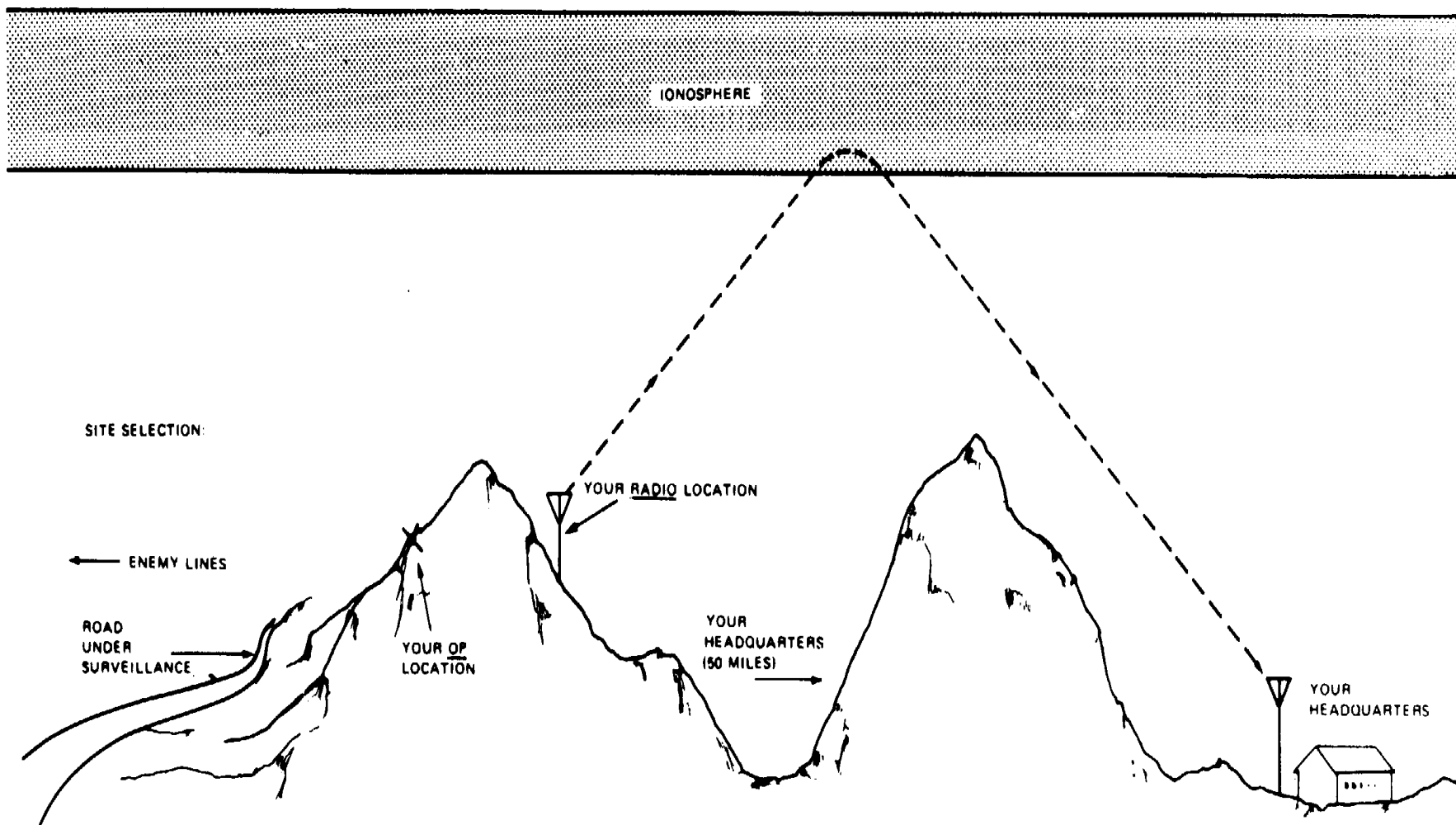

Figure A2-6. Site Selection, Situation

APPENDIX III

DIPOLE ANTENNA KIT

A3-1.

**A3-2.** This appendix provides information on the dipole antenna kit and general instructions for setting up various versions possible with this kit.

**A3-3.** The dipole antenna kit (fig A3-1) consists of two reels of antenna wire with the required BNC plugs, two reels of Dacron cord and weights, and a dipole lead-in fixture. The components of the wire antenna kit can be arranged in any of the following configurations: Slant wire (fig A3-2), two-support dipole (fig A3-3), sloping dipole (fig A3-4), or inverted-V dipole (fig A3-5). Figure A3-6 details the attachment of the antenna wires to the dipole fixture.

**A3-4. SLANT WIRE ANTENNA.** A slant wire antenna is much more effective than the whip antenna. The slant wire antenna requires the use of a dipole antenna (fig A3-1) and an antenna support. It is used when greater range is necessary than the whip antenna can provide, and when time or conditions do not allow the erection of a full horizontal dipole. The proper arrangement for a slant wire antenna is shown in figure A3-2. Erect a slant wire antenna as follows:

GENERAL

1. Decide on the direction that transmission is required and determine the alignment of the antenna (fig A3-7).

2. Unwind one of the dipole antenna reels to the length specified in the antenna length table A3-1. The equations for calculating dipole antenna lengths are:

Each leg in feet

$$= \frac{234}{\text{Frequency in MHz}}$$

Full length of dipole antenna in feet

$$= \frac{468}{\text{Frequency in MHz}}$$

3. Loosen the antenna wire through the notch on the reel to present unwinding further and lay the reel about 20 feet from the antenna support. Position the radio set at the end of the antenna and insert the red plug of the antenna wire into the BNC connector of the amplifier/coupler. Set ANT SEL switch to the BNC (middle) position.

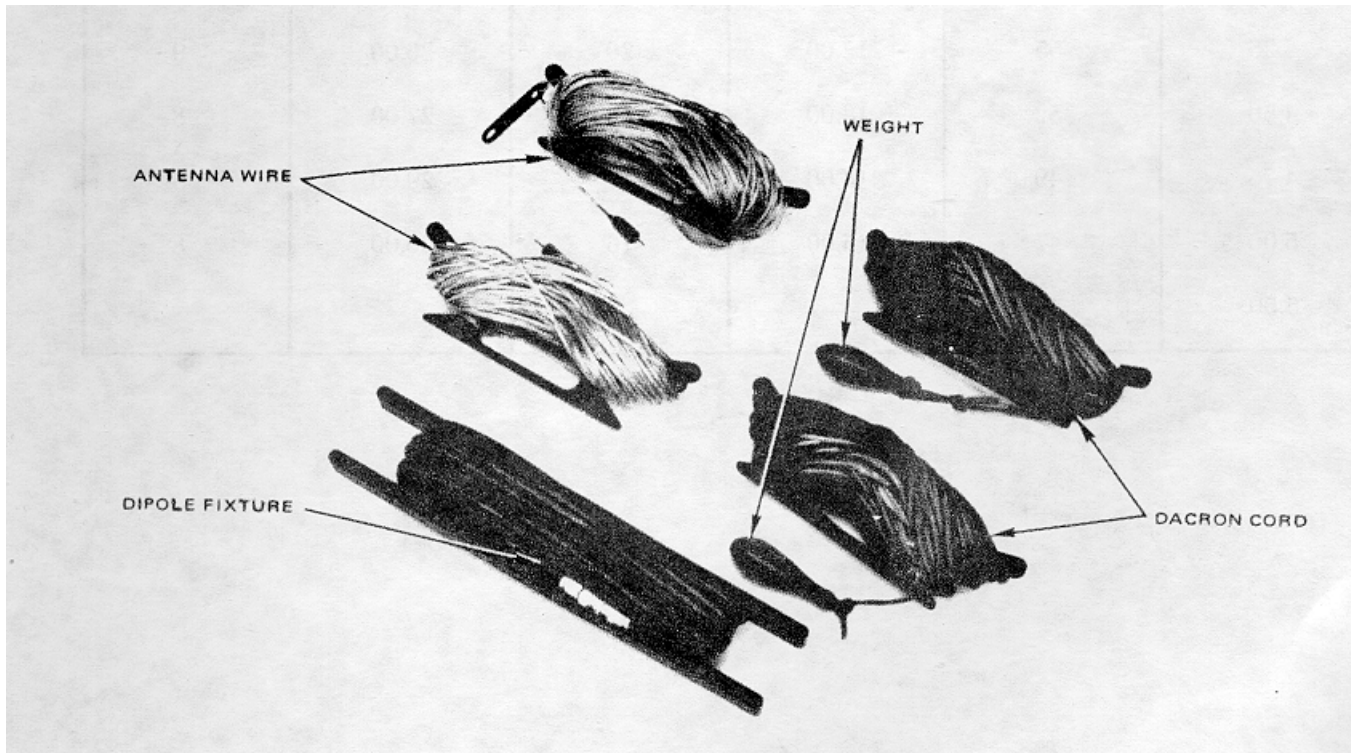

Figure A3-1. Dipole Antenna Kit

TABLE A3-1. ANTENNA LENGTH CHART

NOTE

Given length is for each leg of the dipole

Frequency (MHz)	Length (L) (Ft)	Frequency (MHz)	Length (L) (Ft)	Frequency (MHz)	Length (L) (Ft)
2.00	117	6.00	39	16.00	15
2.20	106	6.50	36	17.00	14
2.40	98	7.00	33	18.00	13
2.60	90	7.50	31	19.00	12
2.80	84	8.00	29	20.00	12
3.00	78	8.50	28	21.00	11
3.25	72	9.00	26	22.00	11
3.50	67	9.50	25	23.00	10
3.75	62	10.00	23	24.00	10
4.00	58	11.00	21	25.00	9
4.25	55	12.00	20	26.00	9
4.50	52	13.00	18	27.00	8
4.75	49	14.00	17	29.00	8
5.00	47	15.00	16	30.00	8
5.50	43				



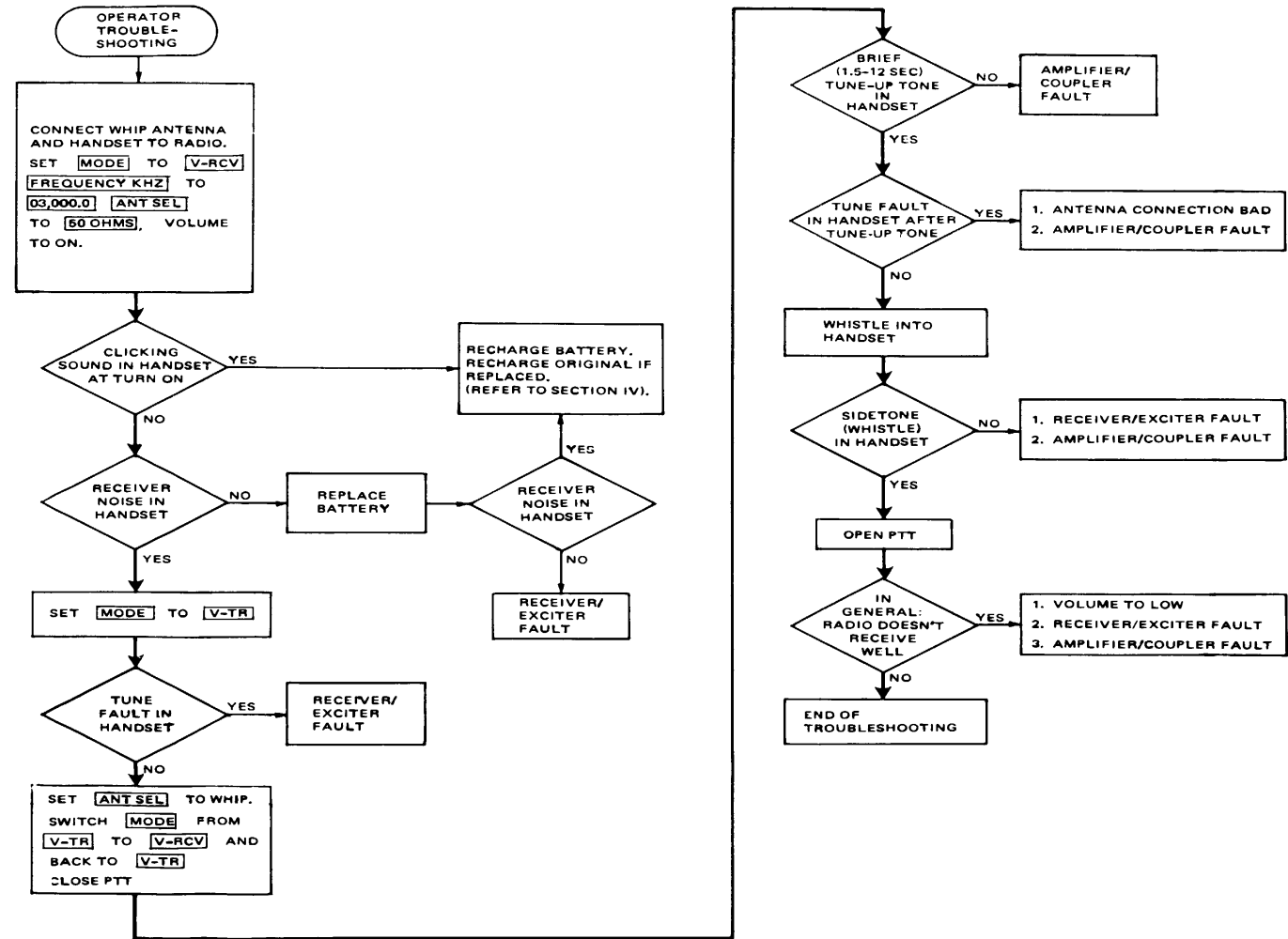

Figure 4-1. Operator's Radio Set Performance Test With Audible Tones

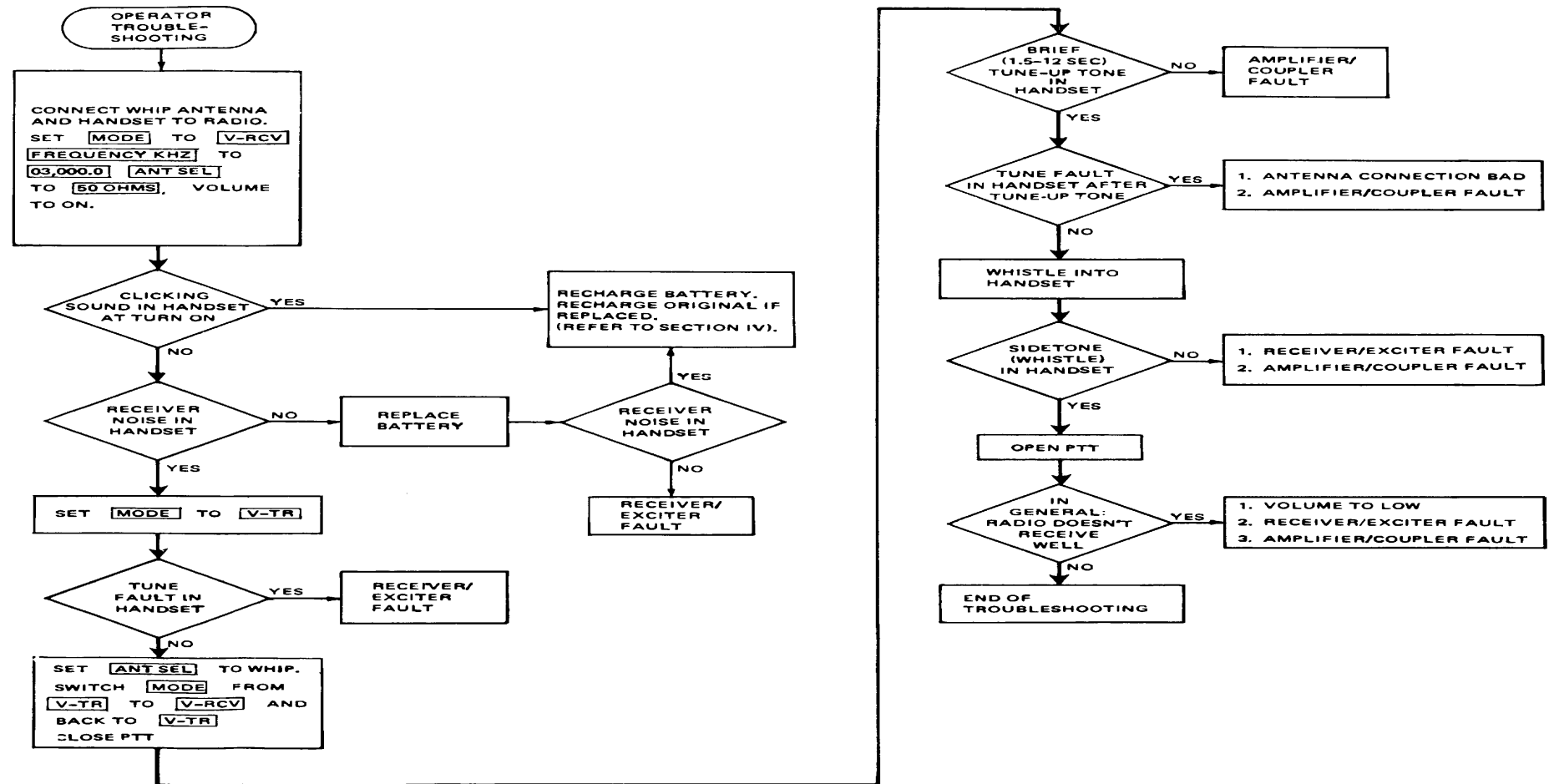

Figure 4-3. Organizational Radio Set Performance Test

4. Connect the black plug of the remaining antenna reel to the GND terminal. Unwind this wire and lay it on the ground in line with the antenna and in the opposite direction of the antenna support. Unwind the reel until it is about 1-1/2 times the antenna length and place the reel on the ground. (When the antenna is completely erected, this wire provides a counterpoise.)

5. Throw the lead weighted dacron cord over any convenient antenna support (such as a tree limb). Then fasten the cord reel to the antenna reel. Raise the antenna and fasten the cord to hold the antenna in place.

**A3-5. DIPOLE ANTENNA.** The dipole antenna is the most effective antenna and, time and tactical circumstances permitting, should be used in preference to either the whip or slant wire antenna. A dipole antenna is usually erected between two supports as shown in figure A3-3. Antenna supports are not provided with this equipment and it is not always possible to find two supports that are properly oriented and spaced. If only one support is available, or if terrain prohibits, a one-support dipole (figs. A3-4 and A3-5) should be used. Note that for both the dipole and slant wire antennas, the most effective receiving and transmitting direction is broadside, or 90° to the line of the wire. Erect a dipole antenna as follows.

1. Attach each dipole antenna wire to the dipole fixture (fig A3-6).

2. Determine the length of each leg of the dipole from the antenna length chart table A3-1.

3. Connect the coaxial lead-in of the feedline to the BNC connector of the amplifier/coupler. Set ANT SEL switch to the BNC (middle) position.

4. If two antenna supports are available, erect the antenna as illustrated in figure A3-3. If only one support is available, use the method shown in figures A3-4 and A3-5.

#### NOTE

**In raising a horizontal dipole, considerable pull force may be required to raise a long antenna. It is recommended that no more than about 100 pounds pull be applied to the cords used to raise it, or the wire may break.**

5. Try to select supports that will enable the height of the center of the dipole (sloping horizontal, or inverted) to be 1/3 of the leg length given in table A3-1, but never lower than about 10 feet. For example, at 6.0 MHz, the desired height would be  $1/3 \times 39' = 13'$  above ground. This may not be possible at the lower frequencies so raise the antenna center as high as available supports will practically allow.

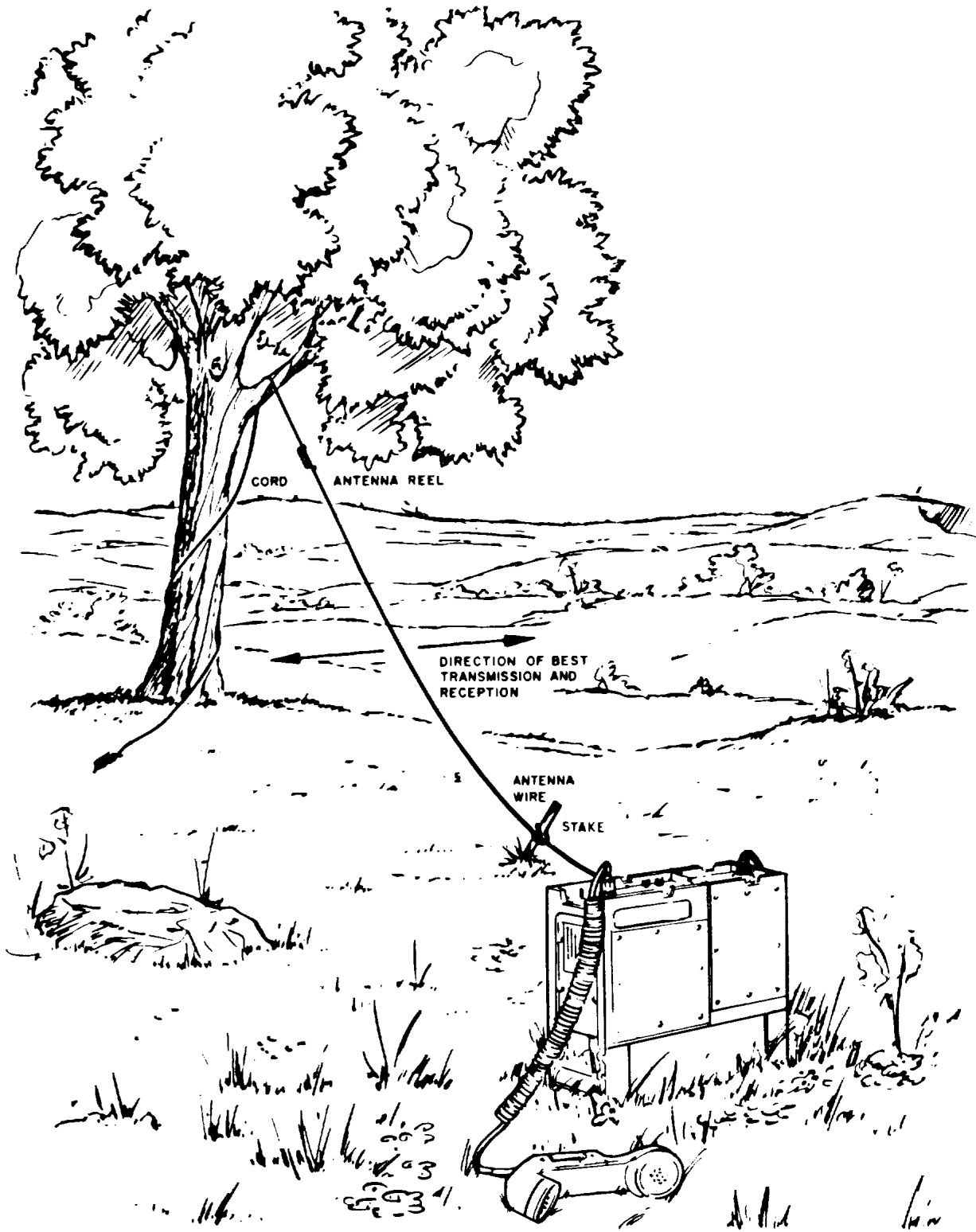

TM 5820-590-12-1-7

Figure A3-2. Slant Wire Antenna

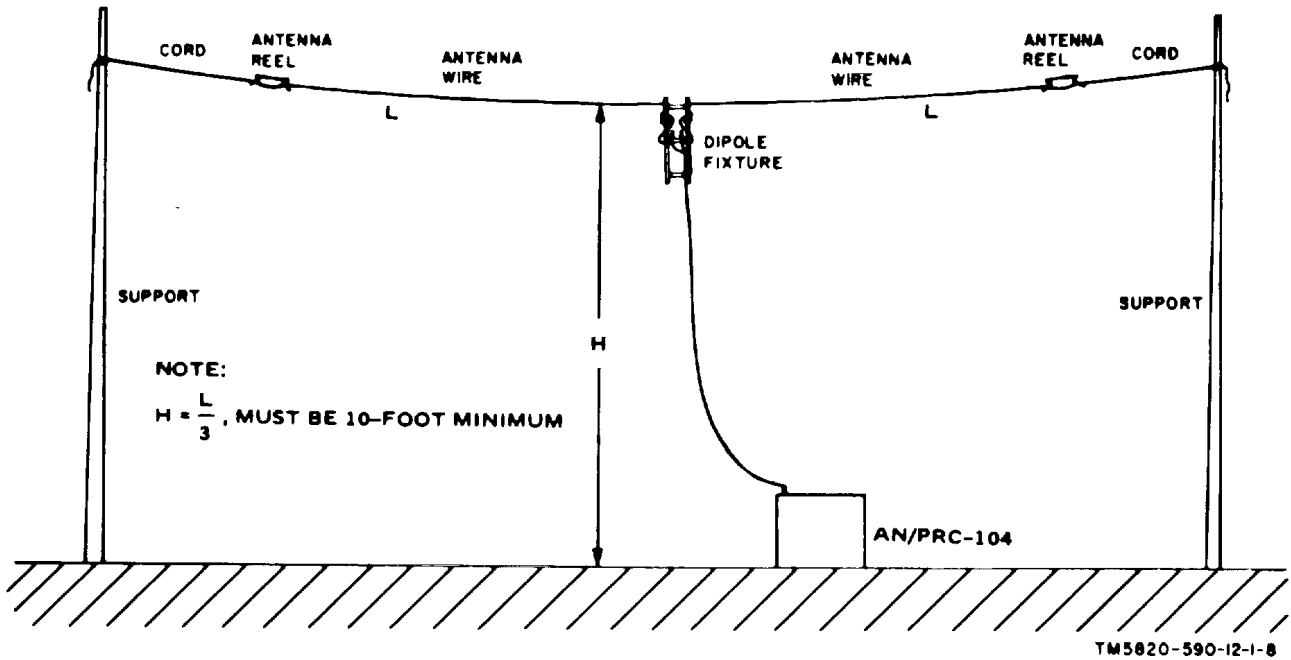

Figure A3-3. Two-Support Dipole Antenna

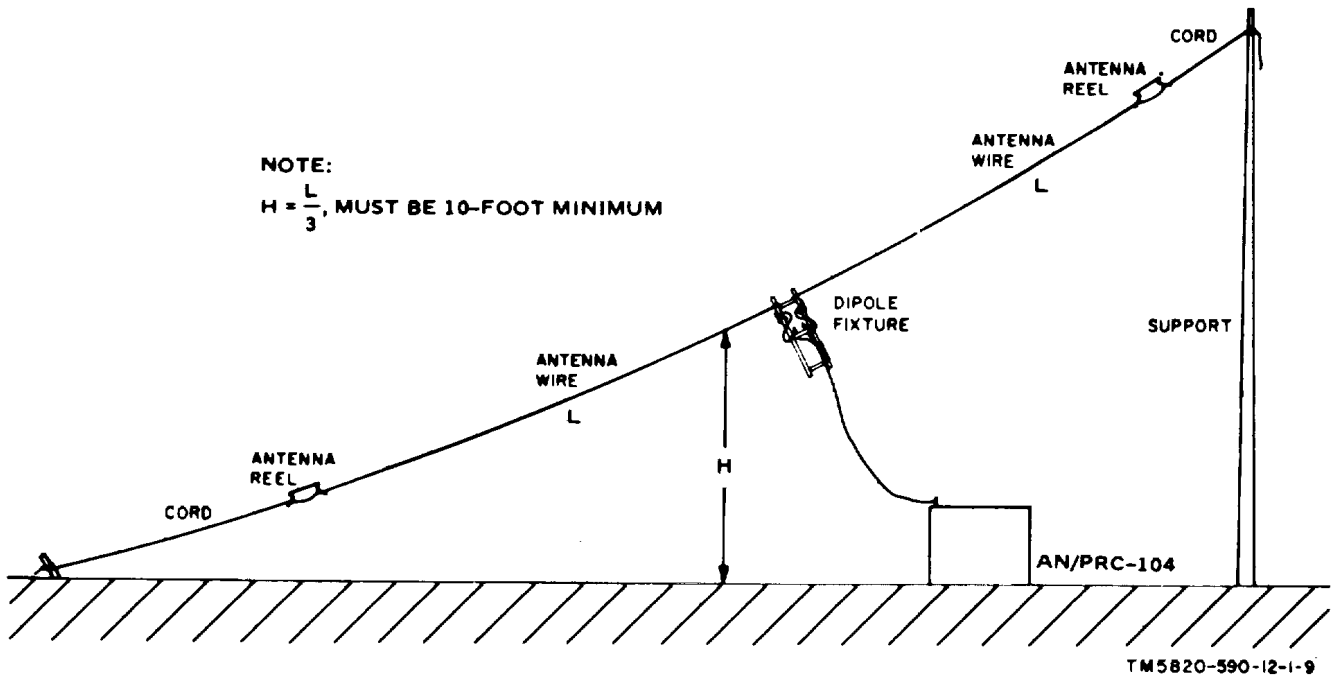

Figure A3-4. Sloping Dipole Antenna

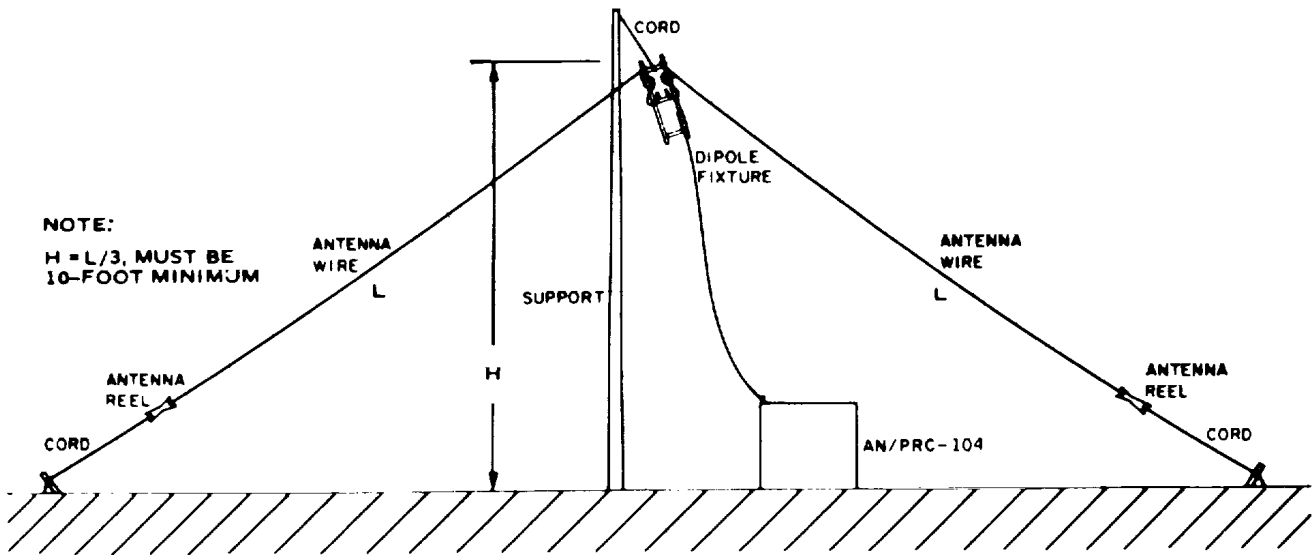

Figure A3-5. Inverted-V Dipole Antenna

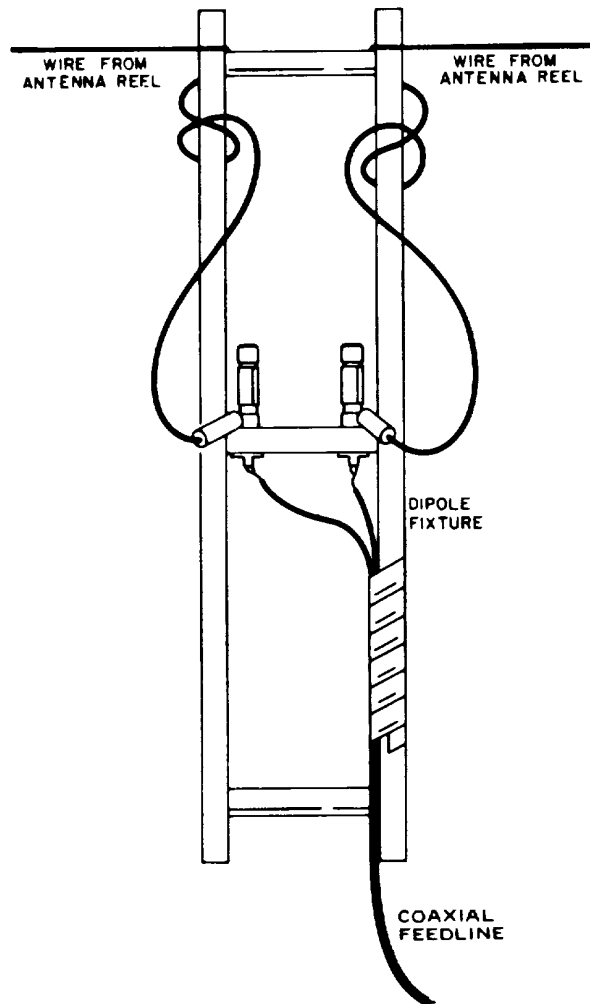

Figure A3-6. Attaching Antenna Wires to Dipole Fixture

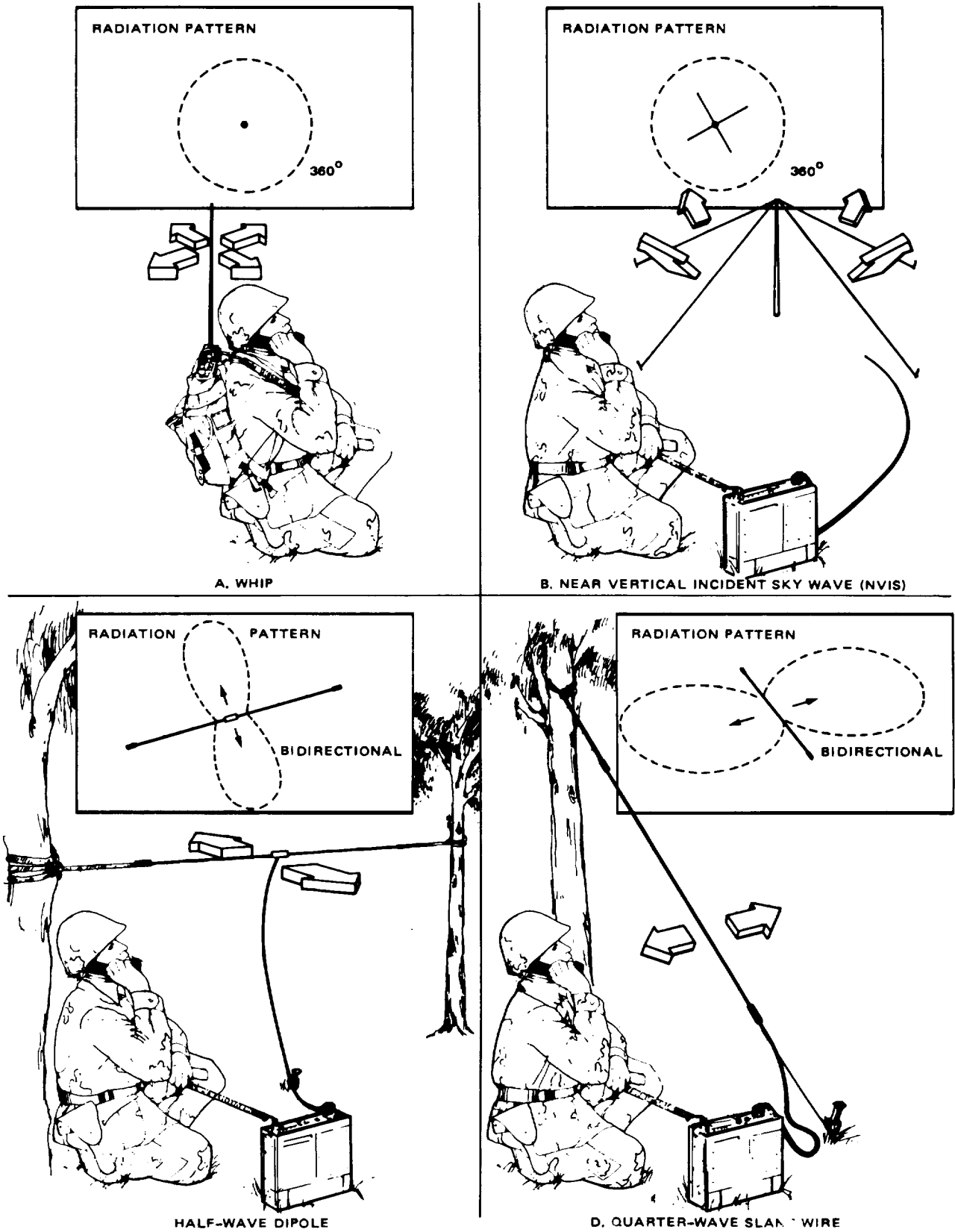

Figure A3-7. Antennas for Use With the Radio Set

**APPENDIX A**  
**REFERENCES**

---

AR 55-38	Reporting of Transportation Discrepancies in Shipments
AR 735-11-2	Reporting of Item and Packaging Discrepancies
AR 755-2	Disposal of Excess, Surplus, Foreign Excess, Captured, and Unwanted Material
DA Pam 310-1	Consolidated Index of Army Publications and Blank Forms
DA Pam 738-750	The Army Maintenance Management System (TAMMS)
SB 11-131	Vehicular Radio Sets and Authorized Installations
SB 38-100	Preservation, Packaging, Packing and Marking Materials, Supplies and Equipment Used by the Army
TB SIG 291	Safety Measures to be Observed When Installing and Using Whip Antenna, Field-type Masts, Towers, Antennas, and Metal Poles that are Used with Communication, Radar, and Direction Finder Equipment
TB 43-0118	Field Instructions for Painting and Preserving Electronics Command Equipment Including Camouflage Pattern Painting of Electrical Equipment Shelters
TM 11-5820-919-24P	Organizational, Direct Support, and General Support Maintenance Repair Parts and Special Tools List for Radio Set AN/PRC-104A
TM 11-5820-919-40-1	General Support Maintenance Manual Radio Set AN/PRC-104A
TM 740-90-1	Administrative Storage of Equipment
TM 750-244-2	Procedures for Destruction of Electronic Materiel to Prevent Enemy Use (Electronics Command)



**APPENDIX B**  
**MAINTENANCE ALLOCATION**

---

**Section I. INTRODUCTION**

**B-1. General**

This appendix provides a summary of the maintenance operations for the Radio Set AN/PRC-104(A). It authorizes categories of maintenance for specific maintenance functions on repairable items and components and the tools and equipment required to perform each function. This appendix may be used as an aid in planning maintenance operations.

**B-2. Maintenance Function**

Maintenance functions will be limited to and defined as follows:

*a. Inspect.* To determine the serviceability of an item by comparing its physical, mechanical, and/or electrical characteristics with established standards through examination.

*b. Test.* To verify serviceability and to detect incipient failure by measuring the mechanical or electrical characteristics of an item and comparing those characteristics with prescribed standards.

*c. Service.* Operations required periodically to keep an item in proper operating condition, i.e., to clean (decontaminate), to preserve, to drain, to paint, or to replenish fuel, lubricants, hydraulic fluids, or compressed air supplies.

*d. Adjust.* To maintain, within prescribed limits, by bringing into proper or exact position, or by setting the operating characteristics to the specified parameters.

*e. Align.* To adjust specified variable elements of an item to bring about optimum or desired performance.

*f. Calibrate.* To determine and cause corrections to be made or to be adjusted on instruments or test measuring and diagnostic equipments used in precision measurement. Consists of comparisons of two instruments, one of which is a certified standard of known accuracy, to detect and adjust any discrepancy in the accuracy of the instrument being compared.

*g. Install.* The act of emplacing, seating, or fixing into position an item, part, module (component or assembly) in a manner to allow the proper functioning of the equipment or system.

*h. Replace.* The act of substituting a serviceable like type part, subassembly, or module (component or assembly) for an unserviceable counterpart.

*i. Repair.* The application of maintenance services (inspect, test, service, adjust, align, calibrate, replace) or other maintenance actions (welding, grinding, riveting, straightening, facing, remachining, or resurfacing) to restore serviceability to an item by correcting specific damage, fault, malfunction, or failure in a part, subassembly, module (component or assembly), end item, or system.

*j. Overhaul.* That maintenance effort (service/action) necessary to restore an item to a completely serviceable/operational condition as prescribed by maintenance standards (i.e., DMWR) in appropriate technical publications. Overhaul is normally the highest degree of maintenance performed by the Army. Overhaul does not normally return an item to like new condition.

*k. Rebuild.* Consists of those services/actions necessary for the restoration of unserviceable equipment to a like new condition in accordance with original manufacturing standards. Rebuild is the highest degree of materiel maintenance applied to Army equipment. The rebuild operation includes the act of returning to zero those age measurements (hours, miles, etc.) considered in classifying Army equipments/components.

### **B-3. Column Entries**

*a. Column 1, Group Number.* Column 1 lists group numbers, the purpose of which is to identify components, assemblies, subassemblies, and modules with the next higher assembly.

*b. Column 2, Component/Assembly.* Column 2 contains the noun names of components, assemblies, subassemblies, and modules for which maintenance is authorized.

*c. Column 3, Maintenance Functions.* Column 3 lists the functions to be performed on the item listed in column 2. When items are listed without maintenance functions, it is solely for purpose of having the group numbers in the MAC and RPSTL coincide.

*d. Column 4, Maintenance Category.* Column 4 specifies, by the listing of a "work time" figure in the appropriate subcolumn(s), the lowest level of maintenance authorized to perform the function listed in column 3. This figure represents the active time required to perform that maintenance function at the indicated category of maintenance. If the number or complexity of the tasks within the listed maintenance function vary at different maintenance categories, appropriate "work time" figures will be shown for each category. The number of task hours specified by the "work time" figure represents the average time required to restore an item (assembly, subassembly, component, module, end item or system) to a serviceable condition under typical field operating conditions. This time includes preparation time, troubleshooting time, and quality assurance/quality control time in addition to the time required to perform the specific tasks identified for the maintenance functions authorized in the maintenance allocation chart. Subcolumns of column 4 are as follows:

- C- Operator/Crew
- O- Organizational
- F- Direct Support
- H- General Support
- D - Depot

*e. Column 5, Tools and Equipment.* Column 5 specifies by code, those common tool sets (not individual tools) and special tools, test, and support equipment required to perform the designated function

*f. Column 6, Remarks.* Column 6 contains an alphabetic code which leads to the remark in section IV, Remarks, which is pertinent to the item opposite the particular code.

**B-4. Tool and Test Equipment Requirements (Sect. III)**

*a. Tool or Test Equipment Reference Code.* The numbers in this column coincide with the numbers used in the tools and equipment column of the MAC. The numbers indicate the applicable tool or test equipment for the maintenance functions.

*b. Maintenance Category.* The codes in this column indicate the maintenance category allocated the tool or test equipment.

*c. Nomenclature.* This column lists the noun name and nomenclature of the tools and test equipment required to perform the maintenance functions.

*d. National/NATO Stock Number.* This column lists the National/NATO stock number of the specific tool or test equipment.

*e. Tool Number.* This column lists the manufacturer's part number of the tool followed by the Federal Supply Code for manufacturers (5-digit) in parentheses.

**B-5. Remarks (Sect. IV)**

*a. Reference Code.* This code refers to the appropriate item in section II, column 6.

*b. Remarks.* This column provides the required explanatory information necessary to clarify items appearing in section II.

**B-3 / (B-4 blank)**

**SECTION II MAINTENANCE ALLOCATION CHART  
FOR  
RADIO SET AN/PRC-104A**

(1) GROUP NUMBER	(2) COMPONENT ASSEMBLY	(3) MAINT. FUNCTION	(4) MAINTENANCE LEVEL					(5) TOOLS AND EQUIPMENT	(6) REMARKS
			C	O	F	H	D		
00	RADIO SET AN/PRC-104A	Service	0.2						
		Inspect	0.2						
		Test	0.2						
		Test		0.2				1,9,10,11	A
		Repair		0.2				1,9,10,11	B
01	RECEIVER-TRANSMITTER RT-1209 ( ) /URC	Replace	0.1						D,F
		Service	0.1						G
		Inspect	0.1						
		Test				0.4		1,2,7 thru 12,14	K
		Repair				0.4		1,2,7 thru 12,14	E,H,N
		Overhaul					2.5	1 thru 11,14, 20	I
0101	HOUSING, RT ASSEMBLY	Replace				0.3		12	
		Test					0.5	1	I K,I
		Repair					0.8	1,2,7 thru 12,14	E,H,I
010101	PTD CA ASSEMBLY FLEX	Replace					0.6	12	
		Test					0.4	1	C,I
		Repair					0.4	1,12,19	E,H,I
0102	HARMONIC FILTER ASSEMBLY	Replace				0.1		12	
		Test					0.3	1,3 thru 12, 14,20	C,I
		Repair					0.4	1,2,7 thru 12,14,19	H,I
		Align					0.1	1,7thru 11, 14,20	1
0103	MODULATOR/DEMODULATOR ASSEMBLY	Replace				0.1		12	
		Test					1.0	1 thru 11,14, 15,16,20	C,I
		Repair					0.4	1,2,7 thru 12 14,19	E,H,I
		Align					0.1	1 thru 11,12, 14,15,16,20	1
010301	FIRST FREQUENCY CONVERTER SUBMODULE	Replace					0.1	12	
		Test					0.2	1,3 thru 8, 14,20	C,I
		Repair					0.4	1,2,7 thru 12,14,19	H,I
010302	SECOND FREQUENCY CONVERTER SUBMODULE	Replace					0.1	12	
		Test					0.3	1,3 thru 8, 14,20	C,I
		Repair					0.4	1,2,7 thru 12,14,19	H,I
010303	THIRD FREQUENCY CONVERTER SUBMODULE	Replace					0.1	12	
		Test					0.3	1,3 thru 8, 14,20	C,I
		Repair					0.4	1,2,7 thru 12,14,19	H,I
0104	SYNTHESIZER ASSEMBLY	Replace				0.1		12	
		Test					0.8	1,3 thru 6, 8 thru 11,14, 15,17,20	C,I
		Repair					0.4	1,2,7 thru 12,14,19	H,I
		Align					0.1	1,3 thru 6, 8 thru 11,14, 15,17,20	I
0105	CONTROL PANEL ASSEMBLY	Replace				0.1		12	
		Test					0.2	1,8,14	C,I
		Repair					0.4	1,2,7 thru 11,12,14,19	E,H,I

**SECTION II MAINTENANCE ALLOCATION CHART  
FOR  
RADIO SET AN/PRC-104A**

(1) GROUP NUMBER	(2) COMPONENT ASSEMBLY	(3) MAINT. FUNCTION	(4) MAINTENANCE LEVEL					(5) TOOLS AND EQUIPMENT	(6) REMARKS
			C	O	F	H	D		
0106	POWER SUPPLY ASSEMBLY	Replace Test				0.1	0.7	12 1,8,9 thru 11,14,20	C,I
		Repair					0.4	1,2,7 thru 11,12,14,19	H,I
02	AMPLIFIER, RADIO FREQUENCY AM-6874 ( )/ PRC-104	Align Replace Service Inspect Test		0.1				1,8 thru 12, 14	I G K
		Repair					0.2	1,8 thru 12, 14	E,H
		Overhaul					2.5	1,8 thru 12, 14,20	1
0201	RF AMPLIFIER ASSEMBLY	Replace Test Repair	0.1	12			0.5 0.2	1 1,8 thru 12, 14,20	C,I H,I
0202	POWER AMPLIFIER MODULE ASSEMBLY	Replace Test	0.4	12			0.9	1,3 thru 11, 14,15,20	C,I
		Repair					0.2	1,8 thru 12, 14,19	E,H,1
		Align					0.1	1,3 thru 12, 14,15,20	1
020201	AMPLIFIER, POWER TOP CCA	Replace Test					0.4 0.9	13 1,3 thru 11, 14,15,20	C,I
		Repair					0.2	1,8 thru 12, 14,19	H,I
020202	AMPLIFIER, POWER BOTTOM CCA	Replace Test					0.4 0.9	12 1,3 thru 11, 14,15,20	C, I
		Repair					0.2	1, 8, thru 12, 14,19	H,I
0203	ANTENNA TUNER MODULE ASSEMBLY	Replace Test	0.1	12			0.7	1,7 thru 11, 14,15,20	C,I
		Repair					0.2	1,8 thru 12, 14,19	E,H,I
		Align					0.1	1,7,8,12,14, 20	I
020301	TUNER, ANTENNA TOP CCA	Replace Test					0.4 0.7	12 1,7 thru 11, 14,15,20	C,I
		Repair					0.2	1,8 thru 12, 14,19	H,I
020302	TUNER, ANTENNA BOTTOM CCA	Replace Test					0.4 0.7	12 1,7 thru 11, 14,15,20	C,I
		Repair					0.2	1,8 thru 12, 14,19	H,1
03	CASE RADIO SET CY-R291/PRC-104 (V)	Replace Repair		0.1			0.3	12,21	
04	ANTENNA AS-2259( )/GR	Repair		0.1					L
05	ANTENNA GROUP AN/GRA-50	Repair		0.1				13	M
06	BATTERY, STORAGE BB-590/U	Replace Service	0.1					18	J
07	BATTERY ASSEMBLY CASE CY-7875/PRC-104A	Repair		0.1				13	O

**SECTION III TOOL AND TEST EQUIPMENT REQUIREMENTS  
FOR  
RADIO SET AN/PRC-104A**

TOOL OR TEST EQUIPMENT REF CODE	MAINTENANCE CATEGORY	NOMENCLATURE	NATIONAL/NATO STOCK NUMBER	TOOL NUMBER
1	O,H,D	MULTIMETER AN/PSM-45	6625-01-139-2519	
2	H,D	GENERATOR, SIGNAL SG-1171/U/U	6615-01-133-6160	
3	D	SPECTRUM ANALYZER, MAINFRAME IP-1216(T)/GR	6625-00-424-4370	
4	D	--SPECTRUM ANALYZER, IF SECTION PL-1388/U	6625-00-431-9339	
5	D	--SPECTRUM ANALYZER, RF SECTION PL-1399/U	6625-00-432-5055	
6	D	--SPECTRUM ANALYZER, TRACKING GENERATOR SG-112/U	6625-00-155-5990	
7	H,D	RF SIGNAL GENERATOR SG-1144( )/U	6625-01-075-8478	
8	H,D	DC POWER SUPPLY PP-2309C/U	6130-01-139-2514	
9	O,H,D	TEST SET, RADIO FREQUENCY AN/USM-298	6625-00-880-5119	
10	O,H,D	DETECTING ELEMENT, 50H	6625-00-945-6092	
11	O,H,D	DUMMY LOAD, 8085	5985-00-477-8165	
12	H,D	TOOL KIT, ELECTRONIC EQUIPMENT TK-105/G	5180-00-610-8177	
13	O	TOOL KIT, ELECTRONIC EQUIPMENT TK-10I/G	5180-00-064-5178	
14	H,D	GENERAL SUPPORT MAINTENANCE KIT OA-9161/GRC-213 --RECEIVER/TRANSMITTER RT-1209 --AMPLIFIER, RF, AM-6874/PRC-104 --HANDSET H-250 --CABLE ASSEMBLY, ELECTRICAL POWER CX-13030 --AUDIO INPUT/KEYING, ADAPTER --AMPLIFIER, POWER SUPPLY AM-7152/GRC-213 --ADAPTER, WHIP --MOUNT,ELECTRICAL EQUIPMENT MT-6234/GRC-213 --CABLE ASSEMBLY, RF, --CABLE ASSEMBLY, AUDIO, --CABLE ASSEMBLY, CONDITIONED POWER, --ATTENUATOR, STEP, CN-1128/U --ATTENUATOR, COAXIAL, NARDA 765-20 --PROBE HIGH IMPEDANCE, HP MODEL NO. 1121A --TECHNICAL MANUAL --SPEAKER LS-454 --DC POWER CABLE CX-4720 --EXTENDER CABLE, AM-7152 POWER CONDITIONER CCA --EXTENDER CABLE AM-7152 VIC-I CCA --EXTENDER CABLE AM-7152 AMPLIFIER/SQULECH CCA	5820-01-159-1646	
15	D	OSCILLOSCOPE OS-261C(V)i/U	6625-01-119-7314	
16	D	DISTORTION ANALYZER AN/URM-184A	6625-00-802-8718	
17	D	FREQUENCY COUNTER AN/USM-459	6625-01-061-8928	
18	O	BATTERY CHARGER PP-6241/U	6130-00-106-6445	
19	D	BENCH REPAIR CENTER PRC-350C	4940-00-403-8176	

**SECTION III TOOL AND TEST EQUIPMENT REQUIREMENTS  
FOR  
RADIO SET AN/PRC-104A**

TOOL OR TEST EQUIPMENT REF CODE	MAINTENANCE CATEGORY	NOMENCLATURE	NATIONAL/NATO STOCK NUMBER	TOOL NUMBER
20	D	DEPOT ACCESSORIES: --MODULATOR/DEMODULATOR TEST EXTENDER CABLE, 755002B9420 --RF COAXIAL CABLE, 755002B9425 --RF EXTENDER CABLE, 755002B9430 --FREQUENCY CONVERTER TEST BED A1A1A1, 755002B9440 \$2,600.00 --FREQUENCY CONVERTER TEST BED A1A1A2, 755002B9450 \$2,600.00 --FREQUENCY CONVERTER TEST BED A1A1A3, 755002B9460 \$2,600.00 --HARMONIC FILTER/POWER AMPLIFIER TEST EXTENDER CABLES, 755002B9435 --SYNTHESIZER TEST EXTENDER CABLE, 755002B9470 --ANTENNA TUNER EXTENDER CABLE, 755002B9480 --100 OHM LOAD, 755002B9475 --130 OHM LOAD, 755002B9490		
21	H	DENT FILLER  <p align="center"><b>NOTE</b></p> <p align="center"><b>ALL EQUIPMENT DEFINED IN THIS SECTION (III) MAY BE SUBSTITUTED WITH EQUIVALENT ITEMS. EACH MAINTENANCE SHOP SHOULD EVALUATE THEIR CURRENT EQUIPMENT AVAILABLE AGAINST THEIR REQUIREMENTS.</b></p>	8010-00-926-2135	

SECTION IV. REMARKS

REFERENCE CODE	REMARKS
A	OPERATIONAL TEST.
B	TEST REQUIRED TO FAULT ISOLATE DEFECTIVE RT-1209, AM-6874, AM-7152, SA-2365 ASSEMBLIES/COMPONENTS OR WIRING PROBLEMS.
C	TEST REQUIRED TO FAULT ISOLATE DEFECTIVE MODULES, CIRCUIT CARDS, OR WIRING PROBLEMS.
D	REPAIR IS ACCOMPLISHED BY REPLACEMENT OF ASSEMBLIES/COMPONENTS OR CABLE ASSEMBLIES.
E	REPAIR IS ACCOMPLISHED BY REPLACEMENT OF MODULES, CIRCUIT CARDS, OR CABLE ASSEMBLIES.
F	THIS TASK CAN INCLUDE THE REPLACEMENT OF NONREPAIRABLE ASSEMBLIES (CABLE ASSEMBLY CG-3815( )/U; ADAPTER UG-349( )/U; BATTERY EXTENDER CABLE ASSEMBLY CX-13031, ANTENNA SPRING AB-129/PR, FRAME PACK FIELD, PACK SHELF, CARGO SHELF, HANDSET H-250/U, BATTERY CASE CY-7875, ANTENNA BASE AB-1241, TELEGRAPH KEY KY-872/PRC-104, WHIP ANTENNA AT-271, PRIMARY BATTERY BA-590/U, CARGO STRAP TIE-DOWN, CHARGER CABLE ASSEMBLY).
G	THIS TASK INVOLVES REMOVING EITHER THE RT-1209 OR AM-6874 FROM EITHER THE AN/GRC-213 OR AN/PRC-104A.
H	THIS TASK CAN INCLUDE THE REPLACEMENT OF A NONREPAIRABLE ASSEMBLY/PIECE PARTS.
I	THIS TASK WILL BE PERFORMED BY USMC DEPOT, ALBANY, GEORGIA.
J	THIS TASK INCLUDES THE REPLACEMENT OR BRINGING CURRENT CHEMICAL LEVELS WITHIN SPECIFIED STANDARDS. SEE TM 11-5820-919-12.
K	TEST REQUIRED TO FAULT ISOLATE TO DEFECTIVE MODULES, CIRCUIT CARDS, OR WIRING PROBLEMS.
L	SEE TM 11-5985-( )-14&P FOR MAINTENANCE ALLOCATION.
M	SEE TM 11-5820-467-15 FOR MAINTENANCE ALLOCATION.
N	ALTHOUGH THE REPLACEMENT OF FUSE (F-1) IS PERFORMED AT GSM, THE CONFIGURATION DRAWINGS IDENTIFY THIS ITEM AS PART OF FGC 01010101.
O	SEE TM 11-5820-919-12 FOR MAINTENANCE ALLOCATION.



**APPENDIX C**  
**COMPONENTS OF END ITEM LIST**

---

**Section I. INTRODUCTION**

**C-1. Scope**

This appendix lists integral components of and basic issue items for the AN/PRC-104(A) to help you inventory items required for safe and efficient operation.

**C-2. General**

This Components of End Item List is divided into the following sections:

*a. Section II. Integral Components of the End Item.* These items, when assembled, comprise the AN/PRC-104(A) and must accompany it whenever it is transferred or turned in. The illustrations will help you identify these items.

*b. Section III. Basic Issue Items.* These are the minimum essential items required to place the AN/PRC-104(A) in operation, to operate it, and to perform emergency repairs. Although shipped separately packed they must accompany the AN/PRC-104(A) during operation and whenever it is transferred between accountable officers. The illustrations will assist you with hard-to-identify items. This manual is your authority to requisition replacement BIII, based on TOE/MTOE authorization of the end item.

**C-3. Explanation of Columns**

*a. Illustration.* This column is divided as follows:

- (1) *Figure number.* Indicates the figure number of the illustration on which the item is shown.
- (2) *Item number.* The number used to identify item called out in the illustration.

*b. National Stock Number.* Indicates the National stock number assigned to the item and will be used for requisitioning.

*c. Part Number.* Indicates the primary number used by the manufacturer, which controls the design and characteristics of the item by means of its engineering drawings, specifications, standards, and inspection requirements to identify an item or range of items. Following the part number, the Federal Supply Code for Manufacturers (FSCM) is shown in parentheses.

*d. Description.* Indicates the Federal item name and, if required, a minimum description to identify the item.

*e. Location.* The physical location of each item listed is given in this column. The lists are designed to inventory all items in one area of the major item before moving on to an adjacent area.

*f. Usable on Code.* Not applicable.

*g. Quantity Required (Qty Reqd).* This column lists the quantity of each item required for a complete major item.

*h. Quantity.* This column is left blank for use during an inventory. Under the Rcvd column, list the quantity you actually receive on your major item. The Date columns are for your use when you inventory the major item at a later date; such as for shipment to another site.

SECTION II INTEGRAL COMPONENTS OF END ITEM

(1) ILLUSTRATION		(2) NATIONAL STOCK NUMBER	(3) DESCRIPTION  PART NUMBER (FSCM)	(4) LOCATION	(5) USUABLE ON CODE	(6) QTY REQD	(7) QUANTITY	
(A) FIG.	(B) ITEM						RCVD	DATE
1	1	5820-01-069-2368	RECEIVER TRANSMITTER RT-1209/URC			1		
1	2	5820-01-065-5044	AMPLIFIER, RADIO FREQUENCY AM-6874/PRC-104A			1		
1	3	5820-01-065-4442	CASE, BATTERY CY-7875/PRC-104A			1		
1	4	5820-00-065-4495	BASE, ANTENNA AB-1241/PRC-104A			1		
1	5	5820-00-243-4127	ANTENNA, SPRING SECTION AB-129/PR			1		
1	6	5985-00-646-2365	ANTENNA AT-271/PRC			1		
1	7		CASE, RADIO SET CY-8291/PRC-104A (P/N 755002A3108)			1		
1	8	5985-00-106-6130	ANTENNA NVIS AS-2259/PRC-104A			1		
1	9	5965-00-043-3463	HANDSET H-250/U			1		
1	10	5805-01-067-5388	KEY, TELEGRAPH KY-872/PRC-104A			1		
1	11		CARD INSTRUCTION (BACK PACK)					
1	3	6135-01-036-3495	BATTERY,PRIMARY, LITHIUM			1		
1	3	6140-01-063-3918	BATTERY,STORAGE, NICAD BB-590/U			1		

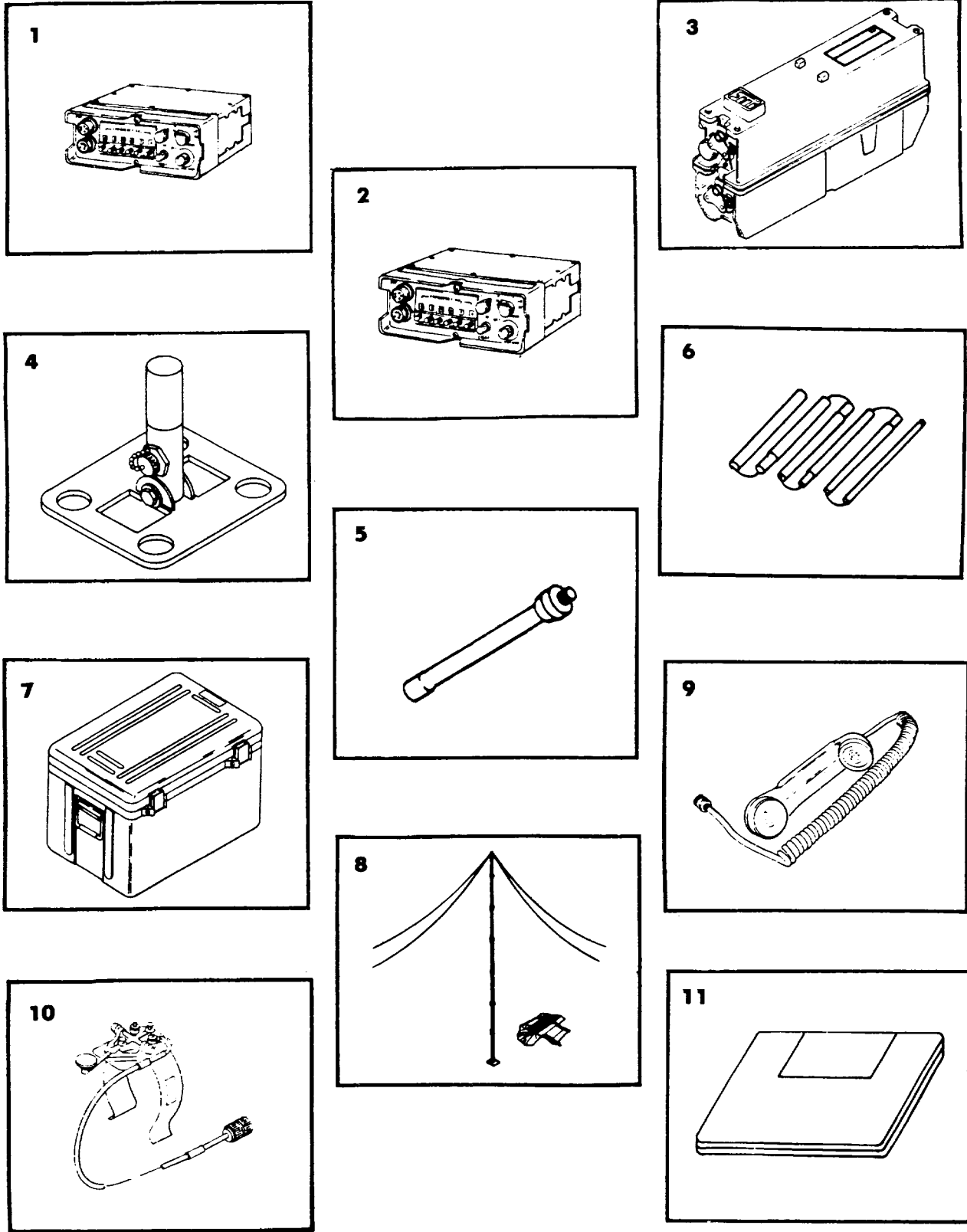

Figure 1

SECTION II INTEGRAL COMPONENTS OF END ITEM-Continued

(1) ILLUSTRATION		(2) NATIONAL STOCK NUMBER	(3) DESCRIPTION  PART NUMBER (FSCM)	(4) LOCATION	(5) USUABLE ON CODE	(6) QTY REQD	(7) QUANTITY	
(A) FIG.	(B) ITEM						RCVD	DATE
2	1	5805-01-065-4442	CABLE ASSEMBLY, POWER, ELECTRICAL CX-13031/PRC			1		
2	2		CABLE ASSEMBLY, RADIO FREQUENCY CG-3815/U 24" 755-00-2A 7114-1			1		
2	3	8465-00-001-6475	FRAME, PACK, GROUND TROOPS, W/STRAPS			1		
2	4	8464-01-019-9102	FIELD PACK, COMBAT NYLON, MED			1		
2	5	8465-00-001-6476	SHELF, CARGO SUPPORT			1		
2	6	8465-00-001-6477	STRAP, CARGO TIE DOWN			1		
2	7	5935-00-204-5118	ADAPTER UG-349/U			1		
2	8	5985-00-892-0758	ANTENNA GROUP AN/GRA-50			1		

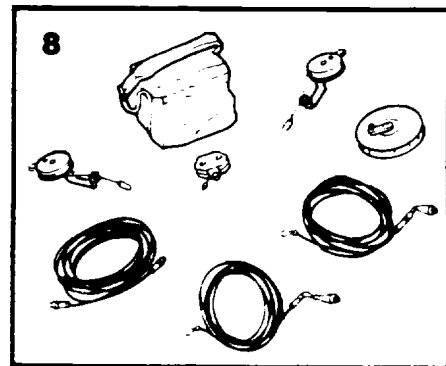
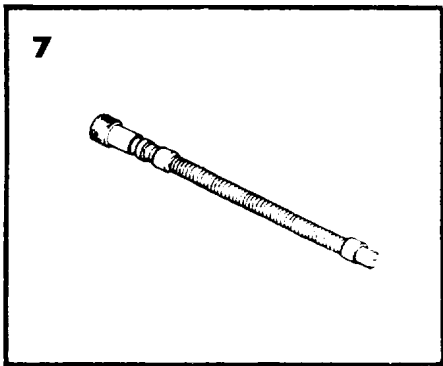
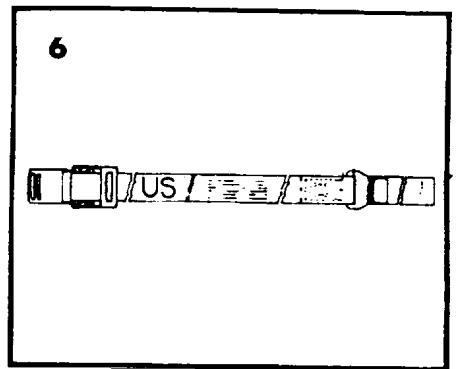
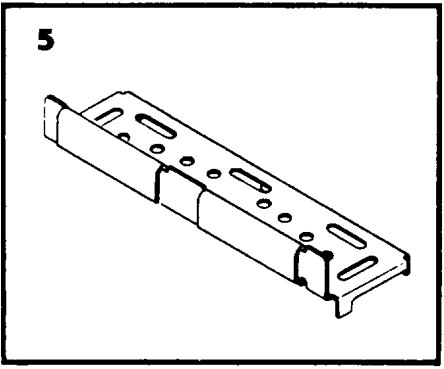
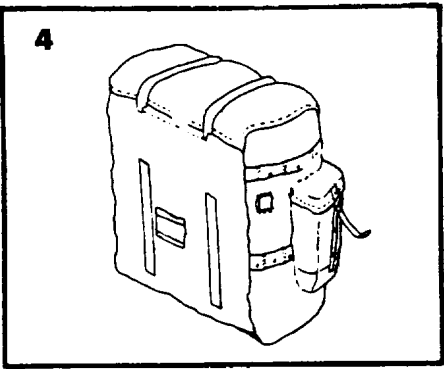
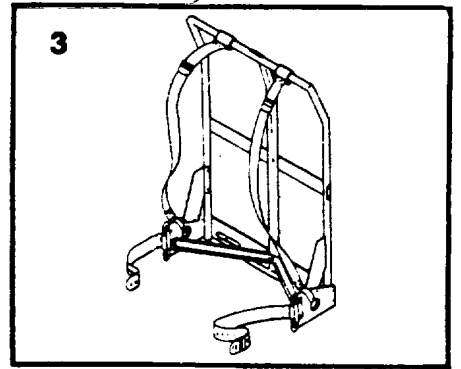
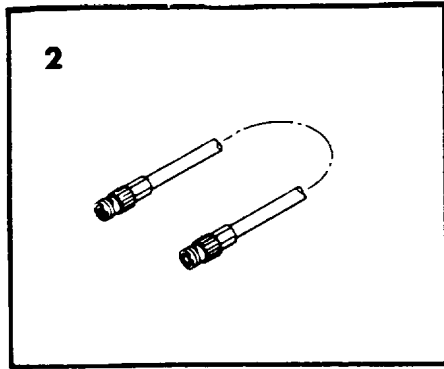
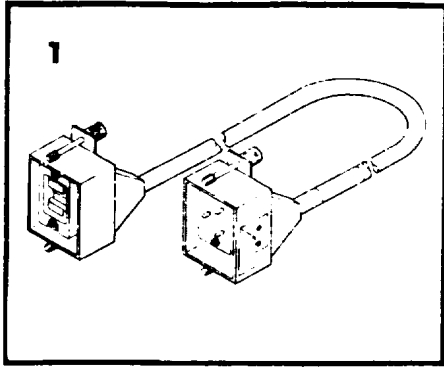

Figure 2

SECTION III BASIC ISSUE ITEMS

(1) ILLUSTRATION		(2) NATIONAL STOCK NUMBER	(3) DESCRIPTION  PART NUMBER (FSCM)	(4) LOCATION	(5) USUABLE ON CODE	(6) QTY REQD	(7) QUANTITY	
(A) FIG.	(B) ITEM						RCVD	DATE
			TM 11-5820-919-12, OPERATOR'S AND ORGANIZATIONAL MAINTENANCE MANUAL, RADIO SET AN/PRC-104(A)			1		
						C-7 /(C-8 blank)		

**APPENDIX D**  
**ADDITIONAL AUTHORIZATION LIST**

---

**Section I. INTRODUCTION**

**D- 1. Scope**

This appendix lists additional items you are authorized for the support of the Radio Set AN/PRC-104(A).

**D-2. General**

This list identifies items that do not have to accompany the AN/PRC-104(A) and that do not have to be turned in with it. These items are all authorized to you by CTA, MTOE, TDA, or JTA.

**D-3. Explanation of Listing**

National stock numbers, descriptions, and quantities are provided to help you identify and request the additional items you require to support this equipment. The items are listed in alphabetical sequence by item name under the type document (i.e., CTA, MTOE, TDA, or JTA) which authorizes the item(s) to you.



SECTION II ADDITIONAL AUTHORIZATION LIST

(1) NATIONAL STOCK NUMBER	(2) DESCRIPTION PART NUMBER AND FSCM	(3) USABLE ON CODE	(4) QTY AUTH
6130-00-106-6445	BATTERY CHARGER PP-6241/U	EA	1

**APPENDIX E**  
**EXPENDABLE SUPPLIES AND MATERIALS LIST**

---

**Section I. INTRODUCTION**

**E- 1. Scope**

This appendix lists expendable supplies and materials you will need to operate and maintain the Radio Set AN/PRC-104(A). These items are authorized to you by CTA 50-970, Expendable Items (Except Medical, Class V, Repair Parts, and Heraldic Items).

**E-2. Explanation of Columns**

*a. Column 1 Item Number.* This number is assigned to the entry in the listing and is referenced in the narrative instructions to identify the material (e.g., "Use cleaning compound, item 5, App. D").

*b. Column 2 Level.* This column identifies the lowest level of maintenance that requires the listed item.

- C - Operator/Crew
- O - Organizational Maintenance
- F - Direct Support Maintenance
- H - General Support Maintenance

*c. Column 3 National Stock Number.* This is the National stock number assigned to the item; use it to request or requisition the item.

*d. Column 4 Description.* Indicates the Federal item name and, if required, a description to identify the item. The last line for each item indicates the part number followed by the Federal Supply Code for Manufacturer (FSCM) in parentheses, if applicable.

*e. Column 5 Unit of Measure (U/M).* Indicates the measure used in performing the actual maintenance function. This measure is expressed by a two-character alphabetical abbreviation (e.g., ea, in, pr). If the unit of measure differs from the unit of issue, requisition the lowest unit of issue that will satisfy your requirements.

SECTION II EXPENDABLE SUPPLIES AND MATERIALS LIST

(1) ITEM NUMBER	(2) LEVEL	(3) NATIONAL STOCK NUMBER	(4) DESCRIPTION PART NUMBER AND FSCM	(5) UNIT OF MEAS
1	C	8305-00-267-3015	CHEESE CLOTH (81348)	YD
2	C	5340-00-906-3666	BRUSH, SOFT BRISTLED	EA
3	C	7930-01-055-6121	DETERGENT, GP, LIQ	GL
4	C	6850-00-105-3084	TRICHLOROTRIFLUOROETHANE (CLEANING COMPOUND)	OZ

ALPHABETICAL INDEX

Subject	Paragraph, Figure Table Number
<b>A</b>	
Amplifier/Coupler, Controls and Indicators.....	2-7, F2-1, T2-2
Antenna	
Dipole .....	A3-5, FA3-3, thru FA3-6, TA3-1
Selection .....	2-21, F2-2
Slant Wire .....	A3-4, FA3-2, FA3-7, TA3-1
Tuner, Functional Block Diagram .....	3-37, F3-9
Tuner, Functional Description.....	3-15
Audible Indicators .....	2-8
Audible Tones, Use of .....	4-15, F4-1, F4-2, F4-3, T4-3
Audio Filtering.....	3-26
<b>B</b>	
Battery Pack .....	1-11
Battery Pack Charging.....	4-42
Battery Indicators Low .....	2-10
Bypass Mode.....	2-15
<b>C</b>	
Cell Replacement .....	4-34
Checks and Services, Periodic.....	4-5
Daily.....	4-6, T4-1
Quarterly .....	4-8, F4-2
Weekly .....	4-7, T4-2
Cleaning .....	4-9
Communication	
Data .....	2-37
Normal .....	2-35
Telegraph .....	2-38
Controlled-Charge Method, Battery Pack Charging .....	4-44, F4-6
Control Panel, Functional Block Diagram.....	3-19, F3-3
Control Panel, Functional Description .....	3-10, F3-2
Controls and Indicators .....	2-5
Corrosion Control .....	4-11

ALPHABETICAL INDEX (Continued)

Subject	Paragraph, Figure, able Number
<b>D</b>	
Data Transceiver .....	2-39
Demolition to Prevent Enemy Use.....	1-17
Dipole Antenna.....	A3-5, FA3-3
.....	thru
.....	FA3-6, TA3-1
Direct Wave.....	A2-7
Disassembly, Battery Pack.....	4-27, F4-5
Disassembly and Packup .....	1-30
Distilled Water Addition .....	4-41
<b>E</b>	
Electrolyte	
Addition.....	4-40
Filling .....	4-36" T4-4
Replenishment.....	4-39
Equipment Description .....	1-5
Equipment, Not Supplied.....	1-19, TI-3
Equipment, Supplied .....	1-18, FI-I, T1-2
<b>F</b>	
Fixed Site Operation.....	1-13
Frequency of Optimum Transmission (FOT) .....	A2-10
Frequency Selection, Functional Block Diagram.....	3-20
Frequency Selection, Operating Considerations.....	2-26
<b>G</b>	
General Information.....	1-1
Ground Wave .....	A2-5, FA2-1
<b>H</b>	
Harmonic Filter, Functional Block Diagram .....	3-36, F3-8
Harmonic Filter, Functional Description .....	3-14
HIF Band Segments .....	A2-12, FA2-4, FA2-5
2 Thru 5 .....	A2-13
5 Thru 10 MHz.....	A2-14
10 Thru 1.5 MHz.....	A2-15
15 Thru 25 MHz.....	A2-16
25 Thru 30 MHz.....	2-17

ALPHABETICAL INDEX (Continued)

Subject	Paragraph, Figure, Table Number
<b>I</b>	
Initial Checkout.....	1-26
Installation and Setup.....	1-24, FI-4
Introduction	
Battery Pack Maintenance.....	4-23
Equipment Description .....	1-6
Maintenance Instructions.....	4-1
Operation Instructions .....	2-1
Theory of Operation.....	3-1
<b>L</b>	
List of Publications.....	1-21, TI-5
<b>M</b>	
Manpack, Operation .....	1-10
Maximum Usable Frequency.....	A2-9, FA2-3
Modes of Operation.....	2-33
Modulator/Demodulator, Functional Block Diagram.....	3-31, F3-6
Modulator/Demodulator, Functional Description .....	3-12
Multi-Skip Phenomenon .....	A2-11
<b>N</b>	
No-Tune Indicator.....	2-13
<b>O</b>	
Operation Instructions, Introduction .....	2-1
Operational Mode.....	3-21
Optimizing Communication with the AN/PRC-104 .....	2-18
<b>P</b>	
Panel Illumination .....	3-25
Performance Test and Troubleshooting, Battery Pack .....	4-29
Power	
Amplifier, Functional Block Diagram .....	3-35, F3-7
Amplifier, Functional Description .....	3-13
Output Indicator .....	2-11
Supply Functional Block Diagram.....	3-27, F3-4
Supply, Functional Description .....	3-16
Preliminary Setup .....	1-28
Propagation of Radio Waves.....	Appendix II
Publications, List of.....	1-21, TI-5

ALPHABETICAL INDEX (Continued)

Subject	Paragraph, Figure, Table Number
<b>R</b>	
Radio	
Set, Functional Description.....	3-5
Set, Relationship of Equipment .....	1-9
Silence.....	2-36
Waves .....	A2-3
Reassembly, Battery Pack .....	4-28, F4-5
Receive Operation.....	3-9
Receiver/Exciter, Controls and Indicators .....	2-6, F2-1, T2-1
Reference Data .....	1-15
Removal, General .....	4-21, F1-3
Repair and Replacement, Battery Pack .....	4-32, F4-4
Replacement General .....	4-22

**S**

Scope of Technical Manual.....	1-1
Sideband Selection.....	3-23
Site Selection.....	2-30
Situation Examples.....	A2-18
Situation 1.....	A2-20
Situation 2.....	A2-23, FA2-6
Skywave .....	A2-8, FA2-2
Slant Wire Antenna .....	A3-4, FA3-2, FA3-7, TA3-1
Support Equipment.....	1-20, T1-4
Surface Wave.....	A2-6
Synthesizer, Functional Block Diagram.....	3-28, F3-5
Synthesizer, Functional Description .....	3-11

**T**

Technical Characteristics .....	1-17, T1-1
Terminal Block Assembly Replacement.....	4-35
Test Procedure.....	1-29
Transmit Operation.....	3-8, F3-1
Transportation and Storage.....	1-22, F-1
Troubleshooting, General.....	4-4-13
Tuning Indicator.....	2-12

**U**

Unattended-Charge , Battery Pack Charging.....	4-43
--	------

**V**

Volume Control.....	3-24
VSW'R Indicator .....	2-14

By Order of the Secretary of the Army:

JOHN A. WICKHAM JR.  
*General, United States Army*  
Official: *Chief of Staff*

MILDRED E. HEDBERG  
Brigadier General, United States Army  
The Adjutant General

Distribution:

To be distributed in accordance with special list.





