

**GENERAL PURPOSE
COMMUNICATIONS RECEIVER**

MODEL SP-600-JX



INSTRUCTIONS

ISSUE 2 - MARCH 1951

Manufactured by
THE HAMMARLUND MFG. CO. INC.
460 West 34th St. New York 1, New York, U.S.A.

**GENERAL PURPOSE
COMMUNICATIONS RECEIVER**

MODEL SP-600-JX

INSTRUCTIONS

ISSUE 2 – MARCH 1951

Manufactured by
THE HAMMARLUND MFG. CO. INC.
460 West 34th St. New York 1, New York, U.S.A.

Printed in U. S. A.



FIG. 1
FRONT VIEW OF RECEIVER
SP-600-JX IN CABINET

TABLE OF CONTENTS

Title	Page
Technical Summary	4
I General Description	5
II Circuit Description	6
III Installation	8
IV Operation and Description of Controls	8
V Maintenance	9
VI Alignment	12
VII Conversion of Table Model Receiver for Rack Mounting	16
Table 1—Tube Socket Voltages	10
Table 2—Tube Socket Terminal Resistances	11
Table 3—RF and HF Oscillator Alignment Frequencies	13
Table 4—Approx. Signal Inputs at IF and AF Stages	13
Table 5—Parts List	17

ILLUSTRATIONS

Figure 1 Front View of Receiver SP-600-JX, in cabinet	2
Figure 2 Block Diagram	7
Figure 3 Location of Tubes and Adjustments	14
Figure 4 Audio and Overall Fidelity Curves	14
Figure 5 Selectivity Curves	15
Figure 6 Rear View of Receiver	20
Figure 7 Top View of Receiver	21
Figure 8 Top View of Receiver—Capacitor Shield Removed	22
Figure 9 Bottom View of Receiver SP-600-JX	23
Figure 10 Bottom View of Receiver—Tuning Unit Shield Removed	24
Figure 11 Circuit Diagram of Receiver	25
Figure 12 Connection Diagram—Receiver Chassis	27
Figure 13 Connection Diagram—Tuning Unit	29
Figure 14 Connection Diagram—Frequency Control Unit	31

GENERAL PURPOSE COMMUNICATIONS RECEIVER

MODEL SP-600-JX

TECHNICAL SUMMARY

Electrical Characteristics

Frequency Range—total 6 bands.....	.54 to 54.0 mc
Band 1.....	.54 to 1.35 mc
Band 2.....	1.35 to 3.45 mc
Band 3.....	3.45 to 7.40 mc
Band 4.....	7.40 to 14.8 mc
Band 5.....	14.80 to 29.7 mc
Band 6.....	29.70 to 54.0 mc

Maximum Undistorted Output—approximate—2.5 watts.

Output Impedance—600 ohms-balanced split windings.

Phone jack-winding; delivers 15 milliwatts to an 8000 ohm resistive load, when the audio output to the 600 ohm power load is adjusted to 500 milliwatts.

Power Supply Requirements

Line Rating..... 95, 105, 117, 130, 190, 210, 234 and 260 volt taps, 50-60 cycles.
Power Consumption..... 130 watts, 1.25 amps. at 117 volts—maximum.

Tube Complement—total 20

RF, IF and BFO Amplifiers.....	7 —	6BA6
HF, 2nd Conversion and BFO Oscillators.....	3 —	6C4
Crystal Controlled HF Oscillator.....	1 —	6AC7
Mixers.....	2 —	6BE6
Detector, "C" Bias Rectifier and Noise Limiter & Meter Rectifier.....	3 —	6AL5
AF Amplifier and IF Output.....	1 —	12AU7
Power Output.....	1 —	6V6GT
Rectifier.....	1 —	5R4GY
Voltage Regulator.....	1 —	0A2

Mechanical Specifications

Rack Model — Dimensions; 19 inches wide, 10½ inches high and 16½ inches deep from rack mounting surface. Weight 66 lbs.

Table Model — Dimensions; 21¾ inches wide, 12¾ inches high and 17¾ inches deep. Weight 87½ lbs.

Performance Data — (approximate values-taken on a sample receiver)

Sensitivity is 2.3 microvolts, or better, throughout the entire frequency range, for a signal to noise power ratio of 10 to 1.

Image rejection ratios are better than 80 db throughout the frequency range.

The IF rejection ratio at 600 kc is 2700 to 1

The AVC action will maintain the output constant within 12 db when the input is increased from 2 to 200,000 microvolts.

GENERAL PURPOSE COMMUNICATIONS RECEIVER

GENERAL DESCRIPTION

The SP-600-JX is a 20 tube Radio Communications Receiver with self contained power supply. The JX suffix in this model number denotes that this receiver is made in accordance with JAN specifications, with the exception of the use of a few capacitors and resistors where special design considerations require special values and tolerances not included in the JAN preferred value lists or where space limitations do not permit their use. The special components so used are equal or superior to the JAN components in quality.

The receiver is supplied in either a well ventilated steel, table model cabinet finished in dark grey to complement the lighter grey front panel or for mounting in a standard 19 inch relay rack.

The self contained power supply is designed for operation from a single phase, 50 to 60 cycle alternating current power source. The power transformer primary is provided with taps covering a line voltage range from 90 to 270 volts. The power consumption is 130 watts.

The receiver is suitable for either headphone or loud speaker reception of AM radio telephone, CW telegraph or AM MCW telegraph signals.

The standard model provides continuous coverage over a frequency range from 0.54 to 54.0 megacycles in six bands. The large easily operated band change control knob, on the front panel, selects the desired frequency band and a band indicator visible through a small front panel window indicates the frequency band in use. This control also aligns the dial frequency indicator with the proper dial scale.

In addition to the frequency scales, the main dial has an arbitrary scale which in conjunction with the band spread dial provides continuous band spread scales over each frequency band for extremely accurate logging and resetability.

The single tuning control is large and of special design to permit maximum traverse speed as well as exceptional operating ease. It controls both the main and band spread dials. An anti-backlash gear train provides extremely close calibration accuracy and completely accurate resetability. A tuning lock provides positive locking action without affecting the frequency setting.

The tuning ratio from the tuning control to the main dial is 50 to 1 and the ratio from the band spread dial to the main dial is 6 to 1.

An ingeniously designed rotary turret is employed to change bands and to place the coil assemblies of the RF amplifier, Mixer and First Heterodyne Oscil-

lator stages directly adjacent to their respective sections of the four gang tuning capacitor and their respective tubes. This assures maximum sensitivity at high signal to noise ratio.

Two stages of tuned radio frequency amplification are provided on all bands. The circuit for single conversion, used on frequencies up to 7.4 megacycles, includes a mixer, heterodyne oscillator, four stages of IF amplification, detector and AVC rectifier, noise limiter and meter rectifier, beat frequency oscillator, beat frequency buffer amplifier, IF output, AF amplifier and output power stage. The circuit for double conversion, employed for frequencies above 7.4 megacycles, includes a second mixer and a second heterodyne crystal controlled oscillator. The power supply system includes a B power rectifier, C bias rectifier and a voltage regulator.

The frequency control unit provides for fixed channel crystal controlled operation on any six frequencies chosen within the range of the receiver. Front panel controls permit the selection of the normal high stability continuously variable tuning or either of the six selected fixed frequency signals. For crystal controlled fixed channel operation it is only necessary to set the dial to the signal frequency, switch to the crystal frequency desired and tune with the delta frequency control. No retuning of the main tuning is necessary or desirable, when switching from VFO to crystal operation for the same signal frequency. These crystals are not supplied with the receiver, but should be purchased on special order from HAMMARLUND MFG. CO. specifying the signal frequency for which it is to function.

The two scale tuning meter normally indicates the relative strength of the received signal in db from 1 microvolt, when operated on AVC and with the RF gain control at maximum. A rear control is provided for adjustment at the plus 20 db scale reading with an RF signal input of 10 microvolts. On depression of the panel meter switch the lower scale of the meter indicates the audio output power level in db from 6 milliwatts. A rear control is provided for adjustment of the 0 db reading.

The AVC circuit is provided with separate time constants for CW and MCW operation. The beat frequency oscillator employs a high capacity Colpitts circuit which gives a high order of frequency stability and minimizes oscillator harmonics. The beat frequency oscillator voltage is introduced into the detector through a buffer amplifier which eliminates oscillator lock-in. This feature makes it possible to tune signals sharply to zero beat and permits the in-

clusion of the rear control for adjusting the beat oscillator injection to suit operating conditions. A front panel control varies the audio beat frequency from 0 to plus or minus 3 KC.

The noise limiter circuit effectively limits the interference from ignition systems or other sources of pulse type noise. The limiter switch permits optional use of the limiter.

The antenna input circuit is designed for use with a balanced line. The input impedance is nominally 100 ohms. The receiver may also be operated with a conventional single wire antenna.

The audio output circuit is designed for a 600 ohm load or line and is provided with a four terminal split winding for balanced load operation. Undistorted power output is approximately 2.5 watts. The head phone circuit when referred to an 8000 ohm load provides signals attenuated approximately 15 db below the 600 ohm power output.

An RF gain control is provided for the manual control of sensitivity in the presence of strong signals and

operates on either MANUAL or AVC.

The send receive switch desensitizes the receiver but leaves the power on to provide for instant reception between transmission periods. A rear receptacle provides for the connection of an external relay.

Radiation is negligible and complies with requirements for shipboard operation and for multi-receiver installations.

Frequency drift after a 15 minute warm up period, ranges between .001 percent and .01 percent of frequency depending on the frequency used. This is a very unusual degree of frequency stability for variable tuned HF oscillators and closely approaches crystal stability.

The selectivity control provides three degrees of crystal and three degrees of non-crystal selectivity ranging from sharp (.2kc) to broad (13.KC). The crystal filter embodies the same circuit features that have proved so effective and desirable in Hammarlund Super Pro Receivers, incorporated in an improved mechanical design.

II

CIRCUIT DESCRIPTION

General—The circuit is shown schematically in Figure 11. A block diagram, Figure 2, is provided to more clearly show the arrangement and functions of the various circuit sections. The location of the various tubes is shown in Figure 3. The circuit, for single conversion, used for signal frequencies up to 7.4 mc consists of two stages of RF amplification V-1 and V-2, First Mixer V-5, First Heterodyne Oscillator V-4, four stages of IF amplification V-7, V-9, V-10 and V-11, Detector and AVC rectifier V-14, Noise Limiter V-15, Beat Frequency Oscillator V-13, IF output and AF amplifier V-16-A and V-16-B, Output Power stage V-17 and the Power Supply system which includes B Power Rectifier V-19, C Bias Rectifier V-20 and Voltage Regulator V-18.

In the circuit for double conversion, used for signal frequencies above 7.4 mc, the Second Mixer V-6 and Second Heterodyne Oscillator V-8 are substituted for the Gate tube V-7.

Input Coupling—The antenna coupling is designed to provide optimum coupling from a 100 ohm transmission line. A balanced doublet or straight wire antenna may be used.

RF Amplifier—An ingeniously designed rotary turret is employed to change bands and to place the coil assemblies of the RF amplifier V-1 and V-2, Mixer V-5 and First Heterodyne Oscillator V-4 stages directly adjacent to their respective sections of the four gang tuning capacitor and their respective tubes. This assures maximum sensitivity at high signal to noise ratio.

First Heterodyne Oscillator—(Variable V-4)—The rotary turret band change switch, advanced de-

sign of the four gang, twin section, variable tuning capacitor and rugged construction throughout, provide frequency stability and dial calibration accuracy to a previously unattained degree.

First Heterodyne Oscillator—(Crystal Controlled V-3)—For services requiring extremely stable, fixed frequency operation, a crystal controlled high frequency oscillator is provided. Instant changeover from variable to crystal controlled oscillator, with a choice of six crystal positions, is effected by a front panel control. A second front panel control permits adjustment of the crystal oscillator frequency over a plus or minus .005 percent range.

Intermediate Frequency Amplifier—Single conversion to 455 kc is employed for signal frequencies below 7.4 mc. There are four stages of IF amplification incorporating the Hammarlund patented crystal filter circuit. Six positions of selectivity provide 6 db bandwidths of .2, .5, 1.3, 3, 8 and 13 kc. On the three narrower bandwidth positions, the crystal filter is in operation. The crystal phasing control provides extreme selectivity for the high attenuation of closely adjacent interfering signals.

Double conversion is employed for signal frequencies above 7.4 mc. The signal is heterodyned to 3.955 mc by the First Mixer V-5 and Heterodyne Oscillator V-4 or V-3 for high image rejection. The 3.955 mc signal is then heterodyned to 455 kc by the Second Mixer V-6 and the 3.5 mc Fixed Crystal Controlled Oscillator V-8, for selectivity.

Detector and AVC—The V-14 tube is used as a high level Detector and AVC Rectifier. The AVC circuit is provided with separate time constants for CW and MCW operation.

III

INSTALLATION

Tubes and Packing—Inspect the chassis to see that all tubes are firmly in their respective sockets and that any packing is removed from the receiver.

Power Supply—Make sure that the primary tap lead on the power transformer is connected to the transformer tap which most nearly agrees with the 50 to 60 cycle power source voltage.

Antenna—The input impedance at the antenna terminals is designed to match a 100 ohm transmission line. The angle plug adapter and connector, supplied with the receiver, is designed for use with a small diameter, "TWINAX" transmission line, which should be used with a balanced antenna installation. If it is desired to operate with a single wire antenna, the antenna lead-in wire should be connected to one terminal of the connector plug and a ground lead should be connected from the other terminal of the connector

plug to the ground terminal, which is adjacent to the antenna input receptacle at the rear of the tuning unit.

Speaker—The loud speaker should be of the permanent magnet dynamic type and should include a speaker voice coil to 600 ohm line matching transformer for connection to the 600 ohm audio output terminals of the receiver.

Headphones—Either low or high impedance headphones may be used in the phone jack. The high impedance type is recommended. The phone jack is located at the lower left side of the front panel.

Mounting—The receiver may be placed on a table or mounted in a standard 19 inch rack. If a table model is purchased, it is supplied with a steel cabinet. The cabinet should be placed in a position which permits the free access of air for the ventilation louvers.

IV

OPERATION

DESCRIPTION OF CONTROLS

The front panel dials and controls are shown in Figure 1 and the rear chassis skirt controls and terminals are shown in Figure 6.

Tuning Dials—The main dial is to the left and the band spread dial is to the right. The main dial has six frequency band scales, calibrated in megacycles and an arbitrary, outer scale. The band spread dial has an arbitrary, 0 to 100, scale. The numeral under the fixed pointer of the main dial indicates the number of revolutions that have been made by the band spread dial at any setting. Thus, if the pointer, for the outer scale, of the main dial indicates over the figure 4 and the band spread dial indicates 87.6, the reading to log for this setting is read, 487.6. This precise mechanical band spread system divides the rotation of the main dial over each frequency band into approximately 600 band spread divisions, with one half division calibration points. Since it is easy to estimate one tenth divisions, on the band spread scale, this divides each frequency band into approximately 6000 readable settings. This permits extreme accuracy in the logging of stations.

Crystal Controlled HF Oscillator—For operation on fixed frequency channels the "FREQUENCY CONTROL" is provided. The crystals are not supplied with the receiver, but will be supplied on special order. In order to insure correct crystal controlled frequency operation crystal units should be ordered from HAMMARLUND MFG. CO. INC. and the order should specify the signal frequency, for which each unit is to be used. The frequency control unit has provision for six crystals. Variable frequency op-

eration or crystal controlled frequency operation on any of the six crystal positions is selected by the "CRYSTAL SWITCH". The crystal oscillator is designed for use with suitable crystals at any frequency in the range of the receiver above one megacycle. The "DELTA FREQ" control is used to compensate for a very small plus or minus frequency tolerance of the crystals.

The procedure for crystal frequency control operation should be as follows: Loosen the knurled thumb screw on top of the crystal unit and push the retainer spring assembly to the rear. Insert the crystal or crystals in the crystal sockets, numbered 1 to 6. Bring the retainer spring assembly forward so that the springs press on top of the crystal holders and tighten the thumb screw. Mark the signal frequency for which each crystal was selected, in megacycles on the plastic chart provided for this purpose alongside the crystal switch. Pencil or ink may be used and can be erased if it is desired to change these figures at any time. The numerals on the chart should be used so that they agree with the numerals on the crystal socket positions, which are also indicated by the crystal switch. The main tuning dial should be set at the signal frequency for which operation is desired. The crystal switch should be set at the position corresponding to the number for that signal frequency on the chart. The Delta Frequency control should be adjusted for maximum signal or for zero beat as required. It should be noted that this tuning adjustment of the Delta Frequency control must be made each time that the signal frequency is changed and that the main tuning dial should be set to agree with the new signal frequency.

Tuning Lock—The tuning lock, located to the right of the tuning knob, provides a positive locking for the tuning mechanism without affecting the frequency setting, when it is desired to prevent accidental shifting of the tuning or when the receiver is operated under a severe condition of vibration.

Tuning Meter—The tuning meter at the upper left on the front panel is useful in accurately tuning a signal and provides an indication of the relative strength of the received signal in db from 1 microvolt. The "METER ADJ RF" control at the rear of the chassis provides adjustment of the plus 20 db reading on the RF scale, with a 10 microvolt input signal. Depression of the "METER SWITCH" converts the meter circuit for indication of the AF output power level in db from 6 milliwatts. This switch is spring returned to the RF scale circuit position when released and should not be depressed for the AF scale unless the audio output has been adjusted for low power output, by means of headphones or speaker. Failure to observe this precaution may result in damage to the meter. The "METER ADJ AF" control at the rear of the chassis provides adjustment of the 0 db reading on the AF scale, which should be made when the AF output power from the 600 ohm audio output terminals is 6 milliwatts or 1.9 volts across a 600 ohm load.

Band Change—The large knob, to the left, is the band change control. Each revolution of this control turns the turret, containing the RF and HF oscillator coil, trimmer and switch contact assemblies, from one frequency band to the next. The turret has no stops and may be turned in either direction desired. A positive detent mechanism assures correct location of the various bands. The band change control simultaneously operates the small frequency band dial, located at the center of the panel and aligns the dial frequency indicator with the proper scale.

Selectivity Switch—The selectivity switch provides three crystal and three non-crystal degrees of selectivity, ranging from extremely sharp, for CW reception, to broad for good fidelity MCW operation. The control knob dial indicates the 6 db band width at each setting.

Phasing Control—The phasing control permits high attenuation of closely adjacent channel interference on either side of the signal frequency, when the crystal selectivity positions are used.

Beat Frequency Oscillator—The beat frequency oscillator is turned "on" for CW signal operation by the "MOD-CW" switch. The beat frequency dial

should be set at zero for tuning to zero beat and then adjusted to give the desired audio pitch. The beat frequency oscillator injection voltage is adjustable by the "BFO INJ" control on the rear skirt of the chassis.

Noise Limiter—The noise limiter switch is independent of other controls and is useful in greatly attenuating noise interference from ignition or similar pulse type sources, regardless of the mode of operation.

Send-Receive—The send-receive switch permits desensitizing the receiver during transmission periods, to prevent damage to the receiver, when operated in proximity to the transmitter and provides instant return to reception between transmission periods.

Relay Receptacle—The relay receptacle, on the rear of the receiver, is connected in parallel with the send-receive switch and provides for the connection of an externally connected relay, to perform the send-receive operation. When the relay is used the send-receive switch is left in the "open" or "send" position.

AVC-Manual Switch—The AVC-Manual Switch permits the choice of either AVC or Manual sensitivity operation as desired. The AVC has a delay bias, which insures maximum sensitivity for weak signals.

RF Gain Control—The RF gain control provides adjustment of the sensitivity for signals of various strength, when under the "manual" operating condition, in order that the receiver sensitivity may be adjusted to suit the signal strength and prevent overloading. This control is also in the circuit when operating on AVC, in order that the sensitivity may be adjusted to reduce undesirable noise during "off" periods in the transmission of the received signal. When it is desired to use the tuning meter for indication of relative signal strength, the RF gain control should be at maximum.

Audio Gain Control—The audio gain control adjusts the audio input to the audio amplifier tube. It should be adjusted for the required audio output when operating on AVC and is best left at or near maximum when operating on MANUAL control.

Phono Input—Terminals are provided on the rear of the receiver for phonograph or other audio frequency source input to the audio frequency amplifier.

Convenience Outlet—A power outlet receptacle is provided on the rear of the receiver chassis for operating an accessory, such as an electric clock or lamp.

V

MAINTENANCE

This receiver is designed for continuous duty and should normally require little attention beyond the replacement of tubes. However, should trouble develop that cannot be eliminated with new tubes, the socket voltages and resistances should be measured to chassis. Any appreciable departure from the values shown in tables 1 and 2 will generally indicate the

component or circuit at fault.

Operating and maintenance of the receiver will be greatly facilitated if the contents of this instruction manual are thoroughly digested. Approximate input signal values for stage by stage gain checks are shown in table 4.

TUBE SOCKET VOLTAGES—TABLE 1

Voltage to chassis. Measurements made with Weston Model 663 Volt-Ohmmeter, except those indicated by asterisk were made with Measurements Corp. Model 62 VTVM. The 500 volt scale was used for all voltages above 10 volts and the 10 volt scale for voltages below 10 volts. Line voltage 117, no signal input. Audio Gain control at minimum and CW-MOD switch on "CW"

TUBE	SOCKET PIN NUMBERS									MODE OF OPERATION
	1	2	3	4	5	6	7	8	9	
V-1	*-1	—	*6.3ac	—	200	90	—	—	—	RF Gain max.
V-1	*-54	—	*6.3ac	—	260	235	—	—	—	RF Gain min.
V-2	*-1	—	*6.3ac	—	210	100	—	—	—	RF Gain max.
V-2	*-54	—	*6.3ac	—	260	240	—	—	—	RF Gain min.
V-3	—	*6.3ac	—	—	—	0	—	265	—	RF Gain max.—VFO operation
V-3	—	*6.3ac	—	—	—	150	—	265	—	RF Gain max.—Crystal Freq. Control
V-3	—	*6.3ac	—	—	—	0	0	290	—	RF Gain min.—VFO operation
V-3	—	*6.3ac	—	—	—	150	0	280	—	RF Gain min.—Crystal Freq. Control
V-4	130	—	*6.3ac	—	130	—	—	—	—	RF Gain max. or min.
V-5	—	1.2	*6.3ac	—	140	110	—	—	—	RF Gain max. or min.
V-6	—	—	*6.3ac	—	225	—	*-1	—	—	RF Gain max.—Freqs. below 7.4mc
V-6	—	—	*6.3ac	—	260	—	*-1	—	—	RF Gain min.—Freqs. below 7.4mc
V-6	—	—	*6.3ac	—	225	90	*-1	—	—	RF Gain max.—Freqs. above 7.4mc
V-6	—	—	*6.3ac	—	260	105	*-1	—	—	RF Gain min.—Freqs. above 7.4mc
V-7	*-11	—	*6.3ac	—	225	170	—	—	—	RF Gain max.—Freqs. below 7.4mc
V-7	*-11	—	*6.3ac	—	260	190	—	—	—	RF Gain min.—Freqs. below 7.4mc
V-7	*-11	—	*6.3ac	—	225	0	—	—	—	RF Gain max.—Freqs. above 7.4mc
V-7	*-11	—	*6.3ac	—	260	0	—	—	—	RF Gain min.—Freqs. above 7.4mc
V-8	0	—	*6.3ac	—	0	—	—	—	—	Frequencies below 7.4mc
V-8	30	—	*6.3ac	—	30	—	—	—	—	Frequencies above 7.4mc
V-9	*-1	—	*6.3ac	—	205	90	—	—	—	RF Gain max.
V-9	*-54	—	*6.3ac	—	260	235	—	—	—	RF Gain min.
V-10	*-1	—	*6.3ac	—	205	90	—	—	—	RF Gain max.
V-10	*-54	—	*6.3ac	—	260	235	—	—	—	RF Gain min.
V-11	*-11	—	*6.3ac	—	210	145	—	—	—	RF Gain max.
V-11	*-11	—	*6.3ac	—	240	145	—	—	—	RF Gain min.
V-12	—	—	*6.3ac	—	210	40	—	—	—	RF Gain max.—BFO Injection max.
V-12	—	—	*6.3ac	—	240	45	—	—	—	RF Gain min.—BFO Injection max.
V-13	25	—	*6.3ac	—	25	—	—	—	—	RF Gain max. or min.
V-14	—	—	*6.3ac	—	*22	—	—	—	—	RF Gain max. or min.
V-15	—	—	*6.3ac	—	—	—	—	—	—	RF Gain max. or min.
V-16	50	—	1.5	—	—	210	—	6.4	*6.3ac	RF Gain max.
V-16	52	—	1.6	—	—	240	—	7.4	*6.3ac	RF Gain min.
V-17	—	—	260	228	—	—	*6.3ac	12	—	RF Gain max.
V-17	—	—	280	265	—	—	*6.3ac	13	—	RF Gain min.
V-18	150	—	—	—	150	—	—	—	—	RF Gain max. or min.
V-19	—	300	—	—	—	—	—	300	—	RF Gain max.—*5 V ac Pin 2 to Pin 8
V-19	—	320	—	—	—	—	—	320	—	RF Gain min.—*5 V ac Pin 2 to Pin 8
V-20	—	*-96	*6.3ac	—	—	—	*-96	—	—	RF Gain max.
V-20	—	*-97	*6.3ac	—	—	—	*-97	—	—	RF Gain min.

TUBE SOCKET TERMINAL RESISTANCE—TABLE 2

Resistance to chassis. Measurements made with Weston Model 663 Volt-Ohmmeter.

Tube removed from socket under measurement. Audio Gain Control at maximum, RF Gain Control at minimum. Limiter Switch "OFF". CW-MOD Switch on "CW". AVC-MAN Switch on "AVC".

Socket Pin No.	1	2	3	4	5	6	7	8	9	MODE OF OPERATION
Tube Socket										
V-1	1.8M	0	—	0	48K	80K	0	—	—	
V-2	1.8M	0	—	0	48K	80K	0	—	—	
V-3	0	—	0	47K	0	46K	—	46K	—	Crystal Freq. control pos. 1-6
V-4	Inf.	Inf.	—	0	Inf.	47K	0	—	—	Crystal Freq. control pos. 1-6
V-4	48K	Inf.	—	0	Inf.	47K	0	—	—	VFO Operation
V-5	47K	150	—	0	48K	53K	500K	—	—	
V-6	22K	0	—	0	46K	Inf.	100K	—	—	Freq. Bands below 7.4mc
V-6	22K	0	—	0	46K	70K	100K	—	—	Freq. Bands above 7.4mc
V-7	115K	0	—	0	46K	Inf.	0	—	—	Freq. Bands above 7.4mc
V-7	115K	0	—	0	46K	80K	0	—	—	Freq. Bands below 7.4mc
V-8	—	—	—	0	Inf.	22K	0	—	—	Freq. Bands below 7.4mc
V-8	—	—	—	0	150K	22K	0	—	—	Freq. Bands above 7.4mc
V-9	1.3M	0	—	0	52K	80K	0	—	—	
V-10	1.3M	0	—	0	52K	80K	0	—	—	
V-11	125K	0	—	0	48K	50K	0	—	—	
V-12	0	0	—	0	48K	145K	*	—	—	*0 to 1K (BFO Injection control)
V-13	—	—	—	0	195K	100K	0	—	—	
V-14	0	770K	—	0	16K	0	220K	—	—	
V-15	94K	Inf.	—	0	Inf.	0	220K	—	—	
V-16	150K	500K	1K	0	0	46K	470K	680	—	
V-17	0	0	46K	46K	470K	Inf.	—	360	—	
V-18	118K	—	—	—	78K	—	0	—	—	
V-19	—	46K	0	55	—	55	—	46K	—	
V-20	50K	65K	—	0	50K	0	65K	—	—	

VI ALIGNMENT

The alignment of a modern communications receiver requires precision instruments and a thorough knowledge of the circuits involved. This receiver, being a double super-heterodyne, the alignment procedure is even more involved than is usual.

Under normal service the receiver will stay in alignment for extremely long periods of time, consequently

realignment should not be attempted unless all other possible causes of a particular trouble have been eliminated. When it has been determined that any realignment should be attempted, a great deal of caution should be exercised in making the adjustments, as any required readjustment should not entail more than a slight angular motion of the adjusting screw.

ALIGNMENT OF THE IF STAGES

The low frequency IF should be aligned first. The recommended method for aligning the low frequency IF involves the use of a sweep frequency signal generator and an oscilloscope. Since these instruments are not available at the average service station the alternate method using an amplitude modulated signal generator and an output meter will be described first. The additional information required for the visual alignment method will be covered in a later paragraph.

The signal generator should be coupled to the grid of the mixer tube V5 through a capacitance of approximately .01 mfd. A miniature tube adapter will be required to make the mixer grid connection available. Such an adapter is manufactured by the Alden Manufacturing Co. An output meter should be connected across the output terminals of the receiver or the speaker voice coil. The receiver controls should now be set as follows:

Control	Position
Selectivity	— See text
Send — Receive	— Receive
CW — Mod	— Mod
Phasing	— Arrow
AVC — Man	— Man
Audio Gain	— Set for approx. 20 volts
RF Gain	— See text
Band Switch	— 1.35 — 3.45 mc
Dial	— 2.5 mc

The signal generator should be modulated 30 percent at 400 cycles. Turn the selectivity switch to the 3 kc position and advance the RF Gain control to maximum. Set the signal generator frequency to 455 kc and adjust its output until some deflection is noted on the output meter. Refer to figure 3 for the location of the various alignment adjustments. Adjust L42, L41, L39, L38, L36 and L32 for maximum output, reducing the signal generator output and the RF Gain control as required to prevent overload or excessive output. Now turn the selectivity switch to the narrowest position, .2 kc, and adjust the signal generator frequency for the maximum output. This establishes the

correct signal frequency by the 455 kc crystal for the IF amplifier and the frequency of the signal generator should not be disturbed for the remainder of the low frequency IF alignment, unless it should be to recheck this establishment of crystal frequency to make sure that the signal generator frequency has not drifted during the alignment. The selectivity switch is now turned to the 3 kc position and L42, L41, L39, L38, L36 and L32 are again adjusted for maximum output. Now turn the selectivity switch to the 1.3 kc position and adjust L37 for maximum output. Before changing this set-up the BFO should be turned on by throwing the CW-Mod switch to CW and checked for zero beat with the BFO knob dial at its zero reading. If necessary L44 should be adjusted for zero output. This check and adjustment of the BFO should be done with the signal generator carrier unmodulated.

The procedure for the visual method of aligning the low frequency IF should be the same as the above except that the adjustments are made for both maximum amplitude and coincidence of the oscilloscope images. The oscilloscope vertical input should be connected across the diode detector load resistance, from the junction of R64 and R65 to chassis.

The high frequency IF should be aligned next. Set the band switch to the 7.4 — 14.8 mc band. The selectivity switch should be in the 3 kc position. Adjust the signal generator frequency to 3.955 mc and adjust L31, L33 and L34 for maximum output.

The 3.5 mc crystal used in the second conversion oscillator circuit is held to a very close frequency tolerance and may be used as a frequency standard at multiples of 3.5 mc from 10.5 mc upwards. In order to do this, in view of the complete shielding against radiation from this oscillator, it will be necessary to temporarily connect a two foot length of insulated wire to the antenna terminal and dress the free end of this lead around the tube shield on the 3.5 mc oscillator tube V8. This test lead should, of course, be removed except while in use as a frequency standard.

ALIGNMENT OF THE RF AMPLIFIER & HF OSCILLATOR

To adequately align the RF Amplifier and HF Oscillator an accurately calibrated signal generator and an output meter are required. The frequencies required are shown in table 3. The location of the adjustments is shown in Figure 3. The use of Table 3 and Figure 3 should be made in following this part of the alignment which will now be described for one frequency band. The same procedure should then be followed for the other frequency bands.

To align the .54-1.35 mc band the signal generator is coupled to the antenna input terminal through a 100 ohm carbon resistor. The generator should be modulated 30 percent at 400 cycles and the output meter connected across the receiver output terminals. The receiver controls should be set as follows:

Control	Position
Selectivity	— 3kc
Send-Receive	— Receive
CW—Mod	— Mod
AVC—Man	— See Text
Audio Gain	— Set for approx. 20 volts
RF Gain	— See text
Band Switch	— set for band to be aligned
Limiter	— off

Set the receiver and signal generator dials to .56 mc. The RF Gain control should be set at maximum and the AVC—Man switch set on AVC. The HF Osc. L adjustment shown in Figure 3, should now be set for maximum output. Then the Ant., 1st RF and 2nd RF L adjustments should be set for maximum output. The receiver and signal generator dials are now set to 1.3 mc and the C adjustments, shown in Figure 3, should be adjusted for maximum output in the same order, beginning with the Osc C adjustment and then making the C adjustments for the Ant, 1st RF and 2nd RF. This procedure should be carefully repeated until no increase in output can be realized. The AVC—Man switch should then be set to Man and the signal generator should be set for approximately 3 micro volts. The L and C adjustments should now be checked for maximum output, adjusting the RF Gain control as found necessary to maintain the output at approximately 20 volts.

Following the frequencies, shown in Table 3, align the remaining bands using the same procedure as above.

TABLE No. 3

RF AND HF OSCILLATOR ALIGNMENT FREQUENCIES AND ADJUSTMENT DESIGNATIONS

FREQ. BAND IN MC	.54—1.35	1.35—3.45	3.45—7.4	7.4—14.8	14.8—29.7	29.7—54.0
RF & HF OSC ADJUST L. AT.	.56	1.4	3.75	7.5	15.0	30.0
RF & HF OSC ADJUST C. AT.	1.3	3.4	7.15	14.5	29.0	52.0

TABLE No. 4

APPROXIMATE SIGNAL INPUT AT IF & AF STAGES FOR 20 VOLTS OUTPUT

Output measured across a 600 ohm resistive load at output terminals of receiver. RF signals modulated 30 percent at 400 cycles. Signals applied to tube grids through a .01 mfd capacitor. Selectivity switch at 3 kc AVC—MAN switch on MAN. CW—MOD switch on MOD, RF Gain and Audio Gain at maximum.

BAND SWITCH	FREQUENCY	INPUT TO	APPROX. INPUT
Any	Audio 400 cycles	Pin 5, V17	3.5 volts
Any	Audio 400 cycles	Pin 2, V16B	.3 volts
1.35—3.45 mc	Mod RF 455 kc	Pin 1, V11	.35 volts
1.35—3.45 mc	Mod RF 455 kc	Pin 1, V10	6000 microvolts
1.35—3.45 mc	Mod RF 455 kc	Pin 1, V9	110 microvolts
1.35—3.45 mc	Mod RF 455 kc	Pin 1, V7	40 microvolts
1.35—3.45 mc	Mod RF 455 kc	Pin 7, V5	65 microvolts
7.40—14.8 mc	Mod RF 3.955 mc	Pin 7, V5	40 microvolts
7.40—14.8 mc	Mod RF 3.955 mc	Pin 7, V6	250 microvolts

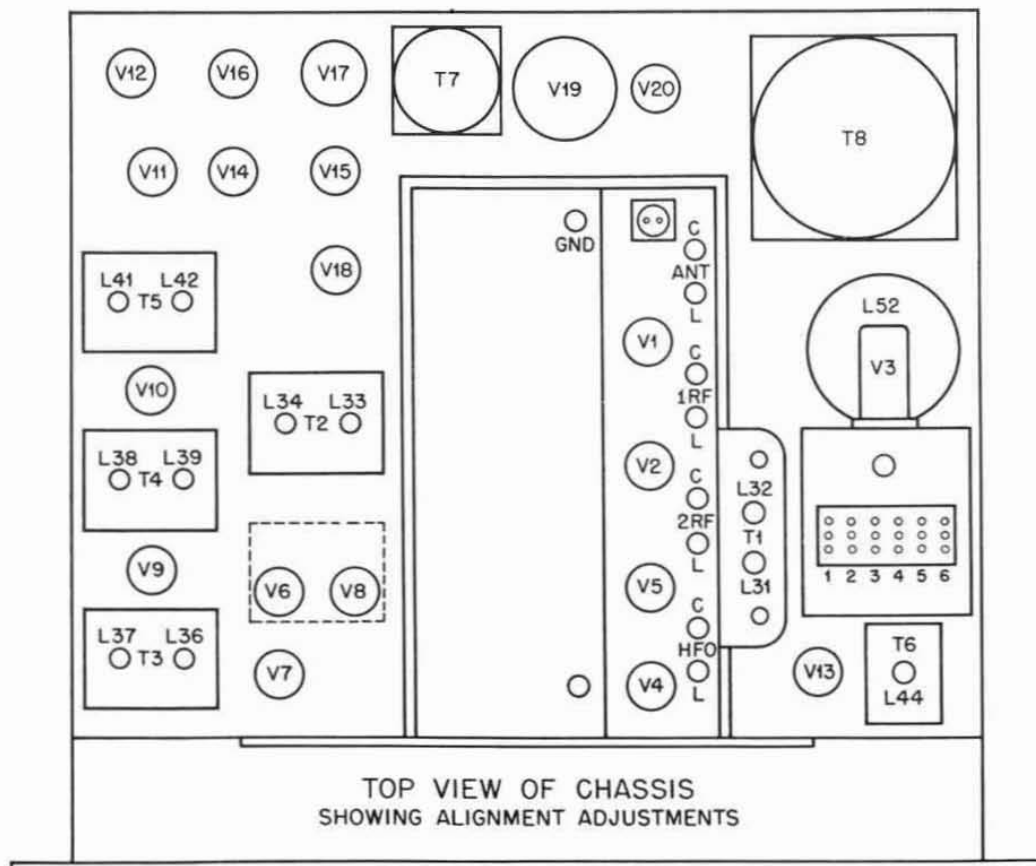

FIG. 3

• AUDIO AND OVERALL FIDELITY CURVES •

- CURVE - Audio frequency amplifier. Input to phono terminals.
 - - - - CURVE - Overall fidelity at 2.5 mc. Modulation 30 percent.
 Selectivity switch in 13 kc position.
 RF Gain set for 20 volts output at 400 cycles.
 Output measured across a 600 ohm resistive load.
 Audio gain control at maximum for both curves.

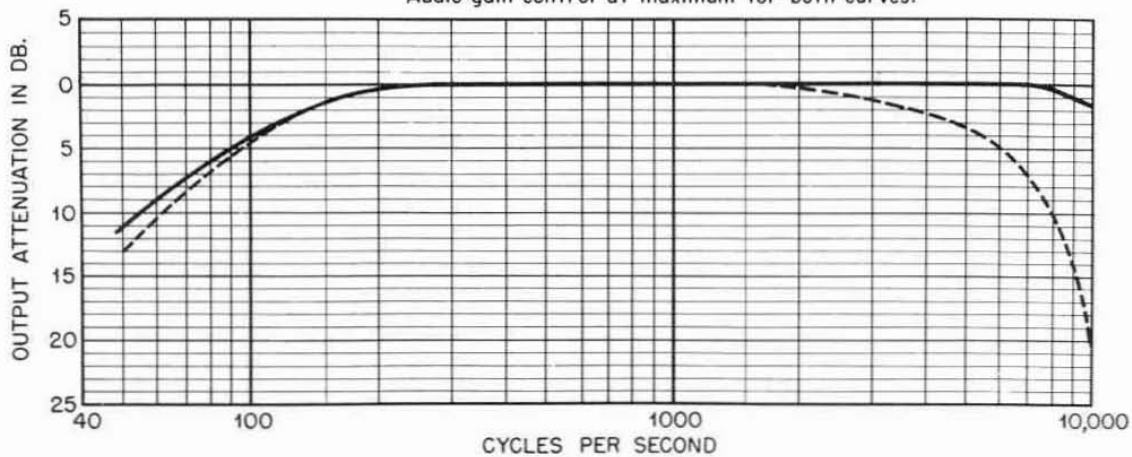

FIG. 4

• SELECTIVITY CURVES
Overall at 2 Megacycles •

NUMBERS DENOTE SELECTIVITY SWITCH POSITIONS
1,2 AND 3 NON CRYSTAL — 4,5 AND 6 CRYSTAL

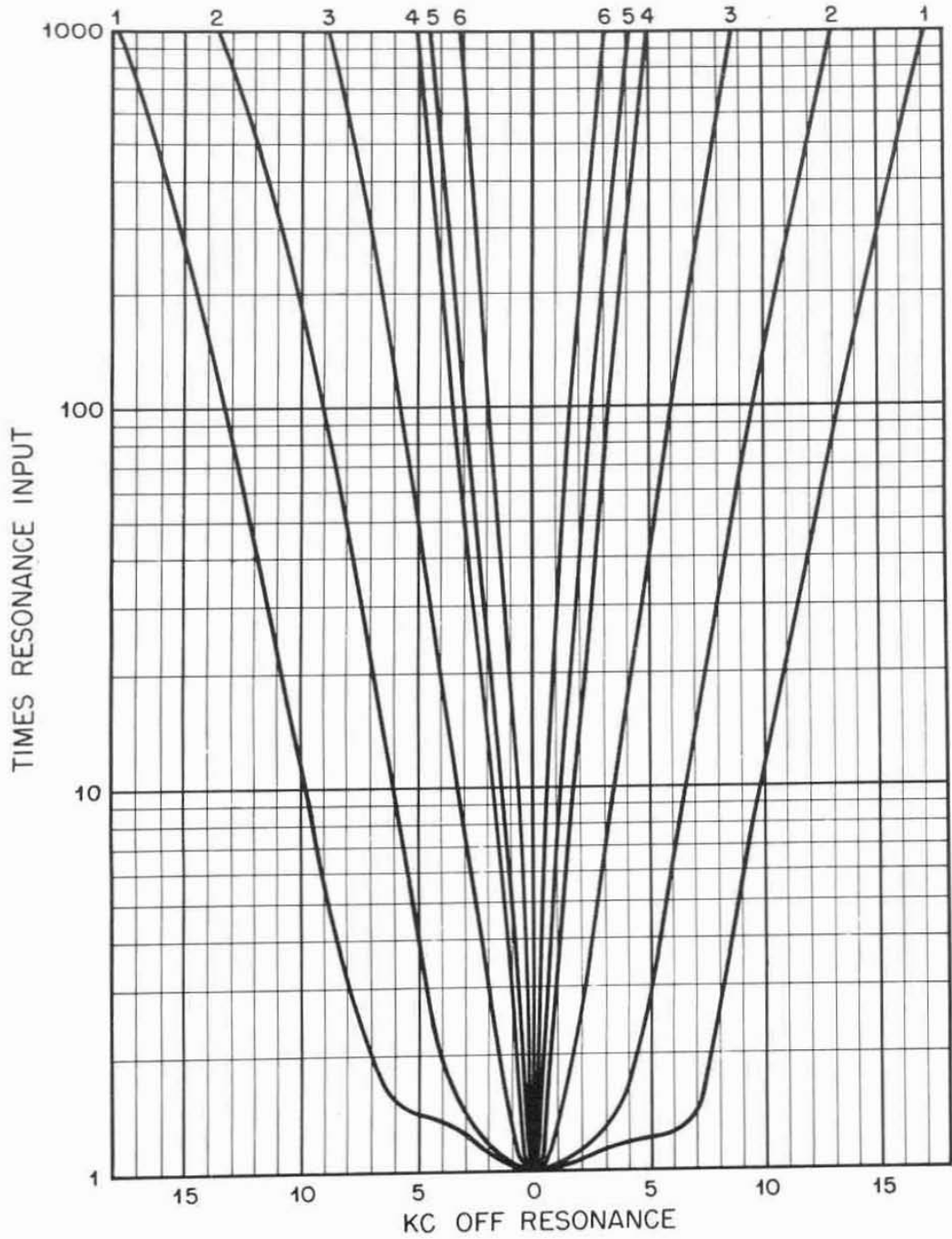

FIG. 5

VII

CONVERSION OF TABLE MODEL RECEIVER FOR RACK MOUNTING

The SP-600 Receiver is designed for either table cabinet or rack mounting. When table models are ordered, the receiver is not supplied with a bottom cover plate since the cabinet serves this purpose. When rack models are ordered the receiver is supplied with a bottom cover plate, but is not supplied with a top cover plate since in most cases the rack is of the cabinet type.

A cover plate kit is provided, on separate order, for conversion to rack mounting where table models have been ordered and where the covers are desired.

The following instructions should be followed when installing the cover kit; To install the bottom cover plate, remove the two rear corner nut plate brackets by removing the three screws at the lower rear ends of the large side mounting brackets and replace these two nut plate brackets with the two slightly shorter

ones from the kit, using the same screws. Remove the nut and lockwasher from the screw, nearest the bottom edge of the chassis, holding capacitor C151 (see bottom of chassis photograph). Install the short angle bracket, from the kit, using the same screw from which the nut and washer were removed, with the tapped (smaller end) of the bracket replacing the nut. The bottom cover plate is now installed using the five 10-32 screws from the kit and the two 10-32 screws that previously held the bottom of the receiver to the cabinet. To install the top cover plate assembly, place the cover with the angles facing downward toward the chassis and with pressure applied at the rear of the plate, to slightly compress the rubber channel against the rear of the front panel, secure the assembly in place with the four 6-32 screws from the kit, engaging them in the tapped holes in the brackets through the clearance holes in the side mounting brackets.

TABLE No. 5 PARTS LIST

Symbol Designations	DESCRIPTION	Hammarlund Part No.	Symbol Designations	DESCRIPTION	Hammarlund Part No.
C1A, B, C, D, E, F, G, H C3, 5, 19, 20, 21, 22, 23, 24, 27, 29, 40, 41, 42, 43, 44, 47, 49, 61, 64, 66, 68, 70, 71, 72, 73, 74, 100, 105, 115, 116, 121, 122, 127, 135, 153, 154, 155 C6, 30, 50 C8, 32, 52, 132 C9, 33, 53 C11, 17, 35, 55 C12, 138, 145 C14 C15, 139 C18, 25, 45, 75, 110, 112, 113 C37, 57, 67 C39, 59, 99, 134 C60, 88 C62 C63 C65 C69, 107, 117, 124 C77 C78 C79, 80 C82 C83 C85 C87 C89 C91 C92 C93 C95 C96 C97 C98, 102, 103, 104, 106, 108, 109, 118, 123, 136, 146, 148, 156, 157 C111 C114 C119, 125 C120, 126 C128, 151, 158, 159, 160 C129A, 129B, 152A, 152B C130 C131, 133 C137 C140 C141, 142 C143, 147, 149 C144 C150 C161A, B, C E1	Capacitor, variable, 8 sections Capacitor, .01 mfd..... Capacitor, 20 mmf..... Capacitor, 2400 mmf..... Capacitor, 33 mmf..... Capacitor, 1500 mmf..... Capacitor, 7 mmf..... Capacitor, 1000 mmf..... Capacitor, 15 mmf..... Capacitor, 100 mmf..... Capacitor, 85 mmf..... Capacitor, 51 mmf..... Capacitor, 12 mmf..... Capacitor, 2200 mmf..... Capacitor, 39 mmf..... Capacitor, variable..... Capacitor, 220 mmf..... Capacitor, 3300 mmf..... Capacitor, 404 mmf..... Capacitor, 5 mmf..... Capacitor, 810 mmf..... Capacitor, 10 mmf..... Capacitor, 1200 mmf..... Capacitor, 120 mmf..... Capacitor, 190 mmf..... Capacitor, 92 mmf..... Capacitor, 51 mmf..... Capacitor, 379 mmf..... Capacitor, 42 mmf..... Capacitor, 610 mmf..... Capacitor, 65 mmf..... Capacitor, .022 mfd..... Capacitor, variable..... Capacitor, 270 mmf..... Capacitor, 300 mmf..... Capacitor, 1300 mmf..... Capacitor, 10 mfd, 100V HS Can, Electrolytic..... Capacitor, 2 x .05 mfd HS Can, Paper..... Capacitor, 27 mmf..... Capacitor, 430 mmf..... Capacitor, .25 mfd 200V..... Capacitor, 1000 mmf..... Capacitor, 100 mmf..... Capacitor, 5100 mmf..... Capacitor, .05 mfd..... Capacitor, 2500 mmf 800V..... Capacitor, 3 x 20 mfd 450V, HS Can. Electrolytic..... 2 Screw Terminal, Phono Input.....	34001-G1 23012-1 23003-41C 23011-40C 23003-45C 23011-62C 23061-168F 23011-58C 23061-155J 23003-94C 23071-59 23003-87C 23023-65UJ 23011-17C 23003-47C 11726-G109 23003-102C 23011-69C 23071-67 23023-8UJ 23072-53 23003-2B 23011-60C 23071-50 23071-64 23071-71 23023-45UJ 23071-63 23071-69 23072-52 23071-58 23013-1 11776-G1 23003-104C 23003-105C 23011-61C 15462-1 15461-1 23023-71UJ 23003-109C 23911-79E 23015-27A 23024-24SL 23015-16A 23911-77E 23070-40 15463-1 4904-5	E2 E7 E5, 8 E9, 10, 11, 12 E13, 14 E15, 16 E17 E18 F1 F2 11, 2, 3, 4 J1 J2 J3 J4, 5 L1 L2 L3 L4 L5 L6 L7, 14, 24, 35 L8 L9 L10 L11 L12	4 Screw Terminal, Audio Output 2 Solder Term. strip..... 1 Solder term. str.p (left) 1 Solder term. str.p (right) 6 Solder term. strip..... 8 Solder term. strip..... 15 Solder term. strip..... 3 Solder term. strip (meter) Fuse, 3 Amp..... Fuse, 1/4 Amp Pigtail..... Fuse Holder..... Fuse Holder, Spare..... Dial Lamp, No. 47 Mazda Dial Lamp Socket Assembly..... Antenna Input Socket..... IF Output Socket..... Phone Jack..... Power or Relay receptacle..... RF Input assembly, includes C2, 3, L1 and Switch contacts for S1A..... RF Input assembly, includes C4, 5, L2 and Switch contacts for S1A..... RF Input assembly, includes C6, 7, 8, L3 and Switch contacts for S1A..... RF Input assembly, includes C9, 10, 11, L4 and Switch contacts for S1A..... RF Input assembly, includes C12, 13, 14, L5 and Switch contacts for S1A..... RF Input assembly, includes C15, 16, 17, L6 and Switch contacts for S1A..... RF Choke, 192 microhenries..... RF Transformer assembly, includes C26, 27, L8, R7 and Switch contacts for S1B..... RF Transformer assembly, includes C28, 29, L9, R8 and Switch contacts for S1B..... RF Transformer assembly, includes C30, 31, 32, L10 and Switch contacts for S1B..... RF Transformer assembly, includes C33, 34, 35, L11, R10 and Switch contacts for S1B..... RF Transformer assembly, includes C36, 37, L12 and Switch contacts for S1B.....	31141-1 16650-12 16650-9 16650-11 16650-10 31163-G1 31162-G1 31454-G1 15928-8 15889-1 15923-1 15923-4 16004-1 31453-1 15959-1 16111-1 5066-1 35013-1 31387-G1 31390-G1 31393-G1 31396-G1 31399-G1 31405-G1 15612-G1 31386-G1 31389-G1 31392-G1 31395-G1 31398-G1

PARTS LIST (Continued)

Symbol Designations	DESCRIPTION	Hammarlund Part No.	Symbol Designations	DESCRIPTION	Hammarlund Part No.
L13	RF Transformer assembly, includes C38, 39, L13 and Switch contacts for S1B	31404-G1	R1, 13, 26	Resistor 510K ohms 1/2 watt	19317-76BF
L15	Same as L8, includes C46, 47, L15, R17 and Switch contacts for S1C	31386-G1	R2, 12, 44, 52, 57, 82, 90, 91, 92, 70	Resistor 10K ohms 1/2 watt	19309-278BF
L16	Same as L9, includes C48, 49, L16, R18 and Switch contacts for S1C	31389-G1	R3, 14, 39, 48, 53	Resistor 33K ohms 1/2 watt	19309-282BF
L17	Same as L10, includes C50, 51, 52, L17, R19 and Switch contacts for S1C	31392-G1	R4, 6, 16, 29, 30, 83, 102, R5, 15, 32	Resistor 1000 ohms 1/2 watt	19309-49BF
L18	Same as L11, includes C53, 54, 55, L18, R20 and Switch contacts for S1C	31395-G1	103 to 110	Resistor 510 ohms 1/2 watt	19309-170BF
L19	Same as L12, includes C56, 57, L19 and Switch contacts for S1C	31398-G1	R7, 8, 17, 18	Resistor 51 ohms 1/2 watt	19309-193BF
L20	Same as L13, includes C58, 59, L20 and Switch contacts for S1C	31404-G1	R9, 19	Resistor 24 ohms 1/2 watt	19309-189BF
L21	RF Choke, 1 millihenry	15617-G1	R10, 11, 20, 21,	Resistor 22 ohms 1/2 watt	19309-9BF
L22	RF Choke, 10 millihenries	15618-1	R22, 23, 64, 65, 77	Resistor 47K ohms 1/2 watt	19309-89BF
L23	RF Choke, 25 millihenries	15619-1	R24, 25	Resistor 180 ohms 1/2 watt	19309-31BF
L25	HF Osc. assembly, includes C76, 77, 78, L25 and Switch contacts for S1D	31385-G1	R27	Resistor 150 ohms 1/2 watt	19309-259BF
L26	HF Osc. assembly, includes C81, 82, L26 and Switch contacts for S1D	31388-G1	R28	Resistor 6800 ohms 1/2 watt	19309-69BF
L27	HF Osc. assembly, includes C83, 84, 85, L27 and Switch contacts for S1D	31391-G1	R31, 37, 41, 49, 54, 58, 80	Resistor 2200 ohms 1/2 watt	19309-57BF
L28	HF Osc. assembly, includes C86, 87, 88, 89, L28 and Switch contacts for S1D	31394-G1	R33	Resistor 1500 ohms 1/2 watt	19309-53BF
L29	HF Osc. assembly includes C90, 91, 92, 93, L29 and Switch contacts for S1D	31397-G1	R34, 35, 38, 43, 51, 56, 62, 67, 68, 75, 76, 81, 100	Resistor 100K ohms 1/2 watt	19309-97BF
L30	HF Osc. assembly, includes C94, 95, 96, L30, and Switch contacts for S1D	31403-G1	R36, 96	Resistor 22K ohms 1/2 watt	19309-178BF
L47	RF Choke, 3.8 millihenries	15616-G1	R40	Resistor 20K ohms 1 watt	19310-179BF
L48	RF Choke, 2 ohms dc	15611-1	R42, 50, 55	Resistor 10 ohms 1/2 watt	19309-1BF
L49, 50	RF Choke, 2.7 ohms dc	15613-1	R45	Resistor, 240 ohms 1/2 watt	19309-201BF
L51	1st Filter Choke 8.5 Hy, 170 ohms dc	31030-2	R46, 94	Resistor, 1100 ohms 1/2 watt	19309-208BF
L52	2nd Filter Choke 20 Hy, 440 ohms dc	31031-2	R47, 66	Resistor 18K ohms 1/2 watt	19309-79BF
L53	IF Output Transformer	31488-1	R59	Resistor 2200 ohms 1 watt	19310-57BF
M1	Tuning Meter	4903-2	R60, 61	Resistor 1 megohm 1/2 watt	19309-121BF
P1	Power plug and cord	6143-1	R63	Resistor 27K ohms 1/2 watt	19309-83BF
P2	Antenna Input Plug	16016-1	R69, 74	Resistor variable 1000 ohms	15363-1
P3	Antenna Adapter Connector	15987-1	R72	Resistor 20K ohms 1/2 watt	19309-218BF
P4	Cable Connector Plug (for J2)	16071-1	R73	Resistor 56K ohms 1 watt	19310-186BF
			R78, 98	Resistor 470K ohms 1/2 watt	19309-113BF
			R79	Resistor 680 ohms 1/2 watt	19309-45BF
			R84	Resistor variable 500K ohms	15342-11
			R85	Resistor 2500 ohm 10 watts	19396-1
			R86, 89, 95	Resistor 82K ohms 1/2 watt	19309-287BF
			R87, 88	Resistor 120K ohms 1/2 watt	19309-181BF
			R93	Resistor variable 50K ohms includes switch S10	15342-21

PARTS LIST (Continued)

Symbol Designations	DESCRIPTION	Hammarlund Part No.	Symbol Designations	DESCRIPTION	Hammarlund Part No.
R97	Resistor 3.3 megohms 1/2 watt	19309-133BF	X4	Tube socket, miniature, ceramic, less center shield	15989-5
R99	Resistor 360 ohms 1 watt	19310-211BF	X5	Tube socket, miniature, ceramic, with center shield	15989-3
R101	Resistor variable 25K ohms	15342-4	X16	Tube socket, "Noval"	16100-1
S1A, B, C, D	Switch, base and spring assembly	31234-G1	X21	Crystal socket, ceramic, for crystals Y1 to Y6	16092-5
S2	Crystal selector switch	15879-1	Y1, 2, 3, 4, 5, 6	Crystal, order special, specify signal fre- quency	31473-spec.
S3	Crystal switch	31469-1	Y7	Crystal, 3.5mc	31130-1
S4	Switch, conversion switching	15862-1	Y8	Crystal, 455kc	31471-1
S5A, B, C	Selectivity switch, 3 sec- tion	15856-1	Miscellaneous	Wrench, set screw No. 6	11806-2
S6, 9	Toggle Switch SPST	15864-1		Wrench, set screw No. 8	11806-3
S7	Toggle Switch DPST	15866-1		Wrench, set screw No. 10	11806-4
S8	Toggle Switch DPDT	15867-1		Snap Button Plug	29619-2
S10	Switch "ON-OFF" part of R93	—		Shaft Coupling, rigid	31275-G1
S11	Switch, DPDT, spring return	15880-1		Shaft Coupling, flexible, soft	415-G3
T1	Mixer plate coil assem- bly, includes C67, 69, 70, L31, 32, R31	31183-G1		Shaft Coupling, flexible, stiff	415-G2
T2	IF Transformer assem- bly, includes C97, 98, 99, L33, 34, R35	31116-G1		Spring, retainer for RF coil assemblies	31003-1
T3	Crystal Filter assembly, includes C107, 110, 111, 112, 113, 114, L36, 37, R41, Y8	31114-G1		Spring, retainer for RF coil	31004-1
T4	IF Transformer, includes C117, 118, 119, 120, L38, 39, 40, R49	31102-G1		Spring, grounding for IF transformer shields	31023-1
T5	Same as T4, includes C123, 124, 125, 126, L41, 42, 43, R54	31102-G1		Spring, conversion switch	31125-1
T6	Beat Frequency Osc. assy., includes C130, 131, 132, 133, 134, L44, 45, 46, R76, 77	31106-G1		Spring, indicator slide	31126-1
T7	Transformer, Audio Output	31086-2		Spring, band change detent	31205-1
T8	Transformer, Power	31029-2		Knob, frequency control	31434-G1
X1, 2, 6, 7, 8, 9, 10, 11, 12, 13, 14, 15, 18, 20	Tube socket, miniature.	15989-4		Knob, tuning lock	31462-G1
X3 17, 19	Tube socket, octal	16082-1		Knob & Skirt (large)	31215-G1
				Knob & Dial (RF Gain)	31227-G1
				Knob & Dial (Audio Gain)	31227-G2
				Knob & Dial (Crystal Phasing)	31227-G3
				Knob & Dial (Beat Freq. Osc.)	31227-G4
				Knob & Dial (Selectivity)	31227-G5
				Chart, frequency control	31463-1
				Spring, anti-backlash	31239-1

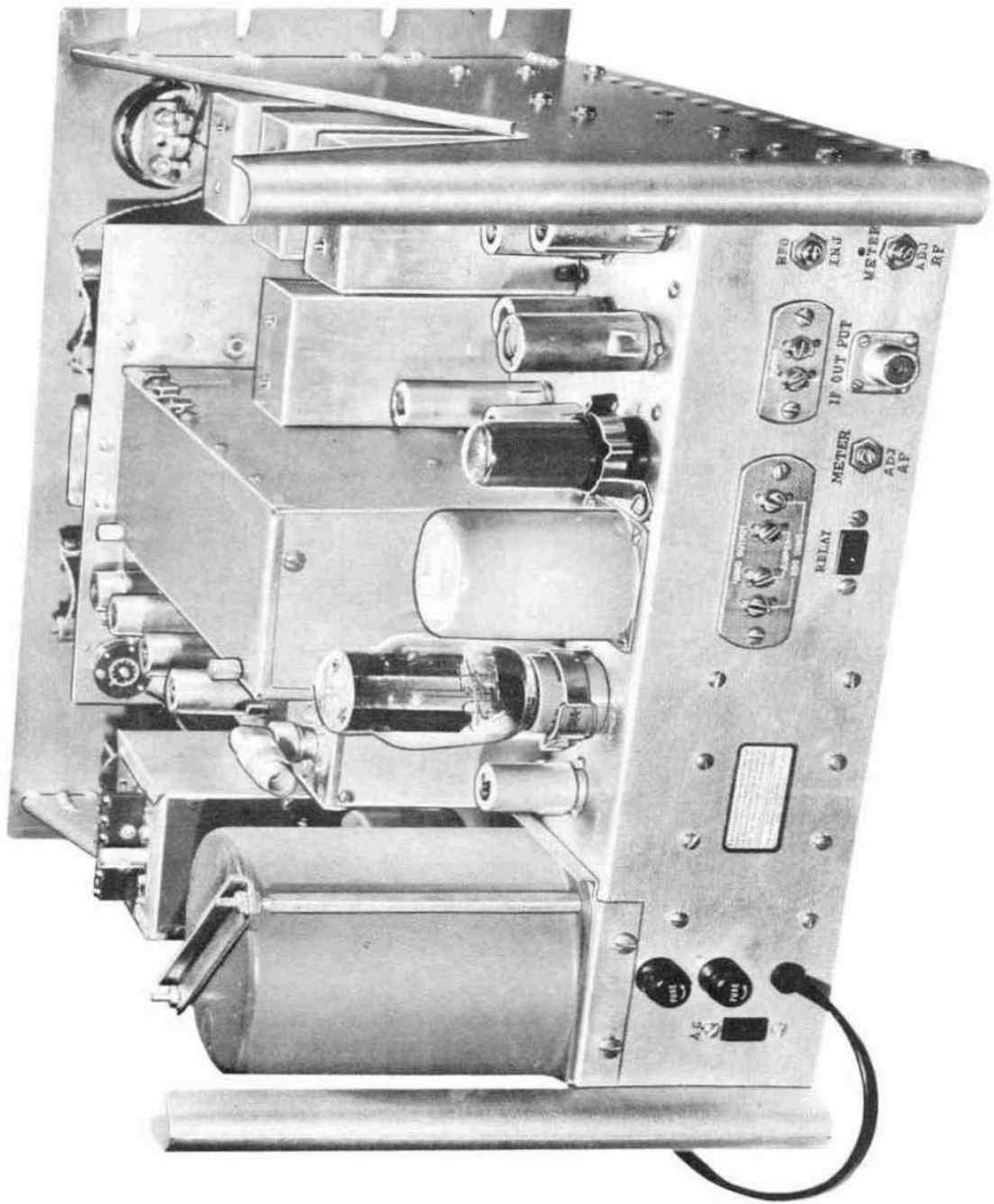

FIG. 6
REAR VIEW OF RECEIVER

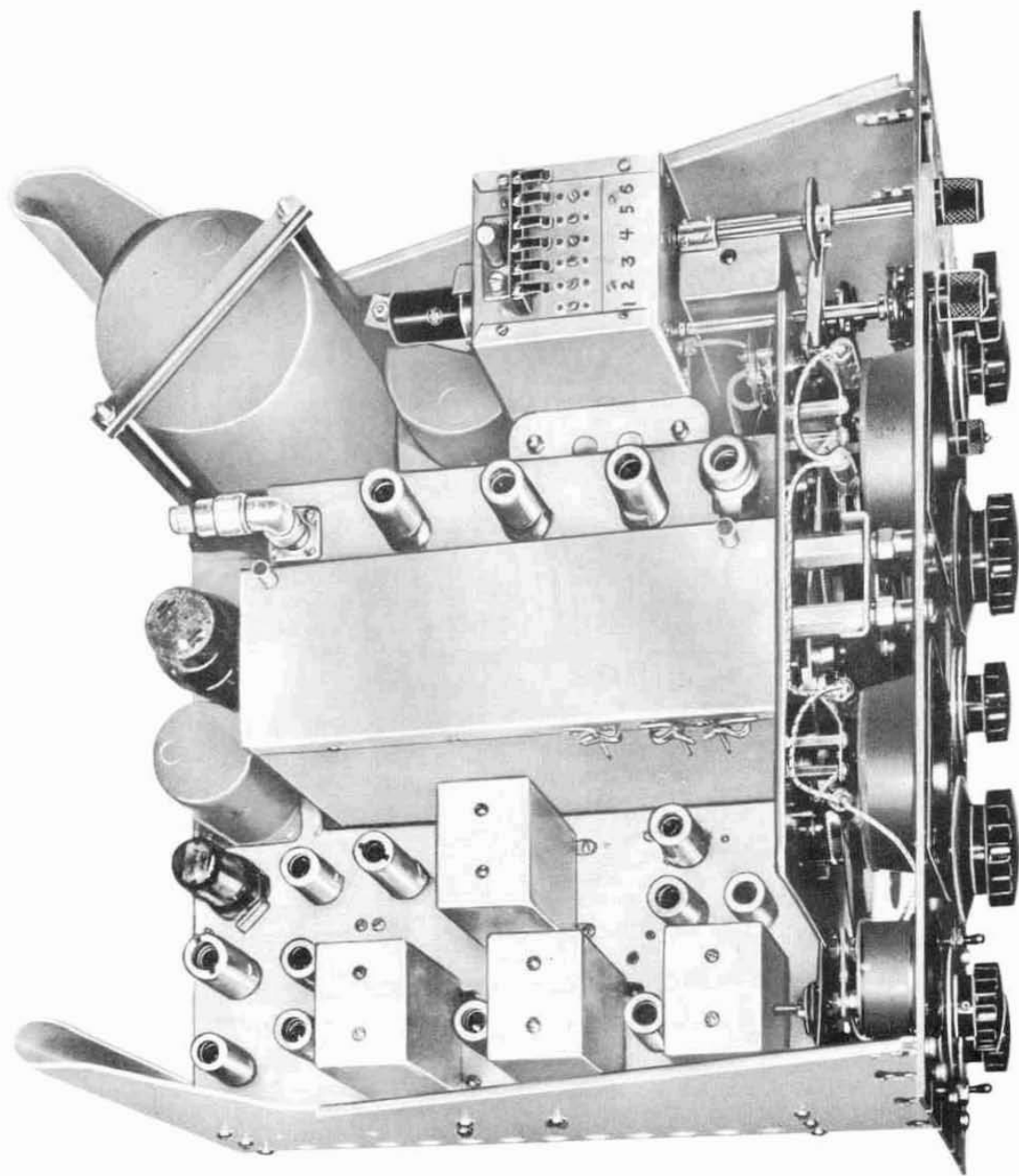

FIG. 7
TOP VIEW OF RECEIVER

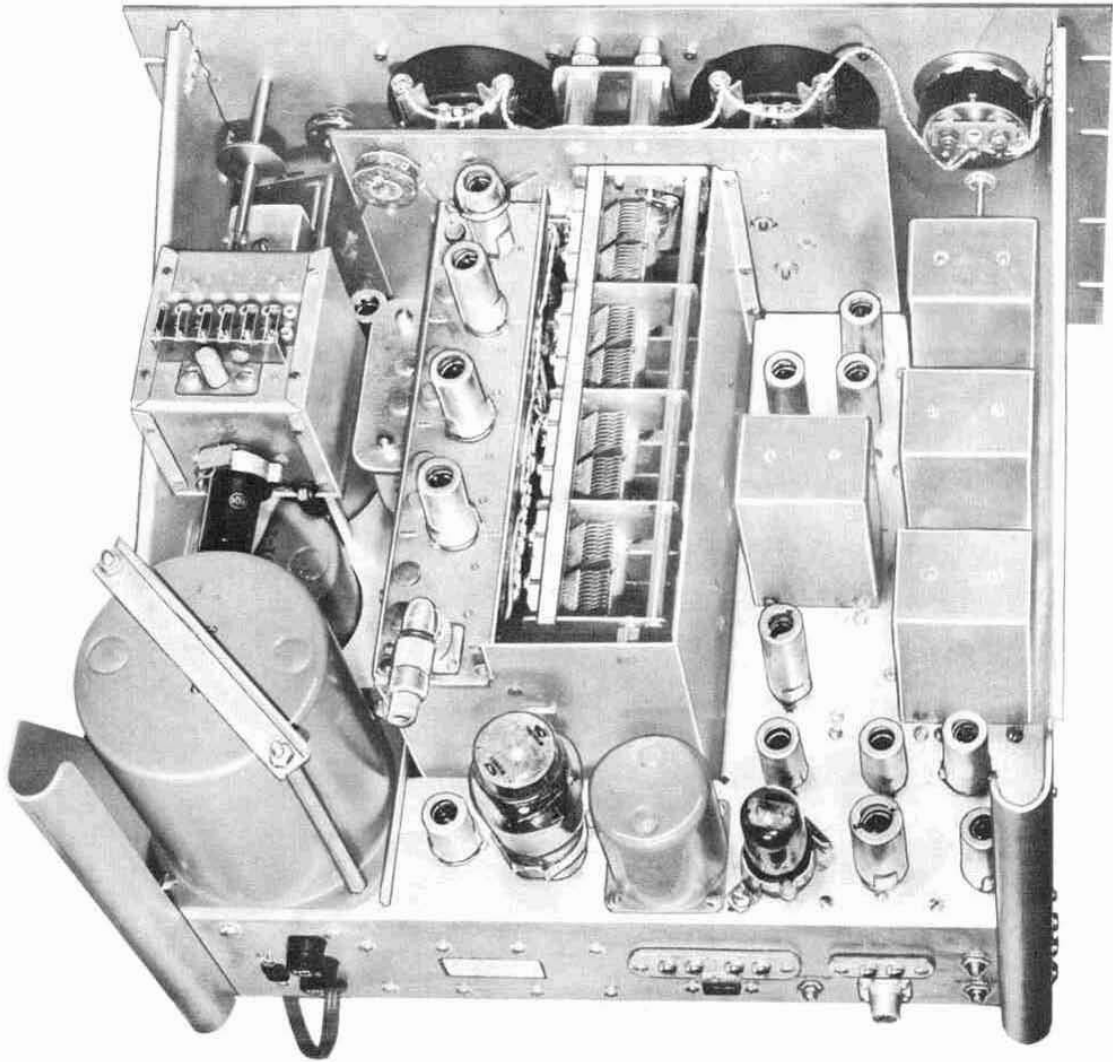

FIG. 8
TOP VIEW OF RECEIVER
CAPACITOR SHIELD REMOVED

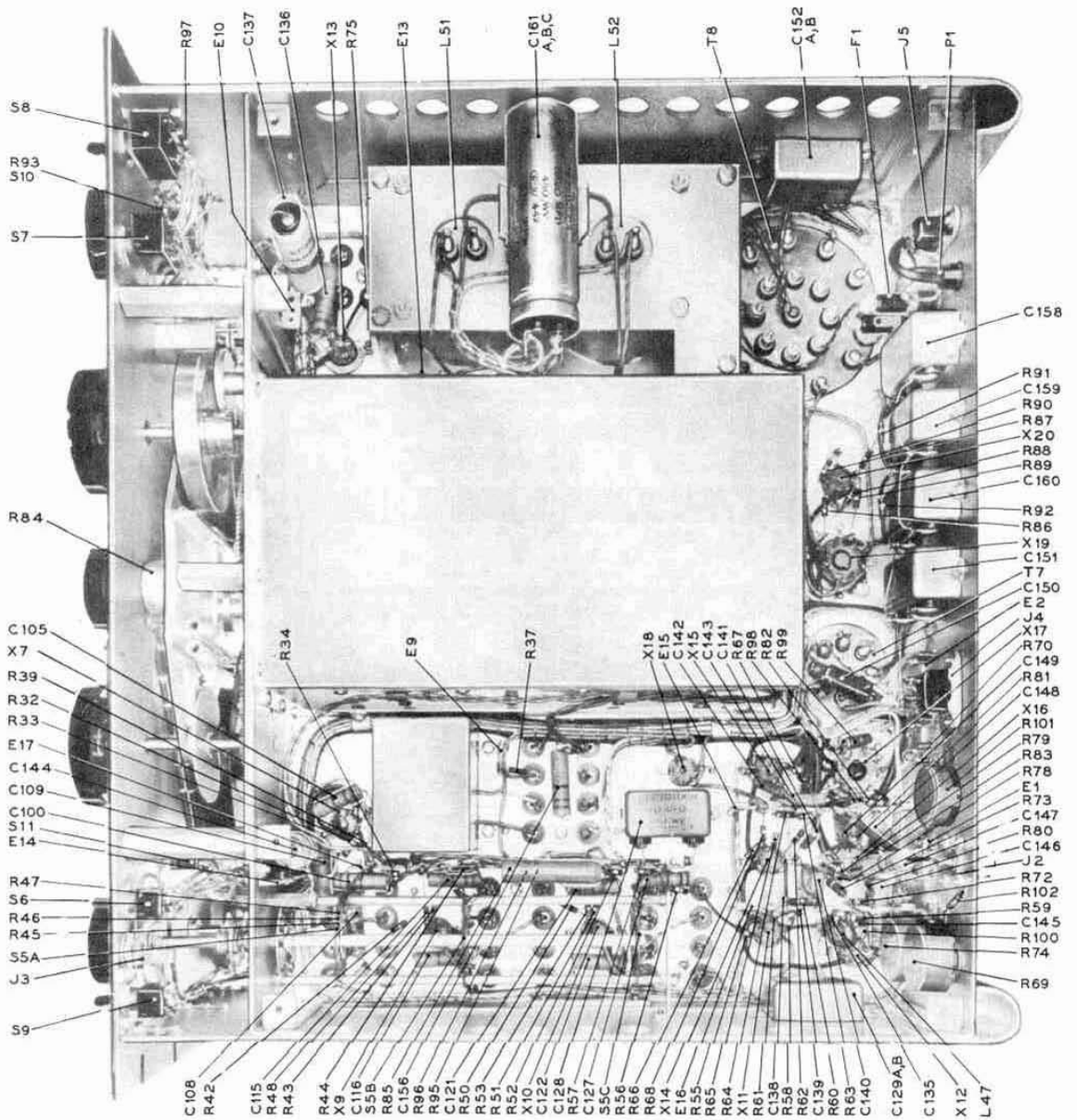

FIG. 9
BOTTOM VIEW OF RECEIVER SP-600-JX

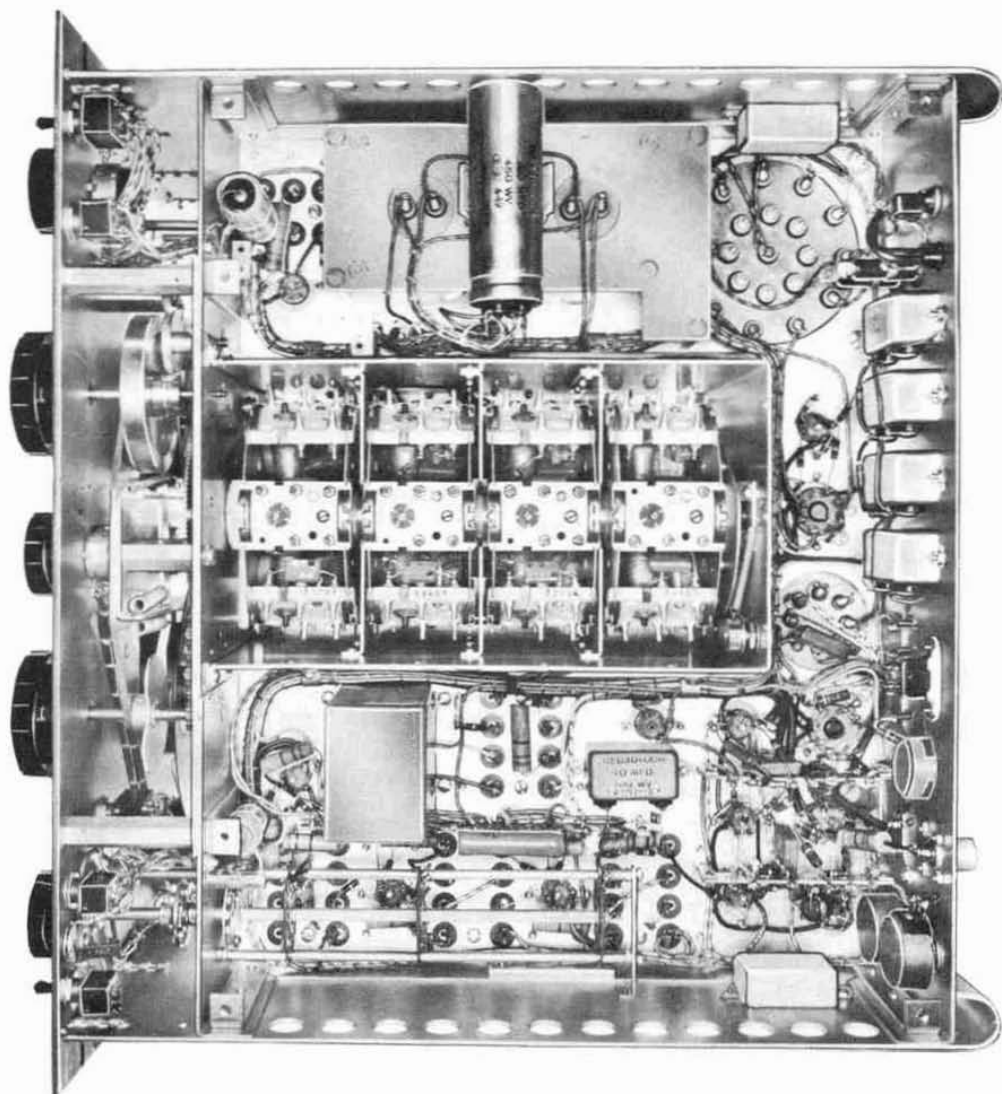
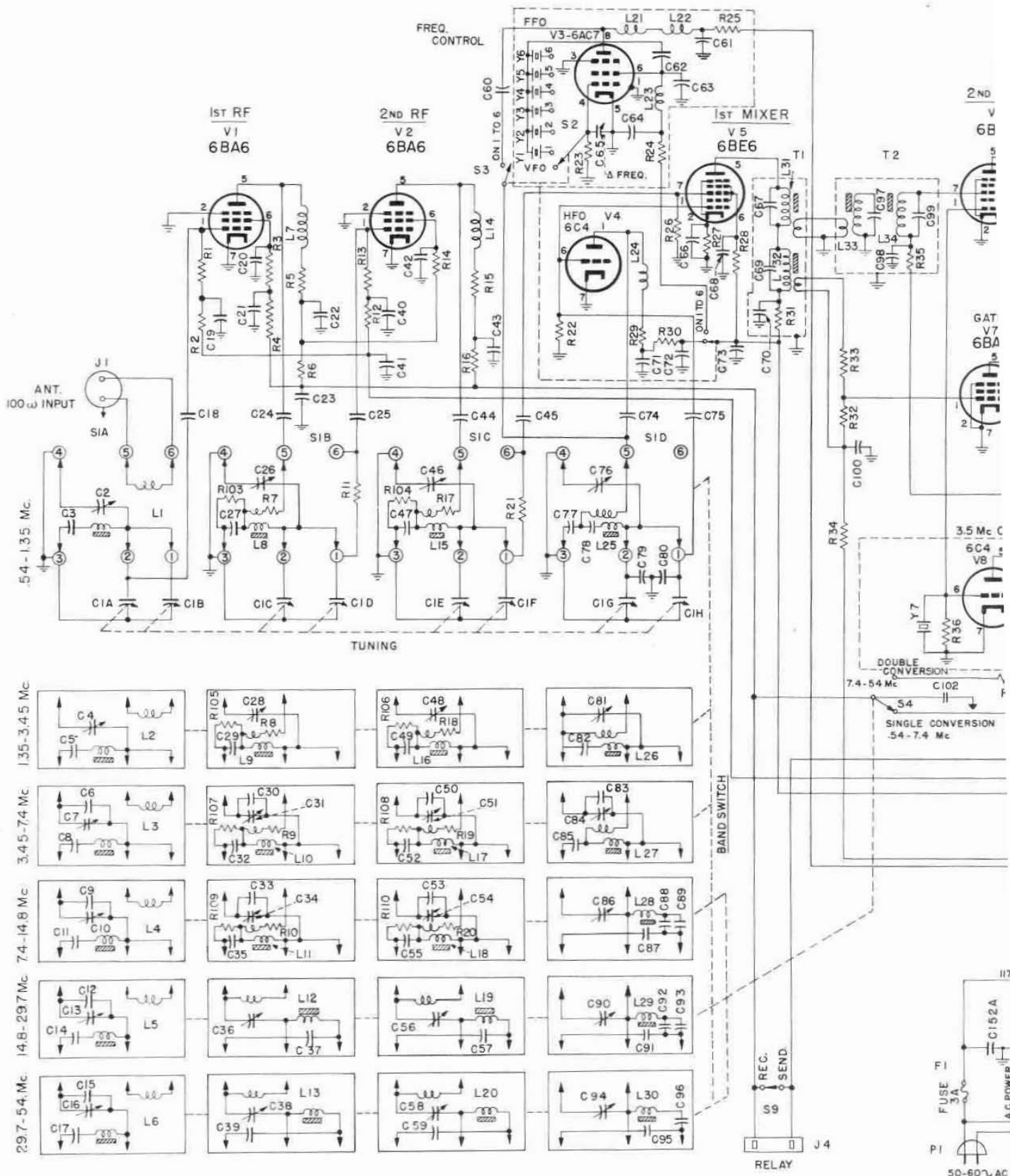

FIG. 10
BOTTOM VIEW OF RECEIVER
TUNING UNIT SHIELD REMOVED



29.7-54 Mc
4.8-29.7 Mc
7.4-14.8 Mc
3.45-7.4 Mc
1.35-3.45 Mc

2ND V 6B
3.5 Mc C 6C4 V8
7.4-54 Mc
50-60 AC

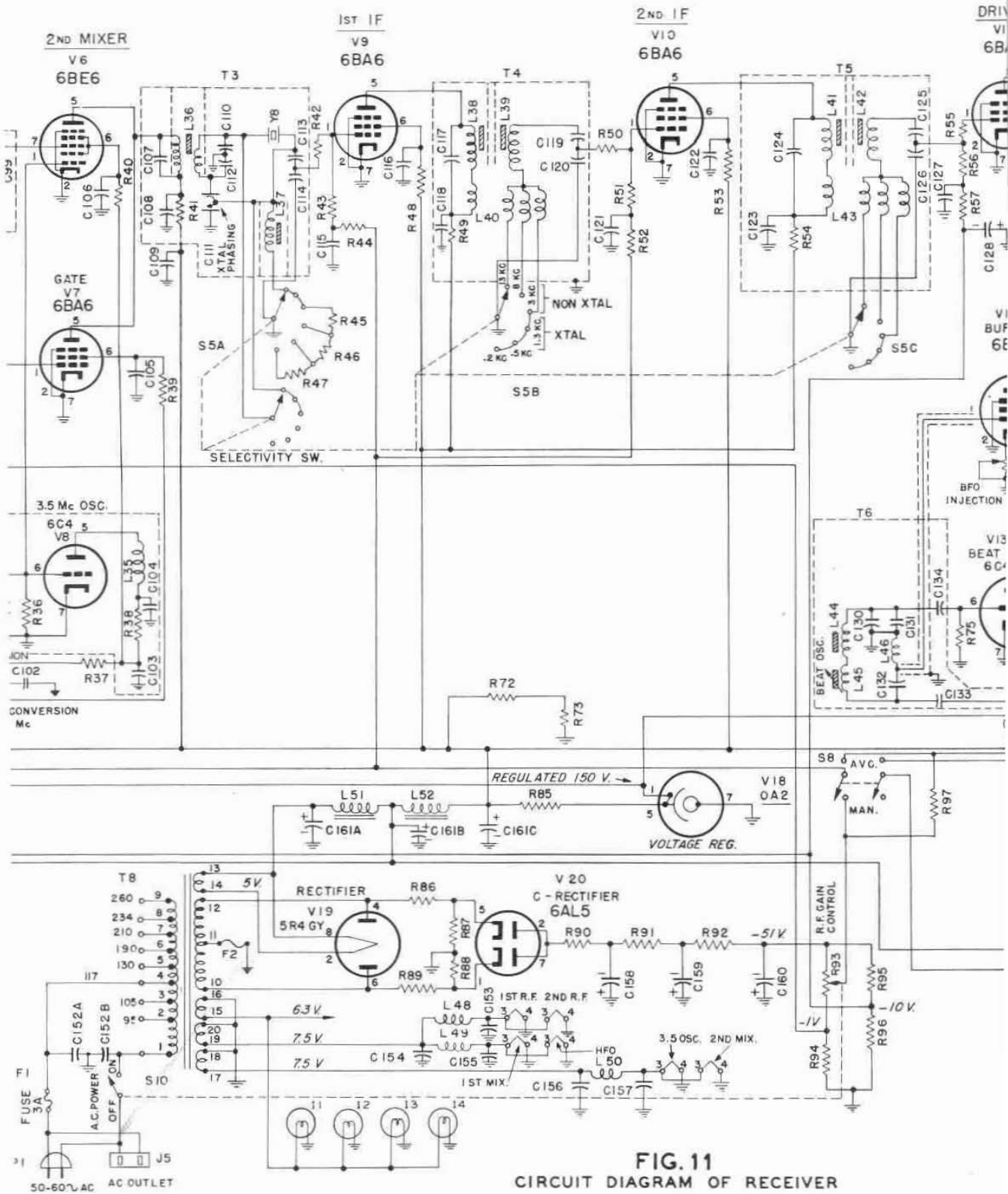

FIG. 11
CIRCUIT DIAGRAM OF RECEIVER

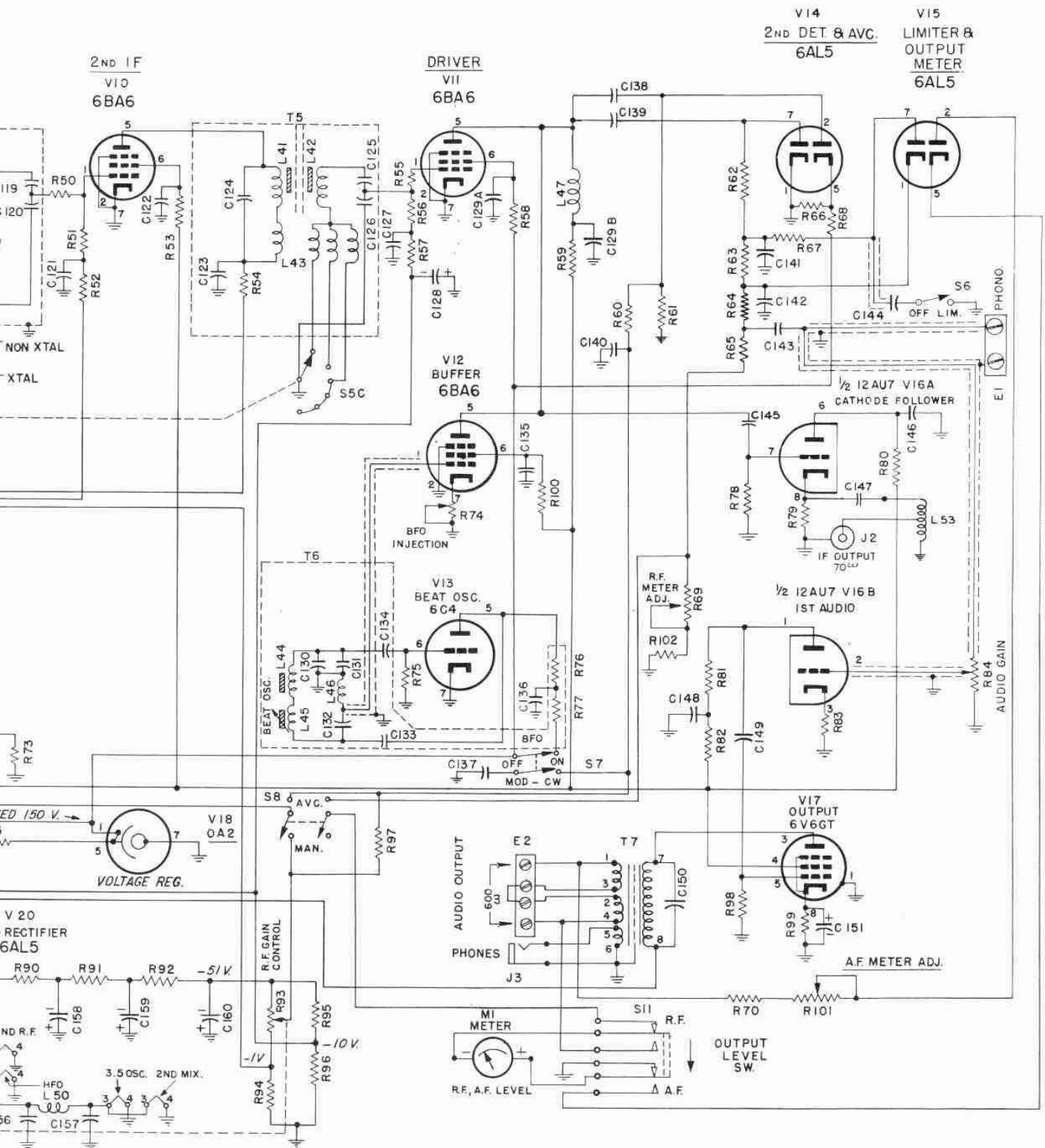
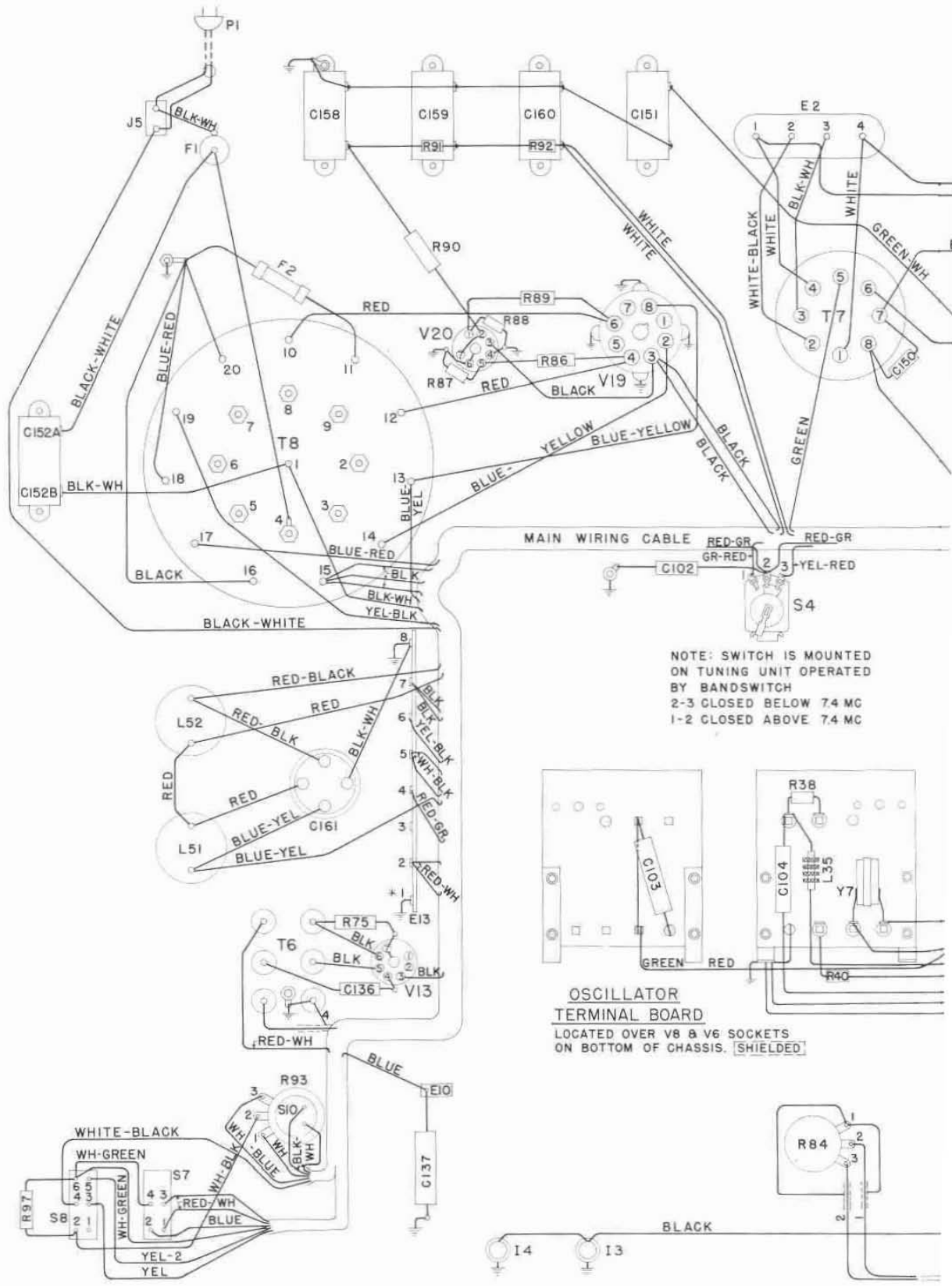
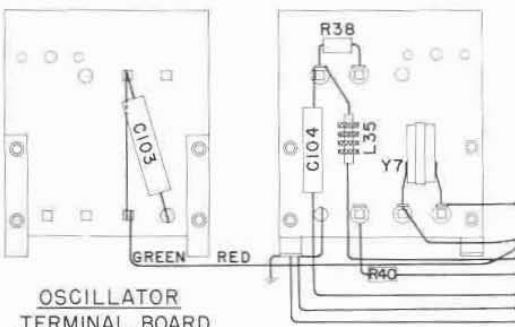

FIG. 11
CIRCUIT DIAGRAM OF RECEIVER



NOTE: SWITCH IS MOUNTED ON TUNING UNIT OPERATED BY BANDSWITCH
 2-3 CLOSED BELOW 7.4 MC
 1-2 CLOSED ABOVE 7.4 MC



OSCILLATOR TERMINAL BOARD
 LOCATED OVER V8 & V6 SOCKETS ON BOTTOM OF CHASSIS. [SHIELDED]

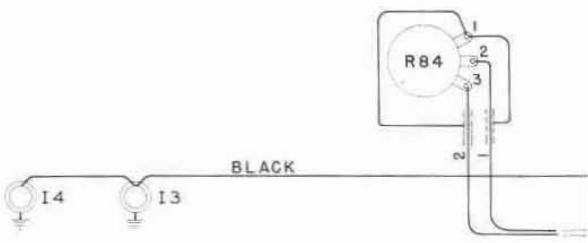

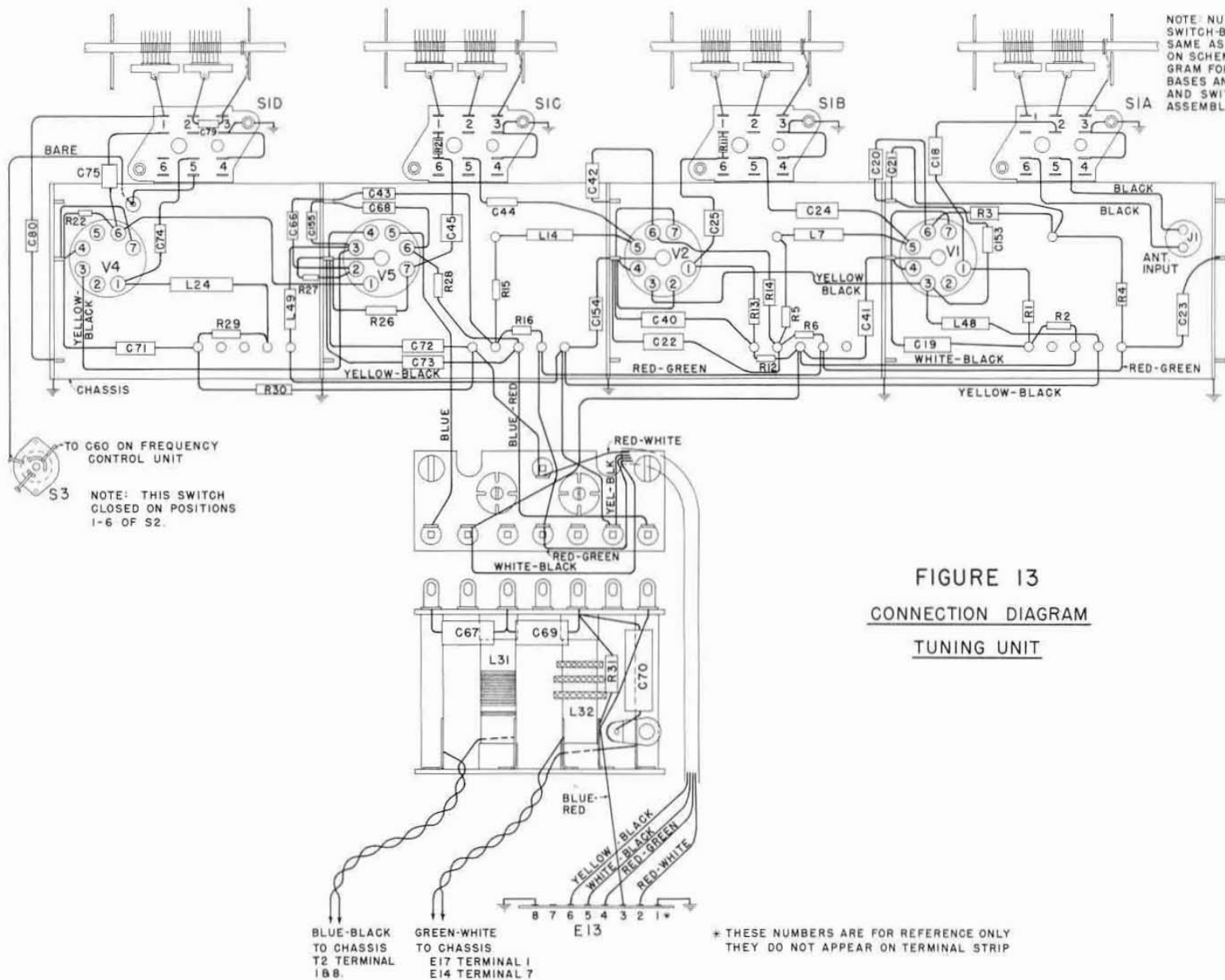

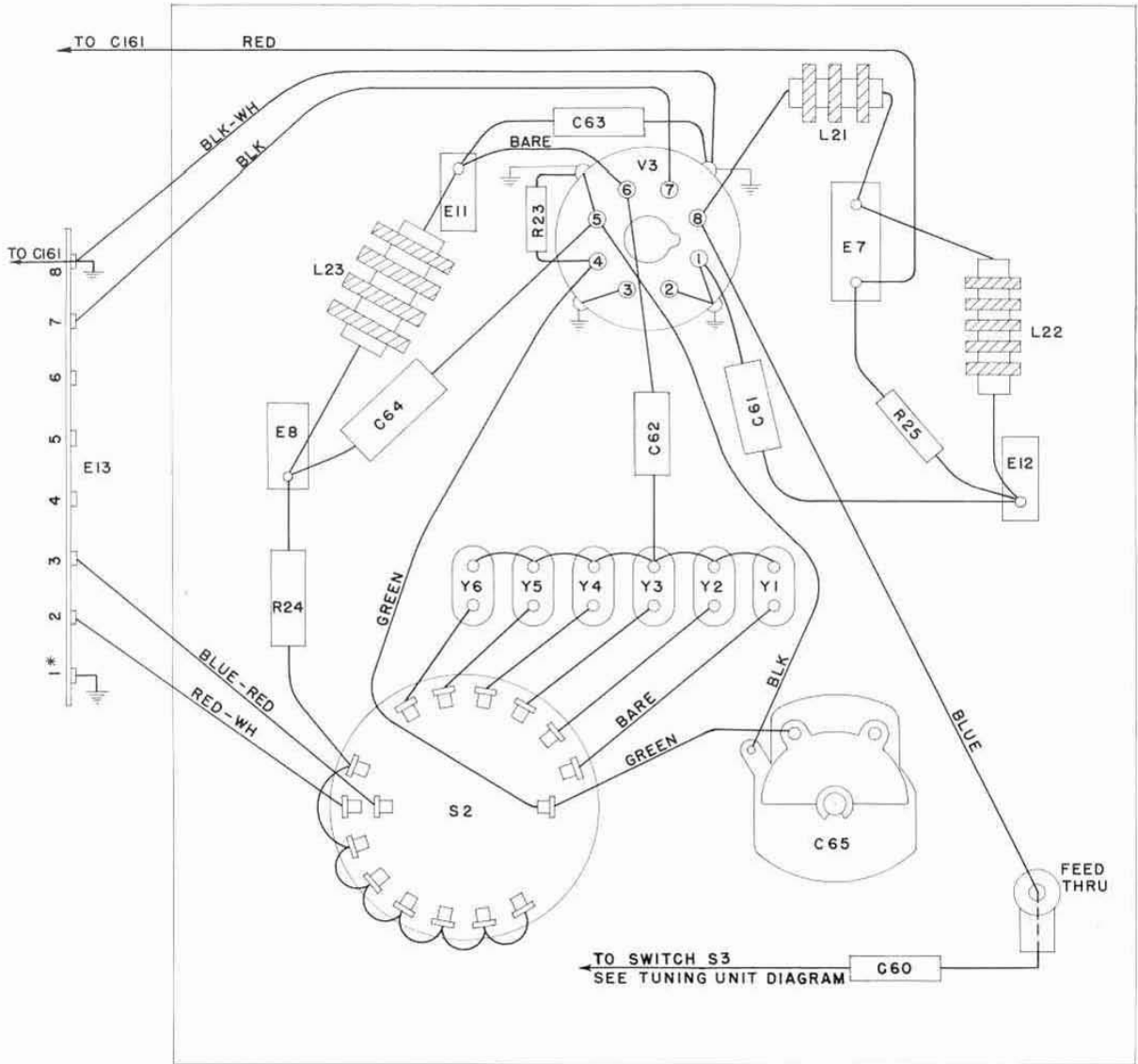

* THESE NUMBERS ARE FOR REFERENCE ONLY.
 THEY DO NOT APPEAR ON TERMINAL STRIP.

FIGURE 14
CONNECTION DIAGRAM
FREQUENCY CONTROL UNIT

Notes

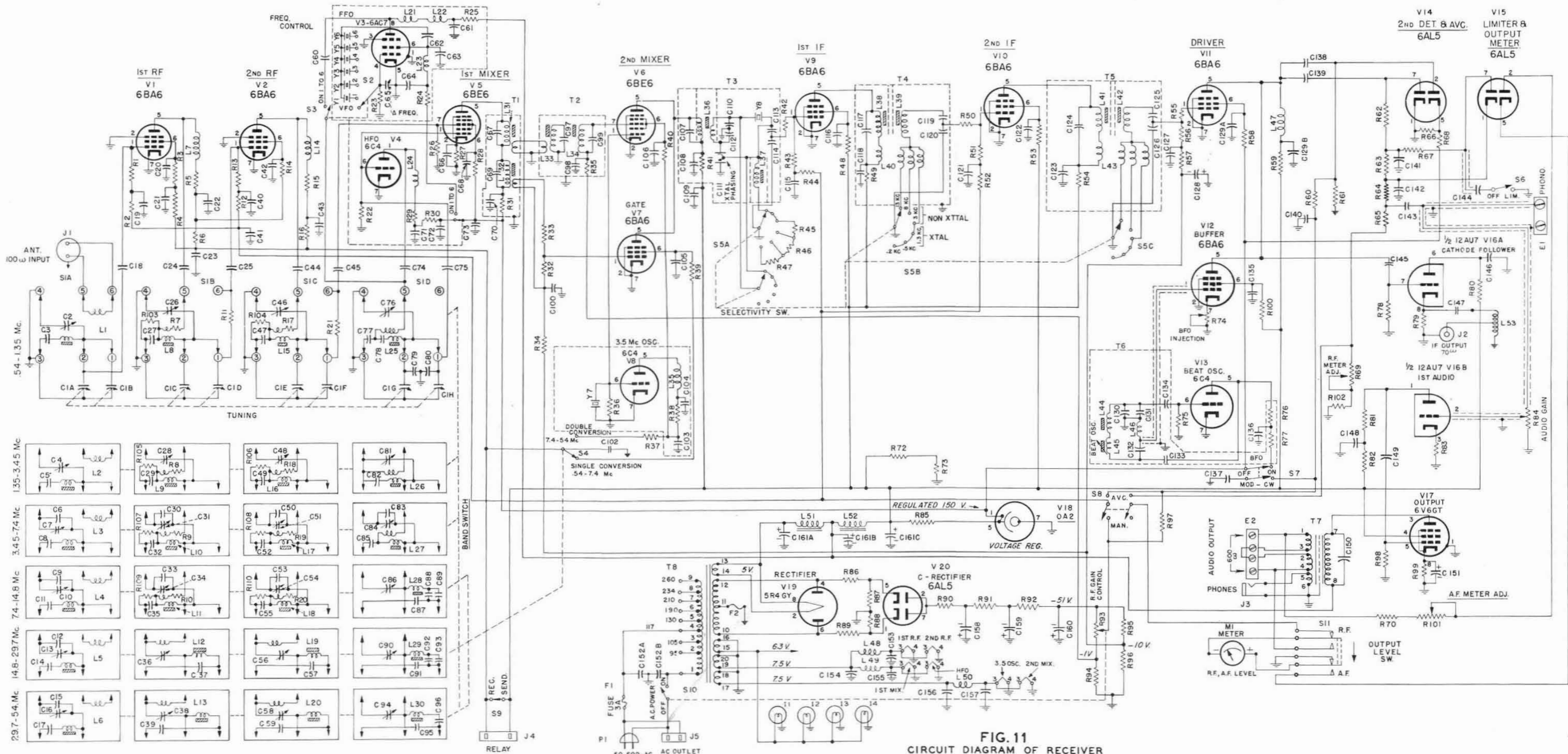

FIG. 11
CIRCUIT DIAGRAM OF RECEIVER

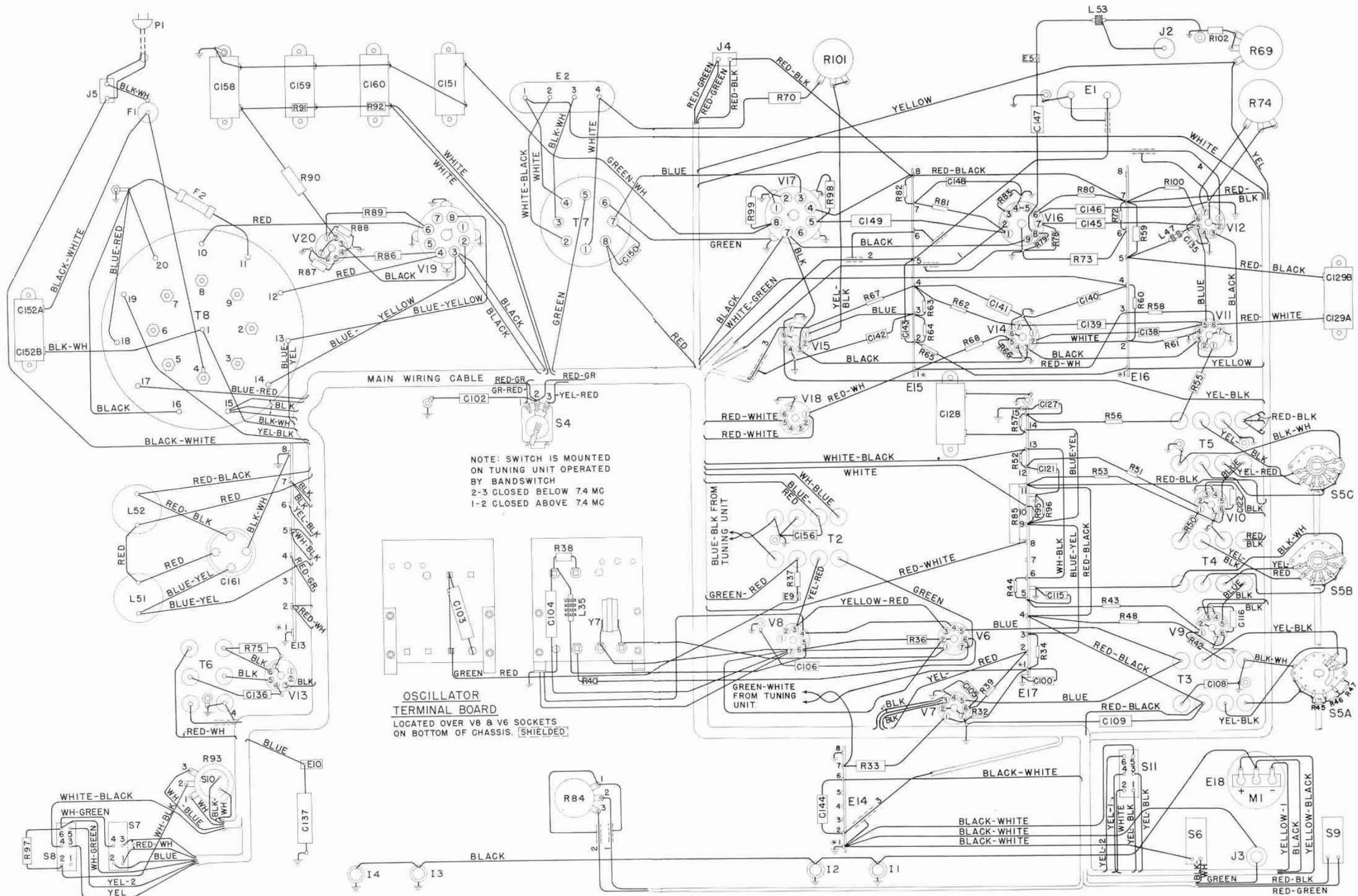

FIGURE NUMBER 12
CONNECTION DIAGRAM-RECEIVER CHASSIS

* THESE NUMBERS ARE FOR REFERENCE ONLY. THEY DO NOT APPEAR ON TERMINAL STRIP.