

Declassified

UNCLASSIFIED
AUTHORITY
DATE 12-17-83
BY

INSTRUCTION BOOK

FOR

MODELS RBG, RBG-1 AND RBG-2

RADIO RECEIVING EQUIPMENTS

FREQUENCY RANGE .54 TO 31.0 MEGACYCLES

SUPPLY 115 VOLTS

NAVSHIPS 900,004—IB

**MODELS RBG AND RBG-2
60 CYCLES ONE PHASE**

**MODEL RBG-1
25 CYCLES ONE PHASE**

**NAVY DEPARTMENT
BUREAU OF SHIPS**

**CONTRACTOR
GENERAL ELECTRIC SUPPLY CORP.
WASHINGTON, D. C.**

MANUFACTURED BY

HAMMARLUND MFG. CO., INC.

NEW YORK, N. Y.

**CONTRACT NOs 87147
CONTRACT NXss 20831**

**CONTRACT DATE, JUNE 14, 1941
CONTRACT DATE, JAN. 5, 1943**

Technical Library
Code 2264
AIM - USN, Seattle
BUCKET SOUND

RESTRICTED

This instruction book is furnished for the information of commissioned, warrant, enlisted and civilian personnel of the Navy whose duties involve design, instruction, operation and installation of radio and sound equipment. The word "RESTRICTED" as applied to this instruction book signifies that this instruction book is to be read only by the above personnel, and that the contents of it should not be made known to persons not connected with the Navy.

NOTICE

The Models RBG, RBG-1 and RBG-2 Radio Receiving Equipments covered by this instruction book are identical with the single exception that the Type CHC-46163 Radio Receiver unit, which is designed for operation from a 25 cycle power source, is supplied with the Model RBG-1 equipment. The Type CHC-46140 Radio Receiver unit, designed for operation from a 50-60 cycle power source, is supplied with both Model RBG and Model RBG-2 Radio Receiving Equipments.

All references throughout this instruction book to Model RBG equipment and to Type CHC-46140 Radio Receiver apply equally to all models with this single exception unless otherwise specifically stated.

CONTRACTUAL GUARANTEE

Applicable only to Model RBG, Contract NOs 87147 dated June 14th, 1941 and Contract NXss 20831 dated Jan. 5, 1943.

The equipment, including all parts and spare parts, except vacuum tubes, shall be guaranteed for a service period of *one year* with the understanding that, as a condition of this contract, all items found to be defective as to design, material, workmanship or manufacture shall be replaced without delay and at no expense to the Government, provided that such guarantee and agreement shall not obligate the contractor to make replacement of defective material unless the failure, exclusive of normal shelf life deterioration, occurs within a period of two years from the date of delivery of the equipment to and acceptance by the Government, and provided further, that if any part or parts (except vacuum tubes) fail in service or are found defective in ten per cent (10%) or more of the total number of equipments furnished under the contract, such part or parts, whether supplied in the equipment or as spares, shall be conclusively presumed to be of defective design, and as a condition of contract subject to one hundred per cent (100%) replacement of all similar units supplied on subject contract by suitable redesigned replacements. Failure due to poor workmanship while not necessarily indicating poor design, will be considered in the same category as failure due to poor design. Redesigned replacements which will assure proper operation of the equipment shall be supplied promptly, transportation paid, to the Naval activities using such equipment, upon receipt of proper notice and without cost to the Government. All defective parts originally furnished under contract shall be held subject to rejection and return to the contractor.

This period of two years and the service period of one year shall not include any portion of the time that the equipment fails to give satisfactory performance due to defective items and the necessity for replacement thereof, and provided further, that any replacement part shall be guaranteed to give one year of satisfactory service.

REPORT OF FAILURE

Report of failure of any part of this equipment, during its service life, shall be made to the Bureau of Ships in accordance with current instructions. The report shall cover all details of the failure and give the date of installation of the equipment. Refer to latest revision of Bureau of Engineering Circular Letter No. 40 for instructions concerning Report of Failures, etc.

**PERTINENT DATES AFFECTING REPLACEMENTS UNDER
THE GUARANTEE**

Contract NOs 87147	Date of Contract 14th, June, 1941
Contract NX _{ss} 20831	Date of Contract 5th, Jan., 1943
Serial number of Equipment.....	
Date of acceptance by the Navy.....	
Date of delivery to contract destination.....	
Date of completion of installation.....	
Date placed in service.....	

Blank spaces in the book shall be filled in at time of installation. Operating personnel shall also mark the "date placed in service" on the acceptance date plate located on the rear skirt of receiver chassis.

RBG RADIO RECEIVING EQUIPMENT

Use.—General service.

Frequency range.—0.54 mc. to 31.0 mc.

Power required for operation.—115/1/50-60, 60 watts.

Description.—The circuit employed comprises one stage of radio frequency amplification, first detector and high frequency oscillator, three stages of intermediate frequency amplification operating at 455 kilocycles, second detector, first audio amplifier and a power-output stage. A beat-frequency oscillator is coupled to the second detector to provide for CW code reception. A full-wave high-vacuum rectifier furnishes plate voltage and a voltage regulator tube is used to stabilize the HF oscillator supply.

A crystal filter, the use of which is optional, is included and provides adjustable selectivity for the reception of signals where the normal noncrystal selectivity of the receiver is insufficient for rejection of closely adjacent interfering signals.

One section of the duplex diode operates as second detector and also provides automatic volume control for the radio frequency amplifier and the first and second intermediate frequency amplifiers. The other diode section is utilized in a limiter circuit which is useful in the reduction of ignition and similar pulse types of interference. The use of the limiter is optional and is controlled by a switch on the front panel.

A tuning meter is provided which indicates relative signal strength, when the receiver is operated on AVC and the sensitivity control is set at maximum. This meter operates on either AVC or manual control as a tuning indicator, the meter reading is maximum at correct tuning of the signal.

The antenna compensator control on the front panel provides correct alignment of the radio-frequency amplifier stage for maximum sensitivity, image rejection, and signal to noise ratio.

Two audio output circuits are provided; a phone jack mounted on the front panel is connected to a balanced winding which will deliver approximately 10 milliwatts of audio power to a 600-ohm load, when the audio output is adjusted to provide 2 watts of audio power to the 5,000-ohm speaker terminals located on the rear of the receiver chassis.

The loudspeaker CHC-49154 is an 8-inch permanent magnet dynamic type, mounted in a metal housing and provided with matching input transformer and phone tipped cable for connection to the pin jack terminals on the rear of the chassis.

The input circuit of the receiver is arranged to be suitable for use with either a balanced feed line or a simple antenna-ground combination. The antenna length is not critical. A good length is approximately 50 feet. The antenna compensator provides correct tuning of the radio frequency stage, which is essential in obtaining maximum signal to noise ratio and image frequency rejection.

TECHNICAL FEATURES

Tube complement

Function	Number of tubes	Type
RF, first, second, third, IF amplifier.....	4	6SK7
HF oscillator and first detector.....	1	6K8
Second detector and AVC limiter.....	1	6H6
CW beat oscillator.....	1	6SJ7
First AF amplifier.....	1	6C5
AF power amplifier.....	1	6V6
Rectifier.....	1	5U4G
Voltage regulator.....	1	VR106
Total.....	11	

Type of receiver.—Superheterodyne.

IF frequency.—455 kc.

Type of reception.—CW, MCW, and voice.

Input.—Tuned circuit with antenna compensator.

Output impedance.—600 ohms for phones and 5,000 ohms for loudspeaker.

Power output.—10 mw. to phones and 2 watts to loudspeaker.

Sensitivity.—Data to be supplied.

Antenna.—Balanced feed line or straight antenna. Antenna length is not critical but approximately 50 feet in the clear is satisfactory.

Radiation frequency.—Band 2: safe; band 1: very close to limit, just above at 540 and 1300 kc; bands 3, 4, and 5: unsafe.

Band coverage:

Band:	Frequency (mc.)
1.....	0.54 to 1.32
2.....	1.32 to 3.2
3.....	3.2 to 5.7
4.....	5.7 to 10.0
5.....	10.0 to 18.0
6.....	18.0 to 31.0

and in addition band spreads are provided within four of the bands as follows:

- (a) 4.0 to 4.6 mc.
- (b) 8.0 to 9.6 mc.
- (c) 12.0 to 13.6 mc.
- (d) 15.0 to 18.0 mc.

Weights, dimensions, and Navy type numbers of equipment units included in the contract

Unit	Type No.	Height	Width	Depth	Weight
RBG receiver.....	CHC-46140	} Data to be supplied.			
Loudspeaker.....	CHC-49154				

SECTION	TABLE OF CONTENTS	PAGE
1	General Description	1
2	Description of Major Units	1
3	Tube Complement	2
4	Power Requirements	2
5	Antenna Requirements	2
6	Installation	2
7	Construction	3
	7.1 General	3
	7.2 Type CHC-46140 Receiver	3
	7.3 Type CHC-49154 Loud Speaker	4
8	Circuit Description	4
9	Operating Instructions	7
10	Performance Data	8
11	Maintenance and Repairs	8
12	Test Data	13
	12.1 Tube Socket Voltages	13
	12.2 Point to Point Resistance	14
	12.3 Stage Gain Measurements	15
13	Alignment	15
	13.1 General	15
	13.2 Visual Method	15
	13.3 Amplitude Modulation Method	16
	13.4 Emergency I.F. Alignment	16
	13.5 HF Oscillator & RF Alignment	17
14	Parts List	19
	14.1 List of Units	19
	14.2 Parts List By Symbol Designation	20
	14.3 Spare Parts	29
	14.4 RMA Resistor Color Code	31
	14.5 List of Manufacturers	31

LIST OF ILLUSTRATIONS

Fig. 1	Model RBG Equipment	v
Fig. 2	Fidelity Characteristic	9
Fig. 3	Sensitivity and Noise	9
Fig. 4	Image Attenuation	10
Fig. 5	AVC Characteristic	10
Fig. 6	Selectivity	11
Fig. 7	RF and HF Osc. Alignment Chart	18
Fig. 8	Outline—Receiver	32
Fig. 9	Outline—Speaker	33
Fig. 10	Circuit Diagram—Receiver	35
Fig. 11	Circuit Diagram—Speaker	34
Fig. 12	Front View of Receiver	36
Fig. 13	Rear View of Receiver	37
Fig. 14	Top View of Receiver	38
Fig. 15	Right End View of Receiver	39
Fig. 16	Left End View of Receiver	39
Fig. 17	Bottom View of Receiver	40
Fig. 18	RF and HF Osc. Coil Assembly	41
Fig. 19	Front View of Speaker	42
Fig. 20	Rear View of Speaker	42

MODEL RBG RADIO RECEIVING EQUIPMENT

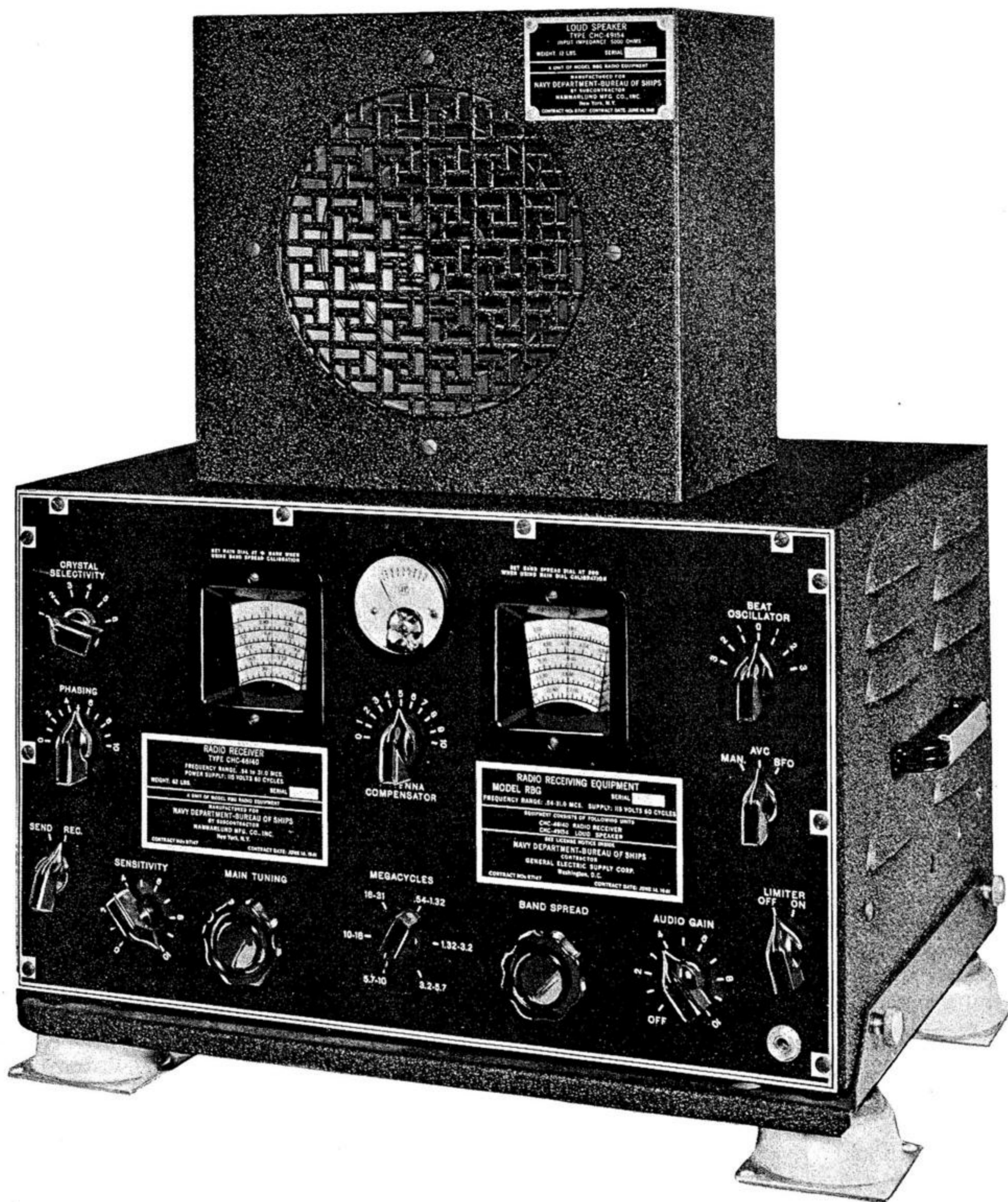

Fig. 1. Model RBG Equipment

1. GENERAL DESCRIPTION

- 1.1 The Model RBG Equipment is a complete radio receiving equipment.
- 1.2 The equipment is suitable for either headphone or loud speaker reception of radio telephone, CW telegraph, or MCW telegraph signals.
- 1.3 The equipment is of the table model type, and the receiver unit includes a shock absorber equipped mounting frame.
- 1.4 The equipment is suitable for operation from 110/120 volts A.C., either 50/60 cycle or 25 cycle as may be designated on the front panel and power transformer nameplate.
- 1.5 Each complete equipment consists of the following major items:
 Type CHC-46140 Radio Receiver for 50/60 cycle operation, or
 Type CHC-46163 Radio Receiver for 25 cycle operation.

 Type CHC-49154 Loud Speaker.
 Instruction books and a set of spare parts are supplied with each equipment.
- 1.6 The CHC-46140 Radio Receiver weighs 62 lbs.
 The CHC-46163 Radio Receiver weighs 67 lbs.
 The CHC-49154 Loud Speaker weighs 12 lbs.

 Spare parts and spare tubes (cased) for each equipment weigh 8 lbs.
 The total weight of the RBG or RBG-2 equipment, with cased spare parts, is 82 lbs.
 The total weight of the RBG-1 equipment, with cased spare parts, is 87 lbs.
 The overall dimensions of the Radio Receiver unit CHC-46140 or CHC-46163 are: $18\frac{15}{16}$ inches wide, $12\frac{3}{16}$ inches high and $14\frac{11}{16}$ inches deep.
 The CHC-49154 Loud Speaker is $10\frac{5}{16}$ inches wide, $9\frac{3}{8}$ inches high and $7\frac{5}{16}$ inches deep.
- 1.7 Outline Drawings are shown in Figs. 8 and 9.

2. DESCRIPTION OF MAJOR UNITS

- 2.1 The type CHC-46140 Radio Receiver is an eleven tube, table model, superheterodyne covering a continuous frequency range of .54 to 31.0 mega-

cycles in six bands. In addition, band spread is provided on four bands as follows:

- 4.00— 4.60 mc
- 8.00— 9.60 mc
- 12.00—13.60 mc
- 15.00—18.00 mc

2.11 The circuit employed comprises one stage of radio frequency amplification, a first detector and high frequency oscillator, three stages of intermediate frequency amplification operating at 455 kilocycles, a diode type second detector, a resistance coupled first audio amplifier and a resistance coupled audio output stage. A beat frequency oscillator is coupled to the second detector to provide for CW reception. A full-wave, high vacuum rectifier furnishes plate voltage and a voltage regulator tube is used to stabilize the HF oscillator plate supply. A crystal filter, the use of which is optional, is included and provides adjustable selectivity for the reception of signals where the normal non-crystal selectivity of the receiver is insufficient for rejection of closely adjacent interfering signals. One section of the duplex diode operates as the second detector and also provides automatic volume control for the radio frequency amplifier and the first and second intermediate frequency amplifiers. The other diode section is utilized in a limiter circuit which is useful in the reduction of ignition and similar pulse types of interference. The use of the limiter is optional and is controlled by a switch on the front panel. A tuning meter is provided which indicates relative signal strength, when the receiver is operated on AVC and the sensitivity control is set at maximum. This meter operates on either AVC or Manual control as a tuning indicator, the meter reading maximum at correct tuning of signal. The antenna compensator control on the front panel provides correct alignment of the radio frequency amplifier stage for maximum sensitivity, image rejection ratio and signal to noise ratio.

- 2.12 Two audio output circuits are provided:
- (1) A phone jack mounted on the front panel is connected to a balanced transformer winding which will deliver approximately 10 milliwatts of audio power to a 600 ohm load, when the audio output is adjusted to provide 2 watts of audio power to the 5000 ohm loud speaker terminals located on rear of the receiver chassis. The jack is so wired that the loud speaker circuit is opened when the phone plug is inserted.
 - (2) Loud speaker tip jack terminals located on the rear of the receiver chassis are connected through the jack switching circuit to a sepa-

rate winding of the power output transformer which will deliver approximately 2 watts of audio power to a 5000 ohm load. The Type CHC-49154 Loud Speaker is fitted with a coupling transformer which correctly matches this output impedance.

2.13 Antenna input terminals are provided on the rear of the receiver chassis. The input circuit is suitable for use with either a balanced feed line or a simple antenna-ground combination. See section 5.

2.14 The power supply for the equipment is an integral part of the receiver unit and employs a power transformer which is provided with a protective fuse in the primary circuit. See section 4.

2.2 The type CHC-49154 Loud Speaker is a table mounting, permanent magnet, dynamic speaker, mounted in an open back steel cabinet, provided with a matching input transformer with shielded, phone tipped leads. See Figs. 19 and 20.

3. TUBE COMPLEMENT

3.1 The tubes employed in the Radio Receiver are as follows:

<i>Symbol</i>	<i>RMA Type</i>	<i>Function</i>
V101	6SK7	RF Amplifier
V102	6K8	HF Osc. & 1st. Det.
V103	6SK7	1st. IF Amplifier
V104	6SK7	2nd. IF Amplifier
V105	6SK7	3rd. IF Amplifier
V106	6H6	2nd. Det., AVC & Limiter
V107	6SJ7	CW Beat Oscillator
V108	6C5	1st. AF Amplifier
V109	6V6	AF Power Amplifier
V110	5U4G	Rectifier
V111	VR-105	Voltage Regulator

4. POWER REQUIREMENTS

4.1 The Model RBG Radio Receiving Equipment is designed for operation from a 110/120 volt single phase power source. The type CHC-46140 Radio Receiver operates on a 50/60 cycle source. The type CHC-46163 Radio Receiver is supplied for 25 cycle operation. This type will also operate satisfactorily on a 60 cycle power source. The normal power consumption is 95 watts.

4.2 The heater current for all tubes exclusive of the rectifier tube is 3.3 amperes at 6.3 volts. The rectifier tube operates at 5.0 volts and 3.0 amperes.

4.3 The maximum total B power delivered from the rectifier is 120 milliamperes at 270 volts.

5. ANTENNA REQUIREMENTS

5.1 The input circuit of the CHC-46140 Radio Receiver is arranged to be suitable for use with either a balanced feed-line or a simple antenna-ground combination.

5.2 The average input impedance is approximately 500 ohms.

5.3 The antenna input terminals E101 are located on the rear of the receiver chassis. These terminals are marked A, A & G.

5.4 In an installation having a simple antenna-ground combination, connect the single lead-in wire from the antenna to the left hand terminal marked A and connect the ground lead, by means of a wire jumper, to both of the remaining terminals, (center A terminal and G terminal). The length of the antenna is not critical. A good length is approximately 50 feet.

5.5 In an installation having a balanced feed-line connect the two wires of the feed-line to the two terminals marked A and connect the terminal marked G to the ground.

6. INSTALLATION

6.1 The Model RBG Radio Receiving Equipment is shipped with each major unit packed in a separate container. Spare parts and spare tubes are also packed in separate containers.

6.2 After unpacking the units, the equipment may be permanently installed in the operating position. Figs. 8 and 9 show complete dimensions for this purpose.

6.3 The Receiver unit is shipped with the tubes in the sockets and ready for operation. Open the hinged lid, remove any paper packing, and be sure that all tubes are firmly in their sockets.

- 6.4 Attach the speaker cable to the tip jacks, E102, on the rear of the receiver chassis, or insert headphone plug in the phone jack J101, on the front panel.
- 6.5 Make antenna and ground connections in accordance with Section 5, Antenna Requirements.
- 6.6 Insert the power cord plug W101, into a 110/120 volt, 50/60 cycle source of single phase alternating current. If the only available power source is 25 cycle the Type CHC-46163 Receiver should be used.
- 6.7 Do not connect this equipment to direct current.
- 6.8 The equipment is now ready for operation and is turned on by means of a power switch which is thrown by turning the audio gain control knob E125 in a clockwise direction. This control adjusts the amount of audio signal desired. The send-receive switch, knob E126, should be in the "receive" position.

7. CONSTRUCTION

7.1 GENERAL

- 7.11 All items of the Model RBG Radio Receiving Equipment are ruggedly constructed of materials known to be suitable for each specific employment.
- 7.12 All materials are insofar as is practicable, resistant to the corrosive action of moist sea atmosphere or are suitably protected therefrom.
- 7.13 All soldered joints are both mechanically and electrically secure and rosin flux is used exclusively for all soldering.
- 7.14 The steel chassis is copper plated before application of cadmium plating, and the steel cabinets are copper plated underneath a black wrinkle finish so that the steel will be protected should the outer finish become injured.
- 7.15 Provision for ventilation is made by the use of louvres.
- 7.16 All major parts and spare parts are interchangeable, insofar as is practicable, without modification, with similar parts employed in other equipments, and are suitably marked to permit identification for ordering purposes.
- 7.17 Bronze lockwashers of the split type are used throughout under screw heads or nuts except in some places where the shakeproof type is used due to the requirement for uniform surface pressure, as against ceramic surfaces. Both types used are of bronze and have a nickel or cadmium plating.
- 7.18 All wiring is color coded in order to facilitate testing and the location of faults. All wiring is of the stranded flexible type and is protected by flameproof insulation.
- 7.19 The front panel has all markings etched permanently on the metal and carries a protective lacquer.

7.2 THE TYPE CHC-46140 RADIO RECEIVER

- 7.201 The receiver is designed for table mounting, and includes a shock absorber equipped mounting frame with provision for securing permanently in the desired operating position. See Figs. 1 and 8.
- 7.202 The sides, top and back of the receiver are protected by a steel cabinet which is attached to the front panel and to the sides and rear of the chassis by machine screws, which thread into tapped holes.
- 7.203 The bottom of the receiver is protected by a heavy steel bottom plate which is secured to the chassis bottom by machine screws. Four corner screws are part of rubber feet that are provided for cushioning.
- 7.204 The assembled receiver is secured in the shock absorber frame, by means of 4 stainless steel knurled thumb screws. Holes in the feet of each of the 4 shock absorbers are provided for securing the unit to the table.
- 7.205 The receiver panel layout is shown in Fig. 12. The functions of the various controls are described in Section 9, Operating Instructions.

7.206 The tuning capacitor assembly including the main tuning capacitor, the band spread capacitor and the antenna compensator, is designed especially for use in the CHC-46140 Receiver. The main tuning capacitor and the band spread tuning capacitor are of the 3 gang in line type with 180 degrees rotation for maximum capacitance change. Stator plates are supported by ceramic insulators. Contact to each of the rotors is made by means of 3 dual fingered bronze springs which have fine silver inlay at the contact ends. These make contact with fine silver collars that are soldered to the two rotor shafts. The main tuning capacitor consists of 3 two-unit sections, a small section and a large section, designed to provide different and more desirable capacitance values for the lower and higher portions of the large frequency range that is covered. See Section 8, Circuit Description.

7.207 The tuning capacitor rotors turn on single-ball bearings; one at each end of the shafts. Each rotor is driven through a pair of gears, with tension springs to eliminate backlash, by the tuning dials. The dials are operated by friction drive from the tuning knobs on the front panel. The turning ratio from knob to capacitor shaft is approximately 19 to 1. This arrangement provides vernier tuning action and permits the dial calibrations to extend over an angle of more than 300 degrees on the dial.

7.208 The tuning dials, as well as the tuning meter dial, are made of translucent laminated celluloid. The calibration scales are permanently imprinted on the center lamination, and the dials are illuminated from the rear by three separate dial lamps.

7.209 The RF and HF oscillator tuning coils, together with trimmer capacitors, fixed padding capacitors and band switch wafers are assembled in 3 separate units on cadmium plated brass angle frames. These frame assemblies are each secured to the chassis by machine screws. Additional rigidity of the entire coil assembly is accomplished by bolting two brass angles between the outer ends of the coil frames. See Fig. 18.

7.210 The band change switch consists of separate ceramic wafer type switches with silver contacts, which are mounted in each of the 3 coil frame assemblies. A bakelite shaft is passed through the entire coil and switch assembly, and is connected by a coupling to the detent mechanism on the front of the chassis.

7.211 The intermediate frequency transformers are all of the permeability tuned type with fixed capacitors of the silver on mica type.

7.212 All tube sockets are of the ceramic type.

7.213 All component parts are mounted with machine screws, to facilitate replacement in the event of failure or damage.

7.214 All fixed capacitors, with the exception of C108, C111 and C139, of .01 mfd. or less are of molded mica construction. Capacitors of more than .01 mfd. are of the metal cased, hermetically sealed, oil impregnated type.

7.215 All fixed resistors, except R141 and R142, are of either the metallized filament or wire wound type, sealed in a phenolic body and bear the R.M.A. color code. Resistors R141 and R142 are of the wire wound type, sealed in a ceramic tube.

7.216 The power transformer, filter chokes and audio output transformer are impregnated and hermetically sealed in drawn steel cases, suitably protected to prevent rusting. These units are each provided with phenolic terminal boards and pin type soldering terminals, suitably numbered.

7.3 THE TYPE CHC-49154 LOUD SPEAKER

7.31 The loud speaker is of the permanent magnet, dynamic, 8 inch cone type.

7.32 The cabinet is fabricated of sheet steel with spot welded inside lapping corner flanges and is copper plated under a black wrinkle finish. A speaker opening hole of 5½ inches diameter in the front is provided with an ornamental and protective grille spot welded to the inside of the cabinet.

7.33 The speaker impedance matching transformer is "potted" in a metal case and is provided with a two-wire shielded cable with phone tip terminals for connection to the receiver. See Figs. 19 and 20.

8. CIRCUIT DESCRIPTION

8.001 The circuit diagram of the Receiver is shown in Fig. 10.

8.002 For purposes of illustration it will be assumed that the band switch is in the position shown in the circuit diagram i. e., for operation from .54 to 1.32 megacycles. It is to be noted that the 6 switch wafers, S101 to S106 inclusive, are operated by a common shaft as described under Construction Par. No. 7.210. This switch may be operated in either a clockwise or counter-clockwise direction. The positions are 60 degrees apart and the various bands are positioned progressively in a clockwise direction as indicated on the front panel. See Fig. 12.

8.003 The signal is connected through the antenna terminals E101 and by switch S101 to the primary antenna coil L101. The secondary of coil L101 is tuned by the large section C102A and the small section C102D of the main tuning capacitor in parallel, and by the antenna compensating capacitor C101. The connections between tuning condenser and coil are made by switch S102.

8.004 It should be noted here, that the large sections C102A, C102B and C102C of the main tuning capacitor are used only for the two lowest frequency bands, i.e., .54 to 1.32 megacycles and 1.32 to 3.2 megacycles. This is shown by the circuit diagram.

8.005 The output of coil L101 is connected to the grid of the RF Amplifier tube V101 through blocking capacitor C103. The plate circuit of V101 is shunt fed, by means of choke L119 and capacitor C104, through switch S103 to the primary of RF coil L107. The secondary of RF coil L107 is tuned by the tuning capacitor sections C102B and C102E in parallel and by trimmer capacitor C150. The coil connections to the main tuning capacitors are made through switch S105. The output of coil L107 is connected to the signal grid of the converter tube V102.

8.006 The HF oscillator circuit is of the plate-tuned type with a fixed-coupled tickler coil in the grid circuit. The plate circuit of the oscillator section of the V102 tube is shunt fed by means of choke L123 and capacitor C109. The plate coil of L113 is tuned by the C102C and C102F sections of the main tuning condenser in parallel and the trimmer capacitor C149. The connections between the tuning capacitor and the coil are made through switch S106. In series with the tuning capacitor and the coil is a series padder condenser C148. This capacitor is used to modify the tuning characteristic of the HF oscillator circuit so that it will maintain a fixed frequency difference of 455

kilocycles from the signal-frequency circuits when the main tuning capacitor is varied through its tuning range. The HF oscillator frequency, in this receiver, is always higher than the signal frequency by the above mentioned 455 kilocycles which is called the intermediate frequency of the receiver. The grid coil of L113 connects through switch S104 and grid capacitor C110 to the oscillator grid of V102. The plate tuned circuit has, in addition to the capacitors above mentioned, a small capacitor C111 which has a negative capacitance-temperature characteristic. The function of this capacitor is to automatically compensate for capacitance variations in the HF oscillator circuit which are due to temperature change. The capacitor C108 connected between the signal grid and the oscillator grid is a small fixed capacitor the function of which is to neutralize the space charge current set up in the signal grid, which otherwise reacts on the oscillator circuit in such a manner as to lower the conversion conductance.

8.007 It is to be noted that the band spread capacitors C102G, C102H and C102I are permanently connected in the circuits. These capacitors are not normally used when operating in the two low frequency bands and the main dial calibrations are all made with the band spread capacitor set at the minimum capacitance end of its scale. The use of the dials is described under Operation Par. No. 9.011.

8.008 The converter tube V102 mixes the signal with the HF Oscillator output and produces the intermediate frequency of 455 kilocycles in its plate circuit, across the primary of the first IF transformer, Z101. Both the primary and secondary of this transformer are permeability-tuned by adjustable iron dust cores and fixed silver-mica type capacitors. The signal, taken from a tap on the secondary of Z101, is impressed on the grid of the first IF amplifier tube, V103.

8.009 The plate of the V103 connects to the primary of coil L126 in the crystal filter assembly Z102. This primary has a shunt capacitor C115 and is permeability-tuned as in the case of the Z101. The signal from the secondary of L126, which is a low impedance untuned coil, goes through the crystal selectivity switch S107 (in the No. 1 or non-crystal position) to the grid coil L127, which has a shunt capacitor, C120 and is permeability-tuned. On all other positions of the crystal selectivity switch, 2 to 6 inclusive, the quartz crystal Y101 is introduced, as a high impedance series tuned circuit, in series between the plate coil L126 and the grid coil L127. The latter, having resistance connected by switch S107 in series with its reactance,

appears as a load impedance on the crystal. This load impedance becomes lower in value as the switch position increases the series resistance, and has the effect of increasing the selectivity of the crystal filter. In positions 2 to 6 inclusive, with the crystal in the circuit, the phasing capacitor C119 introduces a voltage 180 degrees out of phase with the signal voltage applied to the crystal, thereby neutralizing the capacitance of the crystal holder. Further description of the function of C119 will be found under Operation Par. No. 9.010. The signal is taken from a tap on L127 to the grid of the second IF Amplifier tube V104. The plate of V104 connects to the primary of IF transformer Z103, which is identical to Z101 and the signal is taken from a tap on the secondary of Z103 to the grid of the third IF amplifier V105. The plate of V105 connects to the primary coil L128 of the IF transformer Z104. This coil has a shunt capacitor C124 and is permeability-tuned. The secondary of coil L128 feeds the signal through a low impedance shielded cable, with the coupling limiting coil L129 in series, to the low impedance primary of the detector input coil L130.

8.010 The secondary of L130 has a shunt capacitor C125 and is permeability-tuned. This circuit introduces the signal to the detector anode of the diode V106. The IF Signal is demodulated in this diode detector circuit and the modulation components of the signal are developed across resistor R131, with the limiter section of the diode V106 in series. The limiter diode is connected in parallel with the limiter switch S108 and when this switch is in the "off", or closed, position the limiter diode is short circuited and does not function. The limiter timing resistor R125 and capacitor C132A serve to hold the anode of the limiter diode at a positive potential with respect to the cathode under normal signal conditions. When the switch S108 is open, or in the limiter "on" position, the diode offers a low impedance to the modulation components of the signal. When a higher pulse of potential occurs, such as ignition or other short pulse type of noise, the anode of the limiter diode becomes negative with respect to the cathode and the then non-conducting diode prevents the passage of the pulse or reduces it to a great degree.

8.011 The capacitors C126 and C127 and the resistor R123 constitute a low-pass filter, the function of which is to suppress the 455 kilocycle component of the second detector output.

8.012 The resistors R124 and R130 constitute a path for the DC component developed by the diode detector, and the bias voltage for automatic volume

control is taken from the junction of these two resistors. The resistor R129 and capacitor C131 constitute a timing circuit for the AVC, which compensates for variations in signal-strength due to fading. When the MAN-AVC-BFO switch S109 is in the AVC position, the AVC voltage is impressed on the control grids of the RF amplifier tube V101 and the first and second IF amplifier tubes V103 and V104 through the filter resistors R102, R109 and R113 respectively. These resistors, together with the capacitors C105, C112 and C121, provide filtering and isolation of their various RF circuits.

8.013 When the MAN-AVC-BFO switch S109 is in the manual position, the AVC voltage is not used and the sensitivity control R127 is used to adjust the sensitivity of the receiver.

8.014 The tuning meter M101 is a sensitive microammeter connected in the ground return of the detector circuit. When the switch S109 is in the AVC position and the sensitivity control R127 is set at maximum the meter indicates relative signal strength and serves as an accurate tuning indicator. The meter is also in the circuit as a tuning indicator when switch S109 is in the manual position.

8.015 The beat frequency oscillator is of the conventional electron coupled type. The coil L131 has a fixed shunt capacitor C135 and an adjustable Beat Oscillator Control C136 for manually adjusting the pitch of the beat frequency tone. It is permeability-tuned, for the zero beat setting, to the intermediate frequency of 455 kilocycles. R133 is the oscillator grid leak and C134 the oscillator grid condenser. R134 is the oscillator plate load of the tube V107. The beat oscillator is energized by applying screen and plate voltage through switch S109 when it is in the BFO position only. R135 and R136 are isolating filter resistors. The capacitor C132C is the ground return for the screen (oscillator virtual plate) and C132B serves as a return by-pass for the plate load. The beat oscillator potential is impressed on the diode detector anode through the capacitor C128.

8.016 The audio component appearing across the resistor R131 is connected through the blocking capacitor C133 to the Audio Gain control R132 and from the adjustable arm of this control to the grid of the first AF amplifier tube V108. The plate circuit of this tube is resistance coupled to the grid circuit of the audio output tube V109 by the plate resistor R138,

the coupling capacitor C138, and the grid resistor R139. Resistor R137 provides self bias for tube V108. The audio output tube V109 is self biased by the resistor R140. The plate of the audio output tube connects to the primary of the output transformer T102. This transformer has two secondary windings, one being connected through switch circuits of the phone jack J101 to the speaker terminals E102 located on the rear of the chassis. The load impedance for this winding is 5000 ohms. The other secondary is a balanced-to-ground winding connected to the phone jack J101 on the front panel. The load impedance for this winding is 600 ohms. The circuit is so arranged that when a phone plug is inserted in the jack, the jack switch disconnects the speaker terminals and introduces a resistance (R141) load of 5000 ohms across the speaker winding. The phone winding is designed so that the power it delivers to a 600 ohm load is approximately 10 milliwatts when the audio output at the speaker terminals is adjusted to 2 watts.

8.017 AC power is supplied to the receiver through the combination plug and cable W101 and through a 1.5 ampere fuse F101 to the primary of transformer T101. The fuse F101 provides adequate protection to the power transformer and the Rectifier tube V110 in the event of failure or damage in some part of the receiver which might impose a heavy overload on the transformer. One secondary supplies heater power for all of the tubes, other than the rectifier, and for dial lamps. The rectifier tube heater is supplied from a separate secondary and the plate supply by a center tapped high voltage winding. Filtering of the rectified plate power is accomplished by the two reactors L124 and L125 and by filter capacitors C157 to C161 inclusive. Voltage from the output of the filter is supplied through resistor R142 to the anode of the Voltage Regulator tube V111. This tube maintains a steady potential of approximately 105 volts, which is used to supply plate power to the HF oscillator, and screen voltage to the converter, the RF and the first two IF amplifier tubes.

8.018 The send-receive switch S110 connects the plate voltage to the RF amplifier and the first two IF amplifier tubes and when in the "send" position desensitizes the receiver for transmitting periods, for protection of the receiver from the local transmitter, but does not disconnect the receiver from the power source, thus leaving the tubes heated and ready for instant use.

9. OPERATING INSTRUCTIONS

- 9.001 All switches and controls are identified by etched titles and indices on the front panel. See Fig. 12.
- 9.002 The equipment is turned on by means of the power switch which is thrown by turning the Audio Gain Control Knob E125 in a clockwise direction. This control adjusts the amount of audio signal desired.
- 9.003 The Send-Receive switch knob E126 should be in the "receive" position and unless there is a local transmitter, see Par. No. 8.018, this switch may be left in the "receive" position at all times.
- 9.004 The band-change switch, knob E122, is used to select the frequency band in which reception is desired.
- 9.005 The MAN-AVC-BFO switch knob E123 is set in accordance with the type of signal that is desired.
- 9.006 The sensitivity control knob, E124, is used to manually control the signal when either CW code reception or manual control of sensitivity for modulated signals is desired. In either of these cases the audio gain control should be set at or near maximum and the sensitivity control advanced only as far as is required by the signal, in order to prevent overloading. When AVC is used the sensitivity control should be fully advanced and the output adjusted by means of the audio gain control.
- 9.007 When the MAN-AVC-BFO switch knob, E123, is operated in the BFO position, the beat frequency oscillator is "on" for CW reception or for locating very weak modulated signals. The Beat Oscillator Control knob, E128, is normally set at the zero position and is adjusted from this position to produce the desired audio beat tone after tuning the desired signal to zero beat.
- 9.008 The Antenna Compensator, knob E121, provides correct tuning of the antenna circuit, which is essential in obtaining maximum signal-to-noise ratio and image frequency rejection. The adjustment of this control is very important when tuning in weak signals.

9.009 The limiter control, knob E127, on or off, is optional and determined by the conditions of reception. If ignition or other similar short pulse types of noise are present the limiter will be of great help in reducing the interference.

9.010 The quartz crystal filter has six different degrees of selectivity, controlled by the Crystal Selectivity switch, knob E129. When this switch is set on position 1, the crystal holder is short-circuited, the crystal consequently inactive, and the receiver exhibits least selectivity, or broadest response. Refer to Fig. 6. Positions 2, 3 and 4 give selectivity varying from broad to fairly sharp and are usually suitable for phone or modulated signal reception. Positions 5 and 6 are sharp and very sharp respectively and are usually suitable for CW code reception. Normally the phasing control, knob E130, should be set at the arrow in the center of its scale. Adjustment of this control when on any of the five positions from 2 to 6 greatly increases the selectivity on one side or the other of the signal frequency and reduces or eliminates heterodyne interference.

9.011 The main tuning knob, E119, controls the main tuning condenser and dial N104. The main dial is calibrated in megacycles, in six bands. The band and scale used depend upon the setting of the band-change switch, controlled by knob E122. When using the main dial calibration the band spread dial should be set at the 200 line on its arbitrary scale. The calibration of the main dial should then be accurate within one per cent.

9.012 The band spread tuning knob E120, controls the band spread condenser and dial N105. The band spread dial is calibrated in megacycles for each of the four Navy short wave bands, and also has an arbitrary 0-200 scale.

9.013 When the band spread dial is used, it is to be noted that the 200 line on its arbitrary scale coincides with the high frequency end of all four of the Navy bands. The main dial should be set at the diamond mark corresponding to the high frequency end of the band spread range in which operation is desired. For example: if reception of a 12.70 megacycle signal is desired using the band spread dial; set the band-change switch at 10-18 megacycles and set the main dial at the diamond mark at 13.6 megacycles. The band spread dial is now used to tune the desired 12.70 megacycle signal (or any other signal in the band from 12.00 to 13.60 megacycles). When set up in this

manner the band spread calibration should agree approximately with known signal frequencies. If, however, it is found to be slightly off, the band spread dial should be readjusted to correspond with the known frequency of the signal, and the signal should then be retuned by slightly altering the setting of the main dial. A very slight deviation from the diamond mark on the main dial will make an appreciable change in the band spread tuning.

10. PERFORMANCE DATA

The curves in this section are indicative of the performance to be expected of the CHC-46140 or the CHC-46163 Radio Receiver, and provide data which is useful in determining whether repairs or alignment adjustments are necessary. Fig. 2 shows the overall Fidelity characteristic of the receiver. Fig. 3 shows the overall maximum Sensitivity and the maximum noise output in relation to the maximum sensitivity. Fig. 4 shows the attenuation of Image Frequency signals, i.e., signals equal to the signal frequency, for which the receiver is tuned, plus twice the Intermediate Frequency. Fig. 5 shows the AVC characteristic. Fig. 6 shows the overall Selectivity of the receiver, for both non-crystal and for the five different crystal operating conditions.

11. MAINTENANCE AND REPAIRS

11.001 Adequate test equipment for maintenance of the Model RBG Radio Receiving Equipment should include the following items:

- (1) A Model 605-B General Radio Co. standard signal generator, or equivalent.
- (2) A type 418-G General Radio Co. standard IRE dummy antenna, or equivalent.
- (3) A Model 695 Type 11 Weston Output meter, or equivalent.
- (4) A Model 663 Weston volt-ohmmeter, or equivalent.
- (5) A frequency modulated signal generator RCA No. 150, or equivalent.
- (6) A cathode-ray oscillograph, RCA No. 155, or equivalent.
- (7) A 600 ohm resistor for phone jack load and a 6600 ohm 5 watt resistor for speaker load, or a suitable resistor which in parallel with the resistance of the output meter produces a 5000 ohm load.
- (8) An insulated alignment screw driver having small metal blade.

The performance and test data of sections 10 and 12 were determined with equipment as listed above.

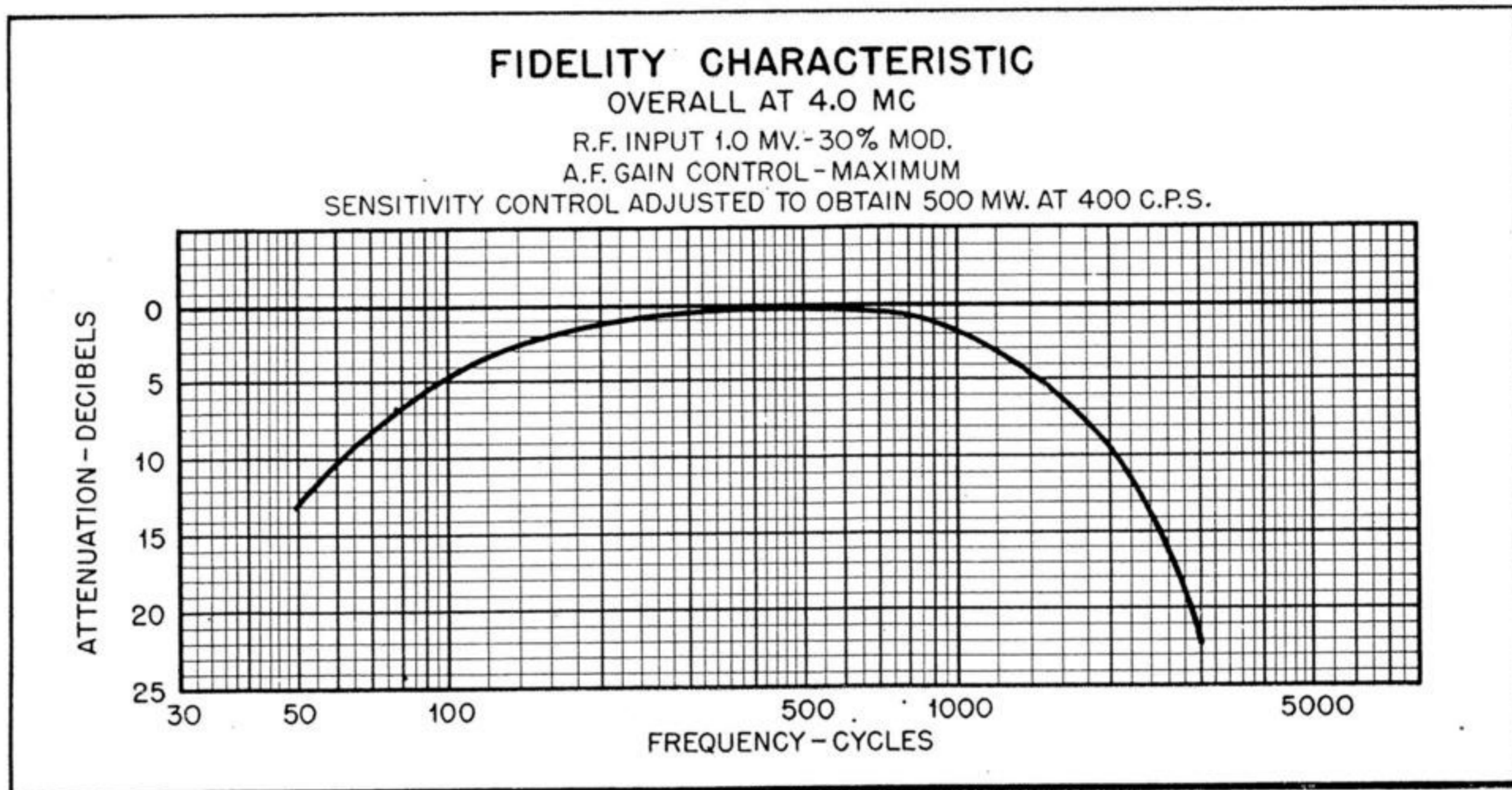

Fig. 2

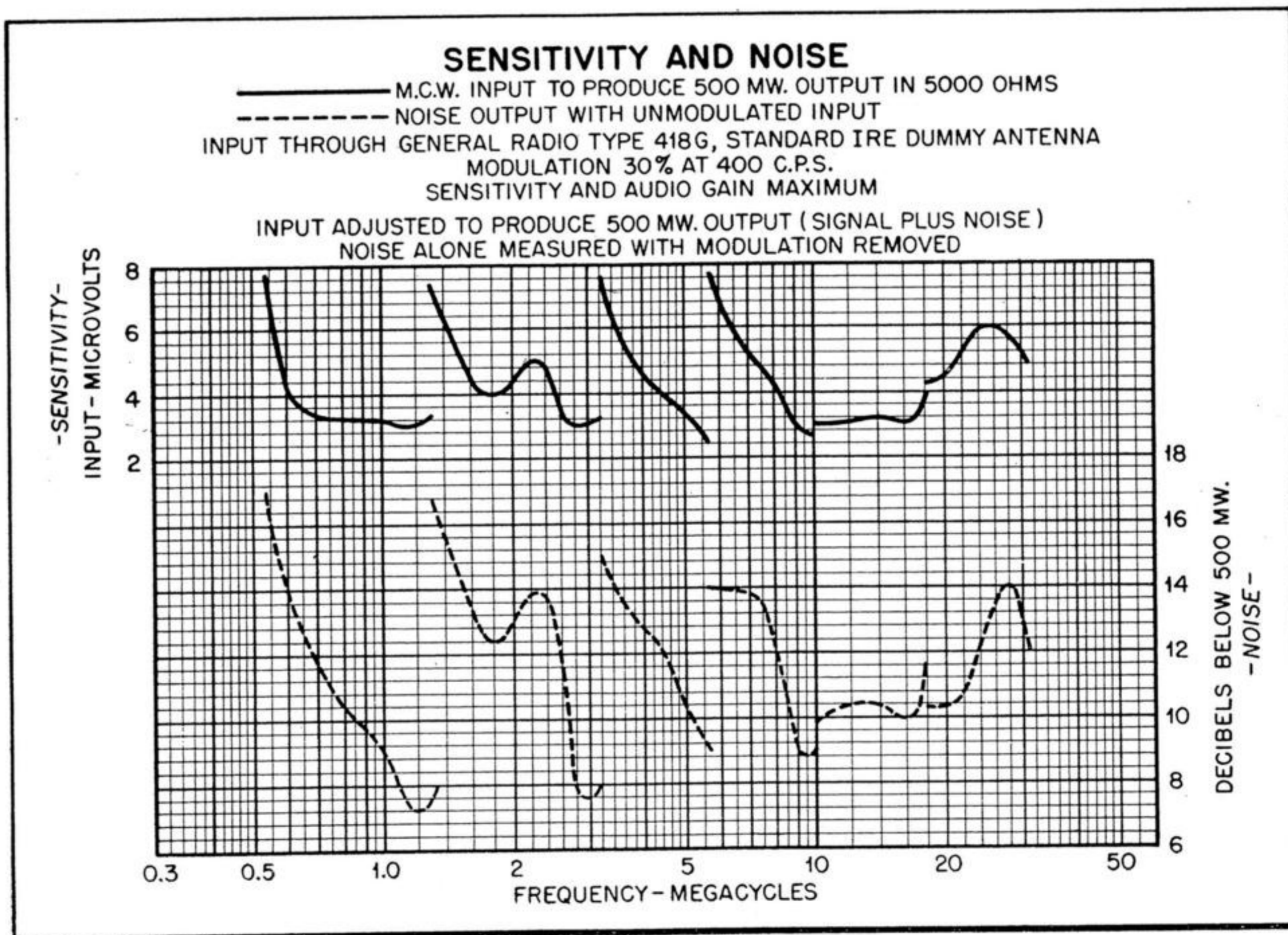

Fig. 3

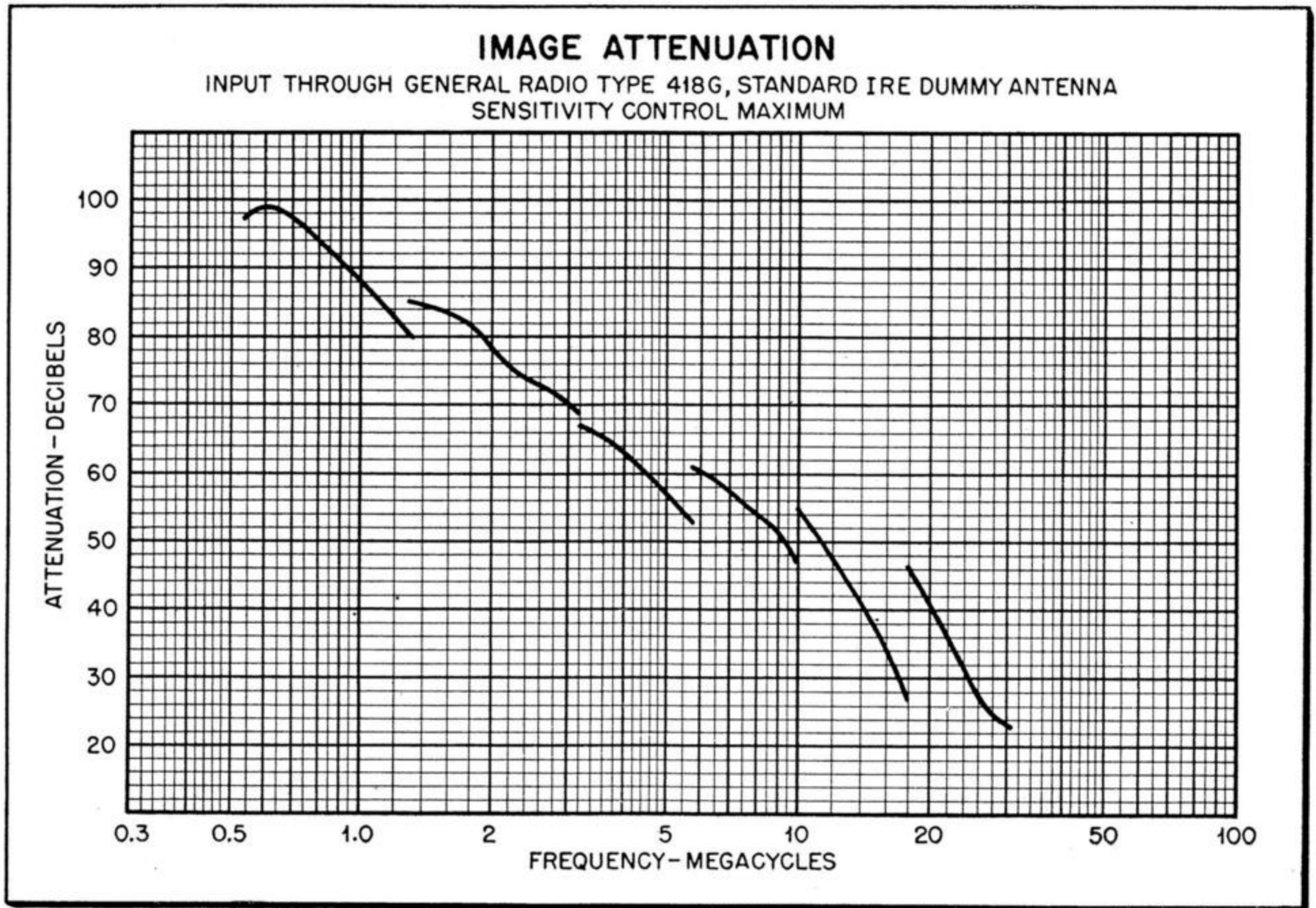

Fig. 4

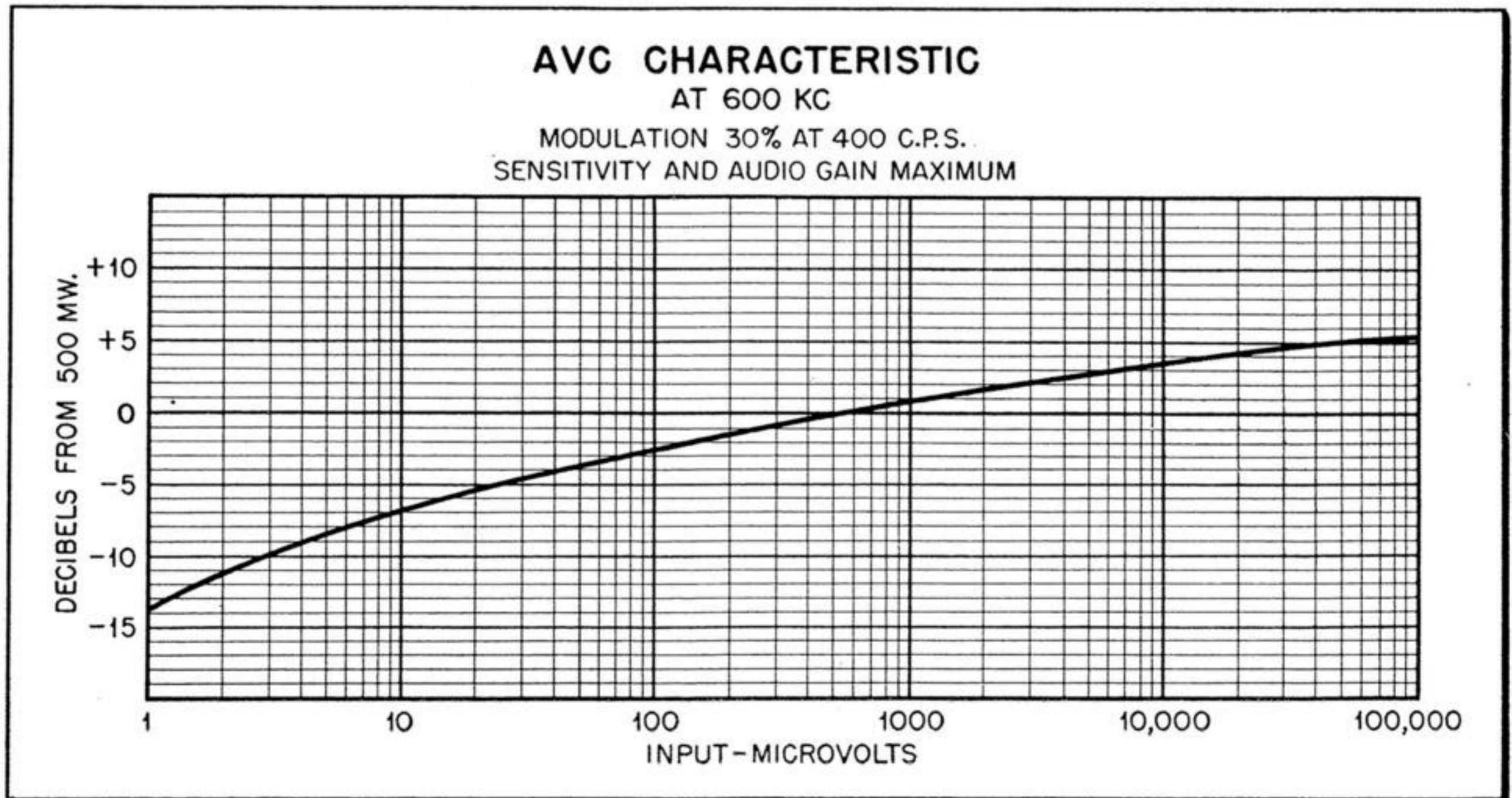

Fig. 5

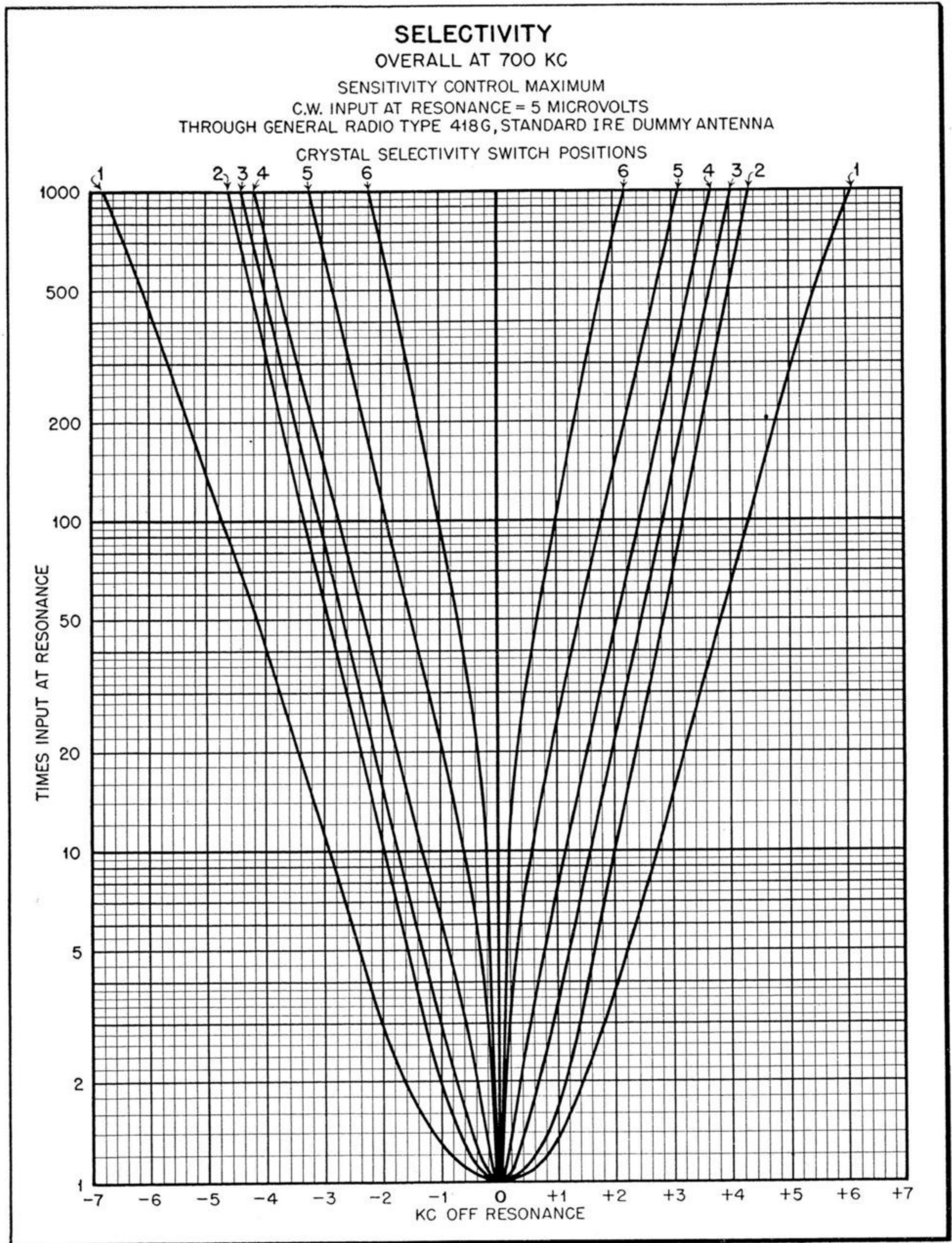

Fig. 6

11.002 In making any tests or adjustments, it is essential that the operator consider the influence that any one circuit element may have upon other associated circuits. The test data of section 12 will be particularly helpful in determining the extent of such influence and the necessity for making further replacements after a fault in one particular circuit element has been located and repaired. For example: a shorted bypass condenser or tube element may cause damage to a filter resistor and upon locating the shorted condenser the associated filter resistor should be checked, or vice versa.

11.003 A faulty vacuum tube in the receiver may greatly reduce the sensitivity, produce intermittent operation, cause intermittent or excessive noise, or result in complete failure of operation. In such cases, all tubes should be checked preferably by replacement with tubes of known quality. A light tapping of the tubes may locate a noisy or intermittent fault.

11.004 The CHC-46140 receiver is not critical to tubes in general, as regards effect on alignment. A replacement of the V102 tube may, however, affect the calibration and performance. See Alignment, Section 13.

11.005 In case of breakdown or failure of the receiver the fault must first be localized in one portion of the circuit. This can usually be accomplished by observation of some peculiar action of one of the controls or by checking the receiver against the test data in section 12. Reference to Figs. 17 and 18 and circuit diagram, Fig. 10, will aid in the location of any component part. Functions and ratings of component parts are given in the Parts Lists, section 14.

11.006 It must be remembered that the test data of section 12 will not positively locate certain faults. For example: an open-circuited by-pass capacitor will not appear in point to point resistance tests

and may introduce regeneration or oscillation in certain circuits which affect the gain of other circuits. Similarly a short-circuit occurring in a low resistance inductor will not appear in a point to point resistance test. A short in an RF or IF inductor will usually require a resort to an alignment check and the faulty circuit will not tune properly or will give very poor gain.

11.007 By-pass or filter capacitors which develop poor internal connections or become open-circuited will cause decreased sensitivity and/or poor stability. The defective unit can be located by temporarily connecting a good capacitor in parallel with any capacitor suspected of fault.

11.008 Failure of any by-pass or filter capacitor may seriously overload resistors of the associated circuits. Overloads of this kind will usually scorch the painted surface of the resistor and make it very easy to locate by visual inspection.

11.009 Open or short-circuited resistors can be definitely located by checking the resistance of the individual units. The circuit diagram Fig. 10 should be consulted to make sure that a resistor under test is not connected in parallel with some other circuit element, which would produce a false measurement.

11.010 Loose connections, which cause intermittent or noisy operation, and which cannot be located by resistance tests may be located by individually testing each circuit element or by tapping or shaking any component under suspicion, with the receiver adjusted for normal operation.

11.011 Failure of operation accompanied by a blowing of fuse, F101, may be caused by a short-circuited filter capacitor C157 to C161, by a short-circuit in the rectifier tube V110, or by any unusual load such as a short-circuit on a heater winding, or on the B supply. Faults of this kind are directly traceable by resistance measurement.

12. TEST DATA

12.1 TUBE SOCKET VOLTAGES					
Terminal Name	Pin No.	Variable		D.C. Volts	
		Symbol	Setting	R127 At 0	R127 At 10
V101	Grid	4	none	0	0
V101	Cathode	5	none	B23	A3.8
V101	Screen	6	none	C105	C102
V101	Plate	8	none	D256	D234
V102	Sig. Grid	CAP	none	0	0
V102	Cathode	8	none	A2	A2
V102	Screen	4	none	C95	C95
V102	Sig. Plate	3	none	C247	C232
V102	Osc. Grid	5	none	*	*
V102	Osc. Plate	6	none	C105	C105
V103	Grid	4	none	0	0
V103	Cathode	5	none	B23	A3.8
V103	Screen	6	none	C105	C102
V103	Plate	8	none	C250	C220
V104	Grid	4	none	0	0
V104	Cathode	5	none	B23	A3.8
V104	Screen	6	none	C105	C102
V104	Plate	8	none	C250	C220
V105	Grid	4	none	0	0
V105	Cathode	5	none	A3.6	A3.3
V105	Screen	6	none	C103	C98
V105	Plate	8	none	C233	C217
V107	Grid	4	S109	B-6 #	B-6 #
V107	Cathode	5	S109	0	0
V107	Screen	6	S109	B36	B35
V107	Plate	8	S109	C200	C188
V108	Grid	5	none	0	0
V108	Cathode	8	none	A2.7	A2.7
V108	Plate	3	none	C130	C122
V109	Grid	5	none	0	0
V109	Cathode	8	none	B13	B12
V109	Screen	4	none	D253	D240
V109	Plate	3	none	D250	D240
V111	Cathode	2	none	0	0
V111	Anode	4, 5, 8	none	105	105

Values in this table are made with the equipment connected for normal operation. Power input 115 volts 60 cycles. No input signal. MAN.-AVC-BFO Switch (S109) in MAN. position unless otherwise specified. Send-receive switch (S110) in receive position. Voltage measurements made with a D.C. voltmeter, 1000 ohms per volt. All voltages are measured between terminal and receiver chassis, the chassis being the minus or negative lead, except value marked #, for which the polarity is reversed.

"A" readings on 0-10 scale: meter resistance 10,000 ohms.
 "B" readings on 0-100 scale: meter resistance 100,000 ohms.
 "C" readings on 0-250 scale: meter resistance 250,000 ohms.
 "D" readings on 0-500 scale: meter resistance 500,000 ohms.

*Measurement cannot be made with voltmeter due to loading effects on circuit.

MODEL RBG RADIO RECEIVING EQUIPMENT

12.2 POINT TO POINT RESISTANCE

Terminal to Chassis

Terminal Name	Pin No.	Variable		Resistance in Ohms
		Symbol	Setting	
V101 Grid	4	S109	MAN.	1,000,000
V101 Grid	4	S109	AVC	3,000,000
V101 Grid	4	S109	BFO	1,000,000
V101 Cathode	5	R127	0	5,000
V101 Cathode	5	R127	10	140
V101 Screen	6	none		71,000
V101 Plate	8	S110	REC	66,000
V101 Plate	8	S110	SEND	INFINITE
V102 Sig. Grid	CAP	S105	*	.02 to 4*
V102 Cathode	8	none		230
V102 Screen	4	none		71,000
V102 Sig. Plate	3	none		67,000
V102 Osc. Grid	5	none		50,000
V102 Osc. Plate	6	none		70,000
V103 Grid	4	S109	MAN.	10,000
V103 Grid	4	S109	AVC	2,000,000
V103 Grid	4	S109	BFO	10,000
V103 Cathode	5	R127	0	5,000
V103 Cathode	5	R127	10	140
V103 Screen	6	none		71,000
V103 Plate	8	S110	REC	66,000
V103 Plate	8	S110	SEND	INFINITE
V104 Grid	4	S109	MAN.	10,000
V104 Grid	4	S109	AVC	2,000,000
V104 Grid	4	S109	BFO	10,000
V104 Cathode	5	R127	0	5,000
V104 Cathode	5	R127	10	140
V104 Screen	6	none		71,000
V104 Plate	8	S110	REC	66,000
V104 Plate	8	S110	SEND	INFINITE
V105 Grid	4	none		1
V105 Cathode	5	none		300
V105 Screen	6	none		115,000
V105 Plate	8	none		67,000
V106 Cathode	8	none		0
V106 Cathode	4	S108	OFF	270,000
V106 Cathode	4	S108	ON	2,360,000
V106 Plate	5	S108	OFF	555,000
V106 Plate	5	S108	ON	590,000
V106 Plate	3	S108	OFF	270,000
V107 Grid	4	none		50,000
V107 Cathode	5	none		.8
V107 Screen	6	S109	BFO	275,000
V107 Plate	8	S109	BFO	78,000
V108 Grid	5	R132	10	250,000
V108 Cathode	8	none		600
V108 Plate	3	none		90,000
V109 Grid	5	none		200,000
V109 Cathode	8	none		280
V109 Screen	4	none		65,000
V109 Plate	3	none		65,000
V110 Cathode	8	none		65,000
V110 Plate	4	none		105
V110 Plate	6	none		115
V111 Cathode	2	none		0
V111 Anode	5	none		69,000

* Value depends on frequency band setting.

12.3 STAGE GAIN MEASUREMENTS

12.31 The sensitivity measurements listed below are provided as a guide in the location of the cause of low sensitivity. The high output lead from the Signal Generator is connected to the grid terminal of the indicated tube and the low output lead is connected to the receiver chassis. The signal is modulated 30 per cent at 400 cycles and the signal adjusted to the intermediate frequency of the receiver. Adjust the signal input to obtain an output of 500 milliwatts (50 volts across a 5000 ohm load). The input at the various intermediate frequency tubes should be as follows:

<i>Input to</i>	<i>Microvolts</i>
V102	less than 175
V103	less than 2,000
V104	less than 5,000
V105	less than 175,000

13. ALIGNMENT

13.1 GENERAL

13.11 Should realignment of the receiver circuits become necessary the following alignment data should be studied carefully before making any circuit adjustments. It is important that the operator understand the function of each circuit element so that correct alignment may be accomplished. The operator should, therefore, familiarize himself with section 7 Construction, and section 8 Circuit Description.

13.12 The operator is cautioned against making any adjustments indiscriminately and he should not alter any alignment adjustment unless tests definitely indicate that alignment is necessary.

13.13 All alignment adjustments can be made with the test equipment listed in Par. No. 11.001 under Maintenance and Repairs.

13.14 The complete alignment of the receiver is divided into two main steps:

- (1) Intermediate frequency amplifier alignment.
- (2) HF oscillator and RF amplifier alignment.

13.15 To align the intermediate frequency amplifier it is necessary to remove the receiver cabinet, bottom plate and corner shield from the chassis. This is accomplished as follows:

- (1) Remove the four knurled thumb screws that secure the receiver to the shock mounting frame and lift the receiver from the mounting frame.
- (2) Remove the two screws from each side and the three screws from the rear of the receiver

cabinet. Remove the ten screws from around the top and sides of the receiver front panel and lift the cabinet off the receiver.

- (3) Unscrew the six screws and the four rubber feet from the bottom of the receiver and remove the bottom cover plate.
- (4) Remove the shield, covering the corner of the chassis where the phone jack is located, by removing the ten screws and lockwashers that secure it to the chassis, being careful to not leave these screws and washers loose in the receiver.

13.2 VISUAL METHOD

13.21 Connect the output lead from the frequency modulated signal generator through a blocking capacitor (.01 to .1 mfd.) to the control grid terminal pin, No. 4, of the third IF tube V105. Connect the synchronizing lead from the frequency modulated signal generator, to the external synchronizing terminal of the cathode ray oscillograph and connect a lead from the vertical input terminal of the oscillograph to the cathode terminal, pin 4, of the limiter and detector tube V106.

13.22 The loud speaker or phones may be used to monitor the signal if desired and is suggested as an aid in bringing the adjustment into approximate resonance.

13.23 Set the main tuning dial to .54 megacycles and the band switch to the .54 to 1.32 megacycle position, the send-receive switch to "receive", the limiter "off" and the MAN-AVC-BFO switch to the "MAN" position. Set the crystal selectivity switch on position No. 1 and the phasing control to the arrow of its scale.

13.24 With signal input to the V105 grid and the frequency of the signal generator adjusted to 455 kilocycles, adjust the plate inductor, L128 of transformer Z104 and the detector input inductor L130 of transformer Z105, alternately, to obtain maximum amplitude and symmetry together with pattern coincidence on the oscillograph. See Figs. 15 and 16.

13.25 Move the signal input lead from the V105 grid to the grid cap of the converter tube V102, without removing the normal grid cap connection. Adjust the lower, (plate) inductors and the upper (grid) inductors of transformers Z101 and Z103 and the lower (plate) inductor L126 of the crystal filter Z102 for maximum amplitude, symmetry and coincidence of the oscillograph pattern.

13.26 Now set the crystal selectivity switch to the No. 2 position and the phasing control at the arrow (center position) and adjust the upper (grid) inductor L127 of the crystal filter Z102 for maximum amplitude and similar appearance of the two images. Adjust signal input or receiver sensitivity control to prevent overloading.

13.27 Set the crystal selectivity switch to the No. 3 position and adjust the phasing control slightly from its arrow position, if necessary to produce identical images. Adjust the signal generator frequency to obtain coincidence of the images and if complete coincidence is not obtained, alternately make slight adjustments of the phasing control and signal generator frequency until coincidence is realized. If after making these adjustments the phasing control should deviate materially from the arrow position, remove the side cover plate from the crystal filter Z102 and after setting the phasing control at the arrow position, adjust capacitor C118 for coincidence of images. These last adjustments have determined the exact frequency of the quartz crystal and the signal generator frequency should be left undisturbed.

13.28 Repeat the complete IF alignment procedure, of paragraphs 13.21 to 13.27 inclusive, for the crystal frequency, until maximum amplitude and coincidence are obtained for both crystal and non-crystal positions of the crystal selectivity switch.

13.3 AMPLITUDE MODULATION METHOD

13.31 With the Signal Generator adjusted for a 455 kilocycle signal, 30% modulated at 400 cycles, connect the Generator output to the grid, pin No. 4, of the third IF tube V105. Connect the output meter to the speaker terminals of the receiver. The meter should be shunted with a resistive load, such that the parallel resistance of the combination is 5000 ohms. The receiver tuning meter may be used instead of the output meter, as a tuning meter, if desired. Adjust the plate inductor, L128, of transformer Z104 and the detector input inductor L130 of transformer Z105, alternately to obtain maximum amplitude of the output meter reading.

13.32 Move the Signal Generator output lead from the V105 grid to the grid cap of the converter tube V102, without removing the normal grid cap connection. Adjust the lower (plate) and upper (grid) inductors of transformers Z101 and Z103 and the lower

(plate) inductor of L126 of the crystal filter Z102 for maximum output.

13.33 Now turn the crystal selectivity switch to the No. 6 position and the phasing control to the arrow (center position) and turn off the modulation of the Signal Generator. Carefully adjust the frequency of the Signal Generator for maximum reading on the tuning meter M101. The Signal Generator frequency should not be disturbed after making this adjustment. Turn the Crystal Selectivity switch to the No. 1 position and adjust the lower (plate) inductor, L126 of the crystal filter, Z102, for maximum meter reading and by means of the Generator output or the Sensitivity control adjust for a reading of 9 on the tuning meter. Now turn the Crystal Selectivity switch to the No. 2 position and adjust the upper (grid) inductor L127 of the crystal filter Z102 to obtain a tuning meter reading slightly lower than 9 (Approx. 8.9).

13.34 Remove the four screws and top cover plate of the Crystal Filter Z102, and remove the screw and retaining spring of the Crystal holder. Carefully remove the Crystal electrode and keep its bottom side free of dust and finger marks. (This side has a ground finish.) Now remove the Quartz Crystal being extremely careful to prevent chipping it, and keep it clean. Leaving the ceramic spacing bars in place, replace the metal electrode and the retainer spring and screw. Adjust the signal input or sensitivity control to produce a reading of 9 on the tuning meter M101, with the crystal selectivity switch on position No. 2 and the crystal phasing control set at No. 3 of its dial and adjust the trimmer capacitor C118 to obtain the lowest possible reading of the tuning meter. Replace the Quartz Crystal and the associated parts and, without disturbing the signal generator frequency, repeat the procedure followed in paragraphs 13.31 and 13.32.

13.4 EMERGENCY IF ALIGNMENT

13.41 If emergency replacements or repairs become necessary in a location where no signal generator is available, it is possible to accomplish any or all of the IF alignment adjustments described under paragraphs 13.31 to 13.34 by substituting the beat frequency oscillator of the receiver for the signal generator and by using the receiver tuning meter throughout as the resonance indicator.

13.42 This method requires unsoldering and disconnecting the terminal of capacitor C128 from pin No. 4 of the detector tube socket V106. Attach a test lead of insulated wire to this terminal of the capaci-

tor C128, long enough to reach to the grid cap of the VI02 tube. Make a temporary wire jumper connection between the center and rear terminals of the five terminal connection strip E113. See Fig. 17.

13.43 Using the lead from capacitor C128 to replace the output lead from the signal generator, follow the instructions for IF alignment as described in paragraphs 13.31 to 13.34. The beat oscillator of the receiver, unless its adjustment has been disturbed, will be adjusted for the frequency of the Quartz Crystal and the IF amplifier when the beat oscillator control is at zero. When adjustments have been made remove the jumper connection and lead described in Par. No. 13.42 above and resolder the connection to capacitor C128.

13.5 HF OSCILLATOR AND RF ALIGNMENT

13.51 With the signal generator connected to the antenna terminal strip E101 through the

dummy antenna (or through a 400 ohm resistor if the dummy antenna is not available) and with the band spread dial set at 200 on its arbitrary scale, adjust the signal frequency to 1.25 megacycles. Set the band change switch to the .54 to 1.32 mc position, the main dial to 1.25 mc (see Fig. 7), and adjust capacitors C149, C150 and the antenna compensator C101 for maximum output. Adjust the signal generator output or the sensitivity control to give the desired output meter reading without overloading.

13.52 Set the main dial and the signal generator frequency at .6 megacycles and adjust inductors L113, L107, and L101 for maximum output meter reading. Repeat the above adjustments until no increase of output is obtained. Follow the same procedure as above for the other five frequency bands, referring to the alignment chart Fig. 7 and to Fig. 18 for the alignment frequencies and location of adjustments.

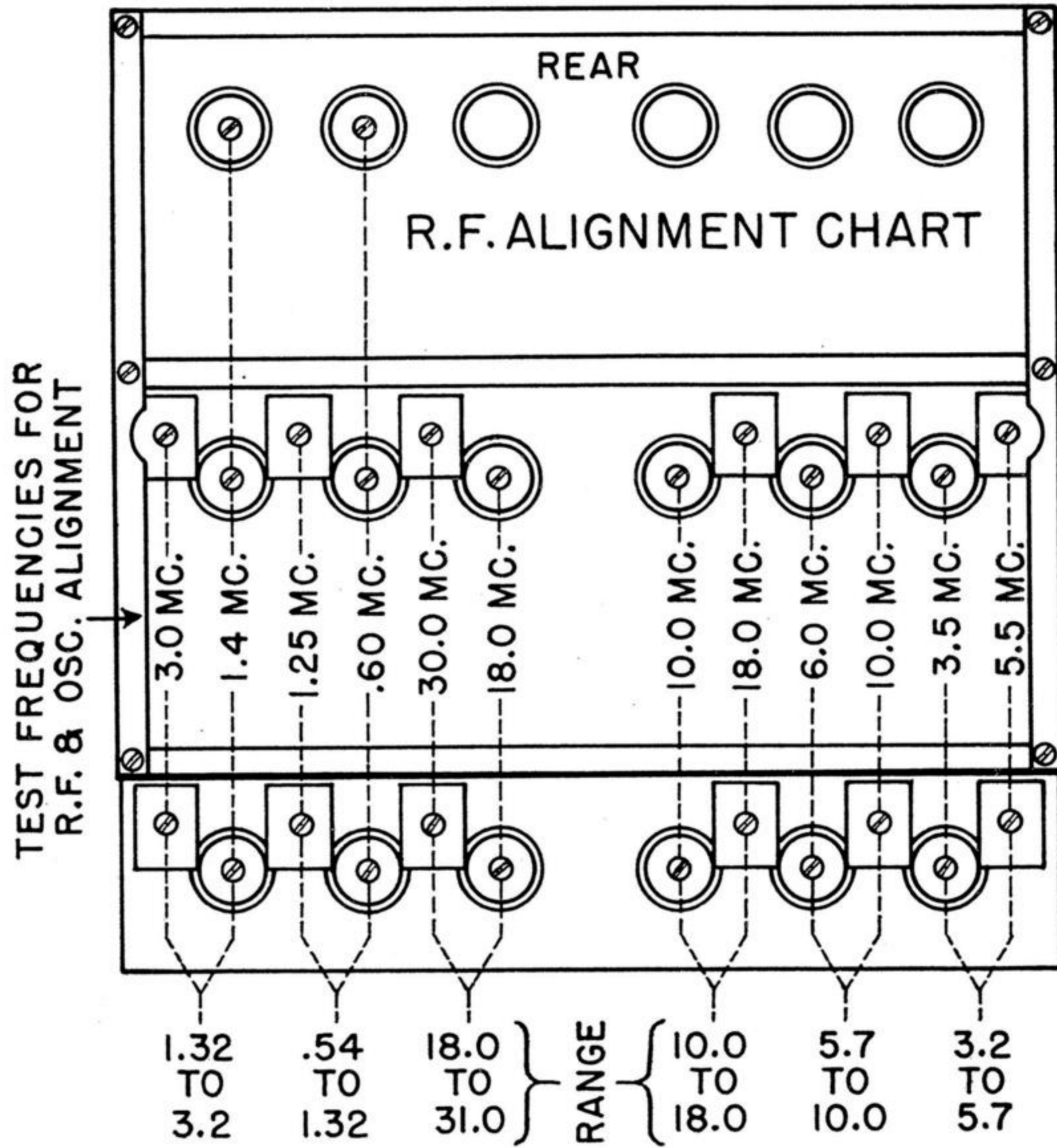

Fig. 7. RF and HF Osc. Alignment Chart

14. PARTS LIST

14.1 LIST OF MAJOR UNITS FOR MODELS RBG AND RBG-1 RADIO RECEIVING EQUIPMENTS		
Navy Type Designation	Name	Symbol Designation Group
CHC-46140 and CHC-46163	Radio Receiver	101-199
CHC-49154	Loud Speaker	201-299

14.2 TABLE I
PARTS LIST BY SYMBOL DESIGNATION FOR MODELS RBG AND RBG-1 RADIO RECEIVING EQUIPMENTS
Section I
CHC-46140 AND CHC-46163 RADIO RECEIVER UNITS (101-199)

Symbol	FUNCTION	DESCRIPTION	Mfr.	Mfr. Design.	Hammarlund Mfg. Co. Dwg. or Part No.
A101	Front Panel (CHC-46140 only)	Etched Aluminum $\frac{1}{16}$ " thick	17		6261
A101	Front Panel (CHC-46163 only)	Etched Aluminum $\frac{1}{16}$ " thick	17		6308
A102	Receiver Cabinet	Fabricated Steel Black Finish	9		6256
A103	Shock Mounting Frame	Fabricated Steel Black Finish	9		6234
STRUCTURAL PARTS					
CAPACITORS					
C101	Antenna Compensating Capacitor	Variable Air	9		SA-759
C102	RF Grid Tuning Cap. Large Sect.	Variable Air	9		SA-761
	Det. Grid Tuning Cap. Large Sect.	Variable Air			
	HF Osc. Tuning Cap. Large Sect.	Variable Air			
	RF Grid Tuning Cap. Small Sect.	Variable Air			
	Det. Grid Tuning Cap. Small Sect.	Variable Air			
	HF Osc. Tuning Cap. Small Sect.	Variable Air			
	RF Grid Tuning Cap. Band Spread	Variable Air			
	Det. Grid Tuning Cap. Band Spread	Variable Air			
	HF Osc. Tuning Cap. Band Spread	Variable Air			
*C103	V101 Grid Coupling	Molded Mica: 600 mmf \pm 10% 500 V DC W	6	5W	6073
*C104	V101 Plate Coupling	Same as C103			
*C105	V101 Grid Filter	Molded Mica: .01 mfd \pm 10% 300 V DC W	6	3WLS	4886
*C106	V101 Cathode By-pass	Paper: 3 x .05 mfd + 20% — 10% 600 V DC W	6	DYR600555	4891
	V101 Screen By-pass				
	V101 Plate Filter				
*C107	V102 Cathode by-pass	Same as C106			
	V102 Screen By-pass				
	V102 Osc. Plate Filter				
C108	V102 Neutralizing		9		6189
*C109	V102 Osc. Plate Blocking	Mica Trimmer Adj. & Sealed 1.5-2.0 mmf	6	2R	6061
C110	V102 Osc. Grid	Molded Silver Mica: 673 mmf \pm 1% 500 V DC W	6	5R	6195
C111	HF Osc. Compensating	Molded Silver Mica: 95 mmf \pm 2% 500 V DC W	6	N680L	6277
*C112	V103 Grid Filter	Ceramic Temp. Comp. 5.5 mmf \pm 10% 500 V DC W	24		
*C113	V102 Plate Filter	Same as C105			
*C114	V103 Cathode By-pass	Same as C106			
	V103 Screen By-pass				
	V103 Plate Filter				
C115	V103 Plate Tuning	Molded Silver Mica: 120 mmf \pm 2% 500 V DC W	6	5R	6179
*C116	Crystal Filter Center Tapping	Molded Mica: 100 mmf \pm 5% 500 V DC W	6	5W	6172
*C117	Crystal Filter Center Tapping	Same as C116			
*C118	Crystal Filter Phasing Trimmer	Mica Trimmer: 1.5-5.0 mmf	9		6189
C119	Crystal Filter Phasing	Variable Air Dual Stator	9		SA-760
C120	V104 Grid Tuning	Molded Silver Mica: 85 mmf \pm 2% 500 V DC W	6	5R	6180

* Spare parts furnished refer to Table II for quantities.

Symbol part designation if any.

14.2 TABLE I—(Continued)

PARTS LIST BY SYMBOL DESIGNATION FOR MODELS RBG AND RBG-1 RADIO RECEIVING EQUIPMENTS

Section I

CHC-46140 AND CHC-46163 RADIO RECEIVER UNITS (101-199)

Symbol Desig.	#	FUNCTION	DESCRIPTION	Mfr.	Mfr. Desig.	Hammarlund Mfg. Co. Dwg. or Part No.
CAPACITORS—(Continued)						
*C121	A	V104 Grid Filter	Same as C105			
*C122	B	V104 Cathode By-pass	Same as C106			
	C	V104 Screen By-pass				
*C123	A	V104 Plate Filter	Same as C106			
	B	V105 Cathode By-pass				
	C	V105 Screen By-pass				
C124		V105 Plate Filter	Same as C110			
C125		V105 Plate Tuning	Same as C110			
C126		V106 Det. Plate Tuning	Same as C110			
C127		V106 RF Filter	Same as C110			
*C128		V106 RF Filter	Same as C110			
C129		V107 to V106 Coupling	Molded Silver Mica: 6 mmf + 0--2 mmf 500 V DC W	6	5R	6151
*C130		V106 Limiter Plate By-pass	Same as C110			
*C131		M101 By-pass	Same as C105			
*C132		AVC Tuning	Same as C105			
	A	Limiter Tuning	Same as C106			
	B	V107 Plate Filter				
	C	V107 Screen By-pass				
*C133		V108 Grid Coupling	Same as C105			
C134		V107 Grid	Silver Mica 240 mmf (part of L131 Assembly)			
C135		V107 Tuning	Silver Mica 225 mmf (part of L131 Assembly)			
C136		CW Osc. Vernier	Variable Air	9		SA-758
*C137		V109 Grid By-pass	Same as C103			
*C138		V108 to V109 Coupling	Same as C105			
*C139		V109 Plate By-pass	Paper: Tubular .01 mfd 1000 V DC W	25	3-115F	6307
*C140		L118 Trimmer	Mica Trimmer: 4-30 mmf	9		6055
*C141		L117 Trimmer	Same as C140			
*C142		L116 Trimmer	Same as C140			
C143		L116 Series Padder	Molded Silver Mica: 2500 mmf ± 5% 300 V DC W	6	1R	6236
*C144		L115 Series Padder	Molded Silver Mica: 1500 mmf ± 5% 500 V DC W	6	1R	6235
*C145		L115 Trimmer	Same as C140			
*C146		L114 Trimmer	Same as C140			
*C147	A	L114 Series Padder	Molded Silver Mica: 988 mmf ± 2% 500 V DC W	6	1R	6296
*C148		L113 Series Padder	Molded Silver Mica: 375 mmf ± 1% 500 V DC W	6	5R	6295
*C149		L113 Trimmer	Same as C140			
*C150		L107 Trimmer	Same as C140			
*C151		L108 Trimmer	Same as C140			
*C152		L109 Trimmer	Same as C140			
*C153		L110 Trimmer	Same as C140			
*C154		L111 Trimmer	Same as C140			
*C155		L112 Trimmer	Same as C140			
*C156	A	AC Line By-pass	Paper: 2 x .1 mfd + 20% -10% 600 V DC W	6	DYR6011	6275

* Spare parts furnished refer to Table II for quantities.

Symbol part designation if any.

14.2 TABLE I—(Continued)
 PARTS LIST BY SYMBOL DESIGNATION FOR MODELS RBG AND RBG-1 RADIO RECEIVING EQUIPMENTS
 Section I
 CHC-46140 AND CHC-46163 RADIO RECEIVER UNITS (101-199)

Symbol		FUNCTION	DESCRIPTION	Mfr.	Mfr. Desig.	Hammarlund Mfg. Co. Dwg. or Part No.
Desig.	*					
CAPACITORS—(Continued)						
*C156	B	AC Line By-pass	Paper: 4 mfd + 10% -3% 600 V DC W Navy type 481080	6	TLAD-6040	6254
*C157		Input Filter	Same as C157			
*C158		Input Filter	Same as C157			
*C159		Intermediate Filter	Same as C157			
*C160		Intermediate Filter	Same as C157			
*C161		Output Filter	Same as C157			
MISCELLANEOUS ELECTRICAL PARTS						
E101		Antenna Terminals	Screw Terminal Assembly	12		6088
E102		Speaker Terminals	Dual Pin Jack Assembly	12		6302
E103		Fuse Holder (CHC-46140 only)	Fuse Clip Holder Assembly	12		3859
E104		RF Lead Thru Insulator	Polystyrene Lead Thru Insulator	18	TPB	6284
E105		Det. Lead Thru Insulator	Same as E104			
E106		Osc. Lead Thru Insulator	Same as E104			
E107		RF Wiring Stand-off Insulator	Isolantite Stand-off $\frac{7}{16}$ " dia. $\frac{3}{4}$ " long 6-32th	9		2915
E108		RF Wiring Stand-off Insulator	Same as E107			
E109		RF Wiring Stand-off Insulator	Same as E107			
E110		Insulating Terminals	2 Terminal connection strip	12	2002	6281
E111		Insulating Terminals	Same as E110			
E112		Insulating Terminals	4 Terminal connection strip	12	2004	6152
E113		Insulating Terminals	5 Terminal connection strip	12	2005	6282
E114		Insulating Terminals	6 Terminal connection strip	12	2006	6153
E115		Insulating Terminals	Same as E114			
E116		Insulating Terminals	Same as E114			
E117		Insulating Terminals	Same as E114			
E118		Insulating Terminals	8 Terminal connection strip	12	2008	4931
E119		Main Tuning (C102A-C102F inc.)	Molded Bakelite Knob	14		3856
E120		Band Spread Tuning (C102G, H, I)	Same as E119			
E121		Antenna Compensator (C101)	Molded Bakelite Knob	7	2150	6105
E122		RF Band Switch (S101-S106 inc.)	Same as E121			
E123		MAN-AVC-BFO Switch (S109)	Same as E121			
E124		Sensitivity Control (R127)	Same as E121			
E125		AF Gain Control (R132)	Same as E121			
E126		Send-Receive Switch (S110)	Same as E121			
E127		Limiter Switch (S108)	Same as E121			
E128		Beat Osc. Vernier (C136)	Same as E121			
E129		Crystal Switch (S107)	Same as E121			
E130		Crystal Phasing (C119)	Same as E121			
E131		Fuse Holder (CHC-46163 only)	Molded Bakelite, Screw type	28	1075	6309

* Spare parts furnished refer to Table II for quantities.

* Symbol part designation if any.

14.2 TABLE I—(Continued)
PARTS LIST BY SYMBOL, DESIGNATION FOR MODELS RBG AND RBG-1 RADIO RECEIVING EQUIPMENTS
Section I
CHC-46140 AND CHC-46163 RADIO RECEIVER UNITS (101-199)

Symbol		FUNCTION	DESCRIPTION	Mfr.	Mfr. Design.	Hammarlund Mfg. Co. Dwg. or Part No.
Desig.	*					
*F101		AC Line Fuse	1.5 Amp. Glass Enclosed	4		6065
FUSES						
HARDWARE						
H101		Shock Mounting Cabinet Handle	Stainless Steel 10-32 Thread (4 used)	9		6272
H102		Shock absorber	Fabricated Metal Handle (2 used)	19	X-2818	6032
H103		Receiver Feet	Lord Shock Absorber (4 used)	15	200PH45	6262
H104		Shock Mtg. Bolts	Rubber Bumper Feet 10-32 Screw (4 used)	2	422-A	6266
H105		Shock Mtg. Nuts	Cap Screw $\frac{3}{8}$ x 24 (4 used)	9		6273
H106		Meter Clamp Mtg.	Steel Hex. $\frac{3}{8}$ x 24 (4 used)	9		6274
H107		Transformer Mtg. Nut (CHC-46140 only)	Tuning Meter Clamp Ring Brass N.P.	26	D-54108	3926
H108		Transformer Mtg. Nut (CHC-46163 only)	Special Mtg. Post 8-32 x $\frac{3}{4}$ " Brass N.P.	9		6304
H108		Shock Mtg. Lockwasher	Special Mtg. Post 10-32 x $\frac{3}{4}$ " Brass N.P.	9		6310
H109			Bronze Split $\frac{3}{8}$ " x $\frac{1}{8}$ " x $\frac{3}{32}$ " (4 used)	9		6311
INDICATORS						
*I101		Band Spread Dial Lamp	Bayonet Type .15 amp. 6.3 Volt Pilot Lamp	8	47	6036
*I102		Main Dial Lamp	Same as I101			
*I103		Meter Dial Lamp	Same as I101			
I104		Main Dial Indicator	Transparent Celluloid Indicator Assembly	9		SA-650
I105		Band Spread Dial Indicator	Same as I104			
JACKS						
*J101		Phone Jack	Long Frame 2 Circ. Fil. Light g. Jack Type	16	5	6255
INDUCTORS						
I101		Antenna Coil .54-1.32 Mc	Bank Wound Litz Adj. Iron Dust Core	9		SA-752D
L102		Antenna Coil 1.32-3.2 Mc	Bank Wound Litz Adj. Iron Dust Core	9		SA-752F
L103		Antenna Coil 3.2-5.7 Mc	Spaced Wound	23		6013
L104		Antenna Coil 5.7-10.0 Mc	Spaced Wound	23		6016
L105		Antenna Coil 10.0-18.0 Mc	Spaced Wound	23		6019
L106		Antenna Coil 18.0-31.0 Mc	Spaced Wound	23		6022
L107		RF Coil .54-1.32 Mc	Bank Wound Litz Adj. Iron Dust Core	9		SA-753C

* Spare parts furnished refer to Table II for quantities.
* Symbol part designation if any.

14.2 TABLE I—(Continued)
PARTS LIST BY SYMBOL DESIGNATION FOR MODELS RBG AND RBG-1 RADIO RECEIVING EQUIPMENTS
Section I
CHC-46140 AND CHC-46163 RADIO RECEIVER UNITS (101-199)

Symbol		FUNCTION	DESCRIPTION	Mfr.	Mfr. Desig.	Hammarlund Mfg. Co. Dwg. or Part No.
Desig.	*					
INDUCTORS—(Continued)						
L108		RF Coil 1.32-3.2 Mc	Bank Wound Litz Adj. Iron Dust Core	9		SA-753D
L109		RF Coil 3.2-5.7 Mc	Spaced Wound Adj. Iron Dust Core	9		SA-753E
L110		RF Coil 5.7-10.0 Mc	Spaced Wound Adj. Iron Dust Core	9		SA-753F
L111		RF Coil 10.0-18.0 Mc	Spaced Wound Adj. Iron Dust Core	9		SA-753G
L112		RF Coil 18.0-31.0 Mc	Spaced Wound Adj. Iron Dust Core	9		SA-753H
L113		HF Osc. Coil .54-1.32 Mc Range	Bank Wound Litz Adj. Iron Dust Core	9		SA-754C
L114		HF Osc. Coil 1.32-3.2 Mc Range	Bank Wound Litz Adj. Iron Dust Core	9		SA-754D
L115		HF Osc. Coil 3.2-5.7 Mc Range	Spaced Wound Adj. Iron Dust Core	9		SA-754E
L116		HF Osc. Coil 5.7-10.0 Mc Range	Spaced Wound Adj. Iron Dust Core	9		SA-754F
L117		HF Osc. Coil 10.0-18.0 Mc Range	Spaced Wound Adj. Iron Dust Core	9		SA-754G
L118		HF Osc. Coil 18.0-31.0 Mc Range	Spaced Wound Adj. Iron Dust Core	9		SA-754H
*L119		V101 Plate Inductor	RF Choke 2 mh 32 ohms DC	9		6181
*L120		V101 Cathode Filter	Same as L119			
*L121		V103 Cathode Filter	Same as L119			
*L122		V104 Cathode Filter	Same as L119			
*L123		V102 Osc. Plate Inductor	RF Choke 10 mh 90 ohms DC	9	7381	6244
*L124		Plate Supply Filter	Iron Core Reactor 7.5 h at 110 ma DC 200 ohm	5		6253
*L125		Plate Supply Filter	Same as L124			
L126		V103 Plate Coil	Crystal Filter Plate Coil	23		6291
L127		V104 Grid Coil	Crystal Filter Grid Coil	23		6245
L128		V105 Plate Coil	IF Output Plate Coupling Coil	23		6247
L129		Link Circuit Series Inductor	Series Coupling Coil (part of Z104)	23		6202
L130		V106 Input Coil	Diode Detector Input Coil	23		6248
L131		V107 Beat Osc. Coil	Part of Z106	23		6290
METERS						
*M101		Tuning and "S" Meter	2" Flush Mtg. Special	3		4903
NAMEPLATES AND DIALS						
N101		Equipment Nameplate	Integral part of Etched Panel (A101)	17		6300
N102		Receiver Nameplate	Integral Part of Etched Panel (A101)	9		SA-755
N103		Acceptance Date Plate	Etched Aluminum	9		SA-756
N104		Main Tuning Dial	Frequency Imprinted Translucent Celluloid	17		6288
N105		Band Spread Tuning Dial	Frequency Imprinted Translucent Celluloid	17		6203
N106		Tube Location Diagram Plate	Etched Aluminum			
N107		License Notice Plate	Etched Aluminum			

* Spare parts furnished refer to Table II for quantities.

* Symbol part designation if any.

14.2 TABLE I—(Continued)

PARTS LIST BY SYMBOL DESIGNATION FOR MODELS RBC AND RBC-I RADIO RECEIVING EQUIPMENTS

Section 1

CHC-46140 AND CHC-46163 RADIO RECEIVER UNITS (101-199)

Symbol		FUNCTION	DESCRIPTION	Mfr.	Mfr. Desig.	Hammarlund Mfg. Co. Dwg. or Part No.
Desig.	*					
RESISTORS						
*R101		V101 Grid	1 Megohm ± 20% 1/2 watt	10	BT 1/2	6167
*R102		V101 Grid Filter	10000 ohm ± 20% 1/2 watt	10	BT 1/2	6165
*R103		V101 Screen Filter	1000 ohm ± 20% 1/2 watt	10	BT 1/2	6160
*R104		V101 Plate Filter	2000 ohm ± 10% 1/2 watt	10	BT 1/2	6279
*R105		V102 Cathode	230 ohm ± 5% 1/2 watt	10	BW 1/2	6156
*R106		V102 Screen Filter	Same as R103			
*R107		V102 Osc. Plate Filter	Same as R104			
*R108		V102 Osc. Grid Leak	50000 ohm ± 10% 1/2 watt	10	BT 1/2	6075
*R109		V103 Grid Filter	Same as R102			
*R110		V102 Plate Filter	Same as R103			
*R111		V103 Screen Filter	Same as R103			
*R112		V103 Plate Filter	Same as R103			
*R113		V104 Grid Filter	Same as R102			
R114		Crystal Select. Determining	25 ohm ± 10% 1/2 watt	10	BW 1/2	6155
R115		Crystal Select. Determining	50 ohm ± 10% 1/2 watt	10	BW 1/2	6170
*R116		Crystal Select. Determining	300 ohm ± 10% 1/2 watt	10	BT 1/2	6169
*R117		Crystal Select. Determining	Same as R103			
*R118		V104 Screen Filter	Same as R103			
*R119		V104 Plate Filter	Same as R103			
*R120		V105 Cathode	Same as R116			
*R121		V105 Screen Filter	50000 ohm ± 20% 1 watt	10	BT-1	6166
*R122		V105 Plate Filter	Same as R103			
*R123		V106 Det. Filter	Same as R108			
*R124		V106 Det. Diode Load	270000 ohm ± 10% 1/2 watt	10	BT 1/2	6280
*R125		Limiter Timing	Same as R101			
*R126		Sensitivity Bleeder	60000 ohm ± 10% 1 watt			
*R127		Sensitivity Control	5000 ohm Linear Pot.	10	BT-1	3804
*R128		V101, V103, V104 Bias Limiting	100 ohm ± 10% 1/2 watt	10	VC-9688	6250
*R129		AVC Timing	2 Megohm ± 10% 1/2 watt	10	BW 1/2	4812
*R130		V106 Det. Diode Load	Same as R124	10	BT 1/2	4920
*R131		V106 Cathode	820000 ohm ± 10% 1/2 watt	10	BT 1/2	6293
*R132		AF Gain Control, V108 Grid	250000 ohm Pot. (with S111)	10	VC-9257	6249
R133		V107 Grid Leak	50000 ohm (Part of L131 Assembly)			
*R134		V107 Plate	3300 ohm ± 10% 1/2 watt	10	BT 1/2	6292
*R135		V107 Screen Filter	200000 ohm ± 10% 1/2 watt	10	BT 1/2	3812
*R136		V107 B Filter	Same as R102			
*R137		V108 Cathode	600 ohm ± 10% 1/2 watt	10	BT 1/2	3807
*R138		V108 Plate	25000 ohm ± 10% 1 watt	10	BT-1	6209
*R139		V109 Grid	Same as R135			
*R140		V109 Cathode	280 ohm ± 5% 1 watt	10	BW-1	6278
*R141		Non Speaker T102 Load	5000 ohm ± 5% 5 watt wire wound	25	5K	6270
*R142		V111 Anode	4000 ohm ± 5% 5 watt wire wound	25	5K	6276

* Spare parts furnished refer to Table II for quantities.
* Symbol part designation if any.

14.2 TABLE I—(Continued)
 PARTS LIST BY SYMBOL DESIGNATION FOR MODELS RBG AND RBG-I RADIO RECEIVING EQUIPMENTS
 Section 1
 CHC-46140 AND CHC-46163 RADIO RECEIVER UNITS (101-199)

Symbol		FUNCTION	DESCRIPTION	Mfr.	Mfr. Desig.	Hammarlund Mfg. Co. Dwg. or Part No.
Design.	#					
SWITCHES						
*S101		Antenna	Ceramic Rotary Wafer	20	21912-HC	6217
*S102		RF Ampl. Grid	Ceramic Rotary Wafer	20	22900-HC	6220
*S103		RF Ampl. Plate	Ceramic Rotary Wafer	20	21913-HC	6218
*S104		HF Osc. Grid	Same as S103			
*S105		1st Det. Grid	Ceramic Rotary Wafer	20	21914-HC	6219
*S106		HF Osc. Plate	Same as S105			
S107		Crystal Selectivity	Bakelite Rotary Wafer	20	22481-QH	6119
*S108		Limiter	Bakelite Rotary Wafer	20	22480-23	6241
*S109		MAN-AVC-CW	Bakelite Rotary Wafer	20	22482-53	6216
*S110		Send-Receive	Bakelite Rotary Wafer	20	22765-23	6098
S111		On-Off Power	Combined with R132			
TRANSFORMERS						
*T101		Power Transformer (For CHC-46140 only)	50-60 Cycle, 1 Phase, 90 VA: Pri. 1-2 3.1 ohms, 117 V: Sec. 3-4-5, 290 -0-290 V, 210 ohms total: Sec. 6-7, 6.3 V, 3 Amp., .1 ohm: Sec. 8-9, 5 V, 4 Amp., .1 ohm	5	7382	6252
*T101		Power Transformer (For CHC-46163 only)	Same as above except, for 25 cycle	5	7494	6301
*T102		AF Output Transformer	Pri. 1-2, 650 ohms Pri.-Sec. turn Ratio 1-1.07 Sec. 3-4, Z 5000 ohm: Pri.-Sec. turn Ratio 1-1.0246 Sec. 5-6, C.t. Ground, Z 3 ohm: 3-4, 550 ohms DC: 5-6 15 ohms DC	5	7383	6251
VACUUM TUBES						
*V101		RF Amplifier	RF Pentode	21	6SK7	
*V102		HF Osc. 1st. Det.	Triode—Hexode Converter	21	6K8	
*V103		1st. IF Amplifier	Same as V101			
*V104		2nd. IF Amplifier	Same as V101			
*V105		3rd. IF Amplifier	Same as V101			
*V106		2nd. Det. AVC Limiter	Twin Diode	21	6H6	
*V107		CW Beat Osc.	RF Pentode	21	6SJ7	
*V108		1st. AF Amplifier	Amplifier Triode	21	6C5	
*V109		AF Power Amplifier	Beam Power Amplifier	21	6V6	
*V110		Rectifier	Full Wave Rect.	21	5U4G	
*V111		Voltage Regulator	Voltage Regulator	21	VR-105	
WIRE						
W101		Power Cord (with plug)	7½ ft. Twin Rubber (with plug)	27		6143
W102		Dial and Meter Lamp Wiring	Dial and Meter Lamp Wiring Assembly	9		SA-771

* Spare parts furnished refer to Table II for quantities.
 # Symbol part designation if any.

14.2 TABLE I—(Continued)

PARTS LIST BY SYMBOL DESIGNATION FOR MODELS RBG AND RBG-1 RADIO RECEIVING EQUIPMENTS

Section I

CHC-46140 AND CHC-46163 RADIO RECEIVER UNITS (101-199)

Symbol		FUNCTION	DESCRIPTION	Mfr.	Mfr. Desig.	Hammarlund Mfg. Co. Dwg. or Part No.
Desig.	*					
TUBE SOCKETS						
*X101		Socket for V101	8 Prong Ceramic	1	RSS8M	6265
*X102		Socket for V102	Same as X101			
*X103		Socket for V103	Same as X101			
*X104		Socket for V104	Same as X101			
*X105		Socket for V105	Same as X101			
*X106		Socket for V106	Same as X101			
*X107		Socket for V107	Same as X101			
*X108		Socket for V108	Same as X101			
*X109		Socket for V109	Same as X101			
*X110		Socket for V110	Same as X101			
*X111		Socket for V111	Same as X101			

CRYSTAL

Y101		Resonator	Quartz Crystal 455 kc	22		6182
------	--	-----------	-----------------------	----	--	------

IF TRANSFORMERS-- FILTERS, ETC.

*Z101		V102 to V103 Coupling	IF Transformer Assembly	23		6289
*Z102		V103 to V104 Coupling	Crystal Filter Assembly	9		SA-768
*Z103		V104 to V105 Coupling	Same as Z101	9		SA-766
*Z104		V105 Plate to Link Coupling	IF Transformer Assembly	9		SA-767
*Z105		V106 Link to Diode Coupling	IF Transformer Assembly	9		SA-757
Z106		CW Osc. Tuning	CW Osc. Tuning Assembly (with S109)	9		

* Spare parts furnished refer to Table II for quantities.

* Symbol part designation if any.

14.2 TABLE I—(Continued)

PARTS LIST BY SYMBOL DESIGNATION FOR MODELS RBG AND RBG-1 RADIO RECEIVING EQUIPMENTS

Section 2

CHC-49154 LOUD SPEAKER UNIT (201-199)

Symbol Desig.	#	FUNCTION	DESCRIPTION	Mfr.	Mfr. Desig.	Hammarlund Mfg. Co. Dwg. or Part No.
STRUCTURAL PARTS						
A201		Speaker Cabinet	Fabricated Steel Black Finish	9		6259
NAME PLATES						
N201		Speaker Nameplate	Etched Aluminum	17		6294
TRANSFORMERS						
*T201		Speaker Coupling Transformer	5000 ohms to Voice Coil matching Trans. (with Shielded Cable)	11		6303
LOUD SPEAKERS						
LS201		Loud Speaker	Perm. Mag. Dynamic	11		6260

* Spare parts furnished refer to Table II for quantities.

Symbol part designation if any.

MODEL RBG RADIO RECEIVING EQUIPMENT

14.3 TABLE II
SPARE PARTS LIST

MODELS RBG AND RBG-1 RADIO RECEIVING EQUIPMENTS

1. BULK SPARE PARTS—QUANTITY FURNISHED PER EACH 10 EQUIPMENTS

Quantity	Hammarlund Part No.	All Symbol Designations Involved	Description
TRANSFORMERS			
1	6251	T102	AF output transformer
1	6303	T201	Speaker coupling transformer
1	6252	T101	Power transformer (for Model RBG only)
1	6301	T101	Power transformer (for Model RBG-1 only)
1	6253	L124, 125	Filter reactor
IF TRANSFORMERS			
2	6289	Z101, 103	IF transformer assembly
1	SA-766	Z104	IF transformer assembly
1	SA-767	Z105	IF transformer assembly
2. SPARE PARTS— QUANTITY FURNISHED PER EACH RECEIVER			
FUSES			
1	6065	F101	1½ Amp. fuse
VACUUM TUBES			
4		V101, 103, 104, 105	6SK7
1		V102	6K8
1		V106	6H6
1		V107	6SJ7
1		V108	6C5
1		V109	6V6
1		V110	5U4G
1		V111	VR-105-30
RF TRANSFORMERS AND CHOKES			
1	SA-768	Z102	Crystal filter assembly (including quartz crystal)
1	6244	L123	RF choke (10 mh)
1	6181	L119, 120, 121, 122	RF chokes
CAPACITORS			
2	6254	C157, 158, 159, 160, 161	4 mfd paper fixed capacitor
1	6275	C156	2 x .1 paper fixed capacitor
3	4891	C106, 107, 114, 122, 123, 132	3 x .05 paper fixed capacitor
1	6307	C139	.01 mfd 1000 VDCW paper capacitor
4	4886	C105, 112, 113, 121, 130, 131, 133, 138	.01 mfd molded mica fixed capacitor
6	6055	C140, 141, 142, 145, 146, 149, 150, 151, 152, 153, 154, 155, 156	4-30 mmf mica trimmer
1	6189	C118	1.5-5 mmf mica trimmer
1	6235	C144	1500 mmf molded mica fixed capacitor
1	6296	C147	988 mmf molded mica fixed capacitor
1	6061	C109	673 mmf molded mica fixed capacitor
2	6073	C103, 104, 137	600 mmf molded mica fixed capacitor
1	6295	C148	375 mmf molded mica fixed capacitor
2	6172	C116, 117	100 mmf molded mica fixed capacitor
1	6151	C128	5½ mmf molded mica fixed capacitor

MODEL RBG RADIO RECEIVING EQUIPMENT

14.3 TABLE II—(Continued)

Quantity	Hammarlund Part No.	All Symbol Designations Involved	Description
RESISTORS			
1	6249	R132	AF gain control 250000 ohms
1	6250	R127	Sensitivity control 5000 ohms
1	6276	R142	4000 ohm 5 watt resistor
1	6270	R141	5000 ohm 5 watt resistor
1	6278	R140	280 ohm 1 watt resistor
1	6166	R121	50000 ohm 1 watt resistor
1	3804	R126	60000 ohm 1 watt resistor
1	6209	R138	25000 ohm 1 watt resistor
1	4812	R128	100 ohm 1/2 watt resistor
1	6156	R105	230 ohm 1/2 watt resistor
1	6169	R116, 120	300 ohm 1/2 watt resistor
1	3807	R137	600 ohm 1/2 watt resistor
1	6279	R104, 107	1000 ohm 1/2 watt resistor
5	6160	R103, 106, 110, 111, 112, 117, 118, 119, 122	2000 ohm 1/2 watt resistor
1	6292	R134	3300 ohm 1/2 watt resistor
2	6165	R102, 109, 113, 136	10000 ohm 1/2 watt resistor
1	6075	R108, 123	50000 ohm 1/2 watt resistor
1	3812	R135, 139	200000 ohm 1/2 watt resistor
1	6280	R124, 130	270000 ohm 1/2 watt resistor
1	6293	R131	820000 ohm 1/2 watt resistor
1	6167	R101, 125	1000000 ohm 1/2 watt resistor
1	4920	R129	2000000 ohm 1/2 watt resistor
SWITCHES			
1	6098	S110	"Send-Receive" switch
1	6241	S108	Limiter switch
1	6216	S109	MAN-AVC-BFO switch
1	6217	S101	Switch wafer
1	6218	S103, 104	Switch wafer
1	6219	S105, 106	Switch wafer
1	6220	S102	Switch wafer
TUBE SOCKETS			
2	6265	X101, 102, 103, 104, 105, 106, 107, 108, 109, 110, 111	Ceramic tube sockets
JACKS			
1	6255	J101	Phone jack
INDICATORS			
3	6036	I101, 102, 103	Dial lamps
METERS			
1	4903	M101	Tuning meter

MODEL RBG RADIO RECEIVING EQUIPMENT

14.4 RMA COLOR CODE FOR RESISTORS

Color	1st. Band	2nd. Band	3rd. Band
Black	—	0	—
Brown	1	1	0
Red	2	2	00
Orange	3	3	000
Yellow	4	4	0000
Green	5	5	00000
Blue	6	6	000000
Purple	7	7	0000000
Gray	8	8	00000000
White	9	9	—

1ST. BAND denotes first numeral in resistance value.
 2ND. BAND denotes second numeral.
 3RD. BAND denotes number of ciphers following first two numerals.
 GOLD BAND indicates 5 per cent tolerance.
 SILVER BAND indicates 10 per cent tolerance.

14.5 LIST OF MANUFACTURERS

Code No.	Name	Address
1	American Phenolic Corp.	Chicago, Ill.
2	Atlantic India Rubber Co.	Chicago, Ill.
3	Beede Elect. Inst. Co.	Penacock, N. H.
4	Bussman Mfg. Co.	New York, N. Y.
5	Chicago Transformer Corp.	Chicago, Ill.
6	Cornell-Dubilier Elect. Corp.	South Plainfield, N. J.
7	Harry Davies Co.	Chicago, Ill.
8	General Elect. Co. (Mazda)	Cleveland, Ohio
9	Hammarlund Mfg. Co., Inc.	New York, N. Y.
10	International Resistance Co.	Philadelphia, Pa.
11	Jensen Radio Mfg. Co.	Chicago, Ill.
12	Howard B. Jones	Chicago, Ill.
13	Karp Metal Products Co.	Brooklyn, N. Y.
14	Kurz Kasch Co.	Dayton, Ohio
15	Lord Mfg. Co.	Erie, Pa.
16	P. R. Mallory & Co., Inc.	Indianapolis, Ind.
17	Metal Etching Corp.	Brooklyn, N. Y.
18	National Co., Inc.	Malden, Mass.
19	National Lock Co.	Rockford, Ill.
20	Oak Mfg. Co.	Chicago, Ill.
21	R. C. A. Mfg. Co.	Harrison, N. J.
22	R. C. A. Mfg. Co.	Camden, N. J.
23	F. W. Sickles	Springfield, Mass.
24	Erie Resistor Corp.	Erie, Pa.
25	Sprague Specialties Co.	North Adams, Mass.
26	Weston Elect. Inst. Corp.	Newark, N. J.
27	Belden Mfg. Co.	Chicago, Ill.
28	Littlefuse Inc.	Chicago, Ill.

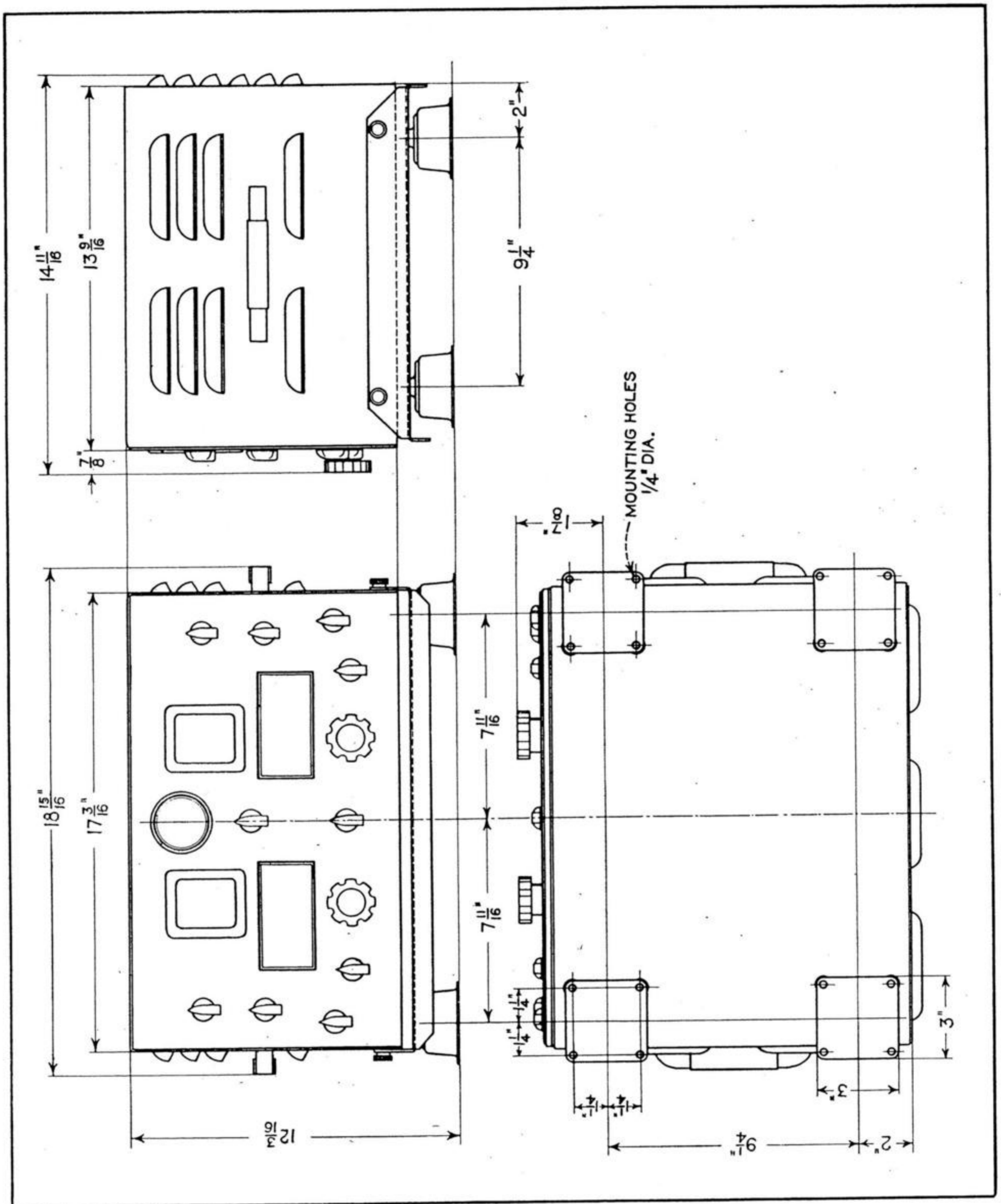

Fig. 8. Outline—Receiver

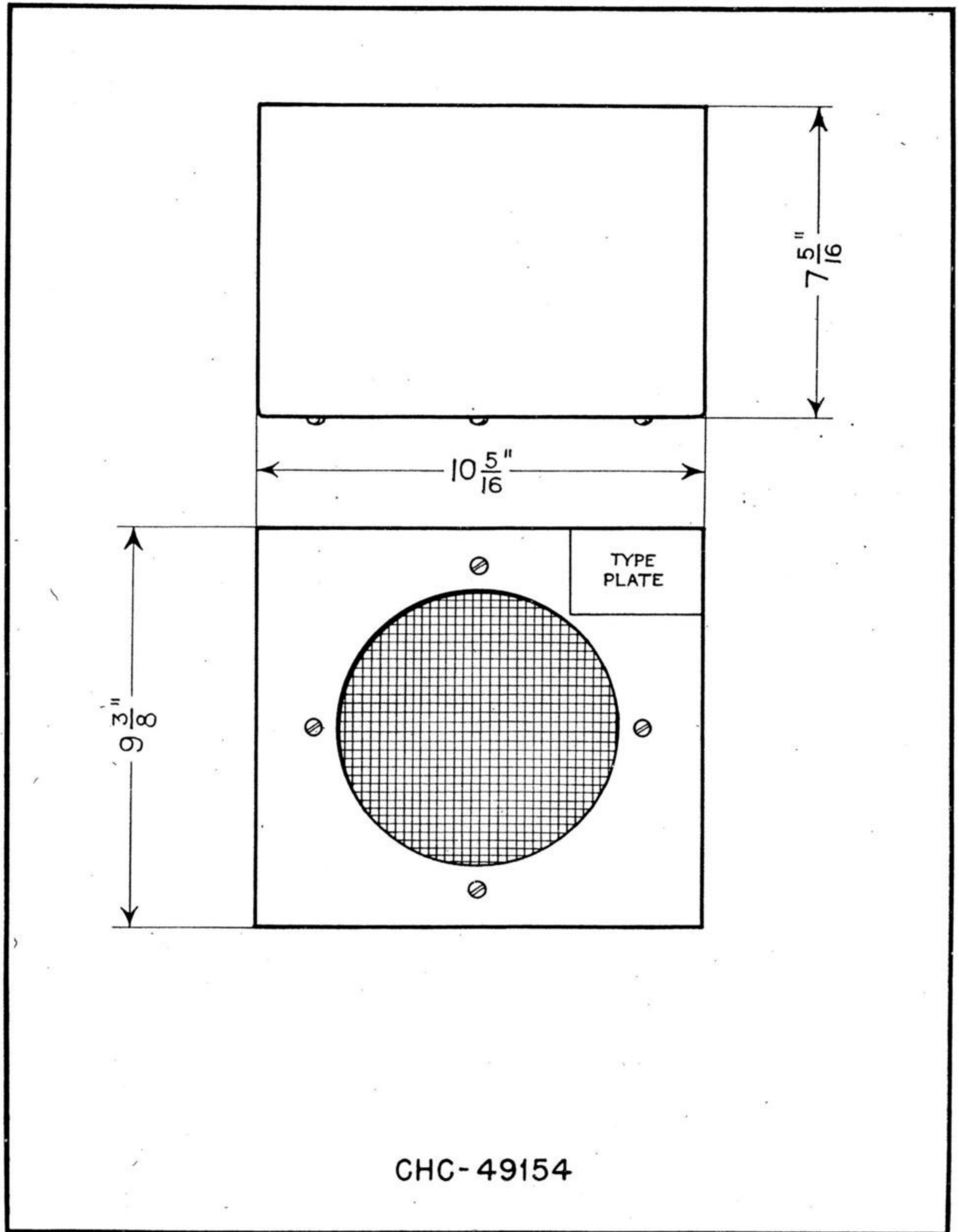

Fig. 9. Outline—Speaker

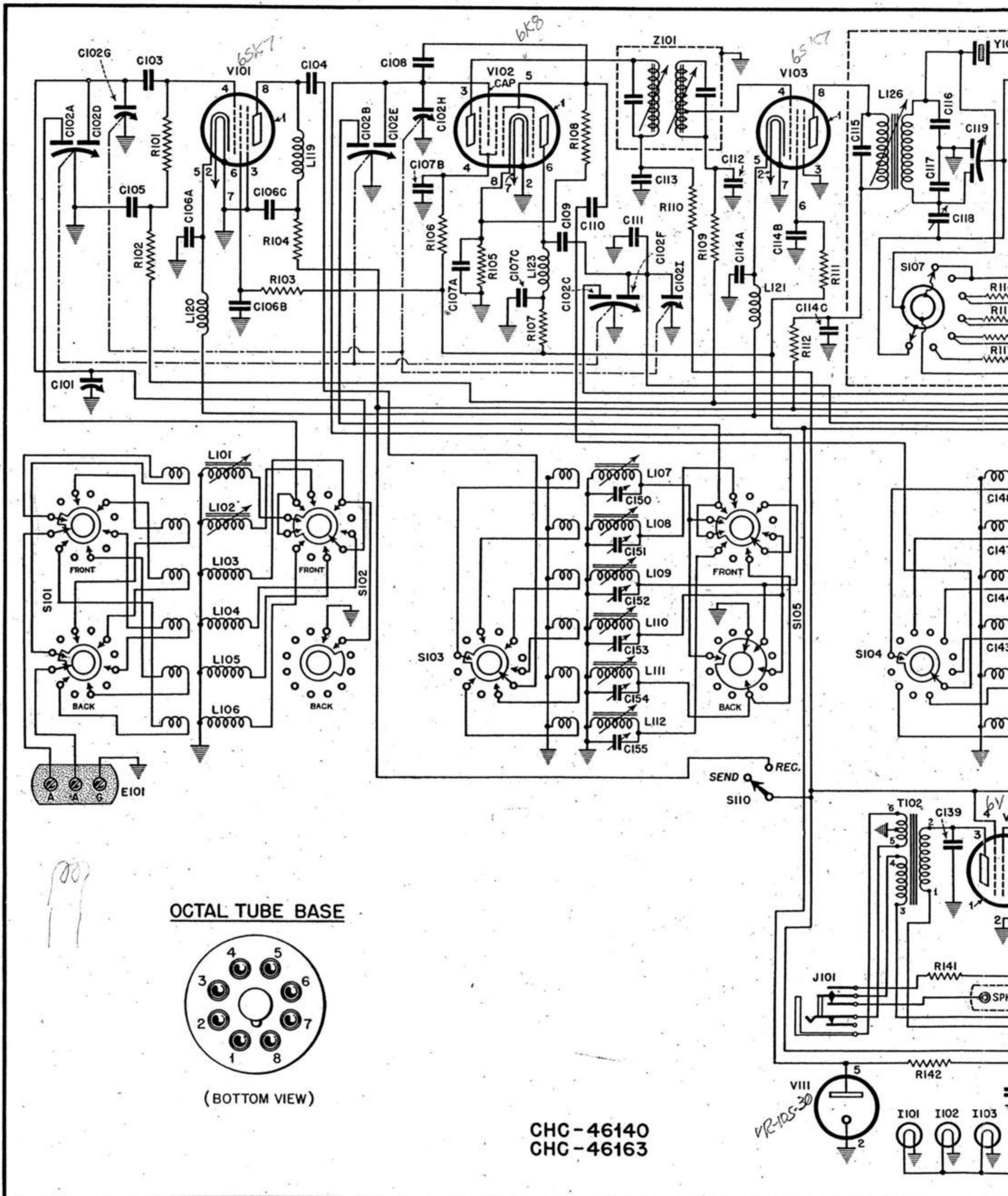
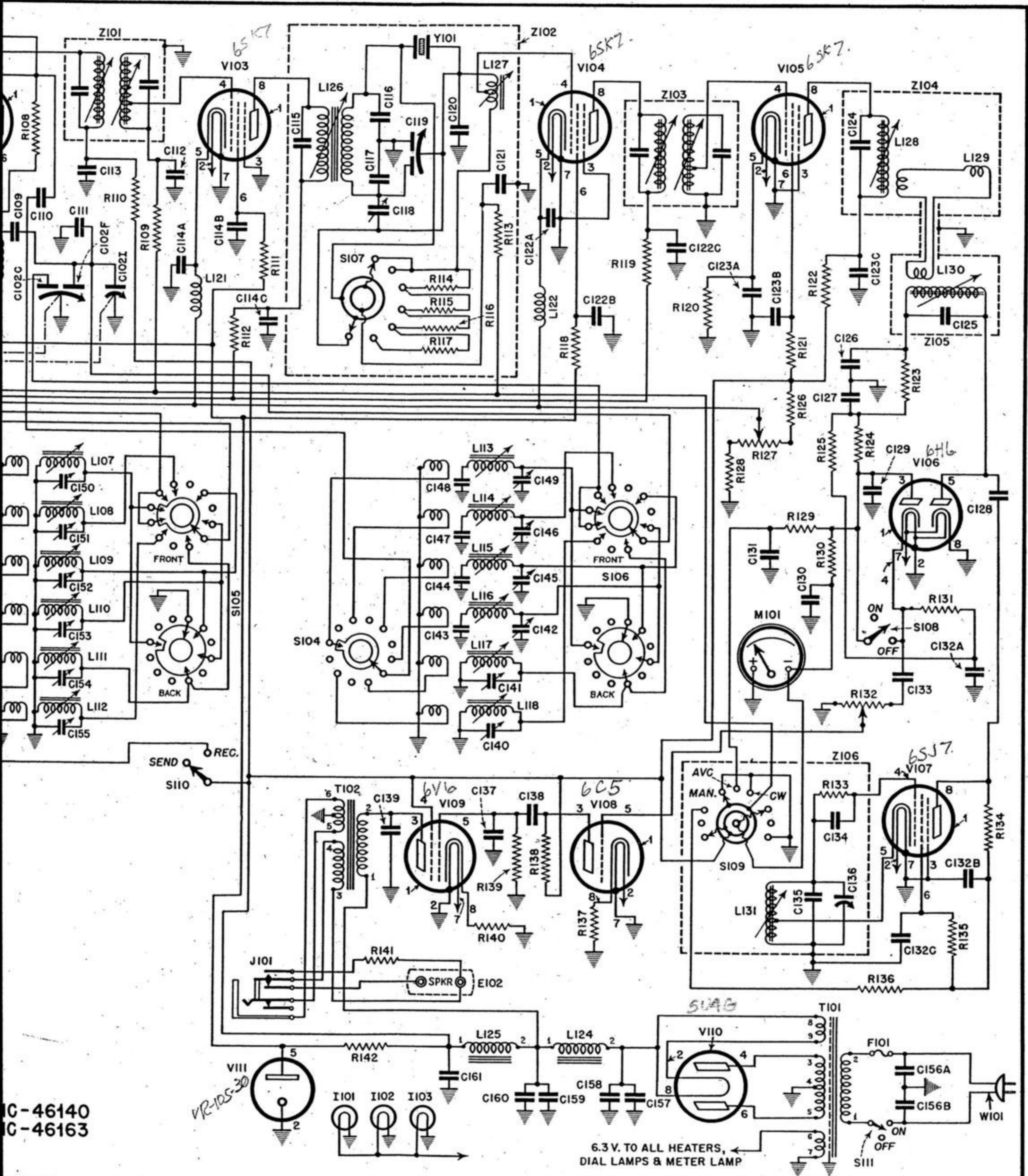

Fig. 10. Circuit Diagram—Receiver

MODEL RBG RADIO RECEIVING EQUIPMENT



IC-46140
IC-46163

Fig. 10. Circuit Diagram—Receiver

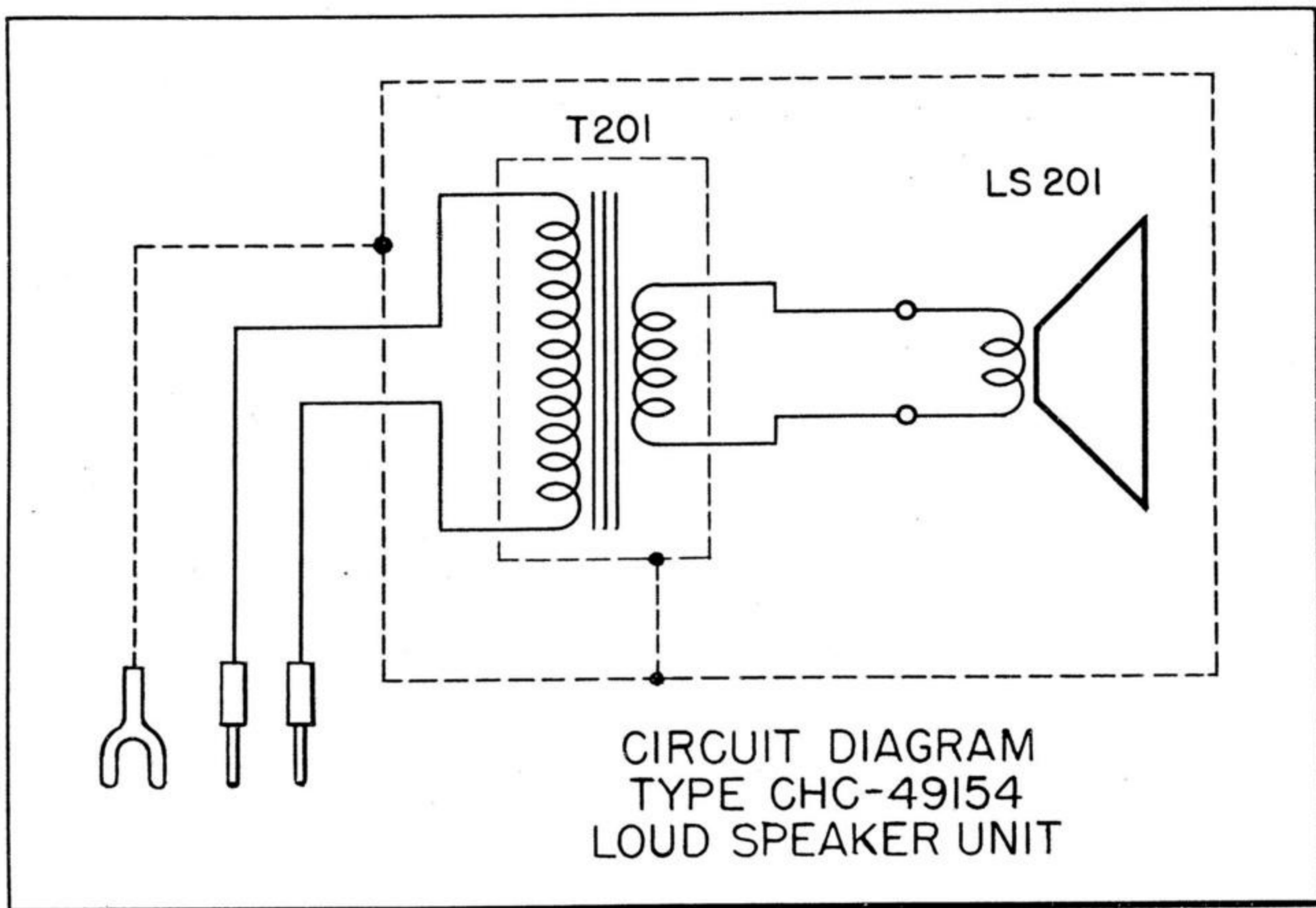

Fig. 11. Circuit Diagram—Speaker

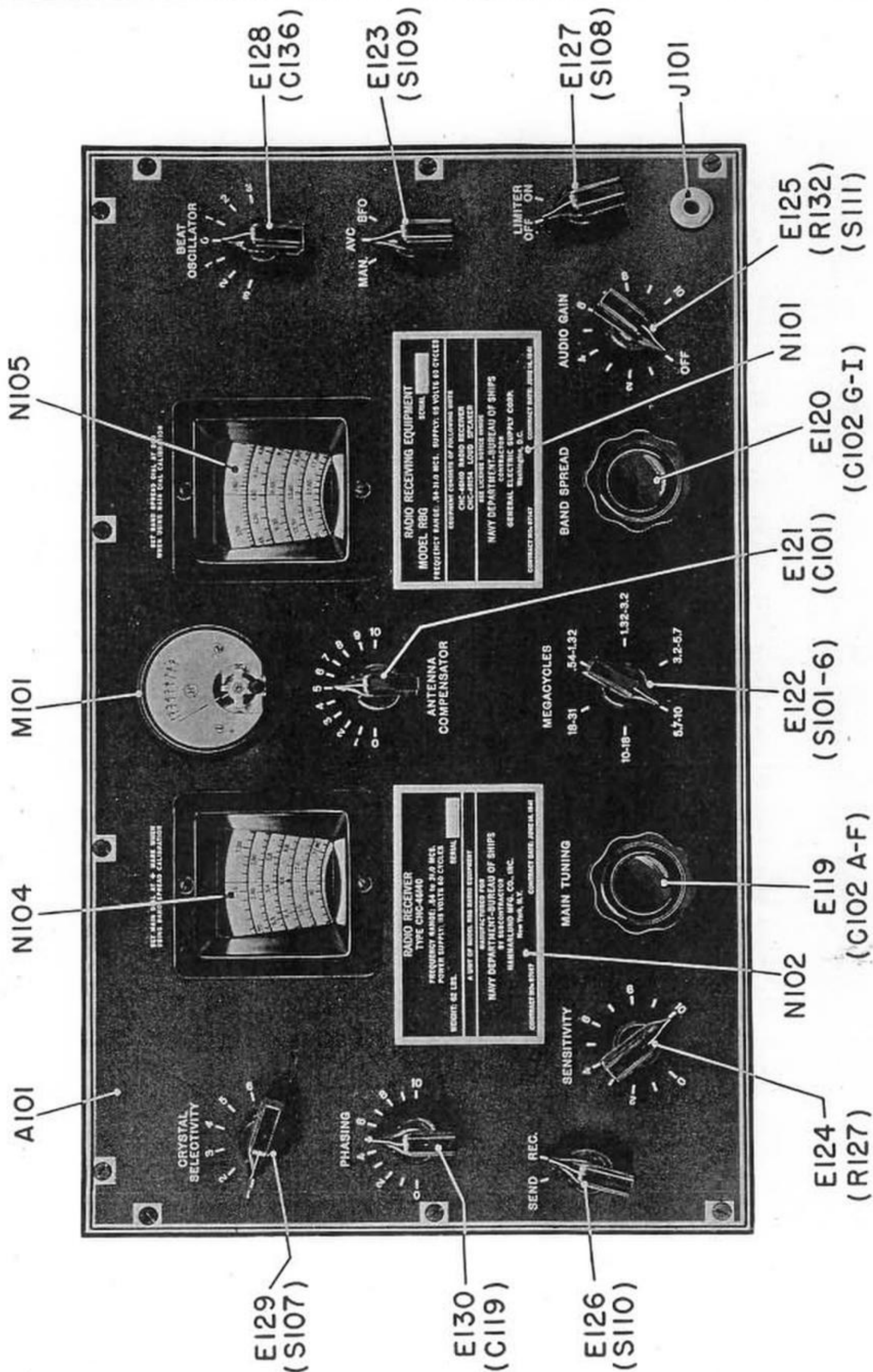

Fig. 12. Front View of Receiver

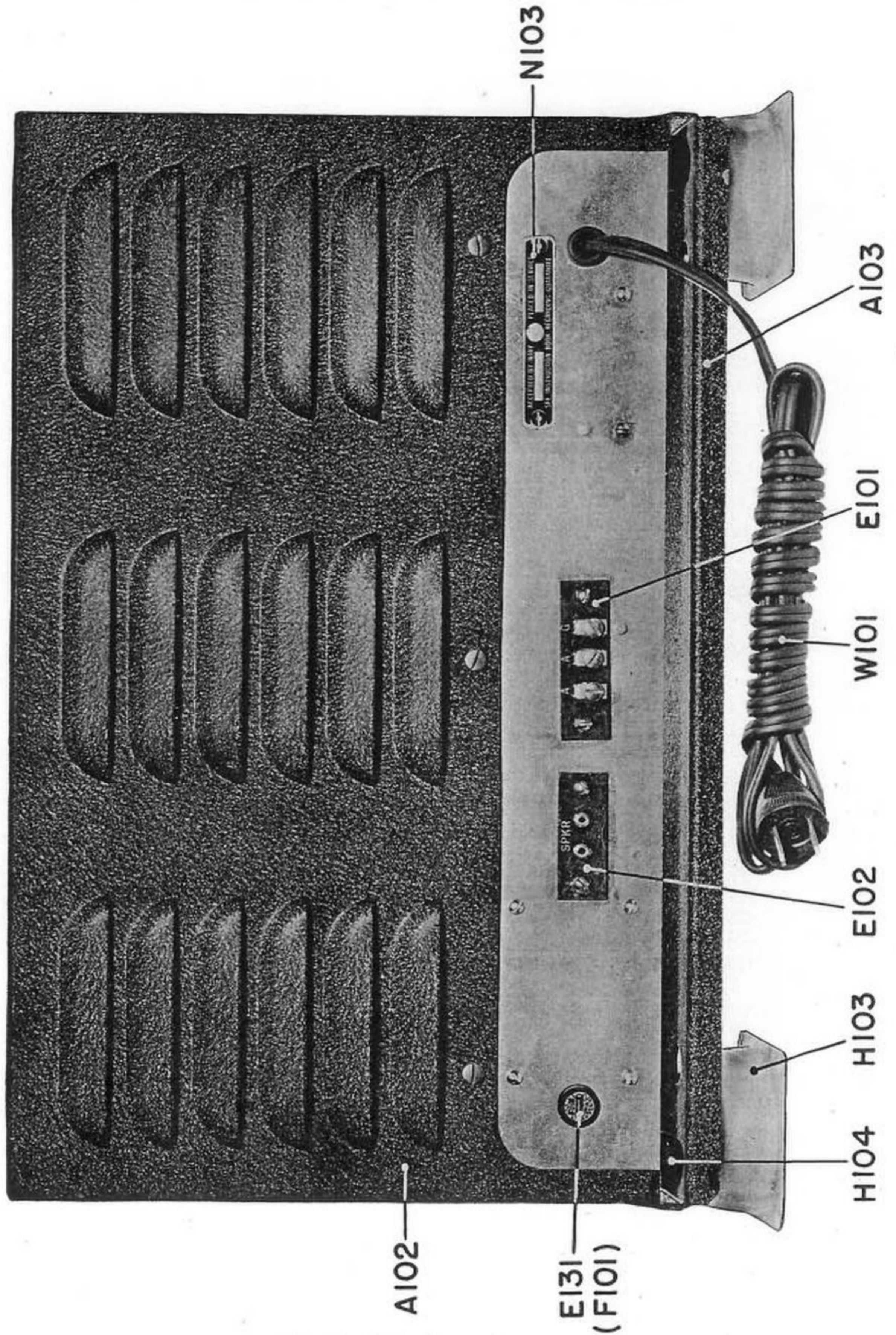

Fig. 13. Rear View of Receiver

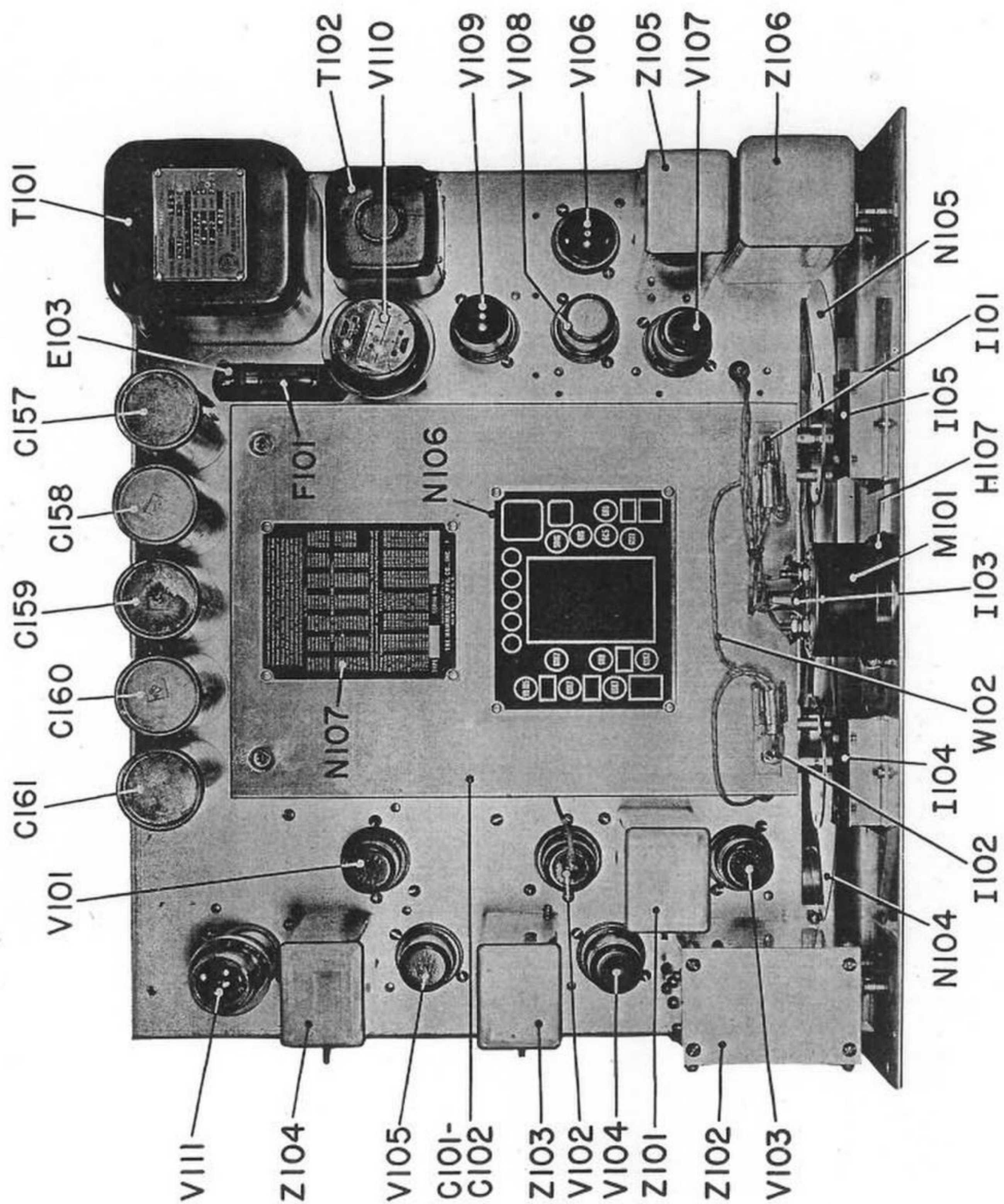

Fig. 14. Top View of Receiver

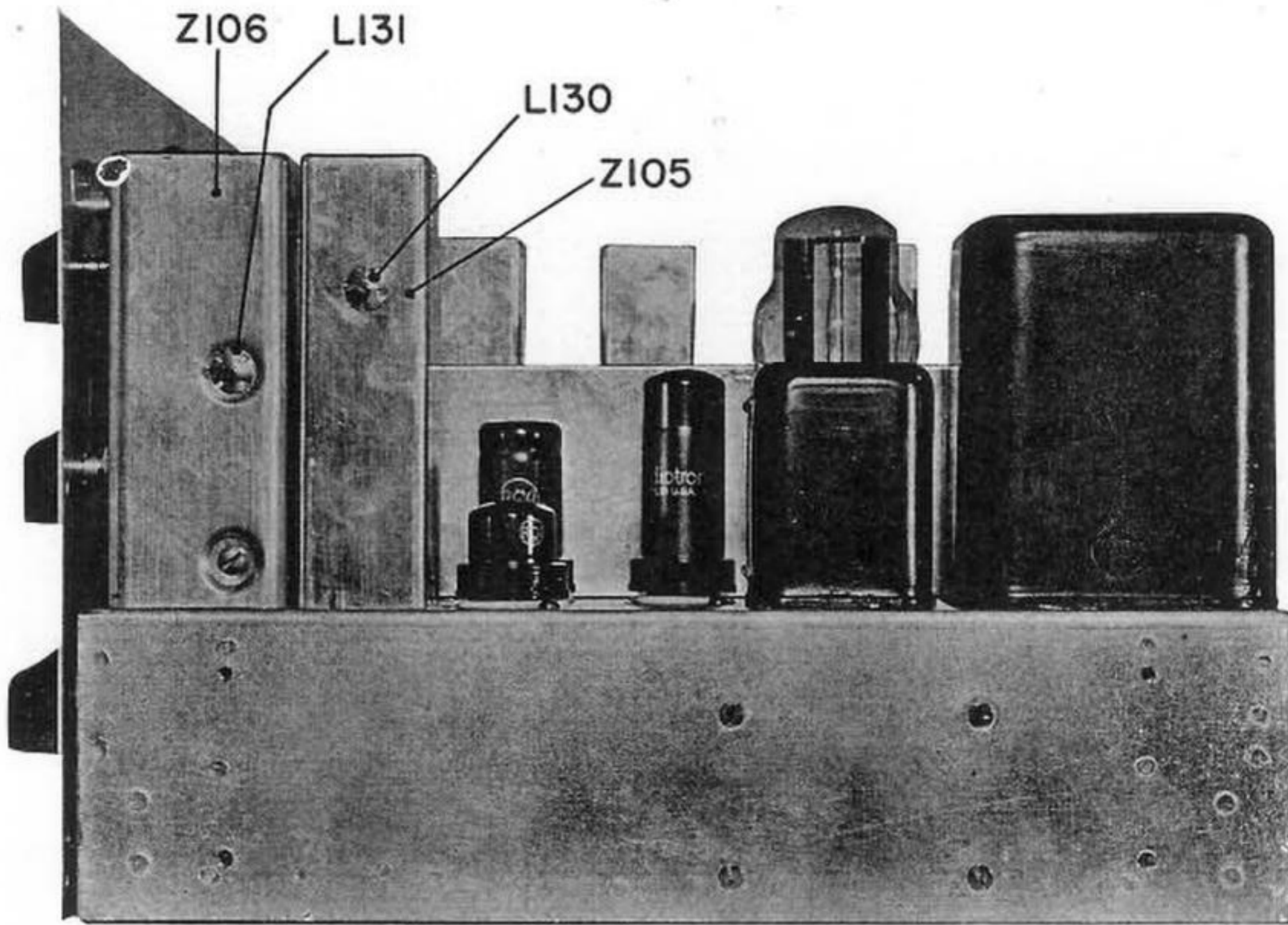

Fig. 15. Right End View of Receiver

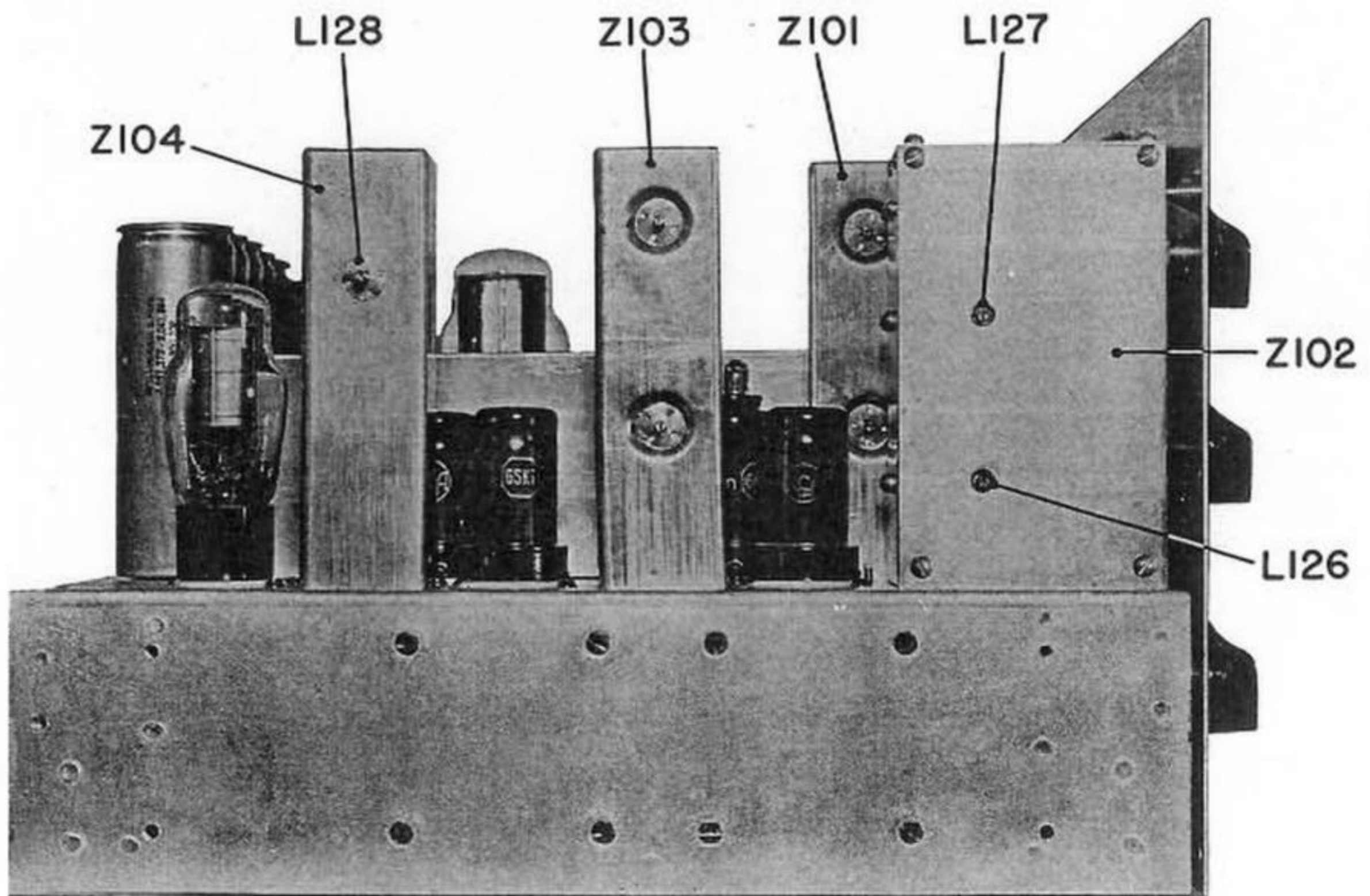
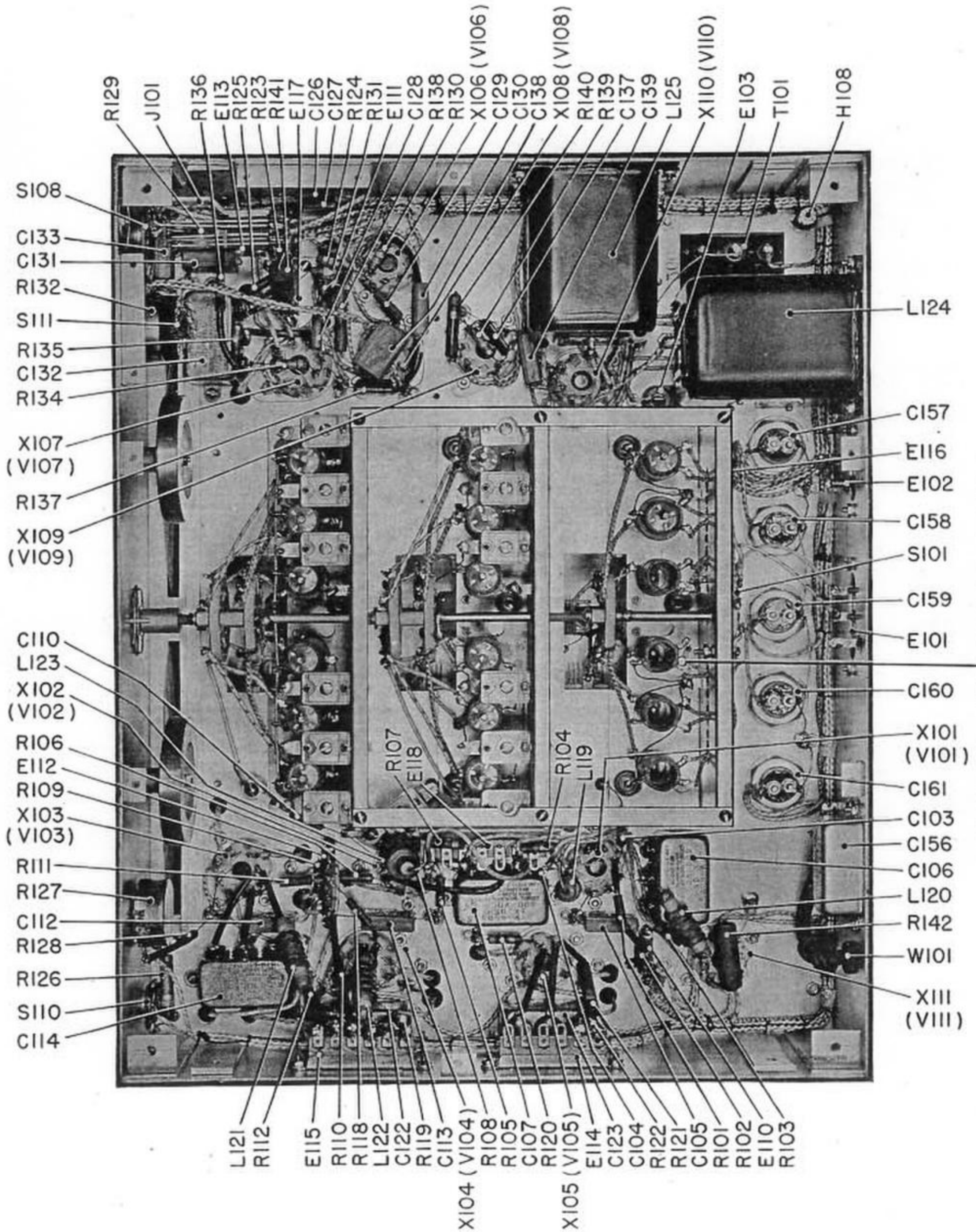

Fig. 16. Left End View of Receiver



FOR R.F. COIL ASSEMBLY SEE FIG. 18

Fig. 17. Bottom View of Receiver

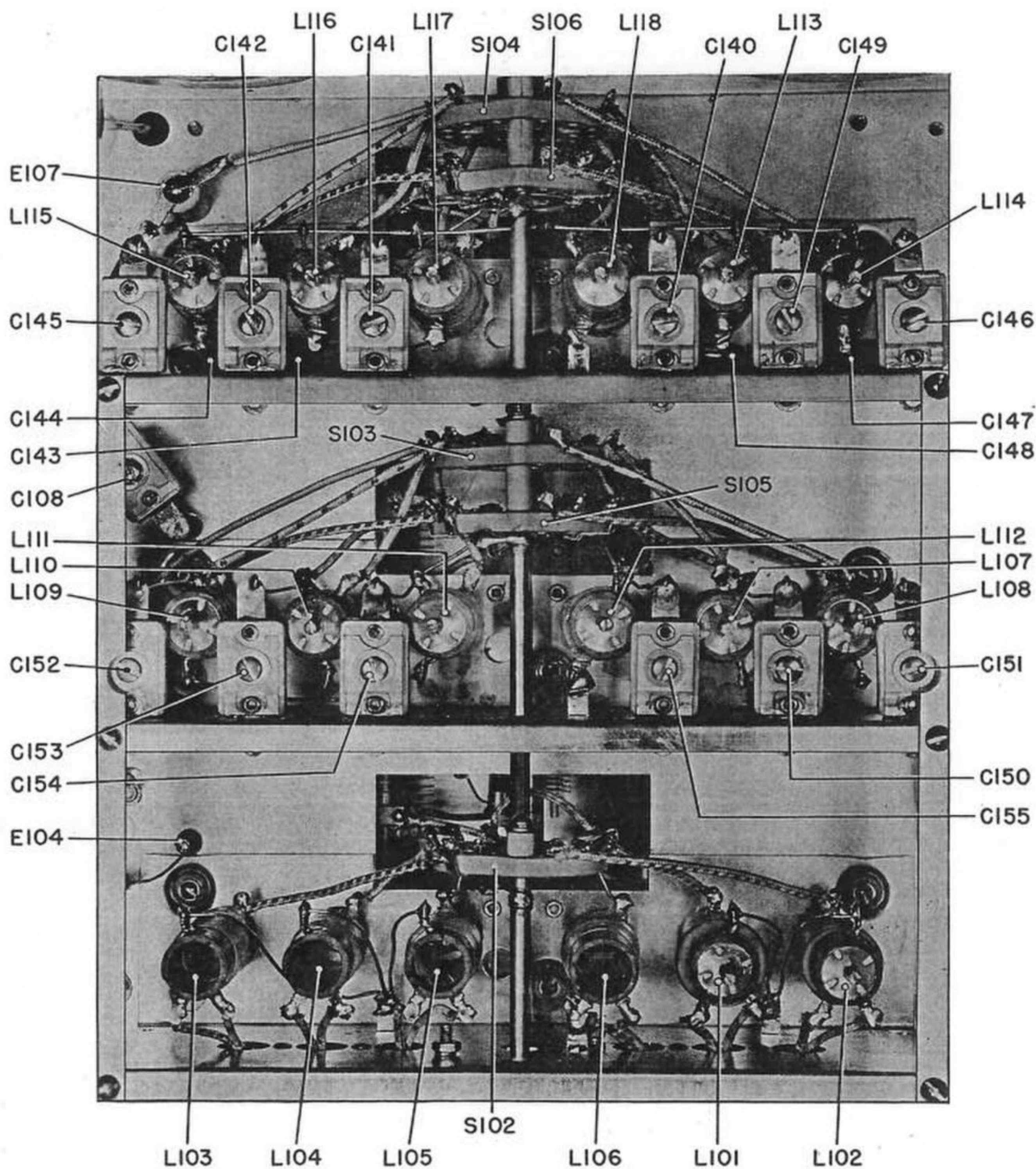

Fig. 18. RF and HF Osc. Coil Assembly

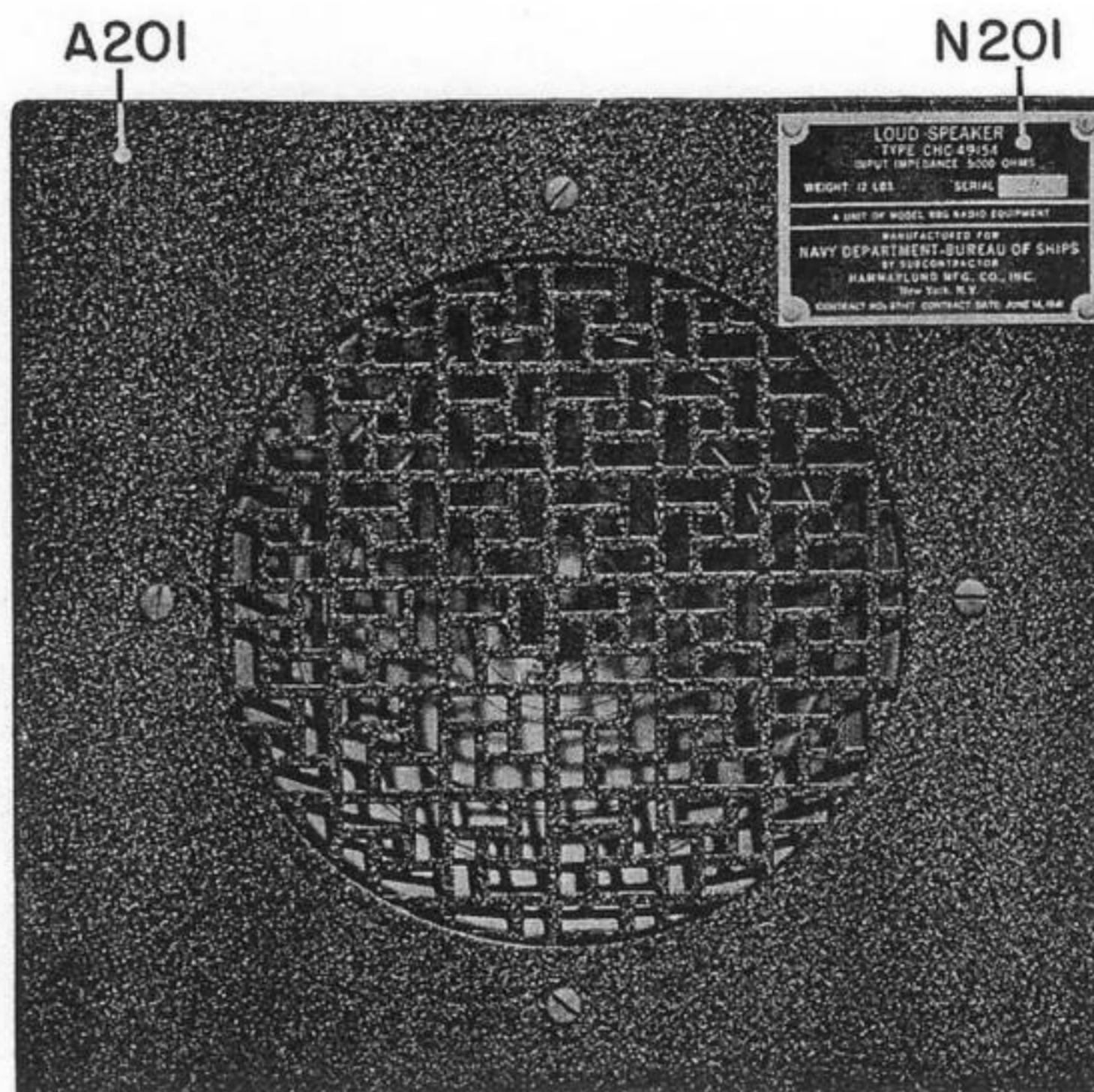

Fig. 19. Front View of Speaker

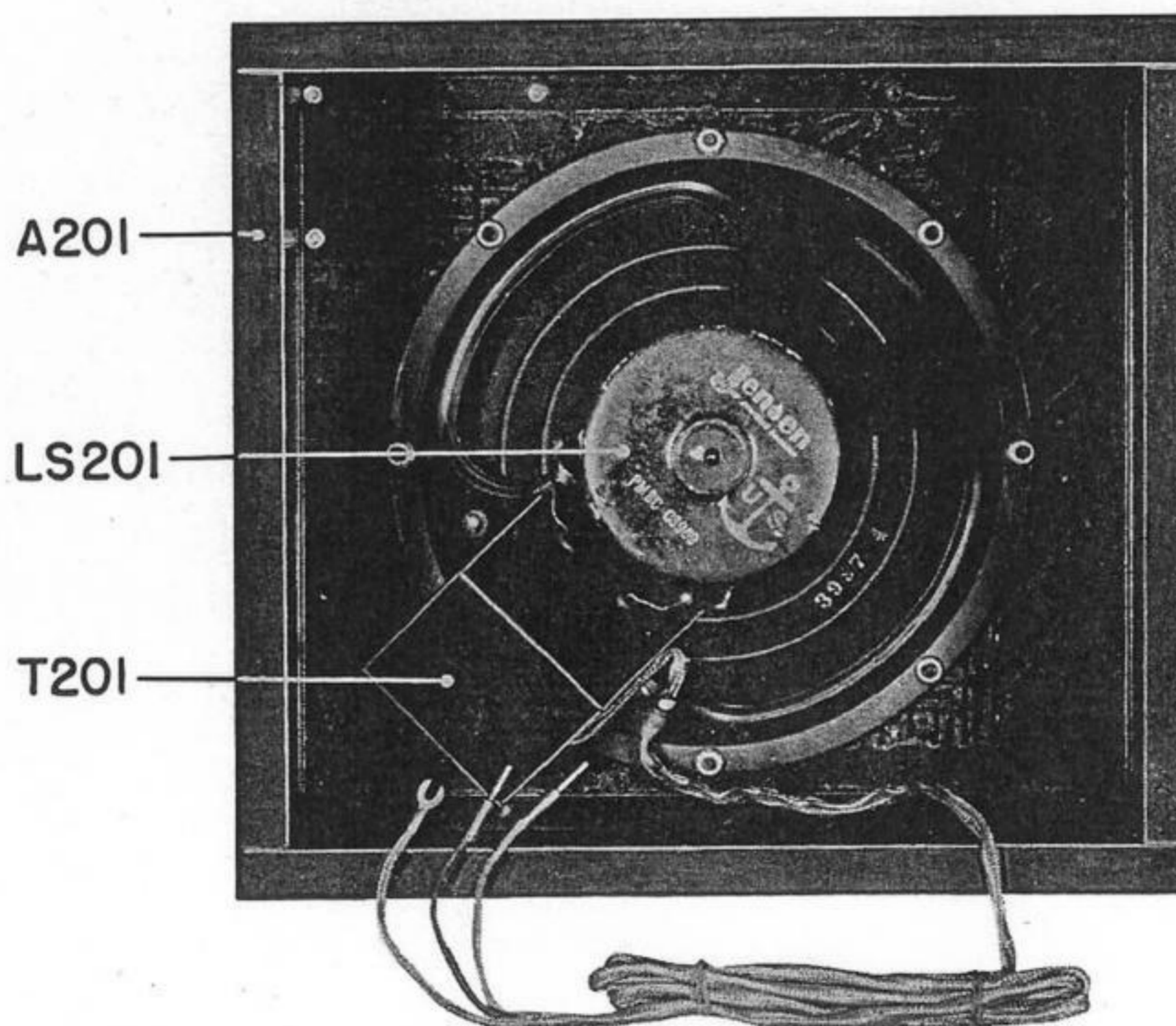

Fig. 20. Rear View of Speaker