

TM 11-5820-348-15

DEPARTMENT OF THE ARMY TECHNICAL MANUAL

**ORGANIZATIONAL, DIRECT SUPPORT, GENERAL SUPPORT
AND DEPOT MAINTENANCE MANUAL
ANTENNA EQUIPMENT RC-292**

(NSN 5985-00-497-8554)

This copy is a reprint which includes current
pages from Changes 2 through 7.

**HEADQUARTERS, DEPARTMENT OF THE ARMY
23 MAY 1966**

CHANGE

No. 7

HEADQUARTERS
DEPARTMENT OF THE ARMY
WASHINGTON, DC, 1 January 1989

**ORGANIZATIONAL, DIRECT SUPPORT, GENERAL SUPPORT, AND DEPOT MAINTENANCE
MANUAL
ANTENNA EQUIPMENT RC-292
(NSN 5985-00-497-8554)**

TM 11-5820-348-15, 23 May 1966, is changed as follows:

1. Remove old pages and insert new pages as indicated below. New or changed material is indicated by a vertical bar in the margin of the page. Added or revised illustrations are indicated by a vertical bar adjacent to the identification number.

Remove pages

None
1-1 and 1-2
2-2.1 and 2-2.2
2-13 and 2-14
3-1 and 3-2
4-1 and 4-2
A1-1 and A1-2

Insert pages

C/(D blank)
1-1 and 1-2
2-2.1 and 2-2.2
2-13 and 2-14
3-1 and 3-2
4-1 and 4-2
A1-1 and A1-2

2. File this change sheet in front of the publication for reference purposes.

Distribution authorized to the Department of Defense and DOD contractors only for official use or for administration or operational purposes. This determination was made on 5 July 1988. Other request for this document will be referred to Commander, US Army Communications-Electronics Command and Fort Monmouth, ATTN: AMSEL-LC-ME-P, Fort Monmouth, NJ 07703-5000.

DESTRUCTION NOTICE - Destroy by any method that will prevent disclosure of contents or reconstruction of the document.

By Order of the Secretary of the Army:

CARL E. VUONO
General, United States Army
Chief of Staff

Official:

WILLIAM J. MEEHAN II
Brigadier General, United States Army
The Adjutant General

DISTRIBUTION:

To be distributed in accordance with DA Form 12-51 Operator, Unit
and DS/GS requirements for RC-292.

CHANGE

HEADQUARTERS
DEPARTMENT OF THE ARMY
Washington, DC, 15 May 1987

No. 6

**ORGANIZATIONAL, DIRECT SUPPORT, GENERAL SUPPORT, AND DEPOT MAINTENANCE
MANUAL
ANTENNA EQUIPMENT RC-292
(NSN 5985-00-497-8554)**

TM 11-5820-348-15, 23 May 1966, is changed as follows:

1. Remove old pages and insert new pages as indicated below. New or changed material is indicated by a vertical bar in the margin of the page. Added or revised illustrations are indicated by a vertical bar adjacent to the identification number.

Remove pages	Insert pages
A and B	A and B
2-1 and 2-2	2-1 and 2-2
2-2.1/(2-2.2 blank)	2-2 .1/(2-2.2 blank)

2. File this change sheet in the front of the publication for reference purposes.

Distribution authorized to the Department of Defense and DOD contractors only for official use or for administration or operational purposes. This determination was made on 15 January 1987. Other requests for this document will be referred to Commander, US Army Communications-Electronics Command and Fort Monmouth, ATTN: AMSEL-ME-P, Fort Monmouth, NJ 07703-5000.

By Order of the Secretary of the Army:

JOHN A. WICKHAM, JR.
General, United States Army
Chief of Staff

Official:

R.L. DILWORTH
Brigadier General, United States Army
The Adjutant General

DISTRIBUTION:

To be distributed in accordance with DA Form 12-51 literature requirements for RC-292.

FIXED OPERATION WITH LONG RANGE ANTENNAS

W A R N I N G

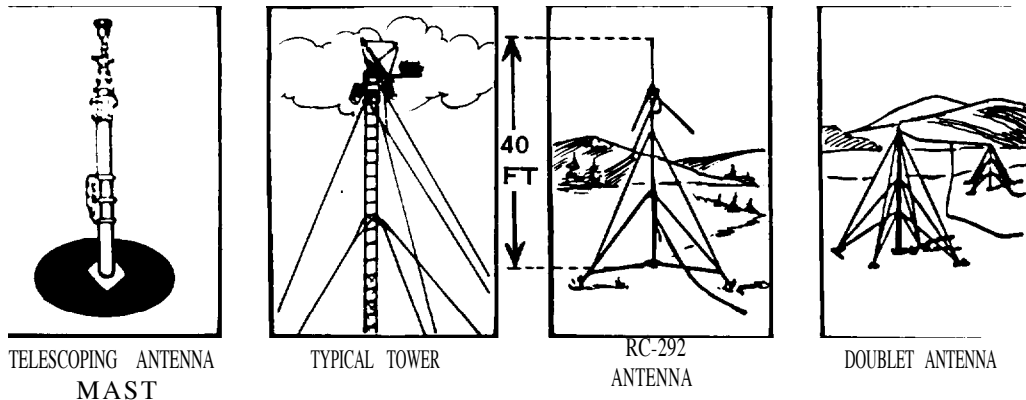

NEVER ERECT THESE LONG RANGE ANTENNAS DIRECTLY UNDER POWER LINES.

IF YOU MUST ERECT THESE LONG RANGE ANTENNAS NEAR POWERLINES, POWERLINE POLES OR TOWERS, OR BUILDINGS WITH OVERHEAD POWERLINE CONNECTIONS, NEVER PUT THE ANTENNA CLOSER THAN TWO TIMES THE ANTENNA HEIGHT FROM THE BASE OF THE POWERLINE, POLE, TOWER OR BUILDINGS. RC-292 80 FT. FROM BASE OF POWERLINE.

NEVER ATTEMPT TO ERECT ANY LONG RANGE ANTENNA WITHOUT A FULL TEAM.

BEFORE ERECTING ANY LONG RANGE ANTENNA, INSPECT ALL THE PARTS MAKING UP THE ANTENNA KIT. DO NOT ERECT THE ANTENNA IF ANY PARTS ARE MISSING OR DAMAGED.

DO AS MUCH OF THE ASSEMBLY WORK AS POSSIBLE ON THE GROUND.

WHEN ERECTING THE ANTENNA, ALLOW ONLY TEAM PERSONNEL IN THE ERECTION AREA.

MAKE SURE THAT THE AREA FOR THE ANCHORS IS FIRM. IF THE GROUND IS MARSHY OR SANDY, GET SPECIFIC INSTRUCTIONS FROM YOUR CREW CHIEF OR SUPERVISOR ON HOW TO REINFORCE THE ANCHORS.

WHEN SELECTING LOCATIONS FOR ANCHORS, AVOID TRAVELED AREAS AND ROADS. IF YOU CANNOT AVOID THESE AREAS, GET SPECIFIC INSTRUCTIONS FROM YOUR SUPERVISOR AS TO WHAT CLEARANCE YOUR GUY WIRES AND ROPES MUST HAVE OVER THE TRAVELED AREAS AND ROAD.

CLEARLY MARK ALL GUY WIRES AND ROPES WITH THE WARNING FLAGS OR SIGNS SUPPLIED BY YOUR UNIT. IN AN EMERGENCY, USE STRIPS OF WHITE CLOTH AS WARNING STREAMERS.

IF YOU SUSPECT THAT POWERLINES HAVE MADE ACCIDENTAL CONTACT WITH YOUR ANTENNA, STOP OPERATING, ROPE OFF THE ANTENNA AREA, AND NOTIFY YOUR SUPERIORS.

IF THE WEATHER IN YOUR AREA CAN CAUSE ICE TO FORM ON YOUR LONG RANGE ANTENNA AND ITS GUY WIRES AND ROPES, ADD EXTRA GUYS TO SUPPORT THE SYSTEM. ROPE OFF THE AREA AND POST IT WITH WARNING SIGNS LIKE "BEWARE OF FALLING ICE."

DO NOT TRY TO ERECT ANY ANTENNA DURING AN ELECTRICAL STORM.

KEEP A SHARP EYE ON YOUR ANCHORS AND GUYS. CHECK THEM DAILY AND IMMEDIATELY BEFORE AND AFTER BAD WEATHER.



5

SAFETY STEPS TO FOLLOW IF SOMEONE IS THE VICTIM OF ELECTRICAL SHOCK

1

DO NOT TRY TO PULL OR GRAB THE INDIVIDUAL

2

IF POSSIBLE, TURN OFF THE ELECTRICAL POWER

3

IF YOU CANNOT TURN OFF THE ELECTRICAL POWER, PULL, PUSH, OR LIFT THE PERSON TO SAFETY USING A DRY WOODEN POLE OR A DRY ROPE OR SOME OTHER INSULATING MATERIAL

4

SEND FOR HELP AS SOON AS POSSIBLE

5

AFTER THE INJURED PERSON IS FREE OF CONTACT WITH THE SOURCE OF ELECTRICAL SHOCK, MOVE THE PERSON A SHORT DISTANCE AWAY AND IMMEDIATELY START ARTIFICIAL RESUSCITATION

WARNING

HELMET LINER, SAFETY GLASSES AND GLOVES MUST BE WORN BEFORE ASSEMBLING AND ERECTING THE RC-292.

WARNING

A hazardous condition exists during antenna erection and disassembly. Fatal injuries have been attributed to the pointed ends of the exposed antenna elements. Take the following precautions:

Attach antenna tip cap (NSN 5965-00-930-7223 or equivalent) to all exposed elements of the RC-292. Secure the tip caps with waterproof tape (NSN 5870-00-419-4291 or equivalent.)

Until the antenna tip caps have been installed place a warning signal (Chem light, guard or other signal) near the antenna elements during assembly, disassembly or when the antenna elements are within reach, particularly at night.

Remove the antenna elements if the antenna is lowered and unattended.

**Organizational, Direct Support, General Support,
and Depot Maintenance Manual**

ANTENNA EQUIPMENT RC-292 (NSN 5895-00-497-8554)

		Paragraph	Page
CHAPTER 1.	INTRODUCTION		
SECTION I.	General		
	Scope	1-1	1-1
	Indexes of publications	1-2	1-1
	Forms and records	1-3	1-1
	Reporting of errors	1-3.1	1-1
	Reporting equipment improvement recommendations (EIR)	1-3.2	1-1
	Administrative storage	1-3.3	1-1
	Destruction of Army electronics materiel.....	1-3.4	1-2
II.	Description and data		
	Purpose and use.....	1-4	1-2
	Technical characteristics	1-5	1-2
	Items comprising an operable equipment.	1-6	1-2
	Running spares	1-7	1-3
	Description of Antenna Equipment RC-292	1-8	1-3
CHAPTER 2.	INSTALLATION AND OPERATING INSTRUCTIONS		
SECTION I.	Service upon receipt of Antenna Equipment RC-292		
	Unpacking	2-1	2-1
	Checking unpacked equipment.	2-2	2-1
II.	Installation of Antenna Equipment RC-292		
	Siting.....	2-3	2-2
	Positioning baseplate and guy stakes.....	2-4	2-3
	Assembling Antenna Equipment RC-292.....	2-5	2-3
	Erection of antenna equipment by two men	2-6	2-4
	Erecting antenna in confined area	2-7	2-5
	Erection of antenna by one man.....	2-8	2-7
	Connection to radio set	2-9	2-8
	Lowering antenna	2-10	2-10
	Operation under unusual conditions	2-11	2-10
	Installing RC-292 on M577 Command Post	2-12	2-12
	Checking installed RC-292 using Test Set, RF Power AN/URM-182 or AN/URM-182A	2-13	2-14
CHAPTER 3.	OPERATOR/CREW MAINTENANCE		
	Scope of operator's maintenance.....	3-1	3-1
	Materials required	3-2	3-1
	Operator/crew preventive maintenance	3-3	3-1
	Preventive maintenance checks and services periods	3-4	3-1
	Cleaning.....	3-5	3-2
4.	ORGANIZATIONAL MAINTENANCE		
	Scope of organizational maintenance.....	4-1	4-1
	Test equipment, tools, and materials required.....	4-2	4-1
	Organizational preventive maintenance checks and services	4-3	4-1
	Touchup painting	4-4	4-2
	Troubleshooting and repair	4-5	4-2
5.	SHIPMENT AND LIMITED STORAGE		
	Disassembly of equipment	5-1	5-1
	Placing RC-292 in Roll CW-50/RC-7 for transportation.....	5-2	5-1
	Repacking for shipment or limited storage.....	5-3	5-1
APPENDIX I.	REFERENCES		A1-1
II.	BASIC ISSUE ITEMS LIST		A2-31
III.	MAINTENANCE ALLOCATION		A3-1

* This manual supersedes TM 11-5020, 5 May 1950, including all changes.

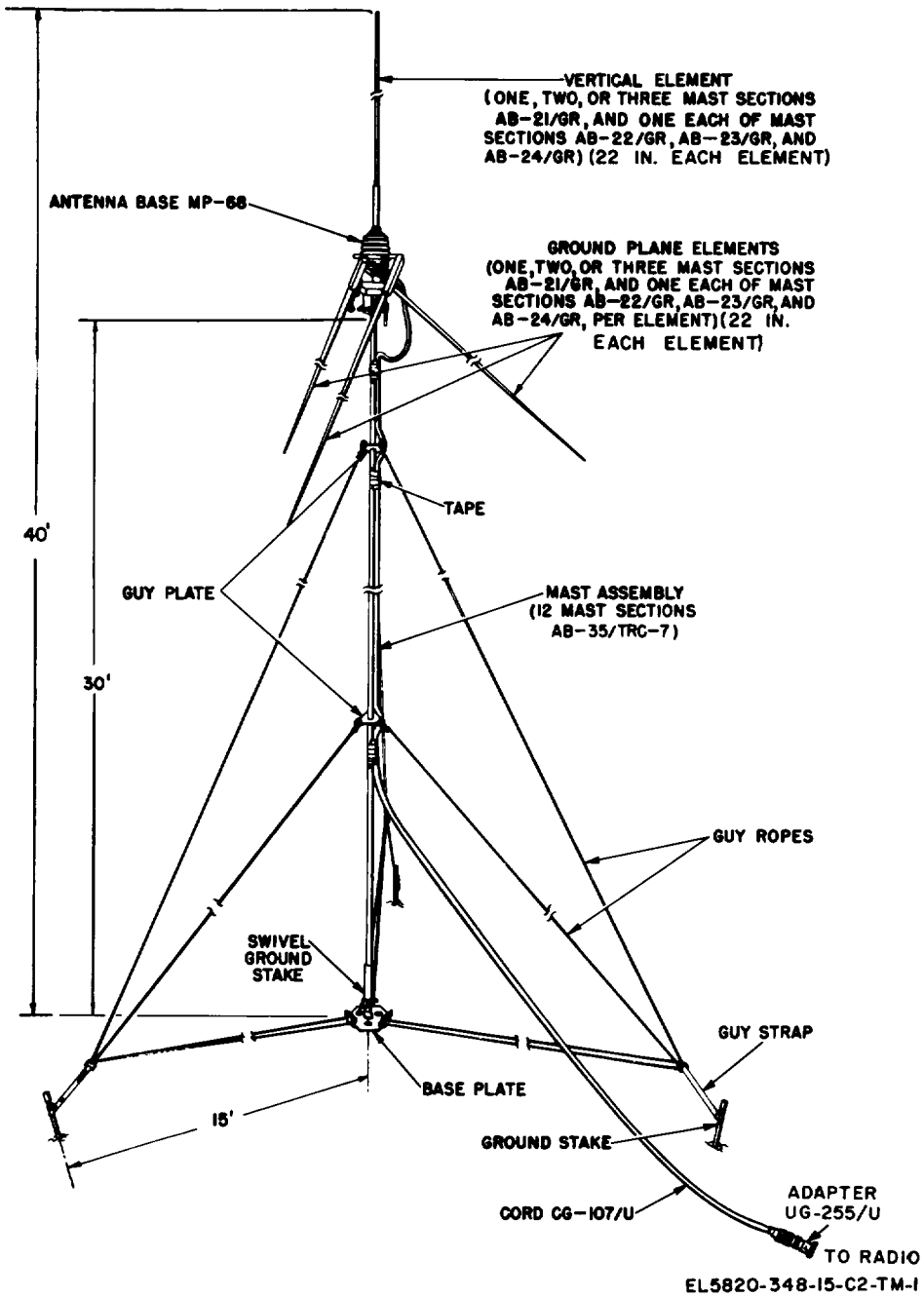

Figure 1-1. Antenna Equipment RC-292.

CHAPTER 1

INTRODUCTION

Section 1. General

1-1. Scope

a. This manual describes Antenna Equipment RC-292 (fig. 1-1) and provides instructions for installation, operation, and maintenance. It includes instructions for operation under usual and unusual conditions, cleaning, and inspection of the equipment, and replacement of parts available to the repair technician.

b. The maintenance allocation chart is provided in appendix 111.

c. Repair parts for the RC-292 are provided in TM 11-5820-348-24P.

1-2. Consolidated Index Of Army Publications And Blank Forms

Refer to the latest issue of DA Pam 25-30 to determine whether there are new editions, changes or additional publications pertaining to the equipment.

1-3. Maintenance Forms, Records And Reports

a. Reports of Maintenance and Unsatisfactory Equipment. Department of the Army forms and procedures used for equipment maintenance will be those prescribed by DA Pam 738-750, as contained in Maintenance Management Update.

b. Report of Item Packaging Discrepancies. Fill out and forward SF 364 (Report of Discrepancy [ROD]) as prescribed in AR 735-11-2/DLAR 4140.55/SECNAVINST 4355.18/AFR 400-54/MCO4430.3J.

c. Transportation Discrepancy Report (TDR) (SF 361). Fill out and forward Transportation Discrepancy Report (TDR) (SF 361) as prescribed in AR55-38/NAVSUPINST4610.33C/AFR75-18/MCO P4610.19D/DLAR 4500.15.

1-3.1 Reporting Errors and Recommending Improvements

You can help improve this manual. If you find any mistakes or if you know of a way to improve the procedures, please let us know. Mail your letter, or DA Form 2028 (Recommended Changes to Publications and Blank Forms) direct to: Commander, US Army Communications-Electronics Command and Fort Monmouth, ATTN: AMSEL-LC-ME-PS, Fort Monmouth, New Jersey 07703-5000.

1-3.2 Reporting Equipment improvement Recommendations (EIR)

If your equipment needs improvement, let us know. Send us an EIR. You, the user, are the only one who can tell us what you don't like about your equipment. Let us know why you don't like the design or performance. Put it on an SF 368 (Product Quality Deficiency Report). Mail it to: Commander, U.S. Army Communications-Electronics Command and Fort Monmouth, ATTN: AMSEL-PA-MA-D, Fort Monmouth, New Jersey, 07703-5000. We'll send you a reply.

1-3.3 Administrative Storage

Administrative storage of the RC-292 will be handled as follows: The requirements apply whether the antenna is stored with an associated radio, or stored alone.

a. Before and after storage, perform the following.

(1) Clean the unit (para 3-7) and spot-paint bare metal parts (para 4-5).

(2) Perform quarterly preventive maintenance.

nance checks and services (para 4-4). Correct all deficiencies.

b. Store in dry, moisturefree area. Records and reports shall be maintained as prescribed in DA Pam 738-750 for equipment in use.

1-3.4. Destruction of Army Electronics Materiel

Destruction of Army electronics materiel to prevent enemy use shall be in accordance with TM 750-244-2,

Section II. DESCRIPTION AND DATA

1-4. Purpose and Use

a. Antenna Equipment RC-292 (fig. 1-1) is an elevated, wide-band, modified ground-plane antenna designed to increase the distance range of radio sets in 30 to 76 mc range (b below).

b. The RC-292 can be used with the following typical radio sets:

(1) Radio Sets AN/VRC-12, AN/VRC-43 through AN/VRC-49 (TM 11 5820-401-12).

(2) Radio Sets AN/VRC-53, AN/VRC-64, AN/GRC-125, and AN/GRC-160 (TM 11-5820-498-12).

(3) Radio Sets AN/PRC-25 (TM 11-5820-398-12) and AN/PRC-77 (TM 11-5820-667-12).

1-5. Technical Characteristics

Frequency range 20 to 76 mc.
 Distance range between radio sets listed in paragraph 1-4b(1) and (2):
 (2):
 Between two RC-292s:
 Average terrain 36 miles
 Difficult terrain 30 miles
 Between RC-292 and vehicular whip antenna:
 Average terrain 25 miles
 Difficult terrain 20 miles
 Distance range between AN/PRC radio sets (para 1-4b(3)):
 Between two RC-292s 12 miles
 Between RC-292 and AN/PRC whip antenna 8 miles
 Antenna erection time (two men) 15 minutes
 Height (to tip of top element) 41½ feet maximum (20 to 28 mc range).
 37 feet minimum (52 to 76 mc range).
 Input impedance 50 ohms.
 Type of radiation pattern Nondirectional.

1-6. Items Comprising an Operable Equipment (Fig. 1-2)

The part number (e.g. SC-D-17306) is followed by 5-digit Federal supply catalogue code for man-

ufacturers (FSCM) (e.g. (17307)). The FMCSs are identified in SB 708-42. See appendix II (basic issue items list) for other RC-292 parts; see paragraph 2 of appendix II for other information.

Item	National stock No.	Quantity
Antenna Equipment RC-292; 5985-00-497-8554 consisting of:		
Adapter, Connector UG-255/U: 5935-00-149-3914 1		
SC-D-595553-1 (80063)		
Antenna Base MP-68: SC-D- 5985-00-049-8344 1		
17306 (80063)		
Cable Assembly, Radio Fre- 5995-00-129-3209 1		
quency CG-107A/U (68 ft, 3 in.)		
Guy rope assembly: (66 ft): SM- 5985-00-863-3707 6		
C-158347 (80063)		
Mast Base AB-154/U: SC-D 5820-00-240-8233 1		
28052 (80058)		
Mast Section AB-21/GR: SC-D 5820-00-228-0244 12		
13614 (80058)		
Mast Section AB-22/GR: SC-D- 5820-00-372-0970 4		
13614 (80058)		
Mast Section AB-23/GR: SC-D- 5820-00-190-4405 4		
13614 (80058)		
Mast Section AB-24/GR: SC-D- 5820-00-240-3720 4		
13614 (80058)		
Mast Section AB-35/TRC-7: SC- 5985-00-240-3723 12		
DL-158370 (80063)		
Plate, Base: SC-D-17262-1 5820-00-268-3776 1		
(80063)		
Plate, Guy: SC-D-17262-2 4030-00-228-6821 2		
(80063)		
Reel RL-28: SC-D-1064 (80063) 8130-00-355-7616 3		
Stake, GUY SC-C-34000 (80063) 4030-00-187-5263 4		
Strap assembly: SC-B-16844 5820-00-797-2420 3		
(80063)		
Adapter M-442 ^a : SC-D-17409 5820-00-609-5496 1		
(80063)		
Stake GP-101/U ^b (Arctic use) 4030-00-187-5265 3		

^aAdapter M-442 is required for adaption of CG-107A/U to certain receiver-transmitter units.

^bRequisition Stake GP-101/U for arctic use or similar soil conditions.

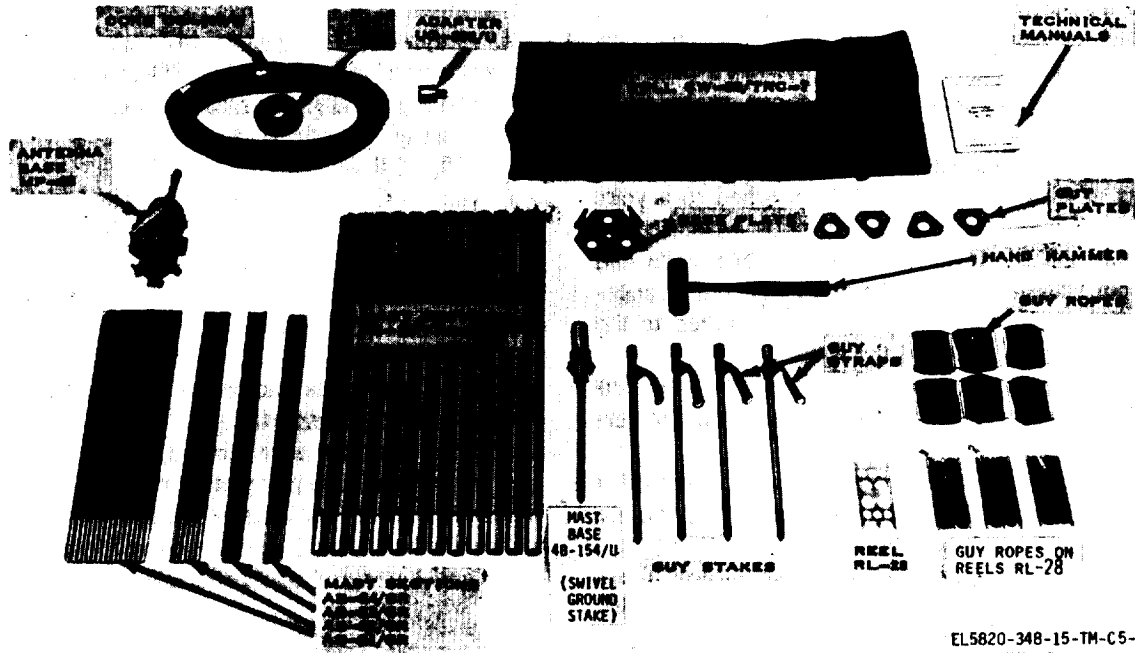

EL5820-348-15-TM-C5-1

Figure 1-2. Antenna Equipment RC-292, components and spare parts.

1-7. Running Spares

Item	Quantity
Adapter, Connector UG-255/U	1
Guy rope assembly	2
Mast Section AB-21/GR	4
Mast Section AB-22/GR	2
Mast Section AB-23/GR	2
Mast Section AB-24/GR	2
Plate, Guy	2
Reel RL-28	1
Stake, Guy	1
Strap assembly	1

1-8. Description of Antenna Equipment RC-292

(figs. 1-1 and 1-2)

The antenna consists of one vertical radiating element which makes an angle of 140 degrees with the vertical element. Antenna Base MP-68 mounts the four antenna elements and provides for connecting the antenna to the radio set by the CG-107/U. Twelve Mast Sections AB-35/TRC-7, joined together, form the 30-foot mast assembly for elevating the antenna above ground. The mast assembly is supported on Mast Base Assembly AB-154/U installed in the baseplate and is held in vertical position by 6 guy ropes. The lengths of the antenna elements are adjusted for different frequency ranges by

changing the number of mast sections which make up the antenna elements (para 2-5b). The swivel stake on which the mast is supported facilitates lowering of the antenna to make such changes. The equipment is designed for hand or vehicle transportation. When disassembled, it is packed in a canvas roll. The RC-292 may also be installed on the top of vehicles, such as M577 Command Post (fig. 2-12) which has brackets provided for the installation.

a. Antenna Elements. The vertical radiating element and the three ground plane elements consist of one to three each Mast Sections AB-21/GR, and one each of Mast Sections AB-22/GR, AB-23/GR, and AB-24/GR. The mast sections are copper plated, painted tubes of high-strength steel which can be screwed together.

b. Antenna Base MP-68. The MP-68 (fig. 1-3) is comprised of a ceramic feedthrough insulator, sockets for mounting the antenna elements, Adapter M-359, and a vise. The feedthrough insulator allows the vertical radiating antenna element socket to be connected through Adapter M-359, to the center conductor of the CG-107/U. The three ground plane sockets and the outer conductor of the CG-107/U connect to the metal framework of the antenna base. The vise enables the antenna base to be clamped to the top of the supporting

mast assembly.

c. Mast Sections AB-35/TRC-7. Twelve sections are provided for assembling the 30-foot supporting mast assembly. Each section is tubular and has a male and female end which permit the sections to be fitted together.

d. Mast Base Assembly AB154/U. This assembly consists of Guy Stake GP-101/U attached to a yoke and clevis pin assembly. The lowermost Mast Section Assembly AB-35/TRC-7 is placed in the yoke and clevis pin assembly. The yoke and clevis pin arrangement allows the mast assembly to be lowered to the ground by pivoting around the stake.

e. Gut Ropes, Guy Plates, Guy Straps, and Guy Stakes. These items hold the mast assembly in the vertical position (fig. 1-1).

f. Reel RL-28. Three of these reels are provided for the guy ropes. Of the six guy ropes provided, two are wound on each of the three reels.

g. Cable Assembly, Radio Frequency Cord CG-107/U. The CG-107/U is a 68-foot length of 50-

ohm, solid-dielectric, coaxial radio-frequency (rf) cable terminated in male Plugs PL-259-A.

h. Adapter M-442. The M-442 consists of an angle bracket provided with Socket SO-259, an insulated lead, and a ground lead which permits the CG-107/U to be easily connected to Radio Sets SCR-508, SCR-528, SCR-608, and SCR-628.

i. Adapter Connector UG-255/U. The UG-255/U is required to adapt the CG-107/U to Receiver-Transmitters RT-66/GRC, RT-67/GRC, RT-68/GRC, RT-246/VRC, RT-524/VRC, and Radio Sets AN/PRC-8, AN/PRC-9, and AN/PRC-10.

j. Roll CW-50/TRC-7. The CW-50/TRC-7 is a canvas roll with pockets and straps to hold the antenna components for transportation in the field. A shoulder strap is provided for easy carrying.

k. Guy Plate. One guy plate is inserted between the sixth and seventh sections of the mast assembly and another between the eleventh and twelfth sections. The upper and lower guy ropes attach to these plates.

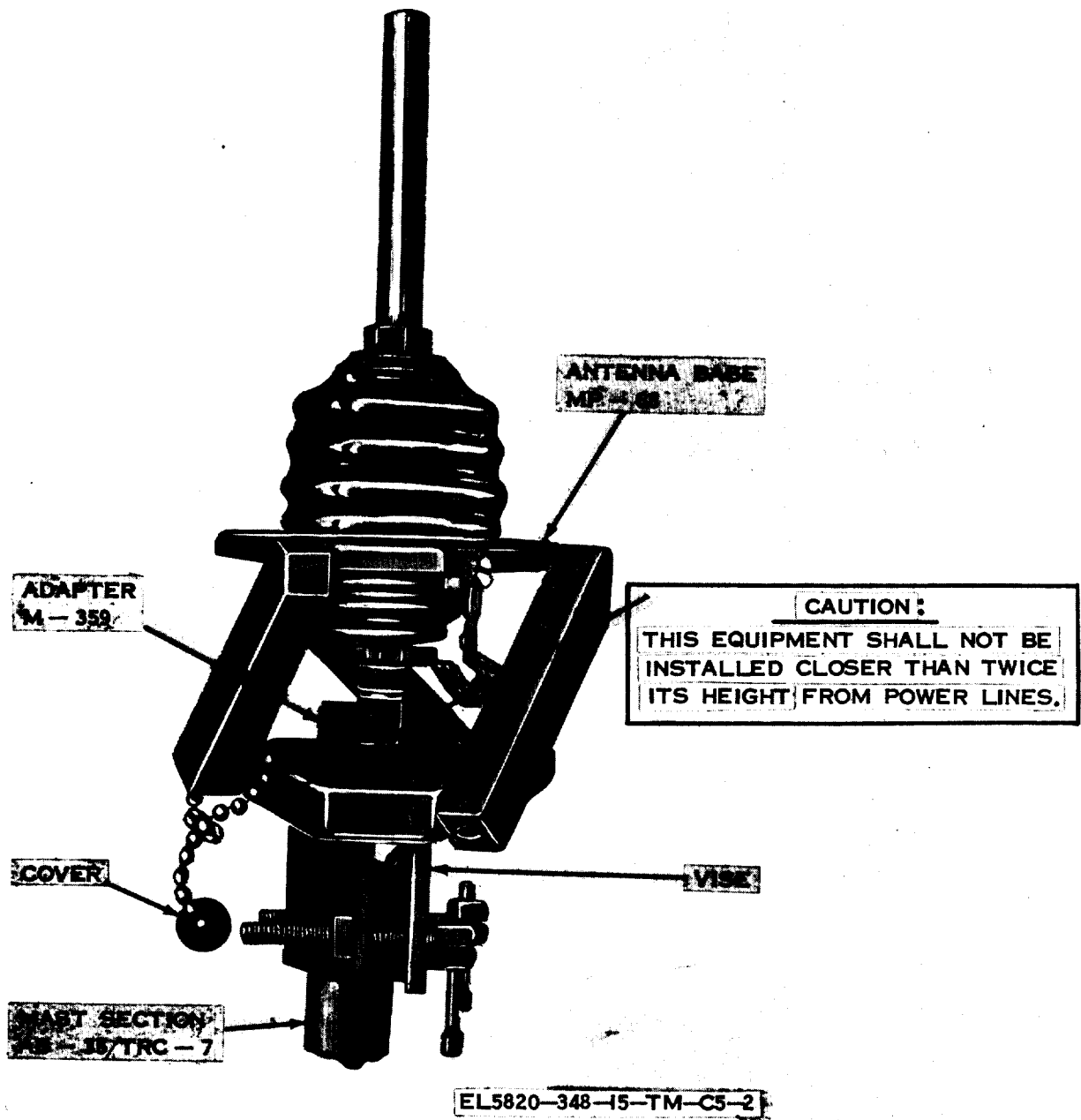

Figure 1-3. Antenna Base MP-68, mounted on mast.

Chapter 2

INSTALLATION AND OPERATING INSTRUCTIONS

Section 1. SERVICE UPON RECEIPT OF ANTENNA EQUIPMENT RC-292

2-1. Unpacking

a. Packaging Data, When packed for shipment, the components of the RC-292 are wrapped as described in paragraph 5-3, and enclosed in an inner corrugated carton. The carton is placed in a moisture-vaporproof barrier with a desiccant and humidity indicator, which is placed in an outer corrugated carton. The outer carton is placed in a moisture-vaporproof barrier, which in turn is placed in 1 wooden packing case. Metal straps are applied around the outside of the wooden packing Mae.

b. Removing Contents. Follow the procedures outlined below when unpacking the equipment.

- (1) Cut the metal straps with a suitable cutting device or twist them with pliers until they break.
- (2) Remove the nails from the wooden cover of the wooden packing case with a nailpuller or pry bar.

Caution: Do not pry deeply into the interior of the case with a pry bar; this may damage the equipment.

- (9) Remove the wooden cover of the case and open the moisture-vaporproof barrier that covers the outer corrugated carton inside the case.
- (4) Remove the outer corrugated carton from inside the moisture-vaporproof barrier.
- (5) Open the outer corrugated carton and open the moisture-vaporproof barrier.
- (6) Open the inner corrugated carton and remove the contents.
- (7) Unwrap the components and place each component group on a clean, dry surface.

2-2. Checking. Unpacked Equipment

a. Inspect the equipment for damage incurred during shipment. If the equipment has been damaged, refer to paragraph 1-3 for applicable forms and records.

b. Check the equipment against the packing list.

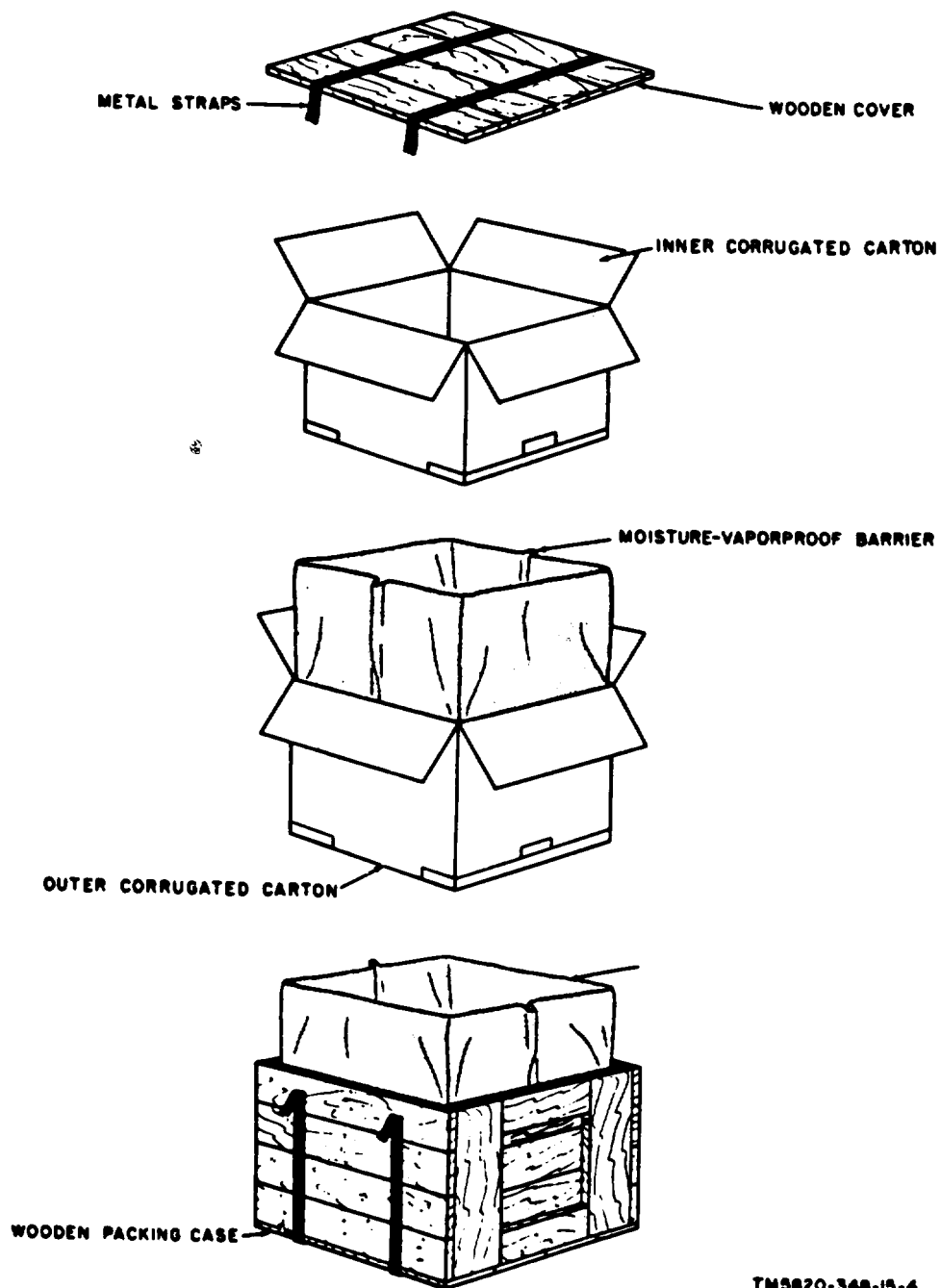

Figure 2-1. Typical packaging diagram.

Section II. INSTALLATION OF ANTENNA EQUIPMENT RC-292.**WARNING**

Helmet liner, safety glasses and gloves must be worn before assembling and erecting the RC-292.

CAUTION

When erecting antenna pull on the upper guys until they are taut, then pull on the lowers guys until they are taut, then pull on both sets of guys equally to pull the mast upright, keeping a slight bow (downward) in the mast, as shown in figure 2-6.

NOTE

The only tool required is the hammer which is furnished with the equipment.

2-3. Siting

a. The signals from the radio transmitter have a greater range if the antenna is high and clear

of hills, buildings, cliffs, densely wooded areas, and other obstructions. Depressions, valleys, and other low places are poor sites for

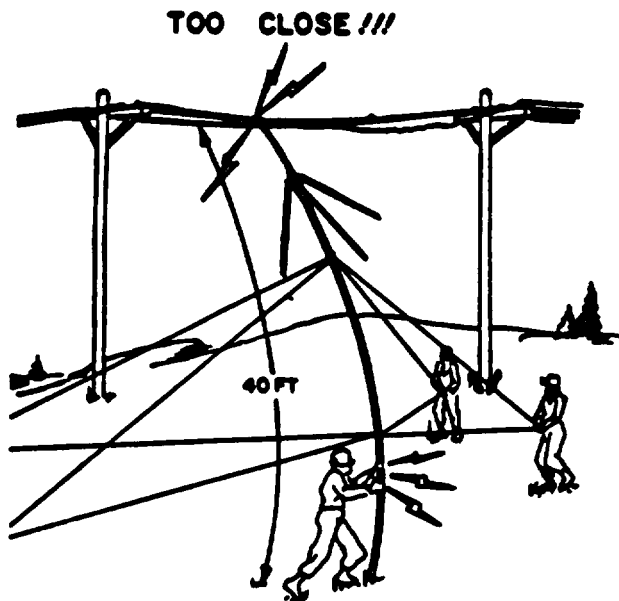

**SOME PERSONS
HAVE BEEN
KILLED!!
SOME HAVE BEEN
INJURED!!**

**READ, UNDERSTAND, AND READ
AGAIN THE INSTRUCTIONS IN
THE WARNING AT THE FRONT
OF THIS MANUAL.**

**THE LIFE YOU SAVE
MAY BE YOUR OWN!!!**

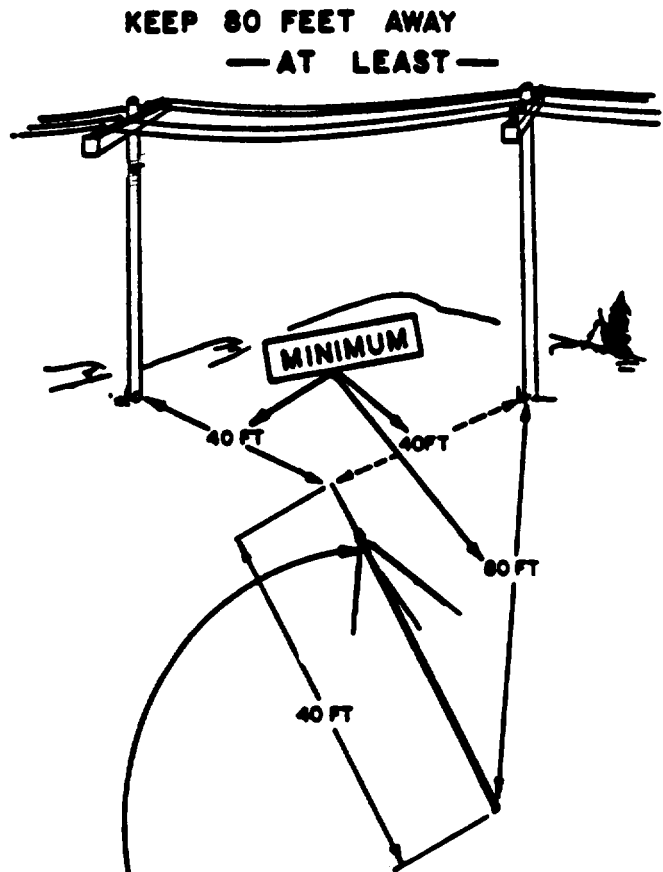

**READ THE INSTRUCTION PLATE
AND FOLLOW WHAT IT SAYS:**

**CAUTION
THIS EQUIPMENT SHALL NOT
BE INSTALLED CLOSER THAN TWICE
ITS HEIGHT FROM POWER LINES**

**THAT'S 40 FT X 2 = 80 FT
FROM BASE OF POWER LINE
TOWER / POLE, ETC**

**READ, AND READ AGAIN, THE
WARNING INSTRUCTIONS IN
THE FRONT OF THIS MANUAL
AND THE HEALTH INSTRUCTIONS
FOR ELECTRICAL SHOCK**

EL 5820-348-15-TM-C5-5

Figure 2-1.1. WARNING INSTRUCTIONS—to be followed when erecting and lowering the antenna.

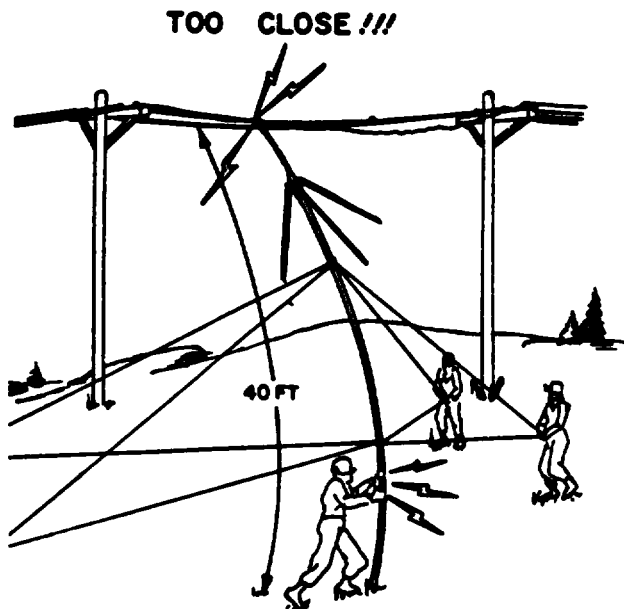

**SOME PERSONS
HAVE BEEN
KILLED!!
SOME HAVE BEEN
INJURED!!**

**READ, UNDERSTAND, AND READ
AGAIN THE INSTRUCTIONS IN
THE WARNING AT THE FRONT
OF THIS MANUAL.**

**THE LIFE YOU SAVE
MAY BE YOUR OWN!!!**

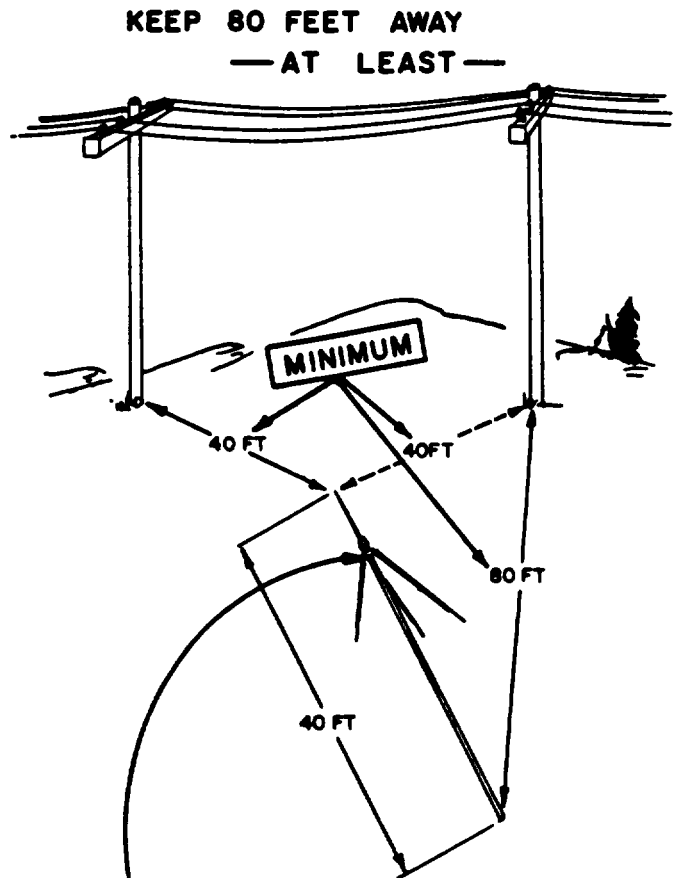

**READ THE INSTRUCTION PLATE
AND FOLLOW WHAT IT SAYS:**

**CAUTION
THIS EQUIPMENT SHALL NOT
BE INSTALLED CLOSER THAN TWICE
ITS HEIGHT FROM POWER LINES**

**THAT'S 40 FT X 2 = 80 FT
FROM BASE OF POWER LINE
TOWER / POLE, ETC**

**READ, AND READ AGAIN, THE
WARNING INSTRUCTIONS IN
THE FRONT OF THIS MANUAL
AND THE HEALTH INSTRUCTIONS
FOR ELECTRICAL SHOCK**

EL 5820-348-15-TM-C5-5

Figure 2-1.1. WARNING INSTRUCTIONS—to be followed when erecting and lowering the antenna.

radio reception and transmission, because the surrounding high terrain absorbs rf energy. Weak or other undesired signals can be expected if the radio set is operated under, or close to, steel bridges, underpasses, powerlines, or power units.

b. The most desirable locations for transmission and reception are hilltops, elevations, and slight rises in ground; flat terrain is also good.

c. When selecting the antenna site, be sure that the 68-foot coaxial cable will reach from the antenna to the radio set.

2-4. Positioning Baseplate and Guy Stakes
(fig. 2-2)

a. Place the baseplate, with the cleats up, where the antenna is to be erected.

b. Drive the stake of the AB-154/U through the center hole of the baseplate with the hammer.

c. Drive three guy stakes at a 45-degree angle into the earth facing away from the mast, (fig. 1-1) 15 feet from the centers of the cleats on the baseplate (fig. 2-2). The three stakes will then be 120° apart. The distance of 15 feet is equal to the length of six mast sections fitted together.

d. Tie the flexible end of each of the three guy straps around the three guy stakes just driven. Use a cowhitch (fig. 2-8), so that tension on the metal ring will hold the guy straps securely.

2-5. Assembling Antenna Equipment RC-292

a. Assembling Mast.

- (1) Assemble six Mast Sections AB-35/TRC-7 by inserting the male ends into the female ends, and place the bottom section of the assembly over the moveable portion of the AB-154/U (fig. 2-2).
- (2) Assemble five additional Mast Sections AB-35/TRC-7 and join them with the six already assembled, inserting one guy plate between the

sixth and seventh sections of the mast assembly.

- (3) Place a second guy plate over the end of the eleventh section of the mast assembly, and add the final Mast Section AB-85/TRC-7 to the assembly.
- (4) Rotate the mast assembly about the AB-154/U until its free end is midway between two of the guy stakes (fig. 2-6).

b. Elements Required. The number of elements required depends on the desired frequency range. The following chart shows the number of each type of section to assemble for a given frequency range.

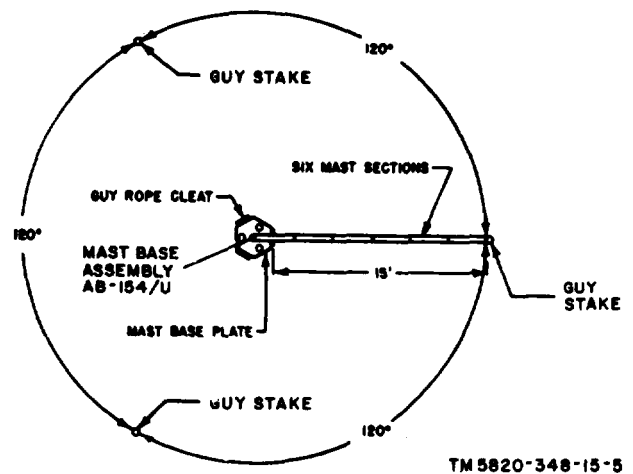

Figure 2-2. Positioning guy stakes.

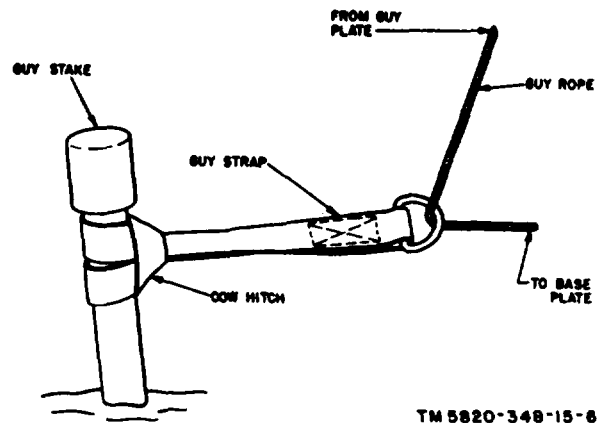

Figure 2-3. Attaching guy strap to guy stake.

Radio Set or Receiver-Transmitter	Operating frequency (mc)	Vertical antenna					Ground plane				
		Number of sections required	Quantity and type of sections				Number of sections required	Quantity and			
			AB-21/GR	AB-22/GR	AB-23/GR	AB-24/GR		AB-21/GR	AB-22/GR	AB-23/GR	AB-24/GR
RT-66/GRC, AN/PRC-8	20 to 27.9	6	3	1	1	1	18	3	1	1	1
RT-67/GRC, AN/PRC-9	27 to 38.9	4	1	1	1	1	15	2	1	1	1
RT-68/GRC, AN/PRC-10	38 to 54.4	3	0	1	1	1	12	1	1	1	1
RT-246/VRC, ^a	30 to 36.5	4	1	1	1	1	15	2	1	1	1
RT-524/VRC, ^a	36.5 to 50.5	3	0	1	1	1	12	1	1	1	1
RT-505/PRC-25, ^b	50.5 to 75.95	2	0	1		1	9	0	1	1	1
RT-841/PRC-77 ^c											

^a Part of AN/VRC-12 series radios (TM 11-5820-401-12).

^b Part of AN/PRC-25 and vehicular Radio Sets AN/VRC-53 and AN/GRC-125.

^c Part of AN/PRC-77 and vehicular Radio Sets AN/VRC-64 and AN/GRC-160.

c. Assembling Antenna Elements.

NOTE

To prevent the mast sections from seizing, apply a thin film of Silicone Compound (NSN 6850-00-880-7616) to the threads of each mast section.

(1) Assemble the vertical element by screwing together the number of Mast Sections AB-21/GR, AB-22/GR, AB-23/GR, and AB-24/GR corresponding to the desired frequency range shown in the chart in b. above. For example, for 30 to 36 mc, use one each of AB-21/GR, AB-22/GR, AB-23/GR, and AB-24/GR. Screw AB-21/GR into AB-22/GR, AB-22/GR into AB-23/GR, and AB-23/GR into AB-24/GR.

(2) Insert the assembled vertical elements into the socket at the top of the insulator on the MP-68.

(3) For the ground plane, assemble three more sets of Mast Sections by screwing together the number of Mast Sections AB-21/GR, AB-22/GR, AB-23/GR, and AB-24/GR corresponding to the desired frequency range shown in the chart above. For example, for 30 to 36 mc, there will be 15 mast sections. In each of the three legs of the ground plane, assemble 2 each of AB-21/GR and one each of AB-22/GR, AB-23/GR, and AB-24/GR.

(4) Insert each ground plane set into a socket of the MP-68.

(5) Place Antenna Base MP-68 over the top Mast Section AB-35/TRC-7 of the previously assembled mast and tighten the vice (fig. 1-3). Position the MP-68 so that two of the elements rest on the ground (fig. 2-9).

(6) Connect Adapter M-359 to the bottom of the MP-68 (fig. 1-3 and 2-10). Connect the CG-107/U to the M-359.

(7) Relieve the strain on the fittings and the connectors by taping the CG-107/U to the mast assembly approximately every 5 feet to the bottom of the MAST.

(8) After the mast is erected, connect the CG-107/U to the radio (para 2-9).

2-6. Erection of Antenna Equipment RC-292 by Two Men

NOTE

The designation of "man" and "men" in following procedures (and para 2-7) apply also to women.

a. Turn the guy plates so that one hole of each is uppermost.

b. Attach two guy ropes securely to the side holes of the lower guy plate (fig. 1-1). Pass these guy ropes through their respective side guy stake strap rings (fig. 2-3), and then through the holes in the appropriate baseplate cleats. Form a slip knot in each guy rope and pull the free ends through the loops of the slip

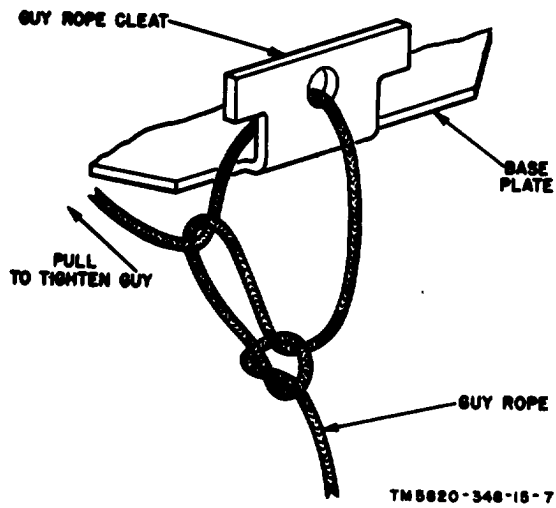

Figure 2-4. Slip knot for tightening guy rope.

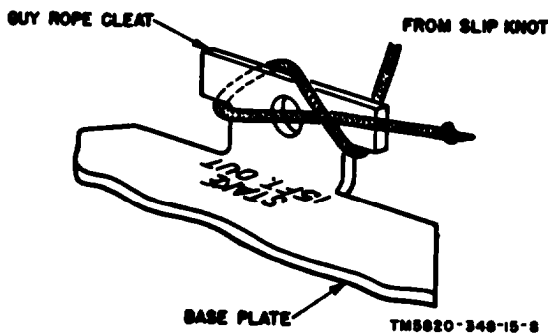

Figure 2-5. Hitch for securing end of guy rope.

knots as shown in figure 2-4. When tied in this manner, each guy rope can be pulled as taut as desired and can be secured with a simple hitch (fig. 2-5). The guy rope can be readily released.

c. Pull the guy ropes taut and secure them with a hitch (fig. 2-5).

d. Snap the third guy in the third hole of the lower guy plate and lay the guy along the mast toward the third guy stake.

e. Attach three guy ropes to the upper guy plate in the same manner.

f. To raise the mast, two men coordinate movements as follows: One man stands near the swivel stake and in line with the third guy stake. The second man stands at the top of the mast. The first man bows the top end of the mast by pulling the free guy ropes taut. At the same time, the second man, having raised the top end of the mast to shoulder height, walks toward the base plate, pushing the mast upward, while the first man walks backward towards the third guy stake, pulling the mast slowly and firmly erect (fig. 2-6).

g. When the mast is in the vertical position, adjust and tighten all the guy ropes. Secure each guy rope with the hitch as shown in figure 2-6.

2-7. Erecting Antenna in Confined Areas

Where terrain, trees, or brush make hori-

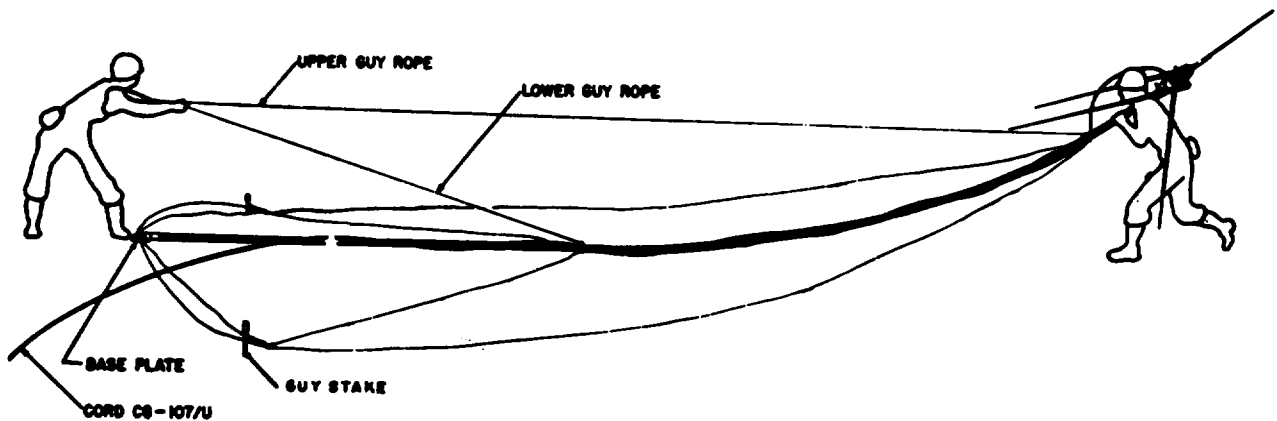

Figure 2-6. Erecting Antenna Equipment RC-292 with two men.

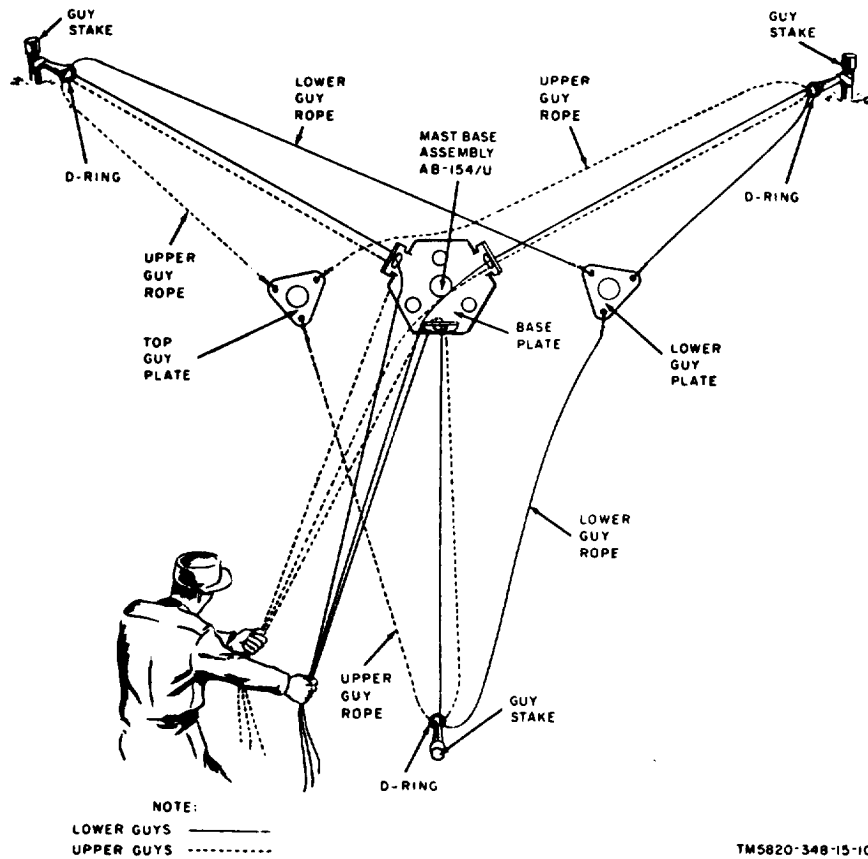

Figure 2-7. Baseplate, guy plate, and guy rope layout.

zontal assembly of the antenna prior to its erection impractical, use the following vertical erection procedure:

a. Lay out the baseplate, swivel stake, and guy stakes as instructed in paragraph 2-4 and as shown in figure 2-7. Remove all obstructions from the area within the limits of the guy stakes.

b. Place two guy plates close to the baseplate, to be used for the upper and lower guy plates.

Note: Lay out the guy ropes so that the upper guy ropes will not cross under the lower guy ropes.

c. Select three ropes for the upper guy ropes and three ropes for the lower guy ropes. Thread the upper and lower guy ropes through the baseplate guy rope cleats as illustrated in figure 2-7.

d. Arrange the free ends of the lower three guy ropes so that the assistant can hold them securely in one hand, and then arrange the

three free ends of the upper three guy ropes so that the assistant can hold them in his other hand. The two groups of guy rope ends held by the assistant will be fed as slack during the assembly procedure when the antenna sections are being raised.

e. Assemble the antenna elements (para 2-5) on Antenna Base MP-68 and place the socket of the antenna base onto the top of a Mast Section AB-35/TRC-7.

f. Place the upper guy plate on the male (lower) end of the top of an AB-35/TRC-7 and place its male end into the female end of the second (next lower) AB-35/TRC-7.

g. Continue to raise the antenna vertically (fig. 2-8) by adding additional Mast Sections AB-35/TRC-7.

h. Attach the lower guy plate between the sixth and seventh mast sections.

i. After the last AB-35/TRC-7 has been added, lower the mast into the swivel stake.

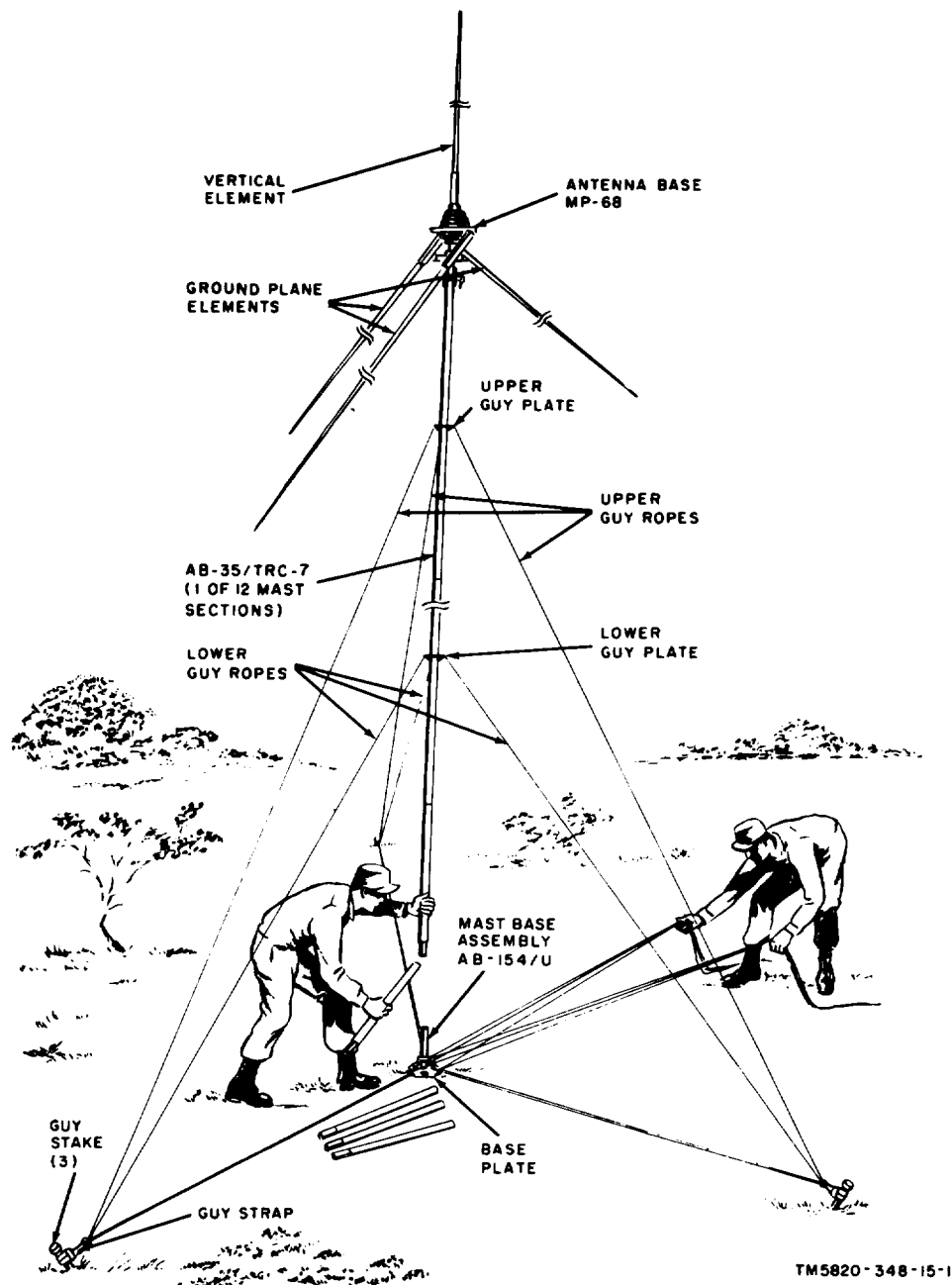

Figure 2-8. Antenna Equipment RC-292, partially assembled, using vertical erection.

j. Secure the free ends of the six guy ropes to the guy rope cleats on the mast baseplate.

2-8. Erection of Antenna Equipment by One Person

If only one person is available for erecting the RC-292, proceed as follows:

a. Follow the assembly procedures in paragraphs 2-5 and 2-6a through e.

b. Move the mast 90 degrees clockwise from the first stake (fig. 2-9). Secure the guy ropes to the baseplate (fig. 2-5).

c. Move the mast 90 degrees counterclockwise

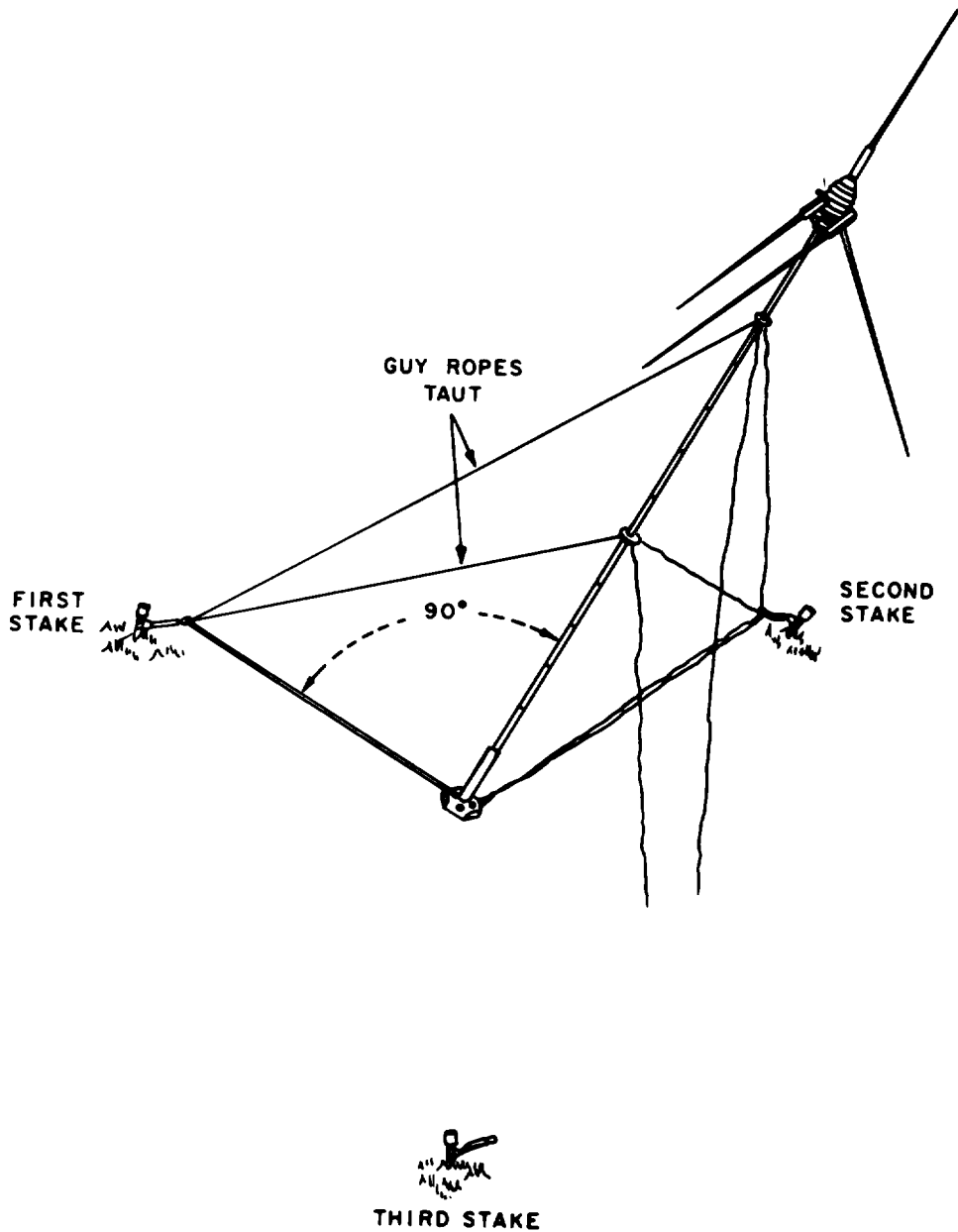

TM5820-348-15-C4-TM-1

Figure 2-9. Positioning RC-292 on ground; first step for one person erection.

from the second stake (fig. 2-9.1). Secure the guy ropes to the baseplate.

d. Position yourself between the first and third stakes. Take the guy ropes in hand and walk toward the third stake, while pulling the mast up and keeping the guy ropes taut leading to the second stake,

e. Run the guy ropes through the third guy stake strap ring (fig. 2-3) and secure them to the baseplate.

2-8 Change 4

f. Adjust and tighten all guy ropes. Secure each guy rope to the baseplate (fig. 2-5).

2-9. Connection to Radio Set

CAUTION

Make sure the radio set is turned off while making the cable connection to the radio.

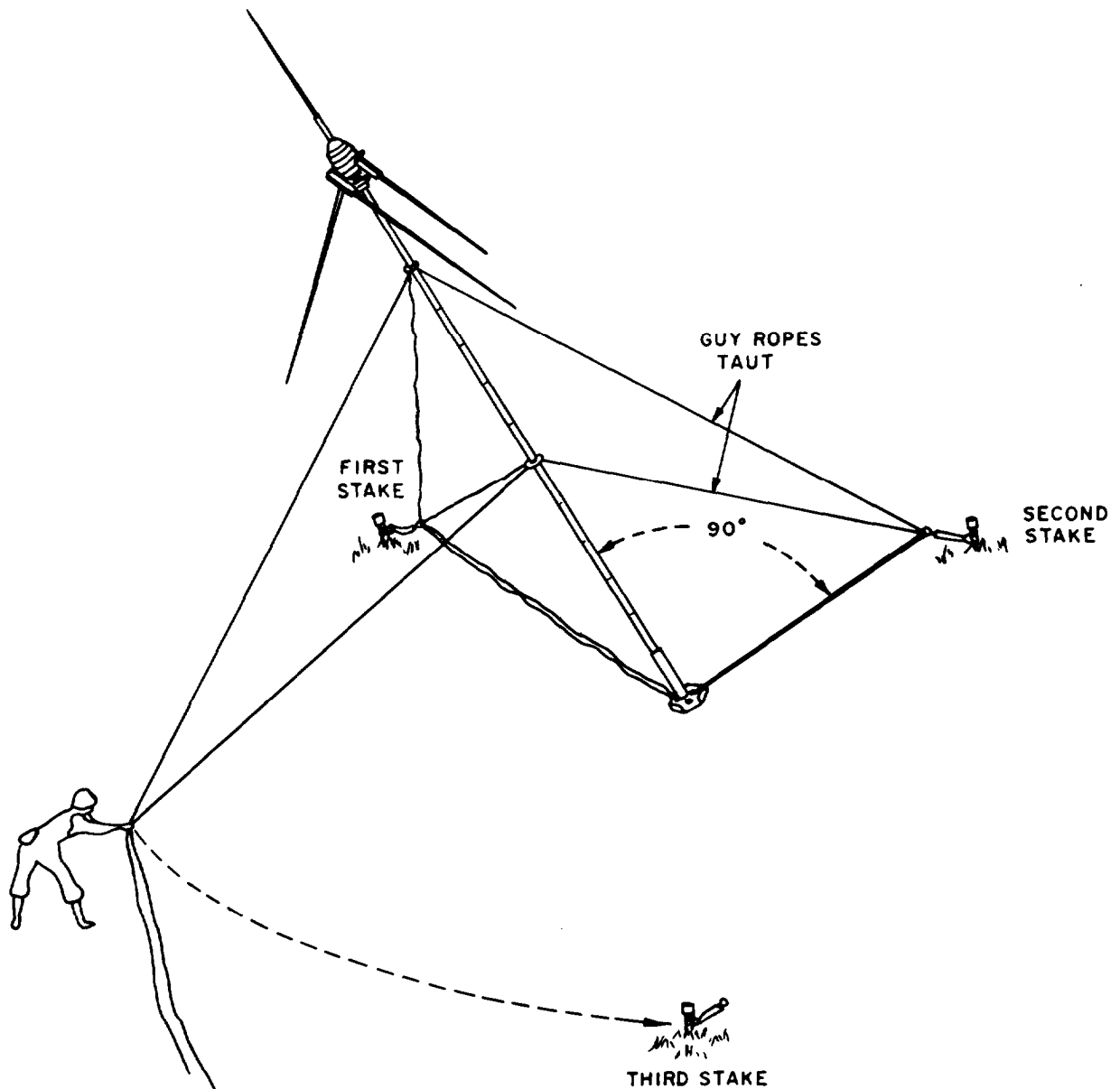

TM5820-348-C4-TM-2

Figure 2-9.1. Positioning RC-292 on ground, second step for one person erection.

- a. Attach Adapter UG-255/U to the end of the CG-107/U and connect the CG-107/U to the radio antenna connector (BNC type) (fig. 2-10).
- b. When the RC-292 is used, Antennas AS-1729/VRC (or AS-2731/GRC) and AT-912/VRC (part of AN/VRC-12 radio series) and AN/VRC-53, AN/VRC-64, AN/GRC-125 and AN/GRC-160 must not be used.
- c. To protect the CG-107/U from vehicles and persons walking in the area, lay boards on the ground on both sides of the cable. The boards should be thicker than the cable.

NOTE

To provide a feed-through assembly for running the CG-107/U through the wall of a shelter, Feed-Thru Kit for RC-292 Antenna Lead-In (NSN 5820-00-227-6542) is used. Plug PL-259 (fig. 2-10) is removed, the ca-

ble, surrounded by a strain-relief connector, is inserted through the hole, and PL-259 is reconnected to the cable (drawings SC-C-160416 and SC-D-13907). The strain relief connector holds the cable in the shelter hole.

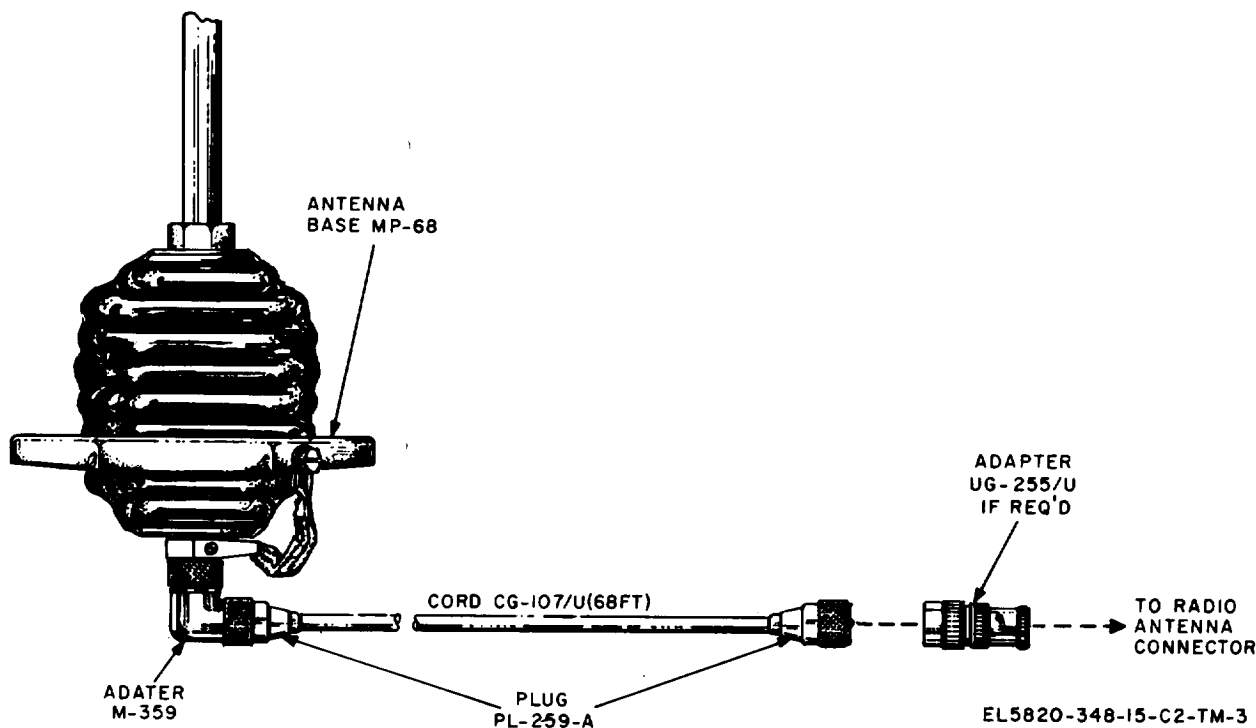

Figure 2-10. Connections of CG-107/U to MP-68 and radio set.

d. When using Radio Sets SCR-508, SCR-528, SCR-608, and SCR-628, perform the following procedures (Fig. 2-11).

- (1) Slide the radio transmitter to the right on Mounting FT-237 () or remove it from the mounting.
- (2) On the mounting, remove the screw located in front of the TR binding post.
- (3) Place Adapter M-442 on Mounting FT-237 so that the adapter mounting hole is over the hole where the screw was removed. Socket SO-239 must face the operator. Position the

terminal, on the end of the adapter ground lead, over the mounting hole. Insert the screw previously removed from Mounting FT-237, through the hole in the adapter, and screw it tightly into the mounting until the adapter is secure.

- (4) Connect the insulated lead of Adapter M-442 to the TR binding post of the mounting and connect Cable Assembly, Radio Frequency Cord CG-107/U to Socket SO-239 on Adapter M-442.

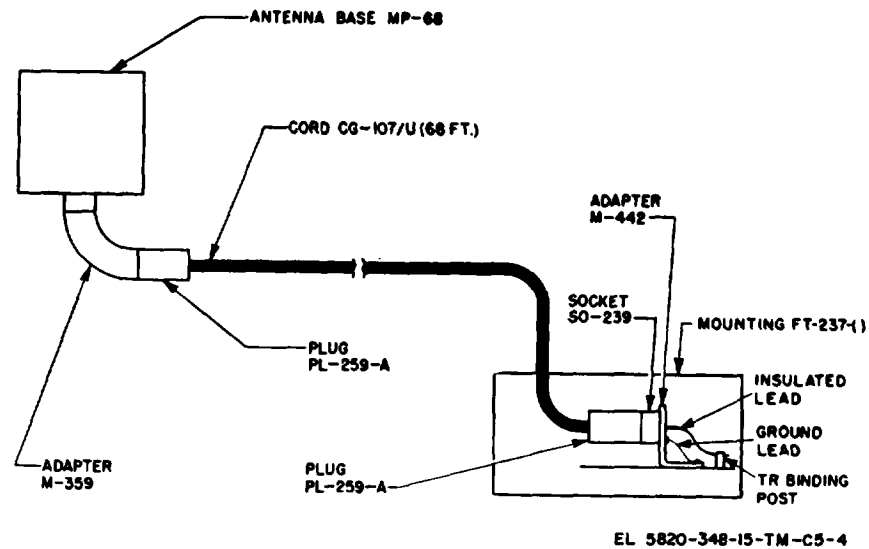

Figure 2-11. Using Adapter M-442 to connect Antenna Equipment RC-292 to radio set (SCR series).

WARNINGS

BEFORE LOWERING THE ANTENNA, READ THE "LONG RANGE ANTENNA WARNING" IN THE FRONT OF THE MANUAL. THESE WARNINGS APPLY ALSO WHEN LOWERING THE ANTENNA.

1. IF THERE ARE POWER LINES NEARBY, LOWER THE ANTENNA IN THE DIRECTION OPPOSITE THE POWER LINES.
2. CLEAR THE AREA OF PERSONNEL, EQUIPMENT, AND VEHICLES BEFORE STARTING TO LOWER THE ANTENNA.

THESE WARNINGS AND INSTRUCTIONS APPLY WHETHER YOU ARE LOWERING THE ANTENNA TO CHANGE ANTENNA ELEMENTS OR DISASSEMBLING THE ANTENNA.

2-10. Lowering Antenna

To lower the antenna to change the number of mast sections in the antenna elements, loosen one set of guy ropes (upper and lower) and lower the antenna to the ground by letting it pivot about the AB-154/U. After the antenna elements have been changed, raise the antenna by pulling on the guy ropes (fig. 2-6 or 2-9) and resecure the antenna. Do not loosen more than two guy ropes.

2-11. Operation Under Unusual Conditions

- a. A special Stake, Guy GP-101/U (para 1-6) is provided for arctic conditions.
- b. Leave a slight slack in each guy rope to allow for expansion and contraction of the mast and guy ropes. Check the tautness in the morning and during the day. Experience with temperature conditions in the area will determine how taut the guy ropes should be.
- c. If the mast and antenna become covered with ice or snow, shut down the radio, brush away the snow and melt the ice.
- d. If the stakes driven into poor soil do not hold, a suitable weight, such as a large rock or tree can be placed on top of the anchor to hold it; or use tools or heavy equipment to hold the stakes in position.

WARNINGS

BEFORE INSTALLING THE RC-292 ON A M577 COMMAND POST (para 2-12), OBSERVE THE FOLLOWING WARNINGS:

1. TURN OFF THE RADIO UNTIL THE RC-292 IS INSTALLED.
2. WATCH OUT FOR POWER LINES!!! SEE THE WARNING ON PAGE 2-2.2. ALSO, FOLLOW THE WARNING INSTRUCTIONS ON ANTENNA ERECTION IN THE FRONT OF THE MANUAL.

2-12. Installing RC-292 on M577 Command Post

The RC-292 can be installed on the top of M577 Command Post (TM 9-2300-257-10) and connected to the radio inside the vehicle (fig. 2-12).

- a. Insert an AB-35/TRA-7 Mast Section on the M577 mast brackets.
- b. Assemble the antenna elements in accordance with the radio frequency to be used (para 2-5b) and attach them to the MP-68 (fig. 1-3).
- c. Install the MP-68 on a AB-35/TRC-7 Mast Section. Attach the CG-107/U to the MP-68, and tape the cable to the AB-35/TRC-7.

WARNINGS

When the MP-68 is erected, with antenna elements installed, the tips of the ground plane elements must be approximately 5 feet above the top of the vehicle (so they are above the head of a person standing on the top of the vehicle).

AFTER THE RC-292 IS INSTALLED, NEVER TOUCH THE ANTENNA ELEMENTS--YOU NEVER KNOW WHEN SOMEONE IS TRANSMITTING ON THE RADIO.

- d. Install enough Mast Sections AB-35/TRC-7 to raise the antenna so that the tips of the down-pointing ground plane elements are approximately 5 feet above the top of the vehicle.
- e. If you expect windy conditions, or if the antenna is to be installed for a few days, put a guy plate between the first two Mast Sections AB-35/TRC-7 (at the top sections below the MP-68) and attach guy ropes between the guy plate and some point on the top of the vehicle.
- f. Run the CG-107/U through the driver's hatch and connect it to the radio (para 2-9). Roll up the extra length of CG-107/U and tie it to convenient points inside the vehicle to keep it away from movement inside the vehicle.

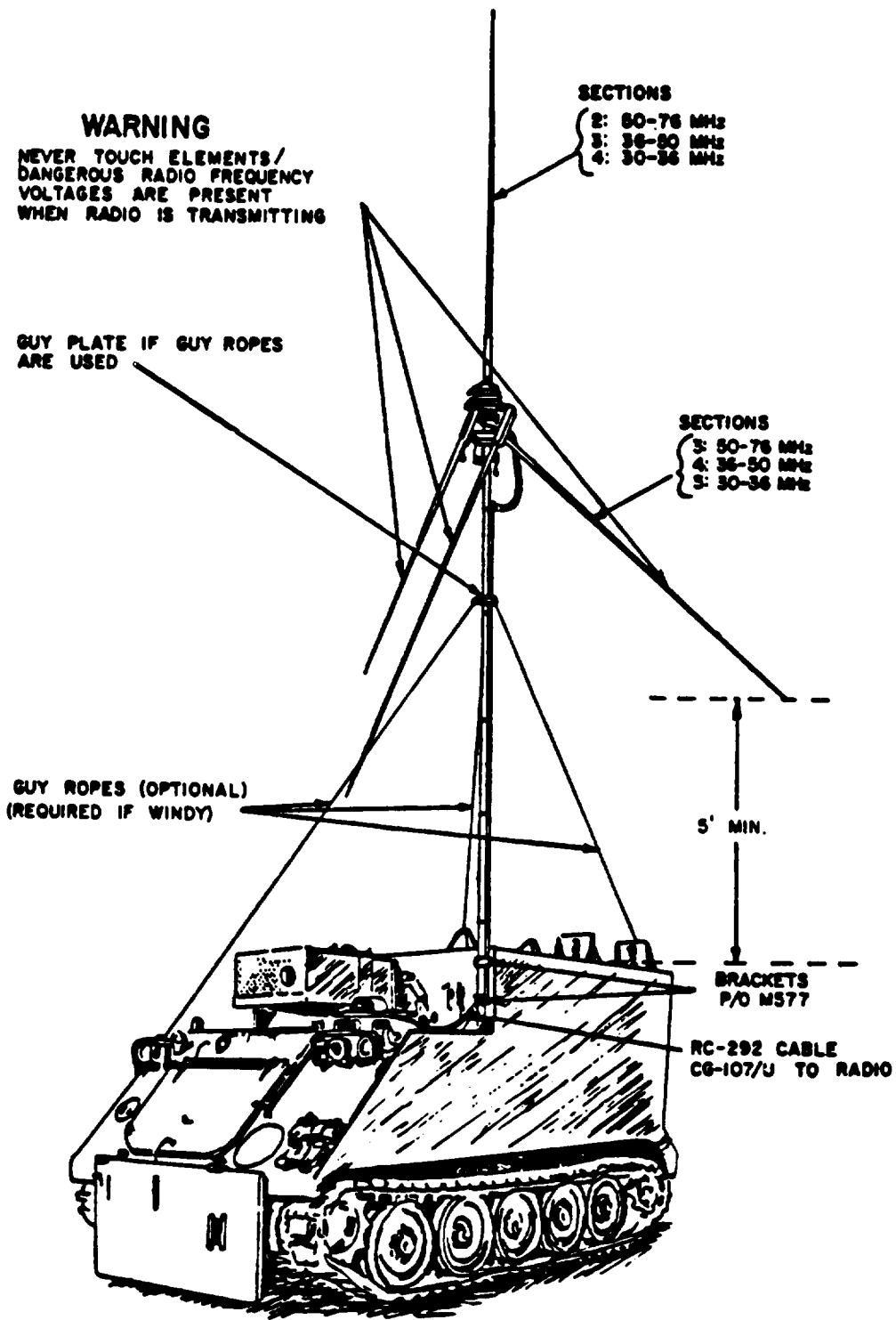

EL5820-348-15-TM-C5-3

Figure 2-12. RC-292 installed on top of M577 Command Post.

2-13. Checking Installed RC-292 Using Test Set, RF Power AN/URM-182 or AN/URM-182A (fig. 2-13)

After the RC-292 is installed and connected to the radio, a check of the performance of the radio with the RC-292 can be performed using the thru-line wattmeter AN/URM-182 (TM 11-6625-2718-14&P) or AN/URM-182A (TM 11-6625-2718-14-1).

- a. Connect the AN/URM-182 or AN/URM-182A as shown in figure 2-13.
- b. Key the transmitter and measure the forward and reflected power. In general, the reflected power indication should be not more than one-third of the forward

power indication. For example:

Foward power (watts)	Maximum reflected power (watts)
3	1
6	2
9	3
33	11
45	15
66	22
etc	etc

- c. If the maximum reflected power requirement (b above) is exceeded, refer to the wattmeter publication or to the operator's publication covering the radio (appendix A).

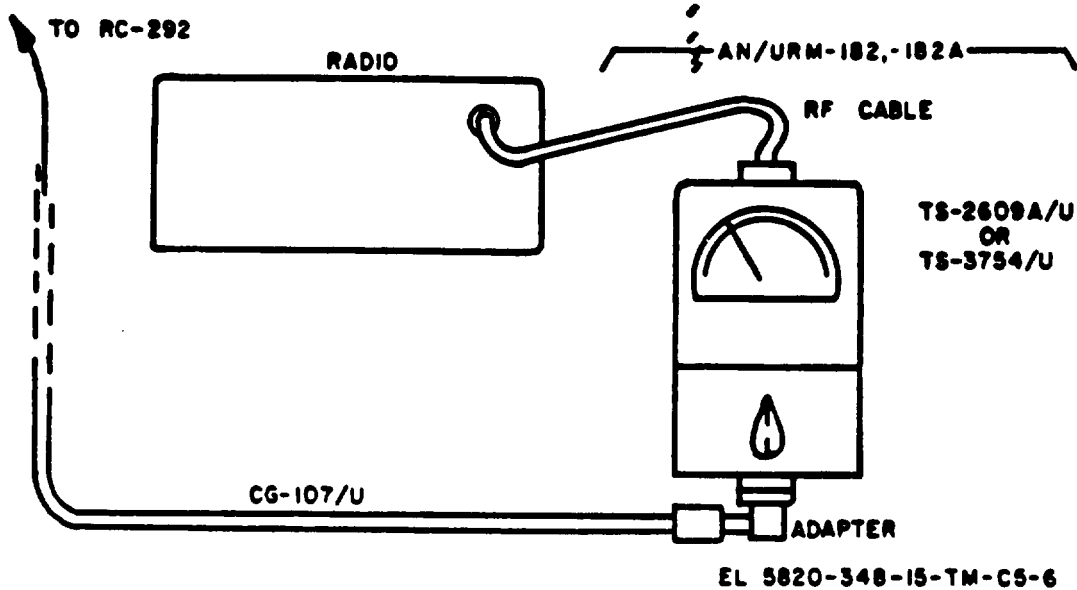

Figure 2-13. Test setup for radio and RC-292 with AN/URM-182 or AN/URM-182A.

CHAPTER 3

OPERATOR/CREW MAINTENANCE

WARNING

Dangerous rf voltage exist at the RC-292 elements and connectors. Personnel should be familiar with the warnings and safety instructions given in the front of the manual before attempting maintenance.

3-1. Scope of Operator's Maintenance

Following is a list of maintenance duties normally performed by the RC-292 operator. These procedures do not require special tools or test equipment.

- u. Preventive maintenance checks and services chart (table 3-1)
- b. Cleaning (para 3-5).

3-2. Materials Required

- a. Trichlorotrifluoroethane.
- b. Cleaning cloth.

3-3. Operator/Crew Preventive Maintenance

Preventive maintenance is the systematic care, servicing, and inspection of equipment to prevent the occurrence of trouble, reduce downtime, and assure that the equipment is operational

a. Systematic Care. The procedures given in table 3-1 cover routine, systematic care and cleaning essential to proper upkeep and operation of the equipment.

b. Preventive Maintenance Checks and Services. The preventive maintenance checks and services chart (table 3-1) outlines functions to be performed daily. These checks and services are to maintain Army electronic equipment in a combat-serviceable condition; that is, in good general (physical) condition and in good operating condition. To assist operators in maintaining combat serviceability, the chart indicates when to check, how to check, and the normal conditions.. The For

readiness reporting, equipment is not ready/available if column lists the criteria when the RC-292 is classified as not ready for its primary mission. If the defect cannot be remedied by the operator, higher category maintenance or repair is required. Records and reports of these checks and services must be made in accordance with the requirements set forth in DA Pam 738-750.

3-4. Preventive Maintenance Checks and Services Periods

Preventive maintenance checks and services (PMCS) for the RC-292 are required on a daily and weekly basis when the R-292 is erected. Table 3-1 specifies checks and services that must be accomplished under the conditions listed below.

- a. During. Be sure to perform during(D) procedures each day the antenna is installed.
- b. Weekly Procedure. If the equipment was not checked during the week, perform the D PMCS together with the weekly (W) PMCS.
- c. If Your Radio Equipment Fails to Operate. Troubleshoot the radio system as outlined in the applicable technical manual for the radio system (appx A). If you are unable to clear the trouble, report the failure using the proper form (DA Pam 738-750).

NOTES

Routine checks are not listed as PMCS; such as: cleaning (para 3-5); checking for frayed cables; stowing items not in use; covering unused receptacles; checking for loose nuts and bolts. These are things that should be done anytime you see they must be done.

The Item No. in table 3-1 shall be used as a source of item numbers for the TM number column on DA Form 2404 (Equipment Inspection and Maintenance Worksheet) in recording the results of the PMCS.

Table 3-1. Operator's Preventive Maintenance Check and Services (PMCS)
 Within the designated internal checks are to be performed in the order listed.
 D—During W—Weekly

Item No.	Interval		Item to be inspected	Procedure	For readiness reporting, equipment is not ready/available if:
	D	W			
1	•		Guy Assemblies	Check and adjust as necessary, the tautness of the guy assemblies. The mast should not be bowed; check straightness by comparing with a building, pole, etc. NOTE Experience should tell how taut to set the guy assemblies to allow for expansion and contraction of the mast during changes of hot and cold temperatures.	Associated radio communication fails because of RC-292.
2	•		CG-107/U	Check to see that the cable laying on the ground is undamaged, and, if required for area traffic condition, is protected by boards (para 2-9c).	
3	•		Radio Communication	Check communication function of associated radio.	
4		•	Guy Stakes	Check the guy stakes for looseness. Hammer them in or reposition them if soil conditions are better in another spot.	
5		•	Baseplate	Inspect the baseplate stakes for security in the ground. Hammer them in if necessary.	

If the equipment must be kept in constant operation, check and service only those items that can be checked and serviced without disturbing operation. Make complete checks and services when the equipment can be shut down.

3-5. Cleaning

a. Remove dust and loose dirt using water and cloth or brush.

WARNING

Adequate ventilation must be provided while using TRICHLOROTRIFLUOROETHANE. Prolonged breathing of vapor should be

avoided. The solvent should not be used near heat or open flames; the products of decomposition are toxic and irritating. Since TRICHLOROTRIFLUOROETHANE dissolves natural oils, prolonged contact with skin should be avoided. When necessary, use gloves which the solvent cannot penetrate. If the solvent is taken internally, consult a physician immediately.

b. Remove grease, fungus, and ground-in dirt with a cloth dampened with trichlorotrifluoroethane.

c. Clean the guy ropes by washing them, allow items to dry thoroughly.

CHAPTER 4

ORGANIZATIONAL MAINTENANCE

WARNING

Dangerous voltages exist in the CG-107/U and the radiating elements. Therefore, never work on or touch these parts until the CG-107/U is disconnected from the radio.

4-1. Scope of Organizational Maintenance

Organizational maintenance of the RC-292 consists of the following

- a. Preventive maintenance (para 4-3 and table 4-1).
- b. Touchup painting (para 4-4).
- c. Troubleshooting and repair (pars 4-5).

4-2. Test Equipment, Tools and Materials Required

Organizational repair parts are listed in TM 11-5820-348-24P.

- a. Test Equipment. Multimeter AN/URM-105 is the only test equipment required.
- b. Tools. Tool Kit, Electronic Equipment TK-101/G contains all the tools required.

- c. Materials.
 - (1) Trichlorotrifluoroethane.
 - (2) Paint, Alkyd, Camouflage, Forest Green per Mil-E-52798.

4-3. Organizational Preventive Maintenance Checks and Services

Preventive maintenance is the systematic care, inspection, and servicing of equipment to maintain it in serviceable condition, prevent breakdowns, and assure maximum operational capability. Organizational preventive maintenance checks and services (PMCS) are performed quarterly (table 4-1).

a. Quarterly PMCS will be scheduled in accordance with procedures specified in DA Pam 738-750.

b. The Item No. in table 4-1 shall be used as a source of item numbers for the TM number column on DA Form 2404 (Equipment Inspection and Maintenance Worksheet) in recording the results of the PMCS.

c. If the equipment fails to meet the criteria in the Procedures column of table 4-1, report the failure in accordance with the procedures specified in DA Pam 738-750.

Table 4-1. Organizational Preventive Maintenance Checks and Service-Quarterly Schedule

Item No.	Item to be inspected	Procedure Check for and have repaired or adjusted as necessary
1	Completeness	All components required to make the RC-292 operational are on hand (para 1-6 and app II) or are available.
2	Publications	TM 11-5820-348-15 and TM 11-5820-348-24P are on hand with latest changes; see DA Pam 25-30 for current publication listing.
3	Modifications	Check DA Pam 25-30 to see if any modification work orders (MWO's) are listed for the RC-292 or its components. All URGENT MWO's must be applied immediately; all NORMAL MWO's must be scheduled.
4	Metal surfaces	Remove rust, corrosion, and fungus; spot-paint bare metal spots (para 4-4).
6	Anticorrosion silicone compound	Remove old and install new anticorrosion compound (para 2-5c, note) on threaded areas of the mast sections and insulating extension.

d. If the equipment must be kept in constant operation, check and service only those items that can be done without disturbing operation. Make the complete checks and services when the equipment can be shut down.

e. Routine checks are not listed in the PMCS table; such as cleaning (para 3-5), dusting, washing; checking for frayed cables; stowing items not in use; covering unused receptacles; and checking for loose guys, stakes, and cable. These are things that should be done anytime you see they need to be done.

4-4. Touchup Painting

The painted surfaces of the RC-292 which have been badly scarred or damaged may be cleaned and repainted as follows

WARNING

Adequate ventilation must be provided while using TRICHLOROTRIFLUOROETHANE. Prolonged breathing of vapor must be avoided. The solvent should not be used near heat or an open flame; the products of decomposition are toxic and irritating. Since TRICHLOROTRIFLUOROETHANE dissolves natural oils, prolonged contact with skin should be avoided. When necessary, use gloves which the solvent cannot penetrate. If the solvent is taken internally, consult a physician immediately.

a. Lightly sand scarred equipment with #00 or #000 sandpaper and clean the bare metal with tri-

chlorotrifluoroethane.

b. Brush two coats of paint (Enamel, Alkyd, Camouflage, color Forest Green per Mil-E-52798) on the metal.

NOTE

Refer to applicable cleaning and refinishing practices specified in SB 11-573 end TB 43-0118.

4-5. Troubleshooting and Repair

a. Troubleshooting. Use Multimeter AN/URM-105 (TM 11-6625-203-12) to check continuity of CG-107/U and MP-68.

(1) MP-68.

(a) Continuity should be measured between the upper radiating elements and the center contact of Adapter M-359 on the MP-68 (fig. 1-3).

(b) Continuity should be measured between the ground plane elements and the shell of CG-107/U.

(2) CG-107/U Continuity should be measured between the center contacts of Plugs PL-259A on the CG-107/U (fig. 3-10) end between the center contact of Adapter UG-255/U.

b. Repair. Replacement parts of the RC-292 and repair parts of the MP-68 are listed in TM 11-5820-348-24P. To disassemble the MP-68 (fig. 1-3), unscrew the socket for the vertical element, remove the upper (female) half of the ceramic feedthrough insulator, and unscrew the nut that holds the adapter assembly (located inside).

Chapter 5

SHIPMENT AND LIMITED STORAGE

5-1. Disassembly of Equipment

Warning: Disconnect the radio set from the antenna before performing any disassembly.

Disassemble the antenna assembly as follows:

- a. Prepare a clean, dry surface for stacking the components.
- b. Loosen one set of guy ropes (upper and lower), and lower the antenna by letting it pivot about the swivel stake.
- c. Remove the tapes that secure Cable Assembly, Radio Frequency Cord CG-107/U to the mast.
- d. Remove and coil the CG-107/U. (Disconnect Adapter M-442.)
- e. Place the cover on Adapter M-359.
- f. Remove all guy ropes and wind them on Reels RL-28, two on a reel.
- g. Disconnect the vertical and ground plane elements from Antenna Base MP-68.
- h. Disassemble the vertical and ground plane elements and group them together according to mast section number.
- i. Loosen the vise and remove the MP-68 from the mast.
- j. Disassemble Mast Sections AB-35/TRC-7 and stack them together,
- k. Stack the guy plates together,
- l. Pull the AB-154/U from the earth. Wipe it clean with a cloth.
- m. Wipe the baseplate clean.
- n. Pull the guy stakes and wipe them clean.

5-2. Placing RC-292 in Roll CW-50/TRC-7 for Transportation

- a. Lay out the CW-50/TRC-7 as shown in figure 5-1.
- b. Place Mast Sections AB-35/TRC-7 in the broad top pocket. Place the technical manuals on top of the mast sections as shown and tighten the right-hand strap securely.
- c. Place Mast Sections AB-21/GR, AB-22/GR, AB-23/GR, and AB-24/GR in the lower section of the top broad pocket. Tighten the left strap securely.
- d. Place Antenna Base MP-68 in the short broad pocket on the right side and strap it securely in place.
- e. Place the AB-154/U and the guy stakes (with attached guy straps) in the lower section of the right hand pocket.
- f. Place the hand hammer, Tape TL-83, baseplate, guy ropes, guy plates, and Adapter M-442 in the lower left pocket.
- g. Coil the CG-107/U and place it on top of the stowed components.
- h. Fold in the end flaps of the CW-50/TRC-7 and strap securely.
- i. Fold the bottom flap of the CW-50/TRC-7 up over the components (fig. 1-2).
- j. Fold the top flap of the CW-50/TRC-7 down over the bottom flap and strap securely (fig. 1-2).

5-3. Repacking for Shipment or Limited Storage

(fig. 2-1)

- a. Wrapping and tying components prior to

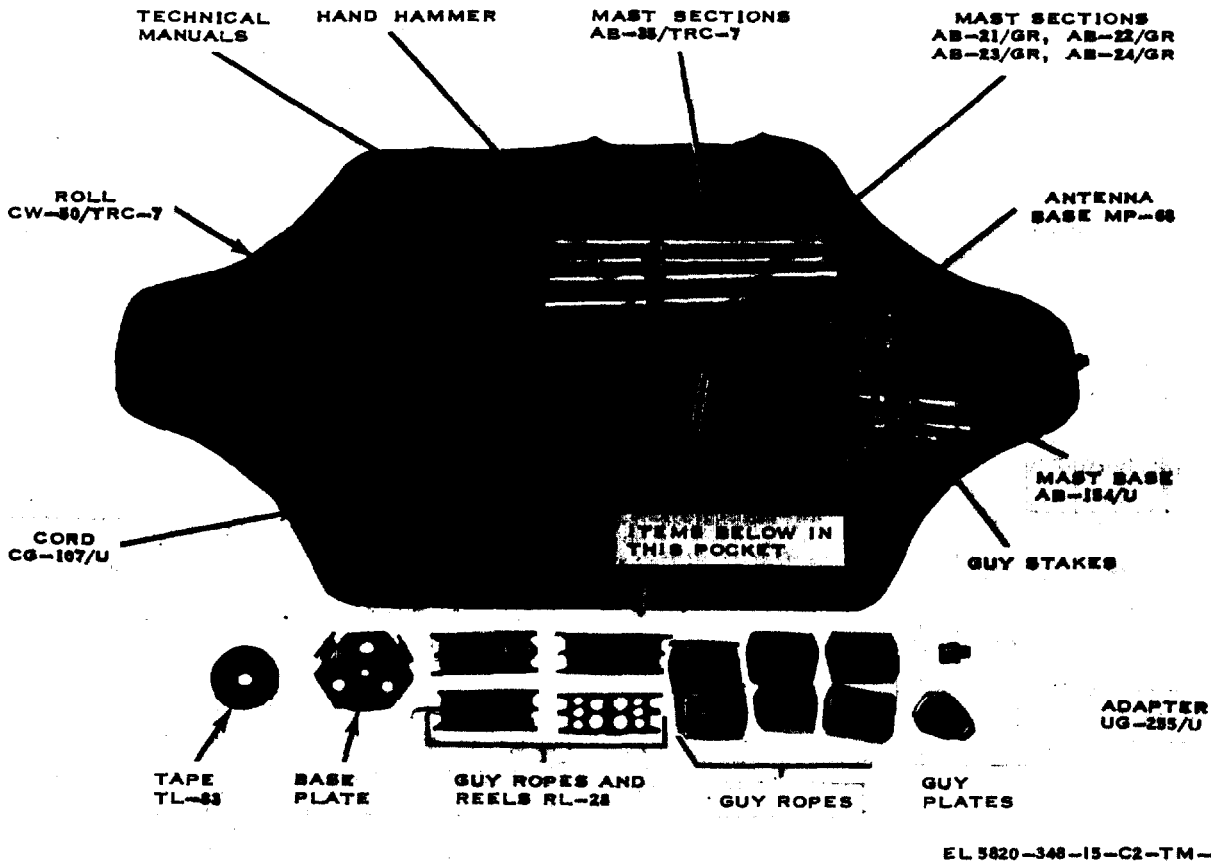

Figure 5-1. Antenna Equipment RC-292 packed in Bag, Roll CW-50/TRC-7.

packing protects them from damage. Follow the wrapping and tying procedures listed below:

- (1) Wrap Antenna Base MP-68 in corrugated paper secured with gummed tape.
- (2) Wrap each mast section group in paper.
- (3) Coil and tie the CG-107/U.
- (4) Fold and tie Roll CW-50/TRC-7.
- (5) Enclose each of the guy ropes in a separate sealed waterproof bag.
- (6) Tie the four guy straps together.
- (7) Securely tie the four guy plates together.
- (8) Securely tie the four guy stakes together.

- (9) Tie the three Reels RL-28 together.
- (10) The hammer, AB-154/U, baseplate, tape, and two technical manuals are loose packed and require no special wrapping.

b. Repack the equipment as follows:

- (1) Select a suitable corrugated fiberboard carton and carefully pack the components. Use a pad of filler material to prevent the components from damaging each other.
- (2) Seal the carton with adhesive tape.
- (3) Enclose the carton with desiccant in a waterproof barrier.
- (4) Place the carton in a suitable tight-fitting wooden crate secured with metal bands.

APPENDIX I

REFERENCES

Following is a list of applicable publications available to the operator and maintenance personnel of Antenna Equipment RC-292.

- | | |
|---------------------|--|
| DA Pam 25-30 | Index of Technical Publications: Technical Manuals, Technical Bulletins, Supply Manuals (Types 7, 8, and 9), Supply Bulletins, and Lubrication Orders. |
| DA Pam 738-750 | The Army Maintenance Management Systems (TAMMS). |
| SB 11-573 | Painting and Preserving Supplies Available for Field Use for Electronics Command Equipment. |
| TB 43-0118 | Field Instructions for Painting and Preserving Electronics Command Equipment Including Camouflage Pattern Painting of Electrical Equipment Shelters, |
| TM 11-5820-348-24P | Organizational, Direct Support and General Support Maintenance Repair Parts and Special Tools List (Including Depot Maintenance Repair Parts and Special Tools) for Antenna Equipment RC-292 (NSN 5820-00-497-8554). |
| TM 11-5820-398-12 | Operator's and Organizational Maintenance Manual Including Repair Parts and Special Tools List: Radio Set AN/PRC-25 (Including Receiver-Transmitter, Radio RT-505/RC-25). |
| TM 11-5820-401-10-1 | Operator's Manual: Radio Sets AN/VRC-12, AN/VRC-43, AN/VRC-44, AN/VRC-45, AN/VRC-46, AN/VRC-47, AN/VRC-48, AN/VRC-49 (Used Without Intercom Systems). |
| TM 11-5820-401-10-2 | Operator's Manual: Radio Sets AN/VRC-12, AN/VRC-43, AN/VRC-44, AN/VRC-45, AN/VRC-46, AN/VRC-47, AN/VRC-48, AN/VRC-49 (Used With Intercom Systems). |
| TM 11-5820-401-12 | Operator's and Organizational Maintenance Manual Including Repair Parts and Special Tools Lists: Radio Sets AN/VJ -12 (5820-00-223-7412), AN/VRC-43 (5820-00-223-7415), AN/VRC-44 (5820-00-223-7417), AN/VRC-45 (5820-00-223-7418), AN/VRC-46 (5820-00-223-7433), AN/VRC-47 (5820-00-223-7434), AN/VRC-54 (5820-00-223-7435), AN/VRC-49 (5820-00-223-7437), AN/VRC-54 (5820-00-223-7567), and AN/VRC-55 (5820-00-402-2265); Mounting MT-1029/VRC (5820-00-893-1323) and Mounting MT-1898/VRC (5820-00-893-1324); Antenna AT-912/VRC (5820-00-897-6357); Control, Frequency selector C-2742/VRC (5820-00-892-3343), and Control, Radio Set C-2299/VRC (5820-00-892-3340). |

TM 11-5820-348-15

- TM 11-582&498-12 Operator's and Organizational Maintenance Manual: Radio Sets AN/VRC-53 (NSN 5820-00-223-7467), AN/VRC-64 (NSN 5820-00-223-7475), AN/GRC-125 (NSN 5820-00-223-7411), and AN/GRC-160 (NSN 5820-00-223-7473), and Amplifier-Power Supply Groups OA-3633/GRC and OA-3633A/GRC (NSN 5820-00-973-3383).
- TM 11-5820-667-12 Operator's and Organizational Maintenance Manual Including Repair Parts List: Radio Set AN/PRC-77 (NSN 5820-00-930-3724) (Including Receiver-Transmitter, Radio RT-841/PRC-77 (NSN 5820-00-930-3725)).
- TM 11-662&2(&12 Operator and Organizational Maintenance: Multimeter AN/URM-105 and AN/URM-1056 Including Multimeter ME-77/U and ME-77C/U.
- TM 11462545414 Operator's, Organisational, Direct Support and General Support Maintenance Repair Parts and Special Tools Lists (Including Depot Maintenance Repair Parts and Special Tools Lists) for Multimeter AN/USM-223.
- TM 750-244-2 Procedures for Destruction of Electronics Materiel to Prevent Enemy Use (Electronics Command).

APPENDIX II BASIC ISSUE ITEMS LIST

Section 1. INTRODUCTION

A2-1. Scope

This appendix lists only basic issue items required by the crew/operator for installation, operation, and maintenance of antenna equipment RC-292.

A2-2. General

The basic issue items list is a list in alphabetical sequence, of items which are furnished with, and which must be turned in with the end item.

A2-3. Explanation of Columns

The following provides an explanation of columns found in the tabular listings:

- a. Illustration. This column is divided as follows:
 - (1) Figure Number. Indicates the figure number of the illustration in which the item is shown.
 - (2) Item Number. Not applicable.
- b. National Stock No. Indicates the National stock number assigned to the item and will be used for requisitioning purposes.
- c. Part Number. Indicates the primary number used by the manufacturer (individual, company, firm, corporation, or Government activity), which controls the

design and characteristics of the item by means of its engineering drawings, specifications standards, and inspection requirements, to identify an item or range of items.

d. Federal Supply Code for Manufacturer (FSCM). The FSCM is a 5-digit numeric code used to identify the manufacturer, distributor, or Government agency, etc., and is identified in SB 708-42.

e. Description. Indicates the Federal item name and a minimum description required to identify the item.

f. Unit of Measure (U/M). Indicates the standard of basic quantity of the listed item as used in performing the actual maintenance function. This measure is expressed by a two-character alphabetical abbreviation, (e.g., ea, in., pr, etc.). When the unit of measure differs from the unit of issue, the lowest unit of issue that will satisfy the required units of measure will be requisitioned.

g. Quantity Furnished with Equipment (Basic Issue Items Only). Indicates the quantity of the basic issue item furnished with the equipment.

Section II. BASIC ISSUE ITEMS LIST

(1) ILLUSTRATION		(2)	(3)	(4)	(5)	(6)	(7)
(A) FIG. NO.	(B) ITEM NO.	NATIONAL STOCK NUMBER	PART NUMBER	FSCM	DESCRIPTION USABLE ON CODE	UNIT MEAS	QTY FURN EQUIP
1-2		5820-00-497-8568			BAG, ROLL CW-50/TRC	EA	1
1-2		5120-00-203-4656	GGG-H-86	81348	HAMMER, HAND: TYPE 10, CLASS 1, 2½ lb	EA	1

APPENDIX III

MAINTENANCE ALLOCATION

Section 1. INTRODUCTION

A3-1. General

This appendix provides a summary of the maintenance operations for RC-292. It authorizes categories of maintenance for specific maintenance functions on repairable items and components and the tools and equipment required to perform each function. This appendix may be used as an aid in planning maintenance operations.

A3-2. Maintenance Function

Maintenance functions will be limited to and defined as follows:

a. **Inspect.** To determine the serviceability of an item by comparing its physical, mechanical, and/or electrical characteristics with established standards through examination.

b. **Test.** To verify serviceability and to detect incipient failure by measuring the mechanical or electrical characteristics of an item and comparing those characteristics with prescribed standards.

c. **Service.** Operations required periodically to keep an item in proper operating condition, i.e., to clean (decontaminate), to preserve, to drain, to paint, or to replenish fuel, lubricants, hydraulic fluids, or compressed air supplies.

d. **Adjust.** To maintain, within prescribed limits, by bringing into proper or exact position, or by setting the operating characteristics to the specified parameters.

e. **Align.** To adjust specified variable elements of an item to bring about optimum or desired performance.

f. **Calibrate.** To determine and cause corrections to be made or to be adjusted on instruments or test measuring and diagnostic equipments used in precision measurement. Consists of com-

parisons of two instruments, one of which is a certified standard of known accuracy, to detect and adjust any discrepancy in the accuracy of the instrument being compared.

g. **Install.** The act of emplacing, seating, or fixing into position an item, part, module (component or assembly) in a manner to allow the proper functioning of the equipment or system.

h. **Replace.** The act of substituting a serviceable like type part, subassembly, or module (component or assembly) for an unserviceable counterpart.

i. **Repair.** The application of maintenance services (inspect, test, service, adjust, align, calibrate, replace) or other maintenance actions (welding, grinding, riveting, straightening, facing, remachining, or resurfacing) to restore serviceability to an item by correcting specific damage, fault, malfunction, or failure in a part, subassembly, module (component or assembly), end item, or system.

j. **Overhaul.** That maintenance effort (service/action) necessary to restore an item to a completely serviceable/operational condition as prescribed by maintenance standards (i.e., DMWR) in appropriate technical publications. Overhaul is normally the highest degree of maintenance performed by the Army. Overhaul does not normally return an item to like new condition.

k. **Rebuild.** Consists of those services/actions necessary for the restoration of unserviceable equipment to a like new condition in accordance with original manufacturing standards. Rebuild is the highest degree of materiel maintenance applied to Army equipment. The rebuild operation includes the act of returning to zero those age measurements (hours, miles, etc.) considered in classifying Army equipments/components.

A3-3. Column Entries

a. Column 1, Group Number. Column 1 lists group numbers, the purpose of which is to identify components, assemblies, subassemblies, and modules with the next higher assembly.

b. Column 2, Component/Assembly. Column 2 contains the noun names of components, assemblies, subassemblies, and modules for which maintenance is authorized.

c. Column 3, Maintenance Functions. Column 3 lists the functions to be performed on the item listed in column 2. When items are listed without maintenance functions, it is solely for purpose of having the group numbers in the MAC and RPSTL coincide.

d. Column 4, Maintenance Category. Column 4 specifies, by the listing of a "worktime" figure in the appropriate subcolumn(s), the lowest level of maintenance authorized to perform the function listed in column 8. This figure represents the active time required to perform that maintenance function at the indicated category of maintenance. If the number or complexity of the tasks within the listed maintenance function vary at different maintenance categories, appropriate "worktime" figures will be shown for each category. The number of task-hours specified by the "worktime" figure represents the average time required to restore an item (assembly, subassembly, component, module, end item or system) to a serviceable condition under typical field operating conditions. This time includes preparation time, troubleshooting time, and quality assurance/quality control time in addition to the time required to perform the specific tasks identified for the maintenance functions authorized in the maintenance allocation chart. Subcolumns of column 4 are as follows:

- C-Operator/Crew
- O-Organizational
- F-Direct Support
- H-General Support
- D-Depot

e. Column 5, Tools and Equipment. Column 5 specifies by code, those common tool sets (not individual tools) and special tools, test, and support equipment required to perform the designated function. The tools and equipment are listed in table 1.

f. Column 6, Remarks. Column 6 contains an alphabetic code which leads to the remark in section IV, Remarks, which is pertinent to the item opposite the particular code.

A3-4. Tool and Test Equipment Requirements (see IV)

a. Tool or Test Equipment Reference Code. The numbers in this column coincide with the numbers used in the tools and equipment column of the MAC. The numbers indicate the applicable tool or test equipment for the maintenance functions.

b. Maintenance Category. The codes in this column indicate the maintenance category allocated the tool or test equipment.

c. Nomenclature. This column lists the noun name and nomenclature of the tools and test equipment required to perform the maintenance functions.

d. National/NATO Stock Number. This column lists the National/NATO stock number of the specific tool or test equipment.

e. Tool Number. This column lists the manufacturer's part number of the tool followed by the Federal Supply Code for manufacturers (5-digit) in parentheses.

A3-5. Remarks (see IV)

a. Reference Code. This code refers to the appropriate item in section II, column 6.

b. Remarks. This column provides the required explanatory information necessary to clarify items appearing in section II.

(Next printed page is A3-3.)

**SECTION II MAINTENANCE ALLOCATION CHART
FOR
ANTENNA EQUIPMENT RC-292**

(1) GROUP NUMBER	(2) COMPONENT/ASSEMBLY	(3) MAINTENANCE FUNCTION	(4) MAINTENANCE CATEGORY					(5) TOOLS AND EQPT.	(6) REMARKS
			C	O	F	H	D		
00	ANTENNA EQUIPMENT RC-292	Inspect	0.1						
		Service	0.2						
		Test		0.3				2,5	
		Test			0.3			3	
		Repair		1.0				1	
		Repair				0.5		4	

**SECTION III TOOL AND TEST EQUIPMENT REQUIREMENTS
FOR
ANTENNA EQUIPMENT RC-292**

TOOL OR TEST EQUIPMENT REF CODE	MAINTENANCE CATEGORY	NOMENCLATURE	NATIONAL/NATO STOCK NUMBER	TOOL NUMBER
1	0	Tool Kit, Electronic Equipment TK-101/G	5180-00-064-5178	
2	0	Multimeter AN/URM-105	6625-00-999-6282	
3	F	Multimeter AN/USM-223	6625-00-999-7465	
4	F	Tool Kit, Electronic Equipment TK-100/G	5180-00-605-0079	
5	0	Test Set, RF Power AN/URM-182	6625-00-148-9371	
		OR		
		Test Set, RF Power AN/URM-182A	6625-01-062-3599	

SECTION IV, REMARKS

REFERENCE CODE	REMARKS
A	Repair of Antenna Base MP-68 and replacement of all parts except guy stake assembly and Mast Sections AB-35/TRC-7.
B	Repair Cable Assembly, Radio Frequency CG-107/U.

By Order of the Secretary of the Army:

HAROLD K, JOHNSON,
General, United States Army,
Chief of Staff.

Official:

J. C. LAMBERT,
Major General, United States Army,
The Adjutant General

Distribution:

Active Army:

USASA (2)	USATC AD (2)
CNGB (1)	USATC Armor (2)
C-E (7)	USATC Engr (2)
Dir of Trans (1)	USATC Inf (2)
CofEngrs (1)	USASTC (2)
TSG (1)	WRAMC (1)
CofSptS (1)	Army Pic Cen (2)
USAAESWBD (5)	USACDCEC (10)
USAIB (5)	USAJFKCENSP WAR (5)
USACDC Agcy (1)	USAATC (5)
USAMC (5)	Ft Monmouth (70)
USCONARC (5)	Ft Hancock (4)
ARADCOM (5)	Ft Gordon (10)
ARADCOM Rgn (2)	Ft Huachuca (10)
OS Maj Cored (4) except	WCMR (5)
USAREUR (5)	Ft Carson (25)
USASETAF (5)	Ft Knox (12)
LOGCOMD (2)	Ft Devens (5)
USAMICOM (4)	Arlington Hall Sta (5)
USASMC (2)	Army Dep (5) except
USASCC (4)	SAAD (30)
USAECOM (30)	GENDEP (OS) (2)
USASPTCP (11)	Sig See, GENDEP (OS) (5)
MDW (1)	Sig Dep (OS) (12)
Armies (2) except	Sig Fld Maint Shops (2)
EUSA (5)	AMS (1)
Corps (2)	USAERDAA (2)
USAC (3)	USACRREL (2)
Div (2)	USAERDAW (13)
Bde (2)	MAAG, Vietnam (5)
Regt,Gp/bg (2)	USA Rsch Spt Gp (5)
Bn (2)	KMAG (5)
Co/Btry (2)	Units org under fol TOE:
Svc Colleges (2)	8-500 AA-AH (2)
USMA (5)	11-500 AA-AC (2)
Br Svc Sch (5)	

NG: State AG (3); Units Same as Active Army except allowance is one copy to each unit.

USA R: None.

For explanation of abbreviations used see AR 320-50,

