

TM 11-6625-274-12

DEPARTMENT OF THE ARMY TECHNICAL MANUAL

OPERATOR'S AND ORGANIZATIONAL
MAINTENANCE MANUAL

TEST SETS, ELECTRON TUBE TV-7/U,
TV-7A/U, TV-7B/U AND TV-7D/U

This copy is a reprint which includes current
pages front Charges 6 and 7.

HEADQUARTERS, DEPARTMENT OF THE ARMY

14 JUNE 1960

W A R N I N G

Be careful not to contact high-voltage connections or the 115-volt ac input connections when replacing tubes in the test set. Voltages up to 300 volts ac may be encountered in this equipment. Serious injury or death may result from contact with these connections.

DON'T TAKE CHANCES!

CHANGE }
NO. 7 }

HEADQUARTERS
DEPARTMENT OF THE ARMY
Washington, DC, 9 January 1984

OPERATOR'S AND ORGANIZATIONAL MAINTENANCE
MANUAL TEST SETS, ELECTRON TUBE

TV - 7 / U (NSN 6 6 2 5 - 0 0 - 3 7 6 - 4 9 3 9) ,
TV - 7 A / U (NSN 6 6 2 5 - 0 0 - 3 7 6 - 4 9 3 9) ,
TV - 7 B / U (NSN 6 6 2 5 - 0 0 - 3 7 6 - 4 9 3 9) ,
A N D
TV - 7 D / U (NSN 6 6 2 5 - 0 0 - 8 2 0 - 0 0 6 4)

TM 11-6625-274-12, 14 June 1960, is changed as follows:

Page 7. Delete paragraphs 1.1, 2, and 2.1 and substitute:

1.1. Consolidated Index of Army Publications and Blank Forms

Refer to the latest issue of DA Pam 310-1 to determine whether there are new editions, changes or additional publications pertaining to the equipment.

2. Maintenance Forms, Records, and Reports

a. *Reports of Maintenance and Unsatisfactory Equipment.* Department of the Army forms and procedures used for equipment maintenance will be those prescribed by TM 38-750, The Army Maintenance Management System.

b. *Report of Packaging and Handling Deficiencies.* Fill out and forward SF 364 (Report of Discrepancy (ROD)) and prescribed in AR 735-11-2/DLAR 4140.55/NAVMATINST 4355. 73A/AFR 400-54/MCO 4430.3F.

c. *Discrepancy in Shipment Report (DISREP) (SF 361).* Fill out and forward Discrepancy in Shipment Report (DISREP) (SF 361) as prescribed in AR 55-38/NAVSUPINST 4610.33C/AFR 75-18/MCO P4610.19D/DLAR 4500.15.

2.1. Reporting Errors and Recommending Improvements

You can help improve this manual. If you find any mistakes or if you know of a way to improve the procedures, please let us know. Mail your letter or DA Form 2028 (Recommended Changes to Publications and Blank Forms)

direct to: Commander, US Army Communications-Electronics Command and Fort Monmouth, ATTN: DRSEL-ME-MP, Fort Monmouth, New Jersey 07703. In either case, a reply will be furnished direct to you.

Paragraphs 2.2, 2.3 and 2.4 are added after paragraph 2.1.

2.2. Reporting Equipment improvement Recommendations (EIR)

If your electron tube test set needs improvement, let us know. Send us an EIR. You, the user, are the only one who can tell us what you don't like about your equipment. Let us know why you don't like the design. Put it on an SF 368 (Quality Deficiency Report). Mail it to Commander, US Army Communications-Electronics Command and Fort Monmouth, ATTN: DRSEL-ME-MP, Fort Monmouth, New Jersey 07703. We'll send you a reply.

2.3. Administrative Storage

Administrative Storage of equipment issued to and used by Army activities will have preventive maintenance performed in accordance with the PMCS charts before storing. When removing the equipment from administrative storage the PMCS should be performed to assure operational readiness. Disassembly and repacking of equipment for shipment or limited storage are covered in chapter 4 and TM 740-90-1.

2.4. Destruction of Army Electronics Materiel

Destruction of Army electronics materiel to prevent enemy use shall be in accordance with TM 750-244-2.

*This change supersedes C2, 30 Jan 1963; C4, 22 June 1966 and C5, 30 April 1974.

| NSN | QTY | Nomenclature, part No., and mfr code | Usable on code Fig. No. |
|---|-----|---|-------------------------|
| 6625-00-376-4939 | | Test Set, Electron Tube TV-7/U, TV-7A, B/U: dynamic mutual conductance type; 0.6 to 117 V fil voltage range meter indication; tube condition on 0 to 120 arbitrary scale; operating power requirements AC, 105 to 125 V, 50 to 1000 Hz single phase; SW positions A thru E; portable type | 1,2,3 |
| 6625-00-820-0064 | | Test Set, Electron Tube TV-7D/U: dynamic mutual conductance type; 0.6 to 117 V fil voltage range; meter indication; tube condition on 0 to 120 arbitrary scale; operating power requirements AC, 105 to 125 V, 50 to 1000 Hz single Phase; SW position A thru F, portable type consisting of: | |
| NOTE | | | |
| The part number is followed by the applicable 5-digit Federal supply code for manufacturers (FSCM) identified in SB 708-42 and used to identify manufacturer, distributor, or Government agency, etc. | | | |
| NOTE | | | |
| In usable on code column, number 1 refers to TV-7/U; number 2 refers to TV-7A/U; number 3 refers to TV-7B/U; number 4 refers to TV-7D/U. | | | |
| 5935-00-732-1919 | 1 | Adapter, Electron Tube Socket: SM-B-425536; 80063 | 1,2,3,4 8 |
| 5935-00-537-4056 | 1 | Adapter, Electron Tube Socket: SM-C-179260; 80063 | 1,2,3,4 8 |
| 5935-00-305-1189 | 1 | Adapter, Electron Tube Socket: SM-B-425538; 80063 | 1,2,3,4 8 |
| 6625-00-684-1189 | 1 | Adapter, Test: SM-B-425638; 80063 | 1,2,3,4 4 |
| 6625-00-618-9928 | 1 | Adapter, Test: SM-B-425639; 80063 | 1,2,3,4 4 |
| 6625-00-618-9929 | 1 | Adapter, Test: SM-B-425640; 80063 | 1,2,3,4 4 |
| 5935-00-808-1802 | 1 | Adapter, Electronic Tube Socket: nuvistor tube socket adapter; 1050-127; 28569 | 1,2,3,4 |
| 6625-00-069-1960 | 1 | Adapter, Test: socket for GE Micro-Miniature 7077 and 7486; 86-060; 04435 | 1,2,3,4 |
| 6625-00-668-4683 | 2 | Lead, Test: 12450-245; 28569 | 1,2,3 4 |
| 6625-00-727-7065 | 2 | Lead, Test: SM-B-425548; 80063 | 4 4 |

Page 17, paragraph 18c. Delete the note. down to 10, turn the BIAS control knob to full scale (100 on dial).

Page 18, paragraph 21d note. Change the note to read:

Page 22, chapter 3 heading. After the heading add:

NOTE

If the meter pointer cannot be adjusted

Section I. OPERATOR/CREW PREVENTIVE MAINTENANCE CHECKS AND SERVICES

Delete paragraphs 31, 32, 33 and figures 11 and 12 and substitute:

equipment other than those issued with the equipment.

31. Scope of Operator's Maintenance

a. Preventive maintenance checks and services chart (par. 33.1).

The maintenance duties assigned to the operator of Test Sets, Electron Tube TV-7/U, TV-7A/U, TV-7B/U, and TV-7D/U are listed below together with a reference to the paragraph covering the specific maintenance function. The duties assigned do not require tools or test

b. Visual inspection (par. 34).

c. Tube replacement (par. 37).

d. Replacement of lamps (par. 39).

32. General**NOTE**

Refer to TM 750-244-2 for proper procedures for destruction of this equipment to prevent enemy use.

a. Operator/crew preventive maintenance is the systematic care, servicing and inspection of equipment to prevent the occurrence of trouble, to reduce downtime, and to maintain equipment in serviceable condition. To be sure that your electron tube test set is always ready for your mission, you must do scheduled preventive maintenance checks and services (PMCS).

(1) BEFORE OPERATION, perform your B PMCS to be sure that your equipment is ready to go.

(2) When an item of equipment is reinstalled after removal, for any reason, perform the necessary B PMCS to be sure the item meets the readiness reporting criteria.

(3) Use the ITEM NO. column in the PMCS table to get the number to be used in the TM ITEM NO. column on DA Form 2404 (Equipment Inspection and Maintenance Worksheet) when you fill out the form.

b. Routine checks like CLEANING, DUSTING, WASHING, CHECKING FOR FRAYED CABLES, STOWING ITEMS NOT IN USE, COVERING UNUSED RECEPTACLES, CHECKING FOR LOOSE NUTS AND BOLTS AND CHECKING FOR COMPLETENESS are not listed as PMCS checks. They are things that you should do any time you see they must be done. If you find a routine check like one of operators reported problems with this item.

NOTE

When you are doing any PMCS or routine checks, keep in mind the warnings and cautions.

WARNINGS

- Adequate ventilation should be provided while using TRICHLOROTRIFLUOROETHANE. Prolonged breathing of vapor should be avoided. The solvent should not be used near heat or open flame; the products of decomposition are toxic and irritating. Since TRICHLOROTRIFLUOROETHANE dissolves natural oils, prolonged contact with skin should be

avoided. When necessary, use gloves which the solvent cannot penetrate. If the solvent is taken internally, consult a physician immediately.

- Compressed air is dangerous and can cause serious bodily harm if protective means or methods are not observed to prevent a chip or particle (of whatever size) from being blown into the eyes or unbroken skin of the operator or other personnel. Goggles must be worn at all times while cleaning with compressed air. Compressed air shall not be used for cleaning purposes except where reduced to less than 29 pounds per square inch gage (psig) and then only with effective chip guarding and personnel protective equipment. Do not use compressed air to dry parts when trichlorotrifluoroethane has been used.

NOTES

The PROCEDURES column in your PMCS charts instruct how to perform the required checks and services. Carefully follow these instructions and, if tools are needed or the chart so instructs, get organizational maintenance to do the necessary work.

If your equipment must be in operation all the time, check those items that can be checked and serviced without disturbing operation. Make the complete checks and services when the equipment can be shut down.

c. Deficiencies that cannot be corrected must be reported to higher category maintenance personnel. Records and reports of preventive maintenance must be made in accordance with procedures given in TM 38-750.

33. Operator/Crew Preventive Maintenance Checks and Services

Perform before operation PMCS if you are operating the item for the first time.

NOTE

The checks in the interval column are to be performed in the order listed.

Page 23. Add paragraph 33.1 after paragraph 33.

33.1. Operator/Crew Preventive Maintenance Checks and Services Chart

B-Before

| Item No. | Interval | Item to be Inspected | Procedures - Check for and have repaired or adjusted as necessary | Equipment is not Ready/Available If: |
|----------|----------|-----------------------------|---|---|
| | B | | | |
| 1 | * | Mission Essential Equipment | Check for completeness and satisfactory condition of the equipment. Report missing items. | Available equipment is insufficient to support the combat mission |
| 2 | ● | TV-7(*)/U Test Set | Accomplish starting procedure as described in paragraph 17. | |

*This check to be performed prior to redeployment or prior to reissue after repair or overhaul.

Add Section II and paragraphs 33.2 and 33.3 after paragraph 33.1 as follows:

Section II. ORGANIZATIONAL PREVENTIVE MAINTENANCE CHECKS AND SERVICES

33.2. Organizational Maintenance

Organizational preventive maintenance procedures are designed to help maintain equipment in serviceable condition. They include items to be checked and how to check them. These

checks and services, described in paragraph 33.3 outline inspections that are to be made at specific monthly (M) intervals.

33.3. Organizational Preventive Maintenance Checks and Services Chart

M-Monthly

| Item No. | Interval | Item to be Inspected | Procedures |
|----------|----------|----------------------|--|
| | M | | |
| 1 | ● | TV-7(*)/U Test Set | Accomplish performance check as described in paragraph 35. |

Page 30. Change title of chapter 4 to "SHIP-MENT AND LIMITED STORAGE".

Page 32. Delete section II in its entirety.

Page 33. Delete appendix I and substitute:

APPENDIX I

REFERENCES

The following is a list of applicable references available to the operator or organizational maintenance personnel of Test Set, Electron Tube TV-7(*)/U.

DA Pam 310-1

Consolidated Index of Army Publication and Blank Forms.

SB 38-100

Preservation, Packaging, Packing and Marking Materials, Supplies and Equipment Used by the Army.

TM 11-6625-274-24P

Organizational, Direct Support and General Support Maintenance Repair Parts and Special Tools Lists (Including Depot Maintenance

Repair Parts and Special Tools) for Test Sets, Electron Tube TV-7A/U. (NSN 6625-00-376-4939), TV-7B/U (6625-00-376-4939) and TV-7D/U (6625-00-820-0064).

TM 38-750 The Army Maintenance Management System (TAMMS).

TM 740-90-1 Administrative Storage of Equipment,

TM 750-244-2 Procedures for Destruction of Electronics Materiel to Prevent
Enemy Use.

Page 34. Appendix II deleted.

By Order of the Secretary of the Army:

JOHN A. WICKHAM JR.
General, United States Army
Chief of Staff

Official:

ROBERT M. JOYCE
Major General, United States Army
The Adjutant General

DISTRIBUTION:

To be distributed in accordance with DA Form 12-36B, Operator
and Crew Maintenance requirements for TV-7A-D/U.

Changes in force: C2, C4, C5, and C6

TM 11-6625-274-12
C 6

CHANGE }
No. 6 }

HEADQUARTERS
DEPARTMENT OF THE ARMY
WASHINGTON DC, 4 May 1982 ■

**Operator's and Organizational Maintenance Manual
Test Sets, Electron Tube
TV-7/U (NSN 6625-00-376-4939),
TV-7A/U (NSN 6625-00-376-4939),
TV-7B/U (NSN 6625-00-376-4939),
AND
TV-7D/U (NSN 6625-00-820-0064)**

TM 11-6625-274-12, 14 June 1960, is changed as follows:

Change the title of the manual as shown above.

Inside front cover. Add the following warnings:

WARNING

Adequate ventilation should be provided while using TRICHLOROTRIFLUOROETHANE. Prolonged breathing of vapor should be avoided. The solvent should not be used near heat or open flame; the products of decomposition are toxic and irritating. Since TRICHLOROTRIFLUOROETHANE dissolves natural oils, prolonged contact with the skin should be avoided. When necessary, use gloves which the solvent cannot penetrate. If the solvent is taken internally, consult a physician immediately.



5

SAFETY STEPS TO FOLLOW IF SOMEONE IS THE VICTIM OF ELECTRICAL SHOCK

1

DO NOT TRY TO PULL OR GRAB THE INDIVIDUAL

2

IF POSSIBLE , TURN OFF THE ELECTRICAL POWER

3

IF YOU CANNOT TURN OFF THE ELECTRICAL POWER, PULL, PUSH, OR LIFT THE PERSON TO SAFETY USING A WOODEN POLE OR A ROPE OR SOME OTHER INSULATING MATERIAL

4

SEND FOR HELP AS SOON AS POSSIBLE

5

AFTER THE INJURED PERSON IS FREE OF CONTACT WITH THE SOURCE OF ELECTRICAL SHOCK, MOVE THE PERSON A SHORT DISTANCE AWAY AND IMMEDIATELY START ARTIFICIAL RESUSCITATION

Page 7. Paragraphs 1.1, 2, and 2.1 are superseded as follows:

1.1. Index of Technical Publications

Refer to the latest issue of DA Pam 310-4 to determine whether there are new editions, changes, or additional publications pertaining to the equipment.

2. Maintenance Forms, Records and Reports

a. Reports of Maintenance and Unsatisfactory Equipment. Department of the Army forms and procedures used for equipment maintenance will be those prescribed by TM 38-750, The Army Maintenance Management System.

b. Report of Packaging and Handling Discrepancies. Fill out and forward SF 364 (Report of Discrepancy (ROD)) as prescribed in AR 735-11-2/DLAR 4140.55/NAVMATINST 4355.73/AFR 400-54/MCO 4430.3E.

c. Discrepancy in Shipment Report (DISREP)

(SF 361). Fill out and forward Discrepancy in Shipment Report (DISREP) (SF 361) as prescribed in AR 55-38/NAVSUPINST 4610.33B/AFR 75-18/MCO P4610.19C and DLAR 4500.15.

2.1. Reporting Errors and Recommending Improvements

You can help improve this manual. If you find any mistakes or if you know of a way to improve the procedures, please let us know. Mail your letter or DA Form 2028 (Recommended Changes to Publications and Blank Forms) direct to Commander, US Army Communications-Electronics Command, ATTN: DRSEL-ME-MQ, Fort Monmouth, NJ 07703. In either case, a reply will be furnished direct to you. Page 8, paragraph 5.1. Lines 9 and 10 are superseded as follows:

6625-668-4683 2 Lead, Test: 12450-245; 28569 1,2,3 4
 6625-727-7065 2 Lead, Test: SM-B-425548; 80063 4 4

Paragraph 7 is superseded as follows:

| Item | TV-7/U | TV-7A/U | TV-7B/U | TV-7D/U |
|--|---|---|---|--------------------------------------|
| F RANGE on FUNCTION SWITCH. | Not used. | Not used. | Not used. | Used. |
| BIAS and SHUNT controls | Markings engraved on a dail. | Markings etched into test set panel. | Markings etched into test set panel. | Markings etched into test set panel. |
| SHORTS lamp | No panel marking. | Panel marking. | Panel marking. | Panel marking. |
| Subminiature tube test socket X109. | Rectangular. | Round on some equipment. | Rectangular. | Rectangular. |
| Storage chip for ac line cord plug. | Not used. | Used. | Used. | Used. |
| Storage clips for test leads | Not used. | Not used. | Used. | Used. |
| Tip of test lead plug (2 each) | 3/32-inch diameter on original equipment may be 5/64-inch on rehabilitated equipment. | 3/32-inch diameter on original equipment may be 5/64-inch on rehabilitated equipment. | 3/32-inch diameter on original equipment may be 5/64-inch on rehabilitated equipment. | 5/64-inch diameter. |

Page 9. Paragraph 7 chart is superseded as follows:

| Item | TV-7/U | TV-7A/U | TV-7B/U | TV-7D/U |
|---------------------------------------|--|--|--|--|
| Grid (G), plate (P), and NOISE jacks. | Accommodates 3/32-inch diameter tip plugs on original equipment may be 5/64-inch on rehabilitated equipment. | Accommodates 3/32-inch diameter tip plugs on original equipment may be 5/64-inch on rehabilitated equipment. | Accommodates 3/32-inch diameter tip plugs on original equipment may be 5/64-inch on rehabilitated equipment. | Accommodates 5/64-inch diameter tip plugs. |
| Gasket around edge of cover | Not used. | Used. | Used. | Used. |

| Item | TV-7/U | TV-7A/U | TV-7B/U | TV-7D/U |
|---|---------------|---------------|---------------|-----------|
| Socket saver adapters X10B, X7B, and X3B, 7-pin and 9-pin miniature and octal base. | Not provided. | Not provided. | Not provided. | Provided. |

Page 22. Paragraph 33.1 warning is superseded as follows:

WARNING

Adequate ventilation should be provided while using TRICHLOROTRIFLUOROETHANE. Prolonged breathing of vapor should be avoided. The solvent should not be used near heat or open flame; the products of decomposition are toxic and irritating. Since TRICHLOROTRIFLUOROETHANE dissolves natural oils, prolonged contact with the skin should be avoided. When necessary, use gloves which the solvent cannot penetrate. If the solvent is taken internally, consult a

physician immediately.

Page 33, Appendix I. TM 11-6625-274-25P is superseded as follows:

TM 11-6625-274-24P Organizational, Direct Support, and General Support Maintenance Repair Parts and Special Tools Lists (Including Depot Maintenance Repair Parts and Special Tools) for Test Sets, Electron Tube TV-7A/U (NSN 6625-00-376-4939), TV-7B/U (6625-00-376-4939) and TV-7D/U (6625-00-820-0064).

Page 37. Appendix III is superseded as follows:

APPENDIX III

MAINTENANCE ALLOCATION

Section I. INTRODUCTION

1. General

This appendix provides a summary of the maintenance operations for the TV-7/U, TV-7A/U, TV-7B/U and TV-7D/U. It authorizes categories of maintenance for specific maintenance functions on repairable items and components and the tools and equipment required to perform each function. This appendix may be used as an aid in planning maintenance operations.

2. Maintenance Function

Maintenance functions will be limited to and defined as follows:

a. Inspect. To determine the serviceability of an item by comparing its physical, mechanical, and/or electrical characteristics with established standards through examination.

b. Test. To verify serviceability and to detect incipient failure by measuring the mechanical or electrical characteristics of an item and comparing those characteristics with prescribed standards.

c. Service. Operations required periodically to keep an item in proper operating condition, i.e., to clean (decontaminate), to preserve, to drain, to paint, or to replenish fuel, lubricants, hydraulic fluids, or compressed air supplies.

d. Adjust. To maintain, within prescribed limits, by bringing into proper or exact position, or by setting the operating characteristics to the specified parameters.

e. Align. To adjust specified variable elements of an item to bring about optimum or desired performance.

f. Calibrate. To determine and cause corrections to be made or to be adjusted on instruments or test measuring and diagnostic equipments used in precision measurement. Consists of comparisons of two instruments, one of which is a certified standard of known accuracy, to detect and adjust any discrepancy in the accuracy of the instrument being compared.

g. Install. The act of emplacing, seating, or fixing into position an item, part, module (component

or assembly) in a manner to allow the proper functioning of the equipment or system.

h. Replace. The act of substituting a serviceable like type part, subassembly, or module (component or assembly) for an unserviceable counterpart.

i. Repair. The application of maintenance services (inspect, test, service, adjust, align, calibrate, replace) or other maintenance actions (welding, grinding, riveting, straightening, facing, remachining, or resurfacing) to restore serviceability to an item by correcting specific damage, fault, malfunction, or failure in a part, subassembly, module (component or assembly), end item, or system.

j. Overhaul. That maintenance effort (service/action) necessary to restore an item to a completely serviceable/operational condition as prescribed by maintenance standards (i.e., DMWR) in appropriate technical publications. Overhaul is normally the highest degree of maintenance performed by the Army. Overhaul does not normally return an item to like new condition.

k. Rebuild. Consists of those services/actions necessary for the restoration of unserviceable equipment to a like new condition in accordance with original manufacturing standards. Rebuild is the highest degree of materiel maintenance applied to Army equipment. The rebuild operation includes the act of returning to zero those age measurements (hours, miles, etc.) considered in classifying Army equipments/components.

3. Column Entries

a. Column 1, Group Number. Column 1 lists group numbers, the purpose of which is to identify components, assemblies, subassemblies, and modules with the next higher assembly.

b. Column 2, Component/Assembly. Column 2 contains the noun names of components, assemblies, subassemblies, and modules for which maintenance is authorized.

c. Column 3, Maintenance Functions. Column 3 lists the functions to be performed on the item listed in column 2. When items are listed without maintenance functions, it is solely for purpose of having the group numbers in the MAC and RPSTL coincide.

d. Column 4, Maintenance Category. Column 4 specifies, by the listing of a "work time" figure in the appropriate subcolumn(s), the lowest level of maintenance authorized to perform the function listed in column 3. This figure represents the active time required to perform that maintenance function

at the indicated category of maintenance. If the number or complexity of the tasks within the listed maintenance function vary at different maintenance categories, appropriate "work time" figures will be shown for each category. The number of task-hours specified by the "work time" figure represents the average time required to restore an item (assembly, subassembly, component, module, end item or system) to a serviceable condition under typical field operating conditions. This time includes preparation time, troubleshooting time, and quality assurance/quality control time in addition to the time required to perform the specific tasks identified for the maintenance functions authorized in the maintenance allocation chart. Subcolumns of column 4 are as follows:

- C—Operator/Crew
- O—Organizational
- F—Direct Support
- H—General Support
- D—Depot

e. Column 5, Tools and Equipment. Column 5 specifies by code, those common tool sets (not individual tools) and special tools, test, and support equipment required to perform the designated function.

f. Column 6, Remarks. Column 6 contains an alphabetic code which leads to the remark in section IV, Remarks, which is pertinent to the item opposite the particular code.

4. Tool and Test Equipment Requirements (Sect. III)

a. Tool or Test Equipment Reference Code. The numbers in this column coincide with the numbers used in the tools and equipment column of the MAC. The numbers indicate the applicable tool or test equipment for the maintenance functions.

b. Maintenance Category. The codes in this column indicate the maintenance category allocated the tool or test equipment.

c. Nomenclature. This column lists the noun name and nomenclature of the tools and test equipment required to perform the maintenance functions.

d. National/NATO Stock Number. This column lists the National/NATO stock number of the specific tool or test equipment.

E. Tool Number. This column lists the manufacturer's part number of the tool followed by the Federal Supply Code for manufacturers (5-digit) in parentheses.

5. Remarks (Sect. IV)

a. Reference Code. This code refers to the appropriate item in section II, column 6.

b. Remarks. This column provides the required explanatory information necessary to clarify items appearing in section II.

(Next printed page is 7)

SECTION IV. REMARKS

| REFERENCE CODE | REMARKS |
|-------------------|---|
| A | REPLACEMENT OF KNOBS, FUSES, AND LAMPS. |

By Order of the Secretary of the Army:

E. C. MEYER
General, United States Army
Chief of Staff

Official:

ROBERT M. JOYCE
Brigadier General, United States Army
The Adjutant General

Distribution:

To be distributed in accordance with Special List.

**SECTION II MAINTENANCE ALLOCATION CHART
FOR**

TEST SETS ELECTRON TUBE TV-7/U, TV-7A/U, TV-7B/U AND TV-7D/U

| (1) GROUP NUMBER | (2) COMPONENT/ASSEMBLY | (3) MAINTENANCE FUNCTION | (4) MAINTENANCE CATEGORY | | | | | (5) TOOLS AND EQT. | (6) REMARKS |
|------------------------|---|--|-----------------------------|----------------|---|-------------------|---|--|----------------|
| | | | C | O | F | H | D | | |
| 00 | TUBE TESTER TV-7U TV-7A/U TV-7B/U TV-7D/U | Service Test Calibrate Repair Repair | | 0.5 0.5 | | 0.5 1.5 3.0 | | 2, 11, 13 1, 4, 14-18 1-10 1-10, 12 | A |

**SECTION III TOOL AND TEST EQUIPMENT REQUIREMENTS
FOR
TEST SET ELECTRON TUBE TV-7/U, TV-7A/U, TV-7B/U AND TV-7D/U**

| COLOR TEST EQUIPMENT REF CODE | MAINTENANCE CATEGORY | NOMENCLATURE | NATIONAL/NATO STOCK NUMBER | TOOL NUMBER |
|-------------------------------|----------------------|--|----------------------------|-------------|
| 1 | HD | TUBE SOCKET ADAPTER MX-1258/U | 6625-00-301-0815 | |
| 2 | HD | *VOLTMETER ME-459/U | 6625-00-229-0457 | |
| 3 | HD | VARIABLE TRANSFORMER CN-16/U | 5950-00-235-2086 | |
| 4 | HD | MULTI METER TS-352 (*)/U | 6625-00-242-5023 | |
| 5 | HD | RESISTOR FIXED (10,000 OHMS) | 5905-00-117-4194 | |
| 6 | HD | ISOLATION TRANSFORMER | 5950-00-498-2146 | |
| 7 | HD | DECADE RESISTOR ZM-16/U | 6625-00-669-0266 | |
| 8 | HD | RESISTOR FIXED (12,000 OHMS) | 5905-00-107-5148 | |
| 9 | HD | RESISTOR FIXED (100,000 OHMS) | 5905-00-120-0894 | |
| 10 | HD | RESISTOR FIXED (375,000 OHMS) | | |
| 11 | HD | RESISTOR FIXED (510,000 OHMS) | 5905-00-279-2516 | |
| 12 | HD | LIGHT ASSEMBLY MX-1292 | 6695-00-378-5449 | |
| 13 | H | TOOL KIT ELECTRONIC EQUIPMENT TK-100 | 5180-00-605-0079 | |
| 14 | D | ELECTRON TUBE OC3 | 5960-00-864-7516 | |
| 15 | D | ELECTRON TUBE 5Y3 | 5960-00-262-0218 | |
| 16 | D | ELECTRON TUBE 6AU6 | 5960-00-169-9346 | |
| 17 | D | ELECTRON TUBE 6L6 | 5960-00-228-0054 | |
| 18 | D | ELECTRON TUBE 5678 | 5960-00-230-5262 | |
| | | *IF THE ME-459/U VOLTMETER IS NOT AVAILABLE, ALL MODELS OF THE ME-30(*)/U VOLTMETER MAY BE USED. | | |

TEST SETS, ELECTRON TUBE
 TV-7/U, TV-7A/U, TV-7B/U, AND TV-7D/U

| | Paragraph | Page |
|-------------------|---|-----------|
| CHAPTER 1. | INTRODUCTION | |
| Section I. | General | |
| | Scope | 1 3 |
| | Forms and records | 2 7 |
| II. | Description and data | |
| | Purpose and use | 3 7 |
| | Technical characteristics | 4 7 |
| | Table of components | 5 7 |
| | Description of test set | 6 8 |
| | Differences in models | 7 8 |
| CHAPTER 2. | INSTALLATION AND OPERATING INSTRUCTIONS | |
| Section I. | Service upon receipt of equipment | |
| | Unpacking | 8 10 |
| | Checking unpacked equipment | 9 11 |
| II. | Controls and indicator | |
| | General | 10 11 |
| | Controls, indicators, and jacks | 11 11 |
| III. | Operation under usual conditions | |
| | General instructions | 12 13 |
| | Test leads | 13 14 |
| | Tube test sockets | 14 14 |
| | Tube test data | 15 14 |
| | Adapters | 16 15 |
| IV. | Operating test set | |
| | Starting procedure | 17 16 |
| | Operating procedure | 18 16 |
| | Checking filament continuity (12-volt Filament tubes) | 19 17 |
| | Reading meter | 20 18 |
| | Gas test | 21 18 |
| | Noise test | 22 19 |
| | Panel lamp test | 23 19 |
| | Testing special tube types | 24 19 |
| | Testing subminiature tubes | 25 19 |
| | Stopping procedure | 26 20 |

*This manual supersedes so much of TM 11-5083, 29 September 1953, including C1, 2 September 1955; C2, 8 February 1956, and C3, 1 April 1959, as pertains to operation and organizational maintenance; so much of C4, 26 August 1959, as pertains to packaging and repackaging; TM 11-6625-274-10P, 11 June 1959, and so much of TM 11-6625-274-20P, 11 June 1959, as pertains to the maintenance allocation chart.

| | Paragraph | Page |
|--------------------|---|-------|
| V. | Operation under unusual conditions | |
| | General | 27 20 |
| | Operation at low temperatures | 28 21 |
| | Operation under tropical conditions | 29 21 |
| | Operation in desert climates | 30 21 |
| CHAPTER 3 . | MAINTENANCE INSTRUCTIONS | |
| | General | 31 22 |
| | Materials required | 32 22 |
| | Preventive maintenance | 33 22 |
| | Visual inspection | 34 25 |
| | Equipment performance checklist | 35 25 |
| | Removal of chassis | 36 27 |
| | Tube replacement | 37 27 |
| | Preferred-type tubes | 38 28 |
| | Replacement of lamps | 39 28 |
| CHAPTER 4 . | SHIPMENT, LIMITED STORAGE, AND DEMOLITION TO PREVENT ENEMY USE | |
| Section I. | Shipment and limited storage | |
| | Removal from service | 40 30 |
| | Repackaging for shipment or limited storage | 41 30 |
| II. | Demolition of materiel to prevent enemy use | |
| | Authority for demolition | 42 32 |
| | Methods of destruction | 43 32 |
| APPENDIX I. | REFERENCES | 33 |
| II. | OPERATOR'S MAINTENANCE REPAIR PARTS AND SPECIAL TOOLS LIST | 34 |
| III. | MAINTENANCE ALLOCATION CHART | 37 |

CHAPTER 1
INTRODUCTION

Section I. GENERAL

1. Scope

a. This manual describes Test Sets, Electron Tube TV-7/U (fig. 1), TV-7A/U (fig. 2), TV-7B/U (fig. 3), and TV-7D/U (fig. 4), and covers installation, operation, and first and second echelon maintenance. It includes in-

structions for operation under usual and unusual conditions, cleaning and inspection of the equipment, and replacement of parts available to first and second echelon maintenance personnel.

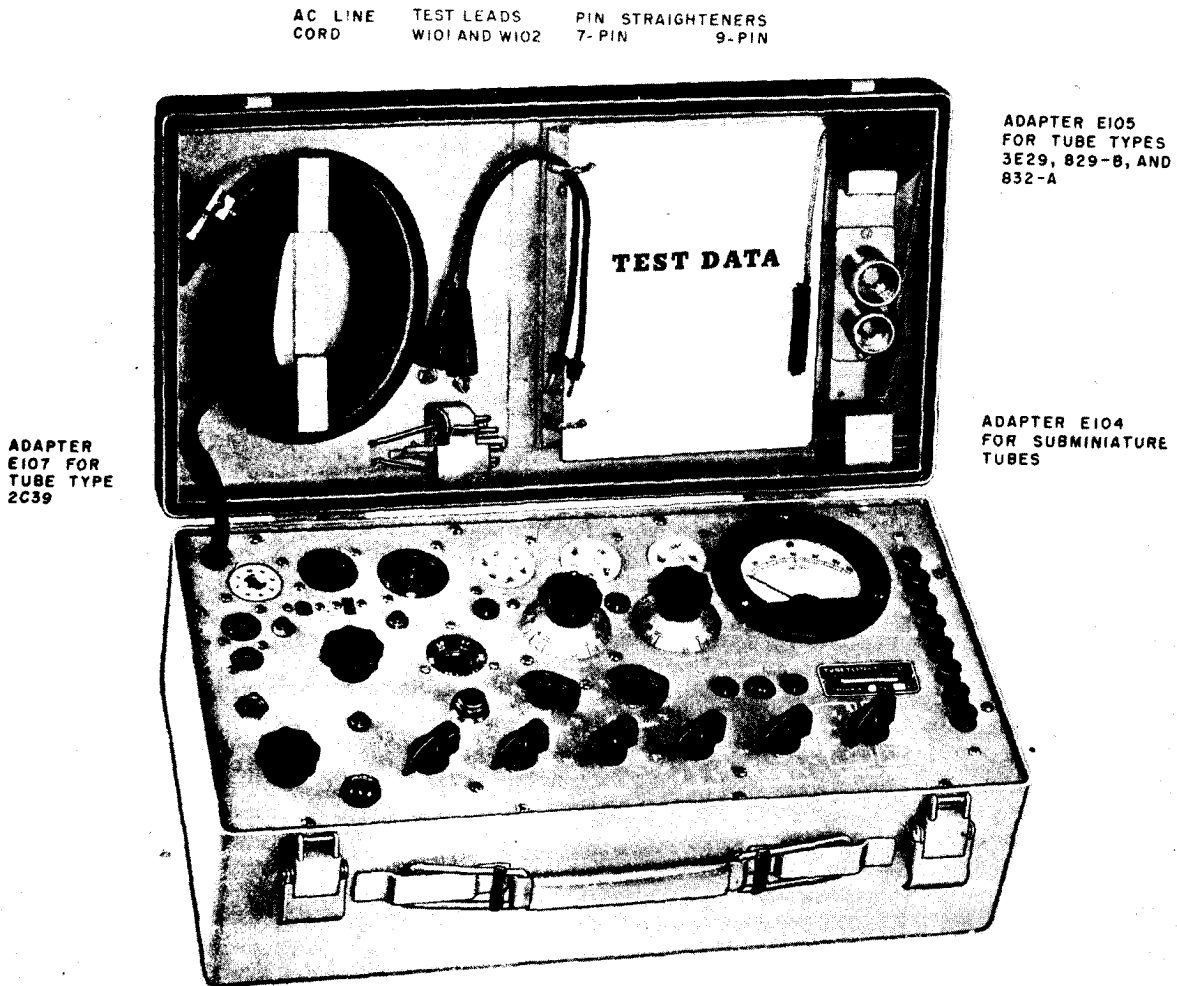

TM6625-274-12-1

Figure 1. Test Set, Electron Tube TV-7/U, less running spares.

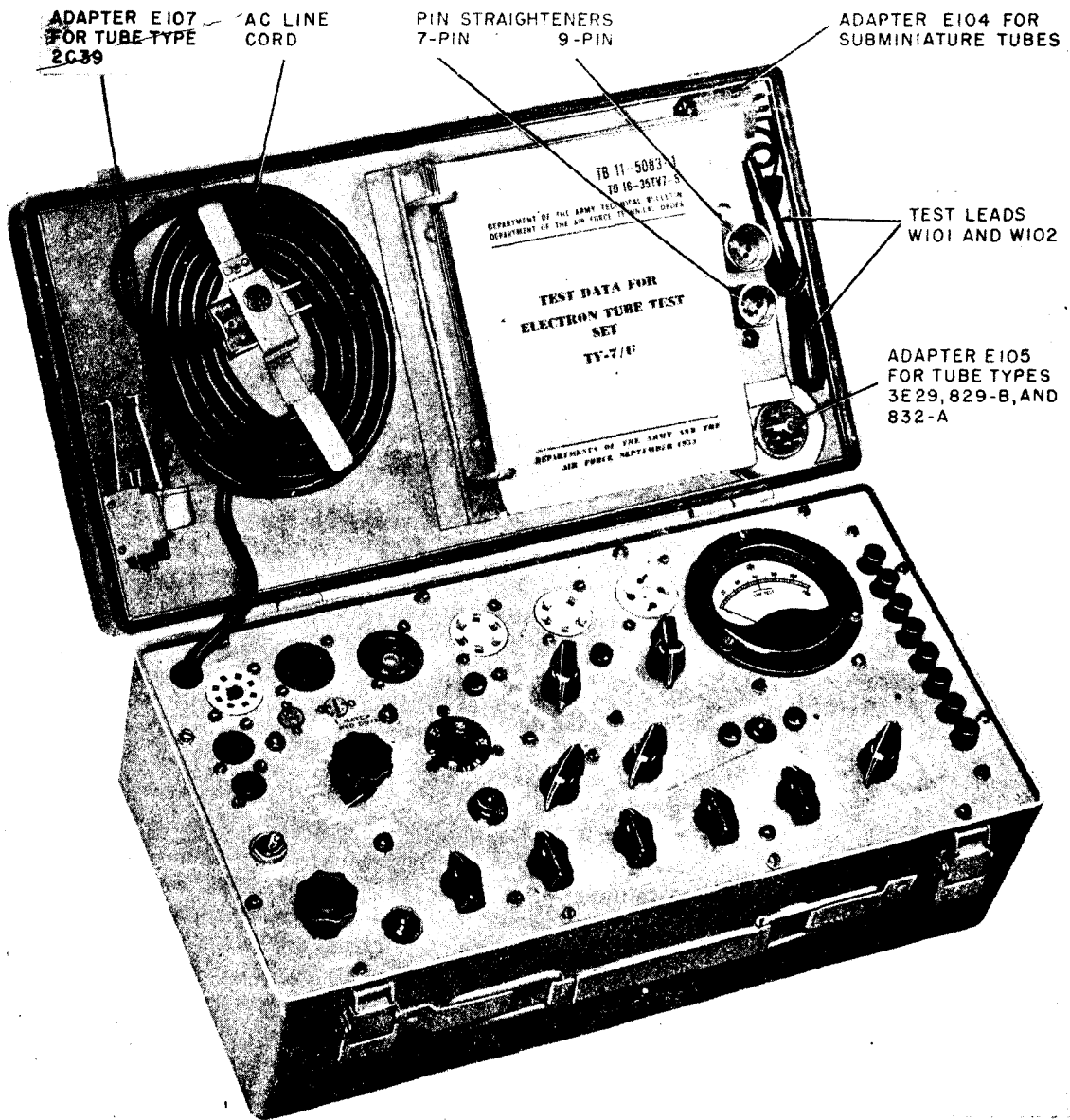

TM6625-274-12-14

Figure 2. Test Set, Electron Tube TV-7A/U, less running Spares.

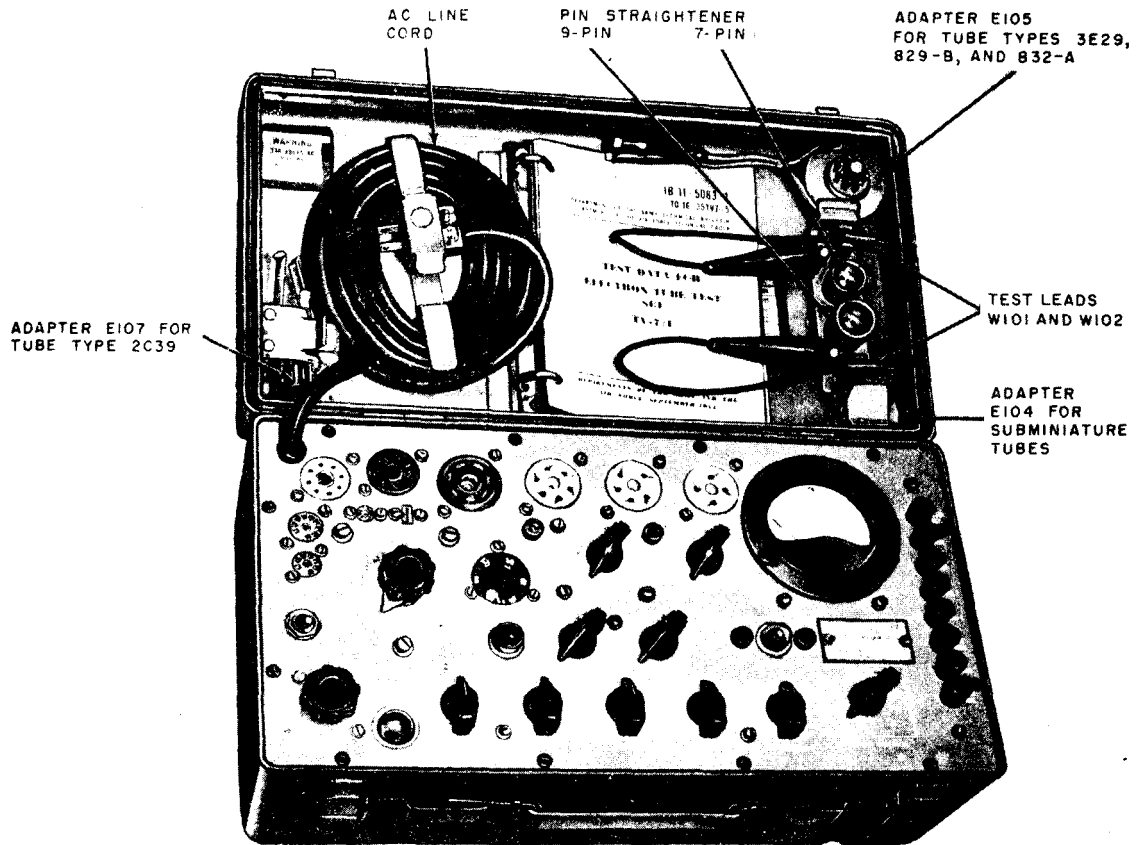

TM6625-274-12-2

Figure 3. Test Set, Electron Tube TV-7B/U, less running spares.



Figure 4. Test Set, Electron Tube TV-7D/U, less running spares.

b. Official nomenclature followed by (*) is used to indicate all models of the equipment item covered in this manual. Thus, Test Set, Electron Tube TV-7(*)/U represents Test Sets, Electron Tube TV-7/U, TV-7A/U, TV-7B/U, and TV-7D/U.

2. Forms and Records

a. *Electronic Failure Report.* Fill out and forward DD Form 787-1, Electronic Failure Report-Signal Equipment, to the Commanding Officer, U.S. Army Signal Equipment Support Agency, Fort Monmouth, N.J., as prescribed in AR 700-39.

b. *Unsatisfactory Equipment Report.* Fill out and forward AF TO Form 29, Unsatisfactory Report, to the Commander, Air Materiel Command, Wright-Patterson Air Force Base, Ohio, as prescribed in AF TO 00-35D-54.

c. *Report of Damaged or Improper Shipment.* Fill out and forward DD Form 6, Re-

port of Damaged or Improper Shipment, as prescribed in AR 700-58 (Army), Navy Shipping Guide, Article 1850-4 (Navy), and AFR 71-4 (Air Force).

d. *Preventive Maintenance Form.* Prepare DA Form 11-266 (fig. 11 and 12), Maintenance Check List for Signal Equipment (Test Equipment), in accordance with instructions on the form.

e. *Parts List Form.* Any comments concerning omissions and discrepancies in appendix II or III in this manual will be prepared on DA Form 2028 and forwarded directly to the Commanding Officer, U.S. Army Signal Equipment Support Agency, Fort Monmouth, N.J. ATTN: SIGFM/ES-ML.

f. *Comments on Manual.* Forward all other comments on this manual direct to the Commanding Officer, U.S. Army Signal Publications Agency, Fort Monmouth, N.J.

Section II DESCRIPTION AND DATA

3. Purpose and Use

Test Set Electron Tube TV-7(*)/U is a portable tube tester of the dynamic mutual conductance type. It is used to test and to measure performance capabilities and to determine rejection limits for electron tubes used in receivers, low-powered transmitters, and many other electronic equipments. The following tests can be made with Test Set Electron Tube TV-7(*)/U:

- a. Continuity test (ballast tubes).
- b. Dynamic mutual conductance test (amplifier tubes).
- c. Emission test (rectifier tubes).
- d. Gas test (amplifier tubes).
- e. Noise test.
- f. Panel lamp test.
- g. Shorts test.

4. Technical Characteristics

Power Supply:
 Input voltage 103.5 to 126.5 Volts ac, single phase.
 Frequency 50 to 1,000 cps.
 Power consumption 45 watts at 115 volts, 50 cps.
 Meter 0 to 120 arbitrary units.
 Operating temperature limits -40° to + 125° Fahrenheit.
 Number of tubes 2.
 Indicator lights:
 PILOT One type 47.
 SHORTS One type NE-45.
 FUSE One type 81.

5. Table of Components

The components of Test Set, Electron Tube TV-7(*)/U are listed in *a* below and the spare parts in *b* below.

a. Components.

| Quantity | Item | Dimensions (In.) | | | Unit weight (lb) |
|----------|--|------------------|-------|--------|------------------|
| | | Height | Depth | Length | |
| 1 | Test set including tubes and lamps | 6 1/16 | 8% | 15% | 18 |
| 1 | Adapter E105: 3E29, 829-B or 832-A tubes | | | | |
| 1 | Adapter E107: 2C39 tube | | | | |
| 1 | Adapter E104: Subminiature tubes | | | | |
| 1 | Adapter X10B: socket saver, 7-pin miniature (TV-7D/U)..... | | | | |
| 1 | Adapter X7B: socket saver, 9-pin miniature (TV-7D/U)..... | | | | |
| 1 | Adapter X3B: socket saver, octal (TV-7D/U) | | | | |
| 2 | Test leads | | | | |
| 1 set | Running spares (b below) | | | 1 5 | |

b. Spare Parts.

| Quantity | Item |
|----------|-----------------------------|
| 1 | Electron tube, type 5Y3WGTA |
| 1 | Electron tube, type 83 |
| 1 | Lamp, neon NE-45 |
| 1 | Lamp, incandescent No. 47 |
| 1 | Lamp, incandescent No. 81 |

binder inside the cover holds TB 11-5083-1 (tube test data book (par. 15)). The cover is hinged by slip hinges and can be removed from the case.

b. An indicating meter and all controls, knobs, pushbuttons, sockets, and indicating lamps are on the front panel. The necessary data for setting and operating the controls to test the various tube types are contained in the tube test data book (a above). One end of the alternating current (ac) line cord is permanently attached to the panel; the other end terminates in a male plug.

6. Description of Test Set

(fig. 1-4)

a. Test Set, Electron Tube TV-7(*)/U (test set) is self-contained in a carrying case equipped with a carrying handle. The cover is secured to the case by luggage-type fasteners. Retainer brackets on the inside of the cover are used to secure and store the power cable, pin straighteners for 7- and 9-pin miniature tubes, and adapters (par. 16). A ring

7. Differences in Models

Test Sets, Electron Tube TV-7(*)/U are similar in purpose, operation, and appearance. Some models have been modified to improve operational features. External differences are as follows:

| Item | TV-7/U | TV-7A/U | TV-7B/7 | TV-7D/U |
|--|------------------------------|--------------------------------------|--------------------------------------|--------------------------------------|
| F RANGE on FUNCTION SWITCH. | Not used. | Not used. | Not used. | Used. |
| BIAS and SHUNT controls | Markings engraved on a dial. | Markings etched into test set panel. | Markings etched into test set panel. | Markings etched into test set panel. |
| SHORTS lamp | No panel marking. | Panel marking. | Panel marking. | Panel marking. |
| Subminiature tube test socket X109. | Rectangular. | Round on some equipments. | Rectangular. | Rectangular. |
| Storage clip for ac line cord plug. | Not used. | Used. | Used. | Used. |
| Storage clips for test leads | Not used. | Not used. | Used. | Used. |
| Tip of test lead plug (2 each) | 3/32-inch diameter. | 5/64-inch diameter. | 3/32-inch diameter. | 3/32-inch diameter. |

| Item | TV-7/U | TV-7A/U | TV-7B/U | TV-7D/U |
|---|--|--|--|--|
| Grid (G), plate (P), and NOISE jacks. | Accommodates 3/32-inch diameter tip plugs. | Accommodates 5/64-inch diameter tip plugs. | Accommodates 3/32-inch diameter tip plugs. | Accommodates 3/32-inch diameter tip plugs. |
| Gasket around edge of cover | Not used. | Used. | Used. | Used. |
| Socket saver adapters X10B, X7B, and X3B, 7-pin and 9-pin miniature and octal base. | Not provided. | Not provided. | Not provided. | Provided. |

CHAPTER 2
INSTALLATION AND OPERATING INSTRUCTIONS

Section I SERVICE UPON RECEIPT OF EQUIPMENT

8. Unpacking

a. Packaging Data. When packed for shipment, the test set is packaged in an inner fiberboard carton. Spare parts are in a small, corrugated carton, protected by a sleeve on top of the test set. The inner fiberboard carton is sealed with gummed tape, and is then placed within an outer fiberboard carton, with all seams and joints sealed with water-resistant, pressure-sensitive tape. A wooden packing case may also be used when a multiple of four test sets is shipped. The wooden packing case

will be strapped only for intertheater shipment. A typical packing case and its contents are shown in figure 5.

- (1) The inside dimensions of a packing case that contains four packaged test sets is approximately $18\frac{3}{4}$ by $20\frac{1}{2}$ by $15\frac{3}{4}$ inches; the volume is 4.8 cubic feet, and the weight is 106 pounds.
- (2) The outside dimensions of a test set packed in fiberboard cartons is $21\frac{1}{2}$ by $10\frac{7}{8}$ by $8\frac{1}{2}$ inches; the volume is

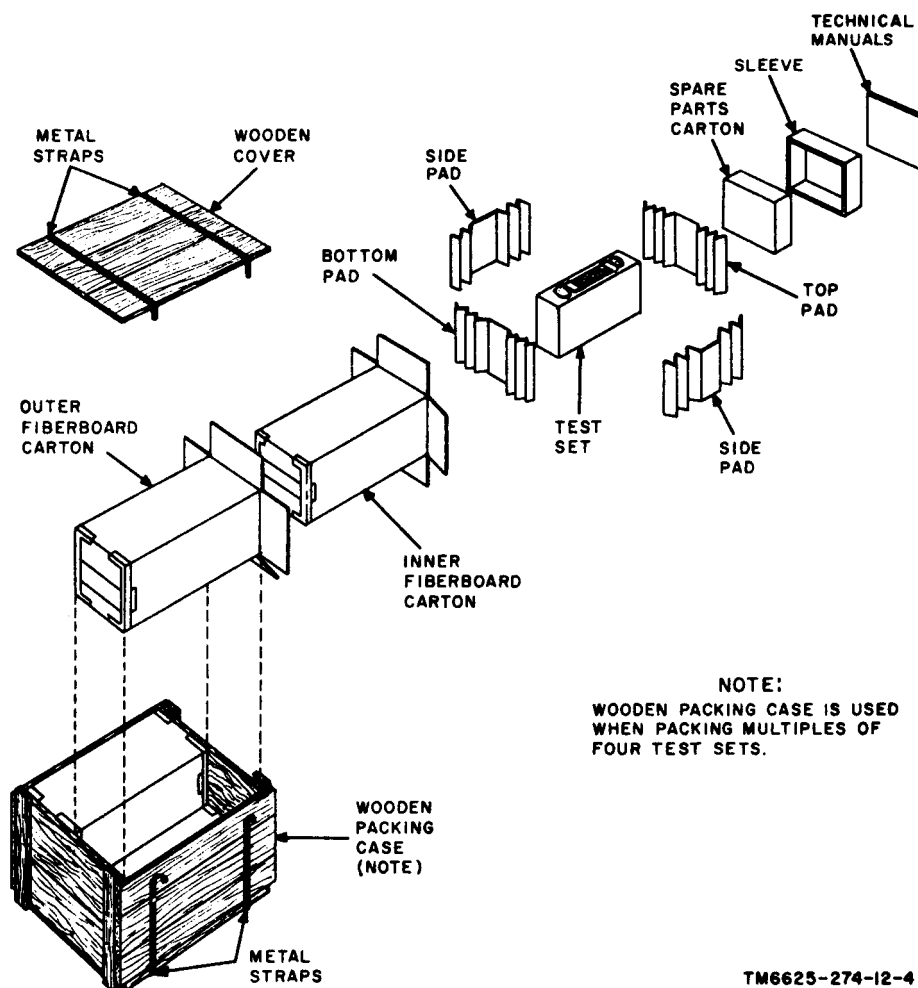

Figure 5. Typical packaging.

1.2 cubic feet, and the weight is **21½** pounds.

b. Removing Contents.

- (1) Cut and fold back the metal straps (when used).
- (2) Remove the nails from the wooden cover and one side of the wooden packing case with a nailpuller. Remove the cover and the side. Do not attempt to pry off the cover or the side; prying may damage the equipment.
- (3) Remove the envelope that contains the technical manuals.
- (4) Remove the outer fiberboard carton from the wooden packing case.
- (5) Open the outer fiberboard carton and remove the inner fiberboard carton.

- (6) Open the inner fiberboard carton and remove the contents.

9. Checking Unpacked Equipment

Check the equipment against the packing list. When no packing list accompanies the equipment, use the table of components (par. 5) as a general check. If the equipment is damaged, refer to paragraph 2. After a test set is removed from its fiberboard container, release the fasteners, open the cover, and proceed as follows:

- a. Check to see that the adapters (fig. 8) are held firmly to the cover.
- b. Check all controls for ease of rotation. Tighten loose knobs.
- c. Check for a broken meter glass and broken lamps.
- d. Check the ac line cord, test leads, and rubber gasket around the edge of the cover (except on TV-7/U) for signs of deterioration.

Section II. CONTROLS AND INDICATORS

10. General

Improper setting of the FILAMENT VOLTAGE switch (fig. 6) or incorrect operation of the pushbutton switches may damage the tube under test. Be sure that all the controls and switches are set properly before testing tubes.

11. Controls, Indicators, and Jacks

a. Switches and Controls.

| Switch or control | Function |
|--|---|
| POWER switch | ON: Connects ac power to test set. OFF: Removes ac power from test set. |
| FILAMENT VOLTAGE (20-position rotary switch) | Provides an 18-step selection of filament voltages from 0.6-volt to 117 volts ac. BLST.: Enables ballast tubes to be tested for continuity and supplies voltage to certain rectifier tubes for emission tests. |

| Switch or control | Function |
|---|---|
| | OFF: Removes voltage from FILAMENT VOLTAGE switch. |
| FILAMENT selectors, left and right (10-position, 5-section rotary switches) | Connects filament of tube under test to filament voltage supply. |
| GRID selector (10-position, 5-section rotary switch) | When set in one of positions 1-9, connects control grid of tube under test to bias and signal voltages. |
| PLATE selector (10-position, 5-section rotary switch) | When set in one of positions 1-9, connects plate of tube under test to plate voltage supply. |
| SCREEN selector (10-position, 5-section rotary switch) | When set in one of positions 1-9, connects screen grid of tube under test to screen voltage supply. |
| CATHODE selector (10-position rotary switch, 0-position open) | When set in one of positions 1-9, connects cathode of tube under test to desired test circuit. |
| SUPPRESSOR selector (10-position rotary switch, 0-position open) | When set in one of positions 1-9, connects suppressor grid of tube under test to desired test circuit. |

| Switch or control | Function |
|---|---|
| FUNCTION SWITCH (11-position, 8-section rotary switch (TV-7D/U), 10-position, 6-section rotary switch on all other models) | SHORTS: Positions 1-5 connect various elements of tube under test to shorts test circuit. RANGES: Positions A-E (A-F, TV-7D/U) control sensitivity of meter circuit and magnitude of signal voltage. |
| LINE ADJUST control | Adjusts amount of input voltage to power transformer. |
| BIAS control | Adjusts amount of bias voltage applied to tube under test. |
| SHUNT control | Adjusts sensitivity of meter circuit. |

b. Pushbutton Switches.

| Pushbutton switch | Function |
|----------------------|---|
| | <i>Switch position Action</i> |
| 1-LINE ADJ | Depressed Connects meter into line test circuit. Normal Disconnects meter from line test circuit. |
| 2-DIODE | Depressed Connects diode tube under test to an ac test voltage, and connects low screen grid voltage (if required) to tube under test when pushbutton 3-MUT. COND. is depressed. ^a Normal Removes ac test voltage from diode under test and connects normal screen grid voltage (if required) to tube under test when pushbutton 3-MUT. COND. is depressed. |
| 3-MUT. COND. | Depressed Connects tube under test to plate and screen grid (when required) voltages. |

| Pushbutton switch | Function |
|---|--|
| | <i>Switch position Action</i> |
| | Normal Removes plate and screen grid (when used) voltages from tube under test. |
| 4-GAS 1 | Depressed Connects ac test voltage to certain diode tubes and connects plate voltage and bias voltage to tube under test when checking amplifier tubes for gas. Normal Removes diode test voltage or plate voltage and bias voltage from amplifier tube under test. |
| 5-GAS 2 (used with 4-GAS 1 when amplifier tubes are tested for gas) | Depressed Connects a resistor into control grid circuit of tube under test. Normal Short-circuits resistor in control grid circuit of tube under test. |
| 6-OZ4. | Depressed Connects tube under test to an ac test voltage. ^a Normal Removes ac voltage from tube under test. |
| 7-RECT. | Depressed Connects tube under test to an ac test voltage. ^a Normal Removes ac voltage from tube under test. |
| 8-METER REV. | Depressed Reverses polarity of voltage applied to meter. Normal Permits normal polarity of voltage to be applied to meter. |

^a Voltage will vary slightly, depending on LINE ADJUST setting.

c. Meter, Indicator Lamps, and Jacks.

Note. The jacks on the TV-7A/U accommodate 5/64-inch diameter tip plugs; the jacks on all other models of the test set accommodate 3/32-inch diameter tip plugs.

| Meter, indicator lamp, or jack | Function | Meter, indicator lamp or jack | Function |
|---|---|-------------------------------|---|
| Meter..... | Indicates condition of tube under test. A LINE TEST mark at midscale is used to establish correct input voltage to power transformer. | FUSE lamp | A fuse and an overload indicator. |
| SHORTS lamp (not a panel marking on TV-7/U) | Indicates and locates shorted tube elements. | Grid (G) and plate (P) jacks | Provide a means of connecting grid and plate test leads to bias and plate voltage circuits, respectively. |
| PILOT lamp | Indicates when power is delivered to test set. | NOISE test jacks (2) | Enables test set operator to check level of noise generated by tube under test. |

Section III. OPERATION UNDER USUAL CONDITIONS

12. General Instructions

Do not operate the test set until the functions of the controls and the indicators (par. 11), the

operating procedure (par. 18), and the use of the test data book (par. 15) are understood. Refer to paragraph 24 whenever a special testing procedure is indicated in the test data book.

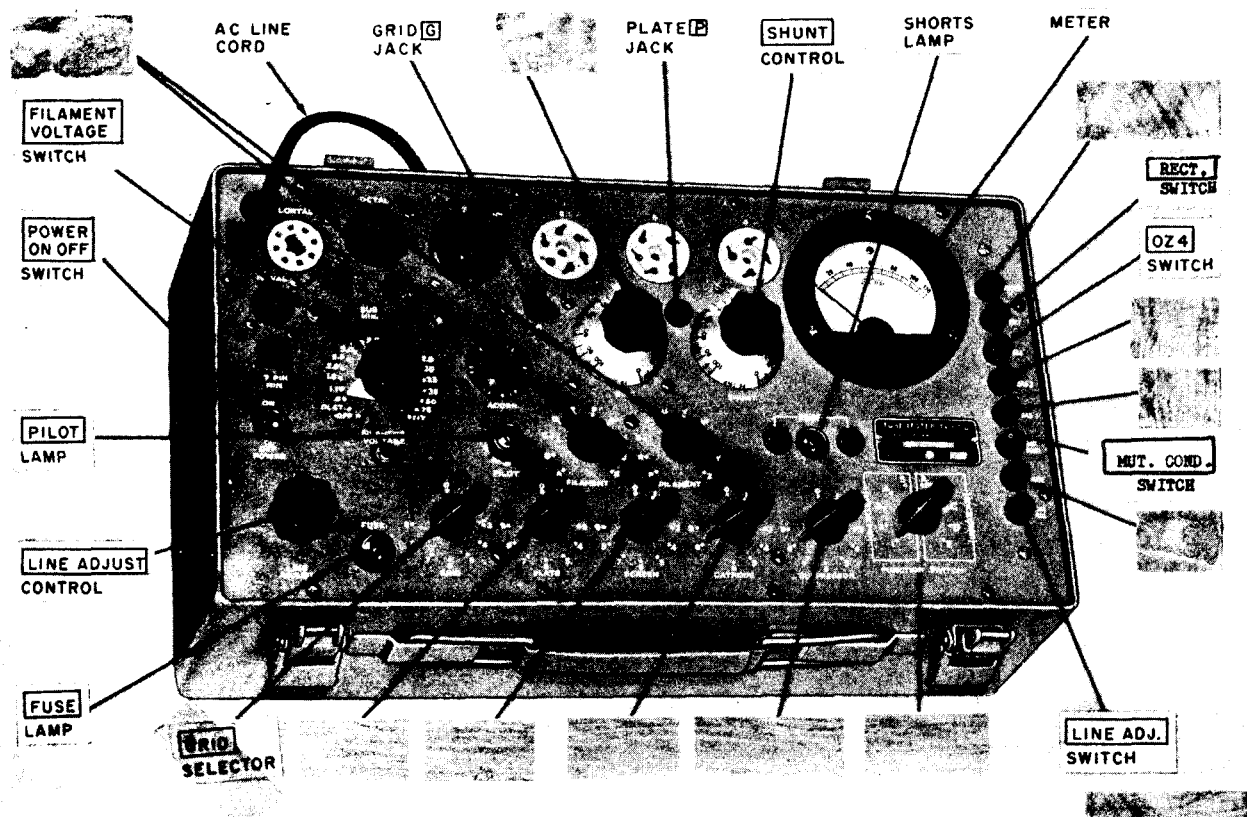

Figure 6. Test Set, Electron Tube TV-7/U, front panel.

13. Test Leads

Two test leads are provided to make connections from the grid (G) and the plate (P) panel jacks to the top caps of tubes under test. Each test lead is terminated on one end in a 3/32-inch diameter tip plug (5/64-inch on TV-7A/U) and on the other end in a battery-type clip with an insulating cover. The test leads are stored inside the cover of the test set case.

14. Tube Test Sockets

(fig. 7)

After the controls on the test set have been set as directed in the tube test data book (par. 15), place the tube to be tested in the proper tube test socket listed below. Socket-saver adapters (par. 16d) are mounted in the 7- and 9-pin miniature sockets and in the octal socket on the TV-7D/U (fig. 4).

| Tube test socket | Tube type tested |
|--------------------|--|
| 4 pin. | Four-pin standard tubes. |
| 5 pin. | Five-pin standard tubes. |
| 6 pin. | Six-pin standard tubes. |
| 7 pin. | Seven-pin standard tubes and panel lamps. |
| OCTAL. | Octal (8-pin) tubes. |
| LOKTAL. | Loktal base (8-pin) tubes. |
| SUB MIN. (2). | Round (8-pin) or flat-type (7-pin) subminiature tubes. |
| NOVAL. | Nine-pin miniature tubes. |
| 7 PIN MIN. | Seven-pin miniature tubes. |
| ACORN. | Acorn type tubes. |

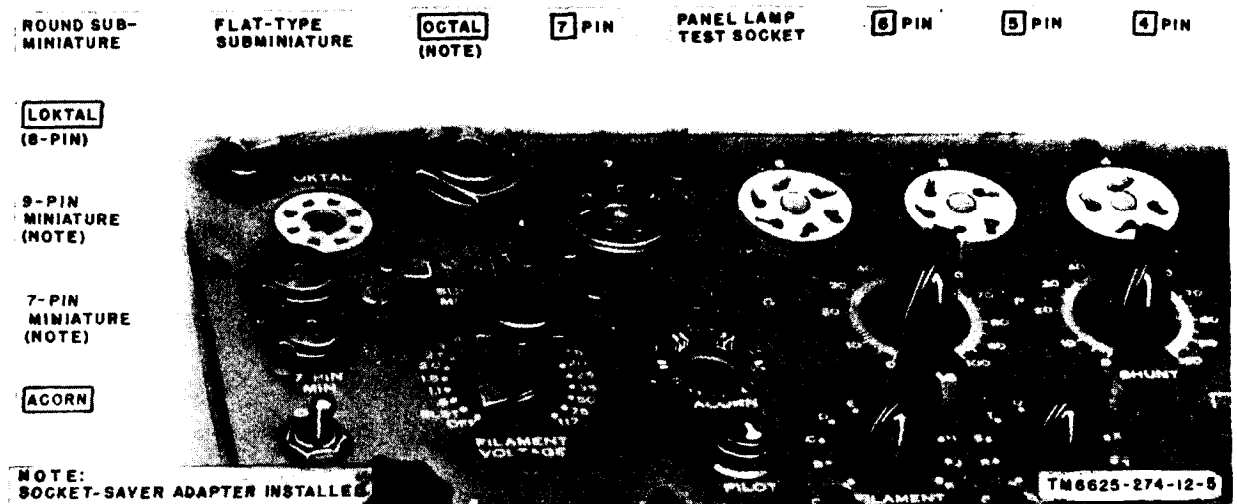

Figure 7. Test sockets, socket-saver adapters installed.

15. Tube Test Data

TB 11-5083-1 (test data book) is mounted on the inside of the cover of the test set. The test data book contains operating instructions for the test set, information necessary to set the controls when testing various tube types, a conversion table for VT tube designations, and a data table for CV type tubes. The control settings for the various tube types are tabulated in nine columns. Read the headings from left to right as follows:

a. *Tube Type.* Type numbers of electron tubes which the test set is designed to test are listed numerically and alphabetically in this column. Tubes that have type letters instead of numbers, such as XXB, are listed at the end of the table.

b. *Fil.* Correct filament or heater voltages for the listed tube types are shown in this column.

c. *Selectors.* The correct setting for the two FILAMENT selectors and the GRID, PLATE,

SCREEN, CATHODE, and SUPPRESSOR selectors are listed in this column. The settings are shown in the same order in which the switches appear on the panel, listing first the two FILAMENT selectors and then continuing, from left to right, with the remaining selectors.

d. Bias. This column lists the setting for the BIAS control.

e. Shunt. This column lists the setting for the SHUNT control. Setting of this control is required only when the FUNCTION SWITCH is in the RANGES A SHUNT position.

f. Range. The settings for the FUNCTION SWITCH are listed in this column. The letters A through E (A through F, TV-7D/U) correspond to the RANGES markings for the FUNCTION SWITCH.

g. Press. Under this heading are listed the test pushbuttons that are used for the various tube types and their individual sections in the case of multipurpose tubes.

h. Min Value. The minimum, numerical values of meter indication for the various tubes and individual sections of multipurpose tubes are shown in this column. Any tube showing a meter reading less than the value indicated in this column should be replaced.

i. Notations. Special information pertaining to particular tube types is listed under this heading.

16. Adapters

a. Adapter E104. Adapter E104 (fig. 8) enables subminiature tubes with long leads to

be tested in the OCTAL socket of the test set. A spring locking action grips the leads of the tube after they are inserted in the adapter. Pull the two tabs upward to open the lock before inserting the leads. The lock is secured by pressing down on the two tabs until a click is heard.

b. Adapter E105. Adapter E105 (fig. 8) enables tube type 3E29, 829-B, or 832-A to be tested in the OCTAL socket of the test set. The adapter consists of a special socket for these tubes mounted on an octal base. The two leads on the adapter connect to the two plate caps of the tube under test.

c. Adapter E107. Adapter E107 (fig. 8) enables tube type 2C39 (a lighthouse tube) to be tested in the OCTAL socket of the test set. The three pairs of spring contacts, from the center outward, connect to the cathode and one side of the filament, to the grid, and to the plate, respectively, of the tube under test. The center contact connects to the other side of the filament of the tube under test.

d. Socket-Saver Adapters (TV-7D/U). Three socket-saver adapters (fig. 7) are included with each TV-7D/U: one 7-pin miniature, one 9-pin miniature, and one octal. The adapters are installed in their corresponding sockets and receive the wear rather than the permanent socket. When worn so that satisfactory contact can no longer be made, the socket-saver adapters can be replaced without disconnecting the leads from their respective test socket.

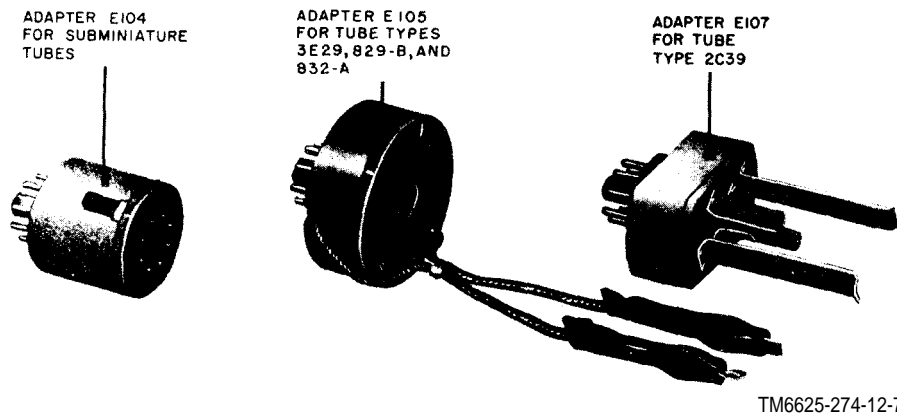

Figure 8. Adapters E104, E105, and E107.

Section IV. OPERATING TEST SET

17. Starting Procedure

Before operating the test set, perform the starting procedure below to check the general operation of the equipment. If the results obtained from the procedures in *b* through *e* below are satisfactory, the test set is ready for operation.

Note. If an abnormal indication is obtained during the starting procedure, refer to the equipment performance checklist (par. 35) for corrective measures.

a. Connect the test set to a 115-volt ac, 50- to 1,000-cycle per second (CPS), power source.

b. Set the POWER switch to the ON position; the PILOT lamp should light.

c. Press pushbutton 1 - LINE ADJ. Rotate the LINE ADJUST control knob until the meter pointer rests over the LINE TEST mark on the meter face.

d. Release pushbutton 1 - LINE ADJ.

e. Check the short test circuit.

(1) Set the left FILAMENT selector at A, the right FILAMENT selector at P, and the GRID, PLATE, SCREEN, CATHODE, and SUPPRESSOR selectors at 0, 0, 0, 2, and 2, respectively.

(2) Rotate the FUNCTION SWITCH through the five SHORTS positions. The neon SHORTS lamp (fig. 6) should glow in positions 2 and 3 of the FUNCTION SWITCH to indicate that the short test circuit is functioning properly.

f. Set the POWER switch to the OFF position.

18. Operating Procedure

The procedures below apply to single-section and multipurpose tubes (tubes that have more than one set of elements in the same envelope). Test each section or group of elements of a multipurpose tube separately. Test data for the multipurpose tube types are listed by sections (pentode sect., triode sect., diode sect., etc) in the test data book.

Caution: Do not insert a tube into a test socket until all the controls have been set in accordance with the instructions below.

a. *Selectors.* The FILAMENT (left and right), GRID, PLATE, SCREEN, CATHODE,

and SUPPRESSOR selector switches select the test socket connections so that correct test voltages are applied to the elements of the tube under test. For clarity, these selector switches will, in some instances, be referred to collectively as "the selectors". When referred to collectively, they are considered in the same order as above.

b. *Setting Controls.*

(1) Locate the type number of the tube to be tested in the test data book (fig. 1-4).

(2) Turn the FILAMENT VOLTAGE knob to the position shown in the *Fil* column of the test data book.

(3) Set the selectors to the letters and the numbers indicated in the *Selectors* column in the test data book. Be sure the numbers indicated by the selector knobs are the same, if read from left to right, as the numbers in the test data book.

Example: To test a tube type 6SN7, the *Selectors* column in the test data book indicates that the selectors are to be set at HY4-5062. Start at the left and turn the FILAMENT (left) selector knob to H, and the FILAMENT (right) selector knob to Y. Turn the GRID selector knob to number 4; the PLATE selector knob to number 5; the SCREEN selector knob to number 0; the CATHODE selector knob to number 6; and the SUPPRESSOR selector knob to 2. The sequence of letters and numbers thus selected (HY4-5062) is identical with that listed in the test data book. The selectors are interconnected electrically so that two different voltages cannot be applied to the same tube pin at the same time. Therefore, accidental shorts are avoided.

(4) Set the BIAS control to the number indicated in the *Bias* column of the test data book.

(5) Set the SHUNT control to the number indicated in the *Shunt* column of the test data book. If no setting is indicated, disregard this step and proceed with the steps below.

(6) Set the FUNCTION SWITCH knob to 1.

(7) Insert the tube to be tested in the

proper test socket (fig. 7) and, if the instructions in the *Notations* column require it, connect panel jacks G or P to the tube caps with the test leads.

- (8) Set the POWER switch to the ON position. The PILOT lamp should light.

Note. For tubes of the heater cathode type, allow approximately 5 to 10 seconds for the cathode to reach operating temperature before testing the tube.

- (9) Adjust the meter pointer (par. 17c and d) to the LINE TEST mark on the meter scale.

Note. Some tubes, such as the 17DE4 and the 32ET5, require the meter pointer to be set at a position other than the LINE TEST mark. Refer to the *Notations* column of the test data book before testing the tube.

c. Shorts Test.

- (1) Turn the FUNCTION SWITCH knob from position 1 to position 5; meanwhile tap the tube lightly and watch the neon SHORTS lamp on each switch position. Tubes with shorted elements will cause the lamp to glow.

Note. A list of tubes that are not to be tapped during the shorts test is contained in the test data book.

- (2) A short is indicated by a steady glow on *both* halves of the SHORTS lamp. A flash when the switch is turned from one position to another does not indicate a defective tube. Intermittent flashing when the tube is tapped indicates the existence of loose elements which can cause noisy or erratic operation.
- (3) Tubes that have more than one section, such as the 25D8, must be tested for shorts on each section.
- (4) Discard a shorted tube without further tests.

Note. Some tubes will show a shorted condition on certain positions of the FUNCTION SWITCH even though they are good tubes. Check the *Notations* column in the test data book for remarks. "Short on 1 and 2" would mean that a short indication in positions 1 and 2 is normal.

- (5) If the tube is not shorted, other tests may be performed as required.

d. *Selection of Range.* Turn the FUNCTION SWITCH knob from the SHORTS side of the switch to the RANGES position indicated in the test data book under the column headed *Range*. This automatically sets the sensitivity of the meter circuit to the proper level for the tube under test.

e. *Operating Pushbuttons.*

Caution: Do not press pushbutton 3 - MUT. COND. when testing rectifier tubes.

- (1) Press the pushbutton (par. 11b) that is indicated in the *Press* column of the test data book.

Caution: Release the pushbutton as soon as the meter pointer comes to rest and the meter indication is read. If the pushbutton is depressed too long, the tube under test may be damaged.

- (2) Refer to the *Notations* column for special information pertaining to specific tube types.
- (3) When the correct pushbutton is depressed, the meter will indicate the condition of the tube. Compare the meter reading to the value indicated in the *Min value* column of the test data book.

19. Checking Filament Continuity (12-Volt Filament Tubes)

Certain electron tubes in the 12-series may have open filament center taps that may not affect the testing or the operation of these tubes, if the tube is used in a 12-volt filament circuit. The test set does not have a specific filament continuity test circuit. A visual check for filament continuity of tube types 12AT7, 12AU7, 12AV7, 12AX7, and 12AZ7 can be made as follows:

- a. Perform the starting procedures (par. 17).
- b. Set the FILAMENT VOLTAGE switch to 12.6.
- c. Set the left and right FILAMENT selector switches to E and to V, respectively.
- d. Set the GRID, PLATE, SCREEN, CATHODE, and SUPPRESSOR selector switches each at zero.

e. Insert the tube in its proper test socket and perform the procedures in paragraph 17b through *d*.

f. Observe the filament of the tube; both sides should be lighted.

Note. Do not prolong the continuity test; keep the filament lighted just long enough to make a thorough observation.

g. Set the POWER switch to the OFF position, and set the FILAMENT VOLTAGE switch to 6.3.

h. Set the left and right FILAMENT selector switches to K and V, respectively.

i. Perform the procedures in paragraph 17b through *d*.

j. Observe the filament of the tube; only one-half the filament should be lighted.

k. Set the POWER switch to the OFF position, and set the left and right FILAMENT selector switches to E and Z, respectively.

l. Perform the procedures in paragraph 17b through *d*.

m. Observe the filament of the tube; the other half of the filament should be lighted.

n. If the tube shows filament continuity, proceed to test the tube in accordance with the instructions in paragraphs 20 through 22.

20. Reading Meter

The meter scale is calibrated in divisions from 0 to 120. When the proper pushbutton is depressed, the meter pointer will indicate the condition of the tube under test as a numerical value. The numerical value of the meter reading is then compared to the minimum acceptable value in the *Min value* column in the test data book. If the number indicated on the meter is less than the listed minimum value, the tube should be replaced. The following chart may be used to convert the numerical value of the meter reading to mutual conductance in micromhos.

| Meter reading | Corresponding value in micromhos | | | |
|---------------|----------------------------------|---------|---------|----------------|
| | Range B | Range C | Range D | Range E (Note) |
| 0 | 0 | 0 | 0 | 0 |
| 10 | 250 | 500 | 1,250 | 2,500 |
| 20 | 500 | 1,000 | 2,500 | 5,000 |
| 30 | 750 | 1,500 | 3,750 | 7,500 |
| 40 | 1,000 | 2,000 | 5,000 | 10,000 |

| Meter reading | Corresponding value in micromhos | | | |
|---------------|----------------------------------|---------|---------|----------------|
| | Range B | Range C | Range D | Range E (Note) |
| 50 | 1,250 | 2,500 | 6,250 | 12,500 |
| 60 | 1,500 | 3,000 | 7,500 | 15,000 |
| 70 | 1,750 | 3,500 | 8,750 | 17,500 |
| 80 | 2,000 | 4,000 | 10,000 | 20,000 |
| 90 | 2,250 | 4,500 | 11,250 | 22,500 |
| 100 | 2,500 | 5,000 | 12,500 | 25,000 |
| 110 | 2,750 | 5,500 | 13,750 | 27,500 |
| 120 | 3,000 | 6,000 | 15,000 | 30,000 |

Note. Ranges E and F, TV-79/U.

21. Gas Test

Pushbuttons 4 - GAS 1 and 5 - GAS 2 are used when testing amplifier tubes for gas content. Multipurpose tubes are tested for gas only on the amplifier sections; the gas test does *not* apply to diode sections or to rectifier tubes. Allow tubes of the filament type to warm up before testing the tube for gas content.

a. Perform the procedures in paragraph 17a through *d* and *f*.

b. Set the controls as indicated in the test data book.

c. Insert the tube in the proper test socket and set the POWER switch to ON.

d. Hold down pushbutton 4 - GAS 1 and adjust the BIAS control (fig. 6) until the meter pointer indicates 10 on the scale.

Note. If the meter pointer cannot be adjusted down to 10, turn the BIAS control knob until the meter reading is 100.

e. Hold down pushbutton 4 - GAS 1 and press pushbutton 5 - GAS 2.

f. If the tube contains gas, the meter pointer will move up the scale. A movement of more than 1 division on the scale indicates a gassy tube.

g. Turn off the test set (par. 26).

22. Noise Test

The NOISE test jacks on either side of the SHORTS lamp (fig. 6) are used when testing electron tubes for noise. A radio receiver or an audio amplifier with a loudspeaker, and a set of test leads, are required to perform the test.

a. Perform the starting procedures (par. 17).

b. Set the controls for the tube under test as indicated in the test data book, and set the POWER switch to ON.

c. Set the FUNCTION SWITCH to SHORTS 1.

d. Connect a test lead to each of the NOISE jacks.

e. Connect the test lead from the left-hand NOISE jack to the chassis of the radio receiver or the audio amplifier.

f. Connect the test lead from the right-hand NOISE jack to either the antenna of a radio receiver or to the input of an audio amplifier. Turn the radio receiver or the audio amplifier power switch to the on position.

g. Tap the tube under test while the FUNCTION SWITCH is turned from position 1 through position 5.

h. Intermittent disturbances within the tube which are too brief to register on the SHORTS lamp will be reproduced as static by the loudspeaker.

i. Turn off the test set (par. 26).

23. Panel Lamp Test

The receptacle in the center of the large, 7-pin socket (fig. 7) is used to check panel lamps.

a. Perform the procedures in paragraph 17a through *d* and *f*.

b. Set the FILAMENT selector switches to HR.

c. Set the FILAMENT VOLTAGE switch to the proper voltage for the lamp to be tested. If the exact voltage is not known, set the FILAMENT VOLTAGE switch to 0.6 volt and increase the voltage as required.

d. Insert the lamp in the receptacle and press the center contact of the lamp firmly against the bottom of the receptacle; then tilt the lamp until the metal shell makes contact with the rim of the receptacle. A defective lamp will not light.

e. Turn off the test set (par. 26).

24. Testing Special Tube Types

a. *Special Testing Procedures.* Certain electron tubes, such as the 6CD7, 6DA5, 6360, and 6524, require a special testing procedure.

The 1-megohm resistors required to test the 6CD7 and the 6DA5, and the 30-volt battery required to test the 6360 and the 6524, are not supplied with the test set. The selectors are set for the tube under test in the normal manner. However, *before* the POWER switch is set to the ON position, the resistors or the battery is connected to the test socket pins as directed in the test data book.

Caution: Disconnect the 30-volt battery before resetting any of the selector switches.

b. *Voltage Regulators.* When voltage regulator tubes are tested, sufficient voltage must be applied to ionize the gas and to cause the voltage regulator tube to conduct. Refer to the test data book for the proper use of the pushbuttons and for control settings.

c. *Thyratrons.* To test thyratrons, set the controls as indicated in the test data book. Press the proper pushbutton and adjust the BIAS control until the tube strikes; this is indicated by a glow between the tube elements and a sharp rise of the meter pointer. The limits of the bias voltage between which the tubes should strike are shown in the test data book. After the tube strikes, the condition of the tube is read on the meter.

d. *Tuning Eye Tubes.* Set the controls as indicated in the test data book. When the proper pushbutton is depressed, note the effect on the tuning eye and compare it to the data in the *Notations* column. When the eye is closed, a thin, bright line is observed; when the eye is open, a wide, dark area is observed.

25. Testing Subminiature Tubes

Subminiature tubes are tested in SUB. MIN. sockets X109 and X110 (fig. 9).

a. Subminiature tubes of the round type with short wire leads or pins are tested in special socket X110. This circular socket has eight contacts.

- (1) Several basing arrangements (fig. 10) are used for these tubes. The arrows near several of the tube bases in figure 10 indicate the location of the dot on the base of the tube. Check the *Notations* column in the test data book; examine the tube and identify the basing. Use adapter E104 (par. 16a) when the subminiature tube has long leads.

(2) Insert the leads or pins in the corresponding contacts of socket X110. If the leads are long enough, set the POWER switch to the OFF position, grasp each lead about one-eighth inch from its end with the tips of a pair of long-nosed pliers, and insert the leads into the proper socket contacts. Set the POWER switch to the ON position and test the tube.

b. Subminiature tubes of the flat or in-line-contact type with pins or leads are tested in flat socket X109 (fig. 9). The tube pins or leads must be inserted so that the dot on the base of the tube is directly in line with the small, molded dot on the socket.

c. Subminiature tube types are identified in the test data book by a star beside the type number. The applicable basing for the various round types is indicated in the *Notations* column. The basing designation letter refers to the diagrams shown in figure 10.

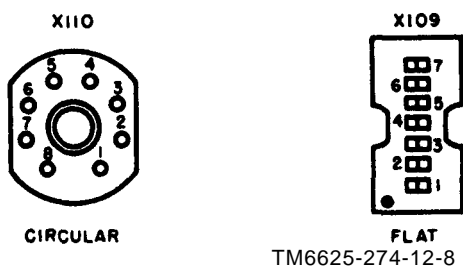

Figure 9. Top view of sockets X109 (flat) and X110 (circular).

26. Stopping Procedure

a. Set the POWER switch to the OFF position.

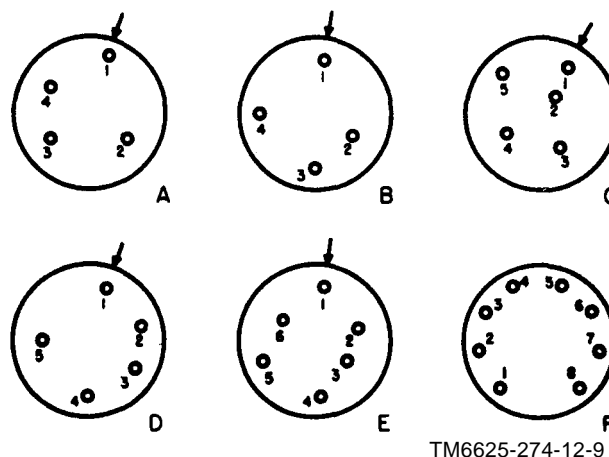

Figure 10. Basing diagrams for subminiature tubes (letters, A, B, C, D, E, and F identify basing for use with test data book).

b. Remove the tube under test from the test socket.

c. Place the adapters, if used, under the clamps on the inside of the cover.

d. Disconnect the ac line cord from the power source and wind it counterclockwise around the retainer bracket on the inside of the cover. Secure the plug under the storage clip (TV-7B/U and TV-7D/U, fig. 3 and 4), or under the coiled ac line cord (TV-7/U and TV-7A/U).

e. Place the test leads, if used, in the storage clips (not on TV-7/U). On the TV-7/U, store the test leads under the coiled ac line cord or as shown in figure 1.

f. Close the cover and secure the fasteners.

Section V. OPERATION UNDER UNUSUAL CONDITIONS

27. General

The test set is designed for normal operation through a temperature range from -40°F to $+125^{\circ}\text{F}$. The operation of the equipment may be more difficult in regions where extreme cold, heat, humidity, or moisture conditions prevail. Paragraphs 28 through 30 provide operational information that may be used to minimize the effects of regional extremes.

28. Operation at Low Temperatures

Subzero temperatures and climatic conditions associated with cold weather may effect the efficient operation of the test set.

a. Extreme cold makes the ac line cord and other rubber parts stiff and brittle. Handle the equipment carefully to avoid cracking the insulation on the ac line cord and on the test leads.

b. Keep the equipment in a warm, dry location. If possible, keep the test set in a heated enclosure. A standby heater is not provided; therefore, leave the test set turned on if possible.

c. Allow the test set to warm up for 10 to 15 minutes before testing tubes. The length of warmup time depends upon the temperature of the surrounding air.

d. If equipment that has been exposed to the cold is brought into a warm room, moisture will form on it and may cause fogging of the meter glass. Dry the equipment thoroughly.

e. Keep the cover of the test set closed at all times when the equipment is not in operation. This will prevent an accumulation of moisture within the equipment due to sweating.

29. Operation Under Tropical Conditions

Warm, damp climates expose the equipment

to damage from moisture and fungus. The high relative humidity causes condensation when the temperature of the equipment drops below that of the surrounding air. Adequate ventilation will minimize this condition. Keep the cover of the test set closed as much as possible. Wipe all moisture and fungus from the exterior of the test set with a clean, lint-free cloth.

30. Operation in Desert Climates

Desert climates expose the test set to damage from dirt, dust, sand, and the effects of strong sunlight. Provide means for keeping dust and sand from entering the holes in the test sockets, adapters, and jacks, and from accumulating around the pushbuttons and other moving parts of the test set. Clean and dust the equipment frequently. When not in use, keep the cover closed to keep dust and dirt out of the exposed parts.

CHAPTER 3
MAINTENANCE INSTRUCTIONS

31. General

The procedures in paragraphs 33 through 39 are to be performed by the operator or organizational maintenance personnel. Operator's maintenance consists of preventive maintenance (par. 33), visual inspection (par. 34), and replacement of electron tubes (par. 37) and lamps (par. 39). Organizational maintenance of the test set is limited to preventive maintenance (par. 33) and to the replacement of the adapters (fig. 8), knobs and pushbuttons, indicator light lens, cable clamps, and clip insulators. The only tools required are those tools normally available to the repairman-user because of his assigned mission.

32. Materials Required

The materials required for operator's and organizational maintenance are as follows:

- a. Cleaning compound (Federal stock No. 7930-395-9542).
- b. Cleaning cloth.
- c. Sandpaper, #0000.

33. Preventive Maintenance

a. *DA Form 11-266.* DA Form 11-266 (fig. 11 and 12) is a preventive maintenance checklist to be used by the operator and organi-

zational maintenance personnel. Items not applicable to the test set are lined out in figure 12. References in the ITEM block in figure 12 are to paragraphs that contain additional maintenance information pertinent to the particular item. Instructions for the use of the form appear on the form.

b. *Items.* The information shown below supplements DA Form 11-266. The item numbers correspond to the ITEM numbers on the form.

| Item | Maintenance procedures |
|------|--|
| 1 | Use a clean cloth to remove dust, dirt, moisture, and grease from the case, the front panel, and the adapters. If necessary, wet a cloth with cleaning compound and then wipe the parts with a dry, clean cloth. |
| 2 | Inspect the clips that hold the adapters and the clips that hold the test leads (TV-7 B/U and TV-7 D/U) for tight spring action. Check the ring binder for proper operation. Check the PILOT, FUSE, and SHORTS lamps for broken glass. Check to see that the socket-saver adapters (fig. 7) are tightly secured in their respective test sockets. |

Warning: Cleaning compound is flammable and its fumes are toxic. Do not use it near a flame; provide adequate ventilation.

| MAINTENANCE CHECK LIST FOR SIGNAL EQUIPMENT TEST EQUIPMENT (AR 750-625) | | | |
|--|------------------|-------------------|-----------------------|
| EQUIPMENT NOMENCLATURE | | | |
| <i>TEST SET, ELECTRON TUBE TV-7D/U</i> | | | |
| EQUIPMENT SERIAL NUMBER | | | |
| <i>2404</i> | | | |
| INSTRUCTIONS | | | |
| <p>This form may be used for a period of one month by using the correct dates and weeks of the month. It is to be used as a Preventive Maintenance check list for Signal equipment in actual use, or for a check on equipment prior to issue.</p> | | | |
| <p>1. For detailed Preventive Maintenance instructions see:</p> <p>a. The Technical Manual (in TM 11 series) for the equipment. (See DA Pamphlet Number 310-4)</p> <p>b. The Supply Bulletin (SB 11-100 series) for the equipment. (See DA Pamphlet Number 310-4)</p> <p>c. The Department of the Army Lubrication Order. (See DA Pamphlet Number 310-4)</p> | | | |
| <p>2. The following action will be taken by either the Communications Officer/Chief for 1st echelon, or the Inspector for higher echelon</p> <p>a. Enter Equipment Nomenclature and Serial Number.</p> <p>b. Strike out items that do not apply to the equipment.</p> | | | |
| <p>3. Operator/Inspector will enter in the columns entitled CONDITION, on the proper line, a notation regarding the condition, using symbols specified under LEGEND.</p> | | | |
| <p>4. After operator completes each daily inspection he will initial over the appropriate dates under "Daily Condition for Month", then return form to his supervisor.</p> | | | |
| TYPE OF INSPECTION | | | |
| OPER- ATOR | 2/3 ECH- ELON | DATE | SIGNATURE |
| ✓ | | <i>8 FEB '60</i> | <i>Natold Andrews</i> |
| | ✓ | <i>22 FEB '60</i> | <i>James Drake</i> |
| | | | |
| | | | |
| | | | |
| | | | |

4

DA FORM 11-266
MAY 57

Figure 11. DA Form 11-266, pages 1 and 4.

| LEGEND for marking conditions: Satisfactory, ✓. Adjustment, Repair or Replacement required, X. Defect corrected, (X). | | | | | | DAILY CONDITION FOR MONTH OF FEBRUARY 1960 | | | | | | | | | | | | | | | | | | | | | | | | |
|--|--|---------------------|----|----|-----|--|-----------------|---|---|---|----|----|----|----|----|--------------------------|----|-----------|----|----|----|----|----|----|----|----|----|----|----|----|
| NO. | DAILY ITEM | | | | | | | | | | | | | | | 2D 3D ECH- ELON | | | | | | | | | | | | | | |
| | | 1 | 2 | 3 | 4 | 5 | 6 | 7 | 8 | 9 | 10 | 11 | 12 | 13 | 14 | | 15 | 16 | 17 | 18 | 19 | 20 | 21 | 22 | 23 | 24 | 25 | 26 | 27 | 28 |
| | 1. CLEAN DIRT AND MOISTURE FROM EXPOSED SURFACES OF HOUSINGS, CASES, CABINETS, CONTROL PANELS, INTER-CONNECTING PLUGS, CABLES, HEADSETS, METER WINDOWS, ETC. | HA | | | | | | | | | | | | | | ✓ | | | | | | | | | | | | | | |
| | 2. INSPECT FOR LOOSENESS OF EXTERIOR ITEMS SUCH AS SWITCHES, KNOBS, JACKS, CONNECTORS AND PILOT LIGHTS. | HA | | | | | | | | | | | | | | ✓ | | | | | | | | | | | | | | |
| | 3. INSPECT CONTROLS FOR BINDING, SCRAPING. TAP CONTROLS LIGHTLY FOR CUT-OUT DUE TO LOOSE CONTACTS. | HA | | | | | | | | | | | | | | ✓ | | | | | | | | | | | | | | |
| | 4. DURING OPERATION BE ALERT FOR ANY UNUSUAL PERFORMANCE OR CONDITION. | HA | | | | | | | | | | | | | | ✓ | | | | | | | | | | | | | | |
| WEEKLY | | CONDITION EACH WEEK | | | | | 2D 3D ECH | ADDITIONAL ITEMS FOR 2D AND 3D ECHELON INSPECTIONS | | | | | | | | | | CONDITION | | | | | | | | | | | | |
| | 5. INSPECT CORDS, CABLES, WIRE AND CHECK MOUNTS FOR BREAKS, CUTS, KINKS, DETE-RIORATION, STRAIN AND PRAYING. | 1ST | 2D | 3D | 4TH | 5TH | ✓ | 15. INSPECT RESISTORS, BUSHINGS, INSULATORS FOR CRACKS, CHIPPING, BLISTERING, DISCOLORATION AND MOISTURE. | | | | | | | | | | | ✓ | | | | | | | | | | | |
| | 6. INSPECT CANVAS AND LEATHER ITEMS FOR FUNGUS, PRAYING, TEARS, BROKEN ZIPERS AND SNAP FASTENERS. | | | | | | | 16. INSPECT JACKS AND CONNECTORS FOR SNUG FIT AND GOOD CONTACTS. | | | | | | | | | | | | | | | | | | | | | | |
| | 7. HAND CHECK FOR LOOSENESS OF EXTERIOR ITEMS SUCH AS HANDLES, LATCHES, HINGES. | | ✓ | | | | ✓ | 17. INSPECT VARIABLE CAPACITORS FOR DIRT AND MOISTURE. | | | | | | | | | | | | | | | | | | | | | | |
| | 8. INSPECT FOR LUBRICATION IN ACCORDANCE WITH APPLICABLE MAINTENANCE ORDER. | | | | | | | 18. INSPECT AIR FILTERS FOR CLEANLINESS. | | | | | | | | | | | | | | | | | | | | | | |
| | 9. INSPECT DRY BATTERIES FOR DIST, LOOSE TERMINALS AND LEAKAGE. | | | | | | | 19. INSPECT BATTERY TERMINALS OF TRANSFORMERS, FIXED CAPACITORS, RESISTORS, SWITCHES, POTENTIOMETERS AND RHEOSTATS FOR CORROSION, DIRT AND LOOSE CONTACTS. | | | | | | | | | | | ✓ | | | | | | | | | | | |
| | 10. INSPECT EXPOSED METAL SUR-FACES FOR RUST AND CORROSION. | ✓ | | | | | ✓ | 20. CLEAN AND TIGHTEN SWITCHES, SLIDERS, RELAY CASES, CLEAN INTERIOR OF CHASSIS AND CABINETS. | | | | | | | | | | | ✓ | | | | | | | | | | | |
| | 11. INSPECT METERS FOR DAMAGED GLASS AND CASES. | ✓ | | | | | X | 21. INSPECT GENERATORS, MOTORS AND DYNAMOS FOR BRUSH WEAR, SPRING TENSION, ARCHES AND COMMUTATOR WEAR. | | | | | | | | | | | | | | | | | | | | | | |
| | 12. INSPECT SEATING OF READILY ACCESSIBLE ITEMS OF A PLUCK-OUT NATURE: CRYSTALS, FUSES, CONNECTORS, PLUG-IN SOLENS, LAMPS, ETC. DO NOT REMOVE, ROCK OR TWIST TO INSPECT. USE ONLY A DIRECT PRESSURE TO INSURE THE ITEM IS FULLY SEATED. | | | | | | ✓ | 22. INSPECT TERMINAL BLOCKS FOR LOOSE CONNECTIONS, CRACKS AND BREAKS. | | | | | | | | | | | | | | | | | | | | | | |
| | 13. INSPECT FOR CLEANLINESS AND TIGHTNESS OF SUCH ITEMS AS CHECK MOUNTS, ANTENNA, ANTENNA MOUNTS AND WAVE GUIDES. | | | | | | | 23. INSPECT GASKETS AND BUSHINGS FOR WEAR AND DAMAGE. | | | | | | | | | | | ✓ | | | | | | | | | | | |
| | 14. INSPECT RELAY AND CIRCUIT BREAKER ASSEMBLIES FOR DIRT, CORROSION, WORN OR BURNED CONTACTS. | | | | | | | 24. INSPECT CATHODE RAY TUBES FOR BURNED SCREEN SPOTS. | | | | | | | | | | | | | | | | | | | | | | |
| ADDITIONAL ITEMS FOR 2D AND 3D ECHELON INSPECTIONS | | | | | | | CONDITION | 25. REMOVE STOPS OR SHAPING REMOVE ALL BATTERIES. | | | | | | | | | | | | | | | | | | | | | | |
| | | | | | | | | IF DEFICIENCIES NOTED ARE NOT CORRECTED DURING THE INSPECTION, INDICATE ACTION TAKEN FOR CORRECTION. (Continue on page 4, if more space is needed) | | | | | | | | | | | | | | | | | | | | | | |
| | | | | | | | | ITEM 11. METER GLASS BROKEN. REPORTED TO HIGHER ECHELON MAINTENANCE FOR REPLACEMENT. | | | | | | | | | | | | | | | | | | | | | | |

Figure 12. DA Form 11-266, pages 2 and 3.

34. Visual Inspection

a. When the equipment fails to perform properly, check the items listed below.

- (1) Test leads, if used, poorly connected or improperly connected.
- (2) Incorrect pushbutton depressed.
- (3) Improper setting of selector switches or controls (par. 18b (3)).
- (4) Battery or resistors improperly connected (par. 24a).
- (5) FUSE lamp defective.
- (6) LINE ADJUST control improperly adjusted (par. 17c).

b. If the above checks do not locate the trouble, proceed to the equipment performance checklist (par. 35).

35. Equipment Performance Checklist

a. *General.* The equipment performance checklist provides a procedure for systematically checking equipment performance. All corrective measures that the operator or the organizational maintenance man can perform are given in the *Corrective measures* column.

When using the checklist, start at step 1 and follow each step in order. If the corrective measures indicated do not repair the equipment, troubleshooting is required by higher echelon. Note on the repair tag how the equipment performed and the corrective measures that were taken. Perform the steps in *b* below.

b. *Checklist.*

| Step | Item | Action or condition | Normal indication | Corrective measures |
|---|-----------------------------|--|---|--|
| P R E P A R A T O R Y | 1 Ac line cord. | Connect ac line cord to power source. | | |
| | 2 POWER switch. | Set switch to ON position. | PILOT lamp lights. | Check ac line cord connection. Remove (par. 39a) and check (par. 23) PILOT lamp; replace if defective. |
| | 3 Meter. | | Pointer stays at zero. | Remove (par. 39a) and check (par. 23) FUSE lamp; replace if defective. Higher echelon repair required. |
| | 4 Pushbutton 1—LINE ADJ. | Depress pushbutton. | Meter pointer moves up-scale. | Defective type 86 tube; replace tube (par. 37) . Higher echelon repair required. |
| | 5 LINE ADJUST control knob. | Rotate control knob, while holding pushbutton 1—LINE ADJ. down, until meter pointer is directly over LINE TEST mark. | Meter pointer moves when control knob is turned. | Check for low-line voltage if pointer will not adjust properly. Higher echelon repair required. |
| | 6 Selectors. | Set selectors as directed in paragraph 17e (1). | Selector knobs should be tight and point directly at a number or letter. The switch detents should be positive. | When a selector pointer is between two numbers or two letters, rotate switch fully counterclockwise. Loosen knob setscrew, turn knob until it points directly at the first number or letter, and tighten setscrew. Tighten loose knobs. If switch detents are not positive, higher echelon repair is required. |
| | 7 FUNCTION SWITCH. | Rotate switch through the five SHORTS positions. | SHORTS lamp glows at positions 2 and 3 of switch. | Check switch settings. Replace SHORTS lamp (par. 39b). Higher echelon repair required. |
| | 8 POWER switch. | Set switch to OFF position. | PILOT lamp goes out. | |

| | Step | Item | Action or condition | Normal indication | Corrective measures |
|--|------|---------------------------|---|---|---|
| S T A R T | 9 | Selectors and controls. | Set according to test being performed. | | |
| | 10 | Tube under test. | Insert in proper test socket. Make connections as required. | Tube pins enter test socket without forcing. | Check for bent pins. Straighten pins of miniature tubes in one of the pin straighteners. |
| | 11 | POWER switch. | Set switch to ON position. | PILOT lamp lights. | |
| E Q U I P M E N T P E R F O R M A N C E | 12 | Meter. | Checking tube for dynamic mutual conductance, emission, or gas. | Meter pointer indicates condition of tube under test when proper pushbutton is depressed. | If meter pointer stays at zero, tube under test may be defective. Check setting of selectors and controls. Test another tube. Higher echelon repair required. |
| | 13 | BIAS control. | Gas test. | Meter pointer can be adjusted to 10 by turning control knob. | Adjust BIAS control knob until pointer indicates 100, then proceed with gas test. |
| | 14 | Panel lamp test socket. | Checking a panel (pilot) lamp (par. 23). | A good lamp will light. | Make good contact between lamp and test socket. Check control settings. Lamp may be defective; check other lamps if available. Higher echelon repair required. |
| | 15 | Adapter E104 (fig. 8). | Testing long lead subminiature tube. | Meter indicates condition of tube when proper pushbutton is depressed. | Unsnap locking device on adapter, move tube up and down to check seating of leads, and secure locking device. Test tube again. Check control settings. Check <i>Notations</i> column in test data book for type basing used. Compare placement of tube leads to basing diagram (fig. 10). Replace adapter and check tube again. If meter pointer does not move when correct pushbutton is depressed, test another tube. Higher echelon repair required. |
| | | Adapter E105 (fig. 8). | Testing tube type 3E29, 829-B, or 832-A. | Meter indicates condition of tube when pushbutton 3 — MUT. COND. is depressed. | Check seating of adapter and tube. Check plate lead for a good connection. Check setting of controls. Test another tube. If meter pointer does not move, replace adapter. Higher echelon repair required. |
| | 17 | Adapter E107 (fig. 8). | Testing tube type 2C39. | Meter indicates condition of tube when pushbutton 3 — MUT. COND. is depressed. | Check seating of tube and adapter. Remove adapter and tube and squeeze spring contacts closer together if necessary. Check setting of controls. Replace adapter and tube in test socket and test tube again. |

EQUIPMENT PERFORMANCE

| Step | Item | Action or condition | Normal indication | Corrective measures |
|------|--------------------------|---|--|---|
| 18 | Socket X109 (fig. 9). | Testing flat subminiature tube. | Meter indicates condition of tube when proper pushbutton is depressed. | Test another tube. If meter pointer does not move, replace adapter. Higher echelon repair required. Check to see that dot on base of tube is aligned with dot on test socket. Slide tube leads up and down in test socket to insure good contact. Check setting of controls. Test another tube. Higher echelon repair required. |
| 19 | Socket X110 (fig. 9). | Testing round subminiature tube. | Meter indicates condition of tube when proper pushbutton is depressed. | Slide tube leads up and down in test socket to insure good contact. Check setting of controls. Check <i>Notations</i> column in test data book for type basing used. Compare placement of tube leads to basing diagram (fig. 10). Test another tube. Higher echelon repair required. |
| 20 | Tube under test. | Remove from test socket. | PILOT lamp goes out. | |
| 21 | POWER switch. | Set to OFF position. | | |
| 22 | Ac line cord. | Remove ac line cord plug from power source. | | |

36. Removal of Chassis

a. Removal.

- (1) Unsnap the latches and open the cover of the test set.
- (2) Unwind the ac line cord from the retainer bracket and remove the cover from the test set. Remove the cover by sliding it to one side until the hinge pins are disengaged.
- (3) Remove the screws that secure the front panel to the case.
- (4) Hold the front panel to the case, turn the test set over, and gently place it on a clean, flat surface.
- (5) Slowly lift the test set case upward until it is clear of the chassis.

b. Replacement.

- (1) Position the test set case so that the handle is forward.

- (2) Carefully lower the test set into the case. Be sure that no wires are caught between the front panel and the edge of the case.
- (3) Replace the screws that secure the front panel to the case. Tighten the screws in rotation a little at a time to prevent binding.
- (4) Replace the cover on the case, wind the ac line cord counterclockwise on the retainer bracket, secure the plug under the clip (not on TV-7/U), close the cover, and secure the latches.

37. Tube Replacement

When trouble occurs, check the ac line cord connection and the control settings before removing any tubes. If tube failure is suspected, use the tube substitution method (a below) to check the tubes.

Caution: Do not rock or rotate a tube when removing it from a socket; pull it straight out with a tube puller.

a. *Tube Substitution Method.* Replace a suspected tube (*b* below) with a new tube. If the equipment still does not work, remove the new tube and put back the original tube. Repeat this procedure with the other tube. If the test set is still inoperative, other checks are required (par. 35*b*).

b. *Replacing Tubes in Test Set, Electron Tube TV-7(*)/U.* Check the tubes in the test set as follows:

- (1) Remove the chassis from the case (par. 36*a*).
- (2) Remove the tube clamp (fig. 13) from the threaded stud and remove the tube.

Caution: Be careful not to hit the meter case with tube type 83 when removing the tube.

- (3) Replace the tube (*a* above) with one of the running spares.
- (4) Set the tube (or a replacement) in the socket and secure it with the tube clamp.
- (5) Replace the chassis in the case (par. 36*b*).

38. Preferred-Type Tubes

A preferred-type electron tube, type 5Y3WGTA, has been developed as a direct replacement for nonpreferred types 5Y3GT and 5Y3WGT (par. 7). The 5Y3WGTA is used in the power supply. When replacement of a 5Y3GT or a 5Y3WGT is necessary, replace it with a 5Y3WGTA. Do not substitute a 5Y3GT or a 5Y3WGT for a 5Y3WGTA.

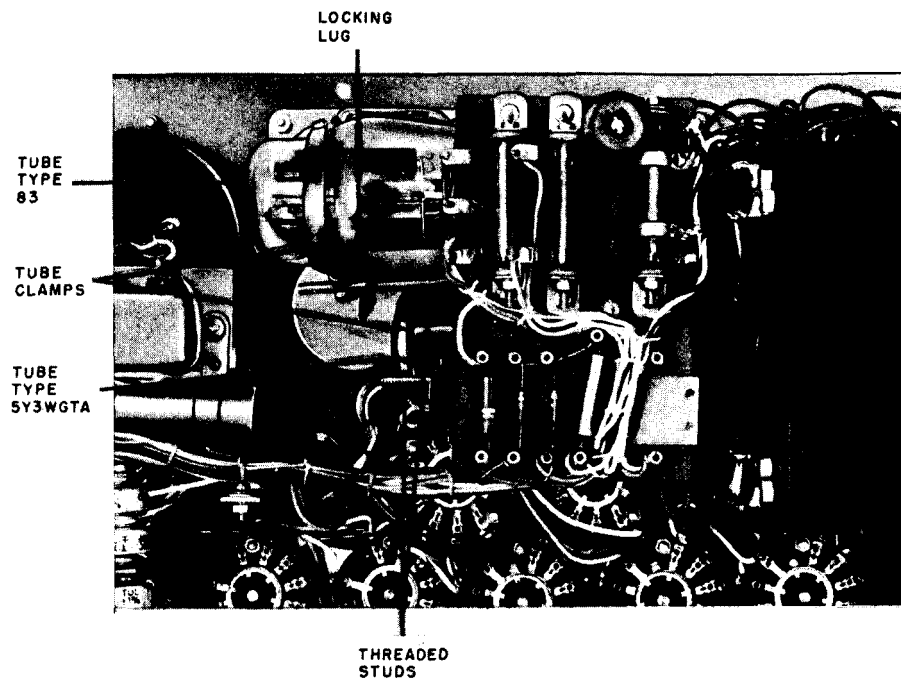

TM6625-274-12-13

Figure 13. Tube location.

39. Replacement of Lamps

The FUSE, PILOT, and SHORTS lamps are removable from the front panel of the test set.

a. The FUSE lamp and PILOT lamp have

bayonet-type bases. Unscrew and remove the PILOT lamp indicator jewel to gain access to the PILOT lamp. To remove either lamp, press downward, turn the lamp to the left, and lift straight up. To replace the FUSE or PILOT

lamp, insert the lamp in the appropriate socket, press downward, turn the lamp to the right, and release it. Replace the PILOT lamp indicator jewel.

b. The SHORTS lamp has a screw-type base. Remove the lamp by turning it to the left; replace the lamp by turning it to the right.

CHAPTER 4
SHIPMENT, LIMITED STORAGE, AND DEMOLITION
TO PREVENT ENEMY USE

Section I SHIPMENT AND LIMITED STORAGE

40. Removal From Service

a. Set the POWER switch to the OFF position and disconnect the test set from the power source.

b. Place the adapters under the clamps on the cover.

c. Wind the ac line cord counterclockwise around the retainer bracket and place the plug under the clip (not on TV-7/U). Place the test leads under the coiled ac line cord (TV-7/U and TV-7A/U) or as shown in figures 1 and 2. On the TV-7B/U and the TV-7D/U, insert one end of the test leads into the storage clips and connect the alligator clips to the studs (fig. 3 and 4).

d. Close the cover and secure it with the latches.

41. Repackaging for Shipment or Limited Storage

(fig. 14)

The exact procedure for repackaging depends on the material available and the conditions under which the equipment is to be shipped or stored. Adapt the procedures outlined below whenever circumstances permit. The information concerning the original packaging (par. 8) will also be helpful.

a. *Material Requirements.* The following materials are required for repackaging Test Set, Electron Tube TV-7(*)/U. For stock numbers of materials, consult SB 38-100.

| Material | Quantity |
|--|----------------|
| Flexible corrugated fiberboard..... | 10 sq ft |
| Waterproof wrapping paper..... | 10 sq ft |
| Gummed paper tape..... | 3 ft |
| Pressure-sensitive tape..... | 4 ft |
| Metal strapping (½ - by 0.020-inch) . . (Note. Strapping seals required) | 8 ft |
| Wooden box (inside dimensions: 18 ¾ by 10 ¼ -by 7 ¾ -inch) | 1 ea (9 bd ft) |

b. *Packaging.*

- (1) *Technical manual.* Package the technical manuals within a close-fitting bag fabricated of waterproof wrapping paper. Seal the seams with pressure-sensitive tape.
- (2) *Spare parts.* Wrap each part within a layer of flexible corrugated fiberboard. Seal the seams with gummed paper tape. Overwrap the flexible corrugated fiberboard with waterproof wrapping paper and seal with pressure-sensitive tape.
- (3) *Test set.* The procedure used to package the test set is the same as the procedure used to package the spare parts ((2) above).

c. *Packing.*

- (1) Fabricate a wooden box.
- (2) Place the packaged test set (b(3) above) in the wooden box.
- (3) Place the spare parts (b(2) above) and the technical manuals on top of the test set.
- (4) Nail down the wooden cover.
- (5) Strap the wooden box when inter-theater shipment is involved.

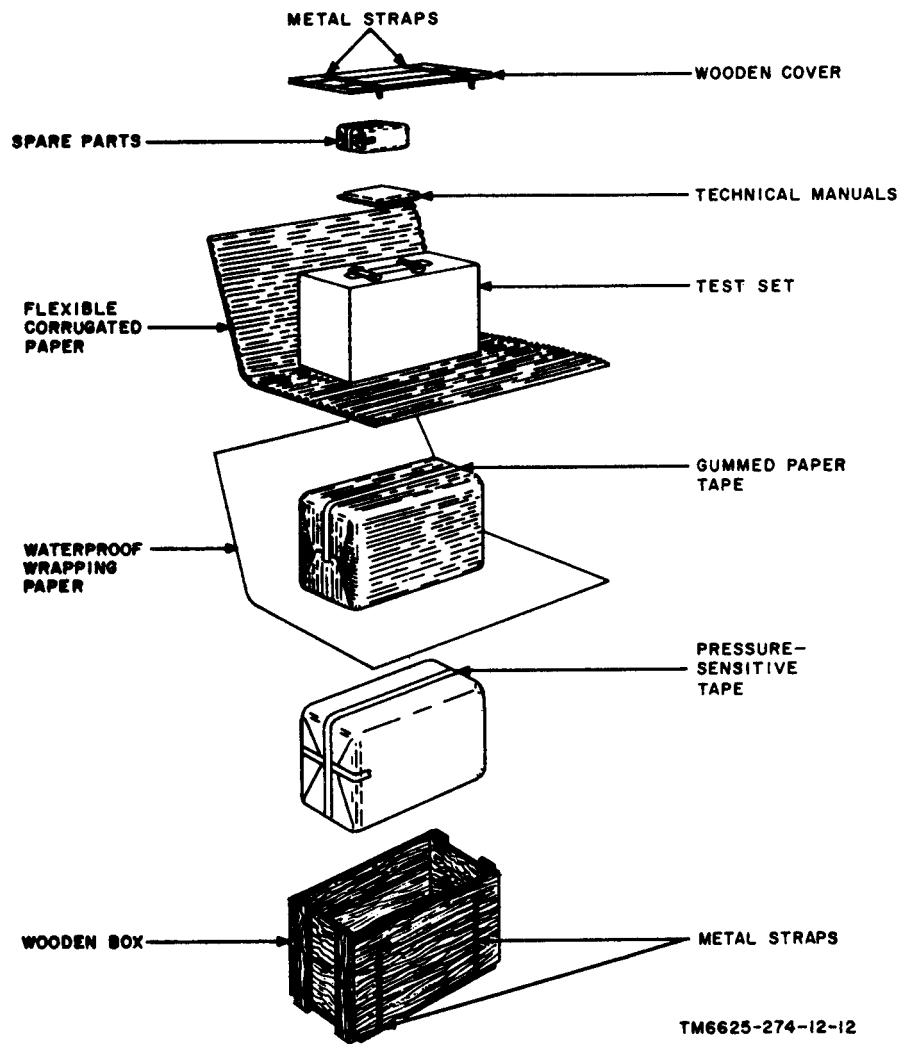

Figure 14. Field repackaging diagram.

Section II. DEMOLITION OF MATERIEL TO PREVENT ENEMY USE

42. Authority for Demolition

The destruction procedures outlined in paragraph 43 will be used to prevent further use of the equipment. Demolition of the equipment will be accomplished only upon the order of the commander.

43. Methods of Destruction

Any or all of the methods of destruction given below may be used.

a. *Smash.* Use sledges, axes, hammers, crowbars, or any other heavy tools available; smash the case, cover, adapters, front panel, and meter.

b. *Cut.* Use axes, handaxes, machetes, or knives; cut the ac line cord and test leads.

c. *Burn.* Use gasoline, kerosene, oil, flame-throwers, or incendiary grenades; burn the technical manuals and test data book.

Warning: Be extremely careful with explosive and incendiary devices. Use these items only when the need is urgent.

d. *Explode.* Use grenades, TNT, or firearms, if explosives are necessary.

e. *Dispose.* Bury or scatter destroyed parts or throw them into nearby waterways.

APPENDIX I
REFERENCES

Following is a list of applicable references available to the operator or organizational maintenance personnel of Test Set, Electron Tube TV-7(*)/U:

SB 38-100 Preservation, Packag-
 ing and Packing Ma-
 terials, Supplies and
 Equipment Used by
 the Army

TB 11-5083-1 Tube Test Data for
 Electron Tube Test
 Sets TV-7/U, TV-

7A/U, TV-7B/U,
and TV-7D/U

TM 11-6625-274-20P Organizational Mainte-
 nance Repair Parts
 and Special Tools
 List and Mainte-
 nance Allocation
 Chart for Test Sets,
 Electron Tube TV-
 7/U, TV-7A/U,
 TV-7B/U and TV-
 7D/U

APPENDIX II
OPERATOR'S MAINTENANCE REPAIR PARTS
AND SPECIAL TOOLS LIST

Section I INTRODUCTION

1. Scope

a. *General.* This appendix lists items supplied for initial operation and for running spares. The list includes tools, accessories, parts, and material issued as *part* of the major item, and all items authorized for basic operator maintenance of the equipment. End items of equipment are issued on the basis of allowances prescribed in equipment authorization tables and other documents that are a basis for requisitioning.

b. *Columns.* The columns are as follows:

- (1) *Source, maintenance, and recoverability code.* Not used.
- (2) *Federal stock number.* This column lists the 11-digit Federal stock number.
- (3) *Designation by model.* A dagger (†) indicates the model in which the part is used.
- (4) *Description.* Nomenclature or the standard item name and brief identifying data for each item are listed in this column. When requisitioning, enter the nomenclature and description on the requisition.
- (5) *Unit of issue.* The unit of issue is the supply term by which the individual item is counted for procurement,

storage, requisitioning, allowances, and issue purposes.

- (6) *Expendability.* Expendable items are indicated by X; nonexpendable items are indicated by NX.
- (7) *Quantity authorized.* Under "Items Comprising an Operable Equipment," the column lists the quantity of items supplied for the initial operation of the equipment. Under "Running Spares and Accessory Items" the quantities are those issued initially with the equipment as spare parts. The quantities are authorized to be kept on hand by the operator for maintenance of the equipment.
- (8) *Illustrations (Figure No.).* The numbers in this column refer to the illustration or illustrations where the part is shown.
- (9) *Illustrations (Item No.).* This column lists the reference symbols used for identification of items in the illustrations or text of the manual.

2. Critical Items

A zero slash (0) in the "Description" column indicates items that are expected to fail during the first year; also items that will make the equipment inoperative if they fail.

Section II. FIRST ECHELON FUNCTIONAL PARTS LIST

| (1) SOURCE MAINTENANCE AND RECOVERABILITY CODE | (2) FEDERAL STOCK NUMBER | (3) DESIGNATION BY MODEL | | | | (4) DESCRIPTION | (5) UNIT OF ISSUE | (6) EXPENDIBILITY | (7) QUANTITY AUTHORIZED | (8) ILLUSTRATIONS | |
|---|--------------------------------|-----------------------------------|---|---|---|---|-------------------------|----------------------|-------------------------------|----------------------|-------------|
| | | 1 | 2 | 3 | 4 | | | | | FIGURE NO. | ITEM NO. |
| | | | | | | ITEMS COMPRISING AN OPERABLE EQUIPMENT | | | | | |
| | | | | | | TEST SET, ELECTRON TUBE TV-7/U; TV-7A, B, D/U | | | | | |
| | | | | | | NOTE: Model Column 1 refers to TV-7/U; Column 2 refers to TV-7A/U; Column 3 refers to TV-7B/U; Column 4 refers to TV-7D/U | | | | | |
| | 6625-376-4939 | | | | | TEST SET, ELECTRON TV-7/U; TV-7A, B, D/U: | ea | NX | | 1,2,3,4 | |
| | Order thru AGC | + | + | + | + | TECHNICAL MANUAL TM 11-6625-274-12P: | ea | X | 2 | | |
| | Order thru AGC | + | + | + | + | TECHNICAL BULLETIN TR-11-5033-1 | ea | X | 2 | | |
| | Order thru AGC | + | + | + | + | TECHNICAL MANUAL TM 11-5083 | ea | X | 2 | | |
| | 5935-204-8379 | + | + | + | + | ADAPTER, ELECTRON TUBE SOCKET: Sig dwg No. SW-B-179212 | ea | X | 1 | 8 | E104 |
| | 5935-201-8500 | + | + | | | ADAPTER, ELECTRON TUBE SOCKET: Hickok part No. 1050-33 | ea | X | 1 | 8 | E106 |
| | 5935-537-4056 | | + | + | | ADAPTER, ELECTRON TUBE SOCKET: Sig dwg No. SW-C-179260 | ea | X | 1 | 8 | E105 |
| | 5935-502-1777 | + | + | | | ADAPTER, ELECTRON TUBE SOCKET: Hickok part No. 1050-50 | ea | X | 1 | 8 | E107 |
| | 5935-511-6491 | | + | + | | ADAPTER, ELECTRON TUBE SOCKET: Sig dwg No. SW-B-179230 | ea | X | 1 | 8 | E107 |
| | 6625-684-1189 | + | + | + | + | ADAPTER, TEST: Victoreen Inst Co part 795-X3B | ea | X | 1 | 4 | X3B |
| | 6625-618-9928 | + | + | + | + | ADAPTER, TEST: Victoreen Inst Co part 795-X7B | ea | X | 1 | 4 | X7B |
| | 6625-618-9929 | + | + | + | + | ADAPTER, TEST: Victoreen Inst Co part 795-X10B | ea | X | 1 | 4 | X10B |
| | 6625-586-8349 | | + | + | | COVER, TEST SET: Hickok part No. 3145-333 | ea | X | 1 | 3 | |
| | 6625-668-4683 | + | + | + | + | LEAD, TEST: Hickok part No. 12450-245 | ea | X | 2 | 1,2,3,4 | W101 W102 |
| | | | | | | RUNNING SPARES AND ACCESSORY ITEMS | | | | | |
| | | | | | | TEST SET, ELECTRON TUBE TV-7/U; TV-7A, B, D/U | | | | | |
| | 5960-262-0218 | + | + | + | + | Ø ELECTRON TUBE: MIL type 5Y3WGTA | ea | X | 1 | 15 | V102 |
| | 5960-100-7323 | + | + | + | + | Ø ELECTRON TUBE: MIL type 63 | ea | X | 1 | 15 | V101 |
| | 6240-179-1814 | + | + | + | + | Ø LAMP, GLOW: GE part No. NE-45 | ea | X | 1 | 15 | E101 |
| | 6240-014-2306 | + | + | + | + | Ø LAMP, INCANDESCENT: GE part No. 81 | ea | X | 1 | 15 | E103 |
| | 6240-155-8706 | + | + | + | + | Ø LAMP, INCANDESCENT: GE part No. 47 | ea | X | 1 | 15 | E102 |

TV-7/U; TV-7A, B, D/U

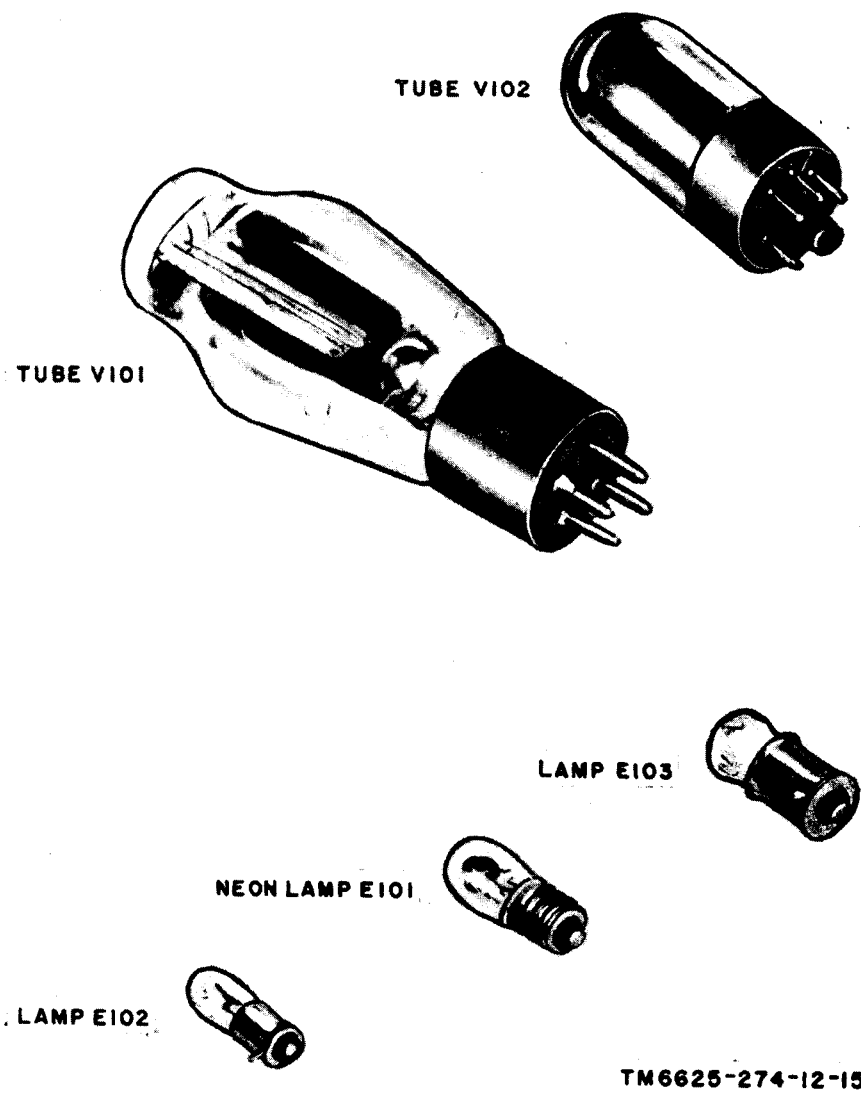

Figure 15. Electron tubes and lamps.

APPENDIX III
MAINTENANCE ALLOCATION CHART

Section I INTRODUCTION

1. Scope

a. *General.* This appendix assigns maintenance functions and repair operations to be performed by the lowest appropriate maintenance echelon.

b. *Allocation of Maintenance Functions.* Columns in section II, Allocation of Maintenance Functions, are defined as follows:

- (1) *Part or component.* This column shows only the nomenclature or standard item. Additional descriptive data are included only where clarification is necessary to identify the part. Components and parts comprising a major end item are listed alphabetically. Assemblies and subassemblies are in alphabetical sequence with their components listed alphabetically immediately below the assembly listing.
- (2) *Maintenance function.* This column indicates the various maintenance functions allocated to the echelon capable of performing the operations.
 - (a) *Service.* To clean, to preserve, and to replenish fuel and lubricants.
 - (b) *Adjust.* To regulate periodically to prevent malfunction.
 - (c) *Inspect.* To verify serviceability and to detect incipient electrical or mechanical failure by scrutiny.
 - (d) *Test.* To verify serviceability and to detect incipient electrical or mechanical failure by use of special equipment such as gages, meters, etc.
 - (e) *Replace.* To substitute serviceable assemblies, subassemblies, and parts for unserviceable components.
 - (f) *Repair.* To restore to a serviceable condition by replacing unserviceable parts or by any other action required utilizing tools, equipment, and skills available, to include welding, grinding, riveting, straightening, adjusting, etc.

(g) *Calibrate.* To determine, check, or rectify the graduation of an instrument, weapon, or weapons system, or components of a weapons system.

(h) *Rebuild.* To restore to a condition comparable to new by disassembling the item to determine the condition of its component parts and reassembling it using serviceable, rebuilt, or new assemblies, subassemblies, and parts.

(3) *1st, 2d, 3d, 4th, 5th echelon.* The symbol X indicates the echelon responsible for performing that particular maintenance operation, but does not necessarily indicate that repair parts will be stocked at that level. Echelons higher than the echelon marked by X are authorized to perform the indicated operation. Column 5 is not used.

(4) *Tools required.* This column indicates the tool, test, and maintenance equipments required to perform the maintenance functions. These numbers are identified in section III, Allocation of Tools for Maintenance Functions.

(5) *Remarks.* This column contains any notations necessary to clarify the data cited in the preceding columns.

c. *Allocation of Tools for Maintenance Functions.* Columns in section III, Allocation of Tools for Maintenance Functions, are as follows:

(1) *Tools required for maintenance functions.* This column lists the tools and test equipment required to perform the maintenance functions.

(2) *1st, 2nd, 3rd, 4th, and 5th echelon.* A dagger (†) in columns 3, 5, and 6 indicates that the tool or test equipment is allocated to that echelon. Columns 2 and 4 are not used.

(3) *Tool code.* This column lists the tool code assigned. The numbers are used

in the maintenance allocation chart to refer to the indicated item.
(4) *Remarks.* Not used.

2. Maintenance by Using Organizations

When this equipment is used by signal service organizations organic to theater headquarters or communication zones to provide theater communications, those maintenance functions

allocated up to and including fourth echelon are authorized to the organization operating this equipment.

3. Mounting Hardware

The basic entries of the maintenance allocation chart do not include mounting hardware such as screws, nuts, bolts, washers, brackets, and clamps.

Section II. MAINTENANCE ALLOCATION CHART

| (1) PART OR COMPONENT | (2) MAINTENANCE FUNCTION | (3) 1ST ECH | (4) 2ND ECH | (5) 3RD ECH | (6) 4TH ECH | (7) 5TH ECH | (8) TOOLS REQUIRED | (9) REMARKS |
|---|--------------------------------|-------------------|-------------------|-------------------|-------------------|-------------------|--------------------------|----------------|
| TEST SET, ELECTRON TUBE TV-7/U; TV-7A, B, D/U | service | X | | | | | | Visual only |
| | adjust | | | | X | X | 1, 2, 5 | |
| | inspect | X | | | | | | |
| | test | | | | X | X | 1, 3, 4, 6, 7 | |
| | replace | X | | | | | | |
| | repair | | | | | X | 5 | |
| ADAPTER, TUBE SOCKET | calibrate | | | | X | X | 1, 2, 6, 7 | |
| | rebuild | | | | | X | 5 | |
| ADAPTER, TUBE SOCKET | replace | | X | | | | | |
| | repair | | | | X | | | |
| BINDER, LOOSE LEAF | replace | | | | X | | | |
| BUTTON, PUSH | replace | | | | X | | 5 | |
| BUMPER, RUBBER | replace | | | | X | | | |
| INSULATOR, CLIP | replace | | X | | | | | |
| CABLE, POWER, ELECTRICAL | replace | | | | X | | | |
| CAPACITOR | replace | | | | X | | 5 | |
| CASE (2) ELECTRICAL EQUIP CABINET | replace | | | | | X | 5 | |
| | repair | | | | | X | 5 | |
| CATCH, LUGGAGE | replace | | | | X | | 5 | |
| HANDLE, LUGGAGE | replace | | | | X | | 5 | |
| CLAMP, ELECTRICAL | replace | | X | | | | | |
| CONNECTOR | replace | | | | X | | 5 | |
| DIAL CONTROL | replace | | | | X | | | |
| | repair | | | | X | | | |
| ELECTRON TUBE | replace | X | | | | | | |
| | | | | | | | | |

| (1) | (2) | (3) | (4) | (5) | (6) | (7) | (8) | (9) |
|-----------------------------------|-------------------------|------------|------------|------------|------------|------------|-------------------|---------|
| PART OR COMPONENT | MAINTENANCE FUNCTION | 1ST ECH | 2ND ECH | 3RD ECH | 4TH ECH | 5TH ECH | TOOLS REQUIRED | REMARKS |
| TV-7/U; TV-7A, B, D/U (continued) | | | | | | | | |
| GASKET, RUBBER | replace | | | | X | | 5 | |
| | rebuild | | | | | X | 5 | |
| GROMMET, RUBBER | replace | | | | X | | 5 | |
| HINGE, BUTT | replace | | | | X | | 5 | |
| KNOB | replace | | X | | | | | |
| LAMP, GLOW | replace | X | | | | | | |
| LAMP, INCANDESCENT | replace | X | | | | | | |
| LAMPHOLDER | replace | | | | X | | 5 | |
| LIGHT INDICATOR | replace | | | | X | | 5 | |
| LENS, INDICATOR LIGHT | replace | | X | | | | | |
| LEAD, TEST | replace | | | | X | | | |
| | rebuild | | | | X | | 5 | |
| CLIP, ELECTRICAL | replace | | | | X | | 5 | |
| JACK, TIP | replace | | | | X | | 5 | |
| METER, ELECTRON TUBE TESTER | replace | | | | X | | 5 | |
| | repair | | | | | X | 5 | |
| RECTIFIER, METALLIC | replace | | | | X | | 5 | |
| RESISTOR | replace | | | | X | | 5 | |
| RETAINER, ELECTRON TUBE | replace | | | | X | | 5 | |
| SOCKET, ELECTRON TUBE | replace | | | | X | | 5 | |
| STRAIGHTENER, PIN | replace | | | | | X | | |
| STUD, THREADED | replace | | | | X | | | |
| SWITCH | replace | | | | X | | 5 | |
| TERMINAL, STUD | replace | | | | X | | 5 | |
| TRANSFORMER, POWER | replace | | | | X | | 5 | |

| (1) TOOLS REQUIRED FOR MAINTENANCE FUNCTIONS | (2) 1ST ECH. | (3) 2ND ECH. | (4) 3RD ECH. | (5) 4TH ECH. | (6) 5TH ECH. | (7) TOOL CODE | (8) REMARKS |
|---|--------------------|--------------------|--------------------|--------------------|--------------------|---------------------|----------------|
| TV-7/U; TV-7A, B, D/U | | | | | | | |
| MULTIMETER TS-382/U | | | | † | † | 1 | |
| RESISTOR, DECADE ZN-16/U | | | | † | † | 2 | |
| TEST SET, ELECTRON TUBE TV-7/U | | | | † | | 3 | |
| TEST SET, ELECTRON TUBE TV-9/U | | | | | † | 4 | |
| TOOL EQUIPMENT TE-113 | | | | † | † | 5 | |
| TRANSFORMER, VARIABLE CN-16/U | | | | † | † | 6 | |
| VOLTMETER, METER ME-30/U | | | | † | † | 7 | |
| TOOL AND TEST EQUIPMENT NORMALLY AVAILABLE TO THE REPAIRMAN USER BECAUSE OF HIS ASSIGNED MISSION | | † | | | | 8 | |
| | | | | | | | |

By Order of *Wilber M. Brucker, Secretary of the Army:*

L. L. LEMNITZER
General, United States Army,
Chief of Staff.

Official:

R. V. LEE,
Major General, United States Army,
The Adjutant General.

Distribution:

Active Army:

To be distributed in accordance with DA Form 12-7 requirements for TM 11 Series plus the following additional formula:

| | |
|--|---------------|
| USASA (1) | 5-848 |
| CNGB (1) | 5-855 |
| Def Atomic Spt Agcy (5) | 5-856 |
| Tech Stf, DA (1) except | 5-872 |
| CSigO (18) | 5-876 |
| USA Abn & Elct Bd (1) | 5-415 |
| USA ATB (1) | 5-416 |
| US ARADCOM (2) | 5-500 (AA-AD) |
| US ARADCOM Rgn (2) | 5-600 |
| MDW (1) | 5-605 |
| Seventh, US Army (5) | 5-617 |
| EUSA (5) | 5-627 |
| Corps (2) | 6-100 |
| USASCS (25) | 6-101 |
| JBUSMC (2) | 6-115 |
| Units org under the fol TOE: (2 copies | 6-116 |
| each) | 6-125 |
| 1-7 | 6-126 |
| 1-17 | 6-135 |
| 1-26 | 6-136 |
| 1-27 | 6-200 |
| 1-37 | 6-201 |
| 1-67 | 6-300 |
| 1-107 | 6-301 |
| 1-207 | 6-315 |
| 5-5 | 6-316 |
| 5-6 | 6-325 |
| 5-7 | 6-326 |
| 5-8 | 6-401 |
| 5-15 | 6-415 |
| 5-16 | 6-416 |
| 5-17 | 6-500 |
| 5-35 | 6-501 |
| 5-36 | 6-525 |
| 5-37 | 6-535 |
| 5-138 | 6-536 |
| 5-192 | 6-537 |
| 5-215 | 6-545 |
| 5-216 | 6-558 |
| 5-217 | 6-575 |
| 5-218 | 6-576 |
| 5-225 | 6-577 |
| 5-226 | 6-585 |
| 5-227 | 6-611 |
| 5-278 | 6-630 |

| | |
|---------------|----------------|
| 6-681 | 11-158 |
| 6-685 | 11-500 (AA-AE) |
| 7 | 11-555 |
| 7-2 | 11-557 |
| 7-11 | 11-558 |
| 7-12 | 11-587 |
| 7-15 | 11-592 |
| 7-16 | 11-597 |
| 7-19 | 11-608 |
| 7-25 | 12-17 |
| 7-26 | 12-32 |
| 7-27 | 17 |
| 7-31 | 17-2 |
| 7-32 | 17-17 |
| 7-52 | 17-22 |
| 7-95 | 17-25 |
| 7-96 | 17-26 |
| 8-15 | 17-27 |
| 8-16 | 17-32 |
| 8-75 | 17-35 |
| 8-137 | 17-36 |
| 8-500 (AA-AH) | 17-37 |
| 9-22 | 17-45 |
| 9-47 | 17-46 |
| 9-65 | 17-51 |
| 9-66 | 17-52 |
| 9-76 | 17-53 |
| 9-86 | 17-55 |
| 9-217 | 17-56 |
| 9-377 | 17-57 |
| 9-500 (AA-AC) | 17-62 |
| 10-22 | 17-65 |
| 10-377 | 17-66 |
| 10-536 | 17-67 |
| 11-5 | 17-85 |
| 11-6 | 17-86 |
| 11-7 | 17-87 |
| 11-8 | 17-115 |
| 11-15 | 17-116 |
| 11-16 | 17-117 |
| 11-17 | 17-125 |
| 11-18 | 17-126 |
| 11-26 | 17-127 |
| 11-37 | 19-27 |
| 11-38 | 19-29 |
| 11-39 | 19-35 |
| 11-45 | 19-37 |
| 11-46 | 19-55 |
| 11-47 | 19-57 |
| 11-55 | 19-217 |
| 11-56 | 19-500 (AA-AE) |
| 11-57 | 20-45 |
| 11-58 | 20-46 |
| 11-95 | 29-56 |
| 11-96 | 30-15 |
| 11-97 | 30-19 |
| 11-98 | 30-22 |
| 11-99 | 32-51 |
| 11-117 | 32-56 |
| 11-155 | 32-57 |
| 11-156 | 32-500 |
| 11-157 | 33-2 |

| | |
|-----------------|----------------|
| 33-56 | 44-446 |
| 33-58 | 44-447 |
| 33-67 (AA-AC) | 44-448 |
| 33-77 | 44-500 |
| 33-510 (AA, AB) | 44-535 |
| 39-51 | 44-536 |
| 39-52 | 44-537 |
| 39-61 | 44-544 |
| 39-71 | 44-545 |
| 39-401 | 44-546 |
| 44-7 | 44-547 |
| 44-8 | 44-548 |
| 44-12 | 44-549 |
| 44-15 | 45-500 (AA-AC) |
| 44-16 | 55-11 |
| 44-35 | 55-12 |
| 44-36 | 55-16 |
| 44-37 | 55-27 |
| 44-67 | 55-38 |
| 44-70 | 55-46 |
| 44-85 | 55-47 |
| 44-86 | 55-57 |
| 44-87 | 55-75 |
| 44-101 | 55-76 |
| 44-115 | 55-78 |
| 44-116 | 55-116 |
| 44-235 | 55-126 |
| 44-236 | 55-127 |
| 44-237 | 55-128 |
| 44-246 | 55-129 |
| 44-435 | 55-157 |
| 44-436 | 55-500 (AA-AE) |
| 44-437 | 57 |
| 44-445 | |

NG: State AG (3); **Units**—Same as Active Army except a llowance is one copy to each unit.

USAR: None

For explanation of a bbreviations used, see AR 320-50.

