

38-1

NOT TO BE PUBLISHED

The information given in this document is not to be disseminated other than directly, or indirectly, by the Press or in any printed or written or official medium in His Majesty's Service.

**WORKING
INSTRUCTIONS**

**WIRELESS SET (CANADIAN)
No. 19 Mark III**

Published by:
The Director
Communications and Electrical Design
MCO Branch
Department of National Defence
Ottawa, Canada

Approved by:
The Chief of the General Staff,
Department of National Defence,
Ottawa, Canada.

(Ref. No. RCA 113913-1)

WIRELESS SET CANADIAN No. 19 MARK III

CONTENTS

CHAPTER I

INTRODUCTION

	Page
1.1 Special Features of W/S Cdn No. 19 Mk III.....	9
1.1.1 Supply Unit	9
1.1.2 Sender/Receiver Chassis	10

CHAPTER II

DESCRIPTION

2.1 General	12
2.2 Installation	13
2.3 The A-Set	13
2.3.1 Description	13
2.3.2 Aerials	14
2.4 The B-Set	15
2.5 The Intercommunication Amplifier	15
2.6 The Supply Unit	15
2.7 Current Drain	16
2.8 Control Units and Junction Distribution Boxes....	16
2.9 Remote Control	17

CHAPTER III

OPERATING INSTRUCTIONS

3.1 General	19
3.2 The Controls and Adjustments	21
3.2.1 A Frequency Mcs.	23
3.2.2 A PA Tuning	24
3.2.3 Flick Adj	24
3.2.4 $4\frac{1}{2}$ —8 Mcs 2— $4\frac{1}{2}$	24
3.2.5 RF Gain A	24
3.2.6 AF Gain A	24
3.2.7 MCW CW R/T	25
3.2.8 Het Tone	25

CHAPTER III—Cont.

OPERATING INSTRUCTIONS		Page
3.2.9	Net	25
3.2.10	AVC On-Off	25
3.2.11	A On-Off	25
3.2.12	B On-Off	25
3.2.13	LC On-Off	25
3.2.14	Key A	25
3.2.15	AK, AVC, LT, HT1, HT2, Drive.....	24
3.2.16	Tuning B	24
3.2.17	Gain B	24
3.2.18	Quench	28
3.2.19	Vibr-Off-Dyn (Supply Unit)	28
3.2.20	Variometer	28
3.3	Netting Drill—A—Set	29
3.3.1	Preliminary to the Tuning Call	29
3.3.2	During the Tuning Call	29
3.3.3	During the Netting Call	30
3.3.4	During the Tune-Up Phase	30
3.4	Testing and Netting the B-Set	31
3.4.1	Preliminary	31
3.4.2	Netting	32
3.5	The Intercommunication Amplifier	33
3.6	Control Unit Switches	33

CHAPTER IV

MAINTENANCE

4.1	Operator's Maintenance	35
4.1.1	Daily Maintenance	35
4.1.2	Weekly Maintenance	38
4.1.3	Running Repairs	39

APPENDIX I

TECHNICAL DESCRIPTION

1.1	The A-Set	42
1.1.1	Circuit Arrangements	42
1.1.2	Flick Mechanism	43

APPENDIX I—Cont.

TECHNICAL DESCRIPTION		Page
12	The A-Set Receiver	43
12.1	R.F. Amplifier	43
12.2	Frequency Changer	43
12.3	1st I.F. Stage	44
12.4	2nd I.F. Stage	44
12.5	Detector, AVC and Output Stage	44
12.6	Beat Frequency Oscillator	45
13	The A-Set Sender	45
13.1	Master Oscillator Stage	45
13.2	Sender Frequency Changer	45
13.3	Buffer Stage (R.F. Amplifier)	46
13.4	Power Amplifier	46
13.5	Modulation	47
14	The B-Set	48
14.1	Circuit Arrangements	48
15	B-Set Receiver	48
15.1	Detector Stage	48
15.2	1st A.F. Amplifier	49
15.3	2nd A.F. Amplifier (Output)	49
16	B-Set Sender	49
16.1	Modulation Amplifier	49
16.2	Modulator	49
16.3	Oscillator	49
17	Send-Receive Switching	49
18	Intercommunication Amplifier	50
19	Aerials	50
19.1	A-Set Rod Aerials	51
19.2	A-Set Horizontal Aerials	51
19.3	A-Set Aerial Circuit	52
19.4	B-Set Aerial	52
110	The Supply Unit	53
111	Audio Equipment	54
111.1	Microphone and Receiver Headgear No. 1	54
111.2	Microphone and Receiver Headgear No. 2	54

APPENDIX II

Adapting A W/S No. 19 Mk I or II to Use Supply Unit No. 2	55
---	----

APPENDIX III

Control Units and Junction Distribution Boxes.

III.1	General	57
III.2	Control Unit No. 1	58
III.3	Control Unit No. 1 Mk II	58
III.4	Control Unit No. 1A	58
III.5	Control Unit No. 1A Mk II	58
III.6	Control Unit No. 2	58
III.7	Control Unit No. 2 Mk II	59
III.8	Control Unit No. 3	59
III.9	Control Unit No. 3 Mk II	59
III.10	Control Unit No. 3A	59
III.11	Control Unit No. 3A Mk II	59
III.12	Control Unit No. 3B	59
III.13	Control Unit No. 3B Mk II	59
III.14	Control Unit No. 3C	60
III.15	Control Unit No. 3C Mk II	60
III.16	Control Unit No. 4	60
III.17	Control Unit No. 5	61
III.18	Control Unit No. 6	61
III.19	Control Unit No. 7	61
III.20	Control Unit No. 8	61
III.21	Junctions Distribution No. 1	62
III.22	Junctions Distribution No. 2	62
III.23	Junctions Distribution No. 3	62
III.24	Junctions Distribution No. 4	62

APPENDIX IV

Electrician's Maintenance

IV.1	General	64
IV.2	Aerials	64
IV.3	Variometer	64
IV.4	Aerial Leads	65

APPENDIX IV (Contd.)

Electrician's Maintenance

	Page
IV.5 Supply Unit	65
IV.6 Set	65
IV.7 Harness	66
IV.8 Operation	67
IV.9 Valve Tests	67
IV.10 A-Set Send-Receive Alignment	69
IV.11 A-Set Calibration	70
IV.12 Vehicle Suppression and Screening	70
IV.13 The Maintenance Chart	70
IV.14 Progressive Resistance Analysis	70

APPENDIX V

Technical Differences Between W/S No. 19 Mk. III Canadian and British.....	73
---	----

PHOTOGRAPHS

1. Front View of Set and Supply Unit	109
2. Inside View of Variometer	111
3. Installation Equipment for Ram II	113
4. Installation Equipment for Truck Ground Station..	115

DIAGRAMS

1. What are all the Knobs for?	22
2. Netting Drill for A-Set	27
3. Block Diagram	117
4. Schematic of A-Set	119
5. Schematic of B-Set	121
6. Schematic of I-C Amplifier	123
7. Schematic of Supply Unit	125
8. Schematic of Control Unit 3A	127
9. Top Plan of Chassis	129
10. Underneath Plan of Chassis	131
11. Plan of Control Units and Junctions Distribution	133
12. Schematic of Junctions Distribution No. 1, 3 and Headgear	135

TABLES

	Page
1. Overall Dimensions and Weights	13
2. Current Drain	16
3. Running Repairs	40
4. Valves for A-Set	42
5. Valves for B-Set	48
6. Valves for I-C Amplifier	50
7. Horizontal Aerials	51
8. Valve Test Figures with A-Set Receiving	68
9. Valve Test Figures with A-Set Sending	68
10. Valve Test Figures with B-Set Receiving	69
11. Valve Test Figures on I-C	69
12. Component Parts List	75
13. Set Kit	94
14. Normal Meter Readings	99
15. Tests for Daily Maintenance	100
16. Progressive Resistance Analysis	104
17. Maintenance Log	108

ABBREVIATIONS

A	"A" Set	MA	Milliampere
AE	Aerial	Mc	Megacycles per second
AF	Audio Frequency	MCW	Modulated Continuous Wave
AVC	Automatic Volume Control	MFD	Micro-farad
B	"B" Set	MMF	Micro-micro-farad
BFO	Beat Frequency Oscillator	OSC	Oscillator
CW	Continuous Wave	PA	Power Amplifier
DF	Direction Finding	RF	Radio Frequency
H	Henry	R/T	Radio Telephony (Speech)
HF	High Frequency	S/R	Sender/Receiver
HT	High Tension	V	Volts
I.C.	Intercommunication Amplifier	VHF	Very High Frequency
Kc	Kilocycles per second	W	Watts
LT	Low Tension		

CHAPTER I

INTRODUCTION

Wireless Set (Canadian) No. 19 Mk. III is an improved version of W/S No. 19 Mk. II. A number of changes and modifications were incorporated to make the operation of the set more flexible.

The Canadian Mk. III set is fully, mutually interchangeable in all its applications and installations with Wireless Set No. 19 Mk. II of British, Canadian and U.S. manufacture as well as the British Mk. III Set.

1.1 SPECIAL FEATURES OF WIRELESS SET, CANADIAN, NO. 19 MK. III

1.1.1 SUPPLY UNIT

The Canadian Supply Unit No. 2 is fully, mutually interchangeable with the British Mk. III Supply Unit and is also interchangeable with Canadian, British and U.S. Supply Units No. 1, if a special adaptor is used.

The Supply Unit is designed to give maximum efficiency and economy on Receive. The Set may be powered solely by the dynamotor, or by the combination of the dynamotor and vibrator. The selection is made by a toggle switch on the panel of the Supply Unit. In the VIBR position a small non-synchronous vibrator provides the anode voltages on Receive, while a 4-commutator dynamotor provides all the H.T. voltages on Send. The change-over from vibrator to dynamotor operation (in the VIBR position) is done automatically by means of a relay in the Supply Unit which is operated by the pressel (Send/Receive) switch. This arrangement ensures maximum economy combined with maximum security.

The Supply Unit will operate from a 12 volt battery, a 24 volt 3-wire system, or a 24 volt 2-wire system. When

using a 24 volt system it is necessary to set the toggle switch inside the Supply Unit to the "24V" position.

When using a 3-wire 24 volt system the vibrator may be used, which ensures maximum economy and an unbalance of not more than 1 amp.

Unlike the Supply Unit No. 1, the No. 2 will operate from a 2-wire 24 volt system, but the Vibrator can not be used.

One spare Vibrator and one spare Rectifier Valve are provided with and mounted inside each Supply Unit.

A special low tension Vibrator FUSE, painted BLUE, is used on the Unit. This fuse is NOT interchangeable with the H.T. fuses.

1.1.2 SENDER/RECEIVER CHASSIS

(a) Slow Motion Drive

The Mk. III Set is provided with a Slow Motion Drive fitted to the A FREQUENCY MC control.

This drive consists of a large and a small knob. For coarse tuning the large knob should be used, for fine and accurate tuning the small one.

(b) Netting Switch

The push-button for NET has been replaced by a toggle-switch, in order to facilitate the operation of the A FREQUENCY MC control when netting.

(c) Separate "ON-OFF" switches for A, B and I.C.

Separate ON-OFF switches for A-, B-Set and I.C. Amplifier are provided, which enable the required facility to be switched on and off independently of the others.

(d) AVC "ON-OFF" Switch

An "ON-OFF" switch for the AVC has been provided because often improved performance may be obtained on CW if the receiver is working without AVC.

(e) R.F. GAIN CONTROL

This control has been provided to facilitate netting and tuning in close proximity of the Control Station. It is also required to adjust the signal-strength if the AVC switch is in the "OFF" position.

(f) FREQUENCY ADJ.

A frequency adjustment has been added to take care of small frequency drifts of the oscillator. It may be used to correct slight detuning caused by vibration, temperature or other reasons.

CHAPTER II

DESCRIPTION

2.1 GENERAL

Wireless Set, Canadian, No. 19 Mk. III has been designed primarily to provide a complete and reliable system of communications in Armoured Formations. It is not restricted to use in Armoured Formations, but may also be used in Armoured Fighting Vehicles (AFV), in various Wireless Trucks and as a Ground-Station. The Set provides the following communication facilities:—

- (i) The A-Set for long range communication
- (ii) The B-Set for short range communication
- (iii) The I.C. Amplifier for intercommunication within the vehicle.

Unlike the No. 19 Mk. II, it is possible on the Mk. III to switch-off the sets not in use. Since it is no longer necessary to heat the A-Set valves in order to operate the B-Set or I.C. Amplifier, the Mk. III is more economical in battery consumption. DO NOT keep the B-Set and the I.C. Amplifier turned "ON" if only the A-Set is required for communication.

Power is supplied to the Set by Supply Unit No. 2 which incorporates a vibrator as well as a dynamotor. The Set may be operated exclusively by the dynamotor; or by the vibrator on "receive" and by the dynamotor on "send". However it is NOT advisable to operate the A-Set, B-Set and I.C. amplifier simultaneously from the vibrator supply, since this puts too great a load on the vibrator. Any two of the above sets may be operated at the same time from the vibrator supply, but not all three. The use of the vibrator is recommended whenever possible, because the battery drain is considerably less when using the vibrator than when using the dynamotor.

The following table shows the weight and overall dimensions of the Set and Supply Unit.

TABLE I

UNIT	WEIGHT IN LBS.	DIMENSIONS IN INCHES		
		LENGTH	DEPTH	WIDTH
Sender/Receiver	40½	17½	8¼	12¾
Supply Unit	30½	6	8¼	12¾
Carrier No. 1	14½			
Set	88½	27	10	13¾

2.2 INSTALLATION

The complete station is packed in two kits known as the "Set Kit" and the "Installation Kit". The former contains the Sender/Receiver, Supply Unit No. 2, Variometer, Headsets, Microphones and all other parts common to all installations. The Installation Kit is specially prepared to suit the type of vehicle in which it is to be used and will contain all the parts necessary for installation in that type vehicle, i.e. control boxes, connectors, additional headgear etc.

2.3 THE A-SET

2.3.1 DESCRIPTION

The A-Set is a combination Sender/Receiver capable of transmission on R/T, M.C.W. and C.W. Since certain parts of the receiver and sender circuits are common, the tuning of the receiver automatically tunes the sender to the same frequency, thus simplifying netting.

The A-Set has 9 valves, three of which are common to the receiver and sender. The receiver is a 6 valve super-heterodyne having an I.F. of 465 Kcs. The sender also uses 6 valves.

The Set covers the frequency range from 2 Mcs (150 M) to 8 Mcs (87.5 M) in two bands. One band covers from 2

Mcs to $4\frac{1}{2}$ Mcs (66.6 M) and the other band from $4\frac{1}{2}$ Mcs to 8 Mcs. The appropriate band is selected by the Band-Change switch on the panel.

The A-Set has a flick-frequency control which permits two pre-selected frequencies to be set up and enables a rapid change from one to the other.

The set is provided with a fine adjustment to the flick-mechanism which permits a limited frequency variation on either side of the flick-setting without altering it. This adjustment gives the operator a ready means of correcting any frequency drift, but its presence should not relieve him from the responsibility of making an accurate initial flick-setting.

2.3.2 AERIALS

The A-Set is designed primarily to operate with 8', 12' or 16' rod aerials. The rod or whip aerials come in 4-foot sections and may be arranged either as single vertical aerials or, by using the special Aerial Base Adaptor as V-aerials. Sufficient rods are supplied to erect a double 16' aerial but the MAXIMUM height recommended for a vehicle in motion is a double 8 foot. The V-aerial is an excellent means of increasing radiation without increasing aerial height, and the directional properties of such an aerial are negligible. For short range communication under conditions in which the 8' aerial is regarded as too conspicuous a single or double 4' aerial may be used. In addition to the whip aerial, any of the usual types of elevated aerials may be used.

The rod aerial is mounted on aerial base No. 8. The aerial base or an elevated aerial is connected to the Variometer which, in turn is connected by a coaxial cable to the "AERIAL A" socket. The entire aerial circuit is fully screened to reduce interference from the engine or other electrical devices in the vehicle.

Using the 8' single vertical rod aerial communication over distances of about 10 miles on R/T and over about 20 miles on C.W. between vehicles in motion, is possible.

2.4 THE B-SET

The B-Set is a very high frequency (VHF) sender-receiver, which covers the frequency range from 230 Mcs (1.3M) to 240 Mcs (1.2M). It provides communication on speech only, over distances up to 1000 yards, over unobstructed level ground, between vehicles in motion.

The 20" aerial provided is a half-wave aerial which is connected directly from its Aerial Base No. 9 to the "AERIAL B" Socket by a coaxial cable. The length of this cable is important to the operation of the Set, and it must not be tampered with.

Since certain parts of the sender and receiver circuits are common, tuning the receiver, automatically tunes the sender, thus simplifying netting. Tuning the sender also tunes the aerial circuit for maximum output.

The B-Set has four valves, all of which are used in the receiver and three of which are used in the sender.

2.5 THE INTERCOMMUNICATION AMPLIFIER

The I.C. amplifier is a two valve "house telephone" to provide communication among the crew members in the vehicle.

2.6 THE SUPPLY UNIT

The No. 19 Mk. III receives its power from the Supply Unit No. 2, which contains a Vibrator Unit and a 4-commutator Dynamotor. It is possible to operate the set solely from the dynamotor, or from the combination of the dynamotor and vibrator, which is a more economical type of operation. The operator selects the type of power supply by a 3-position toggle switch on the panel of the Supply Unit. In the "DYN" position, the set operates exclusively from the dynamotor; in the "VIBR" position, H.T. 1 is supplied by the vibrator on receive. When the pressel switch is pressed for send, a relay cuts the vibrator out of the

circuit and starts the dynamotor. All voltages are then supplied from the dynamotor.

Supply Unit No. 2 will operate efficiently from either a 12 volt or a 24 volt battery. It will operate from either a 3-wire 24 volt system or a 2-wire 24 volt system. **The toggle switch inside the Supply Unit must be set to the voltage from which the set is operated.** When used on a 3-wire 24 volt system, the Supply Unit may be used in either the "VIBR" or "DYN" positions. However, when using a 2-wire 24 volt system, only the "DYN" position can be used.

The Supply Unit produces a nominal H.T.1 of 265 volts and an H.T.2 of 540 volts.

There are 3 fuses on the Supply Unit, two H.T. and one L.T. fuse. Both H.T. fuses are of the same type and mutually interchangeable. The VIBR fuse, painted BLUE, is a low tension fuse and must NOT be used as an H.T. fuse.

2.7 Current Drain

With a battery voltage of 12 volts, the current drain of the No. 19 Mk. III is:

TABLE II

	VIBRATOR	DYNAMOTOR
Receive A only approximately	4 amp.	8 amp.
Receive A and B approximately	6 "	10 "
" A and I.C. "	6 "	10 "
" B and I.C. "	4 "	7 "
" A, B and I.C. "	—	10 "
Send A only R/T	—	9 "
" A and B "	—	11 "
" A, B and I.C. "	—	12 "

2.8 CONTROL UNITS AND JUNCTION DISTRIBUTION BOXES

The control units and junction distribution boxes are installed within easy reach of every man who has to make use of the facilities provided by the No. 19 Set.

Junction distribution boxes are connected to the Inter-communication system only. Junction distribution boxes No. 1 and No. 3 have a special buzzer, operated by a push-button, which can be heard in the Commander's earphones and serves as an emergency signal.

The type and number of control units depends on the vehicle in which the station is installed. The installation instructions supplied with each installation kit contain the number and type of control units required together with detailed instructions for their installation.

The control unit is connected to the Set by a special connector, which carries all the necessary leads for the microphone, earphones, pressel switch, etc. The unit has one or more drop leads which connect to the snatch plugs on the headgear. The selector switch on the control unit permits the operator to select the A-Set, B-Set or I.C. amplifier as required. This arrangement provides separate, independent and simultaneous use of every facility of the No. 19 Set.

The control units are of the type which has both "normal" and "re-transmit" or "re-broadcast" facilities. In the "R" or "Re-broadcast" position it is possible to

- (1) Send on "A" the message being received on the "B". (Output of "B" modulates the "A" sender.)
- (2) Send or receive on "A" and "B" simultaneously.
- (3) Send on "B" the message being received on "A". (Output of "A" modulates the "B" sender.)

Therefore a No. 19 Mk. III station may be used as a relay station, and at the same time the operator can add his own speech to the re-broadcast.

2.9 REMOTE CONTROL

The No. 19 Mk. III may be operated by remote control and/or connected to a field exchange by means of Wireless Remote Control Units, Canadian, No. 1. The Control Units

may be separated by as much as three miles. They are connected by a metallic pair of "control cable", "D8 twisted" or "D3 twisted". Complete details of the installation and operation are contained in the pamphlet with each Remote Control Unit.

WARNING

- (1) When the operator on the Remote Unit is operating on R/T, the Set Operator must not play with the key on the Nearby Unit.
- (2) The Remote Unit Operator must not play with the key on his unit, when he is receiving on Remote R/T.

CHAPTER III

OPERATING INSTRUCTIONS

3.1 GENERAL

3.1.1 Under normal circumstances several stations will work on a GROUP or NET and all the stations on the NET will operate on the same frequency. One station, usually that at the higher formation, will act as CONTROL and will regulate the NET. It is of the utmost importance that all the OUT-STATIONS are accurately tuned to send and receive on exactly the same frequency as the control station.

It is customary to give such a NET two frequencies, the BLUE or normal and the RED or spare frequency. The flick mechanism permits a rapid change from one to the other.

3.1.2. A number of Wireless Sets No. 19 will be equipped with Crystal Calibrators to facilitate quick and accurate tuning.

3.1.3. Personnel connected to the A-set and B-set should always bear in mind that the pressel-switches on their microphones are also the send-receive switches for the sets, and that for security reasons they should NOT be pressed except to pass traffic.

The enemy can ascertain the frequency of the NET, and, by means of D.F. equipment, the location of the station, from the carrier.

When the Commander and the Operator are connected to the same set (A or B) each can monitor the other's conversation but they must not talk to one another, except on the I.C., because their conversation will go out over the air.

3.1.4 The A-set is capable of transmission on R/T MCW and CW. MCW and CW are two types of key operation and the following points should be remembered.

Advantages of OW.

- (a) Greater range.
- (b) If there is interference from other sets using R/T or MCW, less interference may be experienced when using CW.

Advantages of MCW.

- (a) If there is interference from other sets using CW, less interference may be experienced when using MCW.
- (b) The operator can hear his own signals in his headphones.
- (c) MCW can be received by a receiver set to R/T or MCW.

3.1.5. While working, if signals become worse or fail altogether the operator must keep calm and do what little he can to improve conditions. He should follow this sequence.

- (i) Check netting, and if necessary re-net to Control. Use the FLICK ADJ control for renetting and if control cannot be picked up return the FLICK ADJ to its centre position.
- (ii) Check the "ends"—batteries, headsets, aerial and all connections. Check meter reading on AE and also see if sidestone may be heard.
- (iii) Call a nearer station, to check the set.
- (iv) Increase the aerial length or use a double aerial. Remember to adjust the variometer, whenever the aerial is changed.
- (v) Call control on MCW: do not use OW unless ordered to do so.
- (vi) If none of the above attempts give results the set should be moved to a more favourable position.

- (vii) If results are still not attained, the operator should perform the Daily Maintenance Routine to locate any fault that may exist in his set and try to correct it by "Running Repairs".

3.1.6 The following points should be checked when installing the set or after it has been out of operation for a long period.

1. Check that the operating voltages are correct.
2. Check that the I-C Amplifier works satisfactorily.
3. Check that the side-tone of the "A"- and "B"- sets can be heard when sending. This test should be deleted in the field as it will permit the enemy to take D.F. bearings.
4. Check that the incoming signals on the "A"- and "B"- sets can be heard with the Control Unit switches set to I-C.
5. Check that the pilot lamp on the operator's Control Unit lights when the A-set is unattended.
6. Check that the aerial current and drive voltage readings on the meter approximate those shown in the table of Normal Readings.

3.1.7 The set kit contains a small dummy-aerial which fits into the aerial base and which may be used for tuning up the A-set without radiating too much. Full advantage of the facility provided by this dummy-aerial should be taken in the field.

3.2 THE CONTROLS AND ADJUSTMENTS

Before an operator can intelligently operate the set, he must become familiar with the position and purpose of each control. The following paragraphs contain a description of these controls.

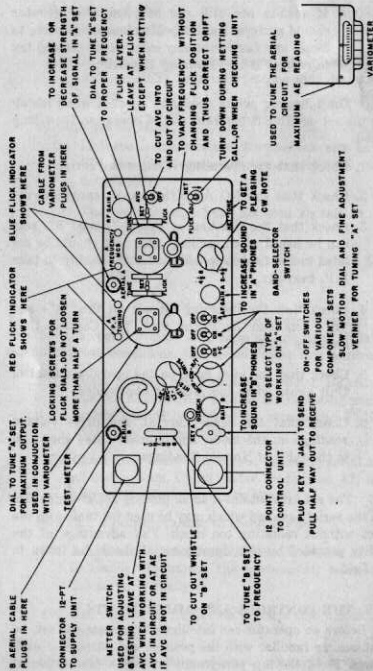

FIG. 1—WHAT ARE ALL THE KNOBS FOR?

3.2.1 A FREQUENCY MCS.

This Master Frequency Control tunes the sender and receiver simultaneously. It operates a 4-gang variable condenser which tunes all the RF tuned circuits in the A-set except the Aerial and Power Amplifier Anode circuits. It is fitted with a Slow Motion Drive. For coarse tuning the large knob should be used and for fine tuning the small one.

It is also fitted with a flick mechanism which is set up according to the following diagram. When the flick lever is at TUNE the flick indicators are disengaged and the Slow Motion Drive is engaged. In the SET position both the indicators and Slow Motion Drive are engaged. In the FLICK position the Slow Motion Drive is disengaged and the indicators are engaged. The flick locking screws must never be loosened more than a half turn

HOW TO SET UP A FLICK POSITION

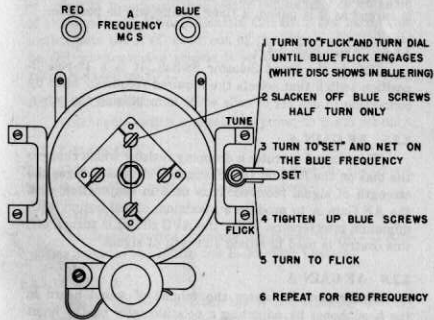

3.2.2 A PA TUNING

This control operates the single variable condenser which tunes the Anode circuit of the Power Amplifier on "send" and the grid of the RF Amplifier on "receive". It is used with the variometer to tune up for maximum output, and is fitted with a flick mechanism.

3.2.3 FLICK ADJ

This is a permeability-tuned adjustment to the master frequency control, which will change the frequency about 1 Kc on either side of the master setting at 2 Mcs and about 4 Kcs on either side at 8 Mcs. The neutral position of this adjustment is indicated by a click. For various reasons—such as changes in temperature or the state of the batteries—the set will vary slightly or drift in frequency. Drifting is indicated by a rise in pitch of incoming R/T signals and background rustle, and by a slight distortion of signals. By means of this control the operator can correct drift without altering his flick setting, by turning the NET switch on and pulling out or pushing in the FLICK ADJ. If the knob is turned as it is pulled, a finer setting will be possible.

3.2.4 "4½-8 MCS 2-4½"

This is the Band Selector Switch. It is a 12-pole 2-position switch that selects the required frequency band by connecting in one set of coils while immobilizing the other.

3.2.5 RF GAIN A

This control operates a dropping resistor which changes the bias on the RF and 1st IF stages and thus changes the strength of signal received. It is used in conjunction with the AF Gain A to produce a maximum signal output with minimum interference. When the AVC circuit is turned off, this control is used to adjust strength of signal.

3.2.6 AF GAIN A

This control regulates the volume of sound heard in the headphones by adjusting a potentiometer on the input to the AF Amplifier which operates the phones.

3.2.7 MCW CW R/T

This Mode of Operation Switch selects the type of communication to be used e.g. R/T (Radio-Telephony), CW (Continuous Wave) or MCW (Modulated Continuous Wave).

3.2.8 HET TONE

This control adjusts the frequency of the BFO over a range from 700 cs to 1800 cs and consequently changes the pitch of the CW note received. It is used only on CW reception.

3.2.9. NET

This switch is used to net the A-set to the incoming signal by means of zero beat. It operates a 465 Kcs Heterodyne Oscillator to beat against the signal produced in the IF Stage by the incoming carrier. At zero beat, this IF signal is also 465 Kcs and the set is netted. When the switch is down the oscillator is operating.

3.2.10 AVC ON-OFF

On CW it is found that better results may be obtained if the Automatic Volume Control Circuit is not used. This switch cuts the AVC in or out of the circuit. AVC should be ON whenever the vehicle is on the move or when the set is working on R/T.

3.2.11 A ON-OFF

This toggle switch connects the power to the A set only.

3.2.12 B ON-OFF

This toggle switch connects the power to the B set and also the L.T. to the I.C. valve heaters.

3.2.13 I-C ON-OFF

This toggle switch connects the power to the I-C Amplifier and also the L.T. to the B-set valve heaters.

3.2.14 KEY A

This is the key jack for the A set. Pushing the key assembly plug fully into the jack puts the set on Send and pulling the plug half way out puts the set on Receive. This

is the only means of Send-Receive Switching on CW or MCW.

3.2.15 AE, AVC, LT, HT1, HT2, DRIVE

This switch enables the test meter to be used for the following purposes:—

- (1) AE—measures aerial current through the variometer. Maximum reading indicates that the sender is operating properly and that the aerial circuit is tuned.
- (2) AVC—maximum dip on the meter indicates that the receiver is properly tuned to the incoming signal.
- (3) LT—checks the low tension voltage applied to the heaters, relays, etc.
- (4) HT1—measures the high tension applied to the receiver (265 volts)
- (5) HT2—measures the high tension applied to the sender (540 volts). This reading can only be taken when the supply unit switch is on DYN, or the pressel-switch is operated.
- (6) DRIVE—measures the input to the PA stage. This reading indicates that the Sender is working properly up to the P.A. circuit. The set must be on transmit.

3.2.16 TUNING B

This dial tunes the B set over the range from 230 to 240 Mcs, by means of a Split Stator Variable Condenser. The dial is calibrated in 10 equal divisions, not by frequency, to enable the operator to preset his dial more easily.

3.2.17 GAIN B

This control regulates the volume of sound heard in the B-set phones, by means of a potentiometer on the input side of the AF Output stage.

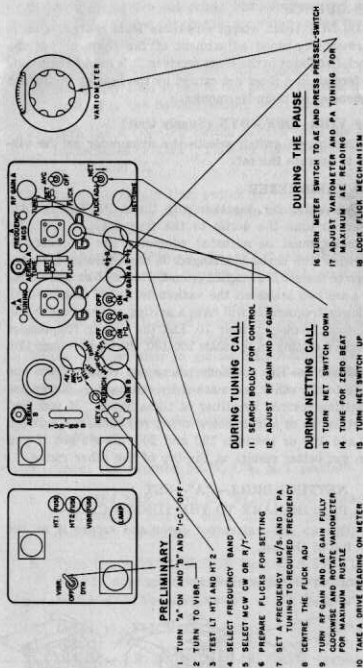

3.2.18 QUENCH

Do NOT touch except on orders from control. This is a permeability-tuned adjustment of the frequency of the Quench Oscillator in the B-set receiver. It is used to eliminate interference in a B-set net caused by the beating of Quench Frequencies or their Harmonics.

3.2.19 VIBR - OFF - DYN (Supply Unit)

This toggle switch selects the dynamotor or the vibrator to operate the set.

3.2.20 VARIOMETER

The variometer, together with the A PA Tuning Dial, is used to tune the aerial to the frequency in use. The variometer must be adjusted whenever the frequency is changed or the aerial is changed. It must also be adjusted whenever the set is switched from CW to R/T or vice versa. There are two scales on the variometer 0-100 and 200-100. The lower frequencies will have a setting on the scale 0-100, the lowest frequency near 10, and the higher frequencies will have a setting on the scale 200-100, the highest near 110.

WARNING—The positions where you change from one scale to the other are marked by red bands. Never use a setting covered by either of these bands. If you find a setting on or a little below either red band, say between 80 and 100 or between 180 and 200, always see if you can get better results at the top of the other range.

3.3 NETTING DRILL—"A"—SET

3.3.1 PRELIMINARY TO THE TUNING CALL

1. Roll up the waterproof cover and secure it at the top of the set.

ROLLING UP THE WATERPROOF COVER

1. Lift Cover up

2. Roll up Tightly

3. Fasten Press-Studs

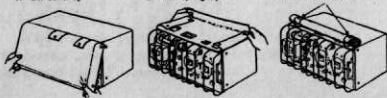

2. Connect up the batteries, headsets, control units, aerial leads and variometer according to the installation instructions.

WARNING—Be sure that the toggle switch inside the Supply Unit is set to the proper position corresponding to the battery supply being used.

3. Turn the A ON-OFF switch to "ON" and the B and I-C switches to "OFF". Turn the control unit switches to "N" and "A".
4. Turn the Supply Unit switch to "VIBR". Allow 30 seconds for the valves to warm up before operating any of the sets.

WARNING—If the A-, B- and I-C sets are to be used simultaneously the Supply Unit switch must be set to "DYN".

5. Take LT, HT1 and HT2 readings on the test meter. It will be necessary to turn the Supply Unit switch to DYN in order to get an HT2 reading. Do NOT press the pressel-switch until the set has had 30 seconds to warm up.
6. Select the required position of the Band Change Switch.
7. Select the required MCW, CW, R/T position.
8. Turn the flick levers to "FLICK" and release the flick locking screws when the flick indicators are showing. Then turn the flick levers to "SET".
9. Turn the A FREQUENCY Mc and A PA TUNING dials to approximately the required frequency. Be sure to read the proper scale on the frequency dial.
10. Centre the FLICK ADJ control.
11. With the RF GAIN and AF GAIN turned fully clockwise, rotate the variometer for maximum back-

ground rustle. This noise indicates that the receiver and aerial circuits are working.

12. After the 30 second warm up, press the pressel-switch and take a DRIVE reading on the meter. This reading indicates that the sender circuits up to the PA stage are working. There should also be an AE reading on the meter indicating that the sender is radiating.
13. With the A-set on R/T, blow into the microphone and listen for sidetone. This checks the headset and microphone circuit.

NOTE: In the field, it may be advisable for security reasons to omit items 12 and 13.

3.3.2 DURING THE TUNING CALL

14. Search boldly for the signal from the control station using the Slow Motion Drive on the master tuning dial. Having found the signal tune for the maximum dip in the AVC. Then adjust the RF GAIN and the AF GAIN until a comfortable signal is heard.

3.3.3 DURING THE NETTING CALL

15. Turn the NET switch down and tune the master tuning dial for zero beat, which is indicated by the silent point between two low-pitched whistles. The sender will then transmit on the same frequency as the incoming signal and the set is "netted" to control.
16. Turn the NET switch up.

3.3.4 DURING THE TUNE-UP PAUSE

17. Turn the meter switch to AE.
18. Put the set on "send" by pressing the pressel-switch or plugging in the key and pressing it.
19. Adjust the Variometer for a reading on the meter. Then adjust the PA TUNING and the Variometer successively for the maximum AE reading. Be sure

FINDING THE SILENT POINT (ZERO BEAT)

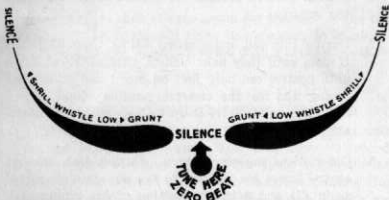

the final Variometer setting is NOT on one of the red marks.

20. Tighten the flick locking screws on the flick being used.
21. Note the Variometer setting on the tablet provided on the set and also in the log.

NOTE—If tuning up on CW it will be necessary to push the key plug in and press the key to obtain an AE reading.

3.4 TESTING AND NETTING THE B-SET

3.4.1 PRELIMINARY

1. Turn the B ON-OFF switch to ON and allow 30 seconds for the valves to warm up.
2. Turn the control unit switches to "N" and "B".
3. Turn GAIN B fully clockwise. A rushing noise will indicate that the receiver is operating.
4. Press the pressel switch and the rushing noise will cease, indicating that the sender is working.
5. Put the TUNING B dial to the ordered setting.

3.4.2 NETTING

6. Control Station presses his pressel-switch and calls the group.
7. During this call, out-stations adjust their TUNING B dials until they hear control, turn GAIN B down until control can only just be heard and adjust the tuning dial for the clearest possible signal. They may then turn GAIN B up to hear control comfortably.
8. Out-stations answer in turn. During each answer, control tunes his "B" set to the out-station's signal as in (7) and notes the setting of his tuning dial. If this is more than one division different from the ordered frequency, the out-station is badly off net.
9. Control station calls all out-stations and tells them "OK off" if they have netted properly. If a station is badly off the net, control tells him to alter the setting of his tuning dial up or down, according to the notes made in (8) above and to answer him again.

The "QUENCH" Adjuster — This should NEVER be touched except on orders from CONTROL.

10. Sometimes a whistle interferes with the working of the net. If this happens, Control orders all out-stations to screw their quench adjusters right IN, and does so himself. He then orders all out-stations but one to switch their "B" sets off; call this one station "No. 1". If there is still a whistle, Control orders No. 1 to screw his adjuster slowly out again, and both listen. When the whistle pitch is too high to be heard, No. 1 stops screwing and tells Control "OK".
11. Control tells another out-station (call him No. 2), by shouting or other means, to switch his "B" set on. If there is a whistle, No. 2 screws his adjuster

slowly out. When he can no longer hear the whistle, he stops screwing and tells Control "OK".

12. The same drill is done again for the rest of the out-stations. It should never be necessary to touch the "QUENCH" adjusters again until a new set joins the group.

3.5 THE INTERCOMMUNICATION AMPLIFIER

The operation of the I-C Amplifier is very simple. Turn the I-C ON-OFF switch "ON" and allow 30 seconds for the valves to warm up. (If the B-set is ON the I-C valves will be warmed up.) Then turn the Control Unit Switches to "N" and "I-C", press the pressel switch and speak. The operator's voice should be heard in each headset connected to the I-C Amplifier, including his own. It is well to note here that if all the Control Units are switched to I-C, the pilot lamp on the operator's Control Unit will not light up indicating that the A-set is unattended because the signals coming in on either the A-set or the B-set can be heard on the I-C Amplifier sufficiently well to tell the operator that someone is calling him.

Those personnel who are connected only to the I-C Amplifier and who are wearing breast-plates may lock their pressel-switches on send and thus free both hands. Under no circumstances should the pressel-switch be locked when operating the A- or B- set because this will keep the set on "send" as long as the pressel-switch is pressed.

3.6 CONTROL UNIT SWITCHES

3.6.1 THE N - R SWITCH

This is a two-position switch which permits the selection of the "Normal" facilities in the N position and the "Rebroadcast" facilities of the No. 19 set in the R position.

3.6.2 THE A - I-C - B SWITCH

This switch has two sets of markings. When the N - R Switch is in the N position this switch permits the normal

selection of the A-set, the B-set or the I-C Amplifier. It is possible to have one Control Box, set to A, operating the A-set and another Control Box, set to B, operating the B-set. It is necessary for personnel provided with Control Boxes to switch to I-C in order to communicate with the remainder of the personnel who are connected to the I-C Amplifier only. On the Control boxes with several drop leads, only a few of these drop leads are connected to the A, I-C and B system and consequently are capable of controlling the sender-receiver units. The remaining drop leads are connected only to the I-C Amplifier, as are all drop leads from Junction Distribution Boxes.

3.6.3 A - B, A & B, B - A

This is the alternate marking of the A, I-C, B switch. When the N-R Switch is in the R position, the "Rebroadcast" facilities will be used. If the message being received on the A-set is to be retransmitted automatically on the B-set this switch must be in the A-B position. When this switch is in the A & B position, one pressel switch will operate the A- and B-sets simultaneously. If the message being received on the B-set is to be retransmitted automatically on the A-set this switch must be in the B - A position.

CHAPTER IV

MAINTENANCE

4.1 OPERATOR'S MAINTENANCE

The operator is not expected to be an expert instrument mechanic or electrician, but he MUST be able to do these three maintenance duties on the set:—

- (a) Perform the Daily Maintenance Tests to check that every bit of the set and every accessory is working properly.
- (b) Carry out Weekly Maintenance to keep the set clean, the controls operating smoothly and to service parts that are beginning to wear or work loose.
- (c) Repair some of the common faults that occur in the field, as shown in Running Repairs.

It is vitally important that faults be found and reported AS SOON AS POSSIBLE so that the electrician or instrument mechanic can repair them before the set is required in battle.

4.1.1 DAILY MAINTENANCE

The operator's daily maintenance consists of completing the Daily Maintenance Tests, shown on pages 100-103. The following hints will be found valuable.

- (a) Supply Unit Connectors and Aerial Feeders.

These should only be disconnected for cleaning, repairing or replacement.

- (b) Changing a Fuse.

Unscrew the fuse cap and replace the fuse as shown in the diagram.

HOW TO ADJUST DRIVER'S BUZZER

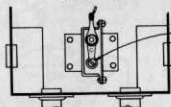

1. PRESS BUTTON
2. ADJUST SCREW UNTIL BUZZER WORKS PROPERLY.
3. SEAL SCREW TO SPRING WITH SHELLAC OR A FAST DRYING LACQUER.

NOTE: The Daily Maintenance Tests must be done in the order given. For example, test 2 will not work unless test 1 has been completed. The tests should be done daily even though the set is not going to be used.

4.1.2 WEEKLY MAINTENANCE

Weekly maintenance shall include

- (a) Complete the Daily Maintenance Tests for the day.
- (b) Clean the outside of the set, supply unit and variometer with a cloth to remove dirt and grease. Do NOT use brasso or petrol or like cleaning materials.
- (c) Check all controls to see that they are not jamming or turning so easily that the shaking of the vehicle will alter their setting.
- (d) Check the spare parts kit to see that it is complete according to the list on its lid.
- (e) See that the spare valves case contains all the valves and that the Supply Unit has a spare valve and a spare Vibrator.
- (f) Report at ONCE
 - (i) Any faults that require the attention of an instrument mechanic or electrician.
 - (ii) Any missing pieces of kit.

- (g) Carry out aerial maintenance according to the diagram.

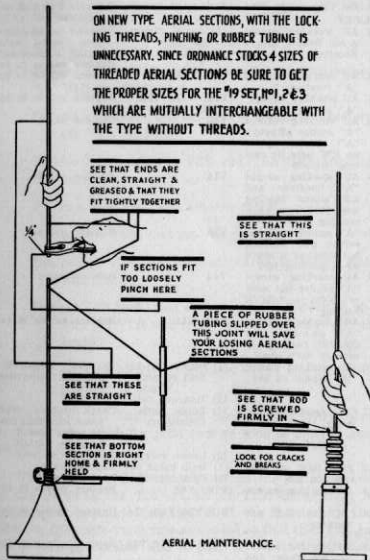

4.1.3 RUNNING REPAIRS

If the set or any part works badly or stops working, try the cure for the particular failure that is shown in the following table.

RUNNING REPAIRS—TABLE 3

Failure	Possible Cause	Possible Cure
POWER		
1. Set Completely dead	Failure of power	Do tests 1 to 8 of daily maintenance
A-SET		
2. All working except A-set Sender and Receiver	(1) Aerial disconnected (2) V4A, V2A, V3A, V1A	Examine aerial connections and replace pigtail if necessary Replace valves in turn
3. All working except "A" receiver	V1A, V1B, V1C	Replace valves in turn
4. All working except "A" sender	V2B, V4A, V5A, V6A	Replace valves in turn
5. All working except "A" sender although "A" receiver gives no CW note or netting whistle	V2B	Replace valve
6. All working except "A" Receiver and AE meter reading does NOT rise when sending R/T	V3A	Replace valve
7. "A" sender and receiver not working but sidetone is heard when sending R/T	V2A	Replace valve
8. All working except "A" sender but meter gives a DRIVE reading	V4A	Replace valve
9. All working except "A" sender but DRIVE reading is zero or very small.	V2B, V5A	Replace valves in turn
10. All working except "A" sender on key	(1) Faulty key, key lead or plug (2) Internal fault	Examine. Repair if possible. Otherwise report.
11. "A" receiver very noisy	(1) Loose Aerial Connection (2) Loose valves	Check tighten where loose, including coaxial cable socket. Examine pigtail. Push into sockets.
12. Pilot light on Control box out	(1) Bulb burnt out (2) Fuse burnt out	Replace bulb Replace fuse
13. All working except I-C	V1F V8B	Replace valves in turn
14. "B" and "I-C" not working	V1F, V1E, V8B, V8A	Replace valves in turn
B-SET		
15. All working except "B" set sender and receiver	V7A, V1D, V1E, V8A	Replace valves in turn
16. All working except "B" receiver	V1D	Replace valve
17. "B" Set very Noisy	(1) Loose valves (2) Loose aerial connections	Push valves into bases. Check and tighten where loose. Examine coaxial cable socket.

WARNING—"B" Aerial feeder is very fragile.

When replacing valves work on the lines of these two examples:—

(1) Failure No. 3 (due to V1B burning out).

Put in a new V1A; test set—no result.

Put in a new V1B; test set—set works, therefore V1B was faulty.

Put old V1A back; test set—set still works, therefore old V1A is sound.

(2) Failure No. 4 (due to V2B and V5A both burning out).

Put in a new V2B; test set—no result.

Put in new V4A; test set—no result.

Put in new V5A; test set—set works, therefore V5A was faulty.

Put old V2B back; test set—set does not work therefore old V2B was faulty so put the new V2B in again.

Put old V4A back; test set—set works, therefore the old V4A is sound.

DO NOT put faulty valves back in the spare-valve case; exchange them for good ones as soon as possible and put them into the case.

The position and designation of all the valves in the set are given in the TOP PLAN of THE CHASSIS. A similar plan is painted on the lid of the B-Set. All the valves in the spare-valve case are coded so that they may be readily distinguishable and a plan of their distribution within the spare-valve case is attached to the lid.

APPENDIX I

TECHNICAL DESCRIPTION

I.1 THE A-SET

I.1.1 CIRCUIT ARRANGEMENTS

The receiver is a superheterodyne which uses an I.F. of 465 Kcs. The function of the valves are described below. From the Block Diagram it can be seen:—

- (1) that several valves are used on both send and receive, and
- (2) that the frequency of the sender is controlled by the Het. Oscillator and the tuning of the Receiver Conversion Oscillator.

TABLE 4

CIRCUIT REFERENCE	DESIGNATION	TYPE	FUNCTION	
			SENDER	RECEIVER
V1A	6K7G	R.F. Pentode	not used	R.F. Amplifier
V2A	6K8G	Triode-Hexode	Oscillator section (triode) connected to control grid of oscillator valve V2B.	Oscillator-mixer
V1B	6K7G	R.F. Pentode	not used	I.F. Amplifier
V1C	6K7G	R.F. Pentode	not used	I.F. Amplifier
V3A	6B8G	Double Diode-Pentode	Pentode is R/T modulator or AF oscillator on MCW.	2nd detector, AVC rectifier, and A.F. amplifier.
V2B	6K8G	Triode-Hexode	Oscillator-mixer	Oscillator section (triode) becomes CW, BFO, variable about 465 Kcs.
V5A	EF50	R.F. Pentode	RF Driver and buffer.	not used
V6A	6H6	Double Diode	Automatic drive control rectifier, and drive rectifier for meter.	not used
V4A	807	Beam Power Tetrode	R.F. Power amplifier.	not used

I.1.2 FLICK MECHANISM

The preselector arrangement consists mainly of 2 circular plates driven from the main condenser spindle. A V cut on the periphery of each plate allows a spring-loaded flick-locating arm to engage in the V slot. The two plates are free to move on the main spindle until locked into the required position by two clamping screws. Each plate can be individually adjusted to the required preselected frequency. The two spring-loaded arms also operate two flags so that a visual indication is given for each preselected frequency.

I.2 THE A-SET RECEIVER

I.2.1 R.F. AMPLIFIER

The signal from the aerial passes through the tuned aerial circuit and is fed through C2A to the control grid of the variable-mu valve V1A. This valve is biased by R2A and the RF GAIN A (R/C 105A), and the biasing resistors are by-passed by C4B. It receives AVC bias through the choke L10A. The anode circuit, which consists of the primary of the RF Transformer L22A and B or L23A and B, is connected through the secondary to the control grid of the hexode portion of the frequency changer valve V2A. The secondary is tuned by C9A.

I.2.2 FREQUENCY CHANGER

The frequency changer valve V2A is a triode-hexode. The triode section acts as the conversion oscillator, working at a frequency 465 Kcs. above the signal frequency. The oscillator circuit comprises the transformers L24A and B and L25A and B, and is tuned by the gang condenser C9B and L/C 103A (the FLICK ADJ.). The triode section of V2A also acts as part of the sender.

The output of the oscillator section is fed to the mixer section by the internal connection between the triode grid and the injector grid of the hexode section. The anode circuit of the hexode is coupled through the IF transformer L8A, to the control grid of the 1st I.F. Amplifier V1B.

I.2.3 1ST I.F. STAGE

Valve V1B is a variable-mu, pentode used solely for I.F. amplification. The bias is provided by R/C105A and R9A, and AVC bias is received through the secondary of L8A. The anode is coupled through the I.F. transformer L8B to the control grid of the 2nd I.F. amplifier V1C.

I.2.4 2ND I.F. STAGE

Valve V1C is another variable-mu pentode, used solely for I.F. amplification. Bias is provided by R8B, and AVC bias is received through the secondary of L8B. The anode is coupled through the I.F. transformer L9A to the anode of the signal detector diode V3A.

I.2.5 DETECTOR, AVC and OUTPUT STAGE

V3A is a double-diode pentode. One diode acts as the signal detector, the other diode as the AVC detector and the pentode as the A.F. Amplifier.

The anode of the signal detector is directly connected to the "live" side of the secondary of the I.F. transformer L9A. The diode load is provided by R7C and R1B. A filter consisting of R7C, C14A and C15A serves to keep the I.F. Signals out of the A.F. Amplifier. The A.F. is fed through C17A to the A.F. volume control R13A, which is connected by a screened lead through a contact on the send-recv relay to the control grid of the pentode section of V3A.

The A.V.C. diode is fed from the signal detector diode through a small coupling condenser C18A. The rectified current through the diode develops the A.V.C. voltage across the diode load R8A. This voltage is applied as negative bias through R8B and R/C103A to the control grids of V1A, V1B and V1C. R8B, R/C 103A, and C83A act as a filter and their values determine the time constant of the circuit.

Since R8A is connected to earth, a negative bias is applied on the anode of the A.V.C. diode equal to the D.C. voltage developed across R9E and R11A by the cathode current of V3A. No rectification takes place, in the A.V.C. diode, therefore, until the amplitude of the incoming signal is great enough to overcome this bias, thus delaying the A.V.C. The A.V.C. circuit can be shorted out by closing switch S/C 105A.

The output stage is the pentode section of V3A acting as an A.F. amplifier. The input is resistance-coupled through R13A. The anode is coupled by the A.F. transformer T2A to the headphones.

I.2.6 BEAT FREQUENCY OSCILLATOR

The triode portion of valve V2B acts as the B.F.O. For the reception of CW, the BFO is switched on by the MCW-CW-R/T switch S7A/6. The pitch of the heterodyne beat note can be adjusted by R14A which shunts the coupling coil L5B.

The BFO also operates at 465 Kcs. when the switch S/C 105B is closed. The inter-electrode capacity of V2B provides coupling with the I.F. by means of the hexode control grid of V2B, and the triode grid of V2A. In this manner the BFO heterodynes with the IF thus enabling the receiver to be tuned accurately to an inaudibly low beat note (zero beat) with the received signal.

I.3 THE A-SET SENDER

I.3.1 MASTER OSCILLATOR STAGE

The triode section of V2A acts as the master oscillator on send, oscillating at a frequency 465 Kcs. above the carrier frequency. It is coupled through R42C to the hexode control grid of the frequency-changer V2B.

I.3.2 SENDER FREQUENCY CHANGER

The triode section of V2B, the BFO, oscillates at 465 Kcs., and its output is mixed with the output of the master oscillator in the hexode section of V2B, producing a signal of carrier frequency.

The output from the hexode is tuned by the circuit L7A or L21A and C9D. The signal is fed through C2C to the control grid of the valve V5A.

I.3.3 BUFFER STAGE (R.F. AMPLIFIER)

V5A is a steep-slope pentode used to amplify the drive voltage to the power amplifier V4A. The output from V5A is tuned by L4A or L6A and C9C, and is fed through C2F to the control grid of V4A and to the anodes of the double-diode valve V6A.

One of the diodes of V6A provides a drive control voltage which is fed back through R1D and R1E to the control grid of V5A. This control voltage is delayed to an extent determined by the setting of R43A, the effect being to maintain the drive voltage applied to the control grid of V4A constant at a pre-determined value.

The other diode of V6A provides a drive voltage reading on the meter. The diode load is provided by R15B and R42B, and it is by-passed by C15M. The meter measures the voltage across R42B.

I.3.4 POWER AMPLIFIER STAGE

V4A is a beam power tetrode valve which acts as the power amplifier. On R/T and MCW modulation is applied to its control grid by the pentode section of V3A; keying on CW is described in I.3.5.

On CW, V4A is self-biased by grid current through R7D.

On R/T and MCW, bias is provided by the HT2. The cathode is grounded and the HT2 negative is connected to ground through R/C 104A, which is by-passed by C/107A. The control grid is connected to the HT2 by R7D, so that bias is provided by the anode current through R/C 104A. This type of biasing provides self-control which is not dependent on the presence of a drive control voltage.

Because the HT2 is not switched by Send/Receive switching on Dynamotor operation, it is necessary to make V4A inoperative on "receive". This is done by connecting the cathode to a bleeder circuit on the HT1, and thus increasing the bias, and at the same time removing HT1 from the screen grid. The bleeder circuit consists of R18B and R19A, and it is by-passed by C15C.

The output of V4A is tuned by L3A and C3A and fed from a low impedance tap on L3A, through the aerial feeder, to the variometer, which tunes the aerial. The R.F. current from the variometer to the aerial is passed through the primary of transformer T1A, and the current in the secondary is taken through the rectifier W1A. The D.C. produced by the rectifier is passed through the RF Choke L2A, R29A, L2.1A, the aerial feeder and RF Choke L2B to the panel meter.

I.3.5 MODULATION

On R/T the pentode section of V3A acts as the modulation amplifier. The input comes from the microphone through the transformer T3A. The output is applied through C17B and R7G to the control grid of V4A. Sidetone is taken through the transformer T2A to the headphones.

On MCW, V3A is made to oscillate by coupling its control grid to the reaction winding on T2A. The anode and screen grid of V3A are keyed through the key-jack J1A.

On CW keying is done, through the key-jack, on the HT supplies of:

- the screen grid of V4A.
- the anode and screen grid of V5A.
- the anode and screen grid of the hexode section of V2B.

I.4 THE B-SET

I.4.1 CIRCUIT ARRANGEMENTS

The B-set is a VHF transceiver with a frequency range of about 229-241 Mcs. When switched to receive, it acts as a super-regenerative receiver, using a "quench" or interruption frequency of between 158 Kcs. and 228 Kcs.; when switched to send, it acts as an anode-modulated oscillator.

TABLE 5

CIRCUIT REFERENCE	DESIGNATION	TYPE	FUNCTION	
			SENDER	RECEIVER
V7A	E1148	Low Capacity Triode	VHF Oscillator	Super-regenerative detector
V1D	6K7G	R.F. Pentode	not used	Quench oscillator at frequency between 158 and 228 Kcs.
V1E	6K7G	Pentode	Modulation pre-amplifier	A.F. Amplifier
V8A	6V6G	Output Pentode	Modulator	A.F. Output

I.5 B-SET RECEIVER

I.5.1 DETECTOR STAGE

V7A is a VHF triode which acts as an oscillating detector and which is tuned to the frequency of the incoming carrier by L11A and C25A. The oscillation of V7A is periodically interrupted by the application of the output from the quench oscillator V1D. V1D is tuned by L14A, C28A and C37A to oscillate at the quench frequency. This arrangement keeps V7A in the most sensitive condition, and the circuit is equivalent to a leaky grid detector with very critically adjusted reaction.

The output from the detector is fed through C29A to the volume control R35A, which is connected to the control grid of the 1st AF Amplifier V1E. A filter circuit, comprising C30A, R6H and C30B, is provided to prevent the quench frequency getting into the A.F. stages.

I.5.2 1ST A.F. AMPLIFIER

V1E is a pentode, used solely for AF amplification. Its output is fed through C29B and is resistance coupled by R8D to the control grid of the output valve V8A.

I.5.3 2ND A.F. AMPLIFIER (Output Stage)

V8A is an output pentode used for AF amplification. Its output is coupled by the transformer T5A to the headphones.

I.6 B-SET SENDER

I.6.1—MODULATION AMPLIFIER

The output from the microphone goes through transformer T4A to the control grid of V1E, which acts as the modulation amplifier. The output from the valve feeds through C29B to the control grid of the modulator valve V8A.

I.6.2 MODULATOR

The output pentode power valve V8A acts as the modulator. The output from the valve is taken through the output transformer T5A to the anode of the oscillator V7A.

Negative feed-back is taken from the phone winding of T5A to the primary of transformer T4A.

Sidetone is taken from T5A to the headphones.

I.6.3 OSCILLATOR

The VHF triode V7A acts as an anode-modulated oscillator producing the carrier. It receives its HT supply through T5A.

I.7 SEND-RECEIVE SWITCHING

Changing over from receive to send is performed by the pressel switch on Microphone and Receiver Headgear No. 1. This actuates a relay on the set, relay S5A for the A-set and relay S5B for the B-set.

When the pressel-switch is closed, one side of the energizing coil L19A (or L19B) is earthed while the other side has a standing voltage of 12V. The relay pulls over, and HT is connected to the sender valves (by S5A2 and 3), and the microphone is put in circuit (by S5A4) with the microphone amplifier V3A.

When using MCW or CW send-receive switching is automatically performed by pushing the key-plug into the key-jack for send, and half withdrawing it for receive.

L8 INTERCOMMUNICATION AMPLIFIER

The intercommunication amplifier is a two-stage AF amplifier which uses negative feed-back.

TABLE 6

CIRCUIT REFERENCE	DESIGNATION	TYPE	FUNCTION
V1F	6K7G	Pentode	First AF Amplifier
V8B	6V8G	Output Pentode	Output AF Amplifier

The output from the microphone is fed to V1F through the transformer T4B, and the output from V1F is resistance coupled to the control grid of the output valve V8B, through C29C and R8F. The output of V8B is transformer-coupled through T6A to the I-C telephone line. Negative feed-back is taken from the secondary of T6A and applied to the primary of T4B.

L9 AERIALS

L9.1 A-SET ROD AERIALS

The A-set is designed primarily for use with single or double 8-, 12-, or 16-foot rod aerials. It may be used, for short communication only, with a single or double 4 foot aerial. The new type aerial sections with the locking threads may be used with the original type of aerial sections. Truck ground stations will also be provided with 34-foot aerials.

L9.2 A-SET HORIZONTAL AERIALS

It should first be understood that the aerial matching variometer loads the rod aerial to a quarter wave-length, and the impedance of the concentric line to the variometer is approximately 40 ohms. An aerial, such as the Wyndom with its medium impedance feed, is unsuitable, but a three-quarter wave aerial can be used. For example, at a frequency of 3 Mcs a half-wave aerial would be 156 feet, the practical length being 95% of the theoretical length. The variometer will load a 12 foot rod to a quarter wave at 3 Mcs, and if we increase the half-wave aerial to 168 feet and connect it to the variometer, it will be possible to load this aerial to a three-quarter wave, for which the input impedance is approximately the same as for a quarter wave.

A number of experiments have been carried out working on this basis, and ranges up to 180 miles have been worked on speech with R5 signals at each end. The tests have not been sufficiently extended to make it possible to formulate any rules as to what the range is, using this type of aerial. It must NOT be assumed that:—

- (1) 180 miles is the maximum range, or
- (2) this range will always be attained, but it is evident that ranges of this order are possible under reasonable conditions.

In order to simplify the erection of aerials, the following standard lengths of wire have been calculated and checked by experiment as suitable to cover the approximate frequency bands shown, for horizontal aerials.

TABLE 7

TOTAL LENGTH OF WIRE IN FEET	FREQUENCY BAND COVERED IN Mcs.
250	2 — 2.65
185	2.6 — 3.5
150	3.45 — 4.5
110	4.45 — 5.6
90	5.55 — 6.65
70	6.6 — 8.0

The wire should preferably be erected as high as possible, e.g., an inverted L with the horizontal portion 30 feet from the ground would be extremely good; good results, however, may be obtained with the horizontal portion of the aerial no more than 18 feet from the ground. A quick and easy method of erecting an aerial, which will give results good enough for many purposes, is to attach one end of the wire to a tree, mast or other support, and the other end to the vehicle in which the set is carried, the vehicle being so placed that the wire is stretched taut between them. Truck ground stations are provided with a 20-foot mast to be used with the 34-foot aerial mast for erecting horizontal aeriels.

The aerial current in a horizontal aerial, as indicated by the panel meter, will be of the same order as the current in the 12-foot rod. In certain circumstances it may be less, but it should not be assumed that for this reason the radiation will be less.

The use of an elaborate earth e.g. a radial earth, with the spokes not less than half the wave-length being used, will improve radiation markedly. Even a simple earth-pin near the vehicle will effect some improvement in radiation, and will avoid the noticeable drop in aerial current which would occur through people near the truck touching the parts of its chassis to which the set is earthed. An earth will also, in many cases, improve the signal-to-noise ratio on receive.

I.9.3 A-SET AERIAL CIRCUIT

A common tuned circuit (A.PA TUNING) is used to tune the grid of V1A on receive and the anode of V4A on send. The aerial is tuned to resonance by the variometer L1A, forming a series resonant circuit, which is connected to a low impedance tapping on the tank coil LSA via a low capacity feeder. The entire aerial circuit within the vehicle is fully screened to reduce interference from other electrical equipment in the vehicle.

I.9.4 B-SET AERIAL

This is a half-wave rod aerial fed by a feeder which is a multiple of a half-wave-length. Only two standard feeders are available. These are cut to correct lengths and therefore must on no account be shortened.

The lengths are:—

Aerial leads No. 2 4 ft. 2 in. $1\frac{1}{2}$ wavelengths

Aerial leads No. 3 7 ft. $2\frac{1}{2}$ wavelengths

NOTE: These physical lengths are not equivalent to the electrical wavelengths, but are calculated taking into account the impedance of the feeder and of the coil circuit.

I.10 THE SUPPLY UNIT

Supply Unit No. 2 comprises two filtered power supplies. One consists of a non-synchronous vibrator and cold cathode valve rectifier. The other is a 4-commutator dynamotor.

Two commutators of the dynamotor connect to two identical low tension windings which are used in parallel on a 12 volt input and in series on a 24 volt input. The switching is done by a switch S/C 102A. A third commutator connects to the HT1(265V) winding. One side of the HT1 output is grounded and the other side is filtered by C/C 101E and C32A and passed through the HT1 ($\frac{1}{4}$ amp.) fuse 1-B to the set. The fourth commutator connects to the HT2 (540V) winding. The HT2 output is not grounded but is filtered by L18A, C/C106A, and C4CP, and passed through the HT2 ($\frac{1}{4}$ amp.) fuse 1-A to the set as a "floating" power supply.

The vibrator and rectifier unit operates from a 12 volt supply and produces 265V (HT1) at a very high efficiency and consequently low current drain. Since it provides only one HT output it cannot operate the A-sender. Its power output is sufficient to operate simultaneously any two of the A-set, B-set, and I-C Amplifier but not all three. Two components, the vibrator and the 0Z4A valve plug into sockets and may be replaced quickly. One spare valve and one spare vibrator are mounted in the Supply Unit.

The 12V input is ungrounded, the positive being connected to the primary centre tap of T/C 101A, and the negative being connected to the vibrator armature. This circuit contains a VIBR (10 amp.) fuse, and it is filtered by C/C 101A, C/C 101B, C/C 102A, C/C 103A and L/C 102A. The transformer output is rectified by V/C 101A (0Z4A) and is passed to the set through the filtering circuit R/C 102A, C/C 104A, C/C 101D, C/C 105A, C/C 105B, R/C 101A and L/C 101A.

Since the vibrator only provides HT1, it is necessary to use the dynamotor on A-set "send". The switching is done by the relay S/C 103A which is operated by the pressel-switch on the A-set microphone.

The heaters and relay are supplied from the 12V supply in parallel with the vibrator or dynamotor.

Since one side of the heater supply is grounded and the vibrator input is floating, the Supply Unit may be used economically on a 24V 3-wire system. The heaters are connected across the lower 12V section and the vibrator across the upper 12V section, and there is an unbalance of not more than one amp. The dynamotor is connected across the entire 24 volts; and when the set is switched to "send" the heaters are supplied from a 12V tap between the two primary windings.

The Supply Unit may also be used on a 24V 2-wire system but the vibrator can not be used. The dynamotor is connected across the entire 24 volts and the heaters are tapped off between the two primary windings.

L.11 AUDIO EQUIPMENT

L.11.1 MICROPHONE AND RECEIVER HEADGEAR NO. 1

This is a moving coil microphone. To exclude noise, it is necessary to speak right into the mouthpiece of the microphone. The pressel-switch contacts are used for switching to send and for bringing the microphone into circuit.

The headphones are also the moving coil type and are fitted with rubber caps to exclude external noise. Moving coil units are used to give a good response over a wide frequency band, as this gives greatly increased intelligibility under noisy conditions.

L.11.2—MICROPHONE AND RECEIVER HEADGEAR NO. 2

The microphone on the headgear is of the carbon granule power type and is intended for use without any amplification.

APPENDIX II

II.1 ADAPTING A W/S 19 MK. I OR II TO USE SUPPLY UNIT NO. 2.

When a Supply Unit No. 2 is to be installed for use with a Wireless Set No. 19 Mk. I or II, (Canadian, U.S. or British) the wiring change outlined in the following section must be made to the Wireless set.

II.2 WIRING CHANGE (WIRELESS SET NO. 19 MK. I AND II ONLY).

(a) Disconnect both the 6-pt and 12-pt connectors, the aerial leads and the key-plug from the wireless set. Loosen, but do not remove, the four screws at the corners of the front panel. Detach the ground pigtail from the set and withdraw the wireless set from its case.

(b) Remove the four screws, lock-washers and nuts which fasten the 6-pt plug mounting to the upper left hand corner of the front panel. Pull the plug mounting forward without straining the leads. (This is a good time to put those screws and nuts in a safer place.)

(c) The lead which is attached to pin No. 1 is a metal braid. Unsolder the braid from the pin.

(d) Obtain, if possible, a one inch length of cambric sleeve similar to that on the other leads. Obtain a piece of insulated flexible wire, approximately 8 inches long. The No. 18 B & S ga. tinned flex. wire which is stocked in Ordnance Stores for Wireless Sets No. 19 is suitable. Solder one end of this wire to the pin (No. 1) to which the braid was originally connected. Slide the cambric sleeve along the wire into place over the joint. Thread the wire through the hole in the panel. Replace the mounting using all four screws and nuts.

(e) Turn the set over. Remove and put in a safe place all the screws and washers that hold the base plate to the set.

(f) The braid which was unsoldered passes through a hole in the chassis near the front panel. Thread the additional wire through this hole. Cut the metal braid (not the wire) near the chassis. Remove the braid from the set, being careful not to strain the connections at the 6-pt plug, if the braid is tied to these leads.

(g) The free end of the lead which was soldered to the 6-pt plug must now be connected to one of the switch contacts on the key jack. It DOES MATTER which contact is used. The correct contact on the jack is connected to pin No. 7 on the 12-pt plug on the front panel. Find this contact by connecting an ohmmeter to pin No. 7 on the 12-pt plug and to each of the contacts in turn of the KEY jack.

(h) Solder the end of the new lead to the KEY jack contact. Do not remove the lead which is already soldered to the jack contact. Be careful to solder neatly and not to drop solder onto other contacts in the set. If the contact is difficult to reach, the whole KEY jack may be unfastened from the front panel so that it can be held in a position which is more convenient for soldering.

(i) Replace the KEY jack and any spacers that may have been used between it and the panel. Replace the base plate and slide the wireless set into its case. Tighten the four mounting screws. Replace the pigtail, the 12-pt connector and the aerial leads.

(j) A 12-pt to 6-pt connector must now be used to connect the Supply Unit to the Set. This connector is contained in the Maintenance Spares.

WARNING

The set has now been altered for use with a Supply Unit No. 2 or a Supply Unit No. 1 Mk. III. It must not be used with a Supply Unit No. 1 until the wiring has been altered to the original connections.

APPENDIX III

CONTROL UNITS AND JUNCTION DISTRIBUTION BOXES

III.1 GENERAL

Of necessity, W/S No. 19 Installations require a number of different types of Control Units and Junction Distribution Boxes to satisfy the varied demands of different vehicles. Most of these Control Units have more than one drop cord for headsets and not all of these cords are connected to the complete facilities of the set. The new operator is often non-plussed to find that his set seems to be in perfect condition and yet he cannot operate it from his pressel-switch. Usually the answer is simple, because he has plugged his headset into the I-C snatch plug on his Control Unit and therefore is not connected to the A-set or B-set facilities. This appendix is intended to bring to the operator's attention the various types of units and boxes he is likely to meet and the facilities of each. The Control Units are easily distinguishable by their name plates.

It is well to note here that when the "Re-broadcast" facilities are being employed, the operator's microphone is cut out of the circuit and he can only listen. However, the commander has full control of the set from his headset and he can add his speech to the re-broadcast.

The pilot light, indicating that the A-set is unattended, will come on when both Control Units are on the B-set. If both Units are on the I-C Amplifier the lamp will not light because the A-set is not considered unattended. Sidetone from both the A-set and B-set is fed into the I-C Amplifier and the operator can tell that someone is calling him on one of the sets. Similarly when one Unit is on B and the other I-C the light will not light because sidetone from the A-set is fed into the I-C Amplifier. In addition, the pilot light will light whenever the N-R switch is turned to R.

III.2 CONTROL UNIT NO. 1

This unit has:

- 1—Radio Operator's Cord (left cord)
- 1—I-C Cord (right cord)
- 1—12-pt connector socket
- 1—Switch A I-C B

Control Unit No. 1 is normally connected to Control Unit No. 2 which is in turn connected to the set. Together Control Units 1 and 2 give full switching facilities.

III.3 CONTROL UNIT NO. 1 MK II

This unit provides in addition to the facilities of No. 1, a 4-way terminal strip to enable I-C Amplifier circuits to be connected. It supersedes No. 1.

III.4 CONTROL UNIT NO. 1A

This is a No. 1 unit modified so that the former I-C drop cord is now connected in parallel with the operator's cord to the "A, I-C, B" switch.

III.5 CONTROL UNIT NO. 1A MK II

This is a No. 1 Mk II unit modified so that the former I-C drop cord is now connected in parallel with the operator's cord to the "A, I-C, B" switch. It supersedes No. 1A.

III.6 CONTROL UNIT NO. 2

This unit has:

- 1-Radio operator's Cord
- 1-W/S A unattended Pilot Light
- 2-12-pt connector sockets (input and output)
- 1-Switch A I-C B.

It is usually used with a No. 1 or 1A unit.

III.7 CONTROL UNIT NO. 2 MK II

This provides the rebroadcast facility in addition to the facilities of No. 2; and consequently supersedes No. 2.

III.8 CONTROL UNIT NO. 3

This is a double-size unit which has

- 2-Radio Operator's Cords (switched independently)
- 1-W/S A unattended Pilot Light
- 2-Switches A I-C B
- 1-12-pt connector socket

This unit, which combines the circuits of No. 1 and 2 without the I-C cord, was designed for a two-man turret and gives full switching facilities.

III.9 CONTROL UNIT NO. 3 MK II

This unit provides the re-broadcast facility in addition to those provided by No. 3 and it supersedes No. 3.

III.10 CONTROL UNIT NO. 3A

This is a No. 3 unit modified to include an I-C drop cord (the centre one) and is designed for three-man turrets.

III.11 CONTROL UNIT NO. 3A MK II

This unit provides the re-broadcast facility in addition to those provided by No. 3A and it supersedes No. 3A.

III.12 CONTROL UNIT NO. 3B

This is a No. 3 unit modified to include a third Radio Operator's Cord connected to an A I-C B switch in parallel with one of the other two Cords. It was designed primarily for use with ground stations and training sets.

III.13 CONTROL UNIT NO. 3B MK II

This unit provides the re-broadcast facility in addition to those provided by No. 3B, and it supersedes No. 3B.

III.14—CONTROL UNIT NO. 3C

This is a double-size unit which has:—

- 1—Radio Operator's Cord
- 1—I-C Cord
- 1—W/S A unattended Pilot Light
- 1—12-pt connector socket
- 2—Switches A I-C B
- 2—Terminal Strips with capacity for 4 terminals each.

An extended commander's Cord is connected to one of the terminal strips and the commander's Cord is switched by the operator. The commander uses the buzzer, which is applied to the operator's phones, to signal the operator. The second Terminal Strip permits additional connections to the I-C circuits.

III.15 CONTROL UNIT NO. 3C MK II

This unit provides the re-broadcast facility in addition to those provided by No. 3C and it supersedes No. 3C.

III.16 CONTROL UNIT NO. 4

This is a single unit designed for ACV's, which has:—

- 1—Radio Operator's Cord
- 2—12-pt connector socket
- 1—Switch A1 (19), I-C, B, A2 (14)

III.17 CONTROL UNIT NO. 5

This is a single unit designed for ACV's which has:—

- 1—Radio Operator's Cord
- 1—I-C Cord
- 1—12-pt connector socket
- 1—Switch A1 (19), I-C, B, A2 (14)

III.18 CONTROL UNIT NO. 6

This is a single unit, designed for ACV's, which has:—

- 1—Radio Operator's Cord
- 1—Attenuator
- 1—12-pt connector socket
- 1—Switch Rec., A2, R/B
- 1—Switch "Mod"
- 1—Terminal Strip with 4 Terminals for Ring Terminals
- 1—Terminal Strip with 3 Terminals for Ring Terminals

This unit has provision for receiving or rebroadcasting on a No. 19 set or alternatively a No. 14 set, and also has a variable modulation control.

III.19 CONTROL UNIT NO. 7

This is a double-size unit designed for ACV's, which has:—

- 2—Radio Operator's Cords
- 2—Switches A1 (19), I-C, B, A2 (14)
- 1—12-pt connector socket

III.20 CONTROL UNIT NO. 8

This is a single unit, designed for a special installation, which has:—

- 1—Radio Operator's Cord
- 1—Special 15 foot Cord
- 1—Switch A, I-C, B
- 1—12-pt connector socket

The long cord has its headphone circuit connected to the switch in parallel with the Operator's Cord, while its microphone circuit is connected only to the I-C Amplifier.

III.21 JUNCTIONS DISTRIBUTION NO. 1

This is a single size unit which has:—

- 1—I-C Cord
- 1—Buzzer and Call-Button
- 1—Terminal Strip with provision for 3 leads.

The I-C Cord is a special lead for a power microphone heargear (Microphone and Receiver Headgear No. 2).

This unit is normally a driver's box which has access to the I-C amplifier only, and which is connected to the nearest 12V supply and to the set by two screened leads (speech, signal) via the slip rings.

The buzzer circuit permits calling the commander's attention when he is connected to one of the sets.

The output from the power microphone transformer is fed directly to the I-C headphone circuit. Thus a two-way conversation can be carried on with the turret crew, using one wire through the slip rings and an earth return. The driver will be heard by the turret crew who cannot reply unless the I-C Amplifier is switched on. For this reason the I-C headphones lead which passes through the power unit and 6-pt connector is labelled speech since it serves both the microphone and the headphones.

III.22 JUNCTIONS DISTRIBUTION NO. 2

This unit is similar to No. 1 but does not have the buzzer or call-button. It is connected in parallel with No. 1 and is intended for the co-driver.

Note: Junctions Distribution No. 1 and 2 are designed for Microphone and Receiver Headgear No. 2.

III.23 JUNCTION DISTRIBUTION NO. 3

This is a single size unit which has:—

- 2—I-C Cords
- 1—Buzzer and Call-Button
- 2—Terminal Strips for 3-pt input connections.

This Unit must be connected to the nearest 12V supply. It is used to connect extra crew to the I-C circuit via Control Unit No. 1 Mk II or No. 1A Mk II, or by a three- or four-way screened connector. In some cases, where the number of slip rings permits, Junctions Distribution No. 3 is used for a driver and/or co-driver. It is designed to use Microphone and Receiver Headgear No. 1, and the moving-coil microphones give improved performance over the power microphones in Headgear No. 2 as used with Junctions Distribution No. 1 and 2.

III.24 JUNCTION DISTRIBUTION NO. 4

This is a Junctions Distribution No. 3 modified to accommodate up to four drop cords and to eliminate the buzzer circuit. It is not in general use.

APPENDIX IV

ELECTRICIAN'S MAINTENANCE

IV.1 GENERAL

Regular and careful maintenance is essential for keeping the set in good working order. The maintenance described in this Chapter should be carried out by an electrician at least once a fortnight, or more often if possible; experience has shown that a month is too long a period. Whenever the electrician maintains the set he should fill in the maintenance chart, which is kept by the Signal Officer for each set under his control.

IV.2 AERIALS

1. **Rods** ("A", "B" and spare).—Straighten. Clean ends and apply a little vaseline to them.
2. **"A" Base**.—Check and clean spring contact and insulator.
3. **"B" Base**.—Clean thread. Inspect insulator for dirt and cracks.
4. **Pigtails**.—Open "A" and "B" bases and inspect pigtails. Replace if frayed. Check connections. **THIS MUST BE DONE VERY CAREFULLY.**

IV.3 VARIOMETER

1. **Friction**.—Check that control knob turns easily but is not so loose as to turn with vibration.
2. **Earth**.—Check contact of spring with aerial feeder plate.
3. **Grubscrew**.—Check that aerial feeder ferrule is tightly held.
4. **Cleaning**.—If internal dampness is suspected, open variometer and dry out. Clean, and see that scale is easily readable.

IV.4 AERIAL LEADS

1. **Feeder** (i.e., lead between variometer and "A" aerial). Check for fraying, especially where feeder passes through turret and under cleats. Clean plugs and sockets at ends and check for burning. Note:—In some installations the aerial is mounted on the variometer and there is no feeder.
2. **"A" set lead** (i.e., lead from set to variometer).—As for feeder (see para. 1 above).
3. **"B" set lead**.—As for feeder (see para. 1 above). Lead must not be shortened.

IV.5 SUPPLY UNIT

1. **Fuses**.—Unscrew and check that fuse wires are of correct gauge. Clean ends and screw in firmly.
2. **Commutators**.—Inspect thoroughly. Wipe with clean, soft rag, moistened with petrol if necessary. Replace brushes if too worn or badly bedded. Do NOT oil bearings except in emergency, since special lubricant is needed.
3. **Variometer screws**.—Where variometer is mounted on supply unit, check tightness of fixing screws.
4. **Cleaning**.—Clean inside thoroughly and dry out if necessary. Inspect sockets.

IV.6 SET

1. **Lubrication**.—Clean dial drives, rims of dials and "flick" discs (behind panel), using a rag moistened with petrol and wrapped round a sharpened stick similar to a toothpick. Apply oil to all these or, if none is available, thick oil. Apply thin oil to all moving parts of flick mechanism. Check tightness of screws securing flick arms and dial stops. If latter are loose, fix them so that condensers are just prevented from fully opening and closing.

2. **Controls.**—Check mechanical action of all controls. Work from left to right. Most important points are:—

i. *Tuning B.*—Should have no side-play. Check tightness of grub screw on hub. Check stops.

ii. *Quench.*—Should make 12 revolutions, stiff but smooth.

iii. *Switches.*—Check for clean action.

iv. *Hot tone.*—Should turn through 360°, stiffly but smoothly.

3. **Valves.**—Remove lids of screening cans and see that they make good contact with cans. Check that screening cans are pushed home into bases. Check that valves are firmly held in sockets; if loose, lightly squeeze contacts of sockets. Inspect grid leads where they pass through screening cans; if worn, replace if possible or insulate with tape.
4. **Cleaning.**—Clean interior of set, and inspect for loose or dirty connections; dry out if necessary. Inspect carefully: aerial terminals, 12-point connectors, and lid of "B" set screening box.

IV.7 HARNESS

1. **Control Units.**—Check action of switches and buzzer. Clean interior of boxes. Inspect 12-point sockets. Inspect drop cords for fraying and snatch sockets for cracks.
2. **Connectors.**—Examine for external fraying. Inspect pins in all connector plugs. Check that heads cannot rotate.
3. **Headsets.**—Inspect leads for fraying and snatch plugs for cracks. Clean out microphone, checking terminals and capsule contacts. Check action of pressel switch, adjusting contacts if necessary. Inspect connection and anchoring of leads to headphones.
4. **Key.**—Clean. Check leads for fraying.

IV.8 OPERATION

1. **Meter.**—Switch supply unit on and check freedom of movement of meter on L.T. Switch off and set zero of meter.
2. **Set test.**—Carry out "Tests for Daily Maintenance" checking operation of each control.

IV.9 VALVE TESTS

1. **Purpose.**—By noting at regular intervals the performance of certain valve stages, the electrician can detect when any one of these stages begins to become inefficient, and can thereby keep the general performance of the set at a high level.
2. **Conditions for tests.**—i. The value of the test figures depends on their being taken under the same conditions on each occasion.

These conditions are:—

- (a) "A" set switched to R/T.
- (b) Four-footed rod or dummy aerial on "A" set (the same on each occasion).
- (c) "A" set tuned to about 3500 kc/s, except where otherwise stated. The set must NOT be tuned to an incoming signal.
- (d) Batteries at least three-quarters charged and battery leads of such a resistance as to give a reading of 11 volts on the set meter. Electricians should use their own batteries, whose state of charge they know, and should have a stock of leads of various resistances.

ii. **Voltmeter.**—The same voltmeter must be used on every occasion. A Universal Avometer is preferable, but a Voltmeter Pocket, No. 2 or No. 3 is also suitable. If no high resistance voltmeter is available, the meter in the set may be disconnected

and used. A length of wire with a prod on it should be connected to one terminal and two lengths, in parallel, each with prods, to the other. These latter two lengths should have high quality series resistors in them of 6,000 ohms and 200,000 ohms respectively.

iii. Test figures.—The tables below show readings which may be expected within $\pm 20\%$. Those measured with the set meter are only a very rough indication.

Note: Great care should be taken not to disturb the relative position of any wiring or components, as this will affect performance and calibration of set.

3. Tests with "A" set receiving.

TABLE 8—VALVE TEST FIGURES WITH "A" SET RECEIVING

CIRCUIT TESTED (a)	POSITIVE OF METER TO (b)	NEGATIVE OF METER TO (c)	VOLTAGE (d)	SET METER SERIES READING ON 600 SCALE (f)	
				RESISTOR (e)	600 SCALE (f)
				Ohms	
V1A	Pin 8	Chassis	3	6000	450
V2A (Hexode)	Pin 8	Chassis	2½	6000	400
V2A (Triode)	Pin 6	Chassis	80	200,000	425
V1B	—	—		Normal A.V.C. Reading	
V1C	Pin 8	Chassis	2½	6000	400
V3A	Pin 8	Chassis	30	200,000	150

4. Tests with "A" set sending.

TABLE 9—VALVE TEST FIGURES WITH "A" SET SENDING

CIRCUIT TESTED (a)	POSITIVE OF METER TO (b)	NEGATIVE OF METER TO (c)	VOLTAGE (d)	SET METER SERIES READING ON 600 SCALE (f)	
				RESISTOR (e)	600 SCALE (f)
				Ohms	
V2B (Hexode)	Pin 8	Chassis	2½	6000	400
Drive	Check reading over whole frequency range. If difference is more than 1.5 V (3 small divisions), check V2B, V2A and V5A.				
V2B (Triode)	Pin 6	Chassis	95	200,000	475
V5A	Pin 6	Chassis	1½	200,000	320
V6A	Record drive readings at 2500 and 4000 kc/s.				
V4A	Record AE readings at 2500, 4000, 5000 and 7500 kc/s.				

5. Test with "B" set receiving.

TABLE 10—VALVE TEST FIGURES WITH "B" SET RECEIVING

CIRCUIT TESTED (a)	POSITIVE OF METER TO (b)	NEGATIVE OF METER TO (c)	VOLTAGE (d)	SET METER SERIES READING ON 600 SCALE (f)	
				RESISTOR (e)	600 SCALE (f)
				Ohms	
V1D	Pin 3	Chassis	70	200,000	355
V1E	Pin 8	Chassis	1½	6,000	300
V5A	Pin 8	Chassis	22	200,000	110

6. Tests with "B" set sending.—V7A.—Positive of meter to H.T. 1, negative to anode. Reading should be about 60V, or 300 on set meter with 200,000 ohms series resistance.

7. Tests on "I-C."

TABLE 11—VALVE TEST FIGURES ON "I-C"

CIRCUIT TESTED (a)	POSITIVE OF METER TO (b)	NEGATIVE OF METER TO (c)	VOLTAGE (d)	SET METER SERIES READING ON 600 SCALE (f)	
				RESISTOR (e)	600 SCALE (f)
				Ohms	
V1F	Pin 8	Chassis	1½	200,000	280
V8B	Pin 8	Chassis	18	200,000	18

8. Loss of emission.—Loss of emission is indicated by a fall in the test reading in the case of all valves except V1D and the triode portion of V2A and V2B. Loss of emission in V2A and V2B is indicated by a variation of the drive reading at various frequencies.

IV.10 "A" SET SEND-RECEIVE ALIGNMENT

Set a wavemeter to 7500 kc/s and tune the receiver to it, using the A.V.C. meter. Press the pressel switch and set the wavemeter to the frequency at which the set is sending. If the reading is more than 1.5 kc/s away from 7500 kc/s, the set needs to be realigned, and should be handed into Ordnance workshops.

IV.11 "A" SET CALIBRATION

Set a wavemeter to 2100 kc/s and tune the receiver to it. Record the setting of the "A" FREQUENCY Mc/s dial. Repeat this at 2500, 3000, 3500, 4000, 5000, 6000, 7000 and 7900 kc/s. In the last case, if using a Wavemeter, Class C, set it to 3950 kc/s and tune the set to the 22nd harmonic (i.e., 7900 kc/s).

IV.12 VEHICLE SUPPRESSION AND SCREENING

Finally, operate the set in the vehicle, with the engine running and all electrical gear (e.g., fans, power-operated turrets, etc.) switched on. If bad crackling is heard, the suppression and screening system of the engine and charging equipment are probably faulty.

IV.13 THE MAINTENANCE CHART

A specimen maintenance chart is shown in Table 17. The electrician, after carrying out each item of his maintenance, puts a tick (✓) in the corresponding square on the chart. If he carries out any minor repairs himself, he puts an "R" in the square and writes the details in the "remarks" column. If he finds that a major repair, which he cannot carry out, is needed, he puts an "X" in the square and hands the set in. He also notes in the remarks column the details of any work done since the set was last maintained; the chart thus gives a complete history of the set.

IV.14 RESISTANCE ANALYSIS

The resistance analysis test has been devised to locate the majority of the circuit faults which may be repaired by the Technical Maintenance Section, with the major exception of open condensers. Since the majority of the readings are made to the chassis, the resistance analysis can be completed much more quickly than a point-to-point check. (In fact an experienced mechanic can be trained to complete this test in less than fifteen minutes.)

For this test all the valves must be removed and all the controls turned fully on. The gang condenser and P.A. Tuning must be fully meshed and the meter switch set to AE. The chassis is upright except for the last 8 readings.

The Resistance Analysis Table requires the following explanations:

- (1) Pin numbers referred to on the plugs are those shown on the schematic diagram.
- (2) Contacts on valve sockets are numbered consecutively in a counter-clockwise direction from the key slot.
- (3) All readings are made to the Chassis unless otherwise stated.
- (4) Some readings have suffixes added to them which have the following meanings:

G—Gain Control fully on

K—Plug in and Key pressed

-2—Check with Band Change Switch in both bands

N—with Netting switch closed

RFG—RF GAIN Control fully retarded

AVC—AVC switch in OFF position

- (5) "Also reads to"—continuity from pin on PL2B to pin on PL2A.
- (6) "Switch Controls . . ."—opening switch will give a different reading which has not been recorded.

The following device to energize the Send/Receive relay will be found useful. Connect pins 7 and 8 on PL2A to the positive of a 12V battery through a switch, and connect the negative of the battery to pin 10 on PL2A. Closing the switch will then put both the A- and B-Sets on "send".

The resistor board referred to is found on the under-side of the chassis to the right of the 807 valve socket. The numbers, L1 and R1 etc., refer to resistance contacts on the board, the L standing for "Left", and the R for "Right", the TC for "Top Centre", and the BC for "Bottom Centre".

Front Apron

Left		Right	
L1	○	○	R1
L2	○	TC	○
L3	○	○	R3
L4	○	○	R4
L5	○	○	R5
L6	○	○	R6
L7	○	○	R7
L8	○	BC	○
	○	○	R8

It is suggested that a faults log, kept in a manner similar to the following example, would be of great value to maintenance personnel.

Example

PL2A—Pin 1 — A Mic Input — 1.4

Short—R8 grounded

5.2—Interchanged Pins 1 and 2 at PL2A

6,000—Interchanged Blue and White at A Mic Input Transformer

Open—Open Blue at A Mic Input Transformer
—Open Primary of A Mic Input Transformer

The resistance analysis test is progressive and must be carried out in the sequence shown in Table 16.

APPENDIX V

MAIN DIFFERENCES

between

WIRELESS SET, CANADIAN, NO. 19 MK. III

and

WIRELESS SET NO. 19 MK. III OF BRITISH
MANUFACTURE

Canadian and British Wireless Sets No. 19 Mk. III are fully, mutually interchangeable in all their applications and installations. All accessories and essential spares such as microphones and headphones, control boxes, variometer, aerials, etc., are individually and mutually interchangeable. Most of the components used in the Canadian, Mk. III Set, are the same as those used in the British version. Not all of them, however, are fully, mutually interchangeable. The most important differences between the two versions are listed below:

1. The Canadian Set includes a Frequency Adjuster not used on the British Set. The presence of this makes the main tuning condenser non-interchangeable with the British gang-condenser.

2. The Canadian Set includes an AVC ON-OFF Switch. Such a switch is not used on the British Set and the British panel has no provisions for this Control.

3. The British Set has a new circuit for the heterodyne oscillator, while the Canadian set uses the same system as used on the Mk. II Set. That means that all heterodyne oscillator coils and R.F. coils in the sender are non-interchangeable.

4. The British Set uses a new type of circuit for the automatic drive control of the output stage, while the Canadian Set uses the same circuit as on the Mk. II.

5. The British Set has a new meter transformer circuit in the variometer, while the Canadian Set uses the same as on the Mk. II.

6. The British Set includes a resistance-capacitance network as tone-filter on CW, which is not used on the Canadian Set.

7. The Canadian Supply Unit is entirely different from the British version and uses an entirely different dynamotor. Hardly any parts of the Supply Unit are interchangeable but the Supply Units as a whole are fully, mutually, interchangeable.

These are the main differences between the British and Canadian versions but it must be pointed out that the arrangements of components and parts on the chassis, differ quite considerably, and that maintenance spares for the Canadian Set cannot be used without careful consideration in the British model and vice versa.

TABLE XII (Cont'd)

LAMPS

CIRCUIT REF.	LOCATION	PYE OR RCA NO.	VALUE	TOLERANCE	RATING	USED ON
P1A	LAMP, PILOT	PC90615C	12 V			P/S

TABLE XII
 COMPONENT PARTS LIST
 WIRELESS SETS (CANADIAN) NO. 19 MK. III
 RESISTORS

CIRCUIT REF.	LOCATION	PYE OR RCA NO.	VALUE	TOLERANCE	RATING	USED ON
R1A	SCREEN V1E	PC70722C	470000	20%	1/4 W	S/RB
B	LOAD V3A	PC70722C	470000	20%	1/4 W	S/RA
C	LOAD V6A	PC70722C	470000	20%	1/4 W	S/RA
D	FILTER V6A	PC70722C	470000	20%	1/4 W	S/RA
E	GRID V5A	PC70722C	470000	20%	1/4 W	S/RA
F	SCREEN V1F	PC70722C	470000	20%	1/4 W	S/R1/C
R2A	CATH V1A	PC70732C	220	10%	1/2 W	S/RA
B	CATH V2B	PC70732C	220	10%	1/2 W	S/RA
C	SEC T5A	PC70732C	220	10%	1/2 W	S/RB
D	PRI T4B	PC70732C	220	10%	1/2 W	S/R 1/C
E	SEC T6A	PC70732C	220	10%	1/2 W	S/R 1/C
F	H F OSC. V2A	PC70732C	220	10%	1/2 W	S/RA
R3A	CATH V2A	PC70730C	270	10%	1/2 W	S/RA
B	CATH V1C	PC70730C	270	10%	1/2 W	S/RA
R4A	SCREEN V2A	PC70721C	22000	10%	1 W	S/RA
D	SCREEN V2B	PC70721C	22000	10%	1 W	S/RA
R5A	P.FILT. V1A	PC70725C	2200	10%	1/4 W	S/RA
B	P.FILT. V2A	PC70725C	2200	10%	1/4 W	S/RA
C	P.FILT. V1C	PC70725C	2200	10%	1/4 W	S/RA

TABLE XII (Cont'd)
RESISTORS (Cont'd)

CIRCUIT REF.	LOCATION	PYE OR RCA NO.	VALUE	TOLERANCE	RATING	USED ON
R5D E	P-FILT. V5A V2B	PC70725C PC70725C	2200 2200	10% 10%	1/4 W 1/4 W	S/RA S/RA
R6B D	GRID V2A	PC70725C	47000	10%	1/4 W	S/RA
F	CATH V2B	PC70725C	47000	10%	1/4 W	S/RA
G	V3A	PC70725C	3000	10%	1/4 W	S/RA
H	GRID V3B FILT. V3C V1A-V1E	PC70725C	47000	10%	1/4 W	S/RB
* R7A * B	DAMP RES. 1ST I.F.	PC70743C	100000	10%	1/4 W	S/RA
C	DAMP RES. 2ND I.F.	PC70743C	100000	10%	1/4 W	S/RA
D	FILT. GRID I.F.	PC70743C	100000	10%	1/4 W	S/RA
G	GRID V4A	PC70743C	100000	10%	1/4 W	S/RA
H	GRID V4A	PC70743C	100000	10%	1/4 W	S/RA
J	SEC. T4A	PC70743C	100000	10%	1/4 W	S/RA
K	PLATE V1E	PC70743C	100000	10%	1/2 W	S/RB 1/C
L	VIF	PC70743C	100000	10%	1/2 W	S/RA
L	DIVIDER V2A	PC70743C	100000	20%	1/4 W	S/RA
L	SCREEN V1A	PC70743C	100000	20%	1/4 W	S/RA
R8A B	AVC LOAD V3A	PC70725C	1 MEG.	20%	1/4 W	S/RA
D	GRID V3A	PC70725C	1 MEG.	20%	1/4 W	S/RA
F	GRID V8A V8B	PC70725C	1 MEG.	20%	1/4 W	S/RB

* - NOT USED ON RCA TYPE U.F. COILS

TABLE XII (Cont'd)
RESISTORS (Cont'd)

CIRCUIT REF.	LOCATION	PYE OR RCA NO.	VALUE	TOLERANCE	RATING	USED ON
R9A B	CATH V1B	PC72388C	1000	10%	1/4 W	S/RA
C	CATH V1E	PC72388C	1000	10%	1/4 W	S/RB
D	CATH V1F	PC72388C	1000	10%	1/4 W	S/R 1/C
E	CATH V8A CATH V3A	PC72388C	1000	10%	1/4 W	S/RB
R10A C	DAMP RES. (VARIOMETER) METER SHUNT	PC70725C PC70725C	470 470	10% 10%	1/2 W 1/2 W	VARA S/RA
R11A B	CATH V3A PLATE V1D	PC70713C PC70713C	3300 3300	10% 10%	1/2 W 1/4 W	S/RA S/RB
R12A	SCREEN V3A	PC70717C	68000	10%	1/2 W	S/RA
R13A	VOL. CONT. (A)	PC81256C	1 MEG.	VAR.		S/RA
R14A	HET. CONT.	PC81256C	6.0	VAR.		S/RA
R15B	DIVIDER V6A	PC70744C	220000	20%	1/4 W	S/RA
R16A	RES. IN L5A	PC89038C	1/2	5%	1/2 W	S/RA
R17A	SCREEN V5A	PC70724C	3900	10%	1/4 W	S/RA
R18A B	CATH V6A TO 57 CATH V4A TO I-HT-1 GRID V7A	PC70727C PC70727C PC70727C	270000 270000 270000	10% 10% 10%	1/2 W 1/2 W 1/4 W	S/RA S/RA S/RA

TABLE XII (Cont'd)
RESISTORS (Cont'd)

CIRCUIT REF.	LOCATION	PYE OR RCA NO.	VALUE	TOLERANCE	RATING	USED ON
R19A B	CATH V4A SCREEN V1C	PC70728C PC70728C	82000 82000	10% 10%	1/4 W 1/2 W	S/R S/RB
R20A B	SCREEN V4A CATH V5A	PC72597C PC72597C	100 100	10% 10%	1/2 W 1/2 W	S/R S/RB
R21A B C	FILT. V7A FEEDBACK V2A METER RES.	PC70724C PC70724C PC70724C	27000 27000 27000	10% 10% 10%	1/4 W 1/4 W 1/4 W	S/R S/R S/RB
R22A	PLATE V4A	PC70733C	47	10%	1/2 W	S/R
R22B C D E	SER. GRID V1E PL. FILT. V1E SER. GRID V1F PL. FILT. V1F	PC70725C PC70725C PC70725C PC70725C	22000 22000 22000 22000	10% 10% 10% 10%	1/4 W 1/4 W 1/4 W 1/4 W	S/RB S/RB S/R 1/C S/R 1/C
R24A	METER SER. RES.	PC71901C	1.2 MEG.	5%	1/2 W	S/R
R25A	METER SER. RES.	PC90459C	1.2 MEG.	5%	1 W	S/R
R25A	METER SER. RES.	PC72399C	29000	2%	1/4 W	S/R
R28A	DAMP. RES. IN VARIOMETER	PC70740C	27	10%	1/2 W	VAR. (A)
R29A	CONTROL IN VARIOMETER	PC81254C	20000	-	-	VAR. (A)

TABLE XII (Cont'd)
RESISTORS (Cont'd)

CIRCUIT REF.	LOCATION	PYE OR RCA NO.	VALUE	TOLERANCE	RATING	USED ON
R30A	FIL. V6A	PC90451C	30	5%	2 W	S/R
R31A	PLATE V1D	PC70741C	2200	10%	1/2 W	S/RB
R32A	GRID V7A	PC72559C	15000	10%	1/4 W	S/RB
R33A	PLATE V1D	PC90474C	27000	10%	1/2 W	S/RB
R33-1A	PLATE V1D	K5974-57B	47000	10%	1/2 W	S/RB
R34A B C	SCREEN V3D OSC. PLATE V2A OSC. PLATE V2B	PC70742C PC70742C PC70742C	47000 47000 47000	10% 10% 10%	1 W 1 W 1 W	S/RB S/R S/R
R35A	VOL. CONT. "B"	PC81257C	100000	-	-	S/RB
R35A	FEEDBACK "B"	PC70736C	39000	10%	1/4 W	S/RB
R37A	CATH V8A	PC70731C	390	10%	1 W	S/RB
R38A	FIL. V7A	PC69034C	56	5%	1 W	S/RB
R39A B	CATH V8B MASTER OSC. GRID	PC70714C PC70714C	820 820	10% 10%	1 W 1 W	S/R 1/C S/R
R40A	LAMP RES. P/S	PC90460C	20	10%	1/2 W	P/S

TABLE XII (Cont'd)
RESISTORS (Cont'd)

CIRCUIT REF.	LOCATION	PYE OR RCA NO.	VALUE	TOLERANCE	RATING	USED ON
R42A B C	GRID V2A DIVIDER V6A DIVIDER V2A-2B	PC72648C PC72648C PC72648C	10000 10000 10000	10% 10% 10%	1/4 W 1/4 W 1/4 W	S/RA S/RA S/RA
R43A	P A BIAS	PC81265C	100000	-	-	S/RA
R44A	SCREEN V1A	PC70745C	39000	10%	1 W	S/RA
R45A B	SCREEN V2A SCREEN V2B	PC72385C PC72385C	22000 22000	10% 10%	2 W 2 W	S/RA S/RA
R/C-101A	FILT. B + VIB.	RC113804-1	47	20%	1 W	P/S
R/C-102A	BUFFER SEC.	RC113804-2	15000	10%	1/2 W	P/S
R/C-103A	AVC. FILT. T/C-101A	RC113804-4	1 MEG.	20%	1/2 W	S/RA
R/C-104A	BIAS V4A	RC113804-3	1500	10%	2 W	S/RA
R/C-105A	R.F. GAIN	RC113925-1	10000	-	-	S/RA

TABLE XII (Cont'd)
 CAPACITORS

CIRCUIT REF.	LOCATION	PC OR RCA NO.	TYPE	VALUE	TOLERANCE	RATING	USED ON
C1A	COUP. ANT. "A"	P 056109C	MICA	4000 MMF	20%	2200V	S/RA
C2A	COUP. V1A	P 056095C	MICA	500 MMF	20%	1000V	S/RA
B	OSC. COUP. V2A	P 056718C	MICA	300 MMF	20%	1000V	S/RA
C	GRID V5A	P 056718C	MICA	300 MMF	20%	1000V	S/RA
D	GRID V6A	P 056718C	MICA	300 MMF	20%	1000V	S/RA
E	GRID V4A	P 056718C	MICA	300 MMF	20%	1000V	S/RA
C3A	P A TUNING	P 050179C	AIR	16-550 MMF	VAR.	-	S/RA
C4A	SCREEN V1A	P 058182C	OIL FILLED	0.1 MF	20%	500V	S/RA
B	CATH V1A	P 058182C	OIL FILLED	0.1 MF	20%	500V	S/RA
C	PLATE V1A	P 058182C	OIL FILLED	0.1 MF	20%	500V	S/RA
D	SCREEN V2A	P 058182C	OIL FILLED	0.1 MF	20%	500V	S/RA
E	CATH V2A	P 058182C	OIL FILLED	0.1 MF	20%	500V	S/RA
F	PLATE V2A	P 058182C	OIL FILLED	0.1 MF	20%	500V	S/RA
H	CATH V1B	P 058182C	OIL FILLED	0.1 MF	20%	500V	S/RA
I	PLATE V1B	P 058182C	OIL FILLED	0.1 MF	20%	500V	S/RA
J	CATH V1C	P 058182C	OIL FILLED	0.1 MF	20%	500V	S/RA
K	PLATE V1C	P 058182C	OIL FILLED	0.1 MF	20%	500V	S/RA
L	SCREEN V3A	P 058182C	OIL FILLED	0.1 MF	20%	500V	S/RA
M	CATH V3A	P 058182C	OIL FILLED	0.1 MF	20%	500V	S/RA
N	SCREEN V3A	P 058182C	OIL FILLED	0.1 MF	20%	500V	S/RA
O	CATH V3A	P 058182C	OIL FILLED	0.1 MF	20%	500V	S/RA
Q	SCREEN V1C	P 058182C	OIL FILLED	0.1 MF	20%	500V	S/RA
R	CATH V2B	P 058182C	OIL FILLED	0.1 MF	20%	500V	S/RA
S	PLATE V5A	P 058182C	OIL FILLED	0.1 MF	20%	500V	S/RA
T	CATH V5A	P 058182C	OIL FILLED	0.1 MF	20%	500V	S/RA
U	PLATE V2B	P 058182C	OIL FILLED	0.1 MF	20%	500V	S/RA
V	SCREEN V2B	P 058182C	OIL FILLED	0.1 MF	20%	500V	S/RA
W	SCREEN V1D	P 058182C	OIL FILLED	0.1 MF	20%	500V	S/RA
X	SCREEN V1E	P 058182C	OIL FILLED	0.1 MF	20%	500V	S/RA
AP	R.F. INTERF. SUP. LT DYN.	P 058182C	OIL FILLED	0.1 MF	20%	500V	S/RB
BP	R.F. INTERF. SUP. LT DYN.	P 058182C	OIL FILLED	0.1 MF	20%	500V	S/RB
CP	R.F. INTERF. SUP. HT ₂ NG. DYN.	P 058182C	OIL FILLED	0.1 MF	20%	500V	S/R 1/C P/S P/S

TABLE XI (Cont'd)
CAPACITORS (Cont'd)

CIRCUIT REF.	LOCATION	PC OR RCA NO.	TYPE	VALUE	TOLERANCE	RATING	USED ON
C5A	GRID V2A	P655110C	MICA	0.1MF	10%	600V	S/RA
C	BLOCK GRID V2B	P655110C	MICA	-0.1MF	10%	600V	S/RA
C5A	PAR PAD M OSC. V2A	P655129C	COMPENSATOR	50 MAF	5%	1300V	S/RA
C7A	GRID COUPLING V2A (TRIODE)	P655117C	CER(MICA)	30 MAF	20%	1000V	S/RA
B	GRID COUPLING V2B (TRIODE)	P655117C	CER(MICA)	30 MAF	20%	1000V	S/RA
C8A	OSC. PAD (HF) V2A	P655257C	MICA	3300 MAF	5%	600V	S/RA
C9A	GRID TUNING V2A (PENTODE)	P650180C	4 GANG VARIABLE AIR COND.	5.70 MAF	VAR.		S/RA
B	OSC. TUNING PLATE V2A (TRIODE)	P650180C	4 GANG VARIABLE AIR COND.	5.70 MAF	VAR.		S/RA
C	GRID TUNING V2A	P650180C	4 GANG VARIABLE AIR COND.	5.70 MAF	VAR.		S/RA
D	GRID TUNING V2A	P650180C	4 GANG VARIABLE AIR COND.	5.70 MAF	VAR.		S/RA
C30A	R.F. TRIMMER (HF) GRID V2A	P650174C	R15196-1	4-30 MAF. VAR. CER.	VAR.		S/RA
B	DRIVE TRIMMER (HF) P2-V5A	P650168C	R15196-1	4-30 MAF. VAR. CER.	VAR.		S/RA
C	SENDER R.F. TRIMMER (HF) GRID V5A	P650168C	R15196-1	4-30 MAF. VAR. CER.	VAR.		S/RA
D	R.F. TRIMMER (LF) GRID V2A	P6501770-191	R15196-1	4-30 MAF. VAR. CER.	VAR.		S/RA
E	SENDER R.F. TRIMMER (LF) GRID V5A	P650177C	R15196-1	4-30 MAF. VAR. CER.	VAR.		S/RA
F	DRIVE TRIMMER (LF) P2-V5A	P650177C	R15196-1	4-30 MAF. VAR. CER.	VAR.		S/RA
C-10-1A	RF PAD (H.F.) GRID V2A	P650174C-191	MICA	5.7-340 MAF (VAR. AIR)	20%	3000V	S/RA
C11A	OSC. PAD (LF) PLATE V2A	NE60128C	APC140	30 MAF	VAR		S/RA
C12A	OSC. PAD (LF) V2A	P655133C	MICA	1760 MAF	3%	1000V	S/RA

TABLE XII (Cont'd)
CAPACITORS (Cont'd)

CIRCUIT REF.	LOCATION	PC OR RCA NO.	TYPE	VALUE	TOLERANCE	RATING	USED ON
C12A	PB1, LBA 1ST I.F.	P655050C	COMP. CER.	140 MAF	20%	350V	S/RA
B	SEC. LBA 2ND I.F.	P655050C	COMP. CER.	140 MAF	20%	350V	S/RA
C	PB1, LBB 2ND I.F.	P655050C	COMP. CER.	140 MAF	20%	350V	S/RA
D	SEC. LBB 2ND I.F.	P655050C	COMP. CER.	140 MAF	20%	350V	S/RA
E	SEC. LBA 3RD I.F.	P655050C	COMP. CER.	140 MAF	20%	350V	S/RA
F	SEC. LBB 3RD I.F.	P655050C	COMP. CER.	140 MAF	20%	350V	S/RA
C14A	RF FILTER AUDIO DIODE V3A	P650596C	MICA	300 MAF	20%	1000V	S/RA
B	HF CUT OFF AUDIO V3F	P650596C	MICA	300 MAF	20%	1000V	S/R 1/2
C15A	RF FILTER AUDIO DIODE V3A	P650595C	MICA	500 MAF	20%	1000V	S/RA
B	RF FILTER BIAS RECT. V5A	P650595C	MICA	500 MAF	20%	1000V	S/RA
C	CATH. BY PASS V5A	P650595C	MICA	500 MAF	20%	1000V	S/RA
D	CATH. BY PASS V6A	P650595C	MICA	500 MAF	20%	1000V	S/RA
E	VOLTAGE DIV. R/T MOD. V3A	P650595C	MICA	500 MAF	20%	1000V	S/RA
F	SCREEN BY PASS V4A	P650595C	MICA	500 MAF	20%	1000V	S/RA
G	PLATE GRID QUENCH OSC. V1D	P650595C	MICA	500 MAF	20%	1000V	S/RA
H	PLATE V1E	P650595C	MICA	500 MAF	20%	1000V	S/RA
J	HEATER CATH. BYPASS V7A	P650595C	MICA	500 MAF	20%	1000V	S/RA
K	HEATER CATH. BYPASS V7A	P650595C	MICA	500 MAF	20%	1000V	S/RA
L	RF FILTER "DRIVE" METER SHUNT	P650595C	MICA	500 MAF	20%	1000V	S/RA
C15A	CATH. BY PASS V3A	P657136C	PLAIN PLATE	12 MF	-0%	50V	S/RA
B	CATH. BY PASS V5A	P657136C	ELECTROLYTIC	12 MF	+100%	50V	S/RA
C17A	COMP. DIODE TO GAIN CONT. V3A	P655122C	MICA	2000 MAF	20%	1000V	S/RA
B	VOLT. DIV. R/T MOD. V3A	P655122C	MICA	2000 MAF	20%	1000V	S/RA
C	RF FILTER METER "AE" CCT.	P655122C	MICA	2000 MAF	20%	1000V	S/RA
C18A	DIODE PLATE COMP V3A	P655242C	MICA	20 MAF	20%	1000V	S/RA
C19A	TUNING BFO GRID V2B (TRIODE)	P655051C	COMP. CER.	90 MAF	20%	1300V	S/RA

TABLE XI (Cont'd)
CAPACITORS (cont'd)

CIRCUIT REF.	LOCATION	PC OR RCA NO.	TYPE	VALUE	TOLERANCE	RATING	USED ON
C22A	8W-PASS PLATE VIB. (TRIGGERS)	PC55048C PC55049C	MICA	2000 MAF	20%	3000V	S/R
C22B	SCREEN BY-PASS VIB.	PC55048C	MICA	2000 MAF	20%	3000V	S/R
C22C	COUPLING SEC. OSC. V2A-V2B	PC55048C	MICA	30 MAF	20%	3000V	S/R
C22A	COUPLING TANK ANT. V1A	PC55048C	MICA	70 MAF	+ - 30MAF	3000V	S/R
C22A	PILOT GRID COMP V2A	PC58189C	OIL FILLED	.025 MF	20%	500V	S/R
C22A	PILOT LIGHT 8Y-PASS	PC58189C	OIL FILLED	.025 MF	20%	500V	P/S
C22A	BLOCK CAP. PLATE V4A	PC58147C	MICA	5000 MAF	20%	500V	S/R
C24A	AERIAL BLOCKING	PC45984C	MICA	3000 MAF	20%	5000V	VAR (A)
C26A	78" SET TUNING	PC80162C OR PC80199C	10C/2872	2.5/5.5 MF PER SECT. VAR.	VAR.		S/R
C26A	RF FILT. GER. RECT.	PC66798C	MICA	3000 MAF	20%	3000V	VAR (A)
C27A	GRID COMP V7A	PC66192C	GER. GLASS D	20 MAF	10%	3300V	S/R
C28A	FEEDBACK QUENCH VID	PC66202C	MICA	700 MAF	5%	3000V	S/R
C29A	OUTPUT COUPLING QUENCH TO	PC58189C	MICA	.01 MF	+20%+50%	600V	S/R
C	GAIN COMP. PLATE V1E TO GRID V8A	PC58189C	MICA	-0.1 MF	+20%+50%	600V	S/R
C	COUPLING PLATE V1F TO GRID V8B	PC58189C	MICA	-0.1 MF	+20%+50%	600V	S/R
C30A	QUENCH FREQ. FILT. PLATE V1E	PC58747C	MICA	3000 MAF	15%	3000V	S/R
C30A	QUENCH FREQ. FILT. PLATE V1E	PC58747C	MICA	3000 MAF	15%	3000V	S/R
C31A	DECOUPLING HT TO VID	PC57193C	PLAIN PLATE ELECTROLYTIC	2 MF	-0%+100%	300V	S/R
B	DECOUPLING HT TO V1E	PC57193C	PLAIN PLATE ELECTROLYTIC	2 MF	-0%+100%	300V	S/R
C	DECOUPLING HT TO V1F	PC57193C	PLAIN PLATE ELECTROLYTIC	2 MF	-0%+100%	300V	S/R

TABLE XII (Cont'd)
CAPACITORS (cont'd)

CIRCUIT REF.	LOCATION	PC OR RCA NO.	TYPE	VALUE	TOLERANCE	RATING	USED ON
C32A	DECOUPLING HT TO POWER UNIT	PC57192C	PLAIN PLATE ELECTROLYTIC	32 MF	+50% - 30%	400V	S/U
C33B	DECOUPLING HT TO V4A	PC58121C	OIL FILLED	0.1 MF	10%	3500V	S/R
C34A	GRID DRIVE CONT. V4A	PC80127C/A	R3519F-2	7-45 MAF	VAR. CERAMIC	VAR.	S/R
C35A	GRID OSC. TRIMMER	R1519F-3		3-30 MAF	VAR. CERAMIC	VAR.	S/R
C35A	OSC. TRIMMER (LF) V2A	R1519F-3		3-30 MAF	VAR. CERAMIC	VAR.	S/R
C35A	TANK BLOCKING V4A	PC65148C	MICA	-0.1 MF	10%	2200V	S/R
C37A	QUENCH RES. CCT. VID	PC65172C	MICA	500 MAF	2%	3000V	S/R
C37A	AVC V3A	PC68182C	OIL FILLED	0.1 MF	20%	500V	S/R
C/CD13A	RF INT. SUP. LT NEG.	RC411300-1	OIL FILLED	0.1 MF	20%	500V	P/S
C	RF INT. SUP. LT POS-NEG.	RC411300-1	OIL FILLED	0.1 MF	20%	500V	P/S
C	RF INT. SUP. LT POS	RC411300-1	OIL FILLED	0.1 MF	20%	500V	P/S
C	RF INT. SUP. HT VIBRATOR	PC68182C	OIL FILLED	0.1 MF	20%	500V	P/S
E	RF INT. SUP. HT DYNAM.	PC68182C	OIL FILLED	0.1 MF	20%	500V	P/S
C/CD20A	RF INT. SUP. VIB. TRANSF.	RC411300-1	OIL FILLED	0.5 MF	20%	65V	P/S
C/CD3A	BUFFER VIB. TRANSF. PRIM.	RC411300-1	OIL FILLED	1 MF	10%	30V	P/S
C/CD3A	BUFFER VIB. TRANSF. SEC.	RC411300-1	OIL FILLED	.004 MF	10%	3000V	P/S
C/CD5A	HT. FILTER. VIB.	RC411300-1	DRY ELECTROLYTIC	20 MF	-10%+50%	400V	P/S
C/CD5A	HT. FILTER. VIB.	RC411300-1	DRY ELECTROLYTIC	20 MF	-10%+50%	400V	P/S

- THESE ITEMS ARE COMBINED IN ONE UNIT AND ARE NOT SEPARATELY REPLACEABLE.

* - PART OF VIB. TRANSFORMER AND IS NOT SEPARATELY REPLACEABLE.

TABLE XII (Cont'd)
CAPACITORS (Cont'd)

CIRCUIT REF.	LOCATION	PC OR RCA NO.	TYPE	VALUE	TOLERANCE	RATING	USED ON
C/C106A	RF INT. SUP. LT ₂ POS.	PC68121C	OIL FILLED	.1 MF	10%	1500V	P/S
C/C107A	DECOUPLING V4A	RCA113927-1	ELECTROLYTIC	12 MF	10%	100V	S/A

TABLE XII (Cont'd)
SOCKETS

CIRCUIT REF.	LOCATION	PYE OR RCA NO.	VALUE	TOLERANCE	RATING	USED ON
S01	6 POINT SOCKETS	PC75470C OR RC113921-501				INSTALLATION KIT CONNECTORS CONN. 12 PT. #273A & INST. KIT CONNECT.
S02	12 POINT SOCKETS	PC75424C OR RC113921-502				
S03	SNATCH SOCKETS	COMPRISING PC76484 PC90681C PC90737				
S04A B	FEEDER SOCKET "A" SET FEEDER SOCKET VARIOM.	PC75511C PC75511C				JUNCT. DIST. & CONTROL UNIT
S05A	FEEDER SOCKET "B" SET	PC75511C				
K1A	KEY & PLUG ASSEM.	KEY PC90691C-1 OR RC1110072-1				SET KIT
W1A	WESTECTER	RECTIFIER PC90747C				VARIOMETER
F1A B	FUSE - DYN. 540V FUSE - DYN. 265V	FUSES PC90267C PC90267C	250MA 250MA			P/S P/S
F/C101A	FUSE - VIBRATOR	RC113838-1	10 AMP			P/S

INDUCTANCES

CIRCUIT REF.	AERIAL VARIOMETER	INDUCTANCES	VAR.
L1A	AERIAL VARIOMETER	PC75608C	VAR.
L2A	CHOKE	PC79115C	VAR.
L2-1A	CHOKE	PC79115C	S/R
L2B	METER CHOKE	PC79115C-191	S/R
L3A	PA TUNING COIL	PC78465C	S/R
L4A	DRIVE ANODE TUN. IND. HF	PC78470C	S/R
*L5A B	LF OSC. IND. (80) LF OSC. COUP	PC78436C	S/R
L6A	DRIVE ANODE TUN. IND. LF	PC78471C	S/R
L7A	SENDER F.C. TUNING IND. LF	PC78472C	S/R
L8A B	1ST I.F. TRANS. 2ND I.F. TRANS.	PC77366C PC77366C	S/R S/R
L9A	3RD I.F. TRANS.	PC77367C	S/R
L30A	RF CHOKE VIA GRID	PC79116C	S/R

ITEMS MARKED * ARE NOT SEPARATELY DEMANDABLE.

TABLE XII (Cont'd)
INDUCTANCES (Cont'd)

CIRCUIT REF.	LOCATION	PYE OR RCA NO.	VALUE	TOLERANCE	RATING	USED ON
L11A	VHF TUN. IND.	PC78432C				S/RB
L12A	VHF AER. CHOKE	PC79126C				S/RB
L13A	VHF V7A CATH. CHOKE	PC79114C				S/RB
L14A	QUENCH TUNING VID	PC78437C				S/RB
L15A	QUENCH ANODE VID	PC78320C				S/RB
L17A	LT CHOKE	RC113865-501				P/S
L18A	RF CHOKE (DYN 540V)	PC78439C				P/S
L19A B	RELAY COIL "A" RELAY COIL "B"	PC90611C PC90611C				S/R S/RB
L21A	SENDER FC ANODE TUN. IND. LF	PC78473C				S/R
*L22A B	RF REC. TUN. IND. RF REC. HF COUP	PC78469C				S/R
*L23A B	RF REC. TUNING IND. RF REC. LF COUP	PC78466C				S/R
*L24A B	RF OSC. TUN. IND. HF RF OSC. COUP	PC78467C				S/R
*L25A B	RF OSC. TUN. IND. LF RF OSC. COUPLING	PC78467C				S/R

ITEMS MARKED * ARE NOT SEPARATELY DEMANDABLE.

TABLE XII (Cont'd)
INDUCTANCES (Cont'd)

CIRCUIT REF.	LOCATION	PYE OR RCA NO.	VALUE	TOLERANCE	RATING	USED ON
L26A	"B" AERIAL CHOKE	PC79126C				S/RB
L/C101A	VIBRATOR CHOKE	RCA113806-501				P/S
*L/C102A	VIBRATOR CHOKE	THIS ITEM CONTAINED IN VIB. T/C101A				P/S
L/C103A	FLICK ADJUSTER	COMPRISING RCA 113827-501 RCA 113825-501				
		TRANSFORMERS				
T1A	AER. CUR. METER TRANS.	PC77371C				VAR.
T2A	REC. OUT "A"	PC77369C				S/RA
T3A	MIC. TRANS. "A"	PC77370C				S/RA
T4A	MIC. TRANS. "B"	PC77368C				S/RA
B	MIC. TRANS. "1/C"	PC77368C				S/R 1/C
*{ T5A T6A	OUT. TRANS. "B" OUT. TRANS. "1/C"	PC76332C PC76332C				S/RB S/R 1/C
T/C101A	VIBRATOR TRANS.					

ITEMS MARKED * ARE NOT SEPARATELY DEMANDABLE.

TABLE XII (Cont'd)

SWITCHES

CIRCUIT REF.	LOCATION	PYE OR RCA NO.	VALUE	TOLERANCE	RATING	USED ON
S2A B C	PRESSEL SWITCH HAND MIC PRESSEL SWITCH HAND MIC PRESSEL SWITCH HAND MIC	PC76355C PC76355C PC76355C				
S4A B	PRESS. BUTTON POWER MIC. PRESS. BUTTON POWER MIC.	PC90618C PC90618C				
S5A B	RELAY S/R(A) RELAY S/R(B)	PC90611C PC90611C				S/RA S/RB
S7A	MCW, R/T, CW SW. 3 POS 9 POLE	PC83217C				S/RA
S8A	METER SW. 6 POS. 2 POLE	PC83206C				S/RA
S10B C	ON/OFF SW. "B" SET. DP TOG. ON/OFF SW. "C" AMP, DP TOG.	PC83220C PC83220C				S/RB S/R 1/C
S11A	WAVE CHANGE SW. 2 POS. 2 POLE WAVE CHANGE CERAMIC	PC83211C PC83211C-1				S/RA
S/C101A	PWR. SW. 4 POLE 3 POS. TOGGLE	RCAL10063-1				P/S
S/C102A	TOG. SW. 12V-24V. DPDT	RCAL13808-1				P/S
S/C103A	RELAY	RCAL10053-1				P/S
S/C104A	TOG. SW. DP "A" SET ON/OFF	PC83220C				S/RA

TABLE XII (Cont'd)
SWITCHES (Cont'd)

CIRCUIT REF.	LOCATION	PYE OR RCA NO.	VALUE	TOLERANCE	RATING	USED ON
S/C105A B	TOG. SW. SP AVC TOG. SW. SP NET	PC83223C PC83223C				S/RA S/RA
PL-1C	6 PT.-PYE PLUG (P/S INPUT)	PC75429C				P/S
PL-2A B C	12 PT.-PYE PLUG(S/R PWR. INPUT) 12 PT.-PYE PLUG(S/R OUTPUT) 12 PT.-PYE PLUG(S/R OUTPUT)	PC75423C				S/R S/R P/S
PL3A B C D	5 PT. SNATCH PLUG	COMPRISING PC76483 PC90680 PC90738				
PL4A B C	FEEDER PLUG "A" SET FEEDER PLUG "B" SET FEEDER PLUG VARIOMETER	PC75512C PC75517C-194 PC75512C				S/RA S/RB VAR.
J1A	KEY JACK "A" SET	JACK PC76150C				S/RA

TABLE XII (Cont'd)

VALVES

CIRCUIT REF.	LOCATION	PYE OR RCA NO.	VALUE	TOLERANCE	RATING	USED ON
V1A TO F	6K7G RF PENTODE	PC86182C				
V2A B	6K8G TRIODE HEYODE 6K8G TRIODE HEXODE	PC86184C PC86184C				
V3A	6B8G DOUBLE DIODE PENTODE	PC86183C				
V4A	807 (ATS25) BEAM POWER TETRODE	PC86186C				
V5A	ARP 25 OR EF50 RF PENTODE	PC86097C				
V6A	6H6 OR AR005 OR EB34 DOUBLE DIODE	PC86170C				
V7A	E1148 UHF OR CVG	PC86187C				
V8A B	6V6G OR ARP32 BEAM POWER TETRODE 6V6G OR ARP32 BEAM POWER TETRODE	PC86185C PC86185C				
V/C101A	OZ4A RECT. VALVE VIBRATOR DYNAMOTOR	MISCELLANEOUS RCA-110050-1 RCA-101985-1				

TABLE XIII

SET KIT FOR WIRELESS SET (CANADIAN) NO. 19 MARK III

Ref. RCA-110070

PYE OR RCA REF. NUMBER	W.D. CAT. NUMBER	DESIGNATION	MIN. FOR WORK	ESSENTIAL SPARES	TOTAL
RCA-107127-202		SENDER/RECEIVER (CANADIAN) MK. 111, COMPLETE WITH VALVES	1		1
RCA-101988-88		SUPPLY UNIT NO.2 (CANADIAN)	1		1
PC-75508C	ZAJ0214	VARIOMETER UNIT MK. 11	1		1
RCA-110076-501		CONNECTOR 1/2-POINT NO.23A (CANADIAN)	1		1
PC-90818C	ZAJ0202	PADS, MOUNTINGS (RESILIENT SEATINGS)	4		4
PC-82286-C	ZAJ3102	CARRIER NO.1	1		1
PC-90816C	ZAJ352	COVER, WATERPROOF NO.1	1		1
PC-75550C	ZAJ094	CASE, SPARE PARTS NO. 5C	1		1
#RCA-110072-1		KEY AND PLUG ASSEMBLY NO.9 (CANADIAN)	1		1
PC-90615C	WB1490	BULBS, 12V.	2	4	6
PC-75556C	ZAJB68	CONNECTOR PIGTAIL NO.1		2	2

CONTAINED
IN CASE
SPARE PARTS
NO.5C
PC76550C

TABLE XIII (Cont'd)

PYE OR RCA REF. NUMBER	W.D. CAT. NUMBER	DESIGNATION	MIN. FOR WORK	ESSENTIAL SPARES	TOTAL
PC-76557C	ZAJ0024	CONNECTOR PIGTAIL NO.2		2	2
PC-90769C	ZAJ0742	BRUSHES, DYN/MOTOR NO.4 (H.T.)		4	4
PC-90770C	ZAJB23	BRUSHES, DYN/MOTOR NO.1B (L.T.)		4	4
PC-90267C	ZAJ379	FUSES, 1/4 AMP.		12	12
RCA-113938-1		FUSES, 10 AMP.		12	12
PC-90266C, DET-3	ZAJ1957	HOLDERS, NO.1, CAPS		2	2
PC-90617C		MICROPHONE CAPSULE		1	1
PC-32089C, DET-2	ZAJ10084	CLAMPING SCREWS		6	6
PC-90154C	ZAJB14/1	PLUG, SINGLE, NO.26, SPRING RETAINING		3	3
PC-90521C	ZAJB15/1	PLUG, 6 PT., NO.4, SPRING RETAINING		2	2
PC-90520C	ZAJB16/1	PLUG, 12 PT., NO.1, SPRING RETAINING		5	5

CONTAINED
IN CASE
SPARE PARTS
NO.5C
PC76550C

TABLE XIII (Cont'd)

PYE OR RCA REF. NUMBER	W.D. CAT. NUMBER	DESIGNATION	MIN. FOR WORK	ESSENTIAL SPARES	TOTAL
PC-90546C	ZA10297	SOCKETS, 16 PT. NO. 5, CLIP SPRING SOCKETS, 12 PT. NO. 1, CLIP SPRING	3	2	2
PC-90545C-	ZA10298				
PC-90815C-191	ZA3104	BL IND GROMMET CASE, SPARE VALVES VALVES 6W76 VALVES 688G VALVES 6A8G VALVES 807 VALVES 6H6 VALVES EF-50 VALVES 6V6G VALVES E1148 SATCHEL, SIGNALS	1	6	6
PC-76873C	ZA5599		1	1	1
PC-861B2C	ZA5205		1	1	1
PC-861B3C	ZA5307		2	2	2
PC-861B4C	ZA5496		1	1	1
PC-861B6C	ZA3058		1	1	1
PC-86170C	ZA5306		1	1	1
PC-86097C	ZA3055		2	2	2
PC-861B5C			1	1	1
PC-861B7C			1	1	1
R-1195B-1			1	1	1

TABLE XIII (Cont'd)

PYE OR RCA REF. NUMBER	W.D. CAT. NUMBER	DESIGNATION	MIN. FOR WORK	ESSENTIAL SPARES	TOTAL
#RCA-110071-1		MICROPHONE & REC. HEADGEAR ASSEM. NO. 1 (CANADIAN)	2	1	3
PC-76387C	ZA1763	AERIAL, BASE NO. 8	1		1
PC-75525C	ZA1764	AERIAL, BASE NO. 9	1		1
PC-76421C	ZA3141	LEADS, AERIAL NO. 1	1		1
#RCA-110074-3		AERIAL ROD "F" SECTION NO. 3 (CANADIAN)	1	3	4
#RCA-110074-2		AERIAL ROD "F" SECTION NO. 2 (CANADIAN)	1	3	4
#RCA-110074-1		AERIAL ROD "F" SECTION NO. 1 (CANADIAN)	1	3	4
PC-90757C	ZA1171	AERIAL RODS "G"	1	2	3
RCA-113923-1		WORKING INSTRUCTIONS WIRELESS SET (CANADIAN) NO. 19, WK. 1111	1		1
PC-90653C		GROMMETS	2		2
PC-7641B0-191		DUMMY AERIAL	1		1

TABLE XIII - (Cont'd)

PYE OR RCA REF. NUMBER	W.D. CAT. NUMBER	DESIGNATION	MIN. FOR WORK	ESSENTIAL SPARES	TOTAL
PC-321066-190		AERIAL BASE NO.8, ADAPTOR "V" (LAPORT)	1		1
RCA-110077-1		LAMPS, OPERATOR NO.6 (CANADIAN)	1		1
RCA-110073-1		BREAST SET	2		2
#RCA-101998-1		CARTON	1		1
RCA-113939-1		LABEL, (FOR CARTON)	2		2
PC-76455-C	ZA2987	FIXING STRAP ASSEM. NO.2	1		1
PC-76454-C	ZA2988	FIXING STRAP ASSEM. NO.1	1		1
RCA-114033-501		HYDROMETERS, SECONDARY CELL PORTABLE MK. 1 (CANADIAN PATT.)	1		1

NOTE: # THESE PARTS ARE TO BE SUPPLIED WHEN EXISTING STOCKS OF THE EQUIVALENT PARTS IN THE OLD DESIGN ARE DEPLETED.
THE EQUIVALENT PARTS IN THE OLD DESIGN ARE AS FOLLOWS:--

NEW DESIGN	OLD DESIGN
RCA-110071-1	PC-76338C
RCA-110072-1	PC-90691C-1
RCA-110074-2	PC-90740C
RCA-110074-2	PC-90741C
RCA-110074-1	PC-90742C

**NORMAL METER READINGS
TABLE XIV**

METER SWITCH	METER FUNCTION	NORMAL READINGS							REMARKS
		FREQUENCY MC/S	8.0	6.0	4.5	3.5	2.5		
AE	INDICATES AERIAL CURRENT	OUTPUT VOLTS	4.0	6.0	8.0	5.5	3.0	MEASURED ON R/T OPERATION USING 0-15 V SCALE AND RF GAIN A FULLY CLOCKWISE. THESE READINGS ARE EXTREMELY VARIABLE AND NO LIMITS CAN BE GIVEN. THE GIVEN READINGS ARE MERELY TYPICAL OF NORMAL OPERATIONS.	
AVC	INDICATES RECEIVER TUNING	INPUT IN MICROVOLTS METER READING IN VOLTS	0	100	1000	10000	100000		
L.T.	INDICATES LT VOLTAGE APPLIED TO FILAMENTS		6.5	3.5	2.5	1.5	1.0	L.T. VOLTAGE SHOULD BE WITHIN THESE LIMITS TO ASSURE OPERATION. VOLTAGES BELOW 12 V WILL REDUCE OUTPUT PERFORMANCE.	
HT1	INDICATES 265V SUPPLY		10V TO 16V						THESE READINGS SHOULD BE OBTAINED WHEN THE LT VOLTAGE AT THE SENDER/RECEIVER TERMINALS IS 12 VOLTS.
HT2	INDICATES 500 V SUPPLY		215 TO 315 V						
DRIVE	INDICATES DRIVE VOLTAGE		480V TO 560V ON "RECEIVE"						
NOTE:	THE TEST METER IS CORRECT IF IT INDICATES A LT READING OF 11.4V TO 12.6V WHEN THE LT VOLTAGE APPLIED TO THE SENDER-RECEIVER TERMINALS IS 12 VOLTS.								

TABLE OF TESTS FOR DAILY MAINTENANCE

TABLE XV

PART OF SET TESTED	TEST NO.	TEST	WHAT SHOULD HAPPEN	WHAT SHOULD NOT HAPPEN	PROBABLE FAULT	ACTION
POWER SUPPLY	1	PUT SUPPLY UNIT ON DYN	RED LAMP LIGHTS AND MACHINE RUNS	(A) MACHINE DOES NOT RUN AND LAMP DOES NOT LIGHT (B) MACHINE RUNS BUT LAMP DOES NOT LIGHT (C) LAMP LIGHTS BUT MACHINE DOES NOT RUN PROPERLY	(1) VEHICLE FUSES (1) BATTERY LEAD (1) MASTER SWITCH OFF (1) BATTERY NOT PROPERLY CONNECTED	REPLACE FUSES CHECK CONNECTIONS. SWITCH ON. CORRECT IF POSSIBLE, OTHERWISE REPORT.
	2	PUT SUPPLY UNIT ON VIBR. (OMIT FOR 2-WIRE 24V)	LAMP SHOULD LIGHT FAINT RUN	LAMP DOES NOT LIGHT	BULB BURNED OUT (1) BATTERY LEAD (1) MACHINE OUT OF ORDER (1) 12V-24V SWITCH IN WRONG POSITION.	CHECK BULB. CHECK LEAD. CHECK SWITCH. REPORT. IN AN EMERGENCY CHECK LT BRUSHES
1 T VOLTAGE SUPPLY	3	METER SWITCH TO LT	METER READS NORMAL ABOUT 11-12 VOLTS	METER READS BELOW 20 VOLTS	VIBR. FUSE BLOWN INTERNAL FAULT BATTERIES NEED CHARGING	REPORT, REPLACE FUSE REPLACE VIBRATOR REPLACE VALVE
HT VOLTAGE SUPPLY	4	METER SWITCH TO HT1 SUPPLY UNIT TO DYN	METER READS ABOUT 25 VOLTS	METER READS ZERO OR BELOW 350 V	(1) HT1 FUSE BLOWN (1) INTERNAL FAULT	(1) REPLACE FUSE (1) REPORT. IN AN EMERGENCY CHECK HT BRUSHES.
	5	METER SWITCH TO HT2 SUPPLY UNIT TO VIBR (OMIT FOR 2-WIRE 24 V)	METER READS ABOUT 25 VOLTS	METER READS ZERO	(1) VIBR FUSE (1) INTERNAL FAULT	(1) REPLACE FUSE (1) REPORT, REPLACE VIBRATOR. REPLACE VALVE.

TABLE XV (Cont'd)

PART OF SET TESTED	TEST NO.	TEST	WHAT SHOULD HAPPEN	WHAT SHOULD NOT HAPPEN	PROBABLE FAULT	ACTION
	6	METER SWITCH TO HT2 SUPPLY UNIT TO DYN	METER READS ABOUT 540 VOLTS	METER READS ZERO	(1) HT2 FUSE BLOWN (1) INTERNAL FAULT	(1) REPLACE FUSE (1) REPORT. IN AN EMERGENCY CHECK HT BRUSHES.
	7	SET ON R/T PRESS PRESSEL SWITCH FOR SECURITY USE DUMMY AERIAL	METER READS IN (A) SHOULD DROP ABOUT 50 VOLTS	METER READING DROPS ONLY ABOUT 20 VOLTS	INTERNAL FAULT	REPORT
I-C SYSTEM AND HEADSETS	8	SWITCH CONTROL UNITS TO I-C PRESS ALL THE VEHICLE AND SPEAKERS TEST ALL HEADSETS	SPEECH HEARD IN ALL THE VEHICLE INCLUDING YOUR OWN	NOTHING HEARD	(1) SWITCH PLUG LOOSE (1) FAULTY HEADSET (1) INTERNAL FAULT	(1) CLEAN & CHECK (1) REPLACE HEADSET (1) REPORT (1) SEE RUNNING REPAIRS (13 AND 14)
	9	PRESS BUZZER BUTTON ON JUNCTION BOX COMMANDER'S PHONES	BUZZER SHOULD RING	BUZZER DOES NOT RING	BUZZER NEEDS ADJUSTING	ADJUST BUZZER
"A" RECEIVER	10	CONTROL UNIT SWITCH TO A BE ON R/C AND TUNE TO ANY STRONG R/T SIGNAL (A BROADCAST STATION) FULLY CLOCKWISE.	(A) STATION HEARD IN PHONES	(1) STATION NOT HEARD IN PHONES	(1) AERIAL DISCONNECTED (1) INTERNAL FAULT	(1) EXAMINE ALL CONNECTIONS INCLUDING PIFEAL (1) REPORT. IN AN EMERGENCY RUNNING REPAIRS (3 AND 9)
			(B) METER SHOULD READ LESS THAN STATION THAN WHEN IT IS NOT.	(2) STATION HEARD BUT VERY NOISY	LOOSE CONNECTIONS	CHECK AERIAL CONNECTIONS ON COAXIAL CABLE
				METER READING DOES NOT ALTER	INTERNAL FAULT	REPORT

TABLE XV (Cont'd)

PART OF SET TESTED	TEST NO.	TEST	WHAT SHOULD HAPPEN	WHAT SHOULD NOT HAPPEN	PROBABLE FAULT	ACTION
	11	AS IN (10) BUT REDUCE RF GAIN	AVC READING DROPS	AVC READING DOES NOT DROP	INTERNAL FAULT	REPORT
	12	TURN NET SWITCH DOWN TO A FREQUENCY 100 KC.	WHISTLE IS HEARD	NO WHISTLE HEARD	INTERNAL FAULT	REPORT SEE RUNNING REPAIRS 5-9.
"A" SENDER NOT TO BE TESTED UNDER WIRELESS SILENCE UNLESS ORDERED USING DUMMY-AERIAL.	13	PRESS SWITCH TO AE VARIOMETER AND A PA TUNING FOR MAXIMUM READING.	METER READING ACCORDING TO READING CHART.	METER DOES NOT READ OR READS VERY LOW.	(1) PRESS/ SWITCH MEETS LOSS OF CONTACTS. (11) INTERNAL FAULTS	(1) TRY ANOTHER HEAD- CHECK CONNE- (11) REPORT SEE RUNNING REPAIRS 4, 5, 7, 8 AND 9.
	14	SPEAK LOUDLY INTO MICROPHONE	(A) METER NEEDLE KICKS (B) SIDETONE HEARD	METER READING DOES NOT ALTER	INTERNAL FAULT	REPORT SEE RUNNING REPAIRS 6.
MCW AND CW OPERATION	15	SWITCH SET TO CW PLUG IN KEY AND PRESS	AE READING AS IN TEST 13	METER DOES NOT READ OR READS VERY LOW	(1) FAULT IN KEY OR LEAD PLUG. (11) INTERNAL FAULT	(1) CHECK KEY, LEAD AND PLUG. SEE RUNNING REPAIRS 30.
	16	WITH KEY PRESSED SWITCH TO MCW AND BACK TO CW	WHISTLE HEAR IN PHONES	NO WHISTLE	INTERNAL FAULT	REPORT SEE RUNNING REPAIRS 5.
	17	PULL PLUG HALF OUT AND LISTEN TO BROADCAST WITH SET ON CW.	DISTORTED SPEECH AND WHISTLE HEARD	NO WHISTLE HEARD	INTERNAL FAULT	REPORT SEE RUNNING REPAIRS 5.

TABLE XV (Cont'd)

PART OF SET TESTED	TEST NO.	TEST	WHAT SHOULD HAPPEN	WHAT SHOULD NOT HAPPEN	PROBABLE FAULT	ACTION
"B" RECEIVER	18	CONTROL UNIT SWITCH TO B ON-OFF ON	HISS HEARD IN PHONES	(A) NOTHING HEARD IN PHONES (B) HISS HEARD IN PHONES, BUT RECEPTION VERY NOISY	INTERNAL FAULT LOOSE CONNECTIONS	REPORT SEE RUNNING REPAIRS 31. (1) CHECK AERIAL LEAD INCLUDING SOCKET IN CONTROL CABLE SEE RUNNING REPAIRS 37.
"B" SENDER NOT TO BE TESTED UNDER WIRELESS SILENCE	19	PRESS PRESS- SWITCH AND SPEAK	HISS DISAPPEARS AND SIDETONE IS HEARD	HISS IS STILL HEARD OR SIDETONE IS NOT HEARD	INTERNAL FAULT	REPORT SEE RUNNING REPAIRS 15.
PILOT LAMP	20	PUT SWITCHES ON BOTH CONTROL UNITS TO "B"	RED LAMP LIGHTS ON OPERATORS CONTROL UNIT	LAMP DOES NOT LIGHT	(1) BULB BURNT OUT (11) FUSE BLOWN	(1) REPLACE BULB (11) REPLACE FUSE IN CONTROL UNIT NO. 1.
GENERAL	21	CHECK ALL CONTROLS WHEN RECEIVING	CONTROLS SHOULD WORK SMOOTHLY	CONTROLS JAM, FEEL THROUGH* OR FAIL TO WORK.	INTERNAL FAULT	REPORT

WIRELESS SET, CANADIAN, NO.19 MK.IIII
PROGRESSIVE RESISTANCE ANALYSIS

TABLE XVI

	1	2	3	4	5	6	7	8	9	10
12 PRONG BATTERY PLUG - #1,2B										
A SWITCH OFF	SHORT	3-6	OPEN	OPEN	OPEN	OPEN	1500	OPEN		
ALSO READS TO		6-P1 2A	30-P1 2A		9-P1 2A			7-P1 2A		
A ON RECEIVE		OPEN	OPEN			27,250				
A ON TRANSMIT		OPEN	OPEN			52,000				
B ON ONLY		OPEN	OPEN			OPEN				
I.C. ON ONLY		OPEN	OPEN			OPEN				
12 PRONG COMMUNICATION PLUG - PL2A - INSERT DUMMY 12 PRONG PLUG SHORTING #1,3,4,6										
	1-4	6-2	6	5-2	1B		300	100		
VBB (6V6G) I.C. OUTPUT I.C. ON-OFF SWITCH CONTROLS #3,4										
	SHORT	350	SHORT	1 MEG.		5F	5F	520		
V1F (6V7G) I.C. AF I.C. ON-OFF SWITCH CONTROLS #3,4										
	SHORT	122,000	470,000	SHORT		5F	5F	3000		25,400
VBA (6V6G) B OUTPUT B ON-OFF SWITCH CONTROLS #3,4,7 I.C. ON-OFF SWITCH CONTROLS #7										
RECEIVE		5F	220	SHORT	1 MEG.			1300		
TRANSMIT								350		
V1E (6V7G) B AF B ON-OFF SWITCH CONTROLS #3,4,7 I.C. ON-OFF SWITCH CONTROLS #7										
RECEIVE		5F	122,000	470,000	SHORT			3000		122,000 G
TRANSMIT										25,400

TABLE XVI (Cont'd)

	1	2	3	4	5	6	7	8	9	10
V1D (5V7G) QUENCH OSCILLATOR B ON-OFF SWITCH CONTROLS #2,3,4 I.C. ON-OFF SWITCH CONTROLS #2										
RECEIVE		SHORT	39,000	50,300	SHORT		5F	SHORT		47,000
TRANSMIT			840	OPEN						
V7A (E114B) DETECTOR OSCILLATOR B ON-OFF SWITCH CONTROLS #3										
RECEIVE			5F					SHORT		20,000
TRANSMIT										205,000
V4A (807) POWER AMPLIFIER A ON-OFF SWITCH CONTROLS #1										
RECEIVE		SHORT	44,000	115,000	62,000					205,000
TRANSMIT R/T			100K	100K	SHORT	30				15,000
TRANSMIT CW			51,000	113,000						
TRANSMIT HCW			100	100						
V5A (EF 50) DRIVER A ON-OFF SWITCH CONTROLS #1										
RECEIVE		SHORT	48,000	44,000						30
TRANSMIT RT			51,000	2,200-2						
TRANSMIT CW			51,000K	2,200K						
TRANSMIT HCW			51,000	2,200						
V5A (6V5) DRIVE LIMITER AND RECTIFIER A ON-OFF SWITCH CONTROLS #2										
RECEIVE		SHORT	470,000	73,000	290,000		30	65,000		
TRANSMIT								SHORT		
V2A (58B6) DEMODULATOR, AVC, AF OSCILLATOR A ON-OFF SWITCH CONTROLS #3,6										
RECEIVE		30	500	1 MEG.				SHORT		1 MEG. G
TRANSMIT RT			OPEN	OPEN				4,300		6,500
TRANSMIT CW			200K	200K						OPEN
TRANSMIT HCW										50,300

TABLE XVI (Cont'd)

	1	2	3	4	5	6	7	8	9	10
V1C (5M76) 2ND 1.F. A ON-OFF SWITCH CONTROLS #2,3,4										
RECEIVE TRANSMIT		SHORT	2,200	82,000	SHORT		30	270		3 MEG. 1 MEG. AVC
V1B (5M76) 1ST 1.F. A ON-OFF SWITCH CONTROLS #3,4										
RECEIVE TRANSMIT		30	5-2	27,300	SHORT		SHORT	1000		3 MEG.
V2A (5M85) MIXER A ON-OFF SWITCH CONTROLS #3,4,5										
RECEIVE & TRANSMIT		30	2,200	11,000	47,000	47,000	SHORT	270		10,000-2
V1A (5M76) R.F. A ON-OFF SWITCH CONTROLS #3,4										
RECEIVE TRANSMIT		30	2200-2	27,300	SHORT		SHORT	220	220	3 MEG.
V2B (5M85) NET OSCILLATOR AND TRANSMIT MIXER										
RECEIVE RT		30	44,000	22,000	47,000	47,000	SHORT	220		100,000
RECEIVE CW					47,000	47,000				
RECEIVE MCW					47,000	47,000				
TRANSMIT RT			2,200-2	11,000		47,000				
TRANSMIT CW				11,000K		47,000				
TRANSMIT MCW			2200	11,000						

TABLE XVI (Cont'd)

TAP ON ANT. COIL	.01	POINT-TO-POINT CHECKS
B ANT SOCKET	470	30 MAF TO 100 MAF AT OSC. COILS
A ANT SOCKET CW	28,000	FROM DUMMY LUG TO DUMMY LUG ON OSC. COILS
METER BOARD TAP	100,000	RESISTOR BOARD L4 TO GRID 807 (READS R7D)
" " " BROWN	1.2 MEG.	CUNENCH OSC. COIL L4 (L14A)
" " " RED-BLACK	1.2 MEG.	RESISTOR BOARD L4 TO GRID 807 (READS R7D)
" " " RED	OPEN	NET OSC. GRID TO 30 MAF (READS RA2C)
OSC. & DRIVER SECTIONS OF GANG	747,000	
OSCILLATOR BOARD	100,000	
RESISTOR BOARD L5	10,000	
RESISTOR BOARD TOP CENTER	150	
RESISTOR BOARD L5		
		220-620
		12
		100,000
		10,000



PHOTO 1—FRONT VIEW OF SET AND SUPPLY UNIT

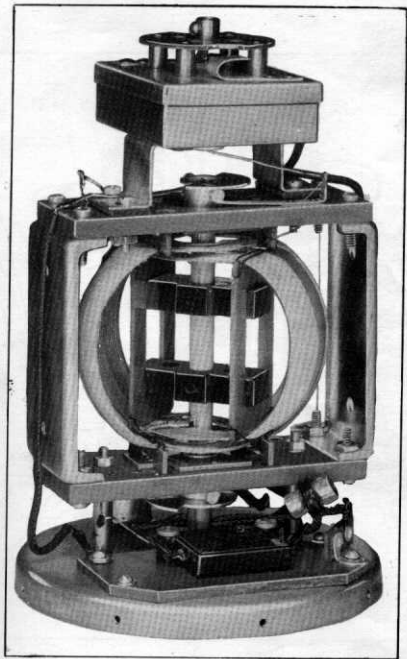

PHOTO 2—INSIDE VIEW OF VARIOMETER

INDEX TO INSTALLATION KIT CRUSER TANK RAM I & II

ITEM REF.	DESCRIPTION	ITEM REF.	DESCRIPTION
1	Aerial Base No. 9 Mtg. No. 1	14	Case, Spare Valves
2	Aerial Base No. 9	15	Junction Distribution No. 3
3	Aerial Rod "G"	16	Connector 6 Pt. No. 12A
4	Connector 12 Pt. No. 4 C	17	Carrier, No. 1
5	Aerial Variometer Mk. II	18	Microphone & Receiver Headgear
6	Plates Packing No. 1	19	Wiring Diagram Plate No. 191
7	Aerial Base No. 8	20	Supply Unit No. 2
8	Aerial Base No. 8 Mtg. No. 3	21	Connector 12 Pt. No. 3 B
9	Aerial Feeder Assembly No. 5	22	Case, Spare Parts No. 5C
10	Leads, Aerial No. 1	23	Sender Receiver (Canadian) Mk. III
11	Connector, Single No. 193	24	Control Unit No. 2 Mk. II
12	Control Unit No. 1 Mk. II	25	Leads, Aerial No. 2
13	Cover, Waterproof, No. 1		

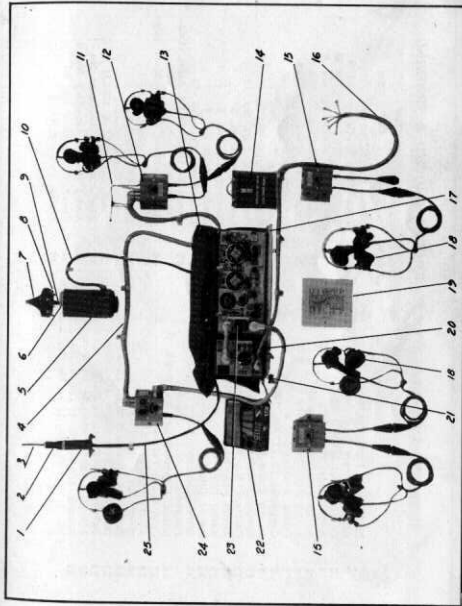

PHOTO 3—INSTALLATION EQUIPMENT FOR RAM II

INDEX TO INSTALLATION KIT—TRUCKS, GROUND & TRAINING

ITEM
REF.

DESCRIPTION

- 1 Case, Spare Parts, No. 5C
- 2 Kits, Hardware
- 3 Control Unit No. 3B Mk. II
- 4 Aerial Base No. 9 Mtg. No. 1
- 5 Aerial Variometer Mk. II
- 6 Aerial Rod "P" Section
- 7 Plates, Seating No. 4
- 8 Connector 12 Pl. No. 1E
- 9 Supply Units No. 3
- 10 Sender Receiver (Canadian) Mk. III
- 11 Carriers, No. 3
- 12 Aerial Base No. 8 Mtg. No. 3
- 13 Aerial Rod "Q"
- 14 Set of Clips
- 15 Wireless Remote Control Units No. 1 (Canadian)
- 16 Leads, Counterpoise, No. 2 Mk. II
- 17 Case Spare Valves
- 18 Aerial Base No. 9A
- 19 Microphones Hand No. 3
- 20* Receivers Headgear M.C. (Canadian)
- 21 Lamps, Operator No. 6 (Canadian)
- 22 Switchboards Charging No. C5 (Canadian)
- 23 1/6 Mile Cable, Electric D3 Twisted
- 24 Aerials, 250 ft. No. 1, 185 ft. No. 1, 150 ft. No. 2, 110 ft. No. 1, 90 ft. No. 1 and 70 ft. No. 1

ITEM
REF.

DESCRIPTION

- 25 Leads, Earth, No. 2
- 26 Connectors, Single No. 24 B
- 27 Connectors, Single No. 24 C
- 28 Connectors, Single No. 24 A
- 29 Connectors, Single No. 24
- 30 Connectors, Single No. 23A
- 31 Connectors, Single No. 23
- 32 Connectors, Twin No. 77
- 33 Leads, Jumper No. 1
- 34 Connectors, 4 Pl. No. 33
- 35 Leads, Aerial No. 5
- 36 Carriers Mtg. No. 1
- 37 Leads, Aerial No. 3
- 38 Connectors, Twin No. 53
- 39 Aerial Vertical, 34 C4. Steel (Can. Telescopic)
- 40 Mast, Vertical, 20 ft. Steel (Can. Telescopic)
- 41 Bags, Aerial Gear
- 42 Leads, Earth No. 3
- 43 Reels, Cable No. 2 Mk. II
- 44 Micro. & Rec. Headgear No. 1
- 45 Aerial Feeder Assembly No. 9
- 46 Grommets, Rubber No. 23
- 47 Plates, Packing No. 2

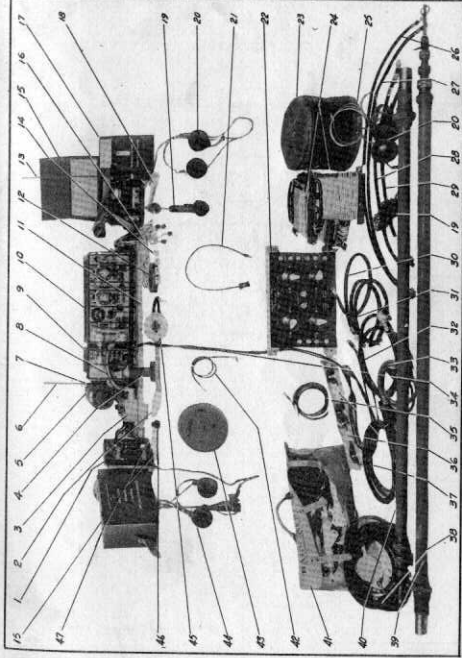

PHOTO 4—INSTALLATION EQUIPMENT FOR GROUND TRUCK STATION

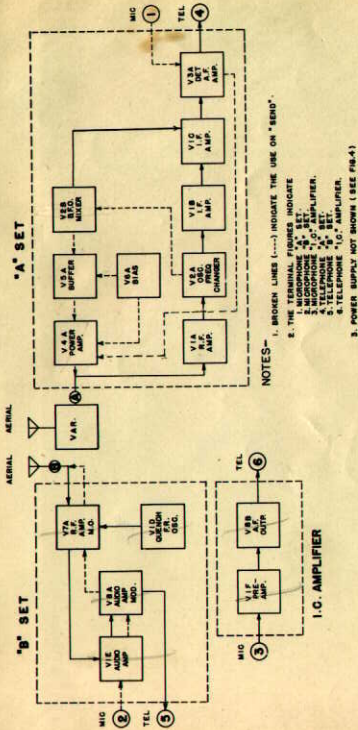
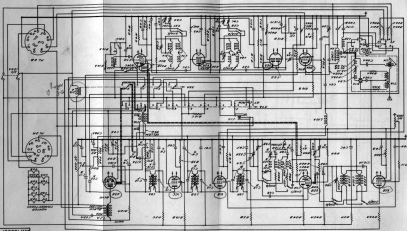

FIG.3 - BLOCK DIAGRAM OF SENDER RECEIVER

1. 100% TESTED
 2. 100% GUARANTEED
 3. 100% ORIGINAL
 4. 100% AUTHENTIC
 5. 100% GENUINE
 6. 100% REAL
 7. 100% TRUE
 8. 100% FACT
 9. 100% TRUTH
 10. 100% JUSTICE

1. 100% TESTED
 2. 100% GUARANTEED
 3. 100% ORIGINAL
 4. 100% AUTHENTIC
 5. 100% GENUINE
 6. 100% REAL
 7. 100% TRUE
 8. 100% FACT
 9. 100% TRUTH
 10. 100% JUSTICE

1. 100% TESTED
 2. 100% GUARANTEED
 3. 100% ORIGINAL
 4. 100% AUTHENTIC
 5. 100% GENUINE
 6. 100% REAL
 7. 100% TRUE
 8. 100% FACT
 9. 100% TRUTH
 10. 100% JUSTICE



6800-K-10

