

# Assembly Manual

## UHF Power Amp (50 watt)

## K-6307

**DICK SMITH**  
**ELECTRONICS**

PTY LTD

## K I T

PLEASE READ DISCLAIMER CAREFULLY AS WE  
CAN ONLY GUARANTEE PARTS AND NOT THE  
LABOUR CONTENT YOU PROVIDE

Reproduced in part by arrangement with Australian Electronics  
Monthly, from their December 1986 Edition.

Many UHF transceivers have an output in the 2W to 10W range. This amplifier will lift a 2W output rig to the 50W level and may be used with CW, FM and SSB modes. It features a 10MHz bandwidth, harmonics better than 60dB down and 12Vdc operation for mobile or home use.

OPERATION on the 70 cm amateur band (420-450 MHz) has grown considerably in popularity over the past decade, with the principal activity lying between 432 MHz and 440 MHz; SSB (and a little CW) operation between 432 and 433 MHz, and FM operation (much of it mobile using repeaters) above that.

One thing you learn very quickly about working on 70 cm and that is there's no substitute for power — whether it be plain old brute force RF or effective radiated power from a

gain antenna. With mobile operation, there's a physical limit to the size of antenna you can mount on a vehicle, so your range is effectively governed by the amount of RF watts you put 'up the stick'. Hence this project.

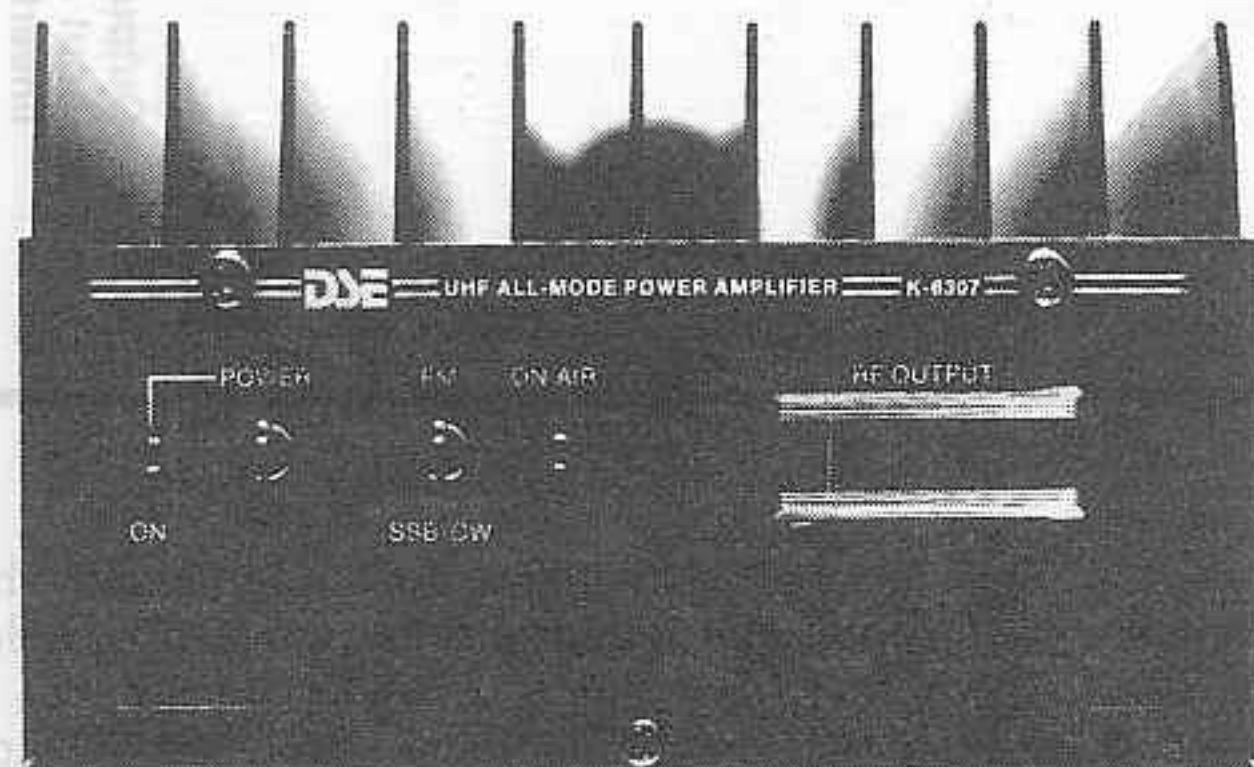

View of the front panel (above) and internal view of the completed project. Input socket is on the left, output on the right. Note the RF output meter at top right.

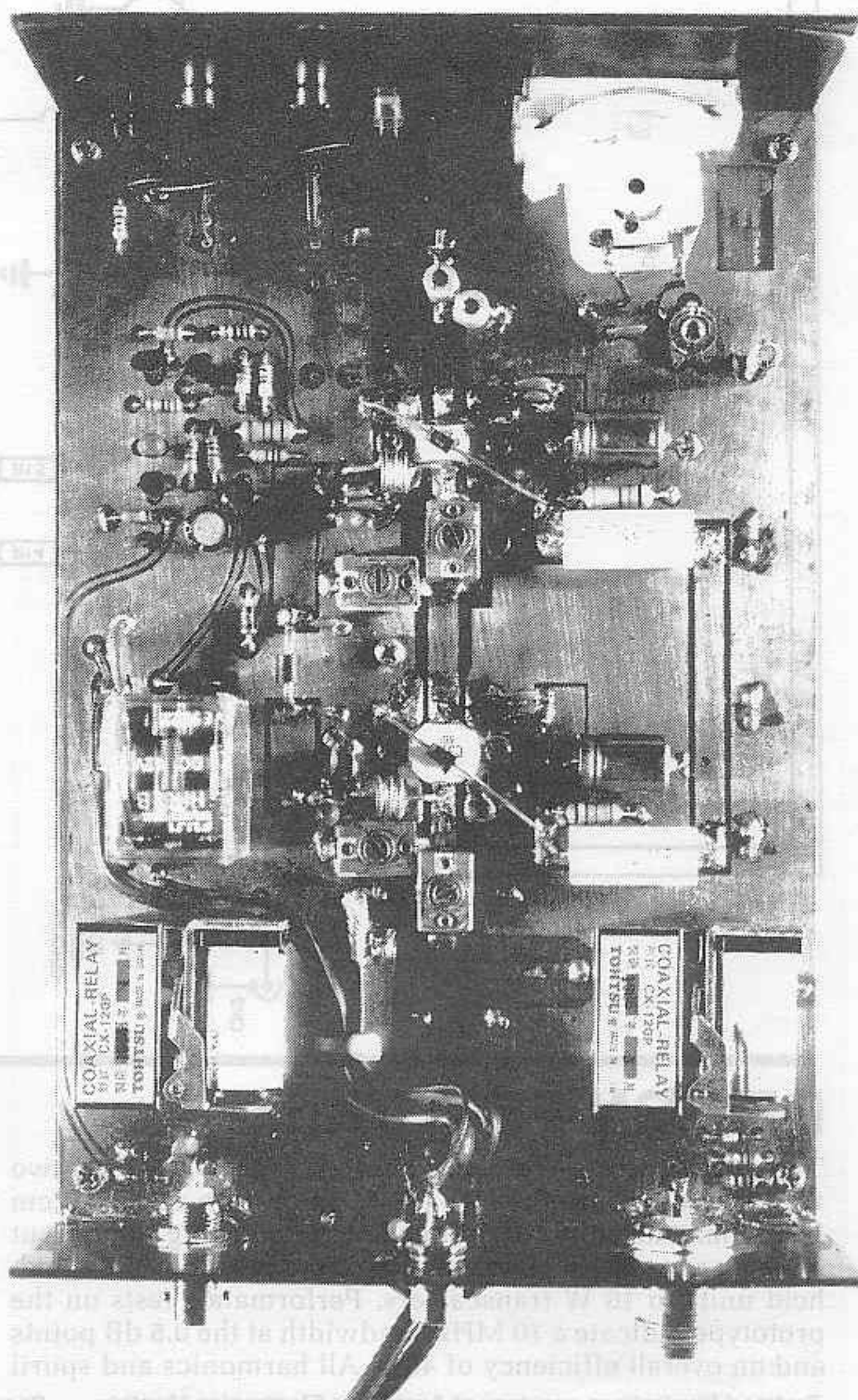



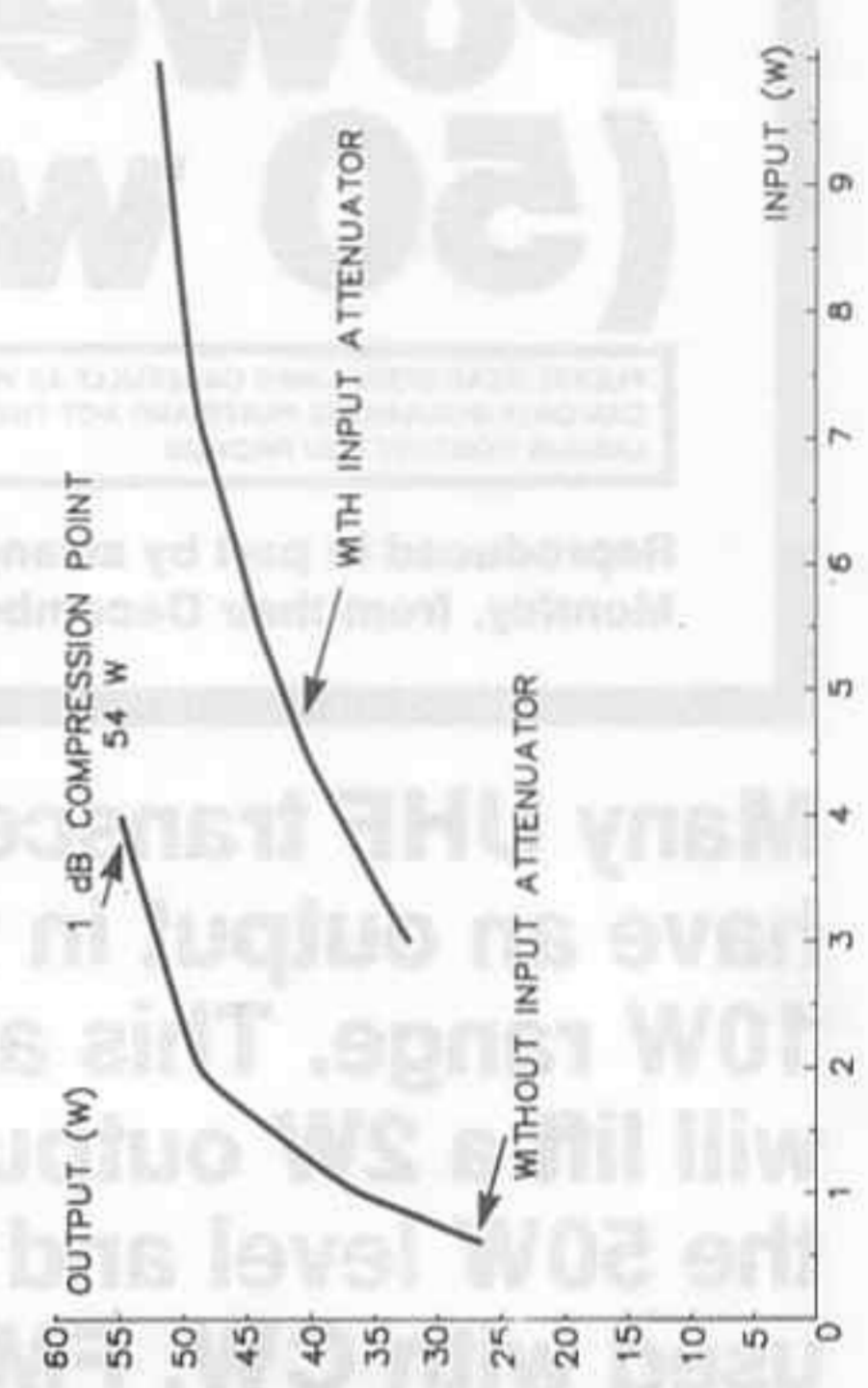
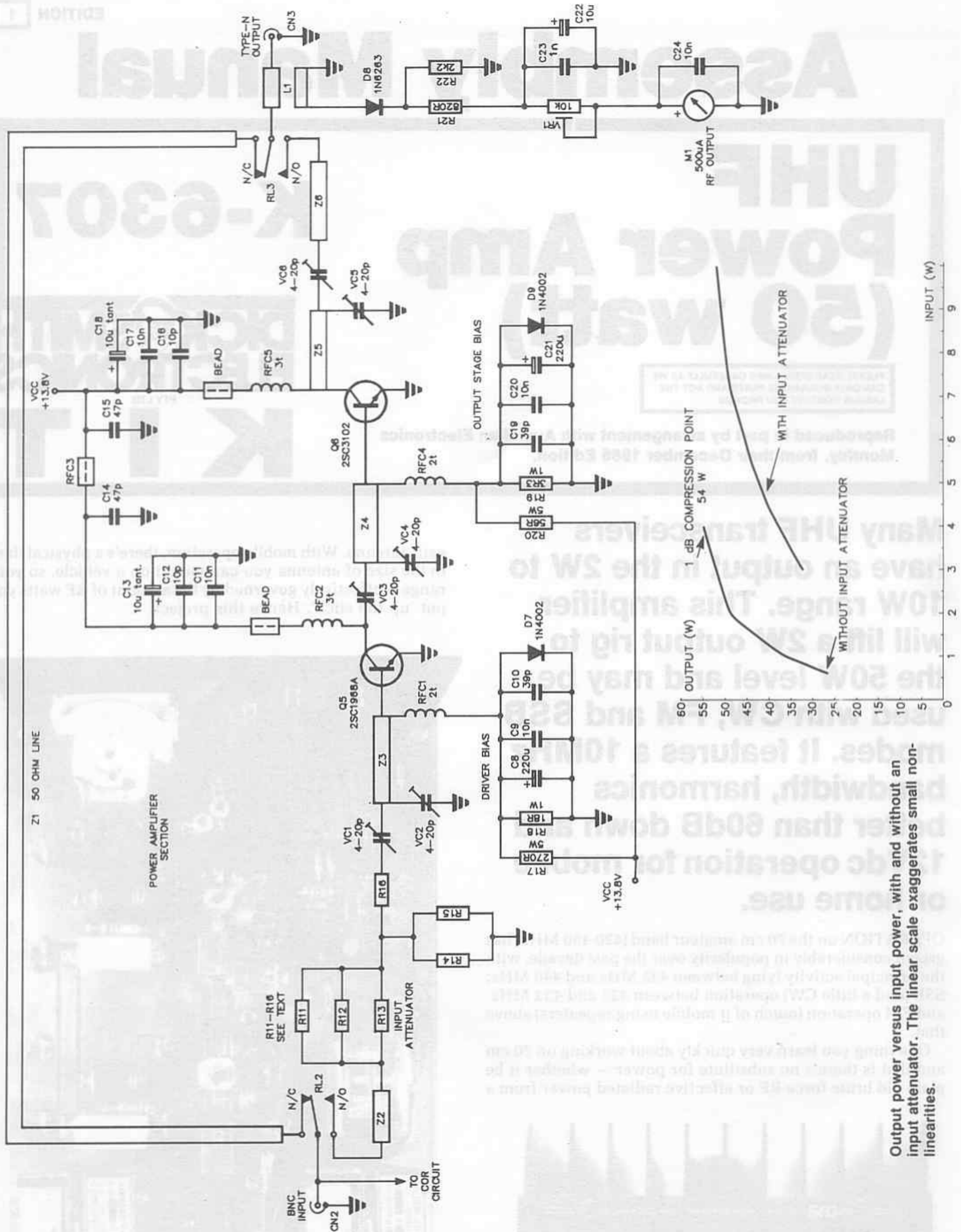

Output power versus input power, with and without an input attenuator. The linear scale exaggerates small nonlinearities.

## DESIGN FEATURES

The project provides a typical output of 50 watts for a two watt input drive in the 430-440 MHz portion of the 70 cm UHF amateur band. It is intended for boosting the output of exciters or transceivers ranging from low-powered handheld units to 10 W transceivers. Performance tests on the prototype indicate a 10 MHz bandwidth at the 0.5 dB points and an overall efficiency of 40%. All harmonics and spuri

measured a minimum of 60 dB below the fundamental, while third-order intermodulation (imd) products measured below -35 dB.

Two Mitsubishi RF power devices, a 2SC1968A and a 2SC3102, are cascaded to provide a gain of 14 dB. Both devices are biased in class AB to ensure suitable linearity for SSB operation. A simple diode-drop scheme was chosen



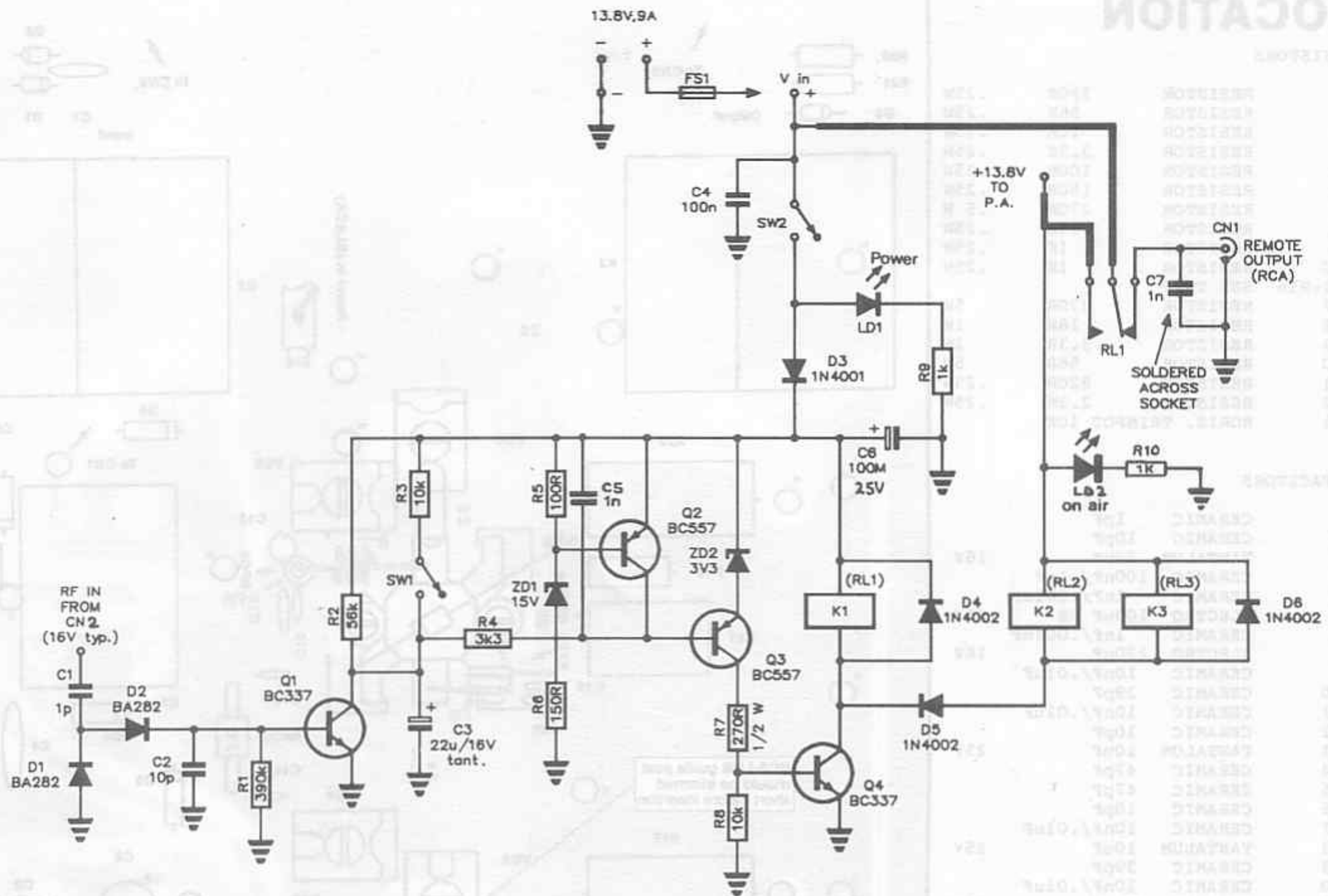

## CHANGE-OVER AND PROTECTION CIRCUIT.

to simplify the circuitry and construction. Circuit board transmission line matching techniques were selected for their inherent low loss and ease of reproduction. The output device is capable of withstanding load mismatches of 20:1. Input VSWR is typically less than 1.2:1 and the insertion loss in the bypass mode measured less than 0.9 dB.

The front panel incorporates a power switch, a switchable between-syllable delay for SSB operation and a relative RF output power meter. Two LEDs provide power on and on-air indication. The input and output sockets are mounted on the back panel and an RCA socket provides a switched +12 V output for a masthead preamp.

### CIRCUIT OPERATION

There are two separate sections to the project's circuitry, the amplifier and the "carrier detect" change-over and protection ("cor") circuit.

#### THE AMPLIFIER

When the unit is switched off, a transmit signal applied to the input socket is routed to the output via the normally-closed (N/C) contacts of the coaxial relays K2 and K3, and the 50 ohm transmission line Z1. This is the "bypass" condition. On reception, signals from the antenna are passed to the receiver in the opposite direction.

When the unit is switched on, it is in the "standby" mode. An applied input signal is sensed by the carrier detect circuit which energises relays K1 to K3, routing the transmit RF signal to the input of the driver stage, Q5. A length of 50 ohm transmission line on the pc board, Z2, completes the path from the K2 contacts (RL2) to the amplifier input.

The 2SC1968A device has a power gain of about 7.0 dB at 435 MHz when powered from a 13.8 V supply. Assuming a 0.2 dB insertion loss in the matching networks, the second (output) stage will be driven with about 9 W for a 2 W input drive. A typical power gain figure for the 2SC3102 device is 7.5 dB. Again, assuming 0.2 dB losses each in the matching networks and the contacts of K3 (RL3), output will be about 47 W.

On the output, L1 (tracks on the pc board) along with D8, R21, R22, C22 and C23 form a directional coupler to indicate relative power output, driving the front panel metering circuit M1, VR1 and C24.

### CARRIER DETECT & CHANGE-OVER

When the unit is turned on, C3 charges to the supply voltage via R2. When you press the microphone button on your transceiver, a small portion of the input RF signal is coupled off via C1 and rectified by diodes D1 and D2. These diodes were selected for their fast switching times. The positive going pulses turn on Q1, discharging C3 and allowing Q3 to conduct. When the current through the potential divider comprised of R7 and R8 exceeds approximately 60  $\mu$ A Q4 will also turn on, energising relay K1 which supplies dc power to the main amp and the coils of the RF switching relays, K2 and K3. This is the "on-air" mode.

When you release the microphone button, Q1 is biased off by R1 allowing C3 to charge up via R2 when the front panel mode switch is selected for SSB/CW operation (long delay). C3 will be charged up by both R2 and R3 when the mode switch is set for FM operation (short delay). The required SSB delay with these components is about 1.5 seconds. This time can be reduced or lengthened if desired by changing the value of R2.

The turn-off threshold for Q3 is about 9.3 volts for a 13.8 volt rail. So when C3 charges up to about 63% of its final value Q3 and Q4 will turn off releasing the relays K1-K3. The unit is now in the standby condition.

Q2, ZD1, R5 and R6 form an overvoltage sense and shut down circuit. When a supply rail in excess of 17 volts is applied and SW2 is turned on, ZD1 will conduct turning on Q2 and holding Q3 off. Dangerous supply potentials which would have otherwise destroyed Q1 and Q2 from over-dissipation are thus prevented from being switched to these devices.



# COMPONENT LOCATION

## RESISTORS

R1	RESISTOR	390K	.25W
R2	RESISTOR	56K	.25W
R3	RESISTOR	10K	.25W
R4	RESISTOR	3.3K	.25W
R5	RESISTOR	100R	.25W
R6	RESISTOR	150R	.25W
R7	RESISTOR	270R	.5 W
R8	RESISTOR	10K	.25W
R9	RESISTOR	1K	.25W
R10	RESISTOR	1K	.25W
R11-R16	SEE TEXT		
R17	RESISTOR	270R	5W
R18	RESISTOR	18R	1W
R19	RESISTOR	3.3R	1W
R20	RESISTOR	56R	5W
R21	RESISTOR	820R	.25W
R22	RESISTOR	2.2K	.25W
VR1	HORIZ. TRIMPOT	10K	

## CAPACITORS

C1	CERAMIC	1pF	
C2	CERAMIC	10pF	
C3	TANTALUM	22uF	16V
C4	CERAMIC	100nF/.1uF	
C5	CERAMIC	1nF/.001uF	
C6	ELECTRO	100uF RB	25V
C7	CERAMIC	1nF/.001uF	
C8	ELECTRO	220uF	16V
C9	CERAMIC	10nF/.01uF	
C10	CERAMIC	39pF	
C11	CERAMIC	10nF/.01uF	
C12	CERAMIC	10pF	
C13	TANTALUM	10uF	25V
C14	CERAMIC	47pF	
C15	CERAMIC	47pF	
C16	CERAMIC	10pF	
C17	CERAMIC	10nF/.01uF	
C18	TANTALUM	10uF	25V
C19	CERAMIC	39pF	
C20	CERAMIC	10nF/.01uF	
C21	ELECTRO	220uF	16V
C22	ELECTRO	10uF RB	25V
C23	CERAMIC	1nF/.001uF	
C24	CERAMIC	10nF/.01uF	
VC1	TRIMCAP	4-20pF Murata	
VC2	TRIMCAP	4-20pF Murata	
VC3	TRIMCAP	4-20pF Compression (GMA-20-200/403)	
VC4	TRIMCAP	4-20pF Compression (GMA-20-200/403)	
VC5	TRIMCAP	4-20pF Compression (GMA-20-200/403)	
VC6	TRIMCAP	4-20pF Compression (GMA-20-200/403)	

## SEMI-CONDUCTORS

D1	DIODE	BA282,BA243,BA244
D2	DIODE	BA282,BA243,BA244
D3-D7	DIODE	1N4002
D8	DIODE	1N6263
D9	DIODE	1N4002
ZD1	ZENER DIODE	400mW 15V
ZD2	ZENER DIODE	1W 3.3V
LD1	RED LED	TL4213 5mm
LD2	GRN LED	TL4233 5mm
Q1	TRANSISTOR	BC337
Q2	TRANSISTOR	BC557
Q3	TRANSISTOR	BC557
Q4	TRANSISTOR	BC337
Q5	TRANSISTOR	2SC1968A
Q6	TRANSISTOR	2SC3102

# OVERLAY SHOWING BOTTOM BOARD COPPER

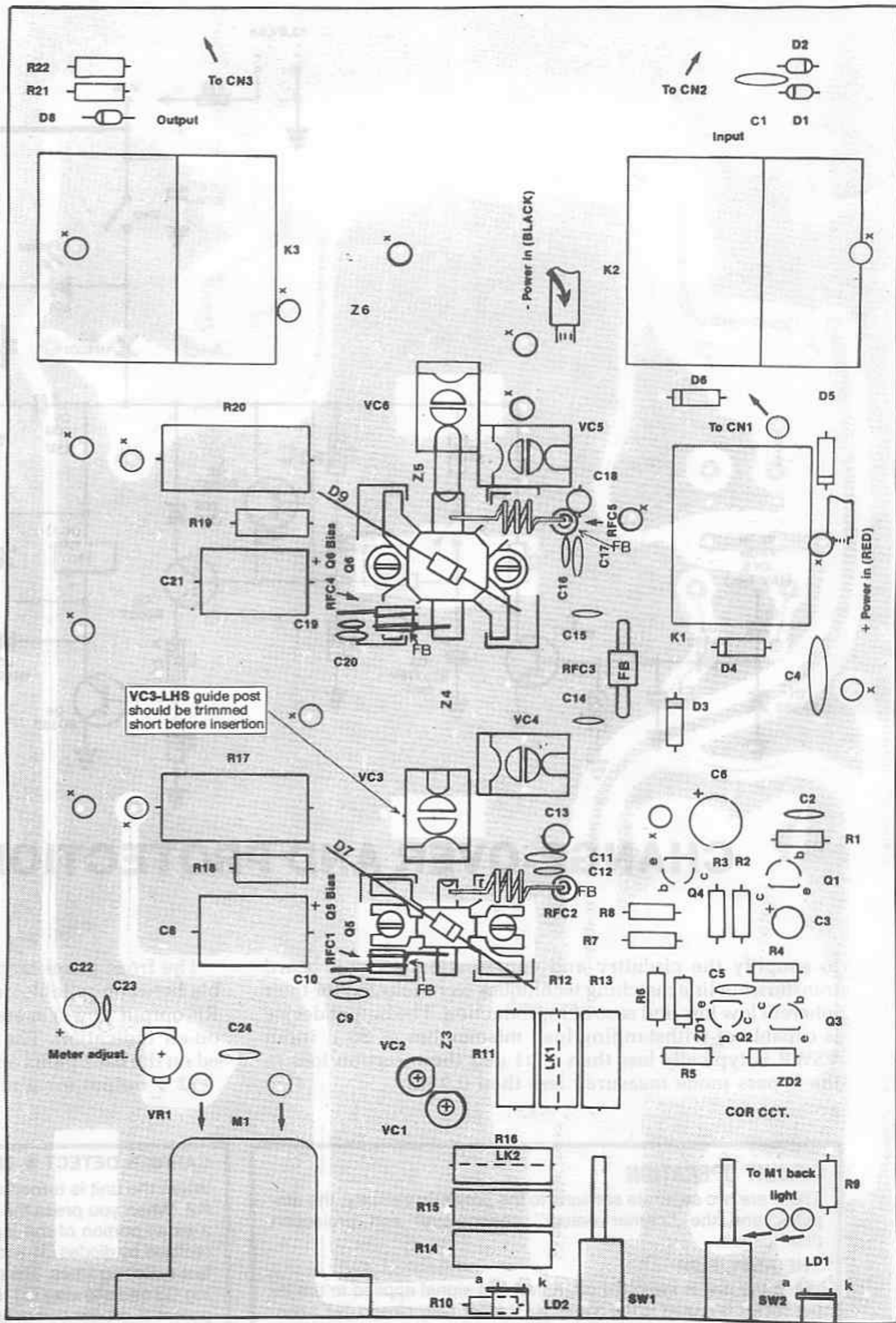

○ OR ○ - PCB Pins  
F/B - Ferrite Bead

The unit requires a nominal 12-13.8 Vdc supply capable of delivering 10 amps. Thus, it can be readily powered from a vehicle battery for mobile operation or from a common dc 'battery eliminator' bench supply.

Circuit board transmission line matching techniques were used for their inherent low loss and ease of reproduction. In fact, some comment about the matching networks is in order here. If you look at the circuit and the construction, you'll see that 'T-network' matching was used. This method

was chosen for several reasons. Firstly, it allows control over the circuit Q which the simpler L-network (commonly seen) does not. Secondly, practical component values are easily realised which means an economical choice of components may be made. A further major advantage is the circuit's ability to match over a wide range of complex impedances, thus providing allowance for normal production variations in transistor parameters and other nominal circuit tolerances.



# OVERLAY SHOWING TOP BOARD COPPER

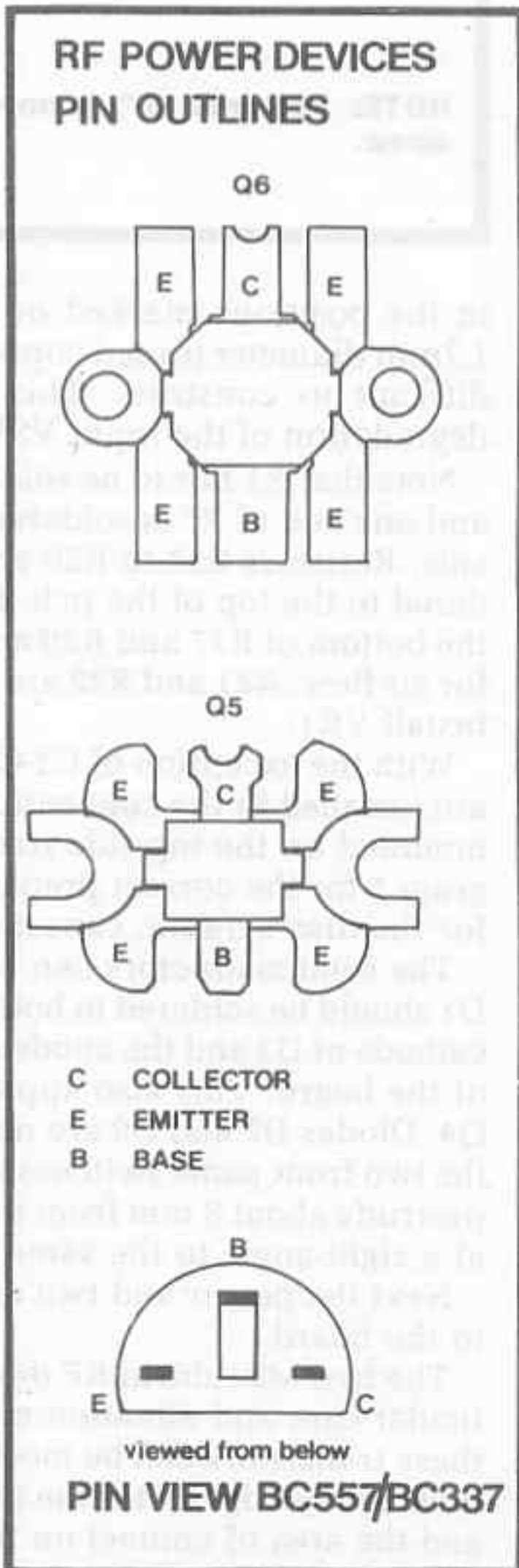
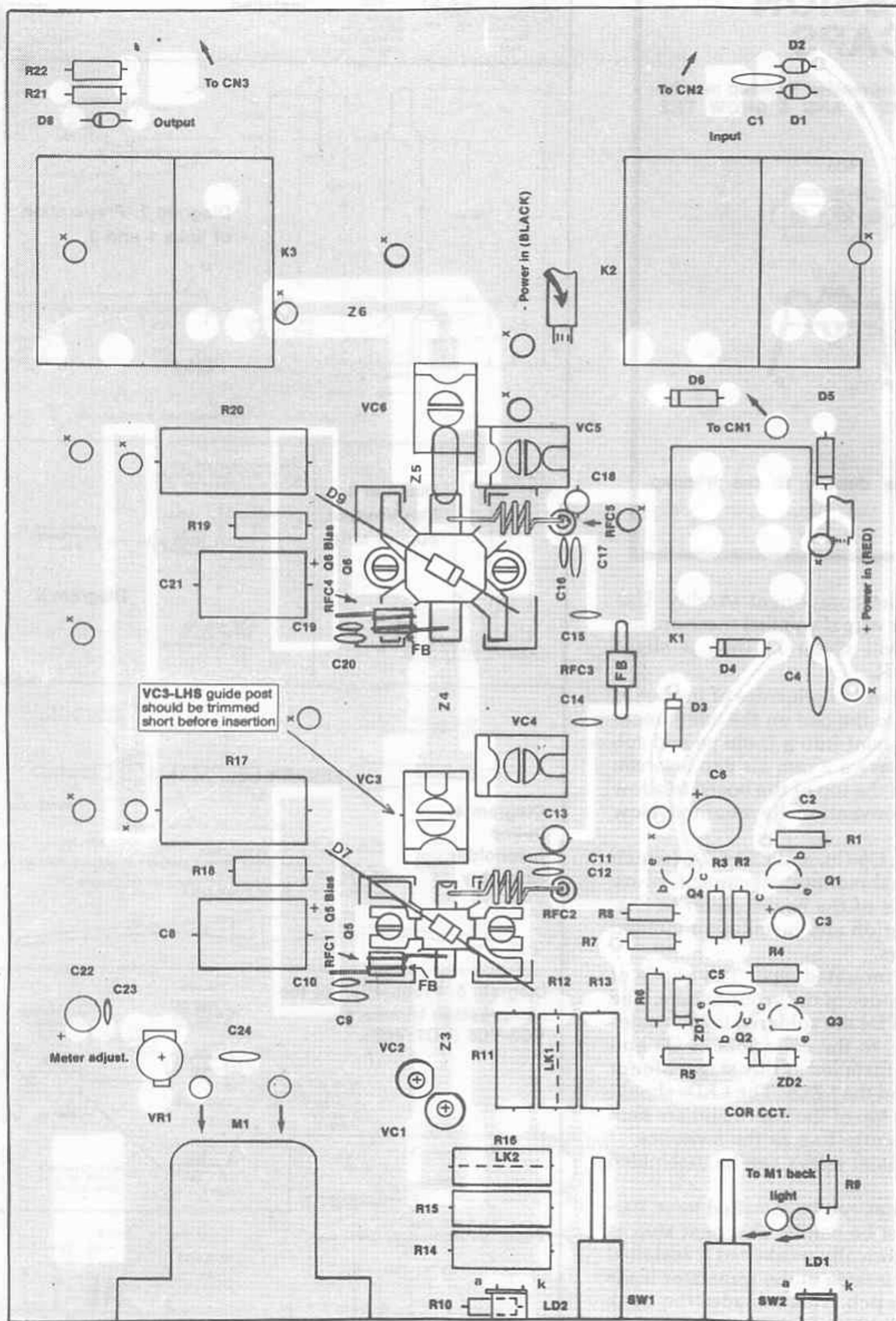

## Construction

All components are mounted on a double-sided pc board measuring 199 mm by 134 mm. This is mounted on a black-anodised finned heatsink measuring 200 mm by 136 mm. The front and rear panels bolt onto the heatsink and an aluminium wrap-around lid completes the assembly.

Before the mounting of components can begin, copper shims are first installed onto the board. Prepare eight pieces of shim so that they are slightly smaller than the rectangular outlines on the pc board overlay and fold them around the Q5 and Q6 transistor cut-outs in the positions indicated on the overlay (see Fig. ). The undersides of the shims and the surface of the board should both be lightly tinned to ensure a good low impedance connection.

The holes marked with an X on the component overlay locate the positions where pcb pins are inserted. Solder to both sides of the board and cut the pins flush on both sides of the board. This improves the groundplane connections where large RF currents are present. Insert the other pcb pins at the locations marked with a circle. These are for wiring terminations.

Placement of the components can now begin. Install and solder all resistors. Please refer to the graph (Fig. 1) to determine if an Attenuator is required. If so, refer to "Input Attenuator Box" section for the correct values to use. If an attenuator is not required, prepare two lengths of copper strips as per Diagram 2 and insert in place of the attenuators



# COMPRESSION TRIMCAPS

Either a GMA20200 or a 403 Compression Trimcap may be supplied in the kit (DIAGRAMS 5 AND 6 SHOW THE GMA20200 STYLE TRIMCAP)

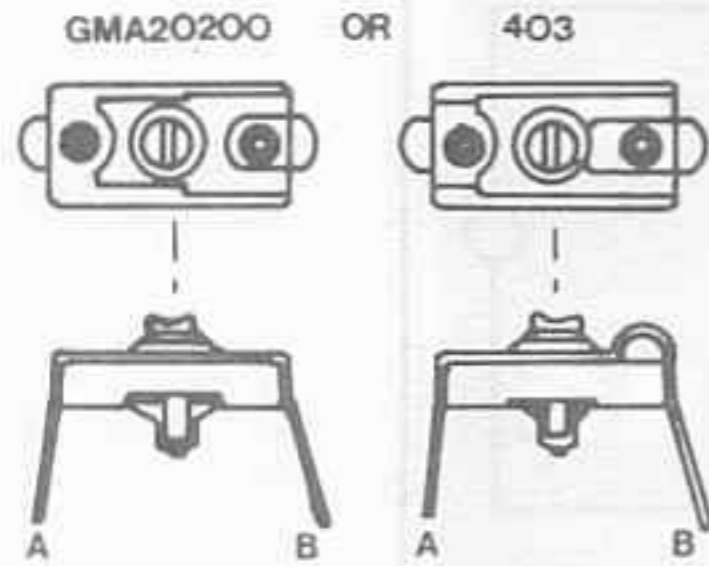

**NOTE:** Terminal "B" connects directly to the trimcap screw.

in the positions marked on the component overlay. Use 1.7mm diameter tinned copper wire if you feel these are too difficult to construct. This will result in only a slight degradation of the input VSWR.

Note that R1 has to be soldered to both sides of the board and one end of R7 is soldered to the pad on the component side. Resistors R17 to R20 are bent into a U-shape and soldered to the top of the pcb. Leave a 2 mm air gap between the bottom of R17 and R20 and the top of the board to allow for air flow. R21 and R22 are conventionally mounted. Now install VR1.

With the exception of C1-C3, C5-C6, and C22-C24, (which are installed in the conventional manner) all capacitors are mounted on the top-side tracks of the board. Refer to Diagram 1 for the correct preparation and installation method for the disc ceramic capacitors.

The semiconductors can be mounted next. The anode of D1 should be soldered to both sides of the groundplane. The cathode of D3 and the anode of D4 are soldered to both sides of the board. This also applies to the collectors of Q3 and Q4. Diodes D7 and D9 are not installed at this stage. Mount the two front panel switches and the LEDs. The LEDs should protrude about 8 mm from the top of the board and are bent at a right-angle to the same centre line as the switches.

Next the power and two coaxial relays can be assembled to the board.

The two Mitsubishi RF devices can be installed next. Particular care and attention must be paid to this next step as these transistors can be mechanically weakened if installed incorrectly. Lightly tin the underside of the transistor leads and the area of contact on the pcb. This includes the track which runs from VC6 to the collector of Q6. Place the devices into their respective positions as shown on the component overlay, but do **not** solder them in at this point in time. Put the pcb aside for the moment.

Using only a thin film of thermal compound, coat the two supplied aluminium plates at the areas of contact to the heat-sink and transistor bases. Referring to Diagram 9, align the large aluminium plate to the pre-tapped holes on the heat-sink. The smaller pre-drilled aluminium plate, 8 mm by 24 mm, is then aligned to the previously positioned plate as per the diagram. The larger plate allows a reasonable spacing between the bottom of the pcb and the top of the heatsink, thus preventing shorts and reducing proximity effects. The smaller rectangular piece offsets Q5 to allow for the difference in thickness (1 mm) between the mounting bases of the two RF devices. Referring to the positions on Diagram 9, locate the four 4BA brass nuts and the washers on the heat-

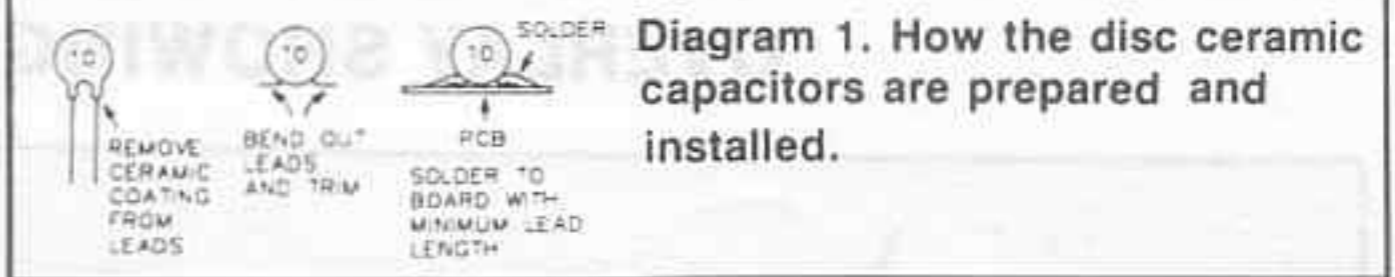

Diagram 1. How the disc ceramic capacitors are prepared and installed.

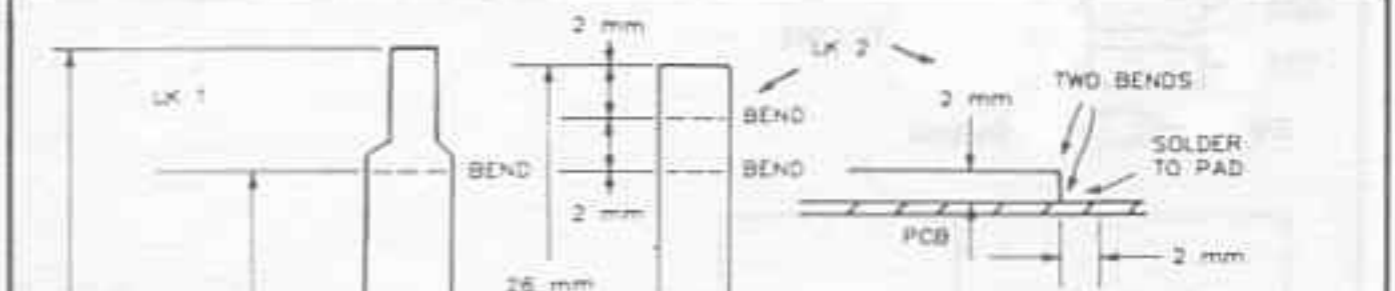

Diagram 2. Preparation of links 1 and 2.

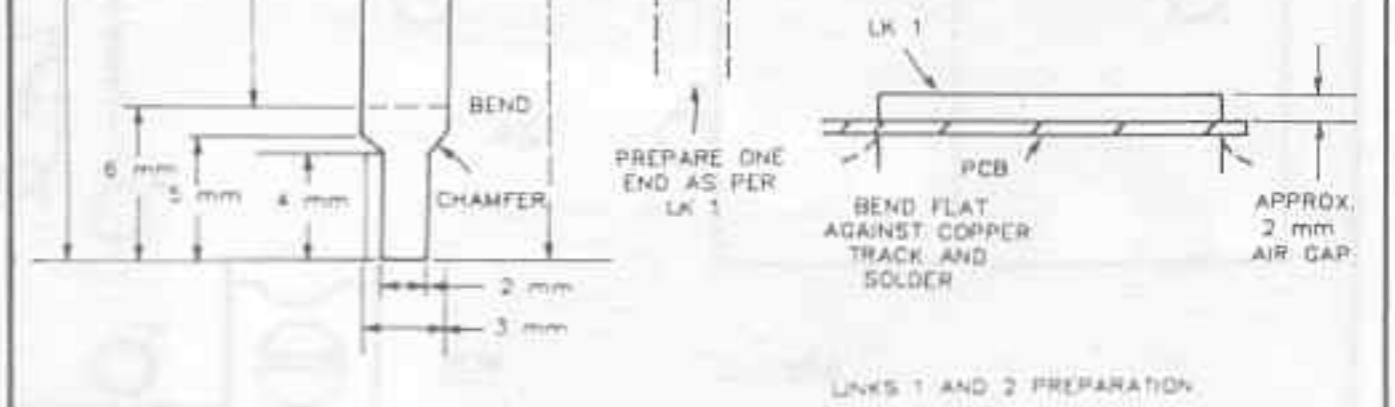

Diagram 3. Input/output copper strip.

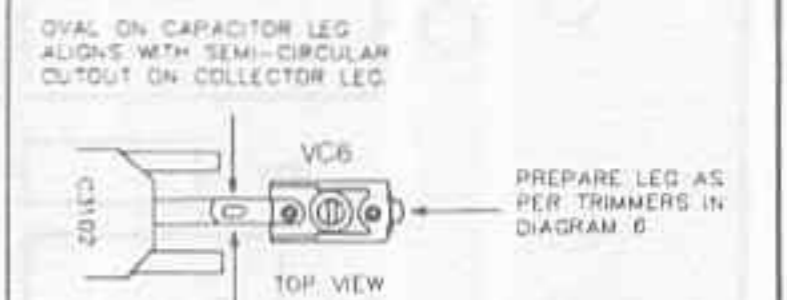

Diagram 5.

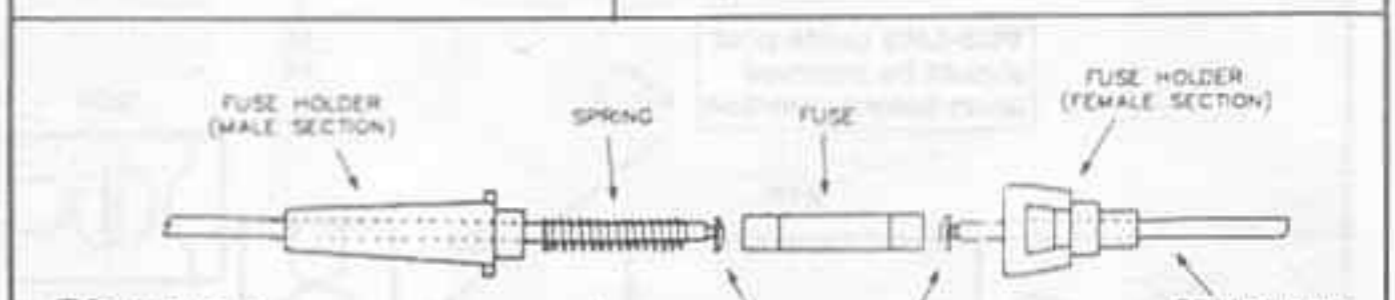

Diagram 4. In-line fuseholder assembly.

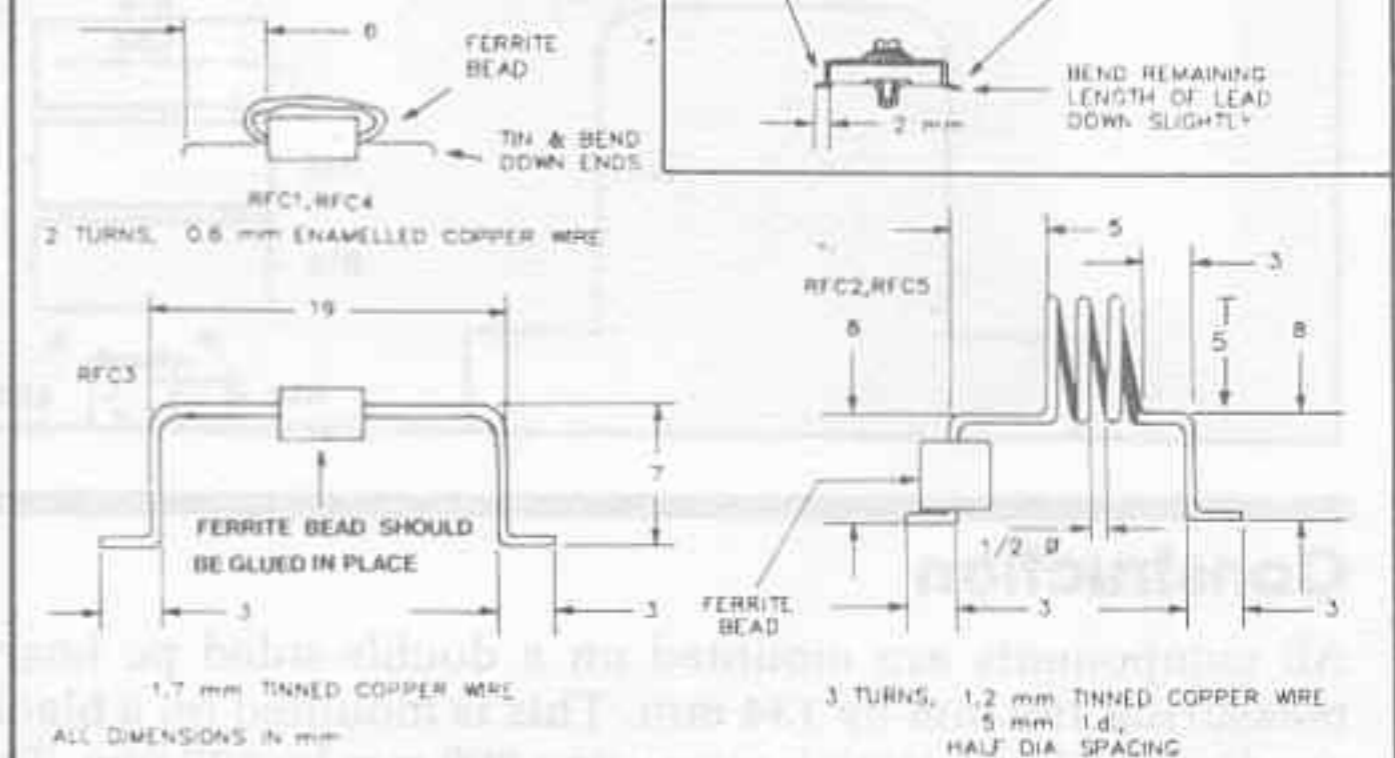
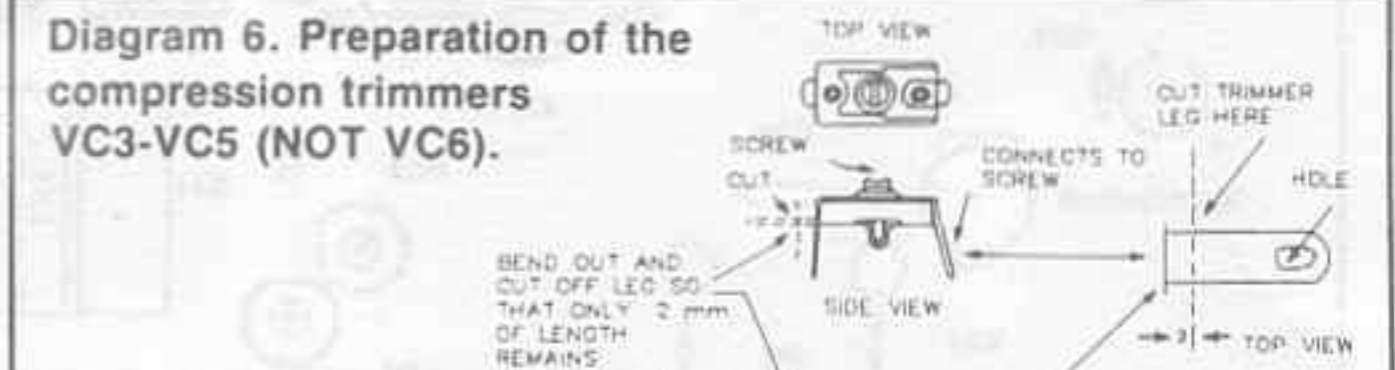
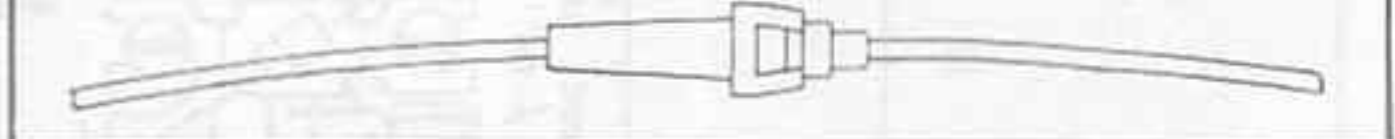

Diagram 8. Coil winding details (RF chokes RFC1-5).

sink. There are two flat washers and one shakeproof washer on each of the two hole locations on the aluminium plate. The shakeproof washer goes toward the aluminium, not the pcb.

Carefully place the pcb onto the heatsink-aluminium plate assembly and insert 3 mm machine screws into the 10 hole locations. Screw them in, but do not tighten down just yet. The board should run parallel to the edge of the heat-



sink with about 1 mm clearance around the sides and the front. The back of the pcb should be flush with the back of the heatsink. If the board overhangs due to a production tolerance it may be necessary to file the edge until it is flush. Bolt on the front panel and locate the meter on its marked position. The two switches and LEDs should then protrude through their respective holes. If everything is aligned, apply some contact adhesive to the top of the meter and glue in place with the flange of the meter butted against the back of the front panel. Terminate the four wires from the meter to their respective pcb pins.

With everything thus aligned, tighten-down the 10 previously inserted screws, ensuring first that the base and collector leads of Q5 and Q6 are aligned *exactly* to the striplines. The two power transistors should always be bolted down last and slackened off first. This is so that the devices never have to take the full support of the pc board. The transistor connections should lie reasonably flat to the plane of the pcb and not bend up or down. This is important as even a little stress on these devices can lead to their eventual destruction. With a soldering iron, run some solder around the edges of the transistor leads and 'sweat' the connections so that the solder on the underside melts.

The Q6 collector lead and the lead in connection for VC6 (not yet installed) form the transmission line for the output matching network. The copper track which runs from the collector of the output device (Q6) to compression trimmer VC6 is there to give the leads on the transistor and the trimmer something to bond to. Tin this track and sweat the collector lead to the copper surface while avoiding running excessive solder to the actual transistor lead if possible.

The trimmer capacitors are mounted next. Bend the leads out on VC1 and VC2 so that they are flush with the bottom surface and trim about 1.5 mm from the leads. Orientate as per the component overlay and solder in place. Bend and cut the lead connections in three only of the compression trimmers as per Diagram 6. Lightly tin the copper contact areas where the trimmers are to be positioned and solder them in place. The output compression trimmer (VC6) can now be installed. Firstly, prepare the trimmer as per Diagram 5 and tin the pad areas where it is to make contact. Insert the trimmer into the pre-drilled holes. Align the trimmer so that the hole in the uncut leg overlaps the semi-circular cutout on the transistor lead forming an oval. Use this hole to sweat the solder under the capacitor leg, thus avoiding running excessive solder onto the transmission line. Solder the other side of the capacitor to its copper pad.

Coat the tops of Q5 and Q6 with a thin film of silicone grease. Bend D7 and D9 into a U-shape and solder in place across the two transistors. There must be a tight physical connection between the bodies of the diodes and the transistors to ensure good temperature tracking when the unit is in operation.

Prepare the five RF chokes as per Diagram 8 and solder in place. The ferrite beads for RFC1 and RFC4 should be suspended slightly above the groundplane. Use only enough solder to make contact to the transistor connections.

Bolt the three sockets to the back panel. The input and output sockets should be tight enough so that they will not work loose when screwing connection cables on and off. Bolt to the heatsink using 1/2" x No. 6 self tapping screws.

With the pc board and back panel bolted to the heatsink, solder the two boards where they meet at a right angle, ensuring first that the main pcb is properly aligned. If there is a gap between the two boards it may not be possible to do this. If this situation occurs, run a length of tinned copper wire along the gap and bend over at both ends so that it is seated in place, parallel to both boards. It should be easier now to solder the two boards together. The underside of the pcb is also to be soldered to the rear panel, but this will be done at a later stage. Cut off the excess lengths of wire if necessary.

Next, prepare two lengths of 3 mm wide copper shims as per Diagram 3 and bend over at one end. Insert the bent ends into the holes of the input and output sockets and solder in

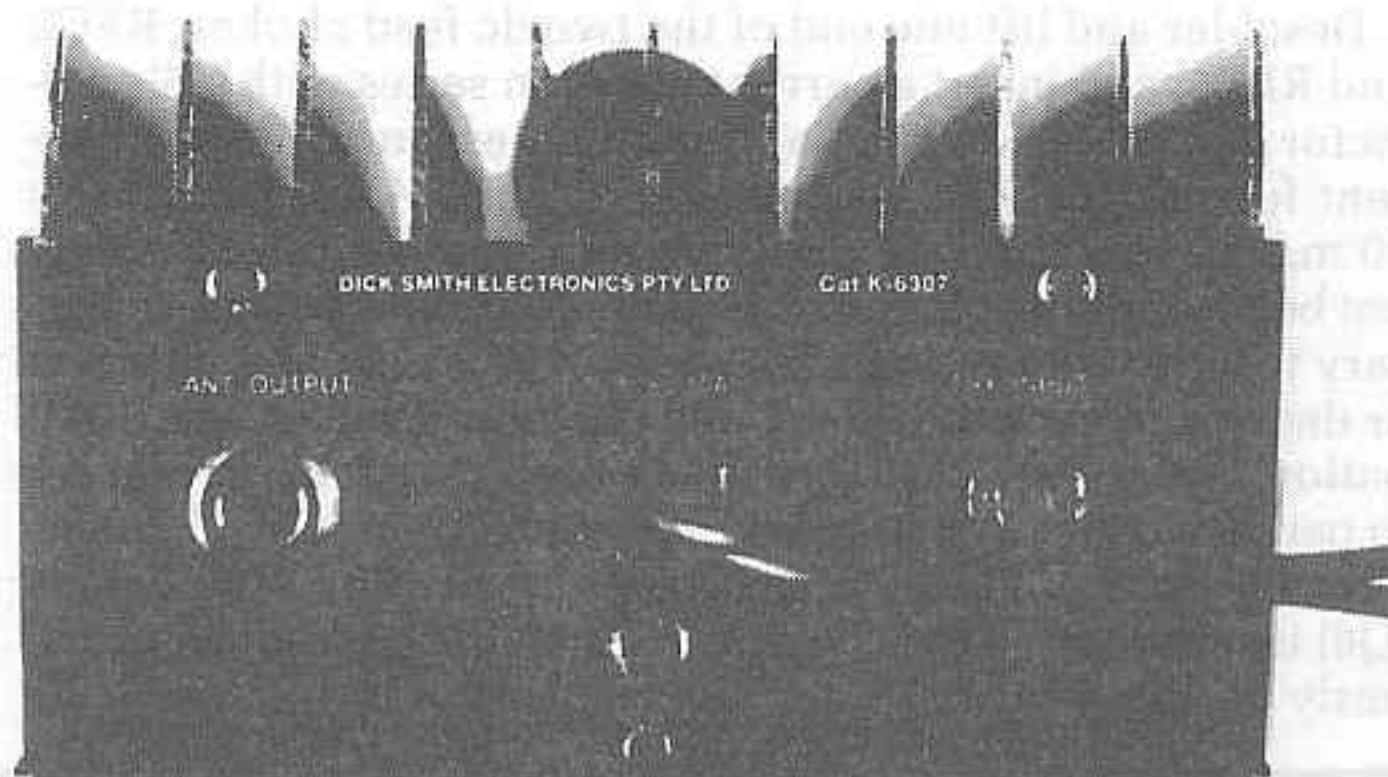

View of the rear panel. Note the "remote" output socket. this provides dc to a masthead preamp if required.

place. Insert the other ends of the copper strips into their respective holes on the main pcb.

Strip 10 mm of insulation from the ends of the red and black power cables then cut in the in-line fuseholder. (Refer to Diagram 4 for the correct preparation of the fuse holder assembly). Solder the leads to their indicated locations. Feed the power cables through the remaining hole in the back panel and retain using the captive grommet. Run a length of small gauge cable parallel to the red power cable. Terminate the ends of the smaller gauge cable to the RCA socket and the pcb pin. Solder C7 across the back of the RCA socket.

Remove the pcb/back panel from the heatsink and tie the three cables to the pc board with a cable tie.

Looking at the board from the bottom this time, solder to the back panel as previously outlined for the top of the board. The lugs which protrude through the pcb on VC4 and VC5 can also be soldered to the board, as well as the copper strip connections for the input/output sockets. This would be a good time to give the pcb a final inspection.

Reinstall the pcb to the heatsink, tightening down the transistor screws last. Bolt the front panel on and the unit is ready for powering up and alignment.

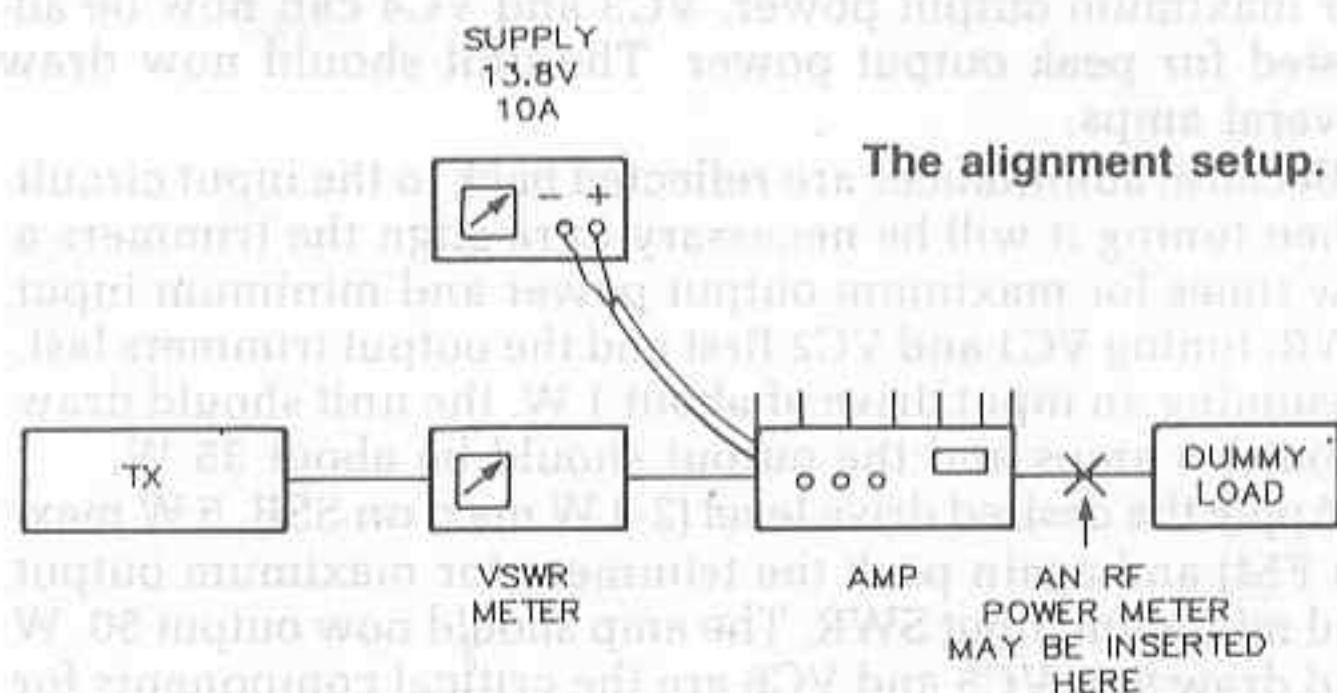

## Power-up and alignment

### Caution!

The following equipment is required to align the power amplifier:

- 12-13.8 Vdc 10 A power supply with current metering,
- UHF power/SWR meter, rated to 50 W or greater,
- 430 MHz-440 MHz exciter, adjustable from 0.5 W to 3 W,
- A 50 ohm dummy load,
- A multimeter, and
- A non-ferrous alignment tool.

Connect the amplifier to a supply voltage that will eventually be used to power the unit. The supply range is between +12 V and +13.8 V. Switch on. The relays should pull in momentarily and the current drain should be about 50 mA. The idle current of the two RF devices will be checked first. With an alligator clip, short the anode of D4 to ground so that the relays pull in. The amplifier should draw 500 mA. Remove power.



Desolder and lift one end of the two dc feed chokes, RFC2 and RFC5, and insert a current meter in series with Q5's collector and its choke. The optimum quiescent collector current for the 2SC1968A operating in class AB is nominally 20 mA. Owing to  $h_{FE}$  variations of the transistors, this may not be the reading obtained. In this situation it may be necessary to adjust the ratio of R17 to R18. R17 may be increased or decreased to optimise the idle current. If the power dissipation of the PW5 resistor is exceeded it will be necessary to parallel values by "stacking" resistors on top of each other. The optimum collector idle current for the 2SC3102 device (Q6) is nominally 150-200 mA. Adjust idle current as previously outlined for Q5.

## PRECAUTION

Before commencing the alignment, there are a few precautions that must be observed. Firstly, always use an insulated alignment tool when making adjustments. Secondly, keep your fingers away from the coils and the PC pattern to prevent RF burns. And thirdly, do not initially apply full drive to the amplifier, or damage may occur.

Reconnect the two feed chokes and alignment can begin.

It is desirable to begin tuning the amplifier with as low an input drive as possible and with reduced supply voltage. This is to reduce the possibility of damaging the transistors by operating at high power levels into a mis-matched load.

Connect a dummy load and power meter (if obtainable) to the output. If obtaining a suitable power meter is not practical, the RF power meter incorporated on the front panel is perfectly suitable for tuning the output power. Connect a suitable exciter and a VSWR meter to the input. Adjust VC1 and VC2 to mid-position and the four compression trimmers to about a quarter turn from tight. Apply an input drive level of between 0.5 W to 1 W and observe the input current. If the relays do not trip with this low level of input, enable the COR circuit by shorting the anode of D4 to ground. Adjust VC1 and VC2 for minimum input SWR. The unit should begin to draw some current at this stage. Peak VC5 and VC6 for maximum output power. VC3 and VC4 can now be adjusted for peak output power. The unit should now draw several amps.

Because admittances are reflected back to the input circuit when tuning it will be necessary to re-align the trimmers a few times for maximum output power and minimum input SWR. tuning VC1 and VC2 first and the output trimmers last. Assuming an input drive of about 1 W, the unit should draw about 7-8 amps and the output should be about 35 W.

Apply the desired drive level (2-3 W max. on SSB, 5 W max. on FM) and again peak the trimmers for maximum output and minimum input SWR. The amp should now output 50 W and draw 9 A. VC5 and VC6 are the critical components for obtaining maximum efficiency. Maximum efficiency is achieved by tuning for maximum RF output and minimum input current and is typically 40%. This can be calculated from the following formula:

$$\text{eff. (\%)} = \frac{P_{\text{out}}}{(V_{CC} \times I) + P_{\text{in}} (\text{drive})} \times 100$$

The temperature of the two input trimmers, VC1 and VC2 should be checked by feeling their cases to ensure the input is not being over driven. **Make sure no drive is applied or you might find out how painful RF burns can be!** Very little heat should be felt. Another indication of over-dissipation is that the trimmer tuning screws will begin to stiffen after a short period.

This completes the alignment procedure. Bolt the cover to the heatsink, attach the four rubber feet and the amplifier is ready for on-air testing. ●

## INPUT ATTENUATOR

For single sideband operation, the power input to the amplifier should be confined to 1-2 watts to ensure the amplifier maintains linearity. (On-air tests proved however that this could be exceeded somewhat without any reports of noticeable clipping.) This input level is compatible with most handheld/portable transceivers on the market, but the larger base/mobile rigs generally have an output somewhere between four and 10 watts. Six watts was considered a mean figure, so an attenuator to reduce 6 W to 1.5 W was required, a drop of 6 dB.

A "T" configuration was chosen:

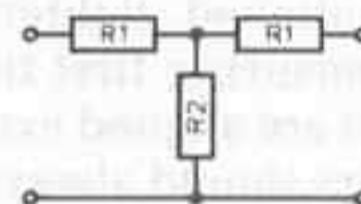

Referring to the *ITT Reference Data for Radio Engineers*, the following formulas apply:

$$R1 = Z[1 - 2/(K + 1)]$$

Where Z is the input/output impedance (50 ohms in this case),

$$\begin{aligned} K &= \sqrt{(P_{\text{out}}/P_{\text{in}})} \\ &= \sqrt{(6/1.5)} \\ &= \sqrt{4} \\ &= 2 \end{aligned}$$

therefore,

$$\begin{aligned} R1 &= 50[1 - 2/(2 + 1)] \\ &= 50[1 - 2/3] \\ &= 50/3 \\ &= 16.6 \text{ ohms} \end{aligned}$$

and,

$$\begin{aligned} R2 &= 2ZK/(K^2 - 1) \\ &= 2 \times 50 \times 2/(4 - 1) \\ &= 200/3 \\ &= 66.6 \text{ ohms} \end{aligned}$$

This gave the basis for some good ballpark figures and after some trial and error, the following values were chosen:

R11 to R13 = 39 ohms each (13 ohms results)

R14, R15 = 150 ohms (75 ohms results)

R16 = 12 ohms

Standard 1 W resistors are quite unsuitable at this frequency due to their self resonance and stray inductance effects. Thus, Allen-Bradley hot-moulded carbon composition resistors were chosen for their inherent low self-reactance.

As can be seen from the foregoing, the actual values come reasonably close to the calculated values.



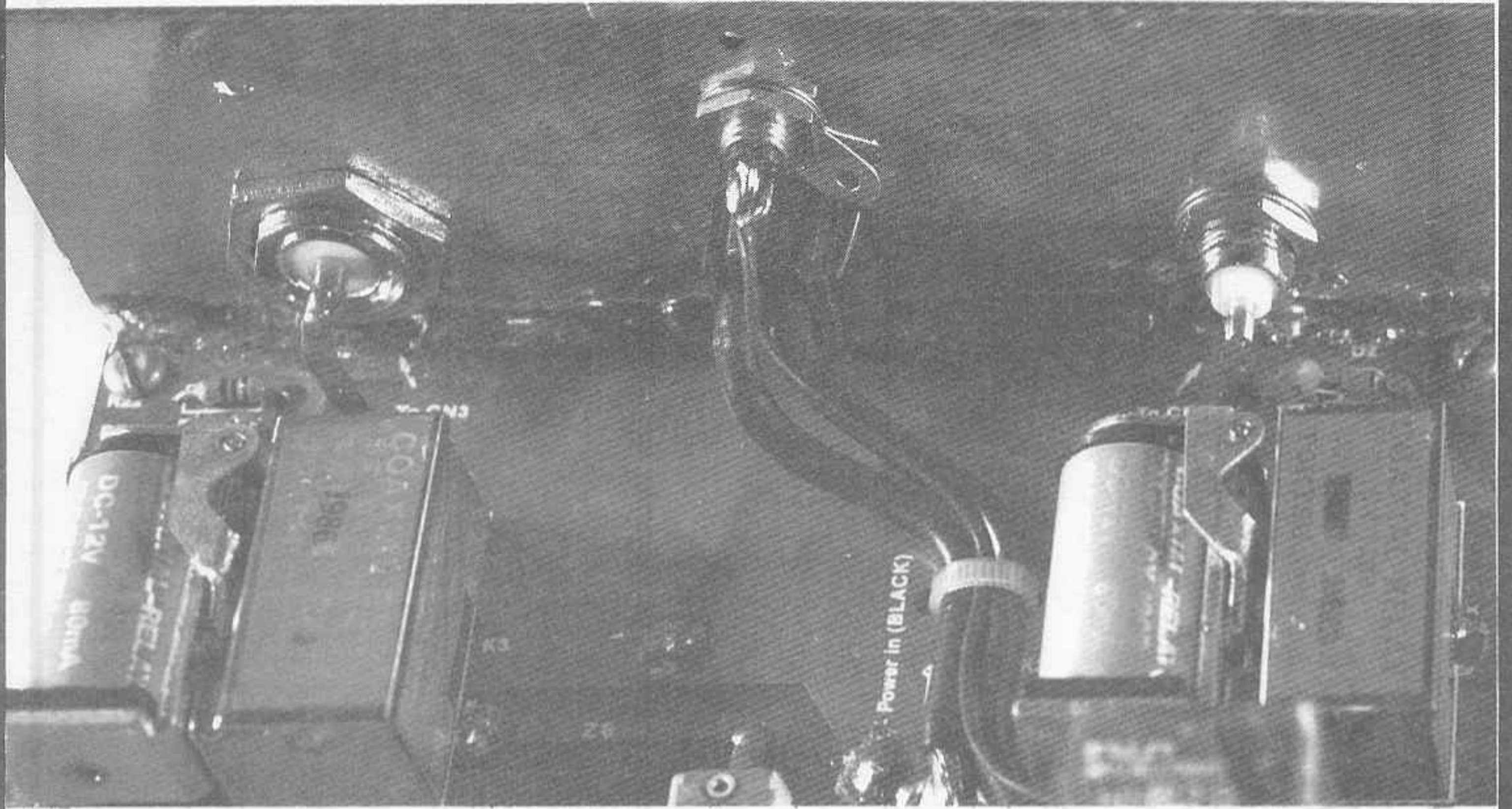

**INSIDE VIEW BACK PANEL**

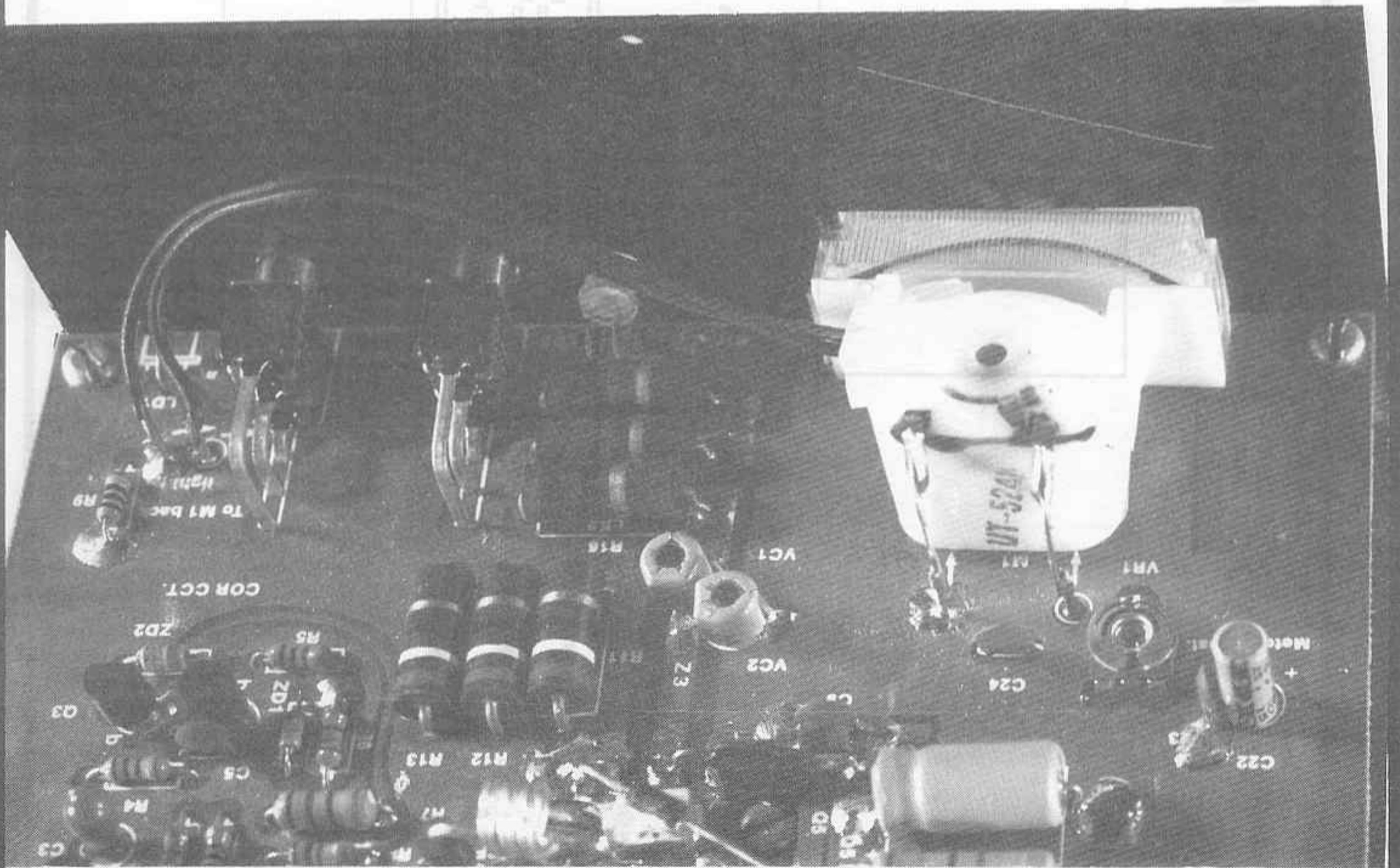

**INSIDE VIEW FRONT PANEL**



# SCREW ALLOCATION

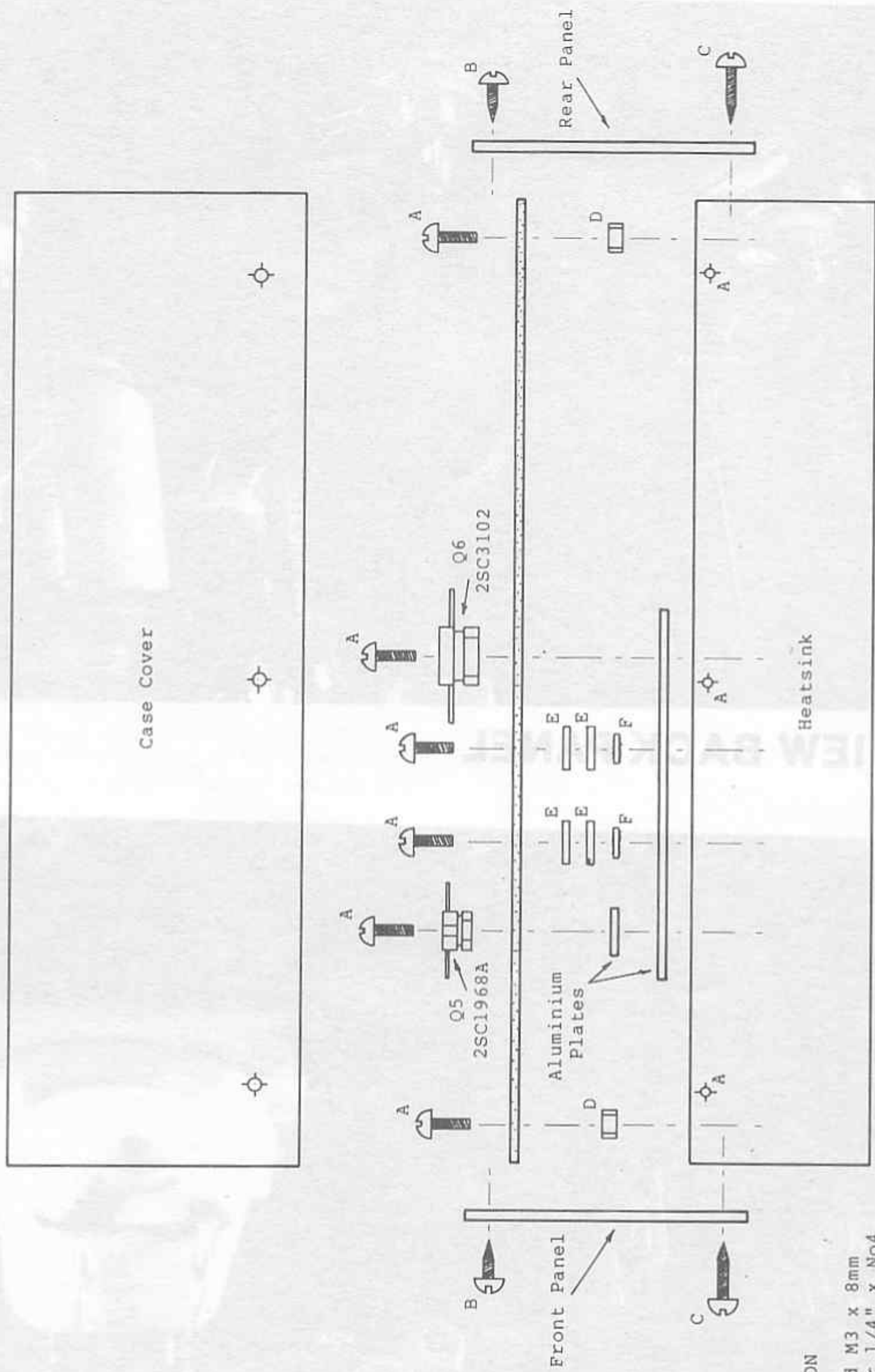

## SCREW ALLOCATION

- A --- Screw Round Head M3 x 8mm
- B --- Screw Selftapper 1/4" x No4
- C --- Screw Selftapper 1/2" x No6
- D --- Nut Hex 4BA
- E --- Washer Flat 1/8"
- F --- Washer Shakeproof 1/8"



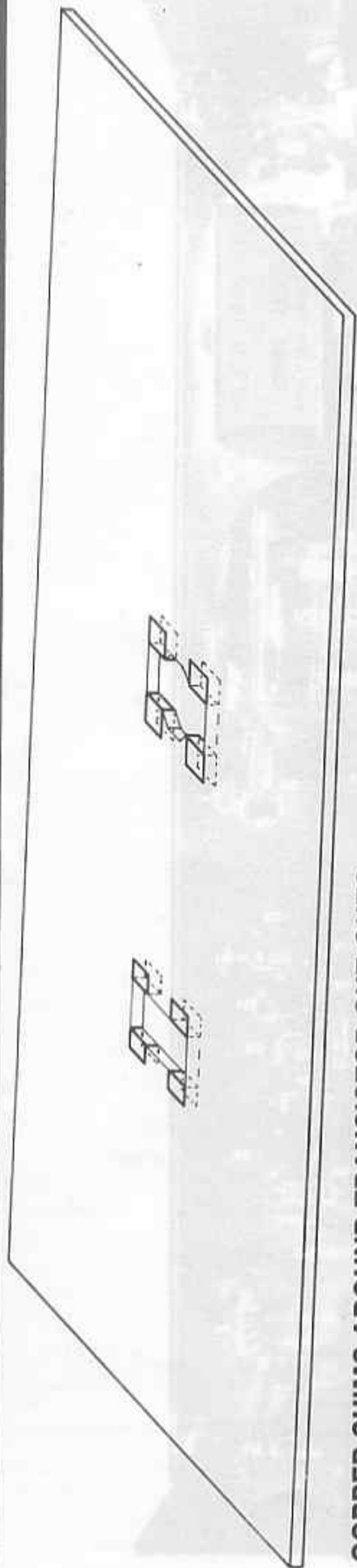
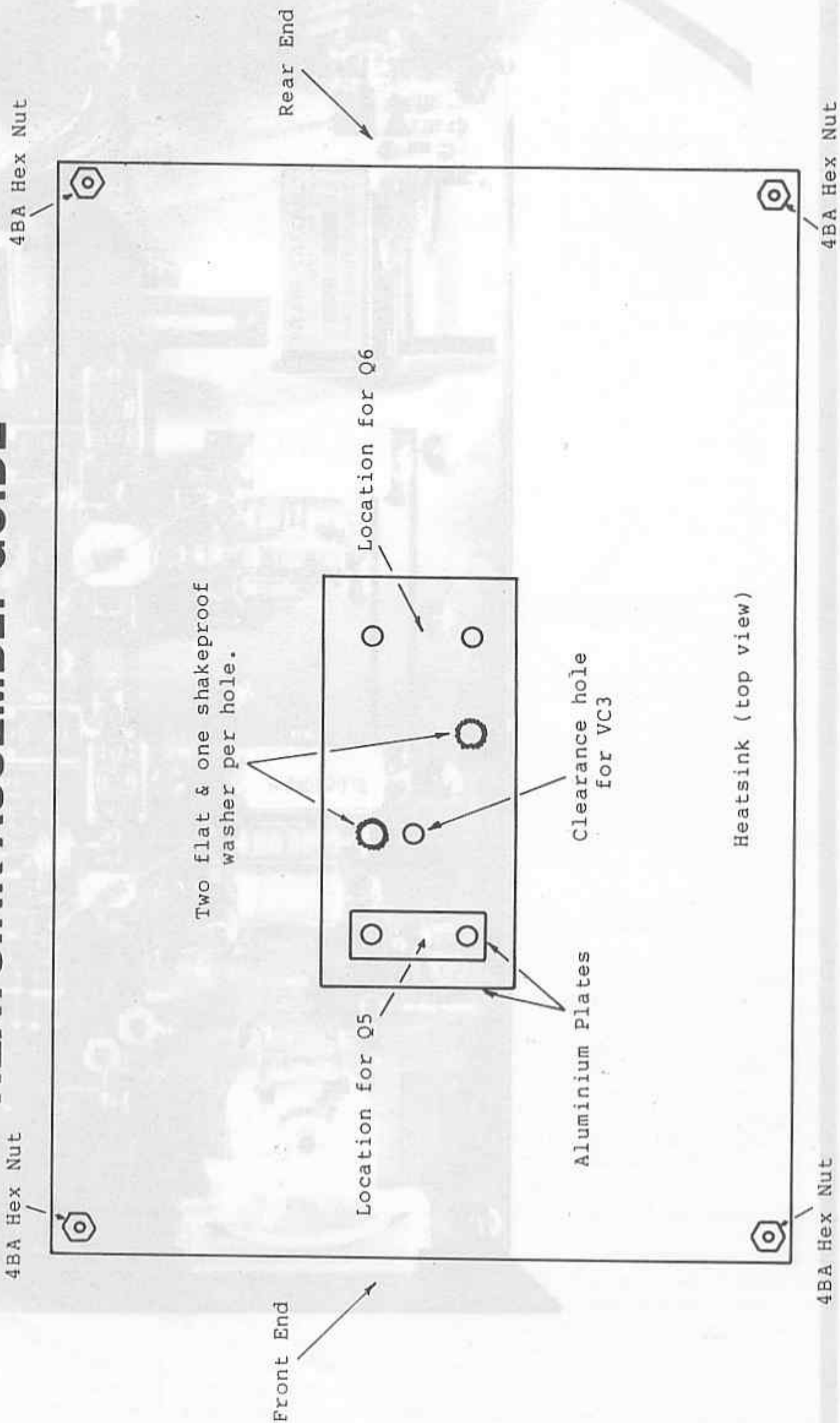

Fig. FOLDING COPPER SHIMS AROUND TRANSISTOR CUT-OUTS

## HEATSINK ASSEMBLY GUIDE





# INSIDE VIEW ~ UHF Power Amplifier

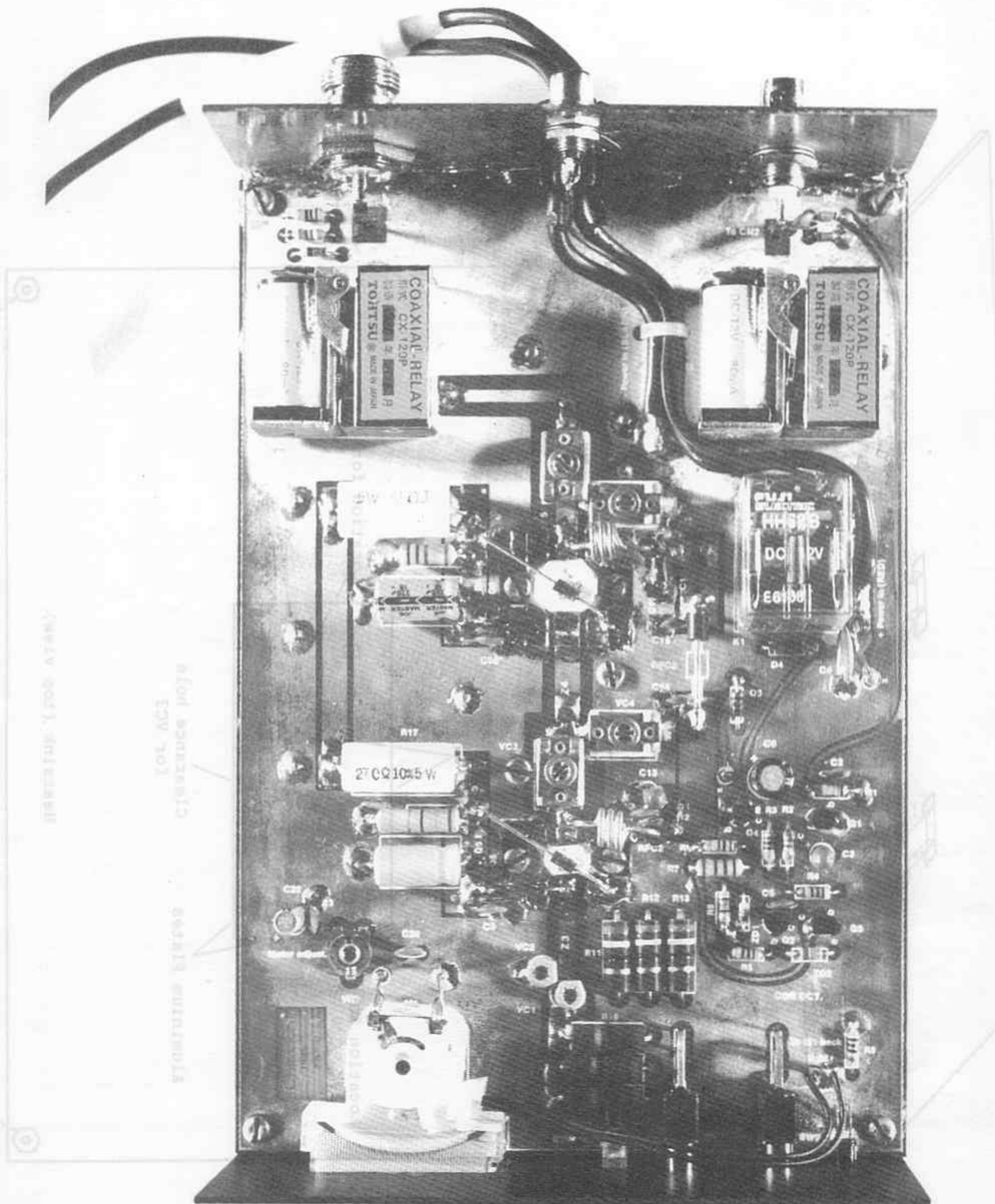



# REAR PANEL WIRING DIAGRAM

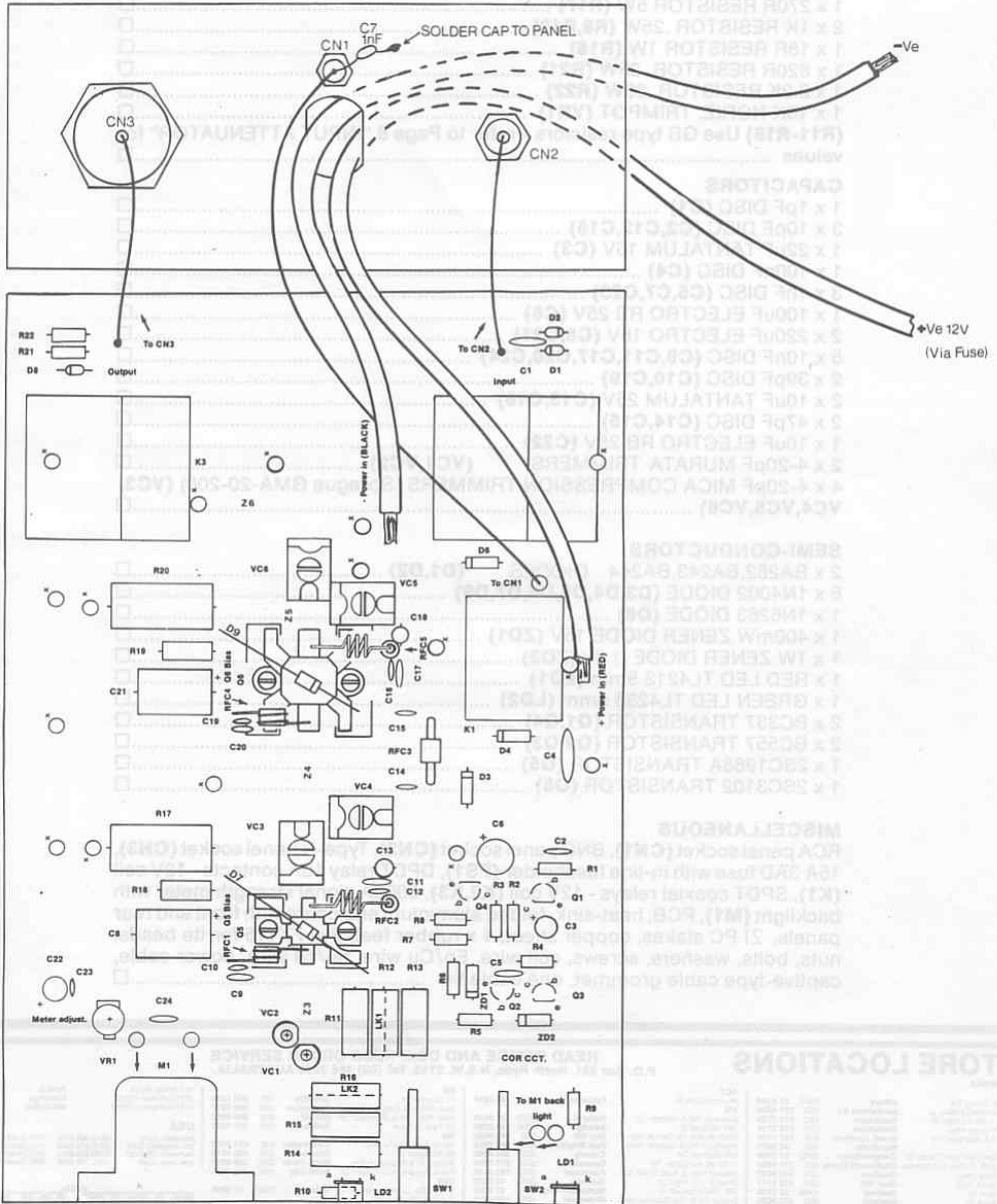



# PARTS LIST

## RESISTORS

- 1 x 390K RESISTOR .25W (R1) .....
- 1 x 56K RESISTOR .25W (R2) .....
- 1 x 56R RESISTOR 5W (R20) .....
- 2 x 10K RESISTOR .25W (R3,R8) .....
- 1 x 3.3K RESISTOR .25W (R4) .....
- 1 x 3.3R RESISTOR 1 W (R19) .....
- 1 x 100R RESISTOR .25W (R5) .....
- 1 x 150R RESISTOR .25W (R6) .....
- 1 x 270R RESISTOR .5W (R7) .....
- 1 x 270R RESISTOR 5W (R17) .....
- 2 x 1K RESISTOR .25W (R9,R10) .....
- 1 x 18R RESISTOR 1W (R18) .....
- 1 x 820R RESISTOR .25W (R21) .....
- 1 x 2.2K RESISTOR .25W (R22) .....
- 1 x 10K HORIZ. TRIMPOT (VR1) .....
- (R11-R16) Use GB type resistors - refer to Page 8 "INPUT ATTENUATOR" for values .....

## CAPACITORS

- 1 x 1pF DISC (C1) .....
- 3 x 10pF DISC (C2,C12,C16) .....
- 1 x 22uF TANTALUM 16V (C3) .....
- 1 x 100nF DISC (C4) .....
- 3 x 1nF DISC (C5,C7,C23) .....
- 1 x 100uF ELECTRO RB 25V (C6) .....
- 2 x 220uF ELECTRO 16V (C8,C21) .....
- 5 x 10nF DISC (C9,C11,C17,C20,C24) .....
- 2 x 39pF DISC (C10,C19) .....
- 2 x 10uF TANTALUM 25V (C13,C18) .....
- 2 x 47pF DISC (C14,C15) .....
- 1 x 10uF ELECTRO RB 25V (C22) .....
- 2 x 4-20pF MURATA TRIMMERS (VC1,VC2) .....
- 4 x 4-20pF MICA COMPRESSION TRIMMERS (Sprague GMA-20-200) (VC3, VC4,VC5,VC6) .....

## SEMI-CONDUCTORS

- 2 x BA282,BA243,BA244 DIODES (D1,D2) .....
- 6 x 1N4002 DIODE (D3,D4,D5,D6,D7,D9) .....
- 1 x 1N6263 DIODE (D8) .....
- 1 x 400mW ZENER DIODE 15V (ZD1) .....
- 1 x 1W ZENER DIODE 3.3V (ZD2) .....
- 1 x RED LED TL4213 5mm (LD1) .....
- 1 x GREEN LED TL4233 5mm (LD2) .....
- 2 x BC337 TRANSISTOR (Q1,Q4) .....
- 2 x BC557 TRANSISTOR (Q2,Q3) .....
- 1 x 2SC1968A TRANSISTOR (Q5) .....
- 1 x 2SC3102 TRANSISTOR (Q6) .....

## MISCELLANEOUS

RCA panel socket (CN1), BNC panel socket (CN2), Type-N panel socket (CN3), 15A 3AD fuse with in-line fuseholder (FS1), DPDT relay 10A contacts - 12V coil (K1), SPDT coaxial relays - 12V coil (K2,K3), 500uA signal strength meter with backlight (M1), PCB, heat-sink, folded aluminium enclosure with front and rear panels, 21 PC stakes, copper sheet, 4 x rubber feet, five FX115 ferrite beads, nuts, bolts, washers, screws, coil wire, En/Cu wire, tin/cu wire, power cable, captive-type cable grommet, one cable tie. ....

## STORE LOCATIONS

**Australia**  
**NSW**  
 Swift & Young Sts  
 755 Terrace Level  
 Shop 1, 65-75 Main St  
 613 Princess Hwy  
 Oxford & Adelaide Sts  
  
 Campbelltown Mall Queen St  
 Shop 235, Archer St Entrance  
 147 Hume Hwy  
 164 Pacific Hwy  
 315 Mann St  
 4 Florence St  
 Hornsby  
 Elizabeth Dr & Bathurst St  
 450 High Street  
 621-627 The Kingsway  
 123 Matland Rd, Tighes Hill  
 Lane Cove & Waterloo Rds  
 George & Smith Sts  
 The Gateway High & Henry St  
 818 George St  
 125 York St  
 Treloar's Bldg, Brisbane St  
 263 Kera St

**Albury** (060) 21 8399  
**Bankstown Sq** (02) 707 4883  
**Blacktown** (02) 871 7722  
**Blakehurst** (02) 548 7744  
**Bondi Junction** (02) 387 1444  
**Brookvale** (02) 83 0441  
**Campbelltown** (046) 27 2199  
**Cherrywood Chase** (02) 411 1955  
**Chullora** (02) 642 8822  
**Gore Hill** (02) 438 5311  
**Gosford** (043) 25 0235  
**Hornsby** (02) 477 8833  
**Liverpool** (02) 800 9888  
**Maitland** (049) 33 7886  
**Miranda** (02) 525 2722  
**Newcastle** (049) 81 1898  
**North Ryde** (02) 88 3855  
**Parramatta** (02) 689 2188  
**Penrith** (047) 32 3400  
**Railway Square** (02) 211 3777  
**Sydney City** (02) 287 9111  
**Tamworth** (067) 66 1711  
**Wollongong** (042) 28 3800

**ACT**  
 96 Gladstone St  
**VIC**  
 Creswick Rd & Webster St  
 145 McCrae St  
 Shop 46 Box Hill Central Man St  
 Hawthorn Rd & Nepean Hwy  
 260 Sydney Rd  
 1150 Mt Alexander Rd  
 Nepean Hwy & Ross Smith Ave  
 Shop 9 110, High St  
 291-293 Elizabeth St  
 Bridge Rd & The Boulevard  
 Springvale & Dandenong Rds  
**QLD**  
 157-159 Elizabeth St  
 166 Logan Rd  
 Gympie & Hamilton Rds  
 2nd Level Western Entrance  
 Redbank Shopping Plaza  
 Queen Elizabeth Dr & Bernard St  
 Gold Coast Hwy & Welch St  
 Bowen & Ruthven Sts  
 Kings Rd & Woolcock St  
 Cnr Pacific Hwy & Kingston Rd

**Fyshwick** (062) 80 4944  
**Ballarat** (053) 31 5433  
**Bendigo** (054) 43 2388  
**Box Hill** (03) 890 0899  
**East Brighton** (03) 932 2388  
**Coburg** (03) 383 4455  
**Epsendon** (03) 379 7444  
**Frankston** (03) 783 9144  
**Geebung** (052) 43 8522  
**Melbourne City** (03) 87 9834  
**Richmond** (03) 428 1814  
**Springvale** (03) 547 0522  
**Brisbane City** (07) 229 5377  
**Buranda** (07) 391 8233  
**Chermside** (07) 358 8255  
**Redbank** (07) 288 5599  
**Rockhampton** (079) 27 9644  
**Southport** (075) 32 9863  
**Toowoomba** (076) 38 4300  
**Townsville** (077) 72 5722  
**Underwood** (07) 341 0844

**SA**  
 77 Grenfell St  
 Main South & Flagstaff Rds  
 Main North Rd & Darlington St  
 24 Park Terrace  
**WA**  
 1141 St & Albany Hwy  
 66 Adelaide St  
 William St & Robinson Ave  
 Raine Square, 125 William St  
**TAS**  
 Shop 40A, Lower Level  
 Cal & Fiddle Arcade  
**NT**  
 17 Stuart Hwy  
**Stuart Park** (089) 81 1577

**Adelaide** (08) 232 1200  
**Darlington** (08) 298 8977  
**Enfield** (08) 260 6068  
**Salisbury** (08) 281 1593  
**Cannington** (09) 451 8888  
**Fremantle** (09) 335 8733  
**North Perth** (09) 328 8844  
**Perth City** (09) 481 3281  
**Hobart** (002) 31 0800

16 Lydney Place  
 289 Cameron Road  
 154 Featherston Street  
**Porirua** (09) 37 6654  
**Tauranga** (075) 87 0711  
**Wellington** (04) 73 9858  
**USA**  
**Berkeley, Calif** (415) 486 0755  
**Los Angeles, Calif** (213) 474 0626  
**Redwood City, Calif** (415) 368 8844  
**San Jose, Calif** (408) 241 2266  
 2474 Shattuck Avenue  
 1530 Westwood Boulevard  
 390 Convention Way  
 4960 Stevens Creek Boulevard

**HEAD OFFICE AND DSXPRESS ORDER SERVICE**  
 P.O. Box 321, North Ryde, N.S.W. 2113. Tel: (02) 888 3200 AUSTRALIA.

**DICK SMITH ELECTRONICS**  
 PTY LTD

Terms available to approved persons only through: