

# OPERATING MANUAL



## ALPHA 89

### HF LINEAR POWER AMPLIFIER



**ALPHA/POWER, INC.** RF Power for Communications and Industry  
14440 Mead Court, Unit B, Longmont, Colorado 80504  
(970) 535-4173 \* FAX (970) 535-0281

# TABLE OF CONTENTS

<b>INSTALLING YOUR ALPHA 89</b> .....	<b>1</b>
<b>OPERATING YOUR ALPHA 89</b> .....	<b>2</b>
<b>1.0 - INTRODUCTION</b> .....	<b>3</b>
<b>2.0 - OVERVIEW OF AMPLIFIER CAPABILITIES</b> .....	<b>3</b>
<b>3.0 - ALPHA 89 SPECIFICATIONS</b> .....	<b>4</b>
<b>4.0 - UNPACKING AND PREPARATION</b> .....	<b>5</b>
Figures 1-3 Transformer installation .....	6
Figure 4 Inside top view .....	7
Figure 5 View with front panel lowered .....	8
<b>5.0 CONTROL &amp; INDICATOR FUNCTIONS</b> .....	<b>9</b>
Figure 6 Front Panel .....	10
<b>6.0 - INSTALLATION</b> .....	<b>11</b>
Figure 7 Rear panel connections .....	11
<b>7.0 - OPERATION</b> .....	<b>12</b>
Table Tuneup Settings .....	14
<b>8.0 - FAULTS AND PROTECTIVE FUNCTIONS</b> .....	<b>15</b>
<b>9.0 - TROUBLESHOOTING SUGGESTIONS</b> .....	<b>16</b>
<b>10.0 - ALPHA 89 FUNCTIONAL CONFIGURATION</b> .....	<b>17</b>

## ILLUSTRATIONS

Figs. 1-3, Transformer installation .....	6
Fig. 4, Inside top view .....	7
Fig. 5, View with front panel lowered .....	8
Fig. 6, Front panel view .....	10
Fig. 7 Rear panel connections .....	11
Fig. 8, ALPHA 89 Simplified schematic .....	18

# CAUTION!!

## READ BEFORE PROCEEDING!

### *TO AVOID SERIOUS DAMAGE NOT COVERED UNDER WARRANTY READ THIS MANUAL CAREFULLY BEFORE INSTALLING YOUR ALPHA 89*

The *ALPHA 89* is easy to install, but failure to carry out each procedure exactly as described in this manual is likely to lead to amplifier damage which is not covered under warranty. Damage to other station equipment also may result. Important precautions are given on this and the next page.

### INSTALLING YOUR ALPHA 89

1. Be careful not to twist or warp the chassis when handling the amplifier with its cover removed. Never lift the chassis by one corner when the transformer is in place.
2. When installing or removing the transformer, move carefully and follow the instructions in this manual *exactly*. When installing, insure that all connectors are *properly mated* and fully seated. Don't force them! Tuck the transformer handle out of the way so it doesn't interfere with the cover. It is necessary to install at least one of the transformer bolts to eliminate potentially hazardous voltage buildup between the transformer and chassis.

When removing the transformer, carefully unlock the mated connectors and gently pull them apart.

3. Insure that both tubes are solidly seated in their sockets with the red silicone rubber chimneys firmly seated against the chassis.
4. Connect the green conductor in the *ALPHA 89* power cord only to the power source neutral or ground. *Connecting the green wire to a "hot" line is almost certain to cause immediate damage.* Triple check your wiring before plugging in!
5. Make sure the primary power tap is connected to the tap closest to your actual AC line voltage. See manual section 4.3.
6. Never install cover screws longer than 1/4". Longer screws may penetrate internal boards or wiring and cause severe damage. Make sure each screw hole in the cover is aligned with its corresponding captive nut in the chassis before inserting screws.
7. Remove blower motor shipping hardware from rear chassis wall. Save the two 10-32 bolts, fibre washers, and rubber shim; reinstall this hardware whenever the chassis is transported.
8. Solidly bond all station equipment together. Heavy braid, such as the outer conductor of RG-8/U coaxial cable, is recommended for the purpose. This is important for personal and equipment safety as well as to avoid RF feedback.
9. **DON'T** apply AC power with the cover off without contacting ETO customer service first. You may damage both you and your amplifier!

# CAUTION!!

## READ BEFORE PROCEEDING!

### TO AVOID SERIOUS DAMAGE NOT COVERED UNDER WARRANTY READ THIS MANUAL CAREFULLY BEFORE OPERATING YOUR ALPHA 89

The *ALPHA 89* is easy to operate, but failure to carry out each procedure exactly as described in this manual is likely to lead to amplifier damage which is not covered under warranty. Damage to other station equipment also may result. Important precautions are given on pages 1 and 2 of this manual.

### OPERATING YOUR ALPHA 89

1. *You must set transceiver power output properly!* The *ALPHA 89* requires only 50 watts drive for full rated output. Virtually all damage results directly from severe overdrive. Damage caused by applying far more than rated drive power to the *ALPHA 89* will not be covered under warranty. Fortunately, most modern transceivers maintain quite consistent output from band to band and mode to mode *if set up properly*. Setting the transceiver POWER or RF PWR control IS NOT SUFFICIENT! Several popular transceivers can generate RF spikes of 200-300W or more unless the transceiver *internal drive level* also is adjusted carefully according to its manufacturer's instructions. Typically this is done with a knob labeled DRIVE (IC-781, FT-1000), PROCESSOR OUT (TS-940, TS-950) or, on SSB when speech processing is not in use, MIC or MIKE.
2. The *ALPHA 89* "faults" into STBY or OFF when unsafe operating conditions occur. If this happens the fault can be cleared by removing excitation, switching from operate to standby and back to operate, and then re-applying excitation.
3. To operate the *ALPHA 89* efficiently, cleanly, and safely at any desired peak power output, it must be properly loaded and driven for that power level. If peak power output (and hence drive) is to be changed significantly, the amplifier must be reloaded and tuned. See section 7.
4. Induced energy from nearby electrical storms or other power transients may damage components. Such damage is not covered under warranty. It is important to use a good lightning arrestor, and it's good practice also to disconnect and ground antenna feedlines, and to disconnect AC power, when the equipment is not in use.

**HAPPY OPERATING!**

# 1.0 - INTRODUCTION

This Manual provides all the information necessary to install and operate your *ALPHA 89*. Schematic diagrams are available on request, at no charge to owners. For your own protection please return the Owner Registration Card immediately and advise ETO of any future address change promptly.

## 1.1 - OWNER ASSISTANCE

Assistance is available from ETO Customer Service (Communications Products) at (719) 599-3861, 260-1191, by FAX at (719) 260-0395, or by mail. *ALPHA* technical specialists also may be contacted through the same office.

# 2.0 - OVERVIEW OF AMPLIFIER CAPABILITIES

It is extremely important to thoroughly review Installation and Operation sections of this manual before attempting to use the *ALPHA 89*. Failure to do so could result in serious damage not covered under warranty.

The *ALPHA 89* is capable of 1.5 kW continuous RF output on all commonly-used modes and on any authorized amateur frequency from 1.8 to 29.7 MHz.

The *ALPHA 89* is compatible with all popular amateur HF transceivers and excitors. It requires approximately 50 watts peak RF drive for 1.5 kW output.

The *ALPHA 89* is capable of full break-in CW (QSK) and all digital modes when used with any appropriate transceiver. The *ALPHA 89* control system incorporates protective functions that minimize the probability of accidental damage to the amplifier or its power tubes. In most cases, when one of the protective functions is "tripped," a front panel LED indicator will display the fault (e.g., excessive grid or plate current, load reflected power/ VSWR, etc.)

For extended RATT or other very high duty cycle service, use of the *ALPHA 89* optional auxiliary cooling fan, available from ETO, is strongly recommended. With reasonable care, your *ALPHA 89* should provide exceptional performance and satisfaction for many years.

### 3.0 - ALPHA 89 SPECIFICATIONS

**Frequency Coverage:** All amateur bands 1.8-29.7 MHz\* plus most non-amateur frequencies 6.0-19.0 MHz and 20-30 MHz.

\* NOTE: FCC rules do not permit new amateur amplifiers to be operable on 24-30 MHz as delivered within the U.S. & possessions. Owners who send ETO Customer Service a photocopy of their authorizing amateur license will promptly be provided information on "unlocking" 12 and 10 meter coverage.

**Band Change & Tuning:** Manually controlled by the operator.

**Power Output:** 1500 watts PEP, keyed CW, or continuous carrier, no time limit. Auxiliary cooling fan (optional) recommended for high duty cycle continuous operation.

**Drive Power:** Typically 50-60 watts for full rated output.

**Input VSWR:** < 1.5:1 within amateur bands; < 2:1 elsewhere.

**Tube Complement:** Two Eimac 3CX800A7 triodes in grounded grid.

**T/R System:** Heavy duty PIN diode switch. Switching time approximately 1 mS. Enclosed mechanical bypass relay.

*capable of feed through and hot switching of 1500 exciter powers*

**ALC:** Grid-current-derived, adjustable to -10V maximum.

**Harmonic Output:** Better than 55 dB below rated output.

**Intermodulation:** Better than 36 dB below rated output.

**Fault Protection:** Plate overcurrent, grid overcurrent, high reflected power (load VSWR), T/R mis-sequencing, gain (i.e., severe mistune or RF arc), overdrive, other.

**Displays:** Dedicated LED bargraphs for peak Pout, Prefl, and Ig, plus switched bargraph for average Ip, HV, TUNE indicator, drive power, and load VSWR.

**Cooling:** Full cabinet ducted-air, rear intake/top exhaust. Floating blower mount for quietest operation.

**Primary Power:** 190-250V (200, 220, 240V nominal taps), 50-60 Hz, single phase; fused 20A.

**Size & Weight:** 17.3"W x 7"H x 16.5"D (439 x 178 x 419 mm) excluding controls, feet & connectors; 75 lb. (34 kg) net.

## 4.0 - UNPACKING AND PREPARATION (Ref. figs. 1-4, pages 6-7)

4.1 Unpack amplifier and transformer. Inspect both for physical damage. Save all packing material for future use. Warning! Do not ship amplifier in other than factory packing or equivalent.

4.2 Remove cover by removing all screws **except** the two located in the perforated tube exhaust areas. Inspect carefully for shipping damage. If damage is discovered in either of these two steps notify ETO Customer Service immediately.

4.3 Connect the proper internal line voltage tap. The *ALPHA 89* may be operated from any AC power source of 190-250V, 50-60 Hz, 20 ampere capacity. A 4-terminal barrier strip for tap selection is located toward the back chassis wall to the left of the transformer. **DO NOT MOVE** the wire connected to the terminal marked PRI! If necessary, move the other wire to the tap (200, 220, or 240V) closest to your nominal AC line voltage.

4.4 Install Transformer. Position amplifier flat on a table with the right side of the chassis facing forward. Install the transformer per Figures 1 through 3, using its sling handle. Use care not to pinch or damage wiring or components. You may wish to have a helper steady the chassis during the following steps.

Align the threaded holes or captive nuts in the transformer base with corresponding chassis holes. Taking care not to torque or twist the chassis, carefully extend it over the edge of the table just far enough to loosely screw in at least one, and preferably both, of the two outside transformer mounting bolts (1/4-20 hex head with flat washers, supplied). The following step is recommended but not mandatory...

Do not stand the amplifier on edge or move it further over the table edge. Instead, rotate it so as to extend the two inner transformer mounting holes, *one at a time*, over the table edge and loosely install the bolts. Now center the transformer as much as possible so that both sides are well clear of metal work. Orient the chassis as above while tightening all 4 bolts.

One of the transformer connectors plugs into the AC power wiring near the top/rear of the chassis center partition, on the power supply side. The remaining two connectors plug into the top of the power supply board immediately in front of the transformer. Proper mating of these connectors is obvious with reasonable care; *look first and make sure they match!* (See Fig. 3 view A-A) Make certain the connectors are properly mated and seated, but don't force them; they mate and latch easily.

4.5 Insure that both tubes are fully seated in their sockets with their red rubber chimneys firmly contacting the chassis.

4.6 Make sure the HV crowbar works smoothly.

4.7 Replace the cover and carefully reinstall all screws. Be careful not to force or cross-thread screws. Never use screws longer than 1/4"!

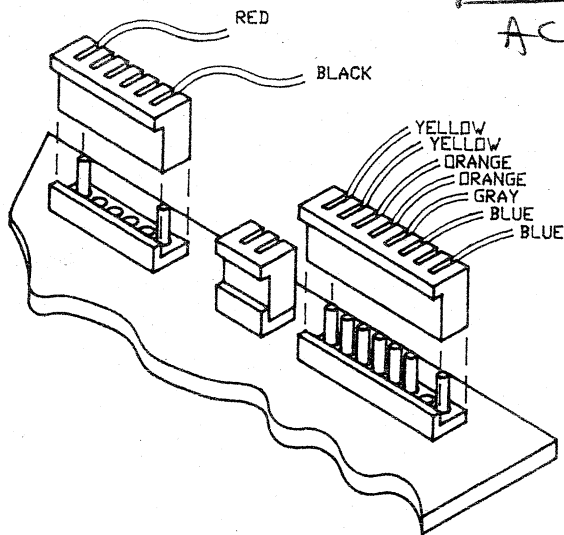
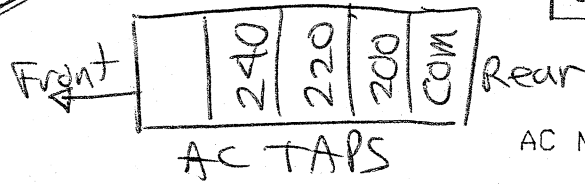
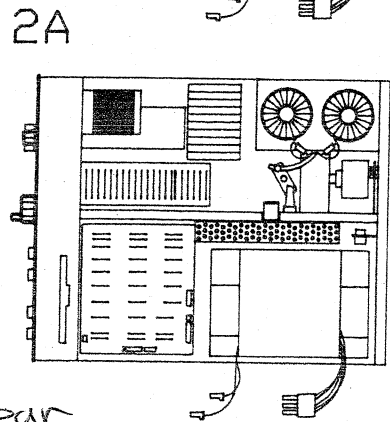
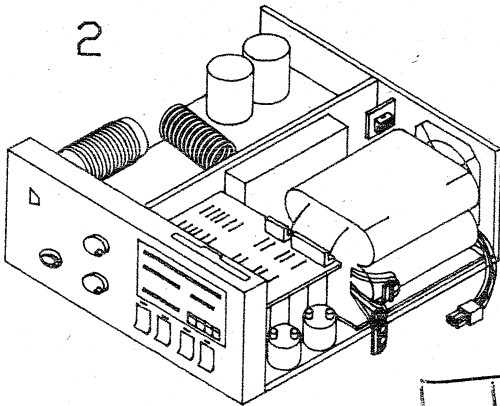
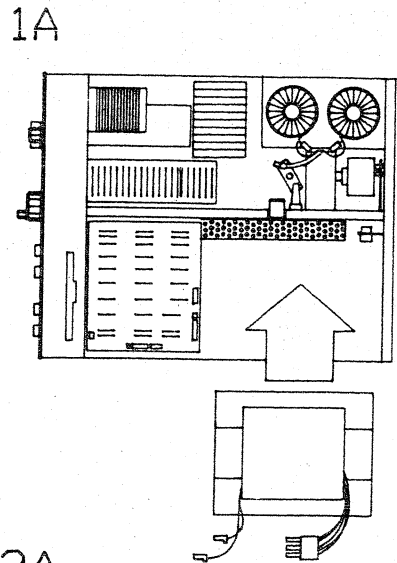
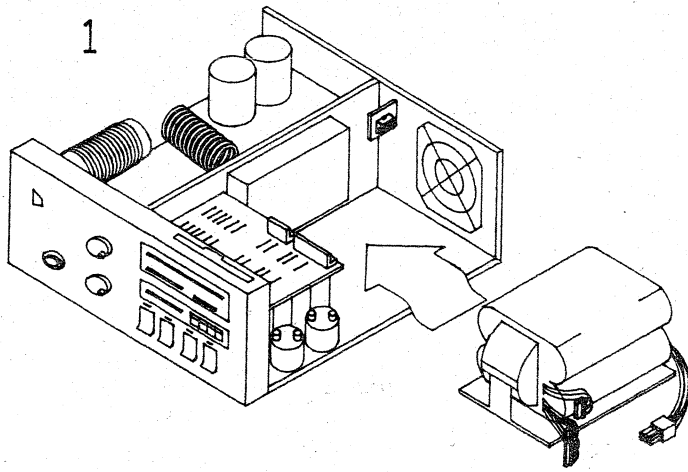

HIGH AND LOW VOLTAGE BOARD CONNECTIONS

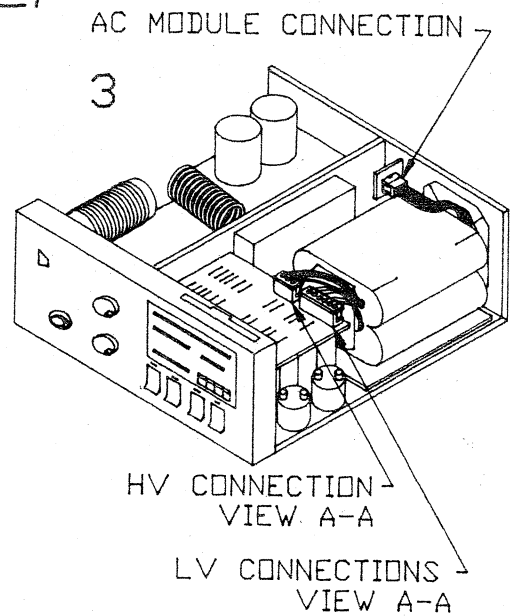

## FIGURES 1-3 TRANSFORMER INSTALLATION



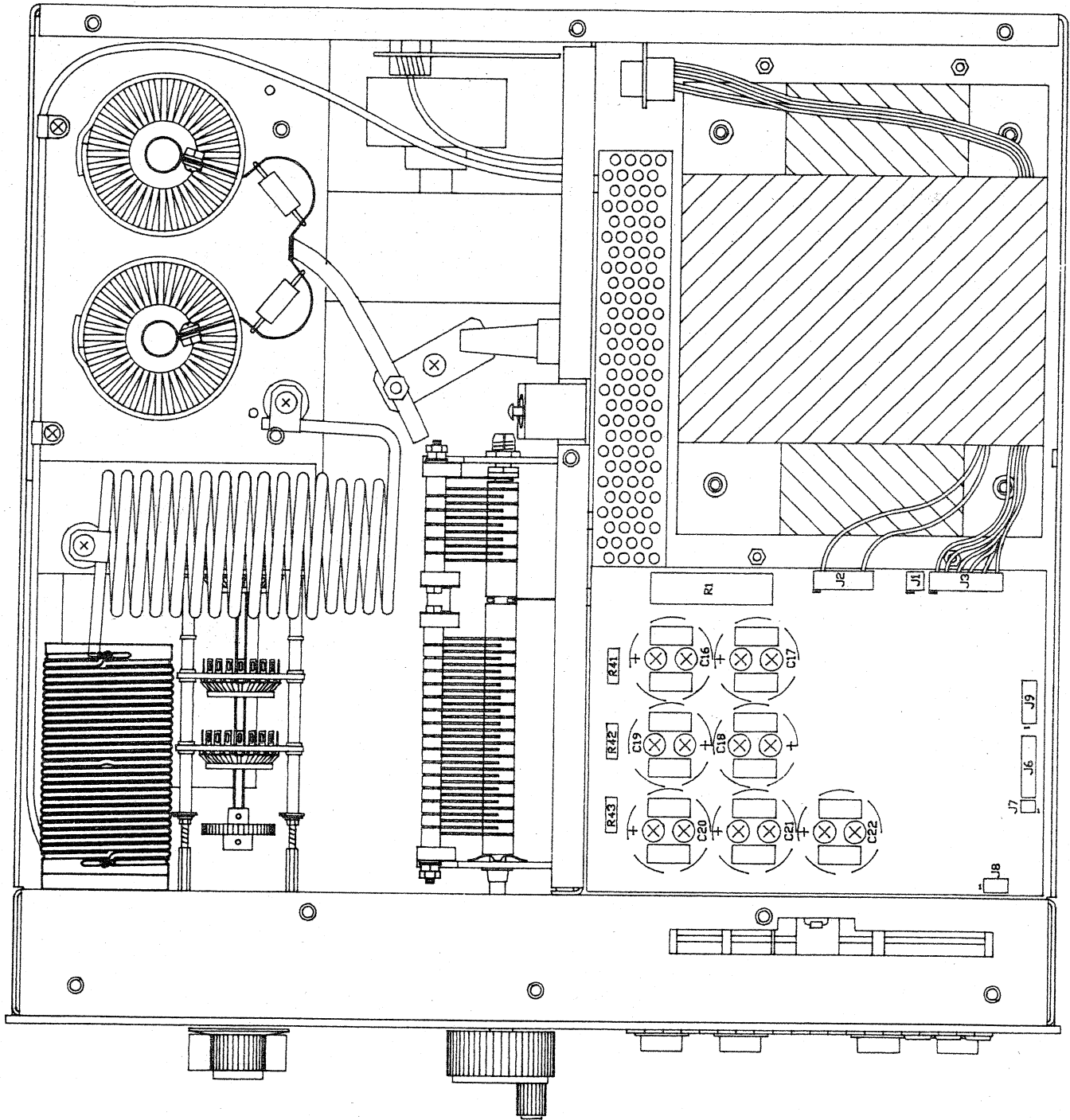

**FIGURE 4**  
**INSIDE TOP VIEW**

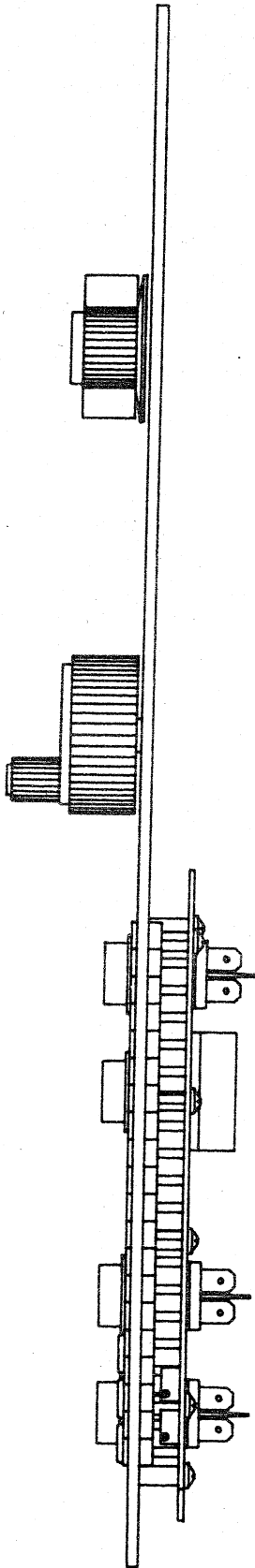
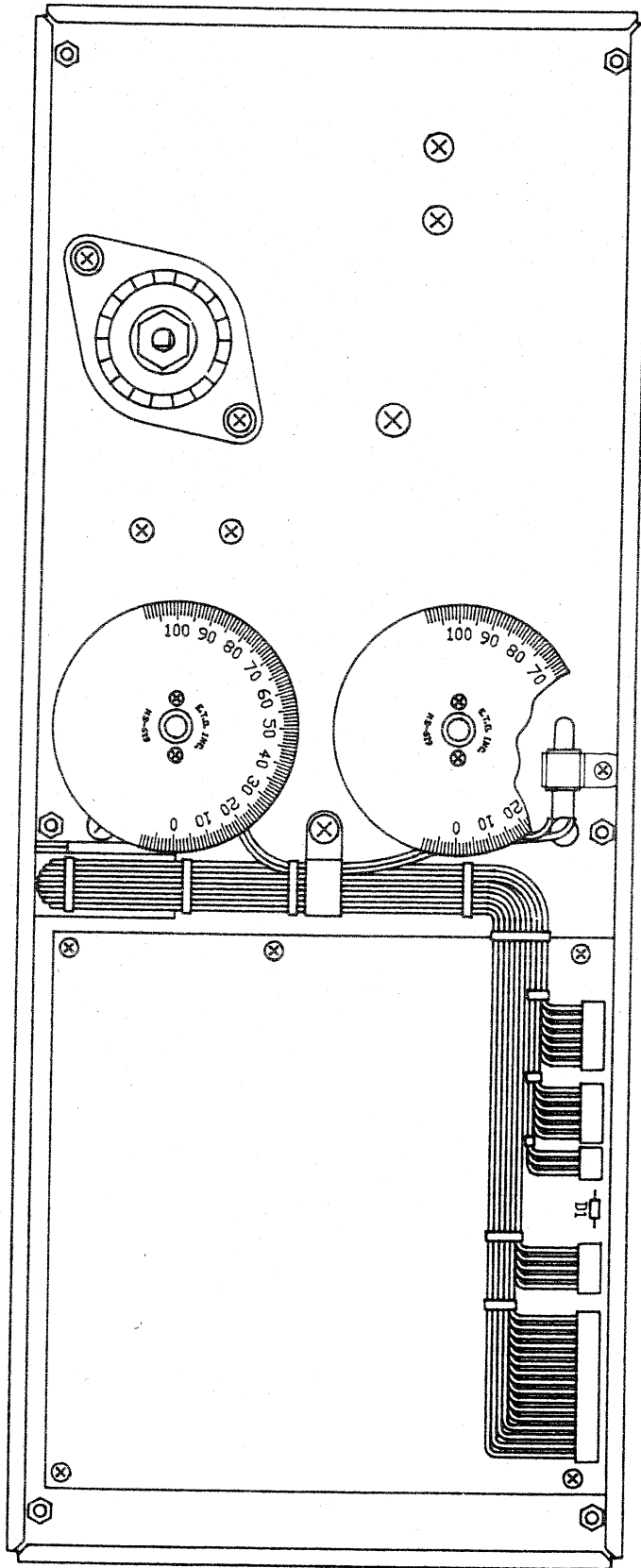

FIGURE 5

VIEW WITH FRONT PANEL LOWERED

## 5.0 CONTROL & INDICATOR FUNCTIONS (See fig. 6, page 10)

- 5.1 RF OUTPUT, GRID CURRENT, and REFLECTED POWER bargraphs are peak-reading and generally self-explanatory. Example: 1.5 kW output (forward power into a 50 ohm load) is indicated when all green LED segments to the left of the 1.5 (kW) label are fully lighted and the first red LED segment is dark. The primary calibration point for RF OUTPUT is at 1.5 kW on 14 MHz.
- 5.2 TUNE/IP/HV/DRIVE/LOAD VSWR "multimeter": The function of this indicator is selected by buttons at its right. It is a moving-dot display. HV (plate voltage) is read on the 0-3 kV top scale. Ip (average plate current) is displayed on the 0-1.5 A next lower scale. INPUT DRIVE is read on the same scale as Ip, with full scale 150 watts. VSWR (3:1 maximum) is read on the bottom scale. The TUNE meter function permits fast and safe manual tuneup at reduced power.
- 5.3 BAND switch: Each band switch position selects the amateur band indicated in MHz.
- 5.4 TUNE control: Varies plate tuning capacitor to set output circuit to resonance.
- 5.5 LOAD control: Varies plate loading capacitor to establish optimum amplifier power output level.
- 5.6 CW/SSB rocker switch: Selects optimum operating bias for emission type. CW provides highest efficiency for non-linear modes including CW and FM, and SSB provides best linearity for SSB, AM, and SSTV (also okay for CW and FM).
- 5.7 OPR/STBY rocker switch: Selects operate or standby modes.
- 5.8 ON and OFF rocker switches: momentary action switches turn the *ALPHA 89*'s main AC power on or off.
- 5.9 Special rear-panel connections:
- a) ALC & ALC Adjust - See section 8.3.
  - b) RELAY - Switches amplifier from receive to transmit when connector center pin is shorted to ground.
  - c) KEY OUT - Provides a contact closure which follows the keying line connected to the RELAY jack whether the amplifier is in ON, STANDBY, or OPERATE condition. Useful for special T/R hook-ups when amplifier is used with exciters having poor T/R sequencing. Contact ETO customer service for specific advice.



ALPHA 89

HF LINEAR AMPLIFIER

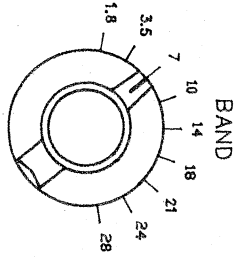

TUNE

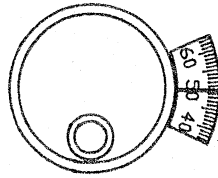

LOAD

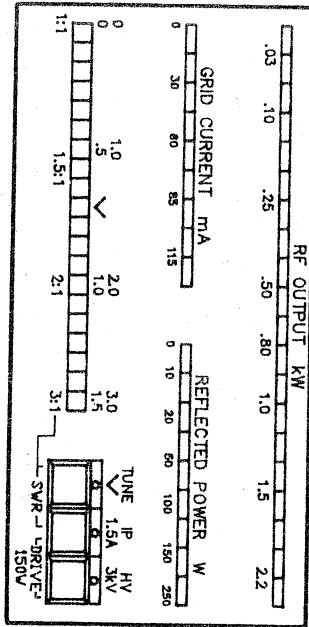
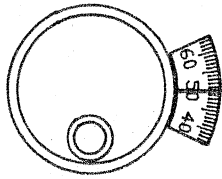

OPR STBY WAIT FAULT

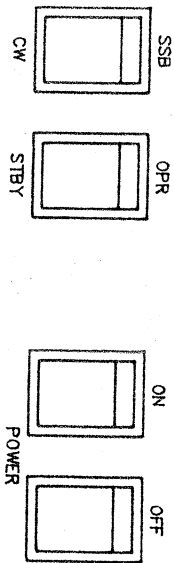

FIGURE 6

FRONT PANEL

## 6.0 - INSTALLATION (Refer to fig. 7, page 11)

6.1 Connect a 50 ohm coax cable 60-72" long (supplied) from the transceiver RF output to the **ALPHA 89's** RF INPUT jack.

6.2 Connect a transceiver T/R control line which is shorted on transmit and open on receive to the **89's** RELAY jack, using a standard "RCA" ("phono") plug. Cable should be shielded type.

6.3 Connect a nominally 50 ohm antenna for the frequency to be used to the **89's** RF OUTPUT jack.

6.4 If desired, connect a cable from the the ALC jack to the transceiver ALC input, using an RCA plug. See sect. 8.3.

6.5 Connect a heavy copper strap or braid from the ground stud & wing nut on the rear panel of the **ALPHA 89** to the chassis of the transceiver and other station equipment, and to the main station RF ground.

6.6 Connect to AC power consistent with tap selected. **CAUTION!** Be sure the **89** green wire connects to AC ground or neutral!

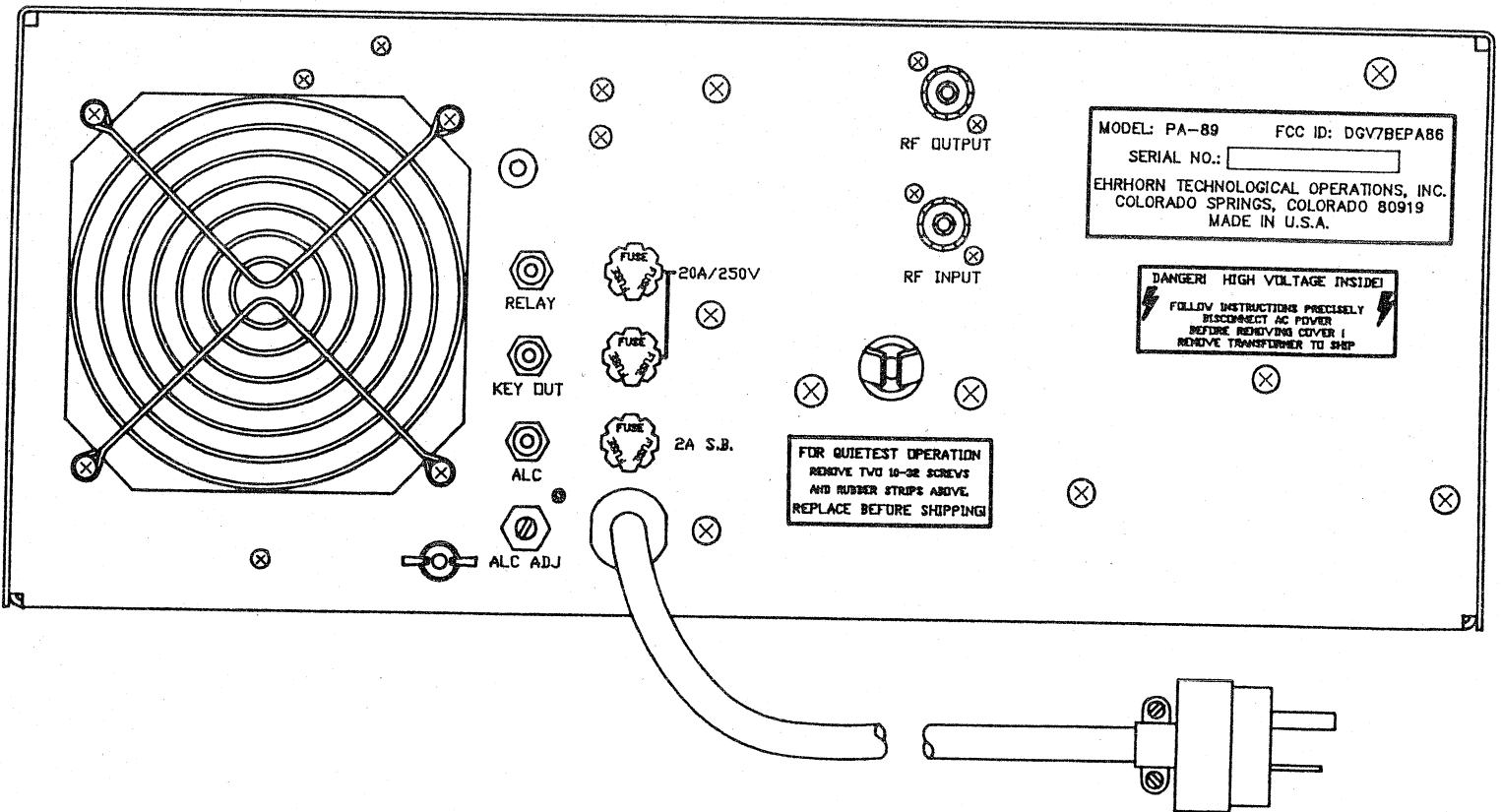

FIGURE 7

## REAR PANEL CONNECTIONS

## 7.0 - OPERATION

If the **ALPHA 89** already is tuned and loaded for the operating frequency, it is necessary only to turn on the amplifier, wait 3 minutes for tube warm-up time delay to complete, then switch to OPERATE and apply drive. Before operating on a frequency or band different from that previously used, the **89** must be re-tuned by the operator. Re-tuning is a simple process that takes only a few seconds.

### 7.1 Preparation for **ALPHA 89** Tuneup

- a) Press POWER ON button. Select preliminary BAND, TUNE, and LOAD control settings from the "tuneup settings" chart, page 14.
- b) When the three minute tube warm-up cycle ends, the red WAIT LED will extinguish. Depending upon the setting of the OPR-STBY (operate-standby) switch, the appropriate status LED above it will then light. Set the switch to STBY (standby); the STBY LED should then be illuminated.
- c) Set transceiver to provide a steady unmodulated RF carrier (e.g., CW, AM, or RTTY/FSK).
- d) Determine proper control settings for transceiver peak output of 50 watts. The **ALPHA 89**'s built-in drive power wattmeter may be used to measure and set transceiver power. To do this, first put the amplifier in STBY so transceiver power is bypassed to the antenna. Then press the multimeter IP and HV buttons simultaneously; the green LEDs in both buttons will illuminate. Driving power is indicated on the 0-1.5 scale with full scale = 150 watts.
- e) Adjust transceiver output to approximately 50 watts, note its power output control setting, then reduce output to ZERO. NOTE: Most transceivers have an internal drive (or "processor out") control which determines the *internal* ALC voltage. This *must* be adjusted according to the manufacturer's instructions to avoid overdrive and distortion.
- f) Set the amplifier multimeter to Ip. The bargraph will read at or near zero until drive is applied.
- g) Switch the amplifier from STBY to OPR (operate).
- h) Set the SSB-CW switch to SSB. (Tuning should be done with the amplifier in the SSB (linear) mode regardless of intended emission type.
- i) Set transceiver to transmit (manual lock-key, MOX, or PTT).

### 7.2 Normal tuneup using the TUNE meter

To tune up for nominal peak RF output of 1500 watts the goal is to adjust LOAD and TUNE controls alternately until the lighted TUNE LED is positioned at the mid-scale "V" mark. Proceed as follows:

- a) Preset the **ALPHA 89**'s BAND, TUNE, and LOAD controls to the positions given in the "tuneup settings" chart on page 14.
- b) Select the multimeter TUNE function and apply approximately ten watts drive. (The TUNE LED

will not deflect from its resting position with less than 5-8 watts; until the amplifier is properly tuned, applying more than 15 watts may cause a protective TUNE fault.)

b) Adjust TUNE control to move or “dip” the TUNE bargraph LED as far to the left as possible.

c) After step (b)...

1) If the TUNE indicator is to the left of the desired (mid-scale “V”) position, adjust LOAD clockwise until the indicator moves to the desired position, OR...

2) If the indicator is to the right of the desired position, adjust LOAD counter-clockwise instead.

d) Repeat steps (b) and (c) until the TUNE indicator is positioned as desired. See para. 7.5 for final tuning check.

### 7.3 Tuneup for peak RF output greater than 1,500 watts

a) Follow steps 7.2 a) through 7.2 d) above except make final adjustments so that the second or third LED to the *right* of the mid-scale “V” mark is lighted.

b) See para. 7.5 for final tuning check.

### 7.4 Tuneup for RF output of 1000 to 1400 watts

a) As above except make final adjustments so the first or second LED to the left of the “V” is lighted.

b) See para. 7.5 for final tuning check.

### 7.5 Final double-check of tuneup adjustment (perform after completing 7.2, 7.3, or 7.4 above)

a) Briefly increase drive power until amplifier grid current just reaches its normal peak value of 35-50 mA; note RF output.

b) If output is close to desired value, tuneup is complete.

c) If output is greater than desired, reduce LOAD control setting very slightly and repeat steps (a), (b), and (c).

d) If output is less than desired, increase LOAD setting slightly and repeat this section.

### 7.6 Alternate tuneup procedure not using TUNE indicator

a) Preset **ALPHA 89** controls per “tuneup settings”, page 14.

b) Slowly increase transceiver output to 25-30 watts. Adjust amplifier LOAD control to maximize RF output. Then adjust TUNE and LOAD alternately until no further increase in output can be obtained.

c) Carefully adjust transceiver output until amplifier grid current just reaches but does not exceed 35-50 mA and note amplifier RF output. Then proceed to c) or d) below, as appropriate.

d) If RF OUTPUT after step c) above is less than desired...

1) Increase LOAD setting until grid current drops below 35 mA.

2) Adjust TUNE control to maximize  $I_g$ .

3) Repeat these sections c) and d) as necessary, until desired RF output is achieved with 35-60 mA  $I_g$ .

OR

e) If RF OUTPUT after step c) is greater than desired...

- 1) Reduce transceiver drive until  $I_g$  drops below 35 mA.
- 2) Reduce LOAD setting until  $I_g$  rises to about 45 mA.
- 3) Adjust TUNE for maximum  $I_g$ .
- 4) Repeat sections c) and e) as necessary, until desired RF output is achieved with 35-50 mA  $I_g$ .

**CAUTION!** If, during operation at or below desired power on any band, the grid current exceeds 70 mA, turn LOAD to a higher setting (to increase loading) and then adjust TUNE for maximum RF OUTPUT. Repeat if necessary until peak grid current at desired output does not exceed 50-60 mA.

**IMPORTANT:** As the final tuneup step, *always* adjust TUNE for maximum RF output.

### 7.7 - TUNING NOTES

- a) At resonance, plate current is minimum (dipped) while grid current and RF output are at or very near maximum (peaked).
- b) Increasing the TUNE control dial reading increases tuning capacitance.
- c) Increasing the LOAD control dial reading decreases loading capacitance; this is because decreasing capacitance increases actual loading.
- d) Excessive grid current can be corrected by reducing transceiver output or increasing amplifier loading.
- e) FCC rules do not permit new amateur amplifiers to be operable on 24-30 MHz as delivered within the U.S. & possessions. U.S. owners who send a photocopy of their authorizing amateur license to ETO customer service will be provided information on "unlocking" 12 and 10 meter coverage. (ETO *is not permitted* to perform this very simple operation for you.)

### TUNEUP SETTINGS

<u>Mhz</u>	<u>TUNE</u>	<u>LOAD</u>
1.9	<del>50</del> 60	30
3.7	77	57
7.2	45	40
10.1	22	<del>30</del> 65
14.2	<del>22</del> 53	60 65
18.1	<del>47</del> 50	65 82
21.2	<del>32</del> 45	75 86
24.9	<del>44</del> 55	70 84
29.0	12 25	85 90



## 8.0 - FAULTS AND PROTECTIVE FUNCTIONS

8.1 Soft Faults: Two conditions may cause soft faults...

- a) Improper operating conditions, usually overdrive (and possibly excessive plate or grid current), high load VSWR, or improper T/R control cable connections or timing.
- b) Abnormal amplifier conditions (e.g., low bias) which may result in damage only in the transmit mode.

When such a condition occurs, the control system automatically switches the amplifier to STBY and the appropriate FAULT LED illuminates to indicate the nature of the fault (see front panel pictorial).

To reset a soft fault...

- a) Return the transceiver to receive
- b) Switch the *ALPHA 89* to STBY (standby)
- c) Correct the condition that caused the fault
- d) Return the *ALPHA 89* to OPR (operate), and...
- e) Resume transmission

8.2 Hard Faults: Failures such as HV shorts (extremely high plate current) or bias or control system failure result in immediate shutdown of amplifier AC power to avoid damage.

To reset a hard fault...

After the cause of the hard (power-off) fault is found and corrected, simply press the ON button and wait for warmup time-delay to complete. Resume operation when desired.

8.3 ALC: No ALC connection normally is needed when using modern transceivers having smooth RF output control. In the rare case where faults or distortion occur because transceiver output cannot be well controlled it will be necessary to contact the transceiver manufacturer for assistance to determine the correct technique to reduce transceiver output. This may require adjustment of internal transceiver controls. See section 9, "overdrive-related faults", for further information.

## 9.0 - TROUBLESHOOTING SUGGESTIONS

Most apparent problems with the *ALPHA 89*, especially when first putting one into operation, result directly from failure to observe carefully the procedures given in this manual, especially those given as cautions on pages 1 and 2. A few other points learned from experience are given here.

**Footswitch use:** Users have found that some footswitches exhibit severe contact bounce which can intermittently cause improper T/R sequencing. Usually this shows up as amplifier dropout (transceiver bypass to the antenna) on occasional CW characters or SSB transmit periods. A capacitor of about .001-.05 mfd placed directly across the switch contacts normally cures the problem.

**Overdrive-related faults:** These nearly always result from failure to set up the transceiver power controls (there may be two controls which interact) according to manufacturer's instructions. In the rare situation when transceiver output cannot be controlled adequately, with reference to page 2, item 1, ALC control feedback to the transceiver might help solve the problem if the transceiver has an external ALC input and a conventional negative-going-from-zero ALC system. (Refer to fig. 7, page 7a for what follows.)

Connect the transceiver ALC input line to the *ALPHA 89* ALC jack using an "RCA" type plug and shielded cable. Turn the ALC control pot adjustment fully counterclockwise. Then, while driving the amplifier with about 50W peak drive, turn the ALC control pot clockwise just far enough to eliminate overdrive faults and/or distortion — with some transceivers this may be only a fraction of a turn.

Ideally, the ALC is checked with an oscilloscope connected between the amplifier's RF output and the load. With the amplifier initially in standby the transceiver is driven with a two-tone audio signal and the RF waveform observed. No waveform distortion or peak clipping should be evident. With the amplifier switched on-line the waveform on the 'scope should be of greater amplitude but "clean" as before.

If you do not have a 'scope, the following procedure will probably prove satisfactory:

Check under CW carrier and SSB voice conditions for any indication of distortion or "motorboating" (signal instability or oscillation). If any is detected, reduce the ALC control setting (CCW) until the distortion disappears. Alternate between drive and ALC control adjustments if necessary to obtain smooth operation.

Do not expect ALC to be an overdrive "cure-all". ALC should be used only to provide fine adjustment of transceiver output (say, reducing it from 55 or 60 to 50 watts) rather than gross limiting (150 watts down to 50). Expecting transceiver ALC range to handle gross overdrive is unrealistic; the transceiver may not be able to accept such excessive control voltage input and will probably have a severely distorted signal. This signal will then be "linearly" amplified by the *ALPHA 89* so that it is not only loud but obnoxious as well, earning the unlucky operator the distinction of being a one-man-pileup on the frequency!

## 10.0 - ALPHA 89 FUNCTIONAL CONFIGURATION

Figure 8 on the following page is a simplified block diagram of the *ALPHA 89*.

- 1) Principal functional components are emphasized as follows:
  - a) Heavy rectangular boxes represent individual modules of the amplifier, in most (but not all) cases circuit boards (PCBs).
  - b) Signal paths used in both transmit and receive are shown by heavy solid lines.
  - c) Signal paths used only in transmit, by heavy dashed lines.
  - d) Signal paths used only in receive, by heavy dotted lines.
  - e) Internal wiring harnesses are shown as light solid lines. Each is labeled with the designations of the control, monitoring and power distribution lines which comprise it.
  - f) Principal interfaces to the outside (connectors & controls) are located around the perimeter of the block diagram.
- 2) Transmit signal path: Drive from the transceiver, applied at the TX RF INPUT connector, passes sequentially through the input wattmeter, tube deck T/R section, input t/r pcb, input matching network, (pair of) 3CX800A7 triode tubes, plate tuning network, dual pin diode pcb, output t/r pcb, and output wattmeter pcb to the tx rf out/rx rf in jack.
- 3) Receive signal path: Tx rf out/rx rf in jack, output wattmeter, output t/r pcb, input t/r pcb, tube deck t/r section, and input wattmeter to the tx rf input jack which is of course also the rx signal output to the transceiver.

While the complexity of the *ALPHA 89* is such that describing its circuitry in detail here is impractical, one set of schematics will be provided at no charge to any owner on request, and assistance with specific questions or problems is always available from ETO Customer Service.

1. ALL CAPACITOR VALUES ARE  $\mu\text{F}$  AND ALL RESISTOR VALUES ARE 1/4 WATT.
2. ALL 'ABX' DESIGNATORS INDICATE PRINTED CIRCUIT BOARDS.

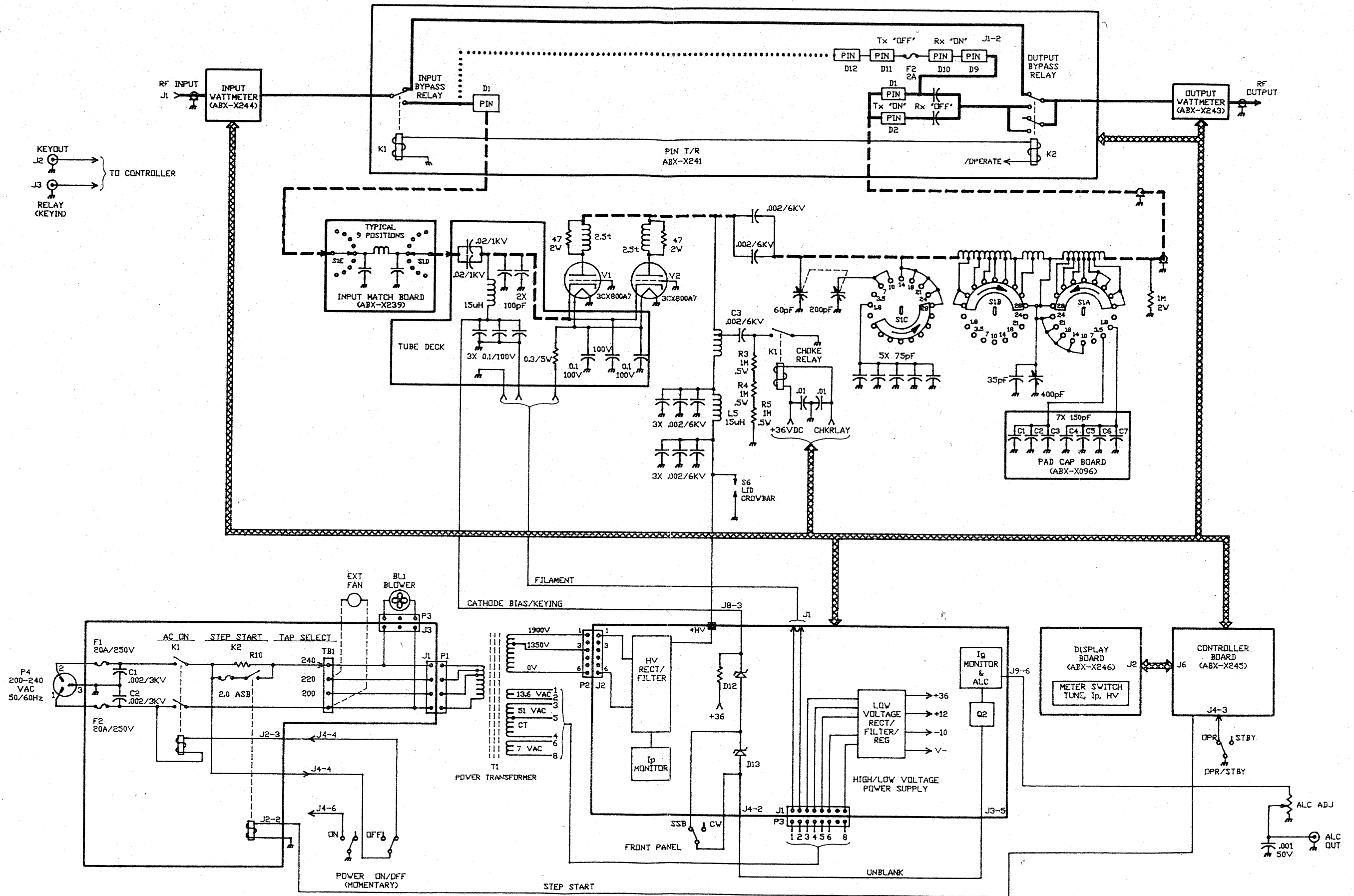

——— Tx & Rx COMMON RF PATH  
 - - - Tx ONLY RF PATH  
 ..... Rx ONLY RF PATH  
 [Cross-hatched] CONTROL BUSS

**ALPHA 89 SIMPLIFIED SCHEMATIC**  
**FIGURE 8**