

CONTENTS

INTRODUCTION.....	1
FEATURES.....	1
SPECIFICATIONS.....	2
EXPLANATION OF FEATURES.....	3-5
INSTALLATION.....	6
DIAGRAM OF RX GAIN.....	7
B-24-G OPTIONAL ADAPTORS.....	8-9
PRECAUTIONS.....	10-11
CONNECTION DIAGRAM.....	12
B-24-G BOOSTER AMP. BLOCK CIRCUIT.....	13
WARRANTY.....	14

INTRODUCTION

The B-24-G is a VHF band high power linear amplifier designed for the 144 MHz band. It has a maximum output power of 50W.

With a combination of built-in low noise GaAsFET receive pre-amp, the B-24-G enables you to enjoy a more comfortable VHF DX QSO.

FEATURES

1. High output power of 50W.
50W average is achieved with 1~5W input power.
2. Aluminum heat sink.
Aluminum heat sink combined with the case is designed for an excellent heat dissipation effect.

SPECIFICATION

FREQUENCY	: 144 MHz
MODE	: F3 (FM)
INPUT POWER	: 1-5W
D.C. OUTPUT POWER	: 50W
DC POWER SUPPLY	: DC 13.8V
OUTPUT CONSUMPTION	: 8A (MAX.)
INPUT/OUTPUT IMPEDANCE	: 50 Ohm
INPUT/OUTPUT CONNECTOR	: BNC/M TYPE
RX GAIN	: 18 dB
ACCESSORY CIRCUIT	: COX (Carrier Operated T/R switch, RX pre-amp)
ACCESSORIES	: Mobile mounting bracket, FUSE (8A), Instruction Manual, docking adaptor.
DIMENSIONS	: 3.4(W)*6.0(H)*3.4(D)in
WEIGHT	: approx. 1.5 lbs.

EXPLANATION OF FEATURES

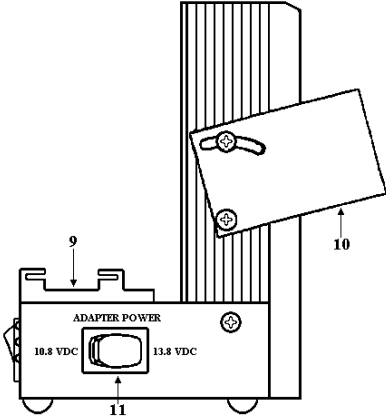
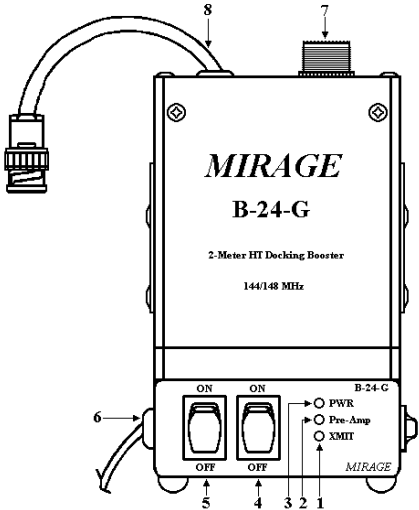

1. **PWR INDICATOR**
The PWR Indicator LED indicates the amplifier is transmitting or on air.
2. **PRE-AMP INDICATOR**
When the PRE-AMP Indicator LED is on, it indicates the amplifier is in the RX mode and boosts the signal received.
3. **TX INDICATOR**
The TX Indicator LED indicates the amplifier is ON and in Stand-By mode. The amplifier is now ready to transmit.
4. **PRE-AMP/OFF SWITCH**
When this switch is ON (upper position), the pre-amp unit boosts the signal received.
5. **TX/OFF SWITCH**
ON (upper position): The amplifier is ready to transmit. (Max. 50W)
OFF (lower position): The amplifier is on receive mode only.
6. **DC INPUT (13.8V)**
This port has two wires. Connect it to a stable DC power supply (13.8V) or battery. The red wire has a fuse holder and is the positive lead. The black wire is the negative lead. (FUSE holder is on the positive DC lead.)

7. ANT
The Antenna can be connected directly here.
8. TX (RF INPUT)
This is a BNC connector that should be connected directly to the handy-transceiver.
9. DOCKING ADAPTOR
There are various adaptors suitable for different models of handy-transceivers.
10. MOUNTING BRACKET
The mounting bracket allows easy attachment of your B-24-G to your car.
11. ADAPTER POWER SWITCH
The adaptor power can be turned OFF (middle position) when the amplifier is not in use. You can select the adaptor to be 10.8V (left position) for new HT models or 13.8V (right position) for older models depending on your HT.

INSTALLATION

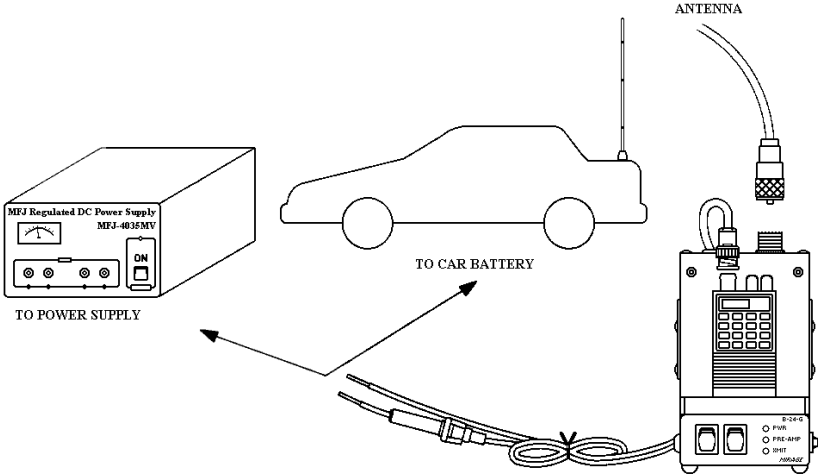

B-24-G OPTIONAL ADAPTORS

HAM RADIO MAKER	ADAPTOR MODEL	COMPATIBLE TRANSCEIVER MODEL NO.
ICOM	MI-1	IC-2N, 02N, 3N, 03N, 12N, 2G, 3G, 12G, 23, etc.
ICOM	MI-2	IC-2S, 2SAT, 2SR, 3S, 3SAT, 3SR, 24, W2, X2, etc.
ICOM	MI-3	IC-W21, X21, W21T, X21T etc.
ICOM	MI-4	IC-T22, T42
YAESU	MY-1	FT-23, 204, 73, 704, 104, 728, etc.
YAESU	MY-2	FT-24, 74, 205, 705, 305, 805, 729, etc.
YAESU	MY-3	FT-11
YAESU	MY-4	FT-50
KENWOOD	MK-1	TH-25, 25G, 45, 45G, 55, 75, 77, etc.
KENWOOD	MK-2	TH-22A, 22AT, 42A, 42AT, 59, 79, 79E, etc.
STANDARD	MS-1	C150, C450, C520, C550, 620, etc.

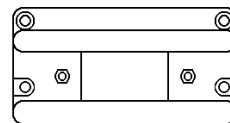

B-24-G

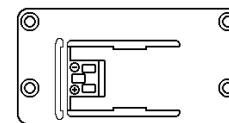

MY-2

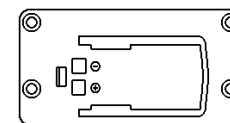

MI-3

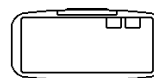

MK-2

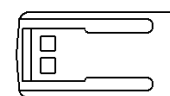

MY-1

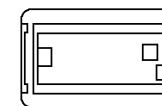

MS-1

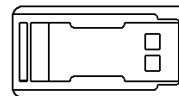

MK-1

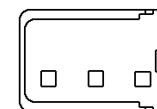

MI-2

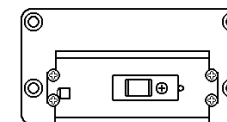

MI-1

ADAPTORS and ADAPTOR POWER SETTING

HAM RADIO MAKER	ADAPTOR MODEL	ADAPTOR POWER SETTING
ICOM	MI-1	13.8
ICOM	MI-2	13.8
ICOM	MI-3	13.8
ICOM	MI-4	10.8
YAESU	MY-1	10.8
YAESU	MY-2	13.8
YAESU	MY-3	10.8
YAESU	MY-4	10.8
KENWOOD	MK-1	10.8
KENWOOD	MK-2	10.8
STANDARD	MS-1	13.8

PRECAUTIONS

To avoid malfunctions and damages, and to achieve full performance, please pay careful attention to the following matters:

1. During transmission, the heat sink may reach a high temperature (approx. 50°C-80°C). Set the amplifier in a well-ventilated place. Do not place objects on top of the amplifier. Do not operate the amp in places exposed to direct sunlight or close to a heater, etc.
2. If the antenna matching condition is poor (or the SWR is high), please try to lower the SWR. This is also important to ensure the efficient transmitting of output power from the antenna. Also, check make sure the antenna is properly connected and there is no short or open before operation.
3. Keep the input power at 5W or less.
4. Be careful that the DC voltage is kept below 13.8V (12-14V). The amplifier could be damaged is connected to a DC 24V battery (for truck use) or AC power source.

5. Never connect the whip antenna of a handy-transceiver directly to the antenna connector of the amplifier unit using M-BNC converting connector etc. It may cause damage to the antenna due to insufficient power capacity. It may also damage the transceiver or the amplifier when strong RF signal intrusions occur.
6. Be sure to use a 50Ω coaxial cable for the various connections. When the impedance differs as with a 75Ω cable, reflected waves will cause a mis-match. This condition makes it difficult to achieve full power from the amplifier and it may cause the RF power transistor to be damaged.
7. When using a stabilized DC power supply, the output voltage may rise to an abnormal level due to RF signal intrusions. Therefore, use a power supply with sufficient current capacity (7A or more) as well as a good protective device for RF intrusions. If the power supply malfunctions, discontinue operation by turning off the power switch and make sure the connection of the amplifier to the power supply is correct (a diagram is shown on the following page).
8. The cord may be burned if the power supply is connected in reverse polarity, especially if the power source is a battery. Check the polarity well before connection. The interior of this amplifier is protected from a reverse polarity connection by a protection circuit.

CONNECTION DIAGRAM

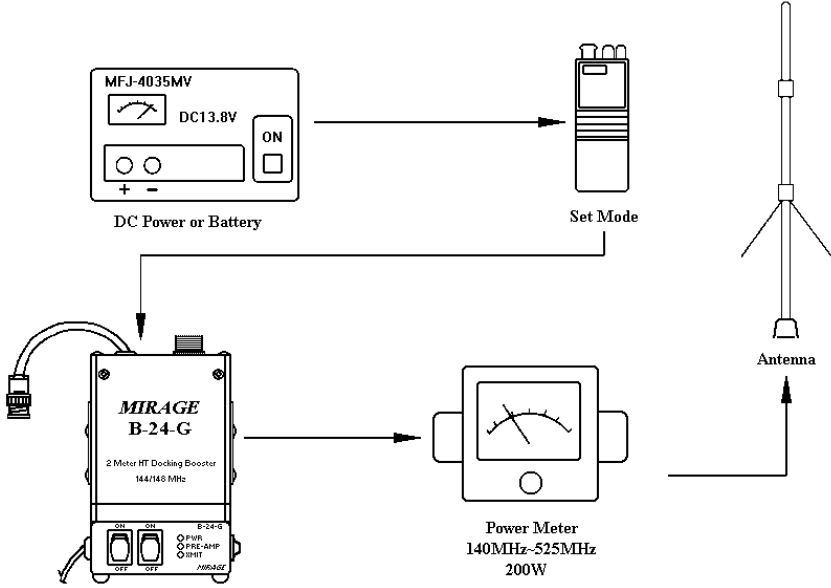

B-24-G BOOSTER AMP. BLOCK CIRCUIT

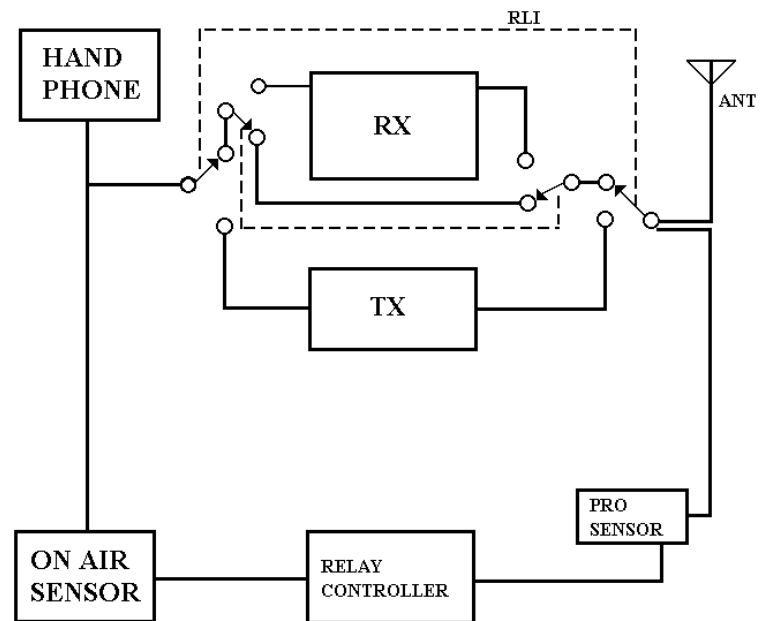

MIRAGE

COMMUNICATION EQUIPMENT

300 Industrial Park Road
Starkville, MS 39759 USA
Tel: (601) 323-8287
FAX: (601) 323-6551

ONE YEAR LIMITED WARRANTY

Any Mirage Communications product found to be defective in materials or workmanship will be repaired or replaced (at Mirage's option) for a period of one year from the date of original purchase.

During the warranty period Mirage Communications will provide, free of charge, both parts and labor necessary to correct defects in material or workmanship.

- To obtain such warranty service, the original purchaser must:
 - (1) Provide "proof of purchase"
 - (2) Ship the product in its original container or equivalent, fully insured and shipping charges prepaid, to Mirage, as addressed below.
- All internal adjustments are factory set for best performance consistent with reliable operation. Changing internal adjustments may void this warranty.
- Improper maintenance or repair may also void this one year warranty. We recommend that units requiring repair during the warranty period be returned to the factory.
- This unit was not designed for repeater operation, and its use in such service is at your own risk.
- Mirage assumes no responsibility for any item connected to or used in conjunction with this product.
- The foregoing constitutes Mirage's entire obligation with respect to this product and the original purchaser and any user or owner shall have no remedy and no claim for incidental or consequential damages.
- All Mirage products to be serviced, in-warranty or out-of-warranty, should be shipped, freight paid to: **Mirage, 921 Louisville Road, Starkville, MS 39759, USA.** Product must be accompanied by a letter describing the problem in detail. Be sure to include **YOUR NAME, ADDRESS, AND TELEPHONE NUMBER!**
- This warranty gives specific legal rights and you may also have other rights which vary from state to state.

WARNING: This unit should not be operated with the cover removed. The cover confines RF radiation. The harmonic filters contained in the circuit will not suppress direct radiation that may result if the cover is removed.