

# TABLE OF CONTENTS

<b>TABLE OF CONTENTS</b>	i-ii
<b>LIST OF ILLUSTRATIONS</b>	iii-iv
<b>SPECIFICATIONS</b>	v-vi
<b>WARNING NOTICES</b>	vii
<b>10 METER OPERATION</b>	vii
<b>INTRODUCTION</b>	viii
<b>UNPACKING</b>	ix

## 1 INSTALLATION

1.1	INTRODUCTION	1-1
1.2	ELECTRICAL CONNECTIONS	1-1
1.3	HIGH VOLTAGE TRANSFORMER INSTALLATION	1-1
1.4	TRANSCEIVER INTERCONNECTIONS	1-2
1.5	ANTENNA REQUIREMENTS	1-2
1.6	GROUND CONNECTION	1-2
1.7	HIGH POWER OPERATION	1-2
1.8	ALC	1-3
1.9	COOLING SYSTEM	1-3

## 2 OPERATING INSTRUCTIONS

2.1	INTRODUCTION	2-1
2.2	FRONT PANEL CONTROLS	2-1
2.2.1	BAND SWITCH	2-1
2.2.2	TUNE	2-1
2.2.3	LOAD	2-1
2.2.4	POWER	2-1
2.2.5	OPR-STBY	2-1
2.2.6	QSK-PTT	2-1
2.2.7	MULTI-METER SWITCH	2-1
2.2.7.a	Ep	2-1
2.2.7.b	Is	2-2
2.2.7.c	FWD	2-2
2.2.7.d	REF	2-2
2.2.8	PLATE CURRENT METER	2-2
2.2.9	OVERDRIVE	2-2
2.2.10	WAIT	2-2
2.2.11	PEAK POWER BARGRAPH	2-2

2.3	REAR PANEL CONNECTIONS AND CONTROLS	2-2
2.3.1	TRANSCEIVER	2-2
2.3.2	ANTENNA	2-2
2.3.3	KEY IN	2-2
2.3.4	KEY OUT	2-2
2.3.5	PTT/VOX	2-2
2.3.6	ALC	2-3
2.3.7	ALC CONTROL	2-3
2.3.8	AC LINE	2-3
2.3.9	LINE FUSES	2-3
2.4	INITIAL TURN-ON	2-3
2.5	TUNE – UP PROCEDURE	2-3
2.5.1	CHECKS TO MAKE BEFORE TUNING UP	2-3
2.5.2	IMPORTANT POINTS TO REMEMBER	2-3
2.5.3	SUGGESTED TUNE – UP PROCEDURE	2-4
<b>3 OPERATION AND SAFETY</b>		
3.1	INTRODUCTION	3-1
3.1.1	TUBES	3-1
3.1.2	INTERLOCKS	3-1
3.1.3	FUSES	3-1
<b>4 TROUBLESHOOTING</b>		
4.1	INTRODUCTION	4-1
4.2	MAINTENANCE	4-1
<b>5 CIRCUIT DESCRIPTIONS AND ILLUSTRATIONS</b>		
5.1	INTRODUCTION	5-1
5.2	INPUT MATCHING ASSEMBLY <b>A6</b> (81946) AND 15M FILTER ASSEMBLY <b>A7</b> (81953)	5-1
5.3	HIGH VOLTAGE RECTIFIER ASSEMBLY <b>A2</b> (81944)	5-3
5.4	SCREEN SUPPLY AND GRID BIAS ASSEMBLY <b>A10</b> (81950)	5-4
5.5	QSK ASSEMBLY <b>A11</b> (81949)	5-6
5.6	SWR ASSEMBLY <b>A4</b> / RELAY <b>A14</b> (81951 / 81959)	5-8
5.7	PLATE CONNECTOR ASSEMBLY <b>A3</b> (81948)	5-9
5.8	METER/SWITCH/DISPLAY ASSEMBLIES <b>A12</b> and <b>A13</b> (81947 and 81952)	5-10
5.9	HV-AC LINE INPUT ASSEMBLY <b>A9</b> (81945)	5-12
5.10	LOAD SHUNT ASSEMBLY <b>A5</b> (81943)	5-14
5.11	SCHEMATIC DIAGRAM, MODEL 417A AMPLIFIER	5-15
<b>6 MASTER PARTS LIST</b>		
		6-1

## LIST OF ILLUSTRATIONS

FIG	DESCRIPTION	PAGE
1-1	T/R CONNECTIONS FOR TEN-TEC TRANSCEIVERS WITH TX OUT AND TX EN	1-4
1-2	T/R CONNECTIONS FOR OTHER TRANSCEIVERS	1-4
2-1	MODEL 417A TUNING CHART	2-5
2-2	MODEL 417A TUNING LOG	2-6
2-3	MODEL 417A FRONT PANEL	2-7
2-4	MODEL 417A REAR PANEL	2-7
2-5	MODEL 417A TOP VIEW	2-8
2-6	MODEL 417A BOTTTOM VIEW	2-9
4-1	TROUBLESHOOTING HINTS	4-1
ASSEMBLY <b>A6</b> (81946) INPUT MATCHING BOARD		
5-1	CIRCUIT TRACE	5-2
5-2	COMPONENT LAYOUT	5-2
ASSEMBLY <b>A2</b> (81944) H.V. POWER SUPPLY BOARD		
5-3	CIRCUIT TRACE	5-3
5-4	COMPONENT LAYOUT	5-3
ASSEMBLY <b>A10</b> (81950) SCREEN SPLY / GRID BIAS BOARD		
5-5	COMPONENT LAYOUT	5-4
5-6	CIRCUIT TRACE	5-5
ASSEMBLY <b>A11</b> (81949) QSK BOARD		
5-7	COMPONENT LAYOUT	5-6
5-8	CIRCUIT TRACE	5-7
ASSEMBLY <b>A4</b> (81951) SWR BOARD		
5-9	CIRCUIT TRACE	5-8
5-10	COMPONENT LAYOUT	5-8
ASSEMBLY <b>A3</b> (81948) PLATE CONNECTOR BOARD		
5-11	CIRCUIT TRACE	5-9
5-12	COMPONENT LAYOUT	5-9

	<b>ASSEMBLY A12 (81947) METER/SWITCH BOARD</b>	5-10
5-13	COMPONENT LAYOUT	5-11
5-14	CIRCUIT TRACE	
	<b>ASSEMBLY A13 (81952) DISPLAY BOARD</b>	5-10
5-15	COMPONENT LAYOUT & TOP CIRCUIT	5-12
5-16	BOTTOM CIRCUIT TRACE	
	<b>ASSEMBLY A9 (81945) AC LINE / DELAY BOARD</b>	5-12
5-17	COMPONENT LAYOUT	5-13
5-18	CIRCUIT TRACE	
	<b>ASSEMBLY A5 (81943) LOAD SHUNT BOARD</b>	5-14
5-19	CIRCUIT TRACE	5-14
5-20	COMPONENT LAYOUT	
		5-15
5-21	SCHEMATIC DIAGRAM, MODEL 417A	

## **SPECIFICATIONS**

### **MODEL 417A**

BAND COVERAGE	160, 80, 40, 30, 20, 17, and 15 meters (12 and 10 meters for authorized users).
POWER OUTPUT	1500 watts continuous in SSB, CW, AMTOR/PACTOR (50% duty cycle modes) on all bands. 1000 watts RTTY/SSTV (continuous duty cycle modes) for up to 10 minutes key down on all bands.
DRIVING POWER	60 watts typical for 1500 watts output.
PLATE EFFICIENCY	Up to 65% depending on band, frequency, line voltage and impedance load.
INPUT AND OUTPUT IMPEDANCE	50 ohms unbalanced with VSWR <2:1
HARMONICS	Meets or exceeds FCC requirements.
CW BREAK-IN	Built-in T/R switching in less than 7 ms.
PROTECTIVE CIRCUITS	A.) Screen grid voltage regulation, current limiting, over voltage protection and MOV arc over protection. LED over-current indication. B.) Control grid voltage regulation, current limiting and LED over-current indication. C.) Plate current over-current trip at 1.5 amps. Series resistor for arc absorption.
PRIMARY POWER	240 VAC -10%/+5% @ 20 amps, 50/60 Hz
LINE PROTECTION	Primary line fuses, chassis interlock, and step-start inrush protection.
TUBES	Two Svetlana 4CX800A ceramic tetrodes in grid-driven configuration.
COOLING	Forced air, vertical exhaust, using centrifugal blower to produce .1" of water pressure drop at sea level, 25 degs. C air temperature.

METERING	Full time plate current meter. Second meter selectable for screen grid current, plate voltage, forward power, and reflected power (x10). Peak forward power indicated on full-time LED bargraph display.
FRONT PANEL CONTROLS	TUNE and LOAD control knobs with 6:1 reduction drive. Rotary band switch and meter switch for screen grid current, plate voltage, forward or reverse power. Standby / Operate , QSK / PTT-VOX and Power on/off rocker switches.
STATUS INDICATORS	Power on, wait, standby/operate, screen grid over-current, control grid over-current.
PLATE VOLTAGE SUPPLY	Step-start inrush protected. Approximately 3000 VDC @ no load, approximately 2700 VDC @ full load. 6 amp, 1000 PIV diodes in fullwave bridge circuit. 9 each 220 uF electrolytic filter capacitors. 10 ohm arc absorption resistor.
SCREEN SUPPLY	360 VDC voltage regulated, current limited.
CONSTRUCTION	.125" aluminum plate transformer and RF tank chassis. .062" aluminum control / airbox chassis and covers.
SIZE	HWD = 8.5" x 19" x 20" (21.6 x 48.3 x 50.8 cm)
WEIGHT	84 lbs. (38.18 kg)

# **WARNING!!!!!!**

This amplifier contains lethal voltages when operating.  
DO NOT operate this amplifier with the covers removed.  
The power supply circuits in this amplifier can produce up to  
3000 volts and cause serious injury or death!

# **CAUTION!!!**

Never attempt to operate the *TITAN III* without first  
connecting a suitable antenna or 50 ohm dummy load of  
sufficient power rating or **SERIOUS DAMAGE MAY  
RESULT!**

## **10 / 12 METER OPERATION OF THE *TITAN III* AMPLIFIER**

FCC rules permit licensed amateurs to modify their own amplifiers for operation in the 24.89 – 24.99 MHz and 28 - 29.7 MHz bands. If you enclose a copy of your valid amateur radio license with the warranty registration card for your new amplifier, an optional input matching circuit (assembly A8) and appropriate installation information will be sent to you without charge.

## INTRODUCTION

The Model 417A *TITAN III* is an advanced design linear amplifier using two 4CX800A high power tetrodes in a grid driven configuration. This amplifier uses a ducted forced air cooling system and operates easily at 1500 watts output with maximum efficiency of 65% .

Two panel meters provide system monitoring. One meter is dedicated to full time plate current measurement. The other meter is switchable among plate voltage, screen grid current, forward power, or reflected power.

Two front panel LEDs indicate overdrive conditions for the control grid and screen grid circuits. Plate current overdrive trip is provided at 1.5 amps.

Band coverage includes 160, 80, 40, 30, 20, 17 and 15 meters as shipped from the factory. With proof of authorization, 12 and 10 meters may be enabled with an optional matching network from TEN-TEC (model # 417A-10).

Primary power of 240 VAC is required. Remember, tune-up at 1500 watts output and 240 VAC line voltage can require up to 20 amps line current. The *TITAN III* primary AC lines are fused at 20 amps. ABC-20 fuses or equivalent must be used in replacement to protect the tubes. Interlocks on the high voltage power supply are provided to ensure operator safety. ***NEVER DEFEAT THESE SAFETY PRECAUTIONS !!!!***



## UNPACKING

Carefully remove the amplifier from the packing carton and inspect it for signs of damage. Carefully remove the high voltage power transformer from its' packing carton and inspect it for signs of damage. If the amplifier or transformer has been damaged, notify the delivering carrier immediately, stating the full extent of the damage. Save all damaged cartons and packing material. **Liability for any shipping damage rests with the shipping carrier.**

Complete the warranty registration form and mail to TEN-TEC immediately (include a copy of your amateur radio license if you are requesting the 10 meter option). Save the packing material for re-use in the event that moving, storage, or reshipment is necessary.

Shipment of your *TITAN III* in other than factory packing material may result in damage. This is not covered under TEN-TEC warranty.

The following hardware and accessories are packed with your *TITAN III*. Make sure you have not overlooked anything.

2 ea.	20 AMP ABC-20 fuses	27038
2 ea.	1 <sup>1</sup> / <sub>2</sub> AMP MDL-1 <sup>1</sup> / <sub>2</sub> fuses	27018
1 ea.	key cable	46160
1 ea.	.056 allen wrench	38040
1 ea.	.062 allen wrench	38088
1 ea.	# 8 allen wrench	38124
4 ea.	#10 hex nuts (for plate transformer installation)	54005
24ea.	4x40 short black flathead screw (to finish installation of top cover)	60080
1 ea.	warranty card	74020
1 ea.	operator's manual	74367
2 ea.	spare 14" tube chimney clamp	38265

If any of the above are missing, contact the repair department at TEN-TEC for replacement.

Repair dept. (865) 428-0364  
Switchboard (865) 453-7172  
FAX (865) 428-4483

Before powering up your *TITAN III*, visually inspect the unit for possible physical damage, such as dents or parts jarred loose during shipment. If you remove the top cover, remember that safety interlocks on both line and high voltage prevent power up. Do not connect this amplifier to AC power without the power transformer installed and the top cover securely held to the chassis with the provided cabinet screws.

# CHAPTER 1

## INSTALLATION

**1.1 INTRODUCTION:** When setting up the station, provide adequate ventilation for the amplifier. Also, select a location that allows comfortable access to the front controls and adequate clearance for rear panel connections.

**1.2 ELECTRICAL CONNECTIONS:** The *TITAN III* amplifier draws up to 20 amps at 240 VAC. Care should be taken not to overload house wiring circuits usually fused or circuit breakered at 15 to 20 amps. A straight run circuit with # 10 / 2 wire with ground and breaker or fuses at 20 amps is strongly advised. Do not connect the *TITAN III* to AC voltage until installation of HV power transformer is completed.

**1.3 HIGH VOLTAGE TRANSFORMER INSTALLATION:** DO NOT CONNECT THE AC LINE CORD TO 240 VAC WALL OUTLET BEFORE INSTALLATION OF THE HV POWER TRANSFORMER.

Check to make sure the amplifier is unplugged from the wall. Remove the top cover of the amplifier. Note only 10 screws were initially installed at the factory. This was done to simplify your task. (If the cover won't come off, check for screws in the underside bottom edges). Temporarily remove the left side chassis rail (four longer flat-head screws). There are four 10 x 32 nuts (TEN-TEC part #54005) in the packing kit. You must use these to mount the transformer and **not** the nuts in the transformer shipping carton. Identify the large open area in the chassis where the transformer mounts. Note the location of the four threaded studs in the chassis. Start two nuts on only the two studs closest to the center of the amplifier chassis. Just "start" the two nuts, engaging only a few threads. Orient the transformer with the two wire HV

lead side of the transformer coil toward the center chassis shield. Being careful not to disturb the printed circuit board behind the meters, align the slots in the transformer bottom mounting bracket under the two nuts that you just installed. Slide the transformer toward the center shield until the studs are seated in the transformer mounting slots about midway. Align the slots in the other bottom mounting bracket with the two remaining studs in the floor of the chassis near the outside of the amp. Install the two remaining nuts on the open studs. Using a long nut driver or socket, tighten all four nuts. Connect the two wire HV cable to the socket on the HV rectifier board A2 (81944) mounted on the center shield. Note the plug will seat properly in the socket in one direction only. Visually inspect the connection for proper seating. Connect the four wire primary cable to the four wire cable extending from the rear chassis area near the smaller low voltage transformer. Again this plug will only seat properly in one direction. Care should be taken when re-installing the side rail and top cover not to pinch this cable. Excess cable length may be looped and tucked between the side rail and fan housing scroll. Remember to install all 34 screws in the top cover when re-assembling. The extras you need are in the packing kit. To access the five screws along each bottom edge, carefully tilt the amplifier on it's side or slide it to the edge of the table and work from below.

**Never ship or transport the amplifier with the transformer installed !!!** Serious damage to the chassis may result.

## 1.4 TRANSCEIVER

**INTERCONNECTIONS:** When using the *TITAN III* with TEN-TEC transceivers with TX EN and TX OUT connectors, follow the diagram in Figure 1-1. The QSK-PTT/VOX switch on the *TITAN III* should be in the QSK position for all modes of operation. This hook-up arrangement will work with the OMNI series, PARAGON I and II, PEGASUS, JUPITER, and ORION. Some modern Yaesu transceivers are also equipped with a full break-in keying loop that can be utilized in a similar fashion. If you are unsure about connecting this equipment, please contact the TEN-TEC factory for instructions.

When connecting the *TITAN III* with all other transceivers, use the diagram in Figure 1-2. Note that the key or keyer must be connected to the KEY IN jack on the *TITAN III*, a cable is run from KEY OUT to the key input jack on your transceiver, and the line from the external T/R N.O. relay contacts on the transceiver must be connected to the PTT/QSK jack on the *TITAN III*. When using this configuration, the QSK-PTT/VOX switch on the amplifier must be in the PTT/VOX position for SSB operation and in the QSK position for CW operation.

## 1.5 ANTENNA REQUIREMENTS:

The *TITAN III* amplifier is designed for use with antennas resonant at the frequency of operation and having an impedance within the limit of 25 to 100 ohms, or an SWR of 2:1 or less (<10% reflected power). Note that any SWR other than 1:1 will result in TUNE and LOAD settings different from those in the manual reference chart (Figure 2-1). The nominal load impedance of the amplifier is 50 ohms. Antennas can exhibit an SWR of more than 2:1 in some part of the band. For operation under these conditions, we recommend using an antenna matching network that will enable the *TITAN III* to work into a 50 ohm load for maximum power transfer to the antenna.

# CAUTION!!!

Never attempt to operate the *TITAN III* without first connecting a suitable antenna or 50 ohm resistive load of sufficient power rating or **SERIOUS DAMAGE MAY RESULT!**

**1.6 GROUND CONNECTION:** In the interest of personal safety and to reduce the possibility of stray RF pickup on interconnecting cables, all station equipment should be well grounded to earth and to supply line ground bus. It is important to strap all equipment chassis together with short heavy leads. This ground bus may then be tied to an external earth grounding rod.

**1.7 HIGH POWER OPERATION:** The *TITAN III* amplifier operates comfortably at a maximum of 1500 watts output. New owners often find that other components in their station may not. Before operating at this power level, be certain to check the following items:

1. The coax from the *TITAN III* to the feed point of your antenna must be top quality RG-8 or better. We recommend silver plated connectors rather than chrome plated connectors. Make sure that all coax connectors are tight.
2. All coax switches or relays in the feed line must be rated at 1500 watts or higher. **NEVER ACTIVATE IN-LINE SWITCHES WHILE TRANSMITTING.**
3. Verify that the components in your antennas are rated for the *TITAN III* maximum power levels (dipole center insulator, end insulators, baluns, traps, etc.) Make sure that all radiating sections are well clear of metallic objects such as rain gutters and antenna supporting

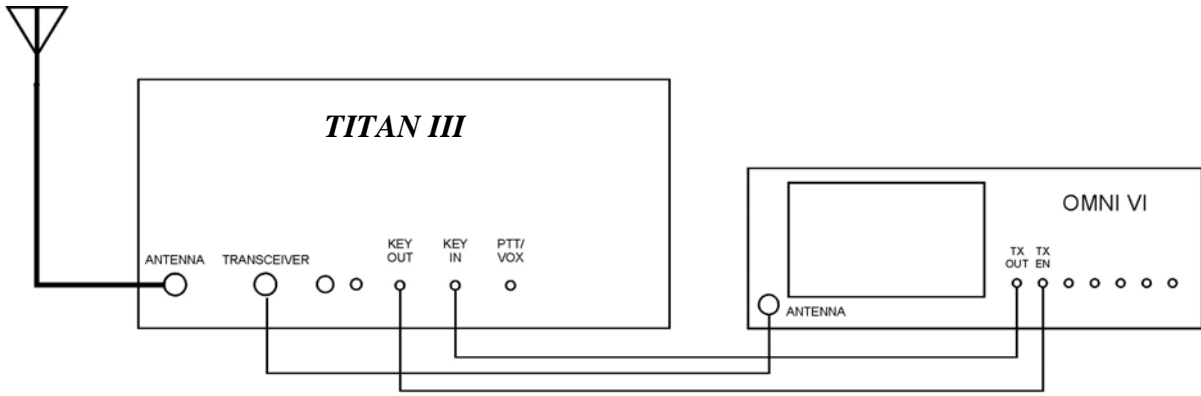
structures. For the first few hours of operation, check the SWR frequently. Any increase in reflected power is an indication that something between the amplifier and the antenna elements, including the end insulators, is heating and must be corrected.

4. A solid earth ground is often essential. Every station will have a unique electrical ground due to location of equipment, distance between units, distance from house wiring ground rod, distance from RF ground rod, etc. Keep equipment ground straps as short and thick as possible and RF ground rod as close to the station as possible.
5. If you use an antenna tuner, make all SWR/matching adjustments with the *TITAN III* in the STANDBY mode using transceiver low power only.
6. If any of your home entertainment electronic devices have RF leaks, the *TITAN III* may find them. If you are not familiar with standard procedure for controlling this type of interference, consult the ARRL Radio Frequency Interference Manual.

**1.8 ALC:** Most solid state transceivers do not provide connection for ALC input and it is unnecessary to make any external ALC connection to these rigs. The ALC output jack is used primarily with tube-type transmitters or transceivers with a negative going ALC system. The ALC ADJUST control is used to set the threshold for proper ALC action. This is -1 to -15 VDC

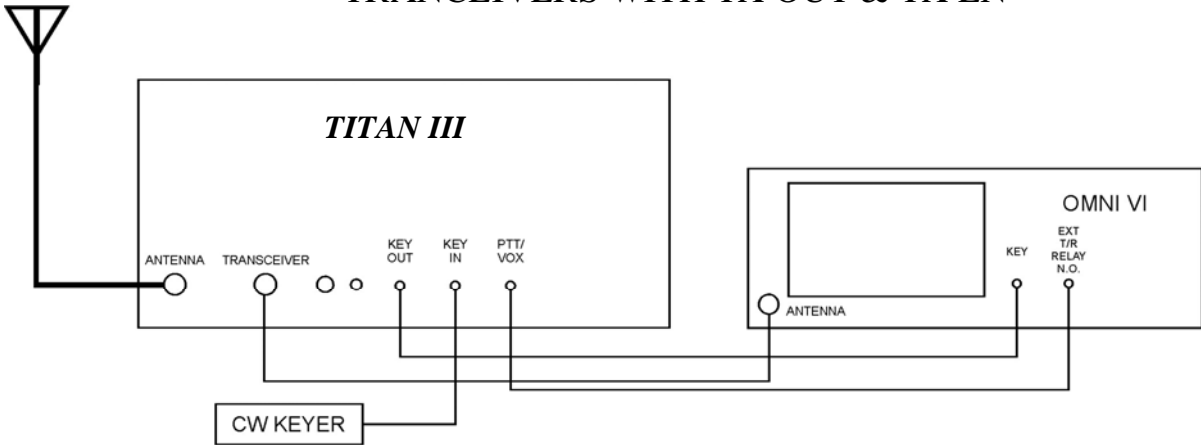
depending on input RF drive level. A negative output voltage will be present at the ALC jack only when the *TITAN III* is in the OPERATE mode and the input RF drive is above the threshold setting. Leave this control fully clockwise if you have no requirement for external ALC.

**1.9 COOLING SYSTEM:** The *TITAN III* uses a pressurized cabinet with the main air intake through the right front side of the chassis and exhaust through the tube chimneys on the right rear top of the amplifier. It is safe to operate the amplifier as long as there are no impediments to the flow of air near the air intakes and/or the exhaust.



<i>TITAN III</i>	TEN-TEC TRANSCIVERS
KEY IN	TX OUT
KEY OUT	TX EN
TRANSCEIVER	ANTENNA

**FIGURE 1-1** T/R CONNECTIONS FOR TEN-TEC TRANSCIVERS WITH TX OUT & TX EN



<i>TITAN III</i>	OTHER TRANSCIVERS
KEY OUT	KEY
PTT/VOX	EXT. T/R N.O. RELAY
TRANSCEIVER	ANTENNA

**FIGURE 1-2** T/R CONNECTIONS FOR OTHER TRANSCIVERS WITHOUT TX OUT & TX EN

## CHAPTER 2

### OPERATING INSTRUCTIONS

**2.1 INTRODUCTION:** The following instructions will enable the operator to quickly place the *TITAN III* in operation. Included are descriptions of the front panel controls and rear panel connections, followed by a detailed tune-up procedure. Refer to Chapter 3 operation and safety tips.

**2.2 FRONT PANEL CONTROLS:** The front panel controls and their functions are described below.

**2.2.1 BAND SWITCH:** This switch selects the desired frequency of operation. This is a ten position switch that covers the 160 meter to 10 meter bands. NOTE: A built-in switch stop prevents operation in the 10 and 12 meter bands. For 10 and 12 meter operation you must contact the factory for an authorized modification kit.

**2.2.2 TUNE:** This control adjusts variable capacitor C1 to provide resonance at the operating frequency. Figure 2-1 shows the approximate settings for both the TUNE and LOAD controls on each band. Keep in mind that the settings in this chart are for operation into an ideal 50 ohm resistive load. There is also a blank log chart that you may use to record the actual control settings for your antennas.

**2.2.3 LOAD:** This control adjusts variable capacitor C2 for the proper amplifier output loading. See Figure 2-1.

**2.2.4 POWER:** This switch routes the AC line to the primary of the low voltage supply. When on, the *TITAN III* will power up and the indicator light in the POWER switch will light.

**2.2.5 OPERATE/STANDBY:** This switch, when in the OPERATE position, places the amplifier online. When in the STANDBY position, the amplifier is bypassed and only the transceiver power is routed to the antenna. When in the OPERATE position, the indicator light in the switch will light. NOTE: No high voltage will be read on the metering when this switch is in STANDBY.

The OPERATE/STANDBY switch also serves as the plate current trip-off circuit reset switch. At 1.5 amps plate current, the plate current trip-off circuitry will activate. The lighted segment of the OPERATE/STANDBY switch will go out when plate current trip-off has occurred. To reset, switch back to STANDBY and immediately back to OPERATE. The lighted segment of the switch should now be lit again and the amplifier is ready to use.

**2.2.6 QSK/PTT:** This switch, when in the QSK position, configures the key circuits for CW/QSK operation. For late model TEN-TEC transceivers with TX EN and TX OUT connectors, or late model Yaesu transceivers connected using a full break-in keying loop, this position is used for all modes of operation. Placing the switch in the PTT position allows the *TITAN III* to be controlled by the PTT/VOX input jack rather than the KEY IN/KEY OUT loop.

**2.2.7 MULTIMETER SWITCH:** This switch connects the right hand meter to monitor various amplifier parameters.

- A. Plate voltage (Ep) - When in this position, the meter reads plate voltage. This voltage is line voltage dependent at a ratio of 12.5 V plate per 1 V line. Plate voltage is approximately 3000 VDC at a line voltage of 240 VAC. Therefore, at a line voltage of 250

VAC the meter will read a little higher (3125 VDC).

- B. Screen current (Is) - When in this position, the meter is paralleled with a resistor in series with the screen supply. This monitors screen grid current. The upper limit for screen current is 75 mA. NEVER OPERATE THE *TITAN III* IN EXCESS OF 75 mA SCREEN GRID CURRENT. A warning zone indicator is used on the face of the meter to alert the operator. In addition to the analog meter, the screen overdrive LED indicates excessive screen current.
- C. Forward power (FWD) - When in this position, the meter is connected to the forward port of a bridge circuit at the antenna output. This measures forward RF output power. It is, however, more load dependent than an external wattmeter. If your antenna is far from resonance, the accuracy is not as good and power measurements should be made externally.
- D. Reflected power (REF) - When in this position, the meter is connected to the reverse port of the bridge at the antenna output. Reflected power is read at 1/10 indication scale of forward power (200 watts full scale).

### **2.2.8 PLATE CURRENT METER:**

Full time plate current metering is provided by the left analog meter.

**2.2.9 OVERDRIVE:** These two LEDs indicate grid overdrive conditions.

A. When the screen overdrive LED is lit, the screen current is approaching or has passed its limit. Reduce drive from the transceiver immediately and retune.

B. When the control grid overdrive LED is lit, the control grid current is approaching or has passed its limit. Reduce drive from the transceiver immediately and retune.

**2.2.10 WAIT:** This LED indicates a 3 minute warm-up period for the tube at initial power up. After being turned on for 3 minutes, the wait

LED goes out and the *TITAN III* can be placed in the operate mode.

### **2.2.11 PEAK POWER BARGRAPH:**

This meter is connected to the bridge at the antenna output through an emitter follower to monitor peak RF output power. When the red LED is lit, 1500 watts output has been reached.

## **2.3 REAR PANEL CONNECTIONS**

**AND CONTROLS:** The rear panel connections and their functions are described below.

**2.3.1 TRANSCEIVER:** This is a standard SO-239 receptacle designed for a mating PL-259 plug. RG-58U or similar 50 ohm coax is required to connect the *TITAN III* to the transceiver.

**2.3.2 ANTENNA:** This is a standard SO-239 receptacle designed for a mating PL-259 plug. RG-8 or similar 50 ohm coax rated for 1500 watts is required for connection to the antenna.

**2.3.3 KEY IN:** This jack is the input for the *TITAN III* transmit/receive relay system. When used with late model TEN-TEC transceivers, this jack is connected to the TX OUT connector on the transceiver. When used with other transceivers, a key or keyer is connected to this jack for QSK CW operation.

**2.3.4 KEY OUT:** This jack is a protected output from the *TITAN III* which passes the KEY IN to the transceiver after all relays in the *TITAN III* have closed and it is ready to transmit. When used with late model TEN-TEC transceivers, this jack is connected to the TX EN connector on the transceiver. When used with other transceivers, this jack is connected to the transceiver CW key input jack.

**2.3.5 PTT/VOX:** This jack is an input to the *TITAN III* transmit/receive relay

circuits. When used with late model TEN-TEC transceivers, this jack is not used. When used with other transceivers, this jack is connected to the normally open (grounding) contacts of the relay key out jack of the transceiver.

**2.3.6 ALC:** This jack provides a negative going ALC voltage, used primarily with tube type transmitters/transceivers. See section 1.8 for detailed information.

**2.3.7 ALC CONTROL:** This control adjusts the ALC threshold voltage from approximately -1 to -15 VDC depending on RF input from the transceiver.

**2.3.8 AC LINE:** This cable is connected to standard 240 VAC. Be sure the line used to power the *TITAN III* is capable of supplying 20 amps of current at 240 VAC, and that it is protected by either fuses or circuit breakers of 20 amps. Wire size of the AC feed line should be at least 10/2 with ground or larger.

**2.3.9 LINE FUSES:** Primary line fuses (ABC-20) are accessible through these panel fuse holders. Replace with ABC-20 or comparable fuses only.

**2.4 INITIAL TURN-ON:** The following steps should be followed when turning on your *TITAN III*.

- A. Set multimeter switch to the plate voltage (Ep) position.
- B. Place the power switch to ON. If any of the following do not occur, press OFF at once and investigate before proceeding.
  1. The power switch light should light.
  2. The meter lights should light.
  3. The fan motor should start and air flow should be felt at the exhaust port on top of the amplifier.
  4. The wait LED should light.
  5. All meter indications are zero.
  6. All other LEDs are not lit.

NOTE: HIGH VOLTAGE IS PRESENT ONLY IN THE OPERATE MODE. THE OPERATE MODE IS DISABLED FOR 3 MINUTES WHILE THE WAIT LED IS LIT.

**2.5 TUNE UP PROCEDURE:** The following section describes important points to observe during tune up. A suggested procedure for safely tuning up the *TITAN III* is included.

**2.5.1 CHECKS TO MAKE BEFORE TUNING UP:** Check the load connected to the amplifier. This can best be done by leaving the *TITAN III* in the BYPASS mode and using only the transceiver output power. Use a reliable SWR bridge or wattmeter to determine the SWR of the load (antenna) connected to the amplifier. If the reflected power is less than 10% of the forward power, the VSWR is less than 2:1. If the reflected power is 4% or less, the VSWR is 1.5:1 or lower. A VSWR of 2:1 or less is essential.

**2.5.2 IMPORTANT POINTS TO REMEMBER:** The most important parameters to observe during tune up are the control grid current and screen grid current. Excessive grid current even for a relatively short period of time can and will damage the tube. If grid currents are not exceeded, the 4CX800A tubes will deliver many years of trouble free service. In the *TITAN III* the control grid is monitored by front panel LED indicator. When control grid current is exceeded, the GRID overdrive LED will light. Reduce the drive immediately and retune the *TITAN III*. Screen grid current is monitored by the multimeter, (when in the S position) and by an LED overdrive indicator continuously. Screen grid current should be kept to a minimum during tune up and always in a positive direction. When screen current is exceeded the SCREEN overdrive LED will light. Reduce drive immediately and retune. After tune up, erratic lighting of either overdrive indicator could indicate breakdown in the load (antenna components). Reduce drive and check for arcing or heating of baluns, coax or other elements. Brief blinks of the LEDs at initial power-on or key-down are OK.



### 2.5.3 SUGGESTED TUNE UP

**PROCEDURE:** Following is the recommended procedure for safe and proper tune up of the *TITAN III*.

- A. Set the band switch to the desired band.  
For 160 meter operation between 1.9 and 2.0 MHz, use position 160B.
- B. Set the multimeter switch to the Ep position.
- C. After the wait LED goes out, place the STANDBY/OPERATE switch to OPERATE. The STANDBY/ OPERATE switch will light and high voltage is indicated on the multimeter (nominal 3000 VDC).
- D. Set the meter switch to the Is position. Always monitor Is (screen grid current) with the multimeter during tune up. Use FWD and REF positions momentarily for checking output power. Output power can also be monitored on the LED bargraph power meter. Always monitor the overdrive LEDs. Reduce drive and re-tune the amplifier if either is lit.
- E. For initial tune up you may set the TUNE and LOAD controls to their center positions. Alternatively you may refer to the suggested settings in the chart in Figure 2-1. Keep in mind that these settings are for operation into an ideal 50 ohm load and will vary with your installation.
- F. Turn the transceiver RF output control to between 10 and 20 watts. Note: at very low transceiver power outputs (<10 watts) the amplifier may not respond when attempting to tune up. This is normal. Increase drive power slightly and continue tune up. **IF AT ANY TIME THE *TITAN III* DOES NOT RESPOND AS EXPECTED, REMOVE DRIVE POWER IMMEDIATELY AND CORRECT THE PROBLEM BEFORE CONTINUING.**
- G. Key the transceiver and slowly increase the drive power until you see the plate current increase.
- H. Adjust the TUNE and LOAD controls for a peak in RF power output. Increase the drive power until screen current appears

and adjust the TUNE control for a peak in screen grid current. Adjust the LOAD control clockwise to reduce screen grid current if it is being driven above 60 mA at your desired power output. Always re-peak the screen current and RF output with the TUNE control after any LOAD control adjustments. Watch the plate current meter during tune up. If the plate current is much over 1.0 Amp at the TUNE control Is/RF peak, reduce loading with a small counter-clockwise rotation of the LOAD control (toward higher numbers on the dial skirt) and re-peak the TUNE. Remember: Readjust the TUNE control for a screen grid current and power output peak each time you adjust the LOAD control. There will be some interaction between these controls. Too-high peaked screen current can always be reduced at the expense of higher plate current by increasing the loading (clockwise LOAD adjustment).

- I. Gradually increase the drive level from the transceiver until you reach the desired output power level while carefully touching up the LOAD and TUNE controls until both plate and screen currents read at or slightly above mid-scale. Screen grid current of 45 to 60 milliamps is normal for 1500 watts output. **NEVER EXCEED 75 MILLIAMPS SCREEN GRID CURRENT.**
- J. Once you have the amplifier tuned up and operating on the desired frequency, you can log the LOAD and TUNE settings in the chart provided (Figure 2-2). These settings should be repeatable for the same frequency, antenna, and SWR when used in the future.

Note: Markings 0-10 on the dial skirts correspond to 0-100% PI-L network capacitance values.

BAND	FREQUENCY MHz	LOAD	TUNE
160A	1.820	8	5
160B	1.980	7	7
80	3.500	8.5	7.5
75	3.980	5.5	5
40	7.040	3.6	1.6
	7.250	3.5	1.5
30	10.120	2	1
20	14.050	1.6	1
	14.250	1.5	0.5
17	18.110	2.0	1
15	21.050	1.5	1.5
	21.4	1.5	1
12	24.900	2.0	1.5
10	28.100	1.5	2
	29.5	1.5	0.5

**FIGURE 2-1 MODEL 417A TUNING CHART  
FOR AN IDEAL 50 OHM LOAD**

BAND	FREQUENCY	LOAD	TUNE	ANTENNA	NOTES

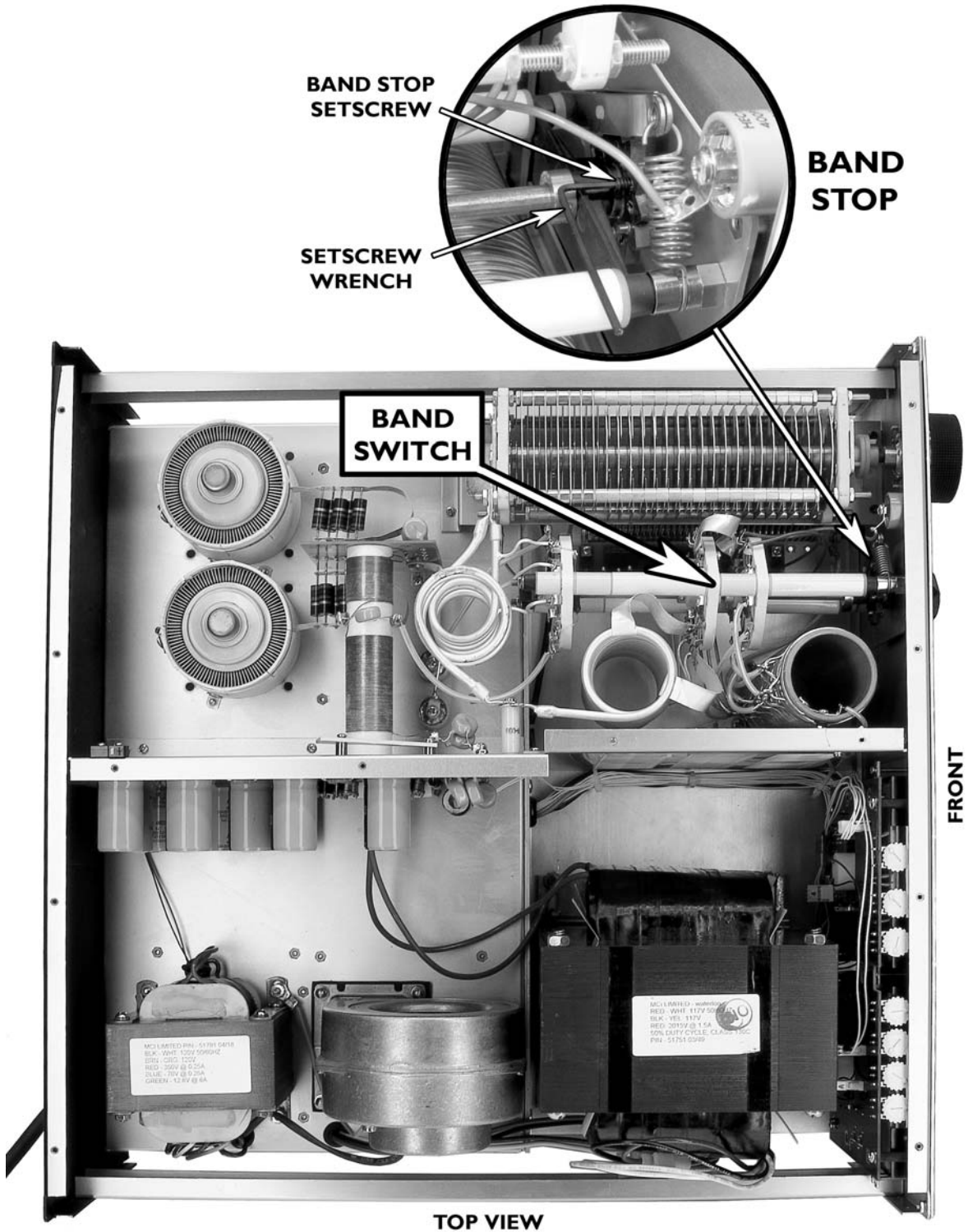
FIGURE 2-2 MODEL 417A TUNING LOG



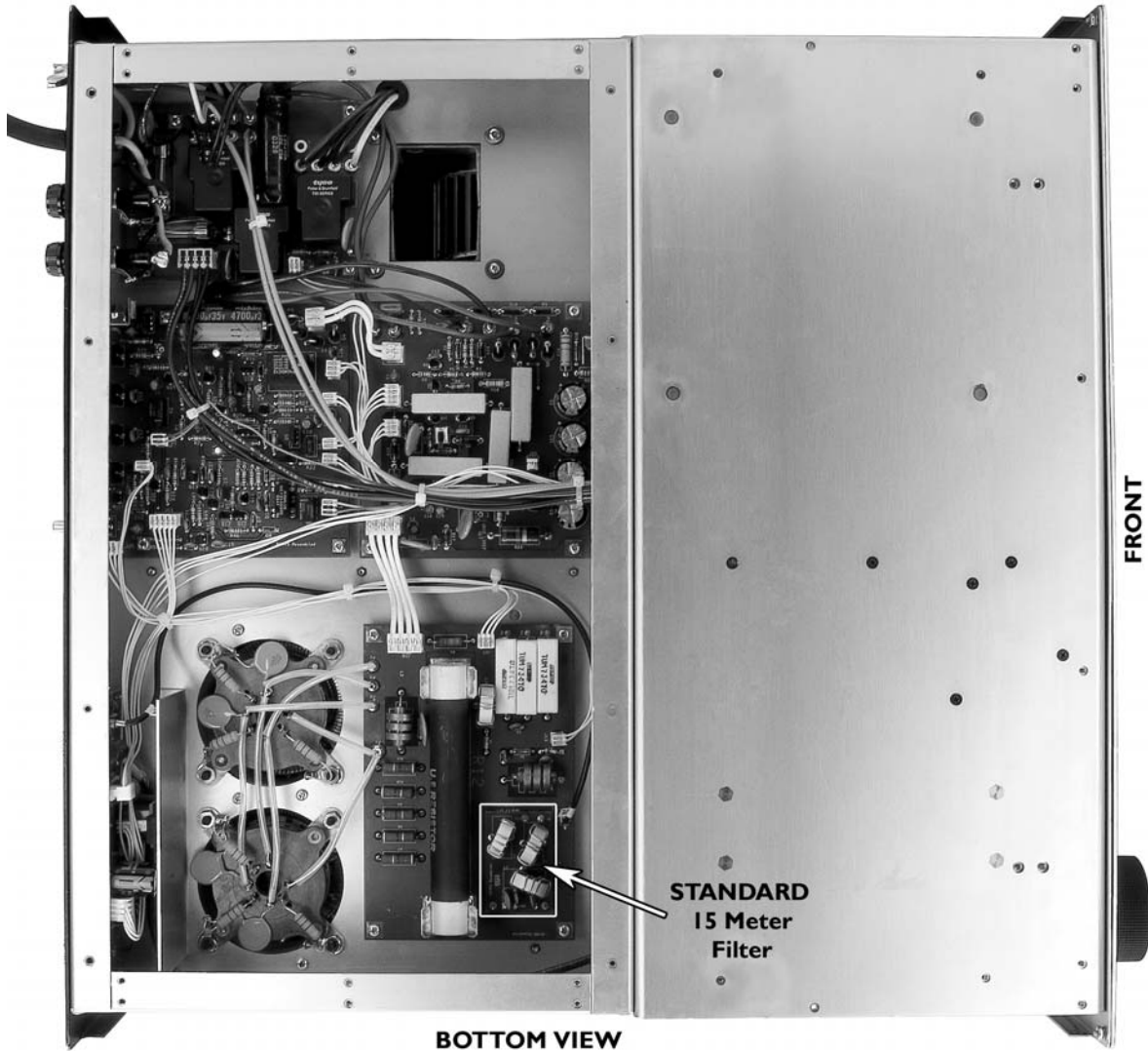
**FIGURE 2-3 TITAN III FRONT VIEW**



**FIGURE 2-4 TITAN III REAR VIEW**



**FIGURE 2-5 TITAN III TOP VIEW**



**FIGURE 2-6 TITAN III BOTTOM VIEW**

## **CHAPTER 3 OPERATION AND SAFETY**

**3.1 INTRODUCTION:** The following paragraphs provide additional information for operation of and safety from your *TITAN III* amplifier.

**3.1.1 HIGH POWER TETRODES:** The 4CX800As are very rugged and normally operate with a large margin of safety in the *TITAN III*. They will deliver outstanding service for many years if not damaged by abuse...especially excessive grid current or blockage of cooling air flow.

**KEEP THE AIR INTAKE AND EXHAUST VENT AREAS  
COMPLETELY CLEAR !!!**

**WARNING !!! DO NOT ALLOW THE SCREEN GRID CURRENT TO  
EXCEED 75 mA!**

**3.1.2 INTERLOCKS:** The *TITAN III* is equipped with interlock switches intended to shut off the power and short out the high voltage power supply when the cover is not securely fastened in place. These protective interlocks are provided to protect you from POTENTIALLY FATAL ELECTRIC SHOCK resulting from accidental contact with lethal voltages inside the amplifier. However, you should never depend on interlocks alone to protect you by removing dangerous voltages. ALWAYS DISCONNECT THE AC LINE CABLE TO THE TITAN III BEFORE REMOVING THE TOP COVER.

**WARNING !! THE AMPLIFIER SHOULD NEVER BE  
ENERGIZED WITH THE COVERS REMOVED!!  
DO NOT DEFEAT THE INTERLOCK SAFETY  
SWITCHES!!**

**3.1.3 FUSES:** Except in rare instances of component failure, blowing one or both primary fuses indicates that maximum safe average power capabilities of the amplifier have been exceeded.

## CHAPTER 4

### MAINTENANCE AND TROUBLESHOOTING

**4.1 INTRODUCTION:** If you encounter a problem, the troubleshooting hints listed in TABLE 4-1 below will help isolate the nature of the problem.

**4.2 MAINTENANCE:** The amplifier compartment, particularly areas around high voltage components should be cleaned often (using a soft bristled brush and vacuum cleaner) to prevent visible accumulation of dust. DO NOT blow air directly into the fan input: this can over rev the motor and damage the bearings.

**TABLE 4-1 TROUBLESHOOTING HINTS**

SYMPTOM	POSSIBLE CAUSE/CURE
1. Will not turn on: nothing happens when the ON switch is activated.	<ul style="list-style-type: none"> <li>A] Fuse missing or open.</li> <li>B] House wiring incorrect or breaker open.</li> <li>C] Power cable to amplifier disconnected.</li> <li>D] Fuse on HV-AC board A9 (81945) open.</li> <li>E] Problem with low voltage power supply on QSK board A11 (81949)</li> </ul>
2. Lights turn on but no high voltage.	<ul style="list-style-type: none"> <li>A] No HV will be present until amp is switched to OPERATE mode (and timed out).</li> </ul>
3. Relays A9K2 and A9K3 on 81945 HV-AC board close but relay K1 does not. Plate Voltage drops when RF is applied.	<ul style="list-style-type: none"> <li>A] A9Q1 on 81945 HV-AC board is defective.</li> <li>B] A9K1 on 81945 is defective.</li> </ul>
4. Relays A9K1, A9K2, A9K3 on 81945 HV-AC board close but no high voltage when switched to OPERATE mode.	<ul style="list-style-type: none"> <li>A] Interlock open, cover not tight</li> <li>B] A9K2, A9K3 defective.</li> <li>C] HV short to ground.</li> <li>D] High voltage transformer disconnected.</li> <li>E] High voltage bridge open.</li> </ul>



**TABLE 4-1 TROUBLESHOOTING HINTS (Continued)**

<p>5. Relays A9K1, A9K2, and A9K3 close at turn on, but line fuses blow.</p>	<p>A] High voltage shorted at crowbar or elsewhere.          B] Shorted tube.          C] Leaky electrolytics in high voltage supply.</p>
<p>6. Amplifier won't drive, zero grid and plate current, high input SWR .</p>	<p>A] Defective cable from transceiver to amplifier.          B] Input relay A4K2 on 81951 SWR board defective.          C] Input filter A7 or A8 on 81946 Input Matching board (A6) loose or damaged.</p>
<p>7. Grid overdrive LED lights with no drive.</p>	<p>A] A10Q7 on 81950 Screen Supply shorted or leaky.          B] Shorted or leaky tube.</p>
<p>8. Screen overdrive LED lights with no drive.</p>	<p>A] A10R23 on 81950 Screen Supply open or increased in value.          B] Low or no high voltage. <b>TURN OFF THE AMPLIFIER IMMEDIATELY.</b></p>
<p>9. Amplifier difficult to drive, little or no output, high plate current (may be accompanied by a "frying sound").</p>	<p>A] Band switch in wrong position.          B] Excessively high load SWR.          C] Defective output relay A4K1 on 81951 SWR board.          D] Arcing in tank circuit or antenna feed line.</p>
<p>10. Excessive plate current in receive mode.</p>	<p>A] Defective bias circuit, 81950 board (A10).          B] Shorted grid / cathode in tube.</p>
<p>11. Transceiver does not key using key-in/key-out loop.</p>	<p>A] Key-in and key-out lines reversed at amplifier or at transceiver.          B] Defective key line cables.          C] Defective relay control circuit on 81949 QSK board (A11).</p>
<p>12. Transceiver stays keyed in receive mode. May be accompanied by loss of receive signal.</p>	<p>A] Relay A4K1 on 81951 SWR board stuck.          B] Shorted key-in or key-out cable.          C] Defective relay control circuit on 81949 QSK board (A11).</p>

## CHAPTER 5

### CIRCUIT DESCRIPTIONS AND ILLUSTRATIONS

**5.1 INTRODUCTION** The following sections contain detailed circuit board subassemblies used in the Model 417A. Also included are circuit trace drawings and detailed component layout diagrams. These drawings are followed by a schematic diagram for the complete amplifier.

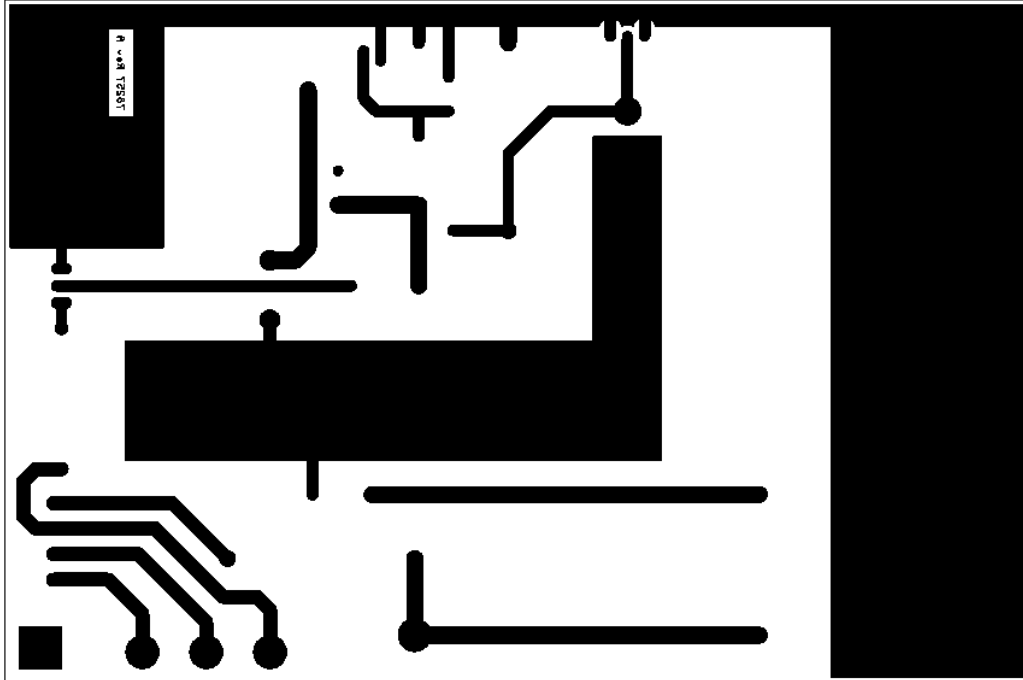
**5.2 INPUT MATCHING BOARD A6 (81946)** This board contains the input filter, impedance matching networks, and ALC circuits.

The 15M INPUT FILTER BOARD A7 (81953) is the standard input filter shipped with the *TITAN III*. This is a five pole elliptic filter consisting of L1, L2, L3, C1, C2, and C3. This filter provides increased roll-off of frequencies above the 15 meter band. An optional 15/10M INPUT FILTER BOARD A8 (81954) is available from TEN-TEC to qualified amateur radio operators, upon receipt of a copy of their amateur radio license.

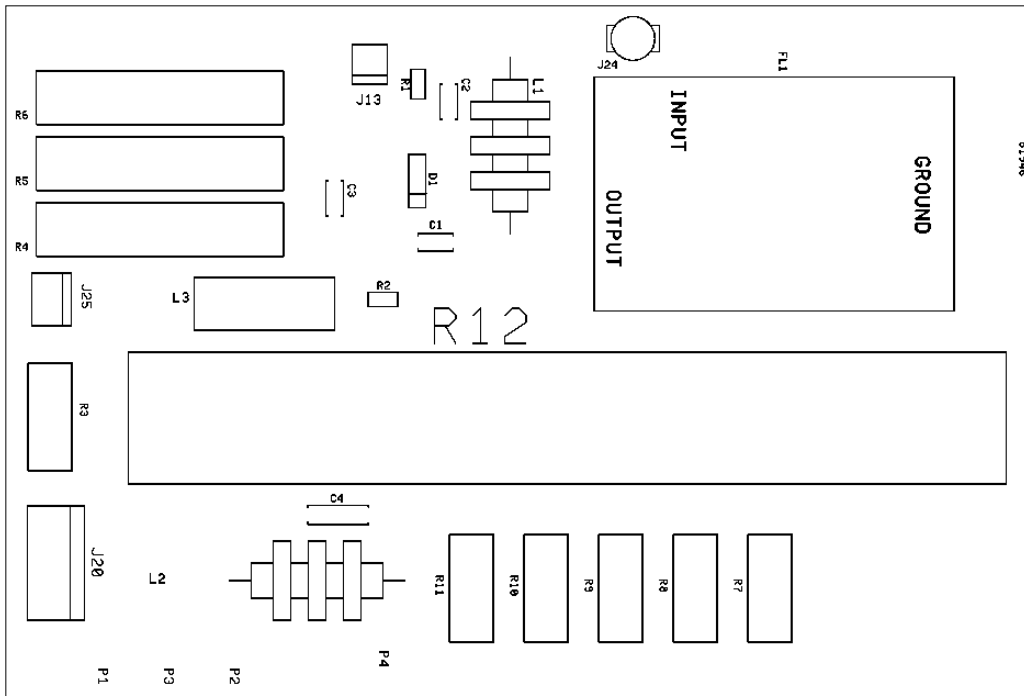
**Note: Operation on the 10 or 12 meter bands will also require additional modifications to the bandswitch assembly. Please contact the factory for instructions or further information.**

The impedance matching network of R4–R12 and L3 on assembly A6 matches the input of the 4CX800As to the driver impedance of approximately 50 Ohms.

The ALC circuit on A6 samples the input RF power to the amplifier. A6D1 rectifies this sample and produces a negative voltage proportional to input power for control of some excitors. The ALC threshold is set by potentiometer A11R52, located on the rear panel. Turn this control fully clockwise if ALC is not used.

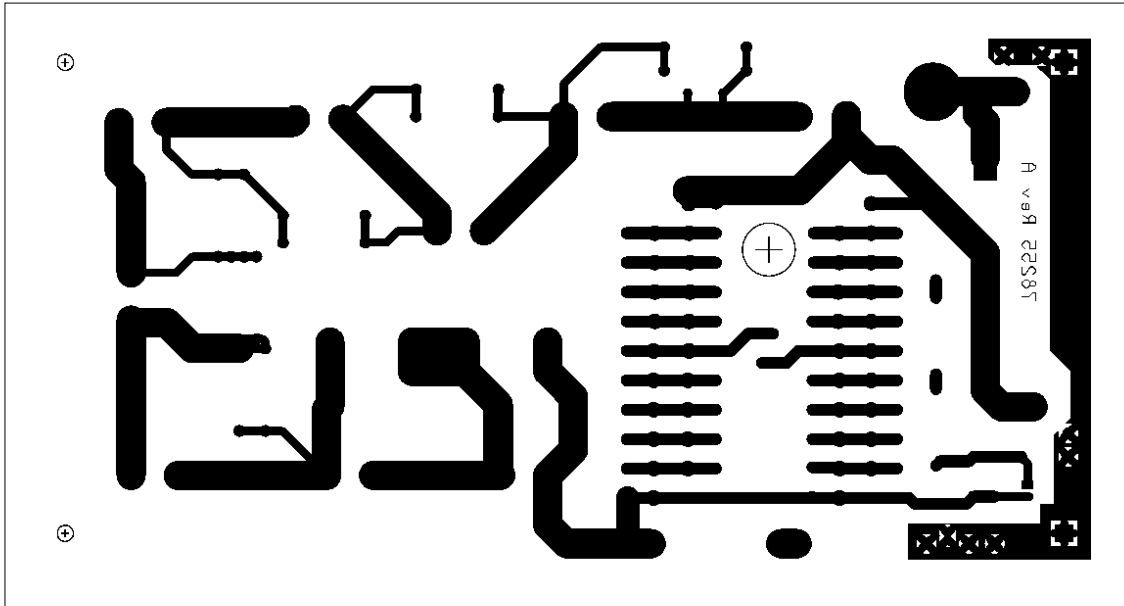


**FIGURE 5-1 INPUT MATCHING BOARD (ASSEMBLY A6) CIRCUIT TRACE AS VIEWED THROUGH BOARD**

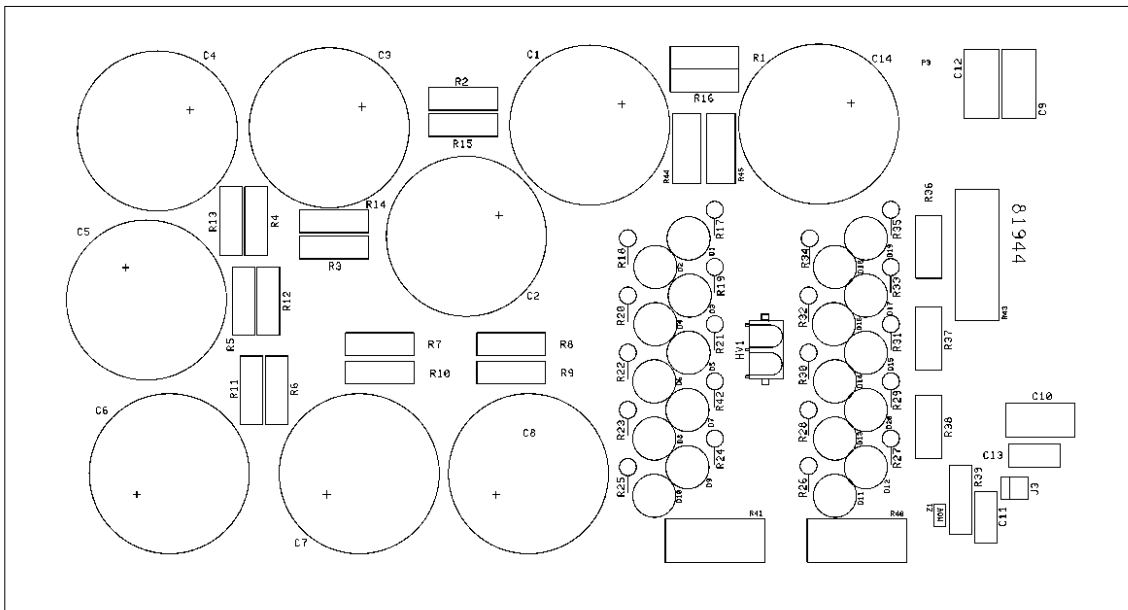


**FIGURE 5-2 INPUT MATCHING BOARD (ASSEMBLY A6) COMPONENT LAYOUT TOP VIEW**

**H.V. POWER SUPPLY BOARD A2 (81944)** This board contains the high voltage rectifier bridge (D1 – D20), H.V. filters (C1 – C8 and C14), and H.V. meter circuits.



**FIGURE 5-3 HIGH VOLTAGE RECTIFIER BOARD (ASSEMBLY A2)  
CIRCUIT TRACE AS VIEWED THROUGH BOARD**



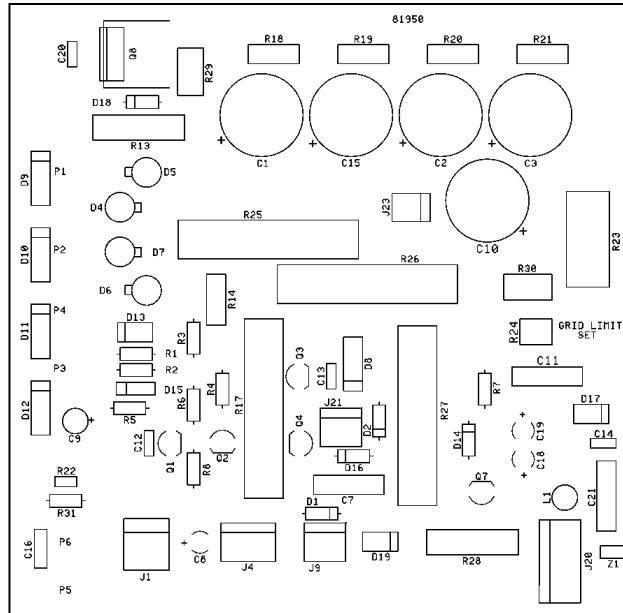
**FIGURE 5-4 HIGH VOLTAGE RECTIFIER BOARD (ASSEMBLY A2)  
COMPONENT LAYOUT TOP VIEW**

**5.4 SCREEN SUPPLY AND GRID BIAS BOARD A10 (81950)** This board contains the screen supply, grid bias supply, and protective circuits for the 4CX800As. The screen voltage is rectified by diodes D4 – D7 and filtered by C1 – C3 and C15. This DC voltage is then regulated by pass element Q8. Load resistors R25 – R27 provide a current drain to insure screen current remains in the positive direction. MOV Z1 protects the power supply in the event of tube arc and insures the screen voltage can't surge above 450 VDC. R23 provides a voltage drop proportional to the screen current to drive the front panel screen current meter.

Grid bias voltage is rectified by D13, then filtered by C10. Q1 senses the key condition and via Q2 and Q4 switches zener diodes D2, D8 and D16 in during key down and out during key up. This zeners the bias voltage to approximately –55 VDC during TX and –100 VDC in RX. Due to differences in tubes, J21 allows adjustment of grid bias in 4 settings:

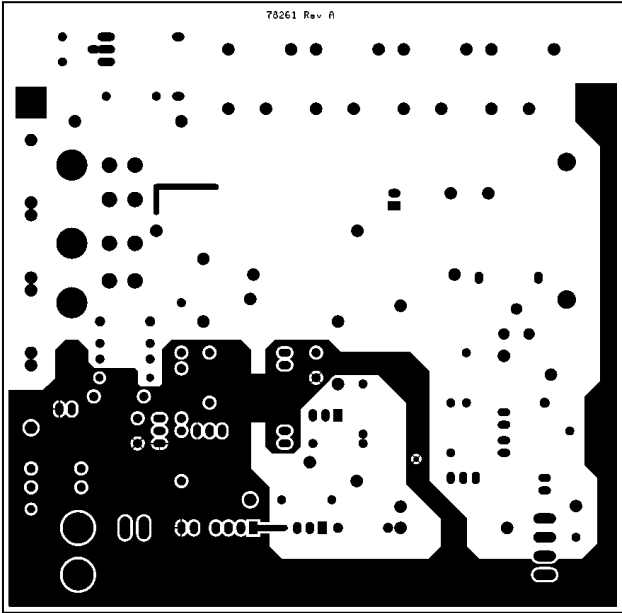
- 47V Pins 1 and 3 shorted
- 55V Pins 2 and 3 shorted
- 60V Pins 1 and 2 shorted
- 68V no pins shorted

This adjustment is factory set to match the tubes shipped with the amp. If the tubes are ever replaced, the jumper setting should be selected to produce approximately 200 – 400 mA of plate current when keyed with no drive. The circuitry of Q7 senses grid current and begins to fold back grid bias toward cutoff as grid power approaches 2 watts. Zener diode D1 provides regulation for the negative 16 VDC power supply to run the meter circuits on the meter switch board and the relay hot-shot circuit on the SWR board.

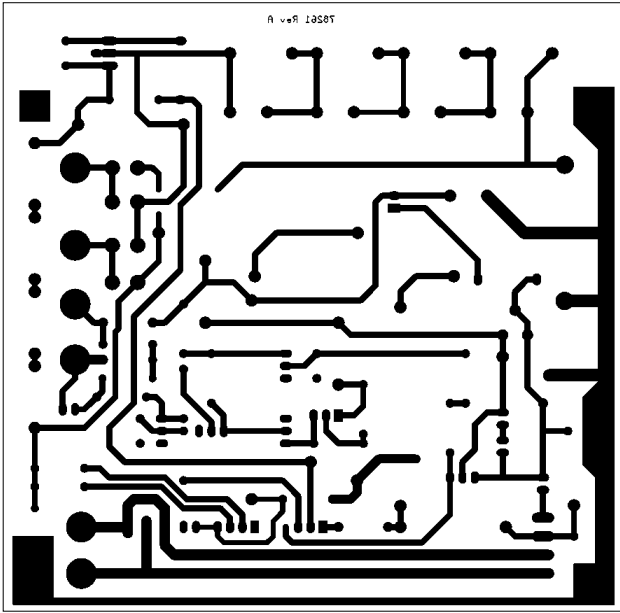


**FIGURE 5-5 SCREEN SUPPLY BOARD (ASSEMBLY A10)  
COMPONENT LAYOUT TOP VIEW**

**TOP SIDE COPPER**



**BOTTOM SIDE COPPER**



**FIGURE 5-6 SCREEN SUPPLY (ASSEMBLY A10) CIRCUIT LAYOUT VIEWED THROUGH BOARD FROM TOP**

**5.5 QSK BOARD A11 (81949)** This board contains the low voltage supply, turn-on relay sequencing circuits, and T/R relay control.

The low voltage is rectified by D1 – D4 and filtered by C6. U1 and Q2 provide regulation for all low voltage circuits except the negative 16 VDC supply.

After a 3 minute warm-up period determined by RC time constant of R4 and C5, Q19 and Q11 will conduct, turning on the pass element Q5. This initiates amplifier power up.

When the STANDBY/ OPERATE switch is put in the OPERATE position, this voltage is applied to relay sequencing circuits Q3, Q6, Q4 and Q10. These circuits insure plate and screen voltages arrive at and leave the tube in the proper order.

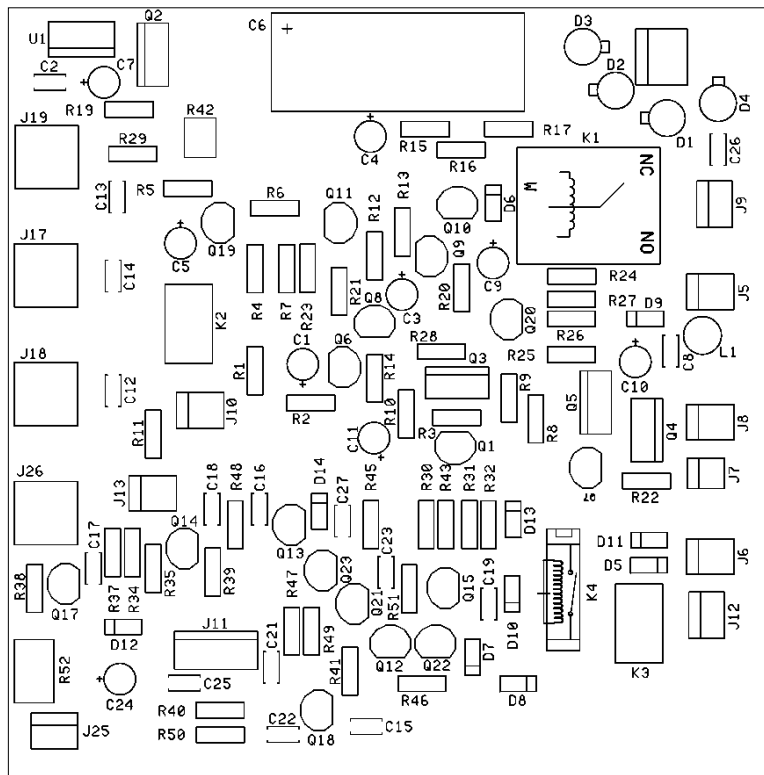
Q20 senses plate current and disables the amplifier when plate current parameters are exceeded (such as excessive plate current during a tube arc). Both plate voltage and screen voltage are removed when plate current of 1.5A is reached.

The QSK CONTROL CIRCUIT consists of Q12-Q18 and Q21-Q23. This circuit samples input key requests, standby/operate modes, power on/off state, state of output relay, and RF presence at the antenna connection and input of the amp. Hot switch protection is provided regardless of mode. In the QSK mode, using the key in / key out loop, the key in request from the transceiver is tailored by the QSK CONTROL circuit to insure smooth QSK action of the input and output relays.

K2 senses power OFF or STANDBY and places the key circuit in bypass for exciter operation in barefoot mode.

K3 senses OPERATE mode and routes the key request to the amplifier control circuits.

K4 passes the “key in” to the KEY OUT jack when all relays are closed and ready for RF.



**FIGURE 5-7 QSK BOARD (ASSEMBLY A11) COMPONENT LAYOUT TOP VIEW**

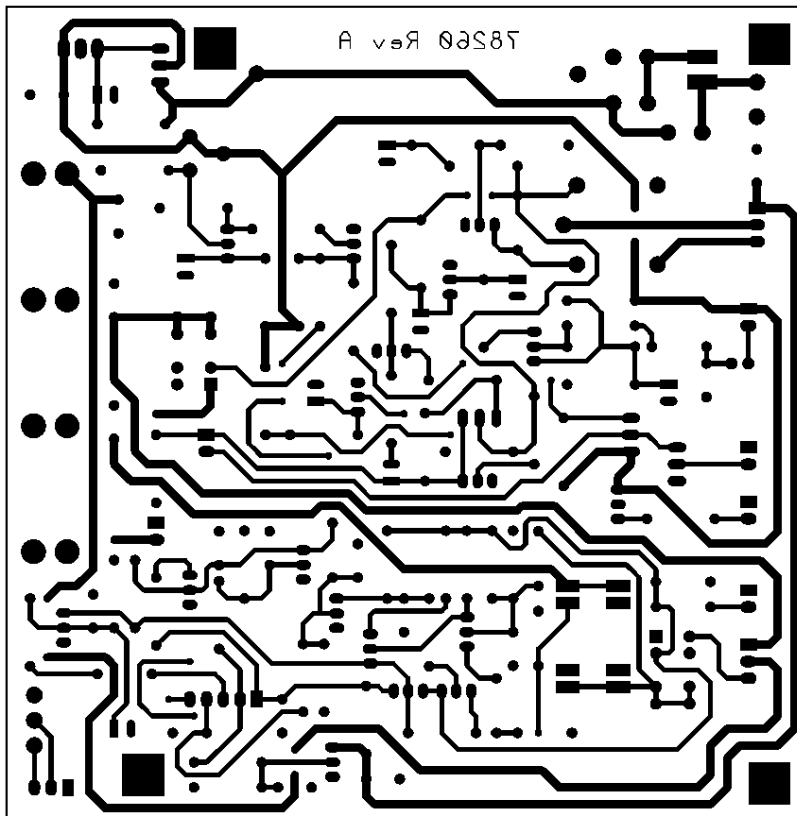
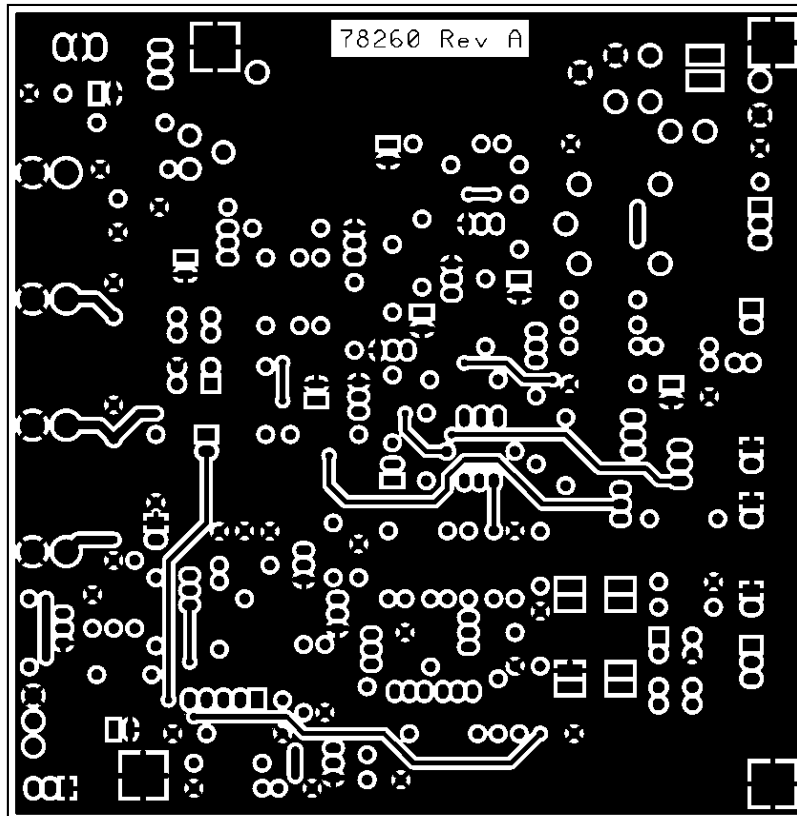


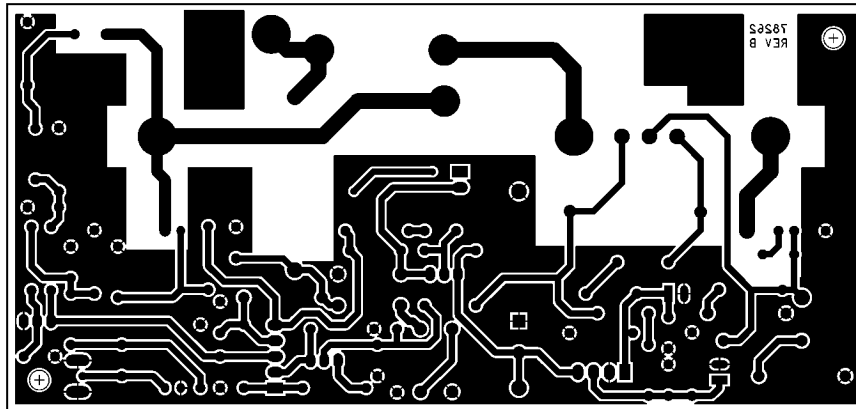
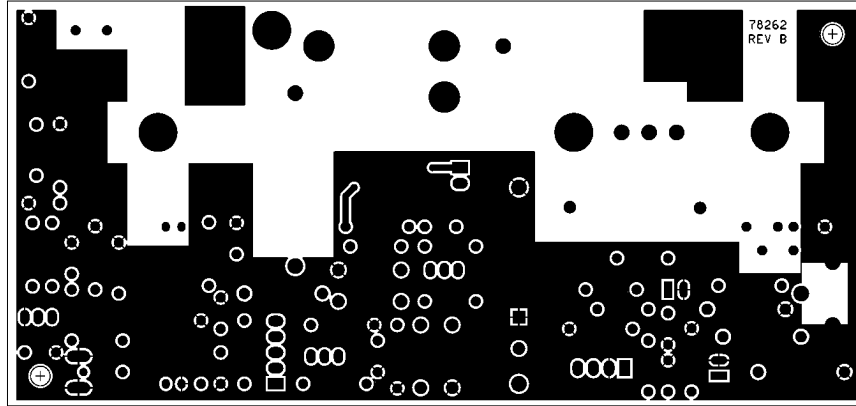
FIGURE 5-8 QSK BOARD (ASSEMBLY A11) TOP AND BOTTOM  
CIRCUIT TRACES VIEWED THROUGH BOARD FROM TOP



**5.6 SWR BOARD A4 (81951)** This board contains the input relay K1, output relay A14 (81959), hot-shot circuit Q3-C19, and the SWR bridge T1 for output power sampling.

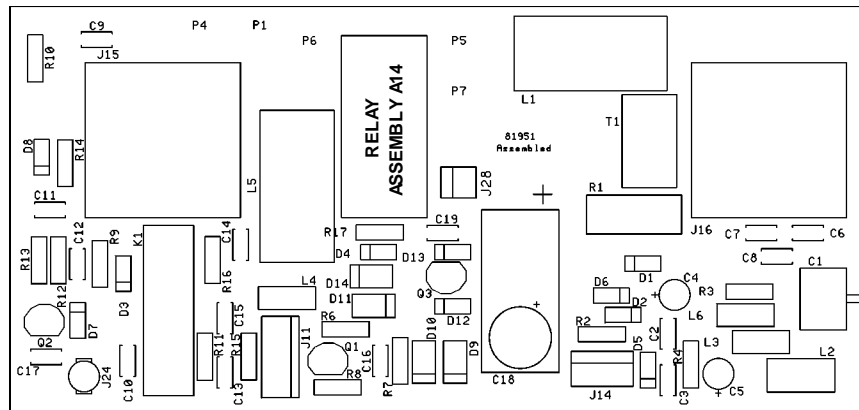
**FIGURE 5-9 SWR BOARD (ASSEMBLY A4) CIRCUIT TRACE VIEWED THROUGH BOARD FROM TOP**

**TOP COPPER**



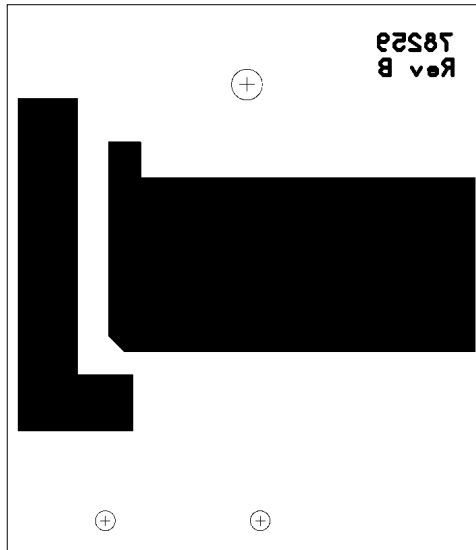
**BOTTOM COPPER**

**FIGURE 5-10 SWR BOARD (ASSEMBLY A4) COMPONENT LAYOUT TOP VIEW**

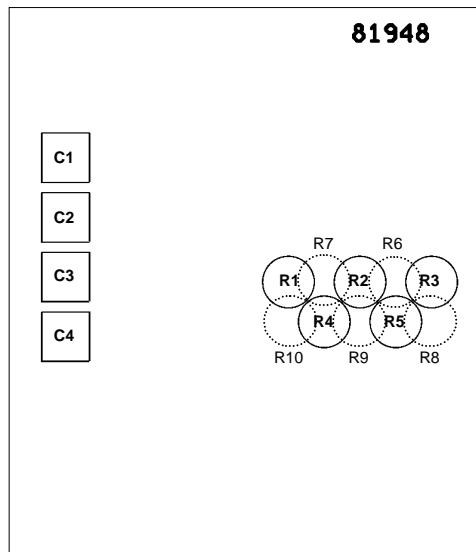


**5.7 PLATE BOARD A3 (81948)** This board contains the parasitic suppressors and coupling capacitors to connect the 4CX800A plates to the amplifier tank circuit.

**FIGURE 5-11 PLATE CONNECTOR BOARD (ASSEMBLY A3)  
CIRCUIT TRACE VIEWED THROUGH BOARD**



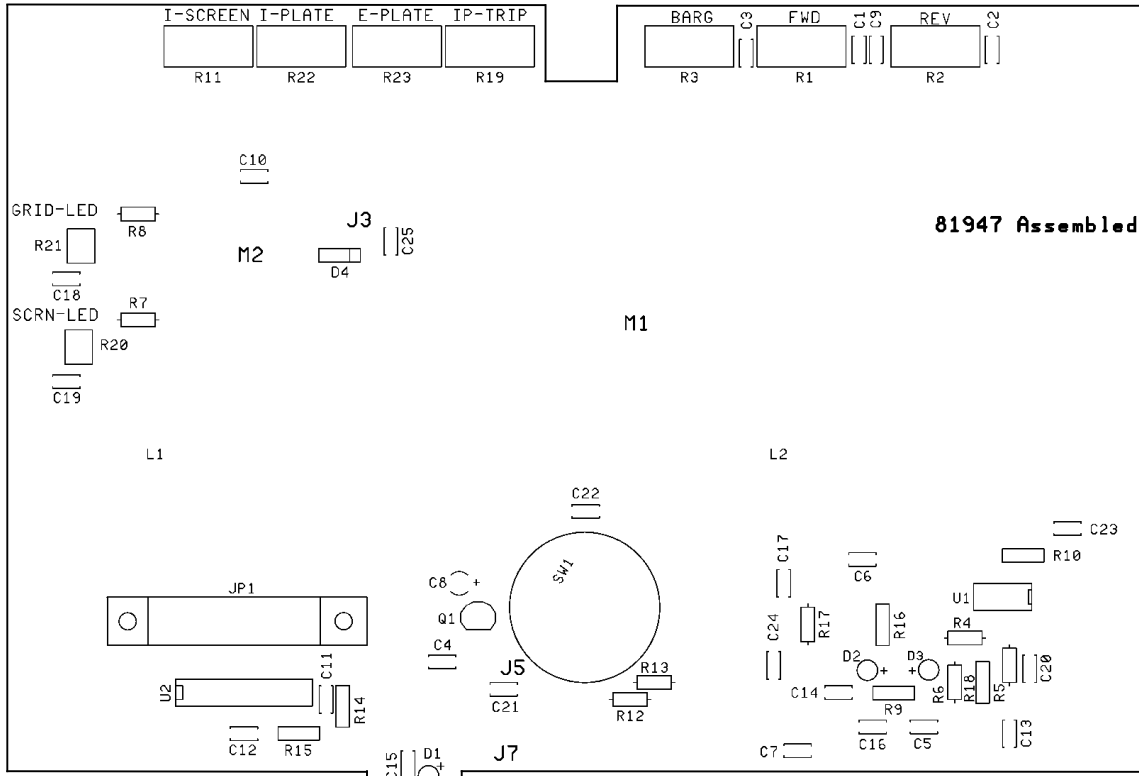
**FIGURE 5-12 PLATE CONNECTOR BOARD (ASSEMBLY A3)  
COMPONENT LAYOUT TOP VIEW**



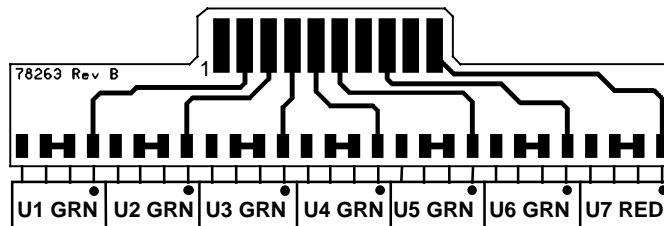
### 5.8 METER/SWITCH BOARD A12 (81947) and DISPLAY BOARD A13 (81952)

This board contains the metering circuits for the front panel meters. A12S1 selects the parameter to be monitored. This selection is then sent to multimeter M1. The multimeter has three calibrated scales for measuring plate voltage, screen current and forward or reflected RF power. The KW scale should be divided by ten when measuring reflected power.

A12U1 samples screen and control grid current and drives the appropriate LED to indicate excessive current of either screen or control grid. Q1 samples forward RF power voltage from the SWR board. This voltage is peak-held by C8 and sent to U2 to drive the peak reading display LEDs on DISPLAY BOARD A13.

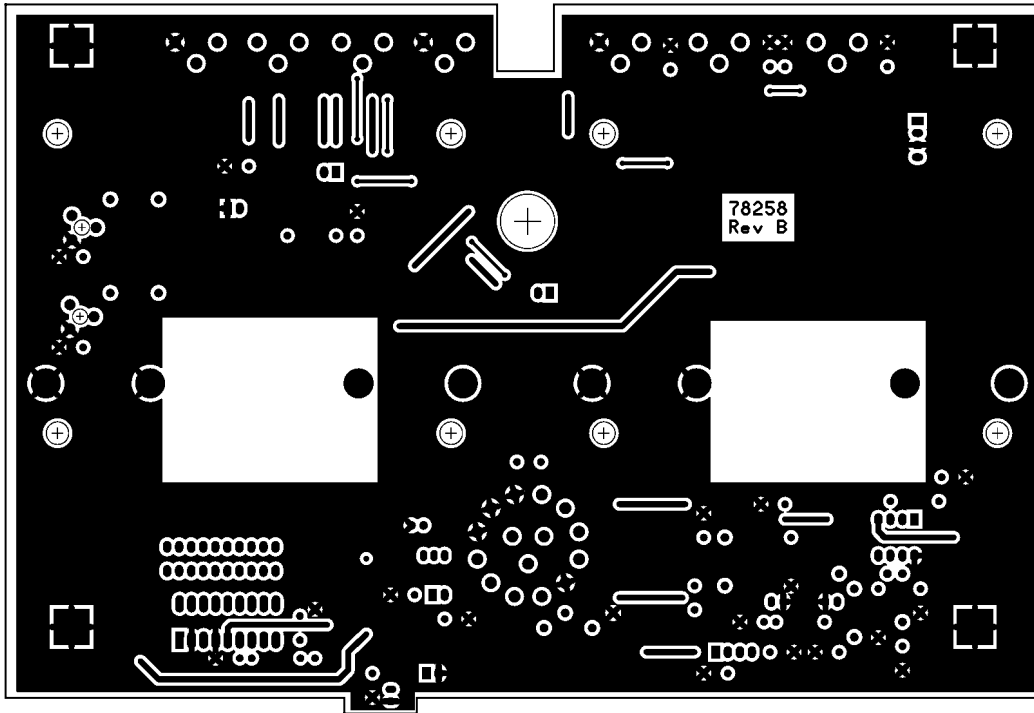


**FIGURE 5-13 METER/SWITCH BOARD (ASSEMBLY A12) COMPONENT LAYOUT VIEWED FROM FRONT PANEL SIDE**



**FIGURE 5-15 DISPLAY BOARD (ASSEMBLY A13) COMPONENT LAYOUT AND TOP CIRCUIT VIEWED FROM TOP**

COMPONENT SIDE COPPER



SOLDER SIDE COPPER

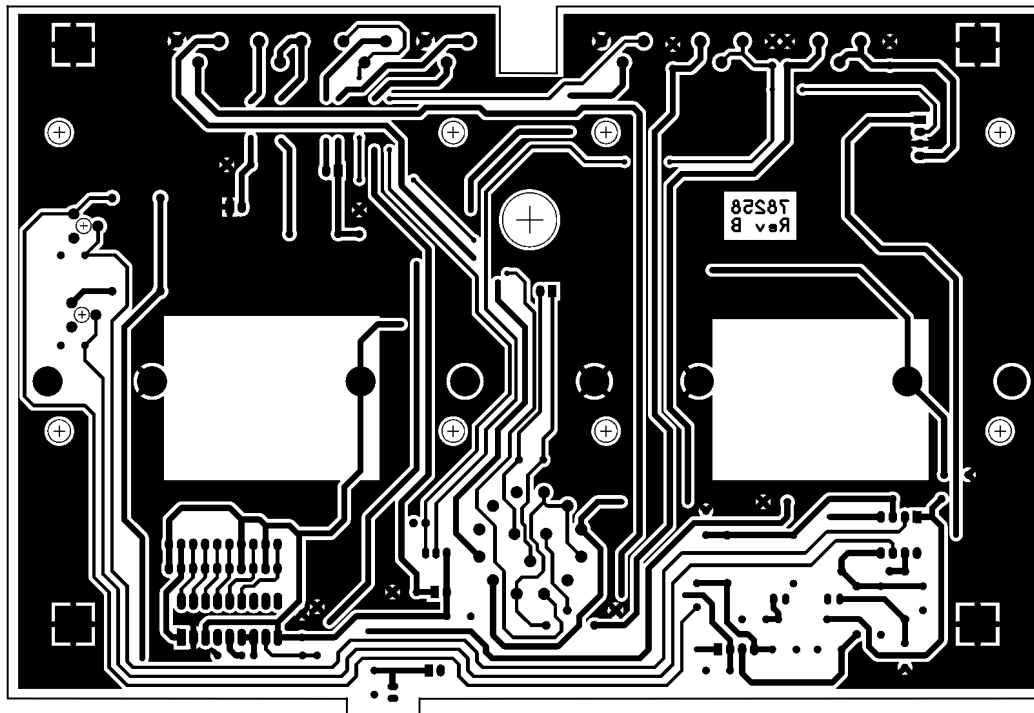
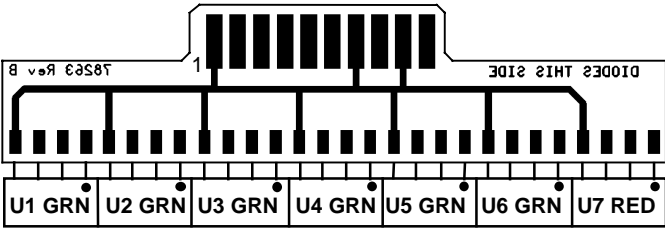
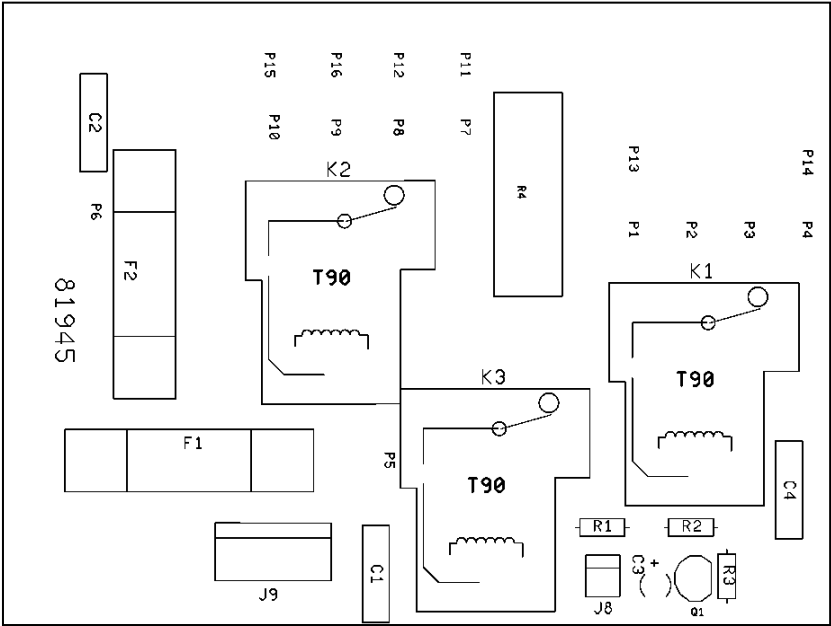


FIGURE 5-14 METER/SWITCH BOARD (ASSEMBLY A12)  
CIRCUIT VIEWED THROUGH BOARD FROM FRONT PANEL

**FIGURE 5-16 DISPLAY BOARD (ASSEMBLY A13) BOTTOM CIRCUIT VIEWED THROUGH BOARD FROM TOP**

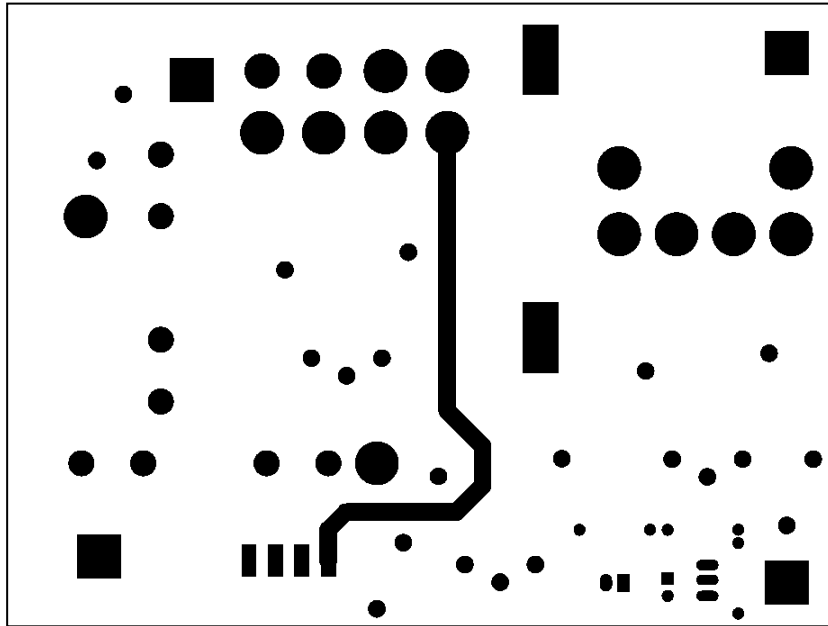


**5.9 AC LINE DELAY BOARD A9 (81945)** This board contains the step start relays and associated circuitry to control inrush current while the H.V. filter capacitors charge.



**FIGURE 5-17 AC LINE DELAY BOARD (ASSEMBLY A9) COMPONENT LAYOUT TOP SIDE VIEW**

TOP COPPER



BOTTOM COPPER

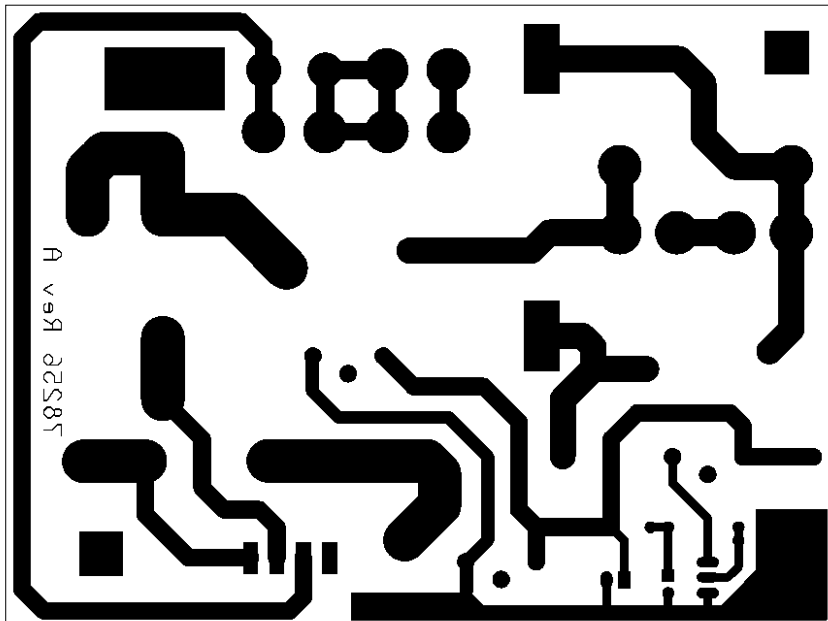
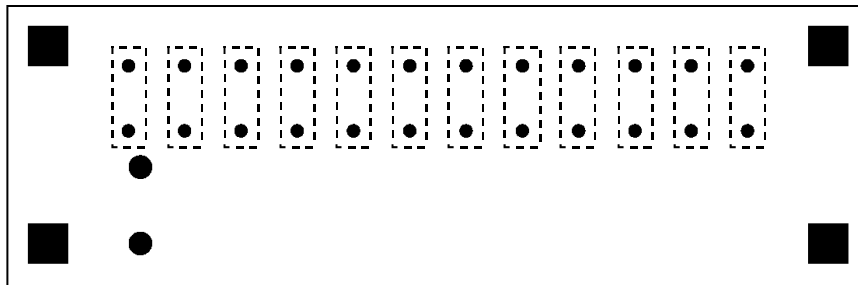


FIGURE 5-18 AC LINE DELAY BOARD (ASSEMBLY A9)  
CIRCUIT TRACE TOP VIEW THROUGH BOARD

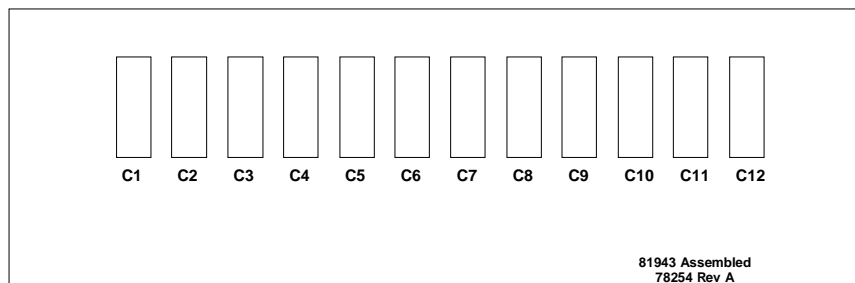
**5.10 LOAD SHUNT BOARD A5 (81943)** This board contains some of the extra load capacitance needed for the tank circuit on the 160M band. Capacitance is paralleled across the variable load capacitor on bandswitch positions 160A, and 160B, and 80.

**FIGURE 5-19 LOAD SHUNT CAP BOARD (ASSEMBLY A5)  
CIRCUIT VIEWED THROUGH BOARD FROM TOP**

**BOTTOM COPPER**



**TOP COPPER**



**FIGURE 5-20 LOAD SHUNT CAP BOARD (ASSEMBLY A5)  
COMPONENT LAYOUT TOP VIEW**

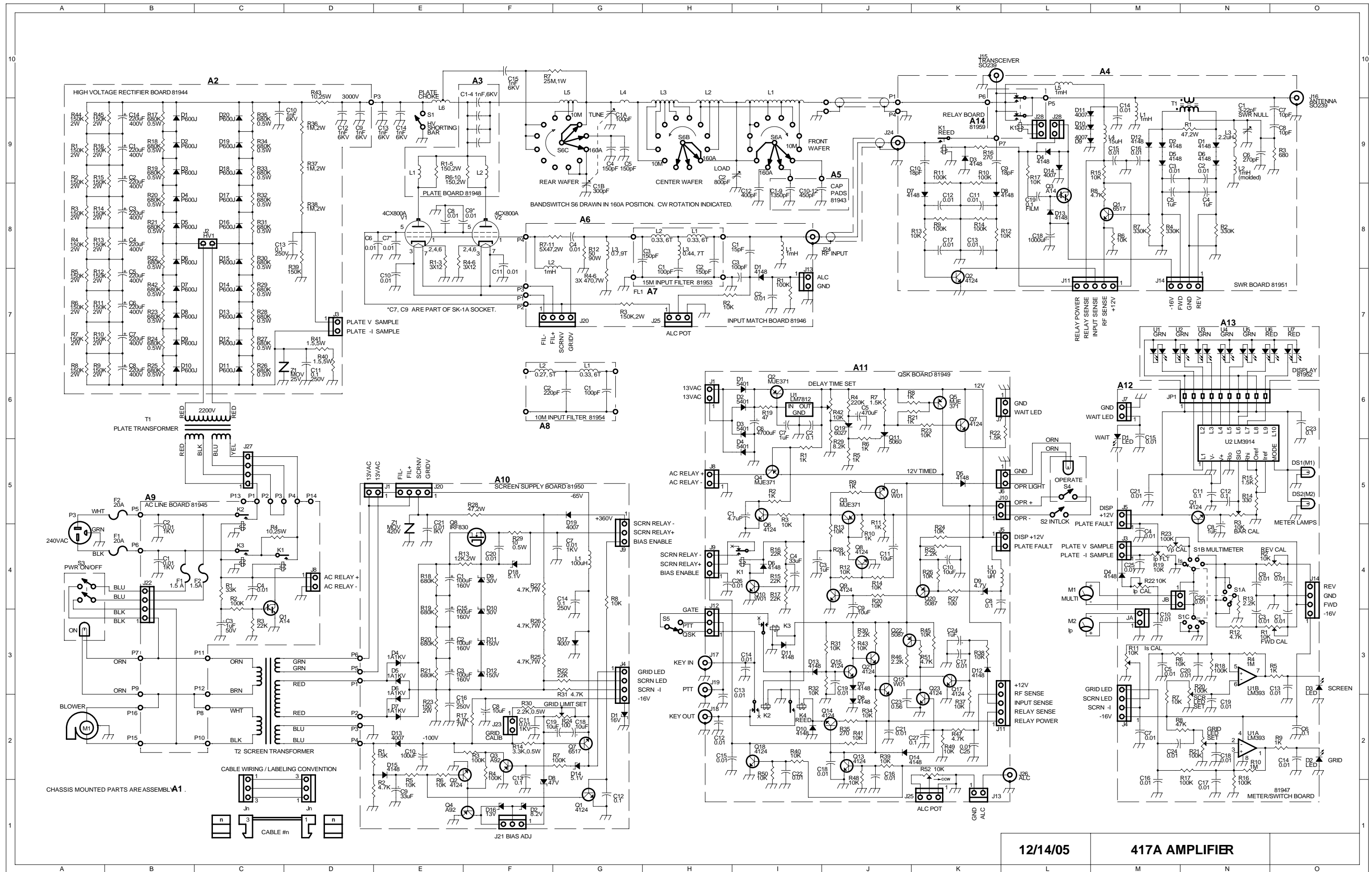


FIGURE 5-21 SCHEMATIC DIAGRAM MODEL 417A



## CHAPTER 6 MASTER PARTS LIST

MODEL 417A

CHASSIS MOUNTED PARTS A1

ITEM	DESCRIPTION	TEN-TEC PART #
T1	HV TRANSFORMER	81859 FROM 21199
T2	LV TRANSFORMER	21198
BLOWER	CENT. BLOWER	38305
S1	SHORTING BAR	93690
S2	INTERLOCK SW	32063
S3	ON-OFF SW	32128
S4	STBY-OPR SW	32129
S5	QSK -PTT SW	32130
S6	BAND SW	98560 FROM 32149
L1, L2	TANK COIL-1	85427-13
L3	TANK COIL-2	85427-11
L4	10M PI COIL	85427-6
L5	15/10M PLATE MATCH	85427-12
L6	PLATE CHOKE	85427-1
	JUMPER STRAP	85427-14
C1A C1B	TUNE CAPACITOR	23520
C2	LOAD CAPACITOR	23526
C4, C5	150pF 5KV N750	23297
C6-C11	.01uF 1KV	23013
C12	400pF 7.5KV N3300	23300
C13-C15	1nF 6KV	23295
R1-R6	12 Ohm, 2W	30405
R7	25M Ohm, 1W, 5kV	30742
P3	AC PLUG	35153
V1 V2	4CX800A TETRODE	25513
V1/V2-S	TUBE SOCKETS W/BYP	27084
F1-F2	20 ABS FUSE	27038
	FUSE HOLDER	27009
	6:1 VERNIER	38146
	TUBE RETAINER	38265
	BAR KNOB	34058
	LOAD-TUNE KNOB	81601
	DIAL SKIRT	91209-1CU
	METER SW KNOB	80529
	BAIL	91178
	RT BAIL FOOT	90926
	LF BAIL FOOT	90925
	REAR FEET	42020
	HOLE PLG - MTR ADJ	42044

AC LINE BOARD A9  
81945

ITEM	DESCRIPTION	TEN-TEC PART #
C1	.01uF 1KV	23013
C2	.01uF 1KV	23013
C3	1uF 50V	23264
C4	.01uF 1KV	23013
K1	RELAY SPST	32067
K2	RELAY SPST	32067
K3	RELAY SPST	32067
	COVER, RELAY	32072
Q1	MPSA14	25253
R1	33K	30155
R2	100K	30161
R3	22K	30154
R4	10 25W	30310
F1 F2	1.5 AMP MDL	27018

INPUT MATCHING BOARD A6  
81946

C1	15pF 1KV	23372
C2	.01uF	23260
C3	100pF	23013
C4	.01uF 1KV	23385
D1	1N4148	28001
FL1/A7	15M INPUT FILTER	81953
L1 L2	1MH	21135
L3	COIL-TOROID, .7uH	85427-7
R1	100K	30161
R2	10K	30150
R3	150K 2W	30311
R4	470 7W	30721
R5	470 7W	30721
R6	470 7W	30721
R7	47 OHM 2W	30408
R8	47 OHM 2W	30408
R9	47 OHM 2W	30408
R10	47 OHM 2W	30408
R11	47 OHM 2W	30408
R12	50 OHM 90WATT	30223

METER-SWITCH BOARD A12  
81947

ITEM	DESCRIPTION	TEN-TEC PART #
C1	.01uF	23260
C2	.01uF	23260
C3	.01uF	23260
C4	.01uF	23260
C5	.01uF	23260
C6	.1uF	23261
C7	.01uF	23260
C8	1uF 50V	23264
C9	.01uF	23260
C10	.01uF	23260
C11	.1uF	23261
C12	.1uF	23261
C13	.01uF	23260
C14	.01uF	23260
C15	.01uF	23260
C16	.01uF	23260
C17	.01uF	23260
C18	.01uF	23260
C19	.01uF	23260
C20	.01uF	23260
C21	.01uF	23260
C22	.01uF	23260
C23	.1uF	23261
C24	.01uF	23260
C25	.01uF	23260
D1	LED	28024
D2	LED	28024
D3	LED	28024
D4	1N4148	28001
M1	MULTIMETER 1mA	98540
M2	PLATE METER 1mA	98544
Q1	2N4124	25258
R1	10K TRIMPOT	30038
R2	10K TRIMPOT	30038
R3	10K TRIMPOT	30038
R4	1M	30173
R5	1K	30138
R6	10K	30038
R7	10K	30038
R8	47K	30157
R9	1K	30138
R10	1M	30173
R11	10K TRIMPOT	30038

ITEM	DESCRIPTION	TEN-TEC PART #
R12	4.7K	30146
R13	2.2K	30142
R14	330	30132
R15	1.5K	30140
R16	100K	30161
R17	100K	30161
R18	100K	30161
R19	10K TRIMPOT	30038
R20	100K PC ADJ	30620
R21	100K PC ADJ	30620
R22	10K TRIMPOT	30038
R23	100K TRIMPOT	30198
SW1	METER SW	98449 FROM 32050
U1A	P/O LM393	25260
U1B	P/O LM393	25260
U2	LM3914	25101

PLATE BOARD A3  
81948

C1	.001uF 6KV	23295
C2	.001uF 6KV	23295
C3	.001uF 6KV	23295
C4	.001uF 6KV	23295
L1 L2	PARASITIC SUP	85427-5
R1-R5	150 2W	30407
R6-R10	150 2W	30407

QSK BOARD A11  
81949

C1	4.7uF 35V	23310
C2	.1uF	23261
C3	1uF 50V	23264
C4	33uF 16V	23308
C5	470uF 6.3V	23567
C6	4700uF 35V	23191
C7	1uF 50V	23263
C8	.1uF	23261
C9	10uF	23266

ITEM	DESCRIPTION	TEN-TEC PART #
C10	10uF	23266
C11	10uF	23266
C12	.01uF	23260
C13	.01uF	23260
C14	.01uF	23260
C15	.01uF	23260
C16	.01uF	23260
C17	.01uF	23260
C18	.01uF	23260
C19	.01uF	23260
C21	.01uF	23260
C22	.01uF	23260
C23	.56uF	23331
C24	1uF 50V	23263
C25	.01uF	23260
C26	.01uF	23260
C27	.1uF	23261
D1	1N5401	28047
D2	1N5401	28047
D3	1N5401	28047
D4	1N5401	28047
D5	1N4148	28001
D6	1N4148	28001
D7	1N4148	28001
D8	1N4148	28001
D9	1N750 4.7V ZENER	28058
D10	1N4148	28001
D11	1N4148	28001
D12	1N4148	28001
D13	1N4148	28001
D14	1N4148	28001
K1	SCRN RELAY	32103
K2	KEY/OFF RELAY	32120
K3	OP/STBY RELAY	32120
K4	KEY_OUT RELAY	32081
L1	100UH	21060
Q1	MPSW01	25023
Q2	MJE371	25105
Q3	MJE371	25105
Q4	MJE371	25105
Q5	MJE371	25105
Q6	2N4124	25258
Q7	2N4124	25258
Q8	2N4124	25258
Q9	2N4124	25258
Q10	MPSW01	25053
Q11	2N5060 SCR	25039

ITEM	DESCRIPTION	TEN-TEC PART #
Q12	MPSW01	25053
Q13	2N4124	25258
Q14	2N4124	25258
Q15	2N4124	25258
Q17	2N4124	25258
Q18	2N4124	25258
Q19	2N6027 UJT	25185
Q20	2N5087	25001
Q21	2N4124	25258
Q22	2N5087	25001
Q23	2N4124	25258
R1	1K	30138
R2	1K	30138
R3	10K	30150
R4	220K	30077
R5	1K	30138
R6	1K	30138
R7	1.5K	30140
R8	1K	30138
R9	1K	30138
R10	1K	30138
R11	1K	30138
R12	10K	30150
R13	10K	30150
R14	10K	30150
R15	22K	30154
R16	22K	30154
R17	22K	30154
R19	47	30122
R20	10K	30150
R21	1K	30138
R22	1.5K	30140
R23	10K	30150
R24	10K	30150
R25	2.2K	30142
R26	10K	30150
R27	100	30126
R28	1K	30138
R29	8.2K	30149
R30	2.2K	30142
R31	10K	30150
R32	10K	30150
R34	10K	30150
R35	270	30131
R37	10K	30150

ITEM	DESCRIPTION	TEN-TEC PART #
R38	10K	30150
R39	10K	30150
R40	10K	30150
R41	10K	30150
R42	10K TRIMPOT	30619
R43	10K	30150
R45	10K	30150
R46	2.2K	30142
R47	4.7K	30146
R48	10K	30150
R49	10K	30150
R50	10K	30150
R51	4.7K	30146
R52	10K ALC POT	30267
U1	LM7812	25232

SCREEN SUPPLY BOARD A10  
81950

C1	100uF 160V	23516
C2	100uF 160V	23516
C3	100uF 160V	23516
C7	.01uF 1KV	23013
C8	10uF 25V	23266
C9	33uF 16V	23308
C10	100uF 160V	23516
C11	10uF 50V	23266
C12	.1uF	23261
C13	.1uF	23261
C14	.1uF 250V	23006
C15	100uF 160V	23516
C16	.1uF 250V	23006
C17	.01uF	23260
C18	10uF 25V	23266
C19	10uF 25V	23266
C20	.01uF	23260
C21	.01uF 1KV	23013
D1	1N5246 16V ZENER	28141
D2	1N756 8.2V ZENER	28019
D4	1A 1KV	28122
D5	1A 1KV	28122
D6	1A 1KV	28122

ITEM	DESCRIPTION	TEN-TEC PART #
D7	1A 1KV	28122
D8	1N5368 47V ZENER	28136
D9	1N5363 30V ZENER	28134
D10	1N5363 30V ZENER	28134
D11	1N5383 150V ZENER	28135
D12	1N5383 150V ZENER	28135
D13	1N4007	28043
D14	1N751 5.1V ZENER	28041
D15	1N4148	28001
D16	1N964 13V ZENER	28010
L1	100uH 100mA	21060
Q1	2N4124	25258
Q2	2N4124	25258
Q3	MPSA92	25107
Q4	MPSA92	25107
Q7	2N6517	25393
Q8	IRF830	25514
R1	15K	30076
R2	4.7K	30146
R3	100K	30161
R4	100K	30161
R5	10K	30150
R6	10K	30150
R7	100K	30161
R8	10K	30150
R13	12K 2W	30324
R14	3.3K .5W	30027
R17	4.7K 7W	30719
R18	680K .5W	30066
R19	680K .5W	30066
R20	680K .5W	30066
R21	680K .5W	30066
R22	22K	30154
R23	150 2W	30407
R24	100 OHM TRIMPOT	30617
R25	4.7K 7W	30719
R26	4.7K 7W	30719
R27	4.7K 7W	30719
R28	47 OHM 2W	30408
R29	10 OHM .5W	30022
Z1	MOV	30718



SWR BOARD A4  
81951

ITEM	DESCRIPTION	TEN-TEC PART #
C1	3-22pF	23169
C2	.01uF	23260
C3	.01uF	23260
C4	1uF 50V	23264
C5	1uF 50V	23264
C6	330pF	23397
C7	10pF	23371
C8	10pF	23371
C9	18pF	23373
C10	18pF	23373
C11	.01uF	23260
C12	.01uF	23260
C13	.01uF	23260
C14	.01uF	23260
C15	.01uF	23260
C16	.01uF	23260
C17	.01uF	23260
C18	1000uF 35V	23200
C19	.1uF FILM	23328
D1	1N4148	28001
D2	1N4148	28001
D3	1N4148	28001
D4	1N4148	28001
D5	1N4148	28001
D6	1N4148	28001
D7	1N4148	28001
D8	1N4148	28001
D9	1N4007	28043
D10	1N4007	28043
D11	1N4007	28043
D12	1N4148	28001
D13	1N4148	28001
D14	1N4007	28043
K1	REED RELAY	32049
L1	1mH RFC	21135
L2	1mH MOLDED	21007
L3	2.2uH	21116
L4	15uH	21126
L5	1mH RFC	21135
Q1	2N6517	25393
Q2	2N4124	25258
Q3	MPSA14	25253
R1	47 OHM 2W	30408
R2	330K	30302

ITEM	DESCRIPTION	TEN-TEC PART #
R3	680	30136
R4	330K	30302
R6	10K	30150
R7	330K	30302
R8	4.7K	30146
R9	100K	30161
R10	100K	30161
R11	100K	30161
R13	10K	30150
R14	100K	30161
R15	10K	30150
R16	270	30131
R17	10K	30150
T1	SWR XFMR	85380-15

RELAY BOARD A14  
81959

K1	OUTPUT RELAY	32101
	RELAY PCB	78270

LOAD CAP SHUNT BOARD A5  
81943

C1 - C9	150pF 3KV COG	23542
C10 - C12	150pF 3KV COG	23542

HV POWER SUPPLY BOARD A2  
81944

C1-8, C14	220MFD 400V EL	23409
C9, C12-14	.001MFD 6KV CER	23295
C11	.1MFD 250V FILM	23006
D1-D20	RECTIFIER GI P600J	28098
J2	AMP MATE-N-LOCK	35307
R1-16, R39, R44, R45	150K 2W	30311
R17-25, R42	680K 3/4W	30066
R36-38	1M 3W IRC GS3	30533
R40, R41	1.5 OHM 5W WW	30411
R43	10 OHM 25W WW	30310
Z1	VARISTOR, V39ZA1	30329