

# Instructions

## Model HF5B

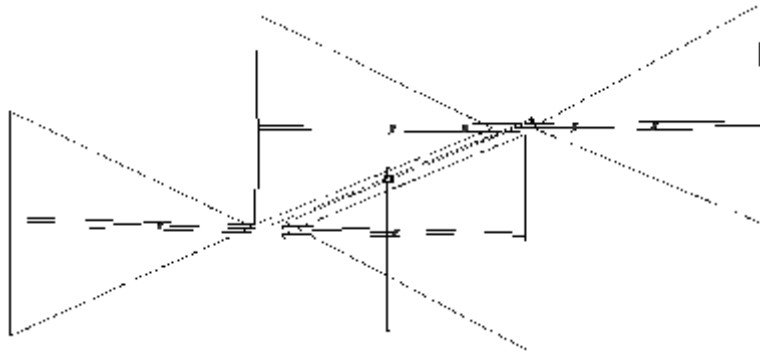

Butternut presents the model HF5B BUTTERFLY compact beam antenna for the 10, 12, 15, 17, and 20 meter amateur bands! With elements only 12 ft 6 in (3.8 m) long and a turning radius under 7 ft (2.1 m), it presents a low profile that allows it to be used in areas where other beam antennas would be restricted. High-efficiency design and broad-band BUTTERFLY elements deliver performance expected only in much larger designs.

### SPECIFICATIONS

- WINGSPAN: 12 ft 6 in (3.8 m)
- BOOM LENGTH: 6 ft (1.8 m)
- TURNING RADIUS: 6 ft 11 in (2.1 m)
- VERTICAL SPREADERS: 6 ft (1.8 m)
- SHIPPING WEIGHT: 22 lbs (10 kg)
- FEED POINT IMPEDANCE: Nominal 50 ohms. Includes RF connector for direct connection to any length feed line terminated in PL-259
- VSWR AT RESONANCE: 1.5:1 or less on all bands
- POWER RATING: 1200 W PEP
- WIND LOADING: 3 ft<sup>2</sup> (.3 m<sup>2</sup>)
- WIND SURVIVAL: 80 mph (129 kph)
- BANDWIDTH: VSWR 2:1 or less 1.5 MHz on 10 meters; entire band on 12, 15 and 17 meters; 200 kHz on 20 meters
- GAIN: 3+ dBd 20 meters, up to 5 dBd other bands except 17 meters where antenna acts as rotary dipole.
- FRONT-TO-BACK: Up to 20 dB
- FRONT-TO-SIDE: Up to 30 dB
- TUNING SYSTEM: No traps; entire element length active on all bands; no tuner required.
- MINIMUM RECOMMENDED HEIGHT ABOVE GROUND: 30 ft (9.1 m)

Accepts up to 1 1/2 in (38.1 mm) mast. Light enough to be turned with a TV rotator.

## BEFORE YOU START

**WARNING: INSTALLATION OF THIS PRODUCT NEAR POWER LINES IS DANGEROUS. FOR YOUR SAFETY FOLLOW THE INSTALLATION INSTRUCTIONS.**

**WARNING: AT NO TIME DURING ASSEMBLY, INSTALLATION, ADJUSTMENT, OR OPERATION SHOULD ANY PART OF THIS PRODUCT BE ALLOWED TO COME INTO CONTACT WITH ELECTRIC POWER LINES, NOR SHOULD THIS PRODUCT BE INSTALLED IN SUCH A WAY THAT ANY PART OF IT MAY CONTACT POWER LINES DURING NORMAL OPERATION OR IN THE EVENT OF STRUCTURAL FAILURE. FAILURE TO EXERCISE EXTREME CARE IN THIS MATTER CAN RESULT IN DAMAGE TO PROPERTY, PERSONAL INJURY, OR DEATH.**

Before you start assembling the antenna, read through the instructions completely, paying special attention to the pictorial diagrams. When you unpack the box, do so on a surface where you will not lose the small parts. Check the parts against the PARTS LIST, identifying each part carefully.

NOTE: Check to see that all parts are present before beginning assembly.

NOTE: 3/4" screws unless directed to use other sizes.







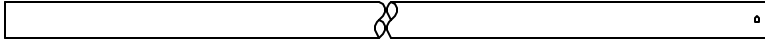
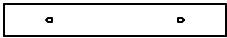

## INSTALLATION NOTES

**CHOOSING AN INSTALLATION SITE:** As with all directional antennas, care must be taken in the choice of an installation site for your HF5B. Pick a place clear of power lines or other obstructions. The HF5B should be mounted at least 30 ft (9.1 m) above the ground for proper operation. It should be able to rotate without hitting anything. Finally, it should not be near any large masses of metal, like metal roofing or siding. Plan your installation so that metallic guy wires are broken up with compression insulators and no other antennas are nearby (like dipoles mounted right under the beam).

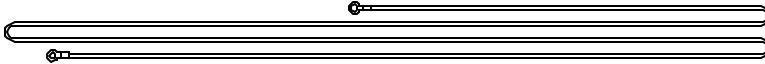
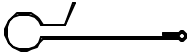



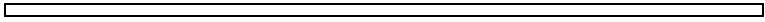

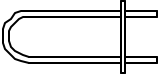
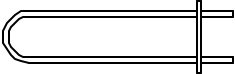

**BALUNS:** The sole purpose of the coaxial line "choke" balun shown in the instructions is to keep RF current from flowing on the outside of the coaxial feed line. It does NOT transform impedances. This form of balun has been featured in the ARRL Antenna Book for 40 years or more and it still works fine. It also costs next to nothing. If, for some reason, you wish to use a commercially manufactured 1:1 balun instead, make sure that it is installed BEFORE you do the "near ground" SWR adjustments on the driven element. Most baluns will introduce odd bits of reactance into an antenna to which they're connected, and that can throw off the tuning of a driven element that was adjusted with another balun in place or with no balun at all.

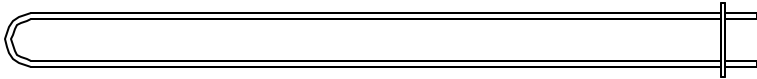
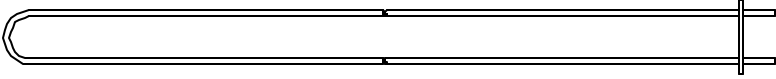
**MASTS AND GUYING:** In order to avoid coupling between antenna elements and guy wires that can detune the antenna it may be necessary to break up the guy wires with insulators. The typical metal "slip-up" mast calls for a set of guys every ten feet or so, and that usually means a set close to the top of the mast in order to steady the rotor and the antenna. If the separation between the antenna and the highest set of guys is less than about 15 ft (4.6 m) it would be a good idea to use insulators on each of the uppermost guys at intervals of 10 ft (3 m) or so. Place the first insulator on each guy AT THE MAST OR TOWER, for that too is a conductor that can be coupled to the antenna by any horizontal or near-horizontal guy wire connected to it. One or two insulators per guy wire should suffice because the HF5B elements extend only a little more than 6 ft (1.8m) from the mast, and any coupling to the guy wire past the second insulator will be negligible.

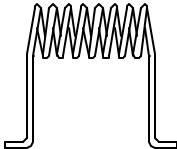
## PARTS LIST

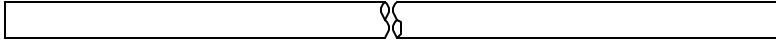
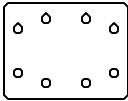
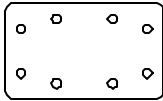
- |    |  |   |
|----|--|---|
|    |    |   |
| A. | V00010 TUBE A — 72 in x 1 1/8 in (1.8 m x 28.6 mm)                                   | 4 |
|    |     |   |
| B. | V00011 TUBE A INSULATOR  | 2 |
|    |    |   |
| C. | V00012 TUBE C — 72 in x 1/2 in (1.8 m x 12.7 mm)                                     | 4 |
|    |    |   |
| D. | V00014 WIRE  | 8 |
|    |     |   |
| E. | V00015 BRACKET END CLAMP E — 1 1/8 in x 3/16 in (28.6 mm x 4.8 mm)                   | 4 |
|    |     |   |
| F. | V00018 BRACKET END CLAMP F — 3/8 in x 3/16 in (9.5 mm x 4.8 mm)                      | 4 |
|    |   |   |
| G. | V00020 CLAMP SPACER G  | 4 |
|    |  |   |
| H. | V00028 TUBE H — 36 in x 3/8 in (91.4 cm x 9.5 mm)                                    | 1 |
|    |  |   |
| I. | V00029 TUBE I — 24 in x 3/8 in (61 cm x 9.5 mm)                                      | 1 |
|    |  |   |
| J. | V00030 TUBE J — 72 in x 3/8 in (1.8 m x 9.5 mm)                                      | 1 |
|    |   |   |
| K. | V00031 STUB K U-SHAPED — 4 7/8 in (12.4 cm) long                                     | 1 |
|    |   |   |
| L. | V00032 STUB L U-SHAPED — 7 1/4 in (18.4 cm) long                                     | 1 |

## PARTS LIST

		
M.	V00033 STUB M U-SHAPED — 23 3/8 in (59.4 cm) long	1
		
N.	V00034 STUB N U-SHAPED — 26 1/4 in (66.7 cm) long	1
		
O.	V00040 CONNECTOR ASSEMBLY	1
		
P.	V00065 COIL P DRIVEN ELEMENT MATCHING	1
		
Q.	V00024 COIL CLAMP Q MATCHING — 1/4 in x 3/8 in (6.4 mm x 9.5 mm)	2
		
R.	V00059 TUBE R — 72 in x 1 1/8 in (1.83 m x 28.6 mm)	1
		
S.	V00067 PLATE BOOM TO ELEMENT	2
		
T.	V00068 PLATE BOOM TO MAST	1
		
U.	V00051 U-BOLT 1 in x 1 3/4 in (25.4 mm x 44.5 mm)	4
		
V.	V00052 U-BOLT 1 1/8 in x 2 in (28.6 mm x 50.8 mm)	10
		
W.	V00053 U-BOLT 1 1/2 in x 2 3/4 in (38.1 mm x 69.9 mm)	2
		
X.	V00054 BACKING CLAMP 1 1/8 in #308 (28.6 mm)	10

## PARTS LIST

Y. V00055 BACKING CLAMP 1 1/2 in #309 (38.1 mm)  2

Z. V00057 LOCK WASHER 1/4 SPLIT RING 18-8  32

AA. V00056 NUT 1/4-20 HEX 18-8  32

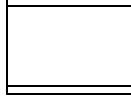
BB. V00061 BUTTER-IT'S-NOT  1

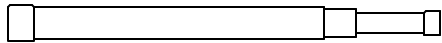
CC. V00063 CAPACITOR CC 10/15M REFLECTOR  1

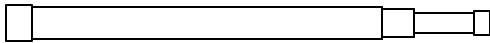
EE. V00062 CAPACITOR EE 10/15/20M  3

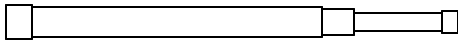
FF. V00064 CAPACITOR FF 12/17M DRIVEN ELEMENT  2

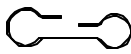
HH. V00044 CAPACITOR CLAMP HH — 1 1/8 in x 1 in (28.6 mm x 25.4 mm)  5

II. V00021 CAPACITOR CLAMP II — 5/8 in x 3/8 in (15.9 mm x 9.5 mm)  4





JJ. V00026 CAPACITOR CLAMP JJ — 1 in x 3/8 in (25.4 mm x 9.5 mm)  1

KK. V00022 CAPACITOR CLAMP KK — 3/16 in x 5/8 in (4.8 mm x 15.9 mm)  1

---

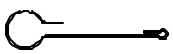
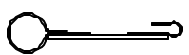
LL. V00060 ROD LL 12M — 28 in x 3/16 in (71.1 cm x 4.8 mm) 1

## PARTS LIST

			
MM.	V00017 ROD CLAMP — 1 1/8 in x 3/16 in (28.6 mm x 4.8 mm)		1
			
NN.	V00045 ROD CLAMP NN — 1 1/8 in x 3/16 in (28.6 mm x 4.8 mm)		1
			
OO.	V00023 COIL/CAPACITOR CLAMP OO 17M — 1/4 in x 5/8in (6.4 mm x 15.9 mm)		1
			
PP.	V00066 COIL PP 17M		1
			
QQ.	V00025 COIL CLAMP QQ 17M — 1/4 in x 3/8 in (6.4 mm x 9.5 mm)		1
			
RR.	V00050 KONNEKTOR-KOTE (1 X 8")		.05
SS.	V00082 HARDWARE PACKAGE		1

## BUTTERFLY™ ELEMENT ASSEMBLY

The Butterfly™ elements will be assembled first, tuned and then attached to the boom. The fully assembled antenna may then be installed on the mast. Although the antenna may rest on the ground for a short time, it's best to have your mast and rotor in place before assembly. NOTE: Mast, rotor and supporting structure are not included with the antenna.

1. Insert a 1 1/8" U-bolt (V) through backing clamp (X), then through the center holes of spreader tube (C). Slide the U-bolt over the end of element tube (A) that does not have the hole in it. The backing clamp (X) should now be sandwiched between element tube (A) and spreader tube (C). Position the edge of backing clamp (X) 3/4 in (19 mm) from the end of element tube (A). Secure the assembly with two 1/4" lock washers (Z) and two 1/4" hex nuts (AA) finger tight.

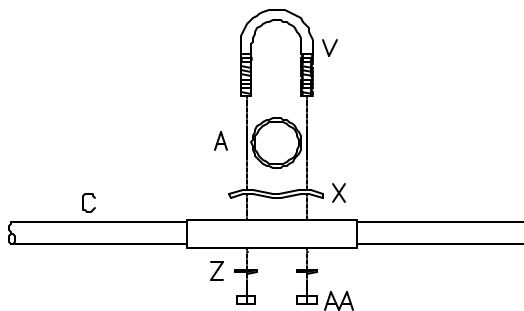

Place the “T” formed in step 1 on a flat surface with the threaded end of U-bolt (V) facing up. A couple of wood blocks may be used under spreader tube (C) to provide support.

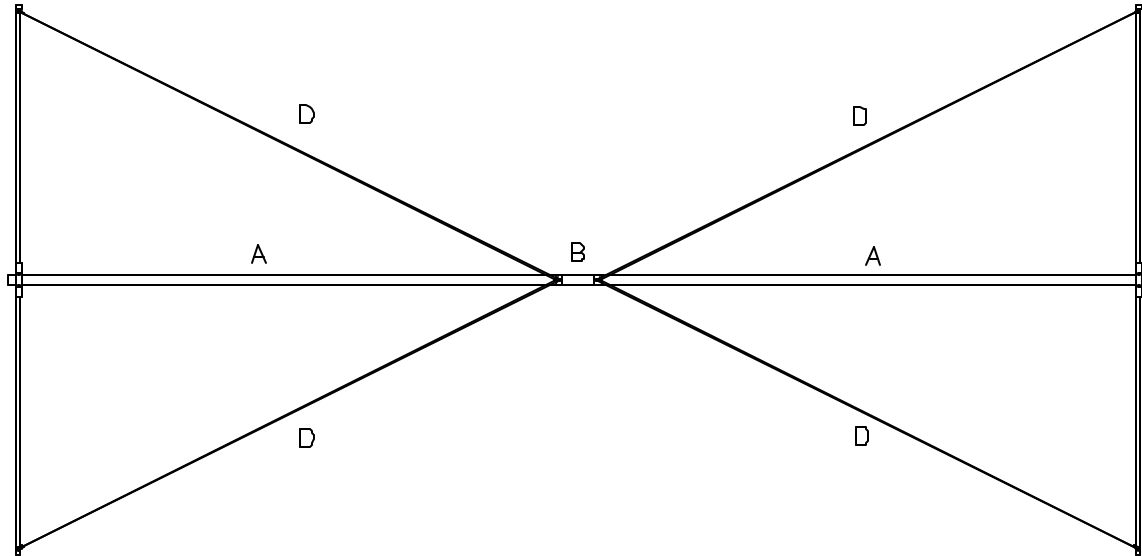

2. Insert one end of element tube insulator (B) into element tube (A) and align the holes. Insert a 1 1/2" bolt, from the bottom, through element tube (A) and element tube insulator (B). Lay out two spreader wires (D) and place one lug of each over the 1 1/2" bolt. Secure with a lock washer and hex nut.
3. Insert a 3/4" bolt from the bottom of spreader tube (C). Place the remaining lug of one of the previously attached spreader wires (D) over the 3/4" bolt and secure with a lock washer and hex nut.
4. Repeat step 3 for the remaining spreader wire (D) for the other end of spreader tube (C). Make a final alignment of tubes, U-bolt and spreader wires. Both spreader wires (D) should be on the same side of element tube (A) as spreader tube (C). A slight bowing of spreader tube (C) should be expected and will not hurt anything.

**NOTE: BE SURE THAT THE ALIGNMENT OF ELEMENT TUBE (A) AND SPREADER TUBE (C) IS CORRECT BEFORE PROCEEDING BECAUSE WHEN THE U-bolt IS FINALLY TIGHTENED, ELEMENT TUBE (A) WILL DISTORT JUST ENOUGH TO FIX SPREADER TUBE (C) INTO PLACE!**

Tighten 1/4" hex nuts (AA) until they are flush with the end of U-bolt (V). Tighten the three hex nuts securing spreader wires (D).

5. Assemble a second element tube (A), spreader tube (C), U-bolt (V) and spreader wires (D) as in steps 1 through 4, attaching it to the other end of element tube insulator (B). This will form a complete Butterfly™ element.

**NOTE: MAKE SURE THE CAPPED ENDS OF SPREADER TUBE (C) ARE BOTH POINTING IN THE SAME DIRECTION.**

6. Repeat steps 1 through 5 to assemble a second Butterfly™ element.

This completes the first part of the assembly process. Check your work to see that all parts are properly aligned and all hardware is tight.

## FOUR-WAY CLAMP ASSEMBLY

1. Using 3/4" bolt, attach plastic spacer (G) to bracket end clamp (E) and secure with lock washer and hex nut.
2. Attach the other end of plastic spacer (G) to end clamp (F) with a 3/4" bolt and secure with lock washer and hex nut as shown.
3. Repeat steps 1 through 3 for the remaining 3 clamp assemblies.

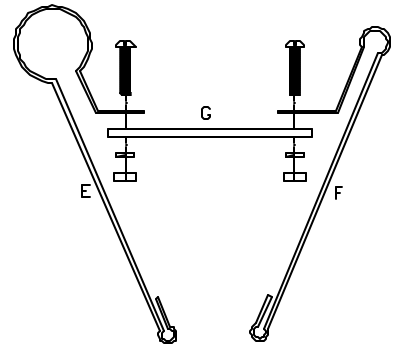

## DRIVEN ELEMENT ASSEMBLY

When you install clamps in the following steps, apply a light coating of Butter-It's-Not™ anti-seize/oxide paste at the spot where the clamp attaches to the tubing. A paper towel or cotton swab may be used for this purpose. Do not overdo it! Too much will cause problems later on.

1. Take either of the completed Butterfly™ elements and place it on a flat surface, using wood blocks for support at the ends. The threaded end of U-bolt (V) and spreader wire (D) should be facing down.

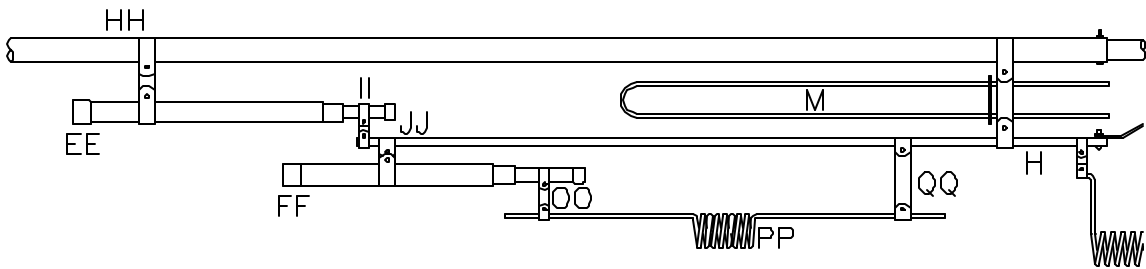

2. Place a 4-way clamp around the left element tube (A) 4 1/2 in (11.4 cm) from element tube insulator (B). Secure with a 1" bolt, lock washer and hex nut.
3. Install tube (H) on the left side of the element as shown making sure that the end with the hole is facing element tube insulator (B). Secure it with 3/4" bolt, lock washer and hex nut finger tight.
4. Position capacitor clamp (HH) 41 in (1 m) from 4-way clamp on the left element and secure it with 1" bolt, lock washer and hex nut.
5. Position capacitor clamp (II) 30 in (76.2 cm) from 4-way clamp on tube (H) and secure it with 3/4" bolt, lock washer and nut.
6. Install capacitor (EE) into the capacitor clamps installed above and secure it with 3/4" bolts, lock washers and hex nuts.
7. Using the chart below, position the u-shaped stub (M) on the 4-way clamp located on the left element and secure with 3/4" bolts, lock washers and hex nuts.

Band Segment (20 Meters)	Spacing
Low (CW) Segment	18 3/4 in (47.6 cm)
Middle Segment	18 in (45.7 cm)
High (Phone) Segment	18 in (45.7 cm)



## DRIVEN ELEMENT ASSEMBLY

8. Center 17M coil to cap clamp (OO) on the small tube of capacitor (FF) and secure with 3/4" bolt, lock washer and hex nut.
9. Position capacitor clamp (JJ) 6 7/8 in (17.5 cm) from 17M coil to cap clamp (OO) on capacitor (FF) and secure with 1" bolt, lock washer and hex nut.
10. Install the above assembly on tube (H) as shown. Secure with 3/4" bolt, lock washer and hex nut.
11. Position 17M coil clamp (QQ) 16 1/2 (41.9 cm) from 17M coil to cap clamp (OO) on tube (H) and secure with 3/4" bolt, lock washer and hex nut.
12. Install 17M coil (PP) between 17M coil clamp (QQ) and 17M coil to cap clamp (OO) and secure with 3/4" bolts, lock washers and hex nuts.

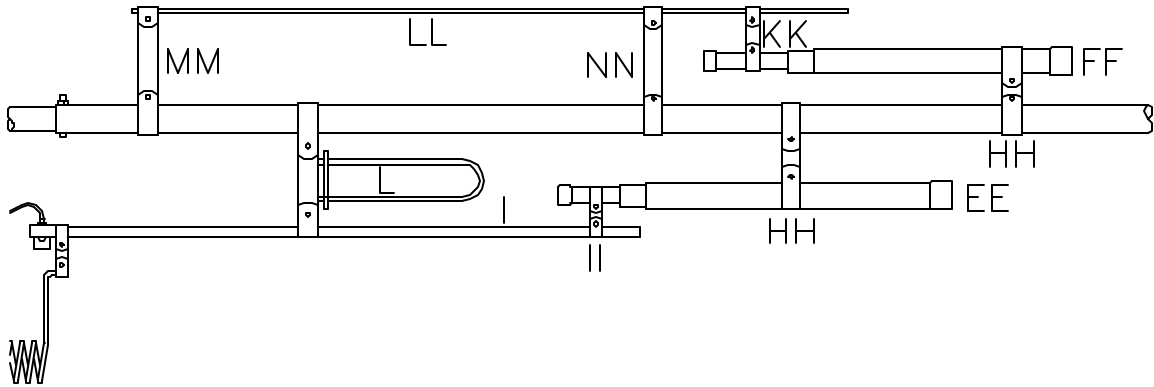

13. Place a second 4-way clamp around the right element tube (A). Using the chart below, position it from element tube insulator (B). Secure with a 1" bolt, lock washer and hex nut.

<b>Band Segment (15 &amp; 10 Meters)</b>	<b>Spacing</b>
Low (CW) Segment	9 3/8 in (23.8 cm)
Middle Segment	9 1/2 in (24.1 cm)
High (Phone) Segment	10 1/8 in (25.7 cm)

14. Install tube (I) on the right side of the element as shown. Secure it with 3/4" bolt, lock washer and hex nut finger tight.
15. Center capacitor clamp (II) on the small tube of capacitor (EE) securing it with 3/4" bolt, lock washer and hex nut.
16. Attach capacitor clamp (HH) to capacitor (EE) and position it 7 in (17.8 cm) from capacitor clamp (II). Secure it with 3/4" bolt, lock washer and hex nut.
17. Attach the above assembly to element tube (A) and position capacitor clamp (HH) 28 3/8 in (72.1 cm) from the element tube insulator (B). Secure capacitor clamp (II) with 3/4" bolt, lock washer and hex nut and capacitor clamp (HH) with 1" bolt, lock washer and hex nut.
18. Install u-shaped stub (L) on the 4-way clamp located on the right element and secure with 3/4" bolts, lock washers and hex nuts.
19. Position 12M rod clamp (MM) on the right element tube (A) 3 1/4 in (8.3 cm) from element tube insulator (B) and secure with 3/4" bolt, lock washer and hex nut.

## DRIVEN ELEMENT ASSEMBLY

20. Install 12M rod clamp (NN) to the right of 12M rod clamp (MM) and secure with 1" bolt, lock washer and hex nut.
21. Position the 12M rod (LL) in 12M rod clamps (NN) and (MM), securing it with 3/4" bolts, lock washers and hex nuts.
22. Center capacitor clamp (KK) on the small tube of capacitor (FF) and secure with 3/4" bolt, lock washer and hex nut.
23. Position capacitor clamp (HH) 9 1/2 in (24.1 cm) from capacitor clamp (KK) and secure with 3/4" bolt, lock washer and hex nut.
24. Attach the above assembly to 12M rod (LL) and position capacitor clamp (KK) 23 in (58.4 cm) from 12M rod clamp (MM) and secure with 3/4" bolt, lock washer and hex nut.
25. Secure the other capacitor clamp (HH) on above assembly to element tube (A) with 1" bolt, lock washer and hex nut.
26. Install SO-239 connector (O) to tube (I) and secure it with 3/4" bolt, lock washer and hex nut. Attach the free end of SO-239 connector (O) to tube (H) and secure it with 3/4" bolt, lock washer and hex nut.
27. Install the matching coil clamps (Q), one on tube (I) and the other on tube (H) and secure both with 3/4" bolts, lock washers and hex nuts.

NOTE: The gap between tube (H) and tube (I) is not critical but must be greater than 1".

28. Position driven element matching coil (P) between matching coil clamps (Q) and secure with 3/4" bolts, lock washers and hex nuts.

This completes assembly of the driven element. Carefully check initial set-up dimensions making sure everything is tight and set assembly aside.

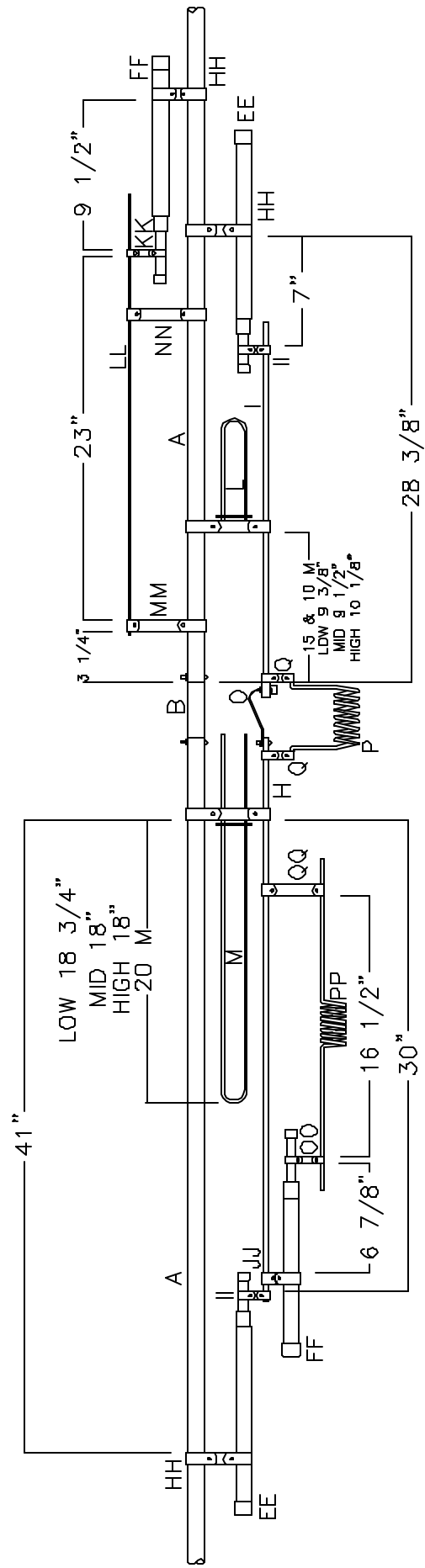

**Driven Element**

## REFLECTOR ELEMENT ASSEMBLY

1. Take the remaining Butterfly™ element and place it on a flat surface, using wood blocks for support at the ends. The threaded end of U-bolt (V) and spreader wire (D) should be facing down.
2. Place a 4-way clamp around the left element tube (A) 5 1/2 in (14 cm) from element tube insulator (B). Secure with a 1" bolt, lock washer and hex nut.
3. Place the remaining 4-way clamp around the right element tube (A) 9 3/8 in (23.8 cm) from the element tube insulator (B). Secure with a 1" bolt, lock washer and hex nut.
4. Attach tube (J) to the 4-way clamps and center over element tube insulator (B). Secure with 3/4" bolts, lock washers and hex nuts.
5. Install u-shaped stub (K) on the 4-way clamp located on the right element and secure with 3/4" bolts, lock washers and hex nuts.
6. Using the chart below, position the u-shaped stub (N) on the 4-way clamp located on the left element and secure with 3/4" bolts, lock washers and hex nuts.

<b>Band Segment (20 Meters)</b>	<b>Spacing</b>
Low (CW) Segment	24 3/4 in (62.9 cm)
Middle Segment	24 1/8 in (61.3 cm)
High (Phone) Segment	24 in (61 cm)

7. Center capacitor clamp (II) on the small tube of capacitor (EE) securing it with 3/4" bolt, lock washer and hex nut.
8. Attach capacitor clamp (HH) to capacitor (EE) and position it 10 in (25.4 cm) from capacitor clamp (II). Secure it with 3/4" bolt, lock washer and hex nut.
9. Attach the above assembly to the left element tube "A" and position capacitor clamp (HH) 33 1/4 in (84.5 cm) from the 4-way clamp. Secure with 1" bolt, lock washer and hex nut.
10. Install capacitor clamp (II) over tube (J) and secure with 3/4" bolt, lock washer and hex nut.
11. Center capacitor clamp (II) on the small tube of capacitor (CC) securing it with 3/4" bolt, lock washer and hex nut.
12. Attach capacitor clamp (HH) to capacitor (CC) and position it 5 in (12.7 cm) from capacitor clamp (II). Secure it with 3/4" bolt, lock washer and hex nut.
13. Using the chart below, position the above assembly element tube "A". Secure with 1" bolt, lock washer and hex nut.

<b>Band Segment (15 &amp; 10 Meters)</b>	<b>Spacing</b>
Low (CW) Segment	21 1/2 in (54.6 cm)
Middle Segment	21 1/8 in (53.7 cm)
High (Phone) Segment	21 in (53.3 cm)

14. Install capacitor clamp (II) over tube (J) and secure with 3/4" bolt, lock washer and hex nut.

This completes assembly of the reflector element. Carefully check initial set-up dimensions making sure everything is tight and set assembly aside.

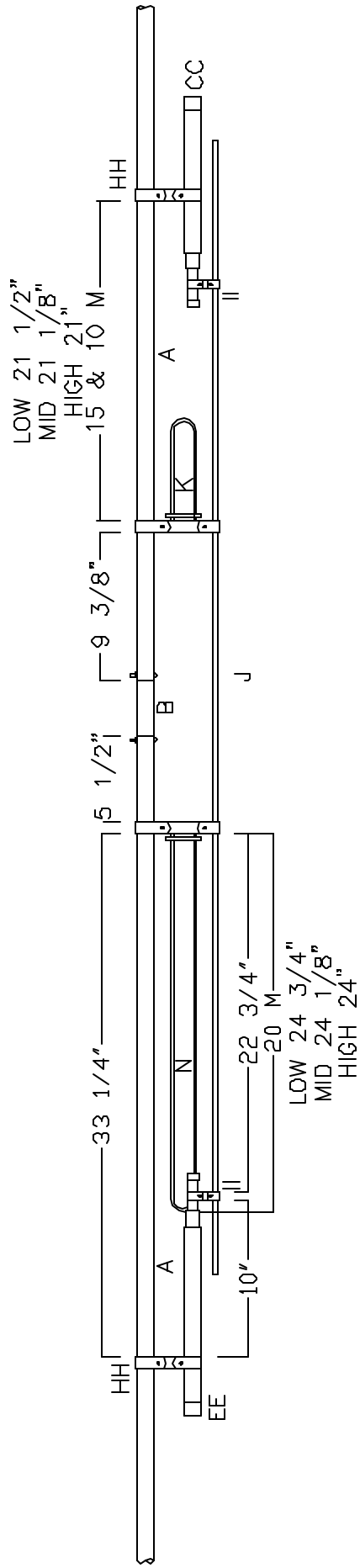

**Reflector**

## PRELIMINARY TUNING PROCEDURE

It is not always convenient or even possible to adjust the antenna at its full height above ground, so it is suggested that the following "Near-Ground" tuning procedure be used. Even if further tuning is contemplated once the antenna is raised to its full height, this procedure can greatly reduce the time one must spend on the tower.

**IMPORTANT:** This procedure calls for the reflector element to be set aside during the adjustment of the driven element. This means far enough away from the latter that it can't possibly exert any influence on the driven element tuning. Any attempt to adjust the driven element close to the earth with the reflector element in place will be a total waste of time and effort. Be sure not to place the driven element any higher than seven feet off the ground because resonance on all bands will increase rapidly at much greater heights. The SWR information below was gathered during examination of the driven element of an HF5B that had been carefully (and tediously) adjusted at a height of 50 feet for lowest SWR consistent with good F/B ratio.

The initial adjustment height of seven feet was chosen because it's not too hard to erect a simple and temporary mast of that height for adjustment purposes and because the earth itself will take the place of the reflector at that height, at least as far as driven-element resonance is concerned.

Remember that the height above ground and the mutual impedance between elements will have a lot to do with antenna resonance, feed point impedance, SWR, and F/B. The advantage of this tuning procedure is that if it's done properly you need not readjust the driven element once the antenna is raised to its final position. If later adjustments are needed for better F/B ratio or SWR they can be confined to the REFLECTOR element,

Be sure that the feed line approaches the driven element at right angles and that the driven element is well away from other conductors. Use good quality coax in runs that are no longer than necessary. Long runs of inexpensive RG-58 are to be avoided because the losses that go with it can produce abnormally broad SWR curves that make it difficult to find the frequency of lowest SWR with any accuracy.

A final thought or two for the perfectionist: it is all but impossible to adjust a parasitic array so that the maximum gain, maximum F/B rejection and lowest SWR will all occur at some particular frequency on a given band. Finally, the dimensions for the driven element given are only approximate. They MAY produce the desired resonances without further adjustment, but the likelihood is that they will not. The HF5B element is reduced to about 41% of normal size on 20 meters, so slight errors in measurement and the effect of nearby conductors will have greater effect on the tuning than with dipole element of more normal size. The key is to adjust the driven element for lowest SWR (not necessarily 1:1) at one of the frequencies given, and to set the reflector as described below.

For arrangement of components along the main tube of the driven element be guided by the pictorials, and if you find that one component interferes with the free travel of another simply reset that clamp to the other side of the obstruction and resume tuning. There are countless tuning combinations that will produce the desired resonances, but you need to find only one. The 17 meter coil adjustment is more critical than most, so adjustments must be made slowly and carefully.

The SWR bridge may be placed anywhere along the transmission line, but for the sake of convenience it may be left near the transmitter and monitored while another person makes tuning adjustments out at the driven element.

## PRELIMINARY TUNING - DRIVEN ELEMENT

Please note that in the following steps you will be tuning only the driven element. Set the reflector element aside during this procedure. Note too that you may be asked to tune the driven element for resonance or lowest SWR at frequencies far removed from those on which you intend to operate. No matter, for the resonances will change considerably when both elements are in place at their operating height.

## PRELIMINARY TUNING - DRIVEN ELEMENT

As always, the antenna should be clear of wires and other conductors to which it might become coupled.

1. Begin with the initial dimensions shown in the pictorial diagram. After these adjustments are complete, set the reflector element aside and out of the way.
2. Position the driven element as shown below so that the plane of the element is approximately 7 ft (2.1 m). above the earth and roughly parallel to it.

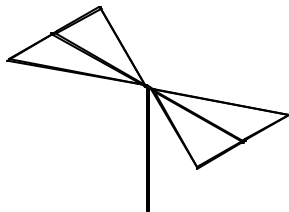

3. Connect an SWR bridge and a calibrated signal source (or a transmitter) to the driven element, making sure that the chassis is GROUNDED before plugging it into the power line in order to avoid electrical shock.
4. Make SWR measurements over the 20 meter band and compare them to the SWR data listed below. If your measurements, particularly the point at which your SWR is lowest, do not resemble those listed below it will be necessary to readjust the length of stub (M) until your lowest SWR reading occurs at or very near that shown below. To move your lowest SWR to a higher frequency shorten stub (M) by loosening the lower clamps of the 4-way assembly and pushing the open end of stub (M) closer to the center of the element; to move your lowest SWR point to a lower frequency increase the length of stub (M) by moving it in the opposite direction. Tighten the clamps and check the SWR again, repeating this adjustment until your frequency of lowest SWR is the same as shown below.

<b>Band Segment (20 Meters)</b>	<b>Tuning</b>
Low (CW) Segment	tune for lowest SWR at 14,140 kHz
Middle Segment	tune for lowest SWR at 14,285 kHz
High (Phone) Segment	tune for lowest SWR at 14,400 kHz

5. Your 20 meter adjustments should not be significantly affected by adjustments made for the other bands, so proceed to the 15/10 meter adjustment by noting your SWR readings over the 15 meter band and compare them to the information given below. For 15 and 10 meters the 4-way assembly, stub and all, on the other side of the element are moved toward the element center to lower the frequency of the lowest SWR and away from the element center to raise the frequency of the lowest SWR. Again, try to make your frequency of lowest SWR, coincide with that listed below.

<b>Band Segment (15 Meters)</b>	<b>Tuning</b>
Low (CW) Segment	tune for lowest SWR at 21,000 kHz
Middle Segment	tune for lowest SWR at 21,100 kHz
High (Phone) Segment	tune for lowest SWR at 21,225 kHz

6. Check your 10 meter SWR. This is determined by the previous 15 meter adjustment, but it should be reasonably close to the values given below. In any case, 10 meter tuning is quite broad, and your frequency of lowest SWR should not differ significantly from that shown in the following chart.

<b>Band Segment (10 Meters)</b>	<b>Tuning</b>
Low (CW) Segment	tune for lowest SWR at 28,300 kHz
Middle Segment	tune for lowest SWR at 28,475 kHz
High (Phone) Segment	tune for lowest SWR at 28,725 kHz

## **PRELIMINARY TUNING - DRIVEN ELEMENT**

7. Check SWR on 12 meters. Adjust for lowest SWR at 24.900 MHz. This adjustment involves sliding double clamp (KK) along rod (LL) and capacitor (FF) to find the right amount of inductance and to raise or lower 12 meter resonance. If more travel along rod (LL) is required, loosen the end of double-clamp (HH) and slide capacitor (FF) and clamp (KK) as needed towards the element center to raise the lowest SWR frequency, or away from the center to lower it.
8. Check the SWR on 17 meters. Tuning on this band is accomplished by varying the inductance of the coil by sliding double-clamp (OO) along capacitor (FF) and the coil lead, toward the center of the element to raise frequency and in the opposite direction to lower frequency. Adjust for lowest SWR at 18.070 MHz. If more travel is needed along the coil lead for clamp (OO), loosen the large clamp on capacitor (FF), and move capacitor (FF) in or out as needed.
9. Re-check SWR on the other bands to make sure that nothing has changed, and readjust as required. This completes the near-ground tuning procedure for the driven element.

## **PRELIMINARY TUNING - REFLECTOR**

The reflector element does not usually require any special attention because there are fewer circuits to adjust and because the capacitors are carefully selected with respect to tolerance. The preliminary settings given in the pictorial should suffice in most cases. On the other hand, miniature antennas are inherently much more critical with regard to adjustment for best F/B ratio and SWR. On all but 20 meters the HF5B would have to be adjusted in place for best possible F/B over a particular band segment, but the consensus is that even with full size arrays of only two elements such exertions are seldom warranted because the possible improvement is not too great to begin with.

If however, one wishes to adjust the 20 meter reflector tuning for lowest SWR at some particular frequency refer to the pictorial diagram of the reflector. If tubular capacitor (EE) is moved closer to the center of the element, the reflector will resonate at a higher frequency and the lower of the two dips in the 20 meter SWR pattern will similarly move higher in the band. If capacitor (EE) is moved out to the end of the element, the resonance will drop to a lower frequency as will the lower dip in the 20 meter SWR pattern.

A change of approximately 1/2 inch in the position of capacitor (EE) will shift the 20 meter resonance approximately 50 kHz. Remember, however, that the two dips on 20 meters should remain from 150 to 200 kHz apart for reasonably good F/B rejection and that similar readjustment to the driven element may then become necessary.

## **FINAL ASSEMBLY**

In the final assembly, the two elements will be installed on boom tube (R).

1. Attach one boom to element plate (S) to each element using two 1" U-bolt (U), four 1/4" lock washer (Z) and four 1/4" hex nut (AA) per element. Do not use backing clamp (X) with the 1" U-bolt (U).

**NOTE: BE SURE THAT BOOM TO ELEMENT PLATE (S) IS CENTERED ON THE ELEMENT TUBE INSULATOR (B) AND DOES NOT SHORT TO EITHER ELEMENT TUBE (A)!**



## FINAL ASSEMBLY

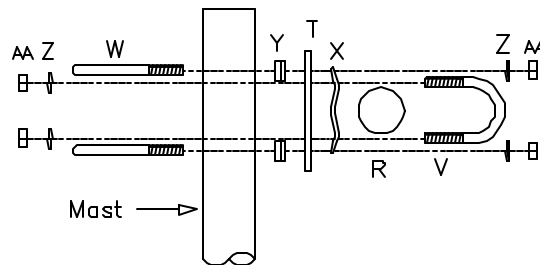
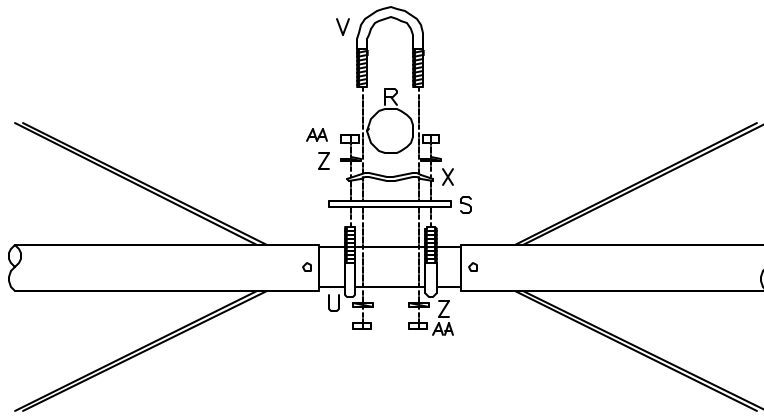

2. Install boom to mast plate (T) on boom tube (R) using two 1 1/8" U-bolt (V), two 1-1/8" backing clamp (X), four 1/4" lock washer (Z) and four 1/4" hex nut (AA).
3. Install two 1 1/2" U-bolt (W) on the opposite side of boom to mast plate (T) using two 1 1/2" backing clamp, four 1/4" lock washer (Z) and four 1/4" hex nut (AA). Do not tighten until the antenna is installed on the mast (not provided).

**IMPORTANT! READ THE FOLLOWING STEP THROUGH TO THE END BEFORE PROCEEDING!**

4. Install the driven element on the end of boom tube (R) using two 1 1/8" U-bolt (V), two 1-1/8" backing clamp (X), four 1/4" lock washer (Z) and four 1/4" hex nut (AA). Position the driven element so the SO-239 connector (O) and u-shaped stub (L) are on the RIGHT side as viewed from the center of the antenna.
5. Install the reflector element on the other end of boom tube (R) using two 1 1/8" U-bolt (V), two 1-1/8" backing clamp (X), four 1/4" lock washer (Z) and four 1/4" hex nut (AA). Position the reflector element so the u-shaped stub (K) is on the RIGHT side as viewed from the center of the antenna.

This completes the final assembly. Both elements should be on the boom, with the boom to mast plate (T) mounted in the center. The edges of the boom to element plates (S) should be within 1/4" of the plastic end caps on boom tube (R). The spreader tubes (C) and boom to mast plate (T) should be aligned 90° to the ground.

## INSTALLATION NOTES

The antenna may be installed as a unit atop the mast, or it may be installed one element at a time. Be sure that the 10/15 meter side of each element is on your right as you face it from the tower. Either way watch out for POWER LINES, guy wires, or other obstructions that may catch the antenna as it is going up, causing damage, injury, or even death.

If you are using a small rotor, it must either be used with a thrust bearing or be mounted right under the boom. A long mast above the rotor will result in damage to the rotor and antenna unless a thrust bearing is used.

Guy wires must either be out of the immediate field of the antenna, nonconductive, or broken up by compression insulators into non resonant lengths.

Do not hang dipoles below the beam! They will detune it.

The HF5B like any other 20 meter beam, must be AT LEAST 30 FT (9.1 M) above ground and "in the clear" to work properly. If you do not heed this instruction, do not be surprised if there are tuning problems.

### CONNECTING THE FEED LINE

1. The HF5B should be fed with any good quality 50 ohm coaxial cable terminated in a PL-259 plug.

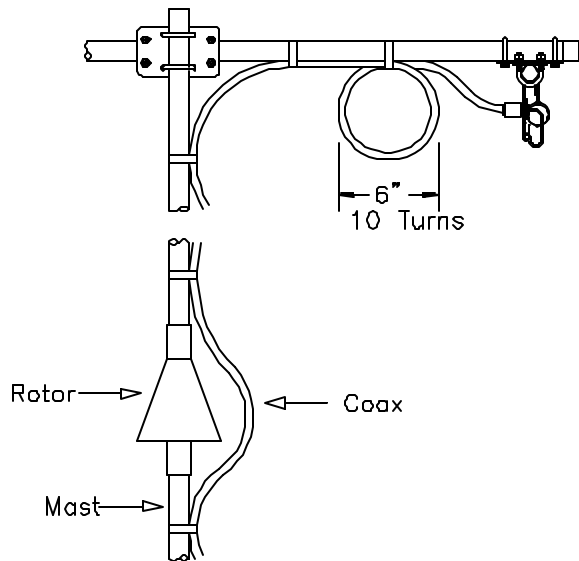

Install the coax feedline as shown. Make a 10 turn coil of coax 6 in (15.2 cm) in diameter and tape it to the boom. This takes place of a balun and keeps RF off of the feedline and tower. Then tape the feedline to the boom and mast. Be sure that the coax is not free to swing in the wind, putting stress on the coax connector!

**FROM THE AC MAINS TO AVOID SHOCK!**

2. A 1:1 balun (not included) may be used at the feed point but is not necessary. If you are not planning to use a balun, construct an RF choke by winding about 10 turns of the coax feed line in a 6 inch (15.2 cm) diameter coil, tape the coil together, and hang it from the boom with tape or wire. This device will help to keep RF off of the feed line and tower.
3. Dress the coax along the boom, down and around the rotor in a loop loose enough to allow 360 degrees of rotation, and along the tower. Avoid loose, dangling feed lines, as this can cause tuning problems.
4. Use the small roll of coax sealer (PP) to cover the junction of the PL-259 and the SO-239. Do not place the sealer on the opposite side of the SO-239 where the wire is soldered.

**NOTE: THE COAX BRAID WILL BE AT GROUND POTENTIAL IF THE ANTENNA IS INSTALLED ON A GROUNDED SUPPORT! BEFORE CONNECTING THE COAX TO YOUR EQUIPMENT, DISCONNECT THE EQUIPMENT**

### FINAL TUNING

The HF5B is an efficient, short, high-Q circuit. As such, bandwidth tends to be a bit narrow on 20

## FINAL TUNING

meters, where the 12 ft 6 in (3.8 m) elements represent only a small fraction of a wavelength. When bandwidth is narrow, it is impossible "cookbook" the antenna by setting it according to the suggested starting dimensions, then installing it on a push-up mast, where it will be unreachable for tuning! Be prepared to do some tuning, even though you have set the antenna up per the instructions!

Note: Tuning adjustments for the driven element on 20 meters are made by changing the length of the 20 meter stub (M). Tuning for 15 and 10 meters involves moving the 4-way clamp assembly on the other side of the element. Tuning on 17 and 12 meters is largely a matter of choosing the right length of rod or coil lead where indicated, although slight compression or expansion of the 17 meter coil may be a more convenient way to change circuit inductance on that band. All other driven element dimensions should be considered fixed for all bands and tuning conditions. Please read the following material carefully before attempting to install the HF5B atop a tall mast where it cannot be reached for final adjustment.

Using low power, start with the 20 meter band, making an SWR curve. Make curves for 17, 15, 12, & 10 meters. If high SWR is encountered on all bands, suspect feed line or connector problems. Test the feed line for shorts or opens.

Ideally, your SWR curves should look like the ones you see in Figure 1, for 20, 15, and 10 meters.

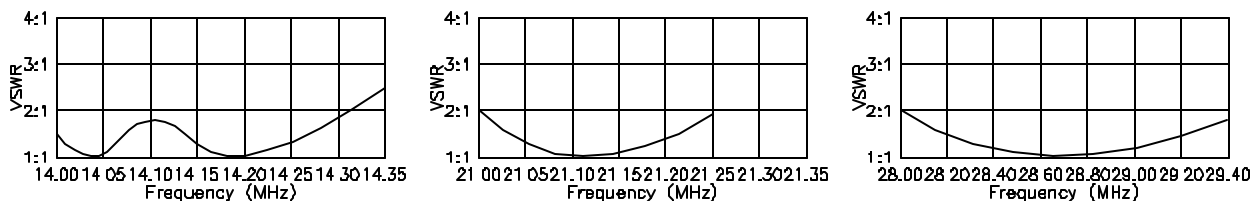

Figure 1

The "dips" in the 20 meter curve should be 150-200 kHz apart. The higher frequency "dip" (on the right) is from the driven element. The lower frequency dip is from the reflector. **CHANGING ONE WILL AFFECT THE OTHER!**

### EXPLANATION OF FIGURE 1

Please note that there were three sets of measurements given for 20 meter tuning depending on whether you want the best SWR bandwidth and front-to-back ratio at the low, middle, or high end of the band. 15 and 10 meter tuning "track", and it is generally not possible to tune for absolute lowest SWR at the low end of 10 meters without pulling the 15 meter resonance below 21 MHz. If, however, you wish to operate over the low end of 10 meters with SWR no greater than 1.5 you should be able to do so and still keep the minimum SWR above 21 MHz.

Pay special attention to the 20 meter SWR curve in Figure 1. This "double-dip" curve is characteristic of tightly-coupled short elements and indicates that the parasitic reflector element is tuned only slightly below the driven element on this band. The lower of the two dips represents reflector resonance, and the upper dip (on the right) represents driven element resonance. The SWR curves in Figure 1 were obtained when the antenna was mounted at a height of 50 ft (15.2 m) and in the clear; at heights below about 30 ft (9.1 m) you may see very different curves, especially if there are other conductors in the antenna's field.

The 20 meter SWR curve in Figure 1 shows a difference in element tuning of about 160 kHz. Suppose that the reflector element were adjusted for resonance at a slightly higher frequency or that the driven element were adjusted for a slightly lower frequency. In such a case the two dips would tend to blend into a single broad one. This arrangement is a common tuning error and will not yield very good F/B ratio. If, on the other hand, the two dips are too far apart, one or even both dips may lie outside the band edges, in which case both SWR and F/B will suffer. Luckily, forward gain is much less critical and should not vary more than a decibel.

## FINAL TUNING

F/B rejection will occur only over the LOWER, part of the SWR curve (the dip on the left), and will be greatest when the difference between the dips is 150-200kHz. When the two dips are close together, they tend to blend into a single broad dip, especially when the antenna is close to the ground. The advantages of seeking the "double-dip" SWR curve is that its presence indicates a condition where the antenna is tuned for reasonably good F/B rejection and that the operator may observe the effect of adjustments made to the elements.

In any case, the proper procedure is to adjust for 20 meters first, then for 15 meters, 10 meters, 12 meters and finally 17 meters. Remember, as before, it is assumed that you are viewing the element from the tower, sighting along the boom from the mast. Tuning adjustments for 20 meters are made to the LEFT side of each element while those for 15/10 meters are made on the RIGHT side. 15/10 meter tuning is interlocked to some extent, but separate adjustments for 10 is usually not necessary as tuning is quite broad on that band.

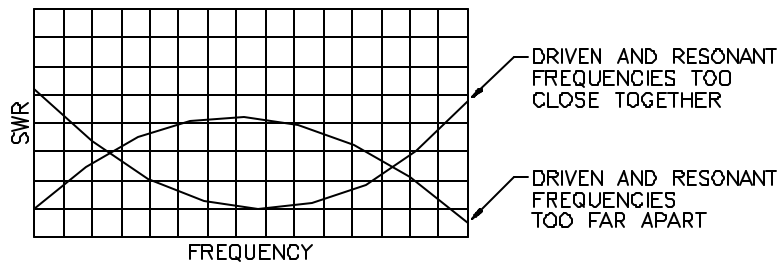

If the preliminary settings do not produce SWR curves on 10, 15, and 20 meters similar to those in Table 1, it may be necessary to modify those settings. Remember, however, that the evils of SWR greater than 1:1 have been grossly exaggerated in recent years and that time and effort spent in tedious adjustments to achieve the lowest possible SWR on a given band will usually produce no noticeable improvement in one's signal at a distant point! If the preliminary settings result in an SWR of, say 2:1 or less over the intended operating range, and if the transmitter is capable of delivering its rated power to the load represented by the feed line and antenna system, adjustment for lower SWR will probably not be worth the extra time and effort.

## ROOFTOP INSTALLATIONS

Even though one has a high roof that seems suitable for the purpose of installing antennas, some cautions should be observed. Wiring or other conductors in the attic or immediately under the roof covering can become coupled to the antenna and affect its performance to a marked extent. Metal flashing under shingles, rain gutters and other antennas and their feedlines, can all cause problems such as high SWR and loss of F/B rejection, as can the beam's feed line if it can't be run straight down from the antenna for a quarter-wavelength or more before it has to run off in another direction. Unfortunately, some of these problems can remain unseen or inaccessible, and there may be no cure for them short of relocating the beam. If SWR changes significantly as the beam is rotated you should suspect some conductor or mass of metal that you've overlooked.

## USING HIGH POWER

The HF5B is rated at 1,200 watts PEP input power to the final amplifier. Exceeding this power level can cause serious damage to the antenna. Avoid "pushing" this limit by a few hundred watts. To avoid exceeding power limits, calculate INPUT power by multiplying AMPS times VOLTS on the amplifier's meter, and adding feedthrough power for grounded-grid operation. THIS TOTAL SHOULD NOT BE MORE THAN 1000 WATTS D.C.! DO NOT RELY ON A WATTMETER PLACED IN THE LINE

## **OPERATION**

**AFTER THE AMPLIFIER TO MEASURE POWER! IT IS EASY TO EXCEED LEGAL LIMITS AND FAR EXCEED THE RATED LIMITS OF THE HF5B BY DOING SO.**

The HF5B operates as a two element beam antenna on 10, 12, 15, and 20 meters. On 17 meters only the driven element is active, and the element operates as a dipole. The direction of maximum signal on 10, 15, and 20 meters is off the driven element, with the second element acting as a reflector. On 12 meters however, the second element is self-resonant above the driven element and acts as a director. Therefore, maximum signal on 12 meters is off the back of the antenna. Because the second element is not in the circuit on 17 meters, the driven element alone is active on that band, and no "front-to-back" will be observed, although there will be noticeable "front-to-side" difference in signal strength.

There are no high impedance "traps" used to isolate sections of the elements in the HF5B design. As a result, the entire element is active on all bands, except for the reflector, which is not used for 17 meter operation. The U-shaped stubs and 3/8 inch tubes provide variable inductive reactance on their respective bands, while the capacitors contribute fixed capacitive reactance on their respective bands. The values of reactance are chosen to allow simultaneous resonances of the element on five bands without the need for external tuners or mechanical switching. On 12 and 17 meters, the rod and coil take the place of U-shaped stubs to provide the necessary inductive reactance. Impedance matching to the short element on 20 meters is accomplished by placing a coil across the feed point. Fine tuning for the best match is accomplished by compressing or expanding this coil slightly. To achieve maximum bandwidth, the element "diameter" is increased by terminating the element in 6 foot spreaders and connecting the spread tips to the element's center with the twisted wires.

Although the elements are only 12 feet 6 inches, efficiency is maintained by using the entire element length and high-Q circuitry. Therefore, performance compared to a larger two-element beam is barely compromised. Gain, front-to-back ratio, and front-to-side ratio are maintained in comparison to larger beams, assuming the dual requirements of adequate operating height and a clear "field" are met. The major compromises in a short antenna like the HF5B are a narrowed SWR bandwidth and a limited power handling capacity.

## **CUSTOMER SERVICE**

For service, please write to us including ALL PERTINENT INFORMATION. This means SWR CURVES, COMPLETE DESCRIPTION OF YOUR INSTALLATION, AND DESCRIPTION OF SYMPTOMS.

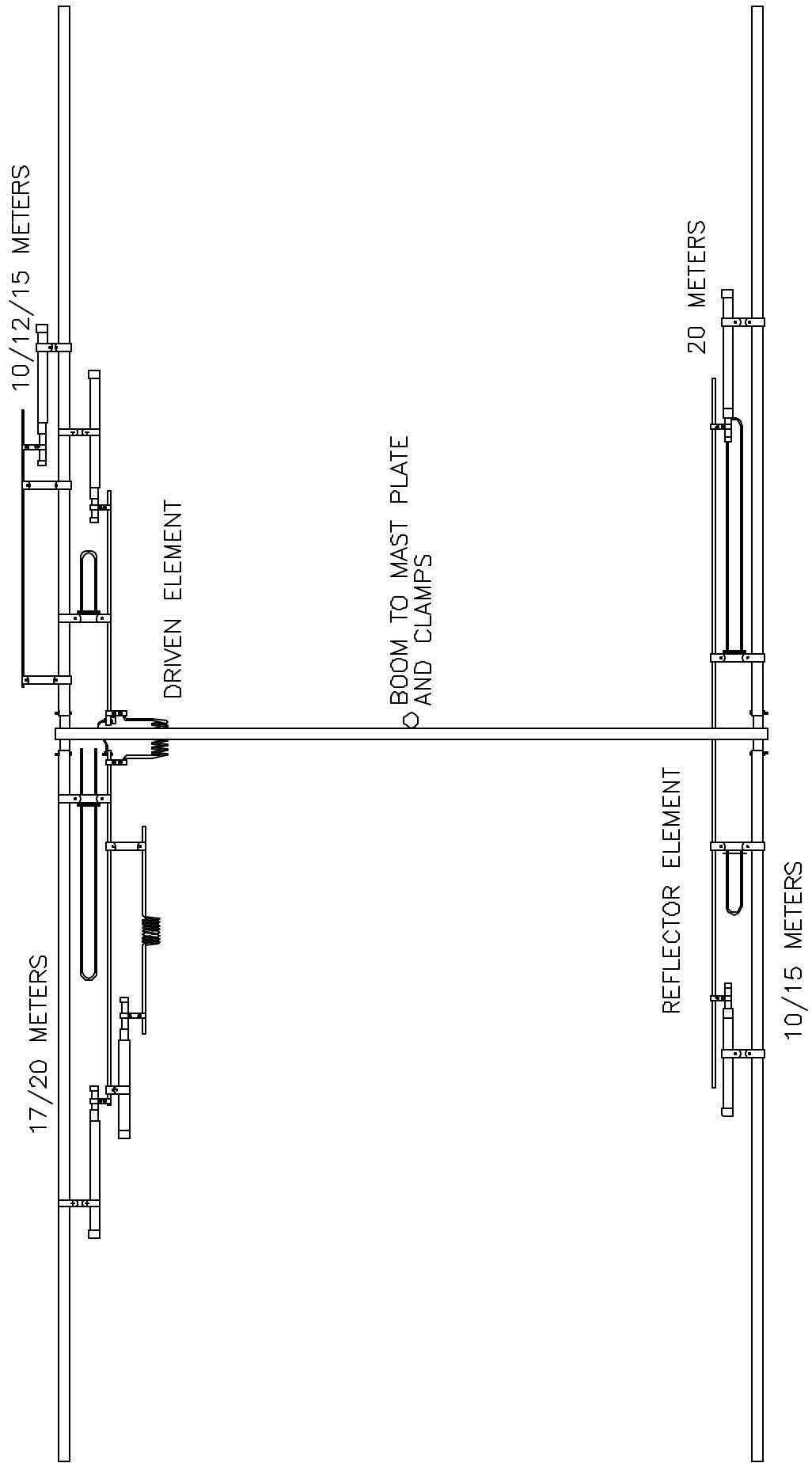

Top View



## LIMITED WARRANTY

Butternut Manufacturing Co. warrants on the terms hereof, to a Customer who has purchased a Product from a Seller, for a period of one year from the date of the purchase, that the Product was not Defective, but this warranty is void if the Product has been subjected to improper or abnormal installation or usage, or a serial number on the Product has been defaced or removed.

If a Customer believes that a Product is Defective, the customer may, within such one-year period, return the entire product to Butternut at Butternut's factory, all shipping charges pre-paid by the Customer. If the Product was Defective, Butternut will at its option and expense repair or replace the Product and will at its expense return the repaired or replaced Product to the customer, in a manner selected by Butternut, at the address from which the Customer sent the Product to Butternut.

THE ABOVE WARRANTY AND REMEDY ARE EXCLUSIVE AND ARE IN LIEU OF ALL OTHER WARRANTIES, EXPRESS OR IMPLIED, INCLUDING BUT NOT LIMITED TO IMPLIED WARRANTIES OF MERCHANTABILITY AND FITNESS FOR A PARTICULAR PURPOSE.

NO SELLER WILL BE LIABLE FOR ANY LOSS, INCONVENIENCE OR DAMAGE, INCLUDING DIRECT, SPECIAL, INCIDENTAL OR CONSEQUENTIAL DAMAGES RESULTING FROM THE USE OF OR INABILITY TO USE A PRODUCT, WHETHER THE LIABILITY WOULD RESULT FROM BREACH OF WARRANTY OR UNDER ANY OTHER LEGAL THEORY.

For instance, this warranty does not cover damage to or caused by an antenna (a) by reason of the antenna acting as a lighting rod, (b) by reason of corrosion or strain from exposure of an antenna to wind or weather, (c) from improper assembly, installation or use of an antenna, or (d) from failure periodically to inspect and maintain an antenna and its installation. The Customer is responsible to insure that installation and use of an antenna complies with applicable laws (such as zoning laws) and regulations (such as condominium regulations).

SOME LAWS DO NOT ALLOW THE EXCLUSION OF IMPLIED WARRANTIES, AND IF THESE LAWS APPLY, THEN ALL EXPRESS AND IMPLIED WARRANTIES ARE LIMITED IN DURATION TO SUCH ONE-YEAR PERIOD. NO WARRANTIES OF ANY KIND APPLY AFTER THAT PERIOD.

Such repair or replacement is the Customer's sole and exclusive remedy for a Defective Product. Specifically, Butternut is not liable (to the Customer or otherwise) for (a) any loss or damage arising in any way from a Product or from actual or anticipated sale, lease, license or use of a Product, or involving any matter such as interruption of service, loss of business or anticipated profits, or delay in receiving, repairing, replacing or returning a Product, or (b) any incidental, indirect, special or consequential damages.

No other person (such as an employee, agent or dealer) is authorized to change this warranty in any way, or to give any other warranties of any kind on behalf of Butternut. This warranty gives a Customer specific legal rights, and a Customer may also have other rights, which vary from state to state.

As used herein the *Customer* is the initial end-use purchaser of a Product from a Seller, a *Product* is an antenna or accessory therefor manufactured by Butternut, a Product is *Defective* if and only if the Product was not free of defects of material and workmanship when manufactured, and a *Seller* is Butternut and any authorized Butternut dealer.



Butternut Manufacturing Co.  
831 North Central Avenue Wood Dale Illinois 60191-1219  
Telephone 630 238 1183 Facsimile 630 238 1186 <http://www.bencher.com>