

20-4CD SKYWALKER

**20 METER
4 ELEMENT YAGI**



951354 (7/88)

Your Cushcraft 20 meter beam is designed and manufactured to give top performance and trouble free service. All hardware is stainless steel. The antenna will perform as specified if the instructions and suggestions are followed and care is used in assembly and installation. When checking the components received in your antenna package use the parts lists in each section. It is easiest to identify the various dimensions of tubing by separating them into groups of the same diameter and length. If you are unable to locate any tube or component, check the inside of all tubing. **IMPORTANT:** save the weight label from the outside of the carton. Each antenna is weighed at the factory to verify the parts count. If you claim a missing part, you will be asked for the weight verification label. There is a master parts list on page 3.

LOCATION

Location of the antenna is very important. Surrounding objects such as trees, power lines, other antennas, etc. will seriously reduce efficiency. To minimize the effects of surrounding objects, mount the antenna as high and in the clear as possible. If metal guy wires are used, they should be broken with strain insulators.

WARNING: THIS ANTENNA IS AN ELECTRICAL CONDUCTOR. CONTACT WITH POWER LINES CAN RESULT IN DEATH, OR SERIOUS INJURY. DO NOT INSTALL THIS ANTENNA WHERE THERE IS ANY POSSIBILITY OF CONTACT WITH OR HIGH VOLTAGE ARC-OVER FROM POWER CABLES OR SERVICE DROPS TO BUILDINGS. THE ANTENNA, SUPPORTING MAST AND/OR TOWER MUST NOT BE CLOSE TO ANY POWER LINES DURING INSTALLATION, REMOVAL OR IN THE EVENT PART OF THE SYSTEM SHOULD ACCIDENTALLY FALL. FOLLOW THE GUIDELINES FOR ANTENNA INSTALLATIONS RECOMMENDED BY THE U.S. CONSUMER PRODUCT SAFETY COMMISSION AND LISTED IN THE ENCLOSED PAMPHLET.

Plan your installation carefully. If you use volunteer helpers be sure that they are qualified to assist you. Make certain that everyone involved understands that you are the boss and that they must follow your instructions. If you have any doubts at all employ a professional antenna installation company to install your antenna.

MOUNTING

The mast mount bracket will accommodate up to a 2" OD (5.1 cm) mast. A 1 1/2" OD (3.8 cm) or larger heavy wall tubing mast should be used. A good heavy duty antenna rotator will provide the best service and longest life. Often it is desirable to mount several antennas on one mast. To keep possible interaction to a minimum, place your antennas as far apart as you can.

SYSTEM GROUNDING

Direct grounding of the antenna, mast and tower is very important. This serves as protection from lightning strikes and static buildup, and from high voltage which is present in the radio equipment connected to the antenna. A good electrical connection should be made to one or more ground rods (or other extensive ground system) directly at the base of the tower or mast, using at least 10AWG ground wire and non-corrosive hardware. For details and safety standards, consult the National Electrical Code. You should also use a coaxial lightning arrester. Cushcraft offers several different models, such as LAC-1, LAC-2 and the LAC-4 series.

TUNING PROCEDURE

If you wish to check the SWR before installation, please observe the following procedures. Temporarily mount the antenna with the boom vertical, reflector at least one foot (30 cm) off the ground on a non-metallic support (wooden box), to prevent detuning the antenna. Guy the top of the boom. Do not use line with wire in it (some clotheslines have a wire core). Keep other antennas, metal objects and guy lines clear of the antenna under test. Do not attempt to tune the Yagi near the ground with the boom parallel to the ground since ground effects will nullify any adjustment and degraded performance will result.

Run the coax cable from your transmitter to the area in which the antenna is going to be tested. The length of this cable or your feedline is not critical. Connect a good quality SWR bridge to the end of this cable. Connect a short length of cable [2 feet (61 cm) or less] from the SWR bridge to the antenna. Set the transmitter to your center operating frequency. When you read SWR, be sure you move far enough away from the antenna so that your body does not effect the reading.

Measure the SWR. If it is high, move the Reddi-Match clamp (128) by 1/4" (.6 cm) in one direction and check the SWR, if the SWR improved then continue moving the Reddi-Match clamp in the same direction. If the SWR deteriorated then move the Reddi-Match clamp in the opposite direction.

When no further improvement can be made you have matched your antenna to 50 Ohms. Then tighten all connections on the Reddi-Match assembly. Tape the feedline to the boom and mast.

MASTER PARTS LIST

KEY	P/N	DESCRIPTION	QTY	KEY	P/N	DESCRIPTION	QTY
BC		2 1/8" x 84" (5.4 x 213 cm) aluminum tubing, slotted and drilled both ends	2	70	190070	4" x 6" (10.2 x 15.2 cm) element mounting plate	4
BB		2" x 72" (5.1 x 183 cm) aluminum tubing, slotted one end, drilled both ends	2	403	010403	1 5/8" x 3" (4.1 x 7.6 cm) stainless steel U-bolt	8
BD		2" x 36" (5.1 x 91.4 cm) aluminum tubing, drilled both ends	1	404	010404	2 1/8" x 3" (5.4 x 7.6 cm) stainless steel U-bolt	13
BA		1 7/8" x 48" (4.8 x 122 cm) aluminum tubing, drilled one end	2	119	010119	5/16" (.8 cm) stainless steel lock washer	46
EA		1 1/4" x 36" (3.1 x 91.4 cm) aluminum tubing, slotted both ends	4	118	010118	5/16" (.8 cm) stainless steel hex nut	44
EB		1 1/8" x 72" (2.8 x 183 cm) aluminum tubing, swaged and slotted one end	8	9	010009	8-32 x 5/8" (1.6 cm) stainless steel round head slotted machine screw	4
EC		7/8" x 48" (2.2 x 122 cm) aluminum tubing, swaged and slotted one end	8	232	010232	8-32 x 2 1/2" (6.4 cm) stainless steel round head slotted machine screw	6
ED		5/8" x 36" (1.6 x 91.4 cm) aluminum tubing, slotted one end	8	10	010010	#8 stainless steel internal tooth lock washer	11
EE		1/2" x 58 1/2" (1.3 x 148.6 cm) aluminum tubing	2	11	010011	8-32 stainless steel hex nut	11
EF		1/2" x 50" (1.3 x 127 cm) aluminum tubing	2	140	010140	5/16 x 1 1/2" (.8 x 3.8 cm) stainless steel hex head bolt	2
EG		1/2" x 45" (1.3 x 114.3 cm) aluminum tubing	2	53	050053	1/2" (1.3 cm) black plastic cap	8
EH		1/2" x 20" (1.3 x 50.8 cm) aluminum tubing	2	58	050058	1 7/8" (4.8 cm) black plastic cap	2
BT		7/8" x 24" (2.2 x 61.0 cm) aluminum tubing, slotted both ends	2	107	150107	Reddi Match insulator	1
BR		3/4" x 48" (1.9 x 121.9 cm) aluminum tubing	4	110	200110	3/8" (.95 cm) Reddi Match clip	1
130	190130	6" x 6" (15.2 x 15.2 cm) mast mounting plate	1	115	050115	Connector boot	1
CB		Coaxial connector bracket assembly	1	116	240116	Silicone package	1
				126	200126	2" (5.1 cm) aluminum brace clamps	2
				928	200928	1 1/4" (3.2 cm) Reddi Match clip	1
				128	200128	1 1/8" x 3/8" (3.17 x .95 cm) Reddi Match strap	1
				63	170063	2" (5.1 cm) aluminum V-block	5
				414	030414	2 1/4" (5.4 cm) stainless steel worm clamp	6
				409	030409	7/8" (2.2 cm) stainless steel worm clamp	20
				411	030411	1 1/4" (3.2 cm) stainless steel worm clamp	16
				326	290326	Danger label	1
						Reddi-Match tube assembly	1

#1 - BOOM ASSEMBLY

Place a worm clamp (414) over the slotted ends of the BB and BC tubes. Position the brace clamps (126) on the BB and BC tubes as shown. The braces will be assembled later. Join the four sections of tube in the order illustrated below in figure A. Align the drilled holes and install screws (232), lock washers (10) and nuts (11). Tighten screws and worm clamps. Push end caps 58 onto each end of the boom.

FIGURE A

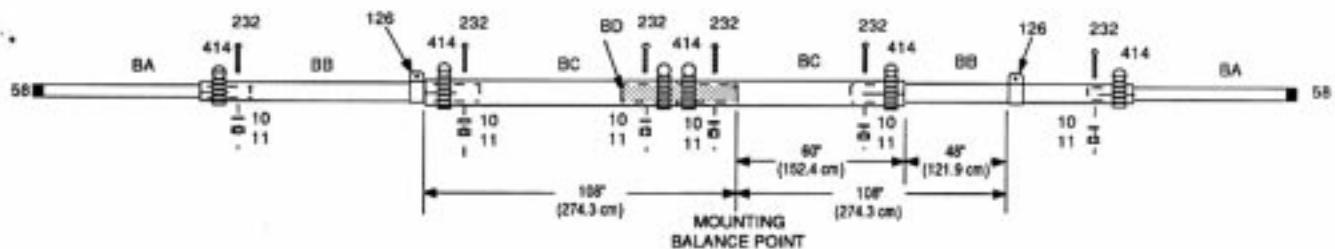

KEY	P/N	DISPLAY	DESC	SIZE	QTY	KEY	P/N	DISPLAY	DESC	SIZE	QTY
BA			ALUM TUBING	1 7/8" x 48" (4.8 x 122 cm)	2	11	010011		SS HEX NUT	8-32	6
BB			ALUM TUBING	2" x 72" (5.1 x 183 cm)	2	58	050058		PLASTIC CAP	1 7/8" (4.8 cm)	2
BC			ALUM TUBING	2 1/8" x 84" (5.4 x 213 cm)	2	232	010232		SS MACH SCREW	8-32 x 2 1/2" (6.4 cm)	6
BD			ALUM TUBING	2" x 36" (5.1 x 91.4 cm)	1	414	030414		SS WORM CLAMP	2 1/4" (5.4 cm)	6
10	010010		SS LOCK WASHER	#8	6	126	200126		BRACE CLAMP	2" (5.1 cm)	2

#2 - ELEMENT ASSEMBLY

Install clamp (928) on the EA tube of the #2 element. Place a worm clamp (411) on the end of each EA tube. Insert the EB tubes 4" (10.2 cm) into each end of the EA tube. Tighten the clamps securely. On the driven element section, slide the Reddi Match clamp (128) on as far as it will go. Place worm clamp (411) on the end of each EB tube. Repeat this procedure for the EC tubes and then the ED tubes using worm clamps (409). Insert the element tips EE, EF, EG and EH into the appropriate elements (figure B). Adjust the element tips and overall length to the dimensions listed in Chart A. Tighten all worm clamps and install caps (53) on the element tips.



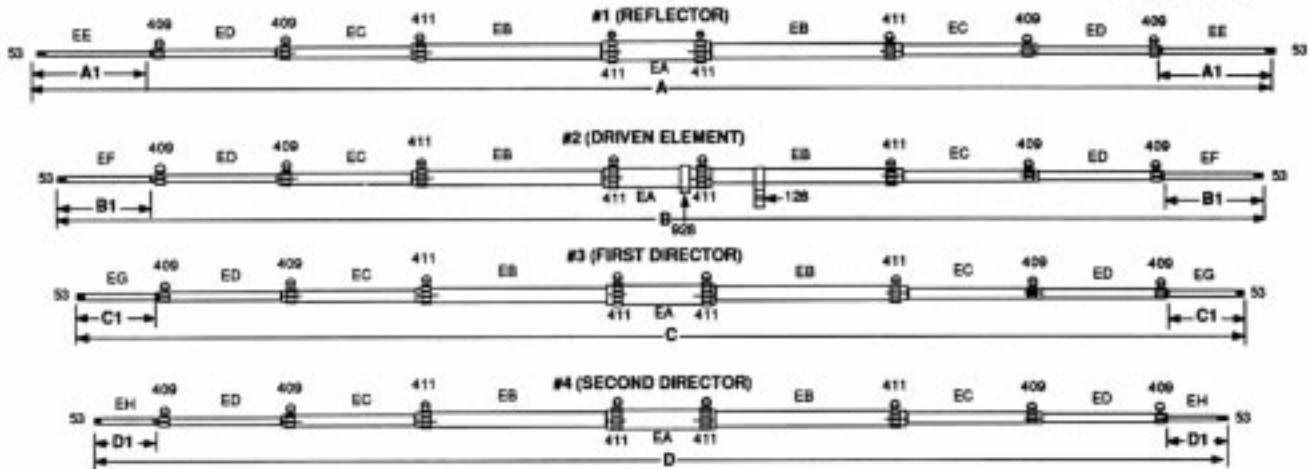

FIGURE B

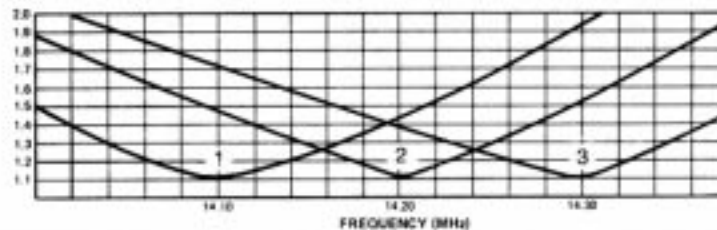

KEY	P/N	DISPLAY	DESC	SIZE	QTY	KEY	P/N	DISPLAY	DESC	SIZE	QTY
EA			ALUM TUBING	1 1/4" x 36" (3.1 x 91.4 cm)	4	EH			ALUM TUBING	1/2" x 20" (1.3 x 50.8 cm)	2
EB			ALUM TUBING	1 1/8" x 72" (2.8 x 183 cm)	8	53	050053		PLASTIC CAPS	1/2" (1.3 cm)	8
EC			ALUM TUBING	7/8" x 48" (2.2 x 122 cm)	8	128	200128		REDDI M STRAP	1 1/8 X 3/8" (3.1 X .96)	1
ED			ALUM TUBING	5/8" x 36" (1.6 x 91.4 cm)	8	409	030409		SS WORM CLAMP	7/8" (2.2 cm)	16
EE			ALUM TUBING	1/2" x 58 1/2" (1.3 x 148.6 cm)	2	411	030411		SS WORM CLAMP	1 1/4" (3.2 cm)	16
EF			ALUM TUBING	1/2" x 50" (1.3 x 127 cm)	2	928	200928		REDDI M CLIP	1 1/4" (3.2 cm)	1
EG			ALUM TUBING	1/2" x 45" (1.3 x 114.3 cm)	2						



FREQUENCY MHz	(1) 14.000 to 14.310		(2) 14.000 to 14.350		(3) 14.020 to 14.350	
	in.	cm	in.	cm	in.	cm
DIMENSION						
A	433	1100	430	1092	427	1085
A1	54 1/2	138.4	53	134.6	51 1/2	130.8
B	416	1057	413	1049	410	1041
B1	46	116.8	44 1/2	113.0	43	109.2
C	406	1031	403	1024	400	1016
C1	41	104.1	39 1/2	100.3	38	96.5
D	357	908	354	899	351	892
D1	16 1/2	41.9	15	38.1	13 1/2	34.3









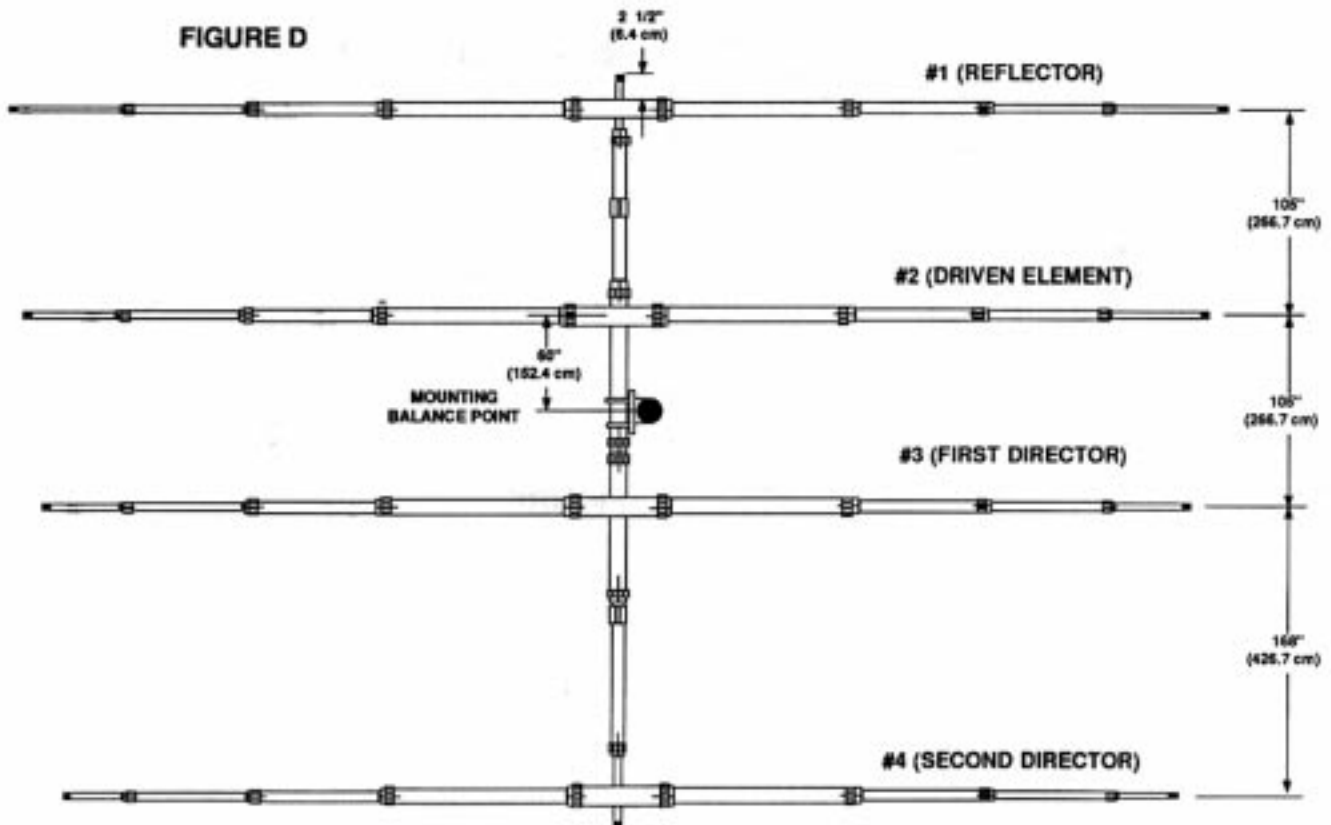
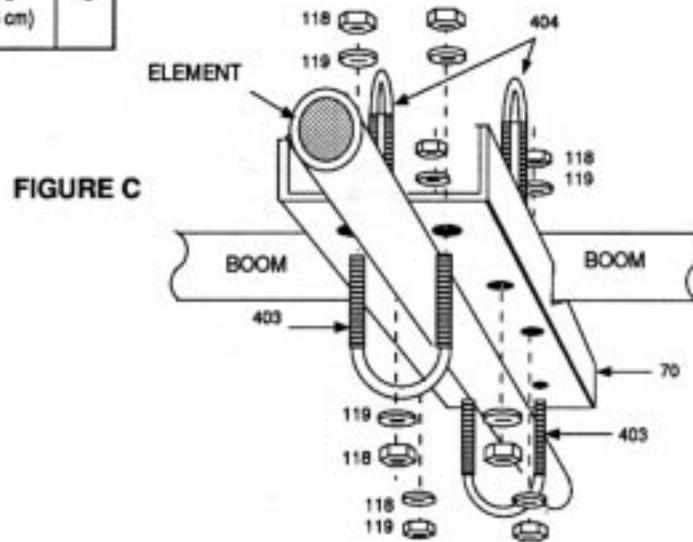



KEY	P/N	DISPLAY	DESC	SIZE	QTY
118	010118		SS HEX NUT	5/16" (.8 cm)	32
119	010119		SS LOCK WASHER	5/16" (.8 cm)	32
70	190070		MOUNTING PLATE	4" x 6" (10.2 x 15.2 cm)	4
403	010403		SS U-BOLTS	1 5/8" x 3" (4.1 x 7.6 cm)	8
404	010404		SS U-BOLT	2 1/8" x 3" (5.4 x 7.6 cm)	8

#3 - ELEMENT MOUNTING

Mount the element/boom brackets (70) as shown in figure C and E. Position the elements on the boom as shown in figure D. The longest element (reflector) is #1. Align the elements and tighten the U-bolts. Note that the driven element backing plate includes the connector bracket (CB). See figure E. This should be mounted with the connector pointing to the center of the boom to allow easy connection of the feedline.

CAUTION: Do not overtighten the U-bolts and distort the boom tubing.







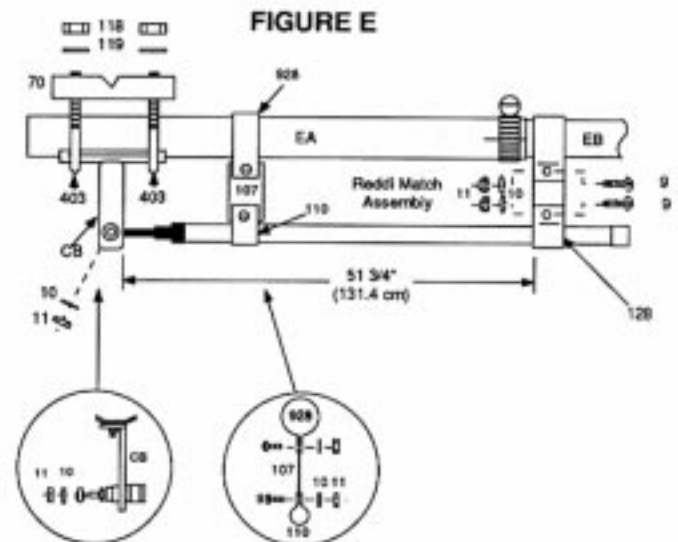

KEY	P/N	DISPLAY	DESC	SIZE	QTY
9	010009		SS MACHINE SCREW	8-32 x 5/8" (1.6 cm)	4
10	010010		SS LOCK WASHER	#8	5
11	010011		SS HEX NUT	8-32	5
128	200128		REDDI-M CLAMP	3/8" x 1 1/8" (.95 x 3.17 cm)	1
118	010118		SS HEX NUT	5/16" (.8 cm)	8
119	010119		SS LOCK WASHER	5/16" (.8 cm)	8
70	190070		MOUNTING PLATE	4" x 6" (10.2 x 15.2 cm)	1
403	010403		SS U-BOLT	1 5/8" x 3" (4.1 x 7.6 cm)	2
CB			CONNECTOR BRACKET		1
	REDDI MATCH		REDDI MATCH		1
928	200928		REDDI M CLIP	1 1/4" (3.2 cm)	1
107	150107		REDDI M INSULATOR		1
110	200110		REDDI M CLIP	3/8" (.95 cm)	1

#4 - REDDI MATCH ASSEMBLY

Mount the Reddi Match to the driven element #2 as shown in figure E.









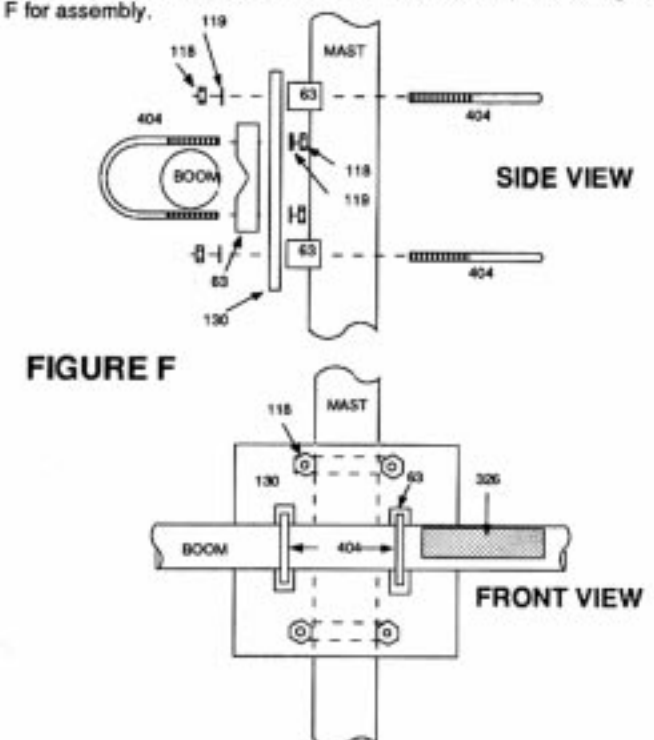

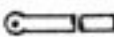
KEY	P/N	DISPLAY	DESC	SIZE	QTY
63	170063		ALUM V-BLOCK	2" (5.1 cm)	4
119	010119		SS LOCK WASHER	5/16" (.8 cm)	8
118	010118		SS HEX NUT	5/16" (.8 cm)	8
130	190130		ALUM PLATE	6 x 6" (15.2 X 15.2 cm)	1
326	290326		DANGER LABEL		1
404	010404		SS U-BOLT	2 1/8 x 3" (5.4 x 7.6 cm)	4

#5 - BOOM TO MAST ASSEMBLY

Assemble and mount the mast bracket to the boom at the balance point. Refer to figure D for the approximate balance point and figure F for assembly.





KEY	P/N	DISPLAY	DESC	SIZE	QTY
BR			ALUM TUBE	3/4" x 48" (1.9 x 121.9 cm)	4
BT			ALUM TUBE	7/8" x 24" (2.2 x 61 cm)	2
63	170063		ALUM V-BLOCK	2" (5.1 cm)	1
118	010118		SS HEX NUT	5/16" (.8 cm)	4
119	010119		SS LOCK WASHER	5/16" (.8 cm)	6
126	200126		BRACE CLAMP	2" (5.1 cm)	2
140	010140		SS HEX BOLT	5/16" x 1 1/2" (.8 x 3.8 cm)	2
404	010404		SS U-BOLT	2 1/8" x 3" (5.4 x 7.6 cm)	1
409	030409		SS WORM CLAMP	7/8" (2.2 cm)	4

#6 - DIAGONAL BRACE ASSEMBLY

Assemble the diagonal braces and install them as shown in figure G. Insert each BR brace section 3" into the slotted tube (BT). Connect the assembled braces to the brace clamps already located on the boom. Locate the brace clamps (126) as shown in figure A. Install the 20-4CD on your support mast as shown in figure F. Tighten the U-bolts taking care not to crush the boom. Slide the brace U-bolt (404) on the support mast above the 20-4CD until the boom is made level. Tighten the brace U-bolt.

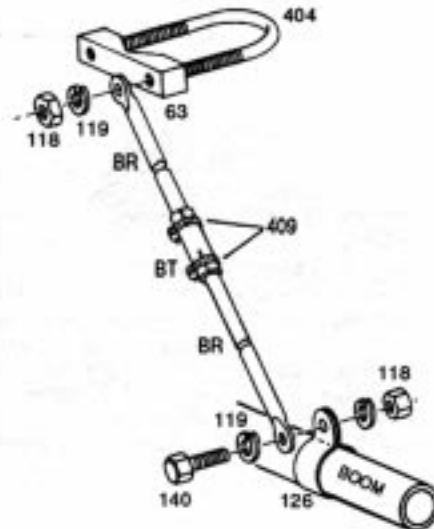
FIGURE G



KEY	P/N	DISPLAY	DESC	SIZE	QTY
115	050115		CONN BOOT		1
116	240116		SILICONE PACKAGE		1

#7 - FEEDLINE ASSEMBLY

Before attaching the feedline permanently, tune the antenna as outlined on page 2. The antenna is designed for use with 50 Ohm coaxial cable terminated with a PL-259 connector. Any length of feedline can be used with your Yagi. The shortest length cable will have the least loss. A connector boot is included for use with your new antenna. See figure G. Slide the boot over the cable before attaching your PL-259. Coat only the outside connector threads and shell with silicone grease. Do not coat the center pin or receptacle. After the PL-259 is firmly screwed on to the antenna connector, slide the vinyl boot over the connector and against the mast bracket.

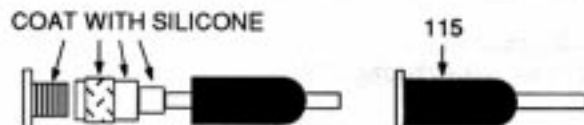

FIGURE H

SPECIFICATIONS

Forward Gain	10.0 dBd
Front to Back Ratio	>30 dBd
SWR Typical	< 1.5 : 1
Boom Length	32 ft. 8 in. (10 m)
Longest Element	36 ft. 1 in. (10.99 m)
Turning Radius	23 ft. 8 in. (7.2 m)
Wind Surface Area	8.1 sq. ft. (.87 sq. m)
Weight	55 lb. (24.9 kg)

LIMITED WARRANTY

Cushcraft Corporation, P.O. Box 4680, Manchester, New Hampshire 03108, warrants to the original consumer purchaser for one year from date of purchase that each Cushcraft antenna is free of defects in material or workmanship. If, in the judgement of Cushcraft, any such antenna is defective, then Cushcraft Corporation will, at its option, repair or replace the antenna at its expense within thirty days of the date the antenna is returned (at purchasers expense) to Cushcraft or one of its authorized representatives. This warranty is in lieu of all other expressed warranties, any implied warranty is limited in duration to one year. Cushcraft Corporation shall not be liable for any incidental or consequential damages which may result from a defect. Some states do not allow limitations on how long an implied warranty lasts or exclusions or limitations of incidental or consequential damages, so the above limitation and exclusion may not apply to you. This warranty gives you specific legal rights, and you may also have other rights which vary from state to state. This warranty does not extend to any products which have been subject to misuse, neglect, accident or improper installation. Any repairs or alterations outside of the Cushcraft factory will nullify this warranty.



48 PERIMETER ROAD, MANCHESTER, NH 03108
603-627-7877 / TELEX 4949472 / FAX 603-627-1764

SPECIFICATIONS SUBJECT TO CHANGE WITHOUT NOTICE