

**MANUAL
MESH DISH KIT
1 / 1.2 / 1.5 & 1.9 Meter**

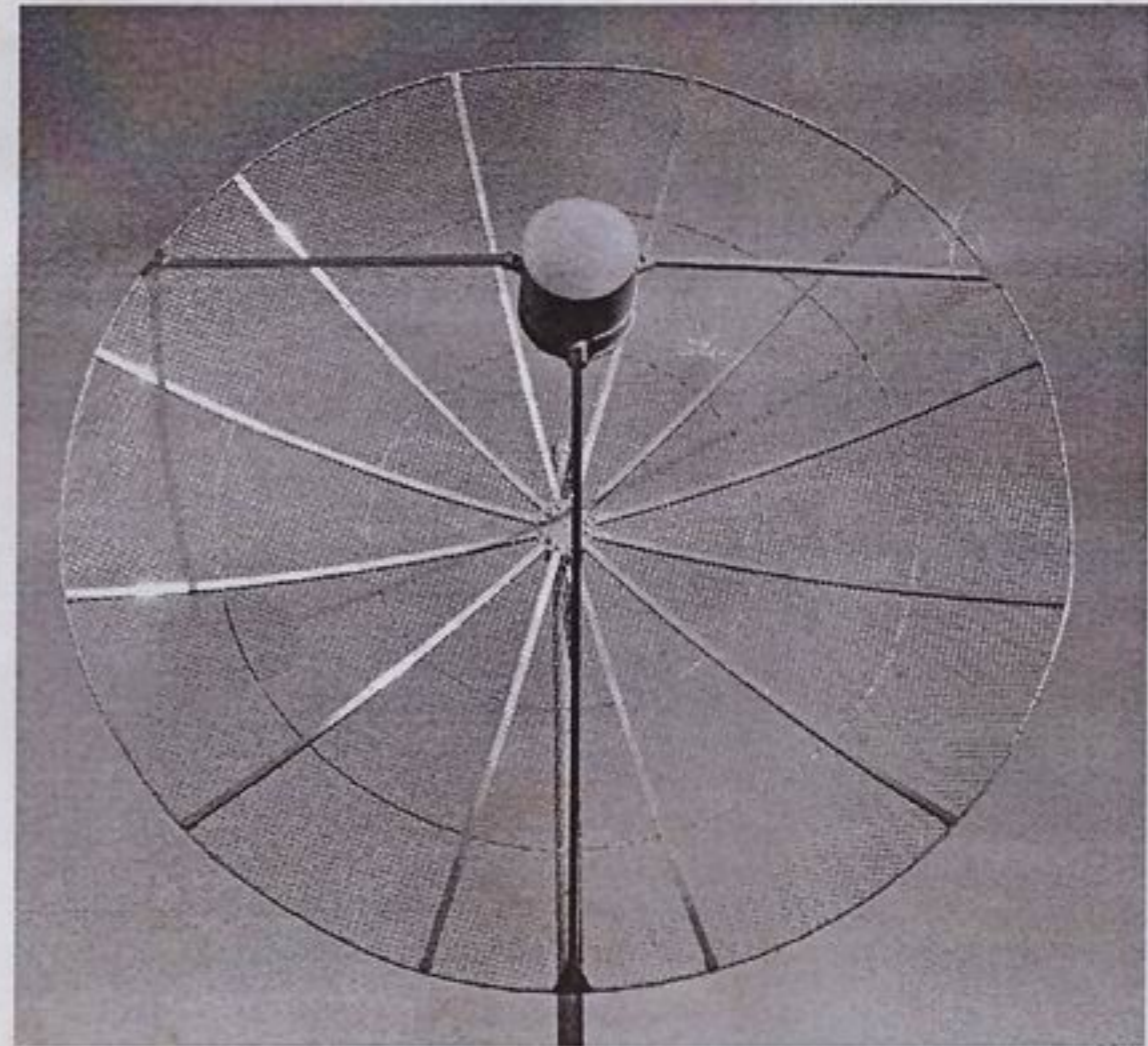

(Example Picture: 1.9 Meter dish and 23cm horn feed)

Dish KIT V3.0

RF HAMDESIGN
www.rfhamdesign.com

Introduction

Thank you for purchasing this MESH DISH KIT.
This kit is an easy to assemble dish with mesh, low weight and wind load.

All the hardware come's with this kit, you will only need some small hand tools, see picture.
A little hand driller, a metal saw, some writing stuff, a small metal hand cutter, a twinge key No. 10 and 13 and a Hand riveter. (note: if text is starting with **, then we are writing about a 1.5 or 1.9m dish)



(1) Placing the rib



It would be help full to use a work mate, but when this isn't available a normal work-bench will also be fine to use.
On the picture's you can see the work-mate is used a lot.

Also on the pictures you will see difference dish sizes, but this isn't any problem, the assembly is always the same.

Start with the Milled alum. Center.
Place the first rib in it and place the top alum cover over it. (see picture)
Place the second rib and continue.



**When assembly a 1.5 or 1.9 meter dish:
(On the picture is a 1.9 meter dish) at the 1.5 and 1.9 meter dish there will be an extra hoop (1.5Meter 1pcs and 1.9Meter 2pcs)

This extra hoop takes some attention !
Start to place the first rib with one end of the extra hoop(s) already in it in the milled center. Now take the second rib, but... first put in the extra hoop in the rib, after this into the milled alum. Center. After this the third rib, and so on.



When the ^{CERCHIO} hoop ends, you will need a coupler.

This coupler is an tube which can be slide over the hoop. A 1.5m dish needs 2 and a 1.9m dish 3 pcs. (pay attention at 1.9meter dish, the inner hoops must not cut to long, you will need complete 3 pcs of length for the 2 inner hoops.)



As you already have seen, the rib's are mounted with M6 x 35 bolts + ring and 4 pcs. M8 thread + ring.

So when placing the rib's take a look at the hole size at the begining of it, some has 7mm and some has 9mm, the 7mm holes are used for the M6 bolts and the 9mm hole for M8 thread. (some rib's do have a mark, this is the 9mm hole)



Don't forget at last, fix all parts.
This is necessary, because else the hoop will not fit.
(Picture left)



(2) READY TO MOUNT THE OUTSIDE HOOP.

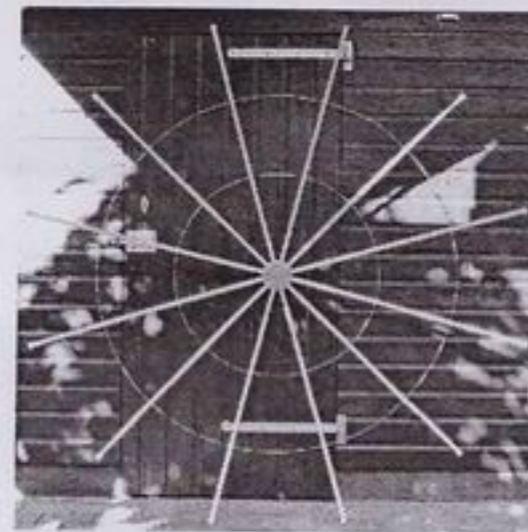

When all is ok, the dish must be like this one on the picture on the left. (1.9 meter dish)

If so, You are now ready to place the outside hoop.

Place the dish back on the bench or worke-mate and watch the next pictures.

Take the 3mm strip hoop, use the hand driller to drill the first 4,1mm hole (4,1mm bore is incl. This kit) This hole is about 10...20cm away from the end. This end is used later to connect the hoop to each other.



Take the 3mm strip and mark it with a marker. Make a line on the strip wich say's this is the middle and.....



Make a 4,1mm hole in the strip, After this.....



Use the Hand riveter to secure the hoop strip at the rib. The first thing is done, after this take the second and go so on until all rib's are done.



Now you are ready to connect the 3mm strip to each other. **

Overlay the strip, as on the picture, secure it and make 3 holes with the 4,1mm bore. Use the 4x12mm pop rivets here to connect the strip.

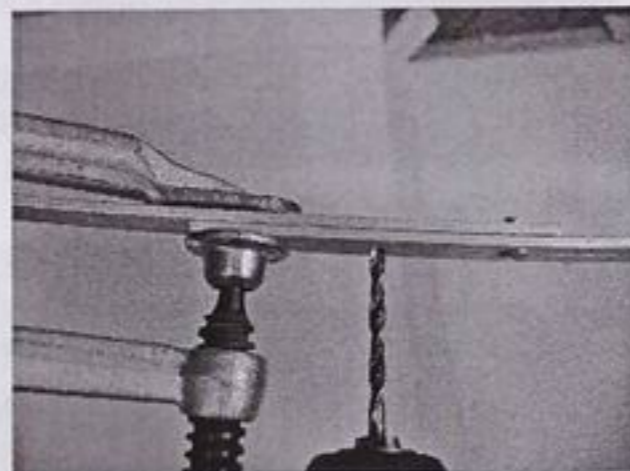

**1,9meter dish, In the kit is an extra lenght of 3mm strip wich can be used for this connection.

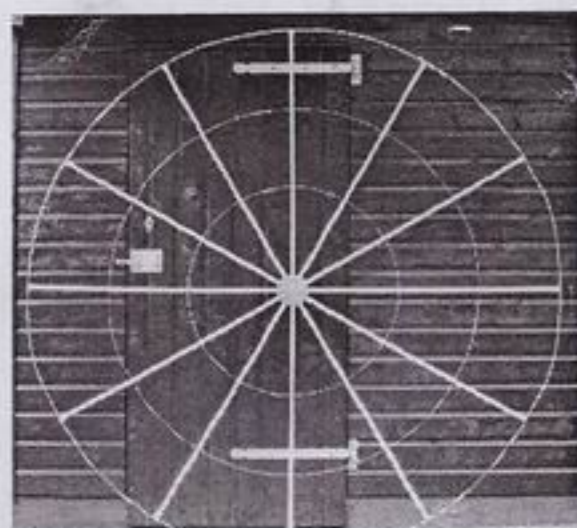

When all is done, the mesh dish should be as this one on the picture left.

(3) Place MESH

Now you are ready to place the mesh. The mesh will be placed in 4 parts. Cut the mesh in 4 right measures (1meter DISH 2 pieces). (see table down below). Place the first piece mesh on a quater piece of the dish, see picture at the right. The mesh must overlay a bit.

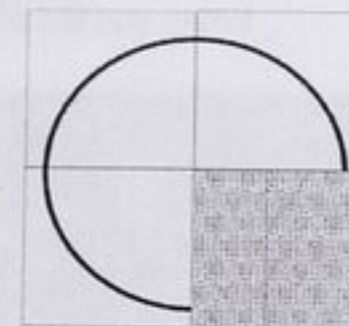

Attention: Cut the piece mesh for use at the 1Meter Dish in 2 pieces, the left over after placing the first part on the dish, is enough to place on the second part. (Find out by turning the piece how it fits)

6 and 3cm dishes:

Mesh dishes ordered for use at frequency >6GHz are supplied with 2.8mm square mesh.



Than take a strip and place it over the mesh, take one of the holes wich are allready on the strip, use a hand-driller, drill a 4.1mm hole into the rib and place a rivet. The first



one is always the hardest one to place, be shure the mesh is on the right place when you place the first rivet. Now place the rest of the rivets. (to place the first strip, take a rib wich is not at the end of the mesh)

Place the other strip, but when you are at the beginning or at the end of the mesh piece, it's now necessary to take the second piece mesh.

Take a other strip and fix both ends of the mesh now, see picture on the right. Be shure the second piece mesh is on the right place. The mesh must also overlay a little bit.

Before placing the second piece mesh, cut the first piece nice and gently, it can be cut near one of the rib's. see picture.



When you did placed some strip and mesh, cut the rest of the mesh in the center, see picture's below.

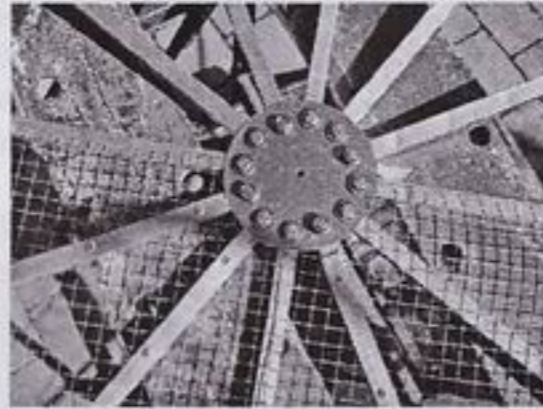
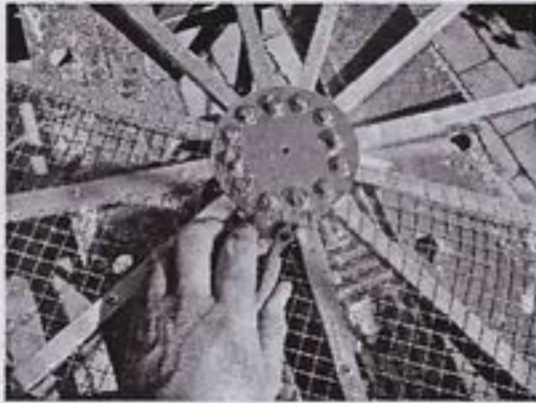

When you placed all of the strips and mesh, it's time now to cut the rest of the mesh which is hanging over the hoop. Use a small metall hand cutter. See picture on the right.



Bend the mesh down over the end of the hoop, take care of your hands, it's useful to use some gloves.

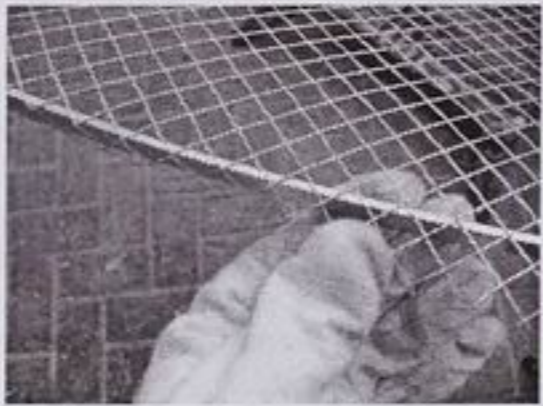

Supplied are cable ties which are used to secure the mesh around the hoop. It's not necessary to place the cable ties close to each other, distance of 5...8 cm will be fine.
The cable ties are also used to secure the mesh to the inner hoop, place the at 10-12 cm distance from each other.
(delivered cable ties are UV-resistance)



(4) Place the 3 leg feed support plate and DISH FEED.

Now pick up the 3 leg dish feed support plate. Drill 3 pieces of 4.1mm holes, rivet the plate. See picture at the left. (use 4x12mm rivets)
Place 1 of the dish feed support plate opposite 1 of the rib's (it's nice to place a plate at the down site of the dish, wich can cary the coax cable down the rib) To calculate the triangle of the 3 leg feed support use the formula: $\sqrt{3}$.radius of the dish.
(example: dish 1meter= $\sqrt{3} \times 0.50m = 1.73 \times 0.5 = 0.87m$)



Note: the dish feed support plate wich is in opposite of 1 of the ribs (1 and 1.2m dish) must be drilled again, this means, the rivet wich is allready in place must be removed and the new rivet must be placed incl. the plate.

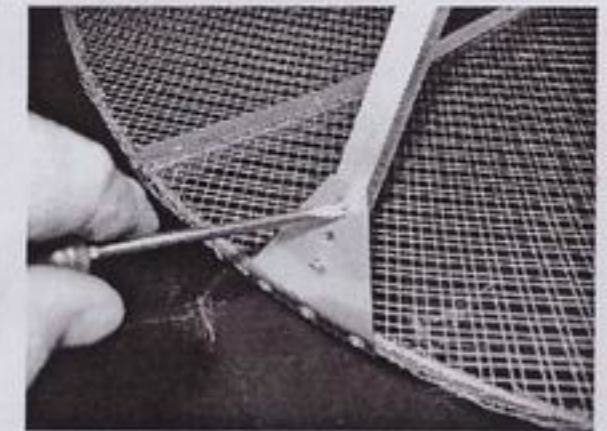

** When using a 1.5 or 1.9 meter dish, the firts plate can be mount where you want, but it's nice to mount it at the under site of the hoop, so the coax cable can run also via a rib.
(Last 2 Pictures on the right: DISH with double MESH)

To secure the 3 leg feed support, use the alum. Square tube 15x15mm.
This tube support is secured with 3x M4x20mm bolts each. Refer picture right. (Picture right is a 1meter size dish)



When you did mount the feed support, it may look at this on the right.

You are now ready to mount the dish feed, if it's ordered including this dish.

Be shure you made your choise for polarization when using a linear dish feed (H or V pol)

The feed support plate is drilled for Horizontal polarization.

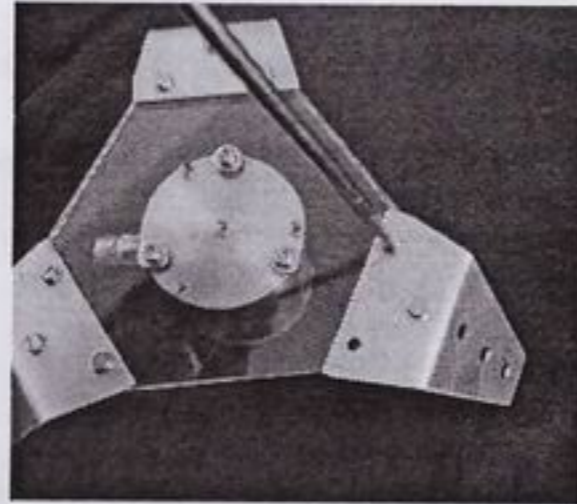

Mount the (delivered) dish feed as on the picture.

If you had orderd also a LPD dish feed 9cm or 6cm dish feed, place it at this way.

Place the dish feed including the feed support at the 3 leg alum. support. See picture.



When you did orderd a dish feed for 23 or 13cm, mount it as on this picture left. (all harware is ind the dish kit when orderd)

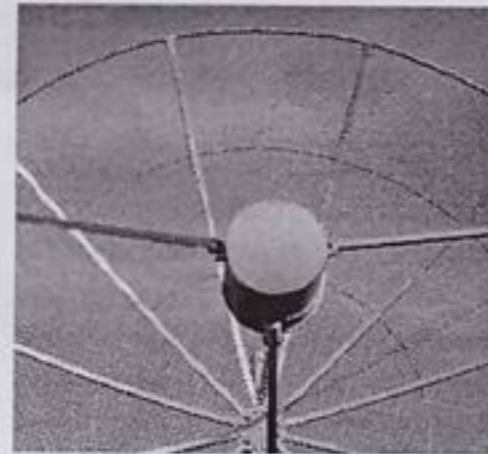

On the right a dose-up picture of the connection to the alum. square tube and Delring mounting support.

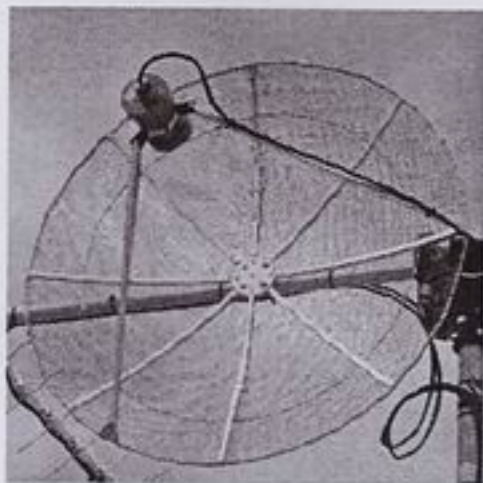

On the left a mounted helix feed at a 1.2Meter dish

(5) Last things....

When everything is done, the dish should be like this picture's.

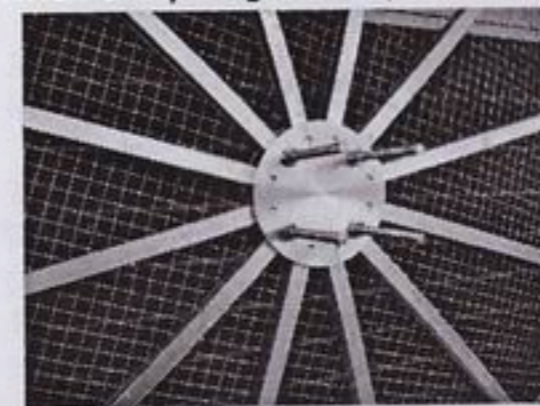

12-Rib dish, without the mast clamp

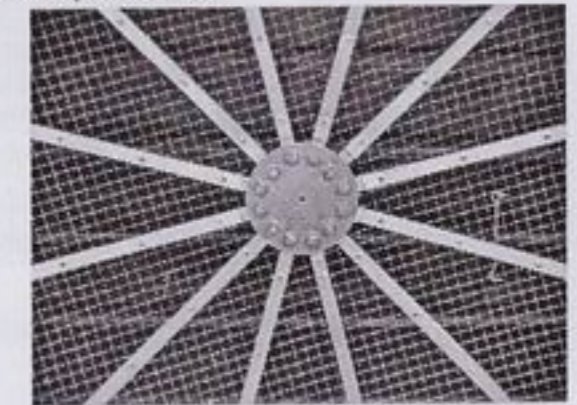

12-Rib dish center, ready

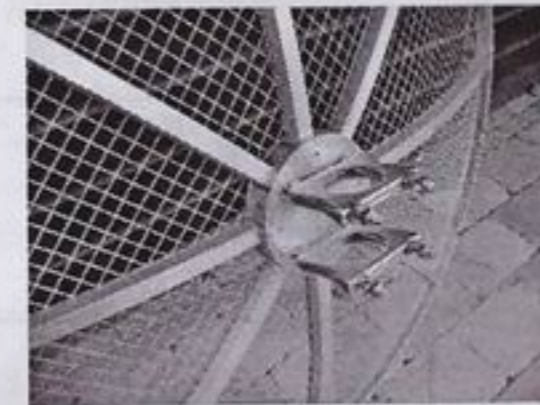

8-Rib dish, including mast clamp

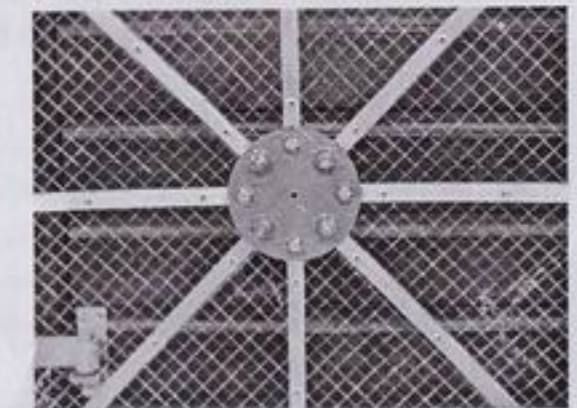

8-Rib dish center, ready.

MESH Dimensions:

DISH SIZE	MESH LENGTH
1 meter	2 x 0.65 meter (1pc of 0.65 meter is used for 1/2 dish: place part of 0.65 meter at the first 1/4 part of the dish, cut around, and unused piece is used for the other 1/4 piece, do the same with the second part 0.65 meter)
1.2 meter	4 x 0.68 meter
1.5 meter	4 x 0.84 meter
1.9 meter	4 x 1.01 meter

FOCAL LENGTH:

(Focal length: the distance from the center of the dish to the front of the feed or when used a L.P.D. feed, use the center of the feed)

DISH SIZE	F/D=0.35	F/D=0.40	F/D=0.45	F/D=0.50
1 meter	35 cm	40 cm	45 cm	50 cm
1.2 meter	42 cm	48 cm	54 cm	60 cm
1.5 meter	52.5 cm	60 cm	67.5 cm	75 cm
1.9 meter	66.5 cm	76 cm	85.5 cm	95 cm

DISH SURFACE AREA:

DISH SIZE	Surface Area
1 meter	0.78 M ²
1.2 meter	1.13 M ²
1.5 meter	1.78 M ²
1.9 meter	2.84 M ²

↑

F/D = 0.45

Need more info?

Website: www.rfhamdesign.com
 E-Mail: info@rfhamdesign.com
 Tel: + 31 650 882 889
 FAX: + 31 847 187 776

DISH FEED SUPPORT Square-tube DIMENSIONS.

In connection with lots of dish feeds which are available we add a standard length 3-leg dish feed support to the dish kit.

The length of the 3-leg dish feed support must be cut, because you have to mount the dish feed exactly at the right distance from the center of the dish, (dimensions at page 10)

1 end the 3-leg support is not drilled, you can change the length of the 3-leg feed supports by your self and drill the holes.

All dimensions in mm.

Hole to drill is 4,1mm, center the hole's at 7.5mm in the 15mm square tube.

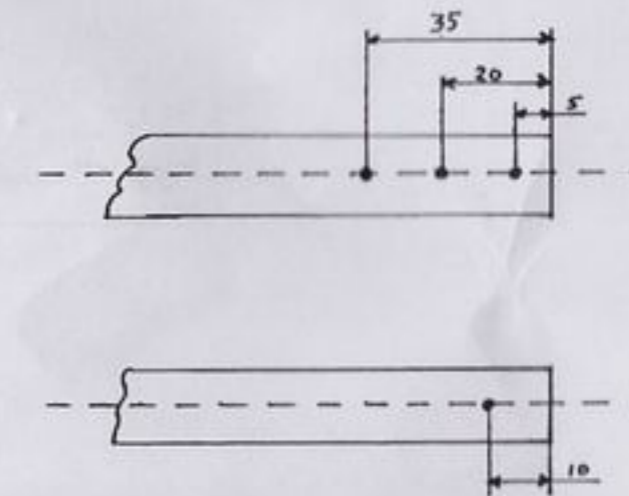

Support detail. dimensions: mm

The upper drawing is at the end of the dish feed when using a plate bracket
 The second drawing is used when you mount a horn clamp for 23 or 13cm.
 (Take some attention with the second drawing, the tube must be turned)

ADD ON INFO MESH DISH TEXT:

#1. When reading: "double mesh" we do mean 2.8mm square mesh.

#2. All delivered 1.0 and 1.2 meter mesh dishes supplied with 6mm square mesh, do have a extra hoop.