DSP-599zx

Audio Noise Reduction Filter

Operating Manual

March 6, 1997



Congratulations

You have purchased the most advanced digital signal processor available. Please complete and return the enclosed Warranty Registration Card. Timewave Technology Inc. occasionally offers performance enhancing updates to its products. By returning the completed Registration Card, we will notify you about these updates. For current information and hints and tips about our products check out our World Wide Web site.

If you are in a hurry to use your new equipment, turn to the Quick Start section. It provides enough information to get your new equipment up and running. You still will want to read through the rest of this manual. It provides valuable operation tips and information that will allow you to use the features to full measure.

Serial Number

You will need your serial number when communicating with Timewave Technology, Inc. The number is on the bottom of the DSP-599zx. It is also stored within the unit and is displayed when you power up your unit. Record your serial number on your registration form and here for future reference.

DSP-599zx Serial Number: _____

Copyright

(1994, 1995, 1996, 1997, 2002 by Timewave Technology Inc. All rights reserved.
Printed in USA

Under the copyright laws, this manual can't be reproduced in any form without prior written permission from Timewave Technology Inc.

Timewave Technology Inc. strives to deliver the best product to our customers. As part of this goal, we are constantly trying to improve our products. Timewave Technology Inc., therefore, reserves the right to make changes to product specifications or documentation without prior notice.

This manual may contain errors, omissions or "typos." Please send your comments, suggestions and corrections:

Timewave Technology Inc.
501 W. Lawson Ave.
St. Paul, MN 55117 U.S.A.

sales@timewave.com E-mail

<http://www.timewave.com> FAQ and General and Update Information

(651)489-5080 Voice

(651)489-5066 Fax

Quick Start

“I don’t want to read the whole manual just to turn it on.”

You have purchased the most advanced digital signal processor available. Please complete and return the enclosed Warranty Registration Card. Time-wave Technology Inc. occasionally offers performance enhancing updates to its products. By returning the completed Registration Card, we will notify you about these updates. For current information and hints and tips about our products check out our World Wide Web site.

If you are in a hurry to use your new equipment, read this Quick Start section. It provides enough information to get your new equipment up and running. You still will want to read through the rest of this manual. It provides valuable operation tips and information that will allow you to use the features to full measure.

What is packed with your DSP-599zx

- DSP-599zx
- Operator Manual (what you are now reading)
- Warranty Registration Card
- 5.5 x 2.1 mm power connector

What is not packed with your DSP-599zx that you will need

- 12-16 Volt dc power supply capable of providing a minimum of 1 ampere. Most commercial power supplies produce 13.8 Vdc and are rated as 12 Vdc. Please see page 2-2 for more information.
- Two-conductor cable to connect between power supply and DSP-599zx
- Cables to connect DSP-599zx with your transceiver speaker output, PTT output, external speaker and multimode controller. All of these cables will need a RCA type connector on the end that attaches to the DSP-599zx. The other connector will vary with the equipment on the other end. Consult your owner’s manuals.
- External speaker and/or headphones. You will need at least one of these devices to connect to the DSP-599zx to hear the audio signal. The DSP-599zx will accept either stereo or mono headphones with a 1/4” plug. **Stereo headphones are the preferred choice because of the dual output channels.** External speakers are connected to the unit with RCA phono plugs. You may need an adapter to convert an existing speaker to this type of connector.
- In some data modes you will need a cable from the 8-pin DIN connector to your transceiver. You may also need a 9-pin serial cable to connect to your computer.

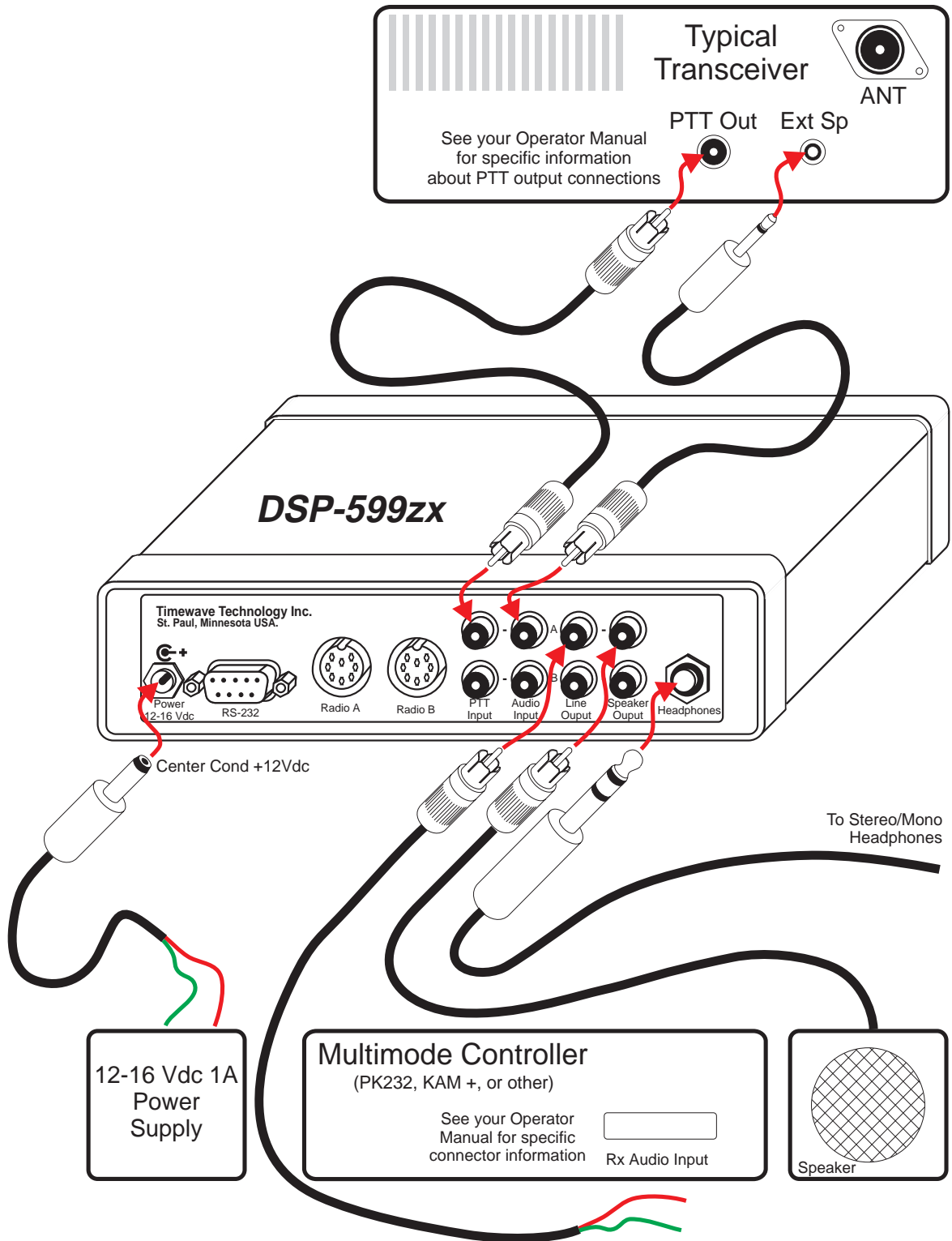

599-010

Consult the installation section of this manual for more information on cables and connections.

Quick Start Setup

Here is the absolute minimum information you need to get started. After you satisfy your urge to hook it up and turn it on please read the entire manual. There are two reasons for the request. First; you will learn how to maximize the effectiveness of this fine product. Second; you paid for this manual so you might want to get your money's worth.

1. **Before** connecting the DSP-599zx, tune in a signal on your receiver and adjust it for your normal listening level.
2. Connect the speaker output of your radio to Channel A audio input of the DSP-599zx. Use a RCA phono connector on the DSP-599zx end of the cable.
3. Connect the Channel A audio output to your 4 or 8 ohm loudspeaker. Use a RCA phono connector on the DSP-599zx end of the cable.
4. Connect a 12-16 Vdc 1 Ampere power supply to the DSP-599zx. Use a 5.5 x 2.1 mm power connector on DSP-599zx end of the 12-16 Vdc power cable. **The center pin must be positive (+).** (There is a 5.5 x 2.1 mm connector packed with the DSP-599zx manual.)
5. Turn on the DSP-599zx power (volume control, right side of front panel).
6. Adjust the radio volume control until the yellow LED on the right side of the DSP-599zx panel flashes but the red LED flashes rarely.
7. Adjust the DSP-599zx volume control for comfortable listening.
8. Select the Voice, CW or Data mode on the DSP-599zx by pressing the Mode switch on the upper left front panel to light the corresponding LED above the display.
9. Try pressing the random noise reduction and tone notch switches, and adjusting filter tuning knobs to operate the various filter features of the DSP-599zx.
10. You can select many more features by using the rest of the switches and the display menus.

For best results, read the manual now!

Voice Mode

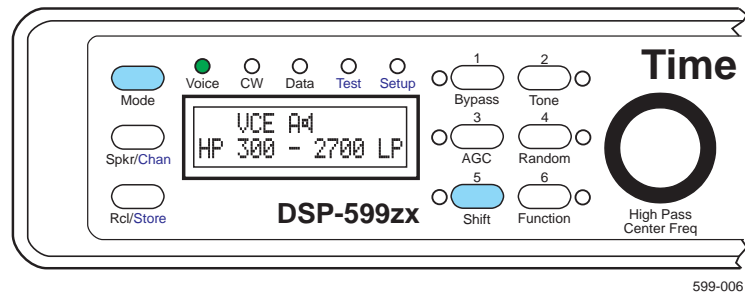

Typical display for Voice mode, 300 Hz to 2700 Hz filter, A channel active and speaker on.

CW Mode

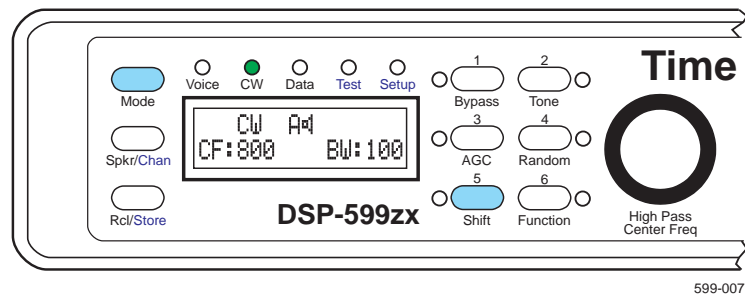

Typical display for CW mode, Center Frequency at 800 Hz and Bandwidth set to 100 Hz filter, A channel active and speaker on.

Data Mode

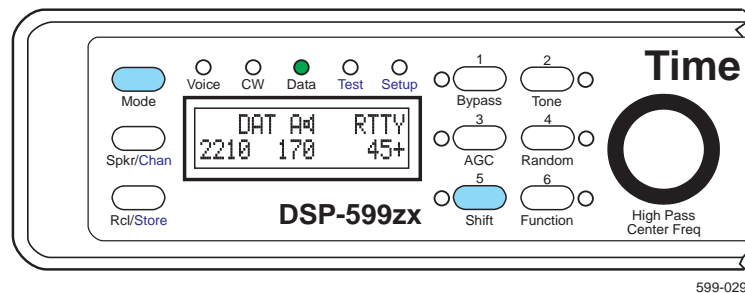

Typical display for RTTY Data mode. Center frequency at 2210 Hz, offset at 170 Hz and baud rate of 45. A channel is active and speaker on. Bandwidth has been adjusted wider than normal.

Table of Contents

“I don’t want to read the whole manual just to turn it on.”	iii
What is packed with your DSP-599zx	iii
What is not packed with your DSP-599zx that you will need	iii
Quick Start Setup	v
Voice Mode	vi
CW Mode	vi
Data Mode	vi
Introduction	1-1
Digital Signal Processing	1-1
DSP-599zx Overview	1-1
Signal Flow	1-2
Front Panel Controls	1-3
Back Panel Connectors	1-4
Features Common to All Modes	1-5
Random/Tone Noise Reduction	1-5
Adaptive Multi-tone and Manual Notch Filtering (Tone noise reduction)	1-5
Dual Channel Operation	1-5
Visible Memories	1-6
Automatic Gain Control	1-6
Bypass Control	1-7
Operating Modes	1-7
Voice Mode	1-8
Highpass/Lowpass Filters	1-8
Random Noise Reduction	1-8
Adaptive Multi-tone and Manual Notch Filtering (Tone noise reduction)	1-9
CW Mode	1-9
Bandpass Filters	1-9
Random Noise Reduction	1-10
Manual Notch Filtering	1-10
Marker Tone	1-10
CW Tone Pitch Shift	1-10
Data Mode	1-11
Bandpass Filters	1-11
Data Tuning Function	1-12
Random Noise Reduction	1-12
RTTY Modem	1-12
RTTY Remodulator	1-12
RTTY FSK Test Signals	1-13
Test Instrument Mode	1-13
Audio Millivoltmeter	1-13
Audio Signal Generator	1-14
Two-Tone Generator	1-14
CTCSS Tone Decoder	1-14
Set-up Mode	1-15

Installation	2-1
Power Supply	2-2
Connecting Cables	2-2
Wiring information	2-2
DSP-599zx Inputs and Outputs	2-2
Transceiver Speaker Output	2-3
External Speaker	2-3
Multimode Data Converter and Terminal Units (TU)	2-3
Transceiver PTT and T-R Outputs	2-3
Audio Input	2-4
Input Impedance Setup	2-4
Input Impedance Jumper Access	2-4
Audio Input Signal Level Setup	2-5
Audio Output	2-5
Headphone Jack	2-5
Headphone Volume Jumper Access	2-6
Speaker Outputs	2-7
Line Outputs	2-7
Input/Output Options	2-7
Speaker/Headphone	2-7
Line Output	2-8
PTT Input	2-9
RTTY Modem Input/Output	2-10
DIN Jacks - Radio A and Radio B	2-10
RS-232 Connector	2-10
Setup - Install	2-11
Audio Input Signal Level Setup	2-11
Line Out Signal Level Setup	2-12
Speaker/Headphone Routing	2-13
Alternate Channel Gain	2-14
Line Out Routing	2-15
Reset Memory	2-16
Exit Setup	2-16
General Operation	3-1
Introduction	3-1
Front Panel Operation	3-1
Controls Common to All Modes and Features	3-2
Primary Operating Modes [Mode]	3-2
Secondary Operating Modes and Features [Shift]	3-2
Speaker Control [Spkr/Chan]	3-2
Channel Control [Spkr/Chan]	3-3
Memory Operation [Rcl/Store]	3-3
User Selectable Power Up Mode	3-5
Bypass [Bypass]	3-5
Automatic Gain Control [AGC]	3-5
Noise Reduction	3-6
Power Switch/Gain Adjust Control	3-6

Voice Mode	4-1
Operation	4-1
High Pass/Low Pass Filters	4-1
Noise Reduction	4-2
AM Line Noise	4-3
Heterodyne Elimination/Notch Filters	4-4
Automatic Notch Filter	4-4
Manual Notch Filter	4-5
Voice Bypass	4-6
Setup - Voice	4-6
AM Line Noise	4-7
Exit Setup	4-7
CW Mode	5-1
Operation	5-1
Bandpass Filters	5-1
Noise Reduction	5-2
Manual Notch Filter	5-2
CW Marker Tone	5-3
CW Tone Pitch Shift	5-3
CW Bypass Mode	5-4
Setup - CW	5-5
Marker Tone Level	5-5
Exit Setup	5-5
Data Mode	6-1
Introduction	6-1
Operations Common To All Data Types	6-1
Basic Data Mode Operation	6-1
Data Settings Display	6-2
Data Tuning Function	6-2
Random Noise Reduction	6-3
Data Bypass Mode	6-3
Data Filter Mode	6-4
RTTY, AMTOR, SITOR, PacTOR, G-TOR	6-4
HF Packet	6-5
CLOVER	6-5
SSTV and WeFAX	6-5
RTTY FSK Test Signals	6-5
RTTY Modem Operation	6-6
RTTY Remodulator Operation	6-7
Data Operating Hints	6-8
Data Primer	6-8
Frequency shift	6-8
Center Frequency	6-8
Baud Rate	6-9
QRM Operating Hint	6-9
Mark Space Frequencies	6-9
Setup - Data Mode	6-10
Speaker Mute/Bypass	6-10
Modem Assignment	6-11
FSK Mark Control	6-11

Configuring Data Operating Modes	6-12
Exit Setup	6-14
Test Instrument Operation	7-1
Audio Millivoltmeter	7-1
Operation	7-2
Sine Wave Generator	7-3
Two-Tone Generator	7-4
CTCSS Decoder	7-5
Autodetect	7-5
Autodetect Display with Input CTCSS Tone.....	7-6
Tone Squelch	7-6
CTCSS Tone Squelch Selection	7-6
CTCSS Tone Squelch Detection	7-6
CTCSS Tone Squelch	7-7
CTCSS Tone Squelch Switch Output Jack and Pin Numbers	7-7
What are CTCSS tones?	7-7
CTCSS Tone Frequencies - Hz	7-8
Setup - Test Instrument	7-8
Default CTCSS Tone	7-9
CTCSS Trigger Threshold	7-9
Signal Generator Calibration	7-10
Millivoltmeter Calibration	7-11
Exit Setup.....	7-12
Troubleshooting	8-1
Common Problems and Solutions.	8-1
Nothing comes on when I turn on the power.	8-1
"Normal" LED does not flash on audio peaks.	8-2
"Overload" LED flashes constantly on audio peaks.	8-2
No audio output	8-2
It still does not work!	8-3
Specifications	A-1
Glossary	A-3
Product Warranty	A-5
Exclusive Remedies:	A-5
Electromagnetic Interference	A-7
Schematic Diagrams	A-9

1

Introduction

This section includes a short summary of both the front panel controls and the rear panel connectors. It also provides an overview of the features found in the DSP-599zx. Please see *Appendix A—Specifications* for detailed information on the capabilities of the DSP-599zx.

Please turn to *Section 2—Installation* for detailed installation and Setup of your new unit. If you are in a hurry to start using the DSP-599zx, turn to section two after you have read the first four pages of this section. Return to this section to review all the features and capabilities.

Digital Signal Processing

Digital Signal Processing (DSP) is a powerful and complex method of analyzing and modifying analog signals. Audio signals like speech or radio data are analog signals. The speech and data signals have fairly well known and predictable characteristics; however, these characteristics are quite complex. By converting the analog signal to a digital signal, a powerful digital signal processor with a special program can analyze the characteristics of the analog signal. The digital signal processor can then modify the digital signal to enhance desired characteristics and to remove undesirable characteristics such as noise. The processed signal is converted back to an analog signal and sent on to a speaker, headphone, or data controller. The result is a signal with less noise and/or fewer data errors. In amateur radio terms, DSP is capable of reducing or eliminating QRN (noise) and QRM (interference).

For a more detailed discussion of digital signal processing, consult the most recent *ARRL Handbook*.

DSP-599zx Overview

The DSP-599zx is an extraordinarily versatile digital signal processor designed for amateur and shortwave radio voice, data, and CW operation. The DSP-599zx uses advanced digital signal processing technology to implement algorithms that perform five basic audio functions:

- Random noise reduction
- Adaptive multi-tone and manual notch filtering (Tone noise reduction)
- Bandpass/Highpass/Lowpass filtering
- Signal generation including RTTY modulation
- Signal detection and measurement including RTTY demodulation

The DSP-599zx combines these five basic functions to reduce noise and interference and improve radio communication. The DSP-599zx hardware and software architecture allow easy field upgrade with new features and algorithms. The same hardware and software architecture also allow ergonomic

mode oriented operation of the DSP-599zx. The LCD alphanumeric display provides a clear view of operating settings when switching between operating modes. The quick-select push buttons and optical encoders for filter tuning allow instant mode change with total recall of last setting and memories. Front-panel selectable and adjustable inputs allow you to quickly setup and adjust your DSP-599zx to wipe out noise and QRM like never before!

Here are a few more highlights among the many other operating features of the DSP-599zx:

- Selectable Automatic Gain Control
- Configurable bypass control
- Two selectable input channels
- Two configurable output channels
- Six memories for instant recall of user-defined configurations
- Test instrument mode for analyzing signals and other equipment

Signal Flow

The DSP-599zx converts analog signals into digital signals before it routes and processes them. The digital signal processor also controls the front panel switches, encoders, LEDs, LCD display, and back panel inputs and outputs. This figure is a greatly simplified block diagram of the DSP-599zx.

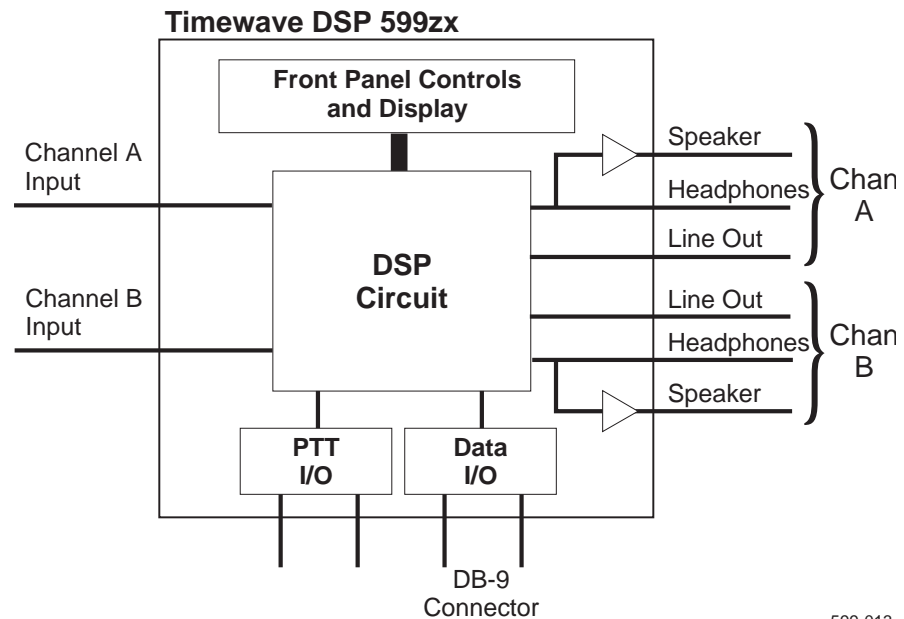

599-013

Front Panel Controls

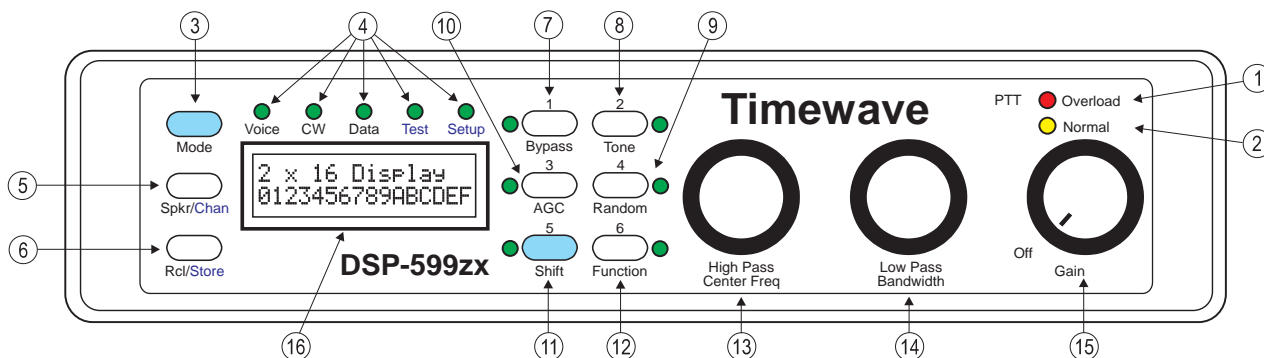

599-002

1. PTT/Overload LED

Red LED indicates a too high signal level into DSP-599zx from receiver. When PTT line from transceiver is connected, red LED on indicates PTT is activated.

2. Normal

Yellow LED indicates normal signal level into DSP-599zx.

3. Mode switch

Press to change mode (Voice, CW, Data). Press **[Shift+Mode]** to switch to Setup and Test modes.

4. Voice, CW, Data, Test, and Setup LEDs.

Indicate the selected mode of the DSP-599zx.

5. Spkr/Chan switch

Press **[Shift]** to toggle speaker on and off. Press **[Shift+ Spkr/Chan]** to switch from Channel A input to Channel B input.

6. Rcl/Store switch

To recall memory, press this key and then one of the switches labeled 1 to 6. To store current settings in a memory, press **[Shift+Rcl/Store]**, then one of the switches labeled 1 to 6.

7. Bypass Switch

Press to Bypass DSP filtering.

8. Tone Switch

Heterodyne elimination for Voice. Marker Tone for CW and Data. Press **[Shift+ Tone]** to adjust the aggressiveness of the tone notch filter or to activate manually tuned notch filter.

9. Random switch

Used to turn on random noise reduction. Press **[Shift+Random]** to adjust aggressiveness of the noise reduction.

10. AGC switch

AGC on.

11. Shift switch

This blue switch shifts the function of the next switch pressed to its function labeled in blue.

12. Function switch

This switch is used alone or in combination with the shift key to access specialized functions.

13. High Pass/Center Freq Control

Tunes the high pass filter in the Voice mode. Tunes the bandpass filter center frequency in CW and Data mode. In most menu modes, this knob is rotated to see menu choices. Pressing the knob selects the choice.

14. Low Pass/Bandwidth Control

Tunes the low pass filter in the Voice mode. Tunes the bandpass filter bandwidth for CW and Data mode. Pressing knob will turn off temporary settings.

15. Gain/Power On/Off

Turns power on and off, and volume control for speaker output.

16. LCD Display

Backlit 2x16 alphanumeric display of mode, control, and test settings and data.

Back Panel Connectors

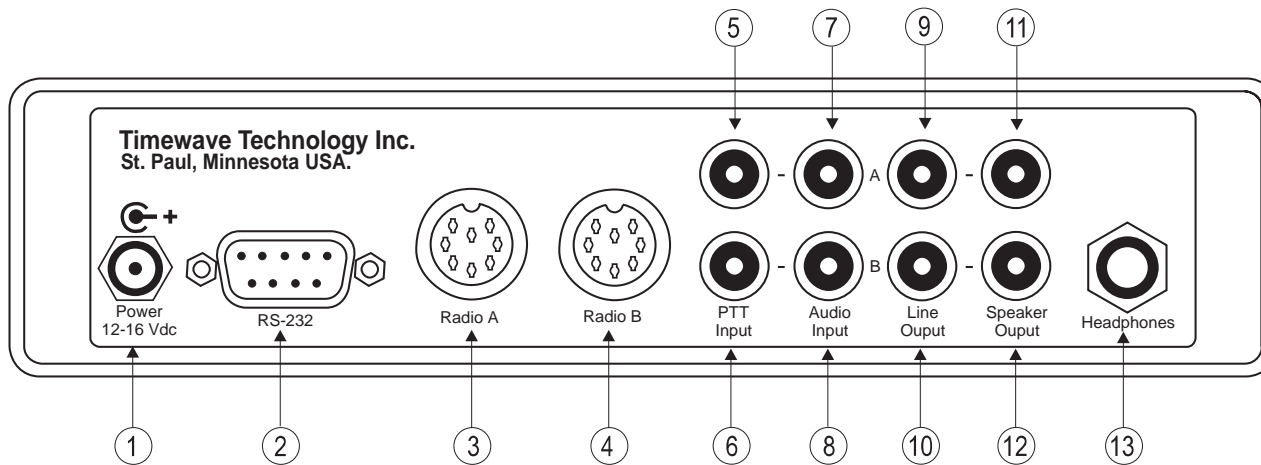

599-005

1. Power In

12-16 Volts DC Use 5.5 mm/2.1 mm matching plug, center positive.

2. RS-232

RS-232 compatible RTTY modem serial output for computer interface. DB-9F connector. Refer to chapter 2 for pin configuration.

3. Radio A

Alternative single 8 pin DIN connection for line out, audio in, PTT out, PTT in, aux. digital in. Also contains connections reserved for future options. Refer to Chapter 2 for pin configuration.

4. Radio B

Alternative single 8 pin DIN connection for line out, audio in, PTT out, PTT in, aux. digital in. Also contains connections reserved for future options.

5. PTT Input A

PTT line from transceiver A PTT output. RCA Phono connector.

6. PTT Input B

PTT line from transceiver B PTT output. RCA Phono connector.

7. Audio Input A

Audio input from radio speaker output - channel A. RCA Phono connector.

8. Audio Input B

Audio input from radio speaker output - channel B. RCA Phono connector.

9. Line Output A

Line level output to multimode data controller - channel A. Gain control doesn't vary this output. RCA Phono connector.

10. Line Output B

Line level output to multimode data controller - channel B. Gain control doesn't vary this output. RCA Phono connector.

11. Speaker Output A

4-8 ohm speaker output - channel A. RCA Phono connector.

12. Speaker Output B

4-8 ohm speaker output - channel B. RCA Phono connector.

13. Headphone Jack

Stereo headphone jack for 1/4" stereo plug.

Features Common to All Modes

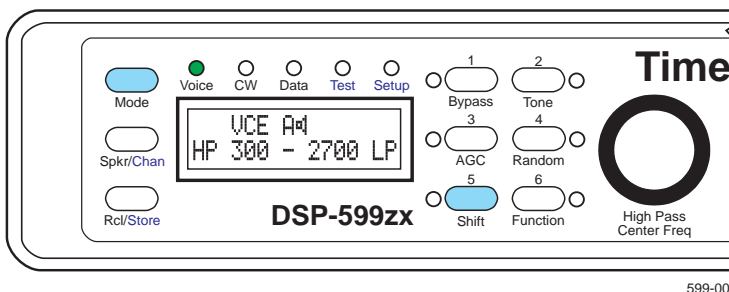

Random/Tone Noise Reduction

The noise reduction functions of the DSP-599zx operate by examining a characteristic of signals and noise called *correlation*, and dynamically filtering out the undesired signals and noise. The degree of correlation is relative. Random noise such as white noise or static is uncorrelated. Speech is moderately correlated. Repetitive or continuous noise such as a heterodyne is highly correlated. The DSP-599zx measures correlation and filters out signals and noise that are outside its correlation thresholds. The amount of noise reduction varies according to the correlation characteristics of the noise. Typical noise reduction ranges from 5 dB to 20 dB for random noise and up to 50 dB for heterodynes.

Adaptive Multi-tone and Manual Notch Filtering (Tone noise reduction)

The DSP-599zx has both an automatic notch filter and a manually tuned filter. The automatic notch filter is an adaptive multi-tone filter that can remove multiple tones simultaneously. The automatic multi-tone filter removes multiple heterodynes almost completely.

The **[Center Freq]** encoder on the front panel tunes the manual notch filter. The manual notch filter is selectable and has a dual notch filter for data signals and a single notch filter for CW signals and heterodynes.

Dual Channel Operation

The DSP-599zx is a dual channel device with two sets of inputs and outputs. The DSP circuit completely processes the selected channel, while signals on the other channel pass through the DSP circuit without processing. Settings for each channel are retained when switching between channels.

The two input channels allow you to connect either two separate radios or a dual channel radio with two outputs to the DSP-599zx. You may configure each channel to completely different operating modes. Selecting the opposite channel returns the DSP-599zx to the previous settings on that channel. This is very handy for two rig operations when setting one rig to monitor CW and the other to monitor voice.

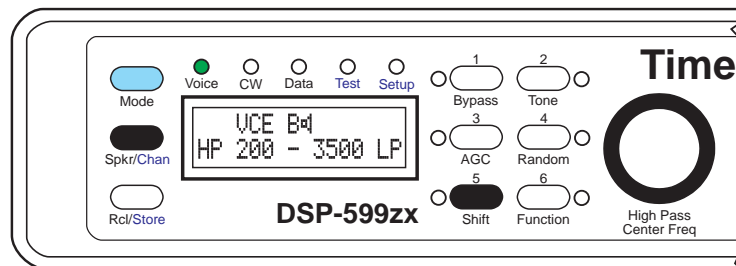

599-032

Pressing [**Shift+Chan**] toggles between channels A and B. The DSP-599zx audio gain control simultaneously controls volume level of both channels. **Setup** mode allows adjustment of the relative volume of the A channel with respect to the B channel.

Setup mode also allows you to configure the two output channels independently. It is possible to configure the Line Out for each channel differently from the external speaker and headphone outputs. This can be very convenient when working in one of the Data modes. The Line Out can then be connected to a multi-mode controller.

The DSP-599zx requires external speakers and/or headphones to hear the audio signal. The DSP-599zx will accept either stereo or mono headphones with a 1/4" plug. Stereo headphones are preferred over monaural headphones so that you monitor both output channels simultaneously.

Visible Memories

The DSP-599zx has six memories to store complete settings and configurations. Pressing [**Shift+Store+#**] (# = 1 - 6) stores every setting and setup configuration except the audio gain control position. Pressing [**Rcl+ #**] instantly recalls the complete configuration stored in the chosen memory. The memory number is displayed along with the critical information on the LCD and LEDs.

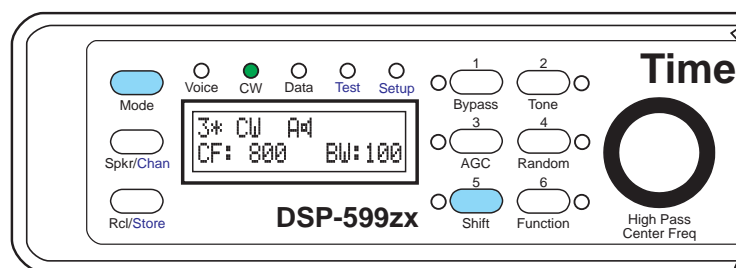

599-016

Automatic Gain Control

The DSP-599zx has switch-selectable automatic gain control to optimize the signal levels for best filter performance and to enhance listening by minimizing audible signal level variation.

Bypass Control

The DSP-599zx has bypass features that vary with the mode of operation. In voice and CW modes, the bypass setting routes the signal through relay contacts to completely bypass the electronic circuitry of the DSP-599zx. Turning the power off to DSP-599zx uses the same relay bypass method. In data mode, the bypass route is through the DSP processor. The amount of signal delay through the bypass route is equal to the delay through the processed signal route. The purpose of this delay equalization is to allow switching between signal processing and bypass without breaking the handshaking link of modes like PacTOR and G-TOR.

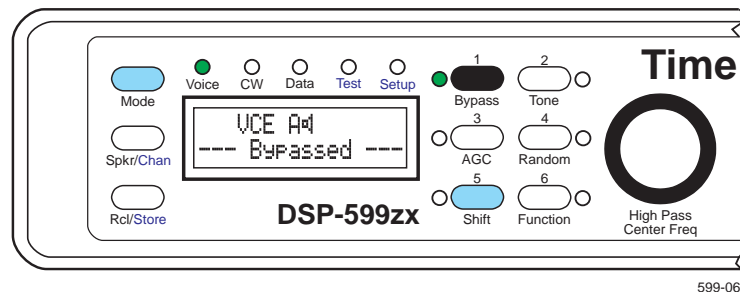

Bypass respects the status of the speaker switch. If the speaker is turned off, bypass leaves it off. The speaker will always, however, come on when power is turned off on the DSP-599zx.

Operating Modes

The DSP-599zx has three normal operating modes that operators will most often use:

- **Voice**
- **CW**
- **Data**

Pressing **[Mode]** steps from Voice mode to CW mode to Data mode back to Voice mode in a circular queue.

There are two more modes that operators will normally use during initial configuration, installation, and troubleshooting,

- **Test**
- **Setup**

Pressing **[Shift+Mode]** once places the DSP-599zx in Test mode. Pressing **[Shift+Mode]** again steps to Setup mode. Pressing **[Mode]** at any time places the unit back in one of the normal operating modes again. When in a menu or test instrument mode, pressing the **middle knob** will back you up one level. Think of the **middle button** in most cases as a cancel/clear button.

Voice Mode

The Voice Mode digitally processes all analog voice signals for all modes including SSB, AM, FM, and PM. Independently selectable processing techniques include noise reduction, heterodyne elimination, tunable high-pass/lowpass filtering, notch filtering and automatic gain control.

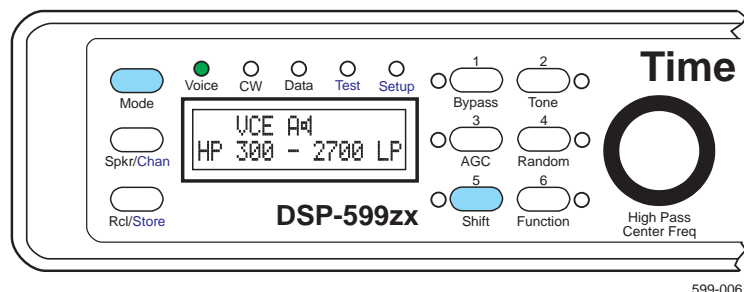

Highpass/Lowpass Filters

The DSP-599zx has highpass and lowpass filters that are independently tunable with front panel controls. The LCD display shows the corner frequencies of the filters as they are tuned. There are many uses for the variable combinations of highpass and lowpass filters that the DSP-599zx offers. In a typical example of a voice mode application, highpass and lowpass filters can improve a signal with a poor signal-to-noise ratio. The independent highpass and lowpass filters remove the low and high audio frequency components that do not contribute significantly to the speech intelligibility, thus improving signal quality. Another common voice mode example is the improvement of a SSB signal corrupted by adjacent channel interference (QRM). The steep skirts of the highpass and lowpass filters allow the operator to minimize or eliminate high side and low side interference independently with minimal impact on the desired signal.

The DSP-599zx highpass filter adjustment range is from 100 to 1000 Hz and the lowpass range is from 1000 to 5000 Hz. Although the DSP-599zx has bandpass filters for CW and the most common data modes, the selectable highpass and lowpass filter combinations also allow precise filtering for modes such as wideshift RTTY.

Random Noise Reduction

The DSP-599zx random noise reduction has proven to be useful in reducing a wide variety of noise types, including white noise, line noise and static crashes. The amount of noise reduction varies according to the characteristics of the noise. Typical noise reduction ranges from 5 dB to 20 dB. It is possible to change the level of aggressiveness within a regular operating mode without going into setup mode.

Adaptive Multi-tone and Manual Notch Filtering (Tone noise reduction)

The DSP-599zx has both an automatic notch filter and a manually tuned filter. The automatic multi-tone filter removes multiple heterodynes almost completely. The aggressiveness is adjustable.

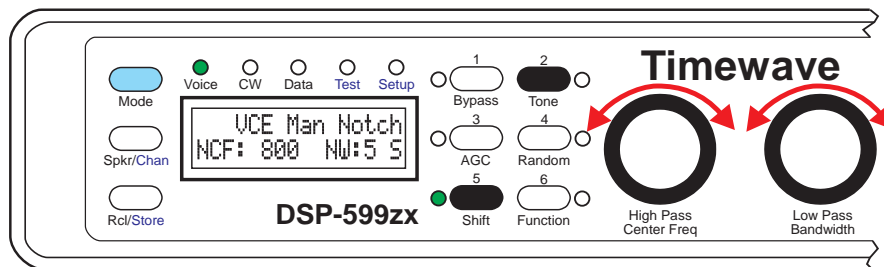

599-027

The manual notch filter is selectable for either as a dual notch filter for data signals and a narrow bandwidth filter for CW signals and heterodynes. The center frequency of the filter is easily set. This filter can be used either to remove a single tone or to remove mark/space data tones.

CW Mode

The CW Mode digitally processes analog CW (Continuous Wave) signals for Morse code reception. Independently selectable processing techniques include noise reduction, tunable bandpass filtering, notch filtering and automatic gain control.

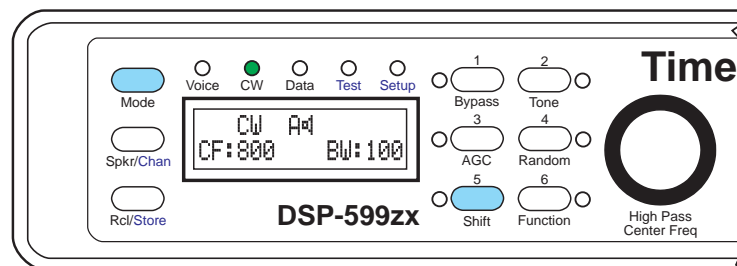

599-007

Bandpass Filters

The DSP-599zx has a fully tunable bandpass filter for use in the CW mode. The LCD display shows the center frequency and bandwidth of the filter as the operator tunes with front panel controls. Narrow band signals like CW and RTTY require a bandpass filter with steep skirts and linear phase response. Linear phase response maximizes the usable signaling rate for a given bandwidth and minimizes ringing often heard on other extremely sharp crystal and audio filters. The DSP-599zx CW filter has skirts so steep that a signal literally falls off the edge of the passband as you tune through a CW signal.

Bandwidths for the bandpass filter range from 10 Hz to 600 Hz, and center frequencies range from 200 to 2095 Hz. The narrow filter bandwidths are

useful for trying to dig out extremely weak signals from the noise and QRM. The narrow bandwidth is also an excellent way of tuning to a single CW signal in a crowded band condition. The wider filter bandwidth allows easy tuning and listening to multiple CW signals simultaneously.

Random Noise Reduction

The DSP-599zx random noise reduction has proven to be useful in reducing a wide variety of noise types, including white noise, line noise and static crashes. The amount of noise reduction varies according to the characteristics of the noise. Typical noise reduction ranges from 5 dB to 20 dB. In the CW mode, random noise reduction is generally most effective in the wider CW bandwidths (400-600 Hz).

Manual Notch Filtering

The DSP-599zx has a manually tuned notch filter. The **[Center Freq]** encoder on the front panel tunes the center frequency of the manual notch filter. The manual notch filter has an adjustable bandwidth allowing removal of many types of signals such as data signals, CW signals and heterodynes. Usually a narrow bandwidth filter is most effective for the greatest improvement of a CW signal, but some operating conditions (i.e., a contest) dictate a wide CW filter bandwidth. The manual notch can remove a single strong annoying signal.

Marker Tone

Pressing **[Tone]** while in the **CW** operating mode inserts an audio marker or spotting tone at the center frequency of the bandpass filter. Tuning the bandpass filter center frequency changes marker tone center frequency. Matching the marker tone frequency with the received signal allows switching in a narrow filter without losing the signal outside the passband of the narrow filter. The level of marker tone is adjustable relative to the processed receive signal.

CW Tone Pitch Shift

A feature unique to the DSP-599zx is the ability to easily shift the CW tone pitch to another frequency. This feature works well with receivers that have non-adjustable, relatively high pitch CW tone, since most hams prefer to listen to 400 - 600 Hz CW tones.

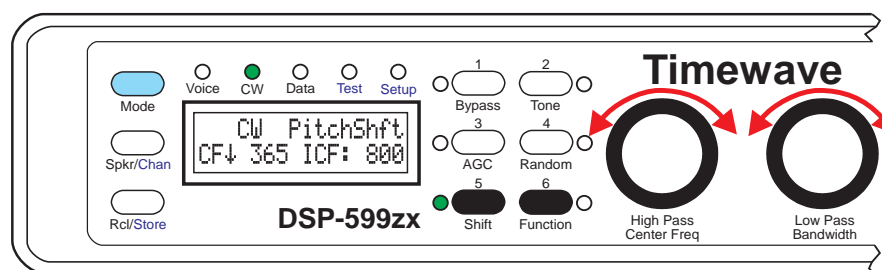

Data Mode

The Data Mode digitally processes data signals including several versions of RTTY, AMTOR, SITOR, PacTOR, G-TOR, CLOVER HF packet, SSTV and WeFAX. Independently selectable processing techniques include noise reduction, tunable bandpass filtering and automatic gain control, and a special RTTY modem and RTTY remodulator.

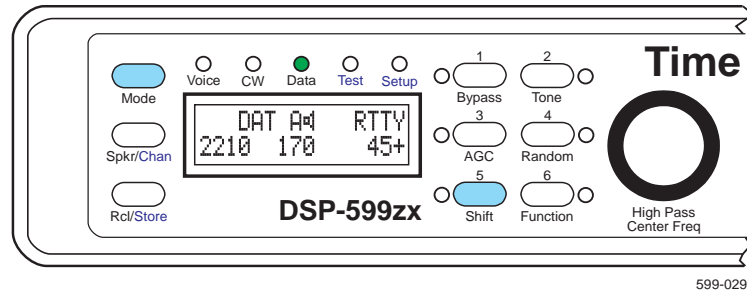

Bandpass Filters

The DSP-599zx has both fixed and tunable bandpass filters for the data mode. Narrow band data signals like RTTY require a bandpass filter with steep skirts, linear phase response, and matched amplitude response. Linear phase response maximizes the usable signaling rate for a given bandwidth and minimizes ringing often heard on extremely sharp filters. The matched amplitude response tailors the filter to match the selected modulation type and baud rate to minimize noise and interfering signals.

The DSP-599zx also has fixed frequency matched bandpass filters centered at 2210 Hz as well as lower frequencies for European standards and 1600-1800 Hz HF packet. The selectable bandwidths of the bandpass filters provide optimum filtering for 170 Hz and 200 Hz frequency shift data signals of various baud rates. Within setup, you can select between European or American standards as your default.

The DSP-599zx has individual linear phase fixed bandpass filters with steep skirts for SSTV, WeFAX and CLOVER. Since the bandwidths for these modes are fixed, the filters are primarily QRM filters for adjacent channel signals rather than noise reduction filters for eliminating random noise. The SSTV filter is a dual passband filter with one passband centered on the SSTV sync pulse at 1200 Hz, and the other passband around the varying FM picture tones from 1500-2300 Hz. WeFAX is similar to SSTV but has no separate sync pulse so the filter bandpass covers 1500-2300 Hz. The CLOVER filter has a 500 Hz bandwidth with a center frequency of 2250 Hz.

Data Tuning Function

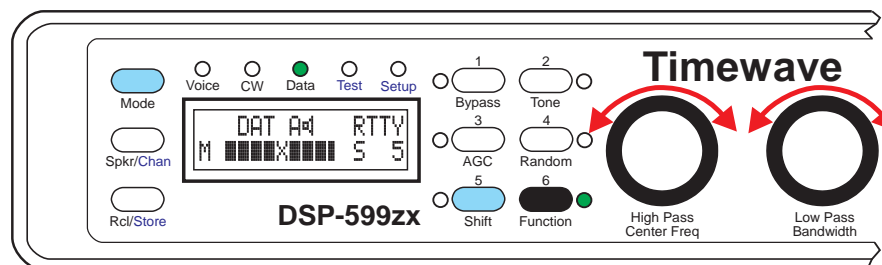

Pressing **[Shift+Function]** turns the tuning display on. This display provides information graphically to allow precise tuning of the receiver. The display also shows the strength of the incoming data signal.

Random Noise Reduction

The DSP-599zx random noise reduction function is not specifically designed for data signals, but has been field proven to be useful for noise reduction under some conditions. It is usually most effective for 45.5 baud RTTY signals.

RTTY Modem

The DB-9F connector provides an RS-232 compatible connection for the RTTY modem output to a computer. The output is demodulated FSK in the same code format (Baudot, ASCII, etc.) as the received signal. It is not decoded or changed in any way except for demodulation. The AFSK modulated output for the transmitter appears on the line output connector of the selected channel. The channel is selectable within setup. The PTT output signal needed to put your transceiver in transmit mode is part of the DIN connector for the appropriate channel.

The AFSK output is a modulated AFSK signal in the same code format (Baudot, ASCII, etc.) as the keying signal from the computer. The DSP-599zx does not encode or change the signal in any way except for AFSK modulation. A software terminal program that can decode and encode Baudot and ASCII code needs to be installed on the computer connected to the DSP-599zx. Timewave does not provide the terminal program. This modem is for RTTY operation only with signaling rates at 75 Baud or less.

This modem feature is designed for RTTY operation. It is not designed to be used as a TNC.

RTTY Remodulator

The DSP-599zx has another special data function for RTTY only. After passing through the optimized RTTY bandpass filter, a precision DSP-based FSK detector in the DSP-599zx demodulates the noisy incoming RTTY tones and uses the recovered digital data to drive a precision DSP-based AFSK generator. This remodulation process takes place entirely in the DSP-

599zx. The precise clean tones from the RTTY AFSK remodulator can feed any analog multimode controller or TU via the DSP-599zx line audio output.

Many analog RTTY demodulators have difficulty with noisy signals of varying amplitude, but virtually all of them can adequately demodulate the precise DSP AFSK generator output. The **[Function]** push-button selects either the remodulator with RTTY filters or the RTTY filters only. This remodulator is optimized for non-burst data at 75 Baud or less.

RTTY FSK Test Signals

Press **[Tone]** while in the non burst Data mode at 75 baud or less activates a sync nul (diddle) test tone. If the baud rate is 100 baud or higher, pressing **[Tone]** activates a space mark reference calibration tone.

Pressing **[Shift+Tone]** while in the Data RTTY mode at 75 baud or less inserts an audio FSK test signal into the receive channel. The “RYRY” test signal is centered at 2210 Hz with a frequency shift of +/- 85 Hz. The baud rate is determined by the RTTY parameter settings. The level of marker tone is adjustable relative to the processed receive signal. If the baud rate is 100 baud or higher, nothing happens when **[Shift+Tone]** is pressed.

Test Instrument Mode

The Test Instrument function helps analyze signals and other equipment. It includes an audio millivoltmeter, an audio signal generator, and an audio tone decoder.

Audio Millivoltmeter

This mode measures audio voltage levels from other equipment including microphones, TNCs, multimode controllers, and receivers. Measurements are both peak and true RMS millivolts. Frequency response ranges from 20 Hz to 10 kHz. In EME work, the audio millivoltmeter mode is useful in antenna evaluation when comparing sun noise and cold sky noise.

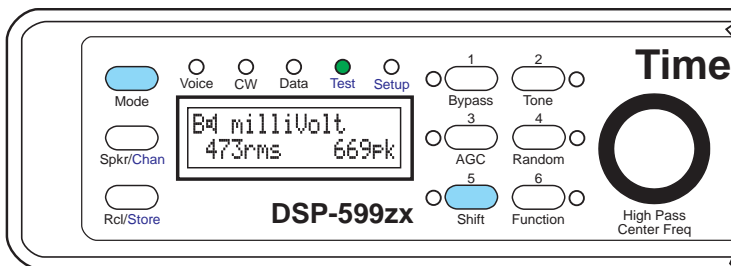

599-081



Maximum input level is 2000 millivolts rms.

Do not attempt to measure any voltage above 2000 millivolts, especially 115 Vac or 220 Vac power line voltage! You will damage the DSP-599zx! ALL WARRANTIES WILL BE VOID!

Audio Signal Generator

This mode produces tunable low-distortion, precision frequency sine wave test signals from 20 Hz to 10 kHz in 10 Hz steps. A two-tone test signal may be selected for SSB testing. The operator may use the precision test signals for calibration and/or trouble shooting of other equipment the user may own. The display shows the frequency and amplitude of the output signal from the line output.

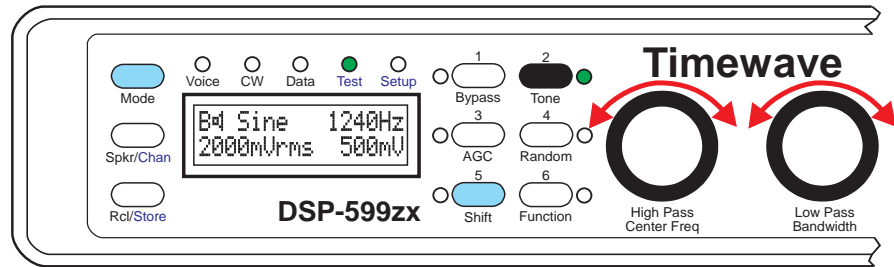

599-046

Two-Tone Generator

Produces a two-tone signal that can be used for SSB linearity testing. The DSP-599zx produces a very pure tone set. This provides for very accurate testing.

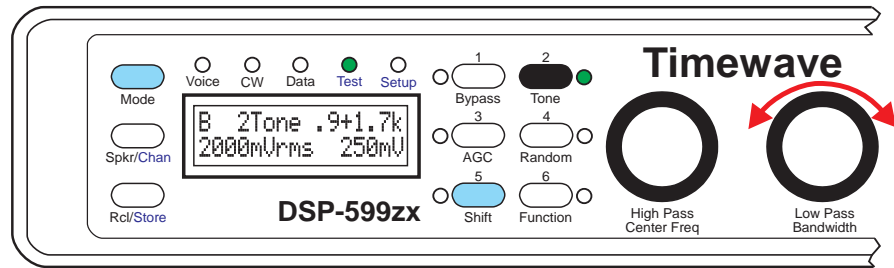

599-047

CTCSS Tone Decoder

This mode decodes CTCSS tones. The CTCSS function shows the tone frequency and amplitude on the LCD display. There are two modes of operation. The first is the autodetect mode which displays the frequency and amplitude of any valid CTCSS tone received. The second is the tone squelch mode which detects a selected CTCSS tone and activates a switch output on the DSP-599zx as well as generates a tone on the selected CTCSS frequency. The audio millivoltmeter function displays the peak amplitude of the selected incoming CTCSS tone. This allows relative measurement of peak deviation of CTCSS tones and voice for UHF and VHF FM/PM transmitters.

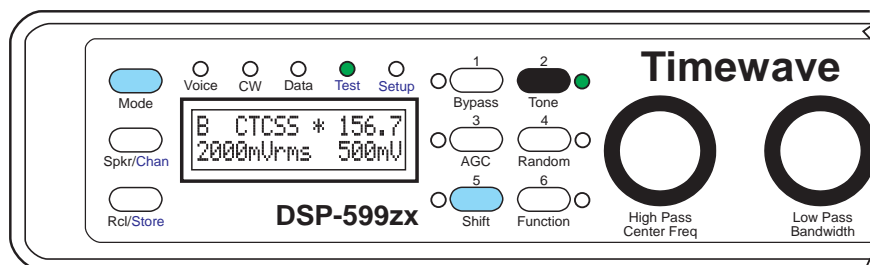

599-054

Set-up Mode

The DSP-599zx uses the setup mode to configure the features which typically do not change while operating.

- **Install Setup.** Common features are set before an operating session. Also features common to all modes such as input sensitivity and line output level are set during installation. (*See Section 2 - Installation* for detailed information.) The parameters available for change are:
 - Input Signal Level
 - Line Output Level
 - Speaker/Headphone Routing
 - Line Output Routing
 - Alternate Channel Gain
 - Reset Memory
- **Mode Setup.** Mode-specific features need only be set if that particular mode will be used. Those features are described in detail in the specific sections describing each mode (Voice, CW, Data, Test Instrument).
 - **Voice**
 - AM Line Noise
 - **CW**
 - Tone Level
 - **Data**
 - Speaker Mute/Bypass
 - Modem Assignment
 - Data Set Definitions
 - **Test Instrument**
 - Millivoltmeter Calibration
 - Signal Generator Calibration

- Default CTCSS Tone
- **About Setup** You can find the serial number of the unit and the revision level of the firmware along with the copyright notice in this section.

2 Installation

To install a DSP-599zx in a station, the operator must provide power to the DSP-599zx and make audio input and output connections to the DSP-599zx. A typical DSP-599zx installation is shown below.

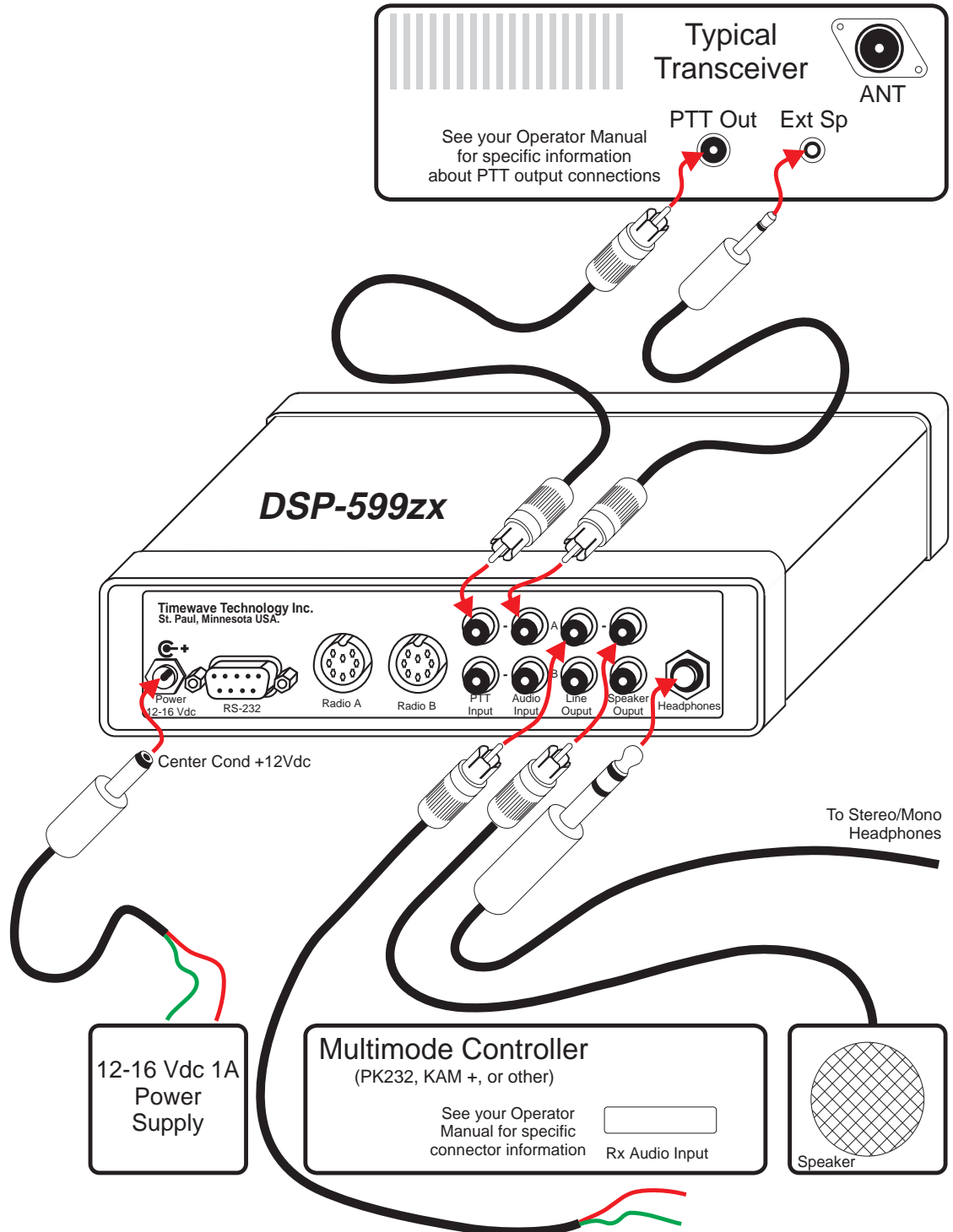

599-010

Power Supply

The DSP-599zx requires a power source of 12 to 16 Volts dc at 1.0 Ampere. The center pin of the power connector is POSITIVE (+). The DSP-599zx chassis is negative. The correct power plug size is 5.5 mm o.d. and 2.1 mm i.d.

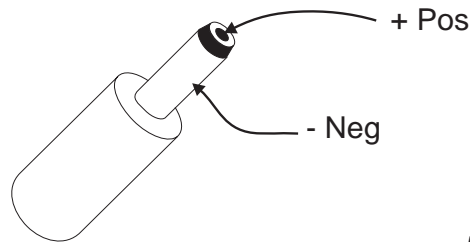

599-096

Acceptable power sources include:

- A 12 volt dc 1 amp unregulated wall mount or desktop power supply.
- A separate regulated 13.8 volt dc power supply with a minimum of 1.0 amp output.
- 13.8 volt dc transceiver power supply **Note that some transceivers with internal power supplies have accessory power jacks with insufficient current output to drive the DSP-599zx. Do not use these internal supplies!**

Users of some Kenwood and Ten-Tec rigs experience ground loop problems when using a common power supply for their rig and the DSP-599zx. We recommend that a separate power supply be used for the DSP-599zx.

(Switching power supplies are generally noisy and **not** recommended, unless they are specifically designed to drive amateur radio equipment.)

Connecting Cables

Use shielded coaxial cables with RCA phono connectors to minimize the possibility of RF interference to the DSP-599zx. Timewave recommends coaxial video cables with metal adapters to match the connectors on transceivers and speakers.

Do not connect the center pin on the DSP-599zx audio input connector to the transceiver speaker ground. Check the connections carefully - this is one of the most common problems in DSP-599zx installations!

Wiring information

This information is to help you determine which connectors you need for your receiver or transceiver. Connector requirements vary widely. Check your radio owner's manual for exact details.

DSP-599zx Inputs and Outputs

The DSP-599zx uses four RCA phono jacks on the back of the filter for audio input, audio output, PTT switch, and line output. Use cables with RCA

phono plugs on one end to connect to the DSP-599zx. The connectors on the other end of the cables are determined by the other devices.

Transceiver Speaker Output

A 1/8" mono phone jack is usually available on most receivers and transceivers for the speaker output. You most likely will use a cable with a 1/8" mono phone plug on one end. The other connector is a RCA phono plug to connect to the DSP-599zx. Some transceivers have other speaker output connectors such as 1/4" phono or RCA phono jacks.

External Speaker

The most common external speaker connectors are a RCA phono jack, a 1/8" phone plug, or bare tinned wires.

Multimode Data Converter and Terminal Units (TU)

Data devices use a wide variety of connectors including phone jacks, RCA phono connectors, DIN connectors, D-subminiature, screw terminals and others. Consult your owner's manual.

Transceiver PTT and T-R Outputs

Transceiver PTT and T-R outputs use a wide variety of connectors including phone jacks, RCA phono connectors, DIN connectors, screw terminals and others. Consult your transceiver owner's manual.

Figure 1 shows a RCA phono plug and Figure 2 shows a 1/8" mono plug.

The list of pre-made cables are from the Radio Shack Store.

- Part #42-2444 - 1/8" phone plug to RCA phono plug (DSP-599zx audio input to transceiver speaker output).
- Part #42-2370 - phono plug to split bare tinned wire (DSP-599zx speaker output to external speaker, or DSP-599zx PTT input from a transceiver PTT output connector).
- Part #42-2366 is a RCA phono plug to RCA phono plug.

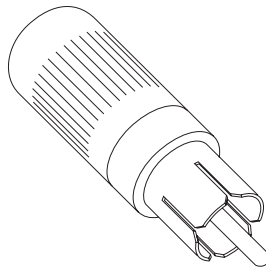

Figure 1 - RCA phono plug

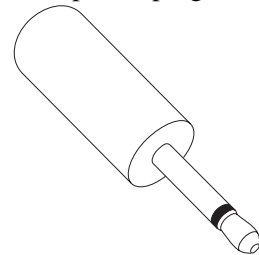

Figure 2 - 1/8" mono plug

For more information see your *ARRL Handbook* on connectors.

Audio Input

Input Impedance Setup

The factory default input impedance of the DSP-599zx Channel A is 25 ohms. This impedance is appropriate for most radios when driven by the speaker output of the radio. The factory default input impedance of the DSP-599zx Channel B is 20k ohms. This impedance is appropriate for most radios when driven by the speaker output of the radio and for other higher impedance sources. The reason for the two choices of impedance is that some radio output stages oscillate if you do not load them with a low impedance source. Other radio output stages are stable with high or low impedance loads. When using a radio, start with the radio loudspeaker output connected to the DSP-599zx Channel A input. This should work for all radios. If you are using a high impedance source, start with the source connected to the DSP-599zx Channel B input. You can configure the DSP-599zx Channels A and B for a high or low input impedance by moving a shorting jumper.

Input Impedance Jumper Access

1. Loosen the two screws holding each of the bezels in place. Slide bezels off the unit.
2. Remove four screws holding the front panel in place. Carefully disconnect the two ribbon cables from the rear of the front panel.
3. Remove the four screws holding the rear panel in place.
4. Turn unit over and remove the two screws from the bottom of the case.
5. Observing static precautions carefully turn unit upright and slide circuit board assembly about two thirds of the way out of the case.
6. Change the location of the jumper for the appropriate channel. Note that channel B is the uppermost. Putting the jumper on the left and middle pins sets the channel to high impedance. Putting the jumper on the center and right pins sets the channel to low impedance.

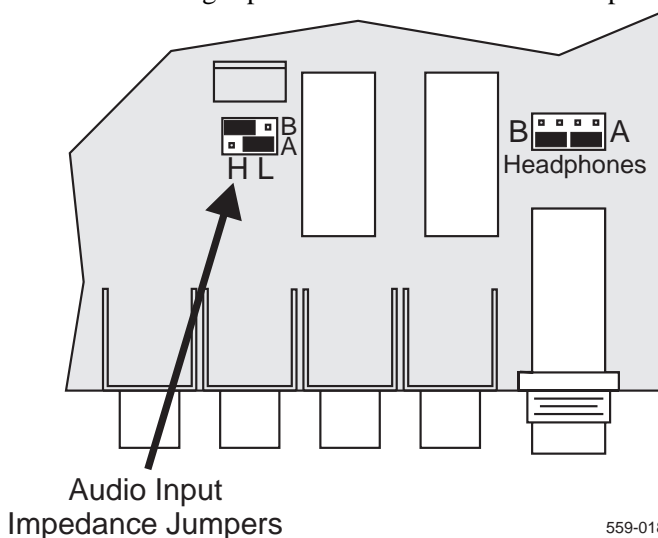

Reassemble the DSP-599zx by reversing the previous steps. Take care when sliding the circuit board assembly in so that you don't pinch the attached ribbon cables.

Audio Input Signal Level Setup

The audio inputs of the DSP-599zx are RCA phono connectors on the rear panel of the DSP-599zx. Matching the output level of the radio to the input level of the DSP-599zx is necessary to take maximum advantage of the wide dynamic range of the DSP-599zx. The Setup mode of the DSP-599zx allows independent adjustment of input sensitivity of Channels A and B. Turn to page 2-11 for the Setup procedure. The input sensitivity is factory set to match the speaker output levels typical of most amateur transceivers. Use Setup to set the input sensitivity if the source is different from a loudspeaker output. If you are using a loudspeaker output, the best way to match the level is to use the adjustable audio output of the radio to set the input level to the DSP-599zx. After connecting the DSP-599zx to the radio, follow this simple procedure to match the audio levels.

First, tune the radio to a strong signal after setting the radio output gain control to a convenient midrange position. Adjust the output level control on the radio so the **Overload (red)** indicator LED on the front panel of the DSP-599zx occasionally flashes and the **Normal (yellow)** indicator LED always flashes with the normal audio input levels. Proper adjustment ensures optimum signal-to-noise ratio and minimum distortion. Adjust the radio output level only to maintain the proper input level to the DSP-599zx. Use only the **[Gain]** control on the DSP-599zx to control the listening volume.

Audio Output

The DSP-599zx provides you with a choice of three audio outputs:

- Headphone jack
- Speaker outputs
- Line outputs

Headphone Jack

On the lower right hand corner of the DSP-599zx rear panel is a 1/4" (6.3 mm) jack connected for stereo headphones. **Timewave recommends stereo headphones.** Mono headphones will work for many of the functions of the DSP-599zx; however, some of the advanced capabilities require stereo headphones or two speakers.

Inserting a headphone plug does not affect the DSP-599zx speaker output. Use the front panel speaker switch to mute the speaker. The headphone volume may vary substantially among different types. If you find that the headphone volume is different than the speaker volume, use the internal jumpers to adjust the headphone volume.

Headphone Volume Jumper Access

1. Loosen the two screws holding each of the bezels in place. Slide bezels off the unit.
2. Remove four screws holding the front panel in place. Carefully disconnect the two ribbon cables from the rear of the front panel.
3. Remove the four screws holding the rear panel in place.
4. Turn unit over and remove the two screws from the bottom of the case.
5. Observing static precautions carefully turn unit upright and slide circuit board assembly about two thirds of the way out of the case.
6. Change the location of the jumper for the appropriate channel. Note that channel B is on the left. Putting the jumper across the bottom pair of pins sets the channel to normal volume. This is the factory default setting. Putting the jumper across the top pair of pins sets the channel to high volume. Putting the jumper vertically over the left pair of pins for each channel sets the channel to low volume.

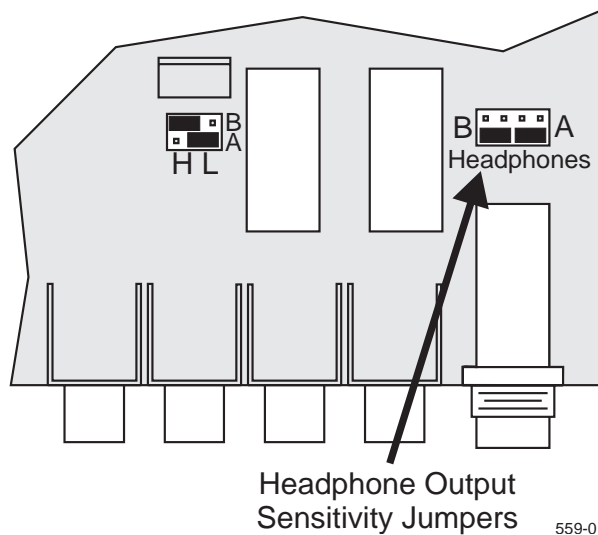

The figure below shows jumper configuration for the three choices for setting headphone volume. **If you are using mono headphones, you must set the volume for normal or low volume.** Even though you could set the headphone volume for channel A different than channel B, we do not recommend doing it.

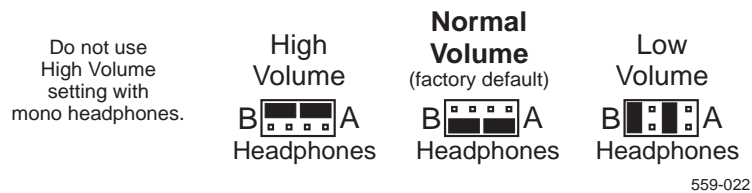

Reassemble the DSP-599zx by reversing the previous steps. Take care when sliding the circuit board assembly in not to pinch the attached ribbon cables.

Speaker Outputs

The Speaker Output RCA phono jacks on the rear panel of the DSP-599zx provide adequate output to drive 4 or 8 ohm speakers. The front panel gain control adjusts the audio level from both outputs A and B. Use the Setup mode to adjust the relative levels between the processed channel and the unprocessed channel. The maximum output power is approximately 1.3 watts into a 4 ohm speaker, or 1.0 watt into an 8 ohm speaker.

Line Outputs

The Line Output RCA phono jacks on the rear panel of the DSP-599zx provides adequate output power to drive 600 ohm or greater loads. The front panel gain control does not adjust the audio level from these outputs. The output levels are equal to the respective audio input levels to the DSP-599zx.

Input/Output Options

Within Setup - Install, you have options for configuring output assignments. You will assign speaker/headphone separately from line output. Turn to page 2-14 for the *Setup - Install* procedure.

Speaker/Headphone

The factory default is mono for one radio. With this option, when you select a radio connected to input A, you will hear the output on both channels. Likewise, if you select a radio connected to input B you will hear the output on both channels. The diagram below shows the speaker/headphone signal flow when the DSP-599zx is configured for mono.

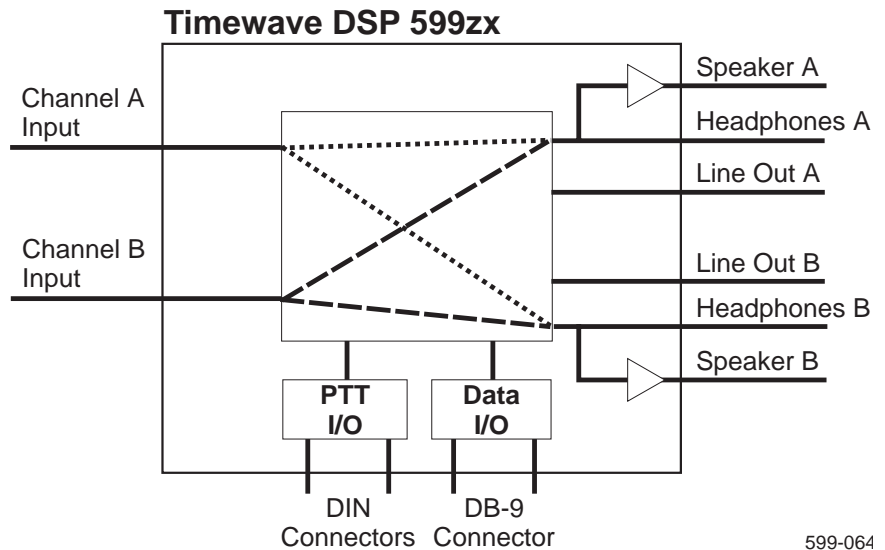

In dual mode when you are connecting two radios or one radio with two separate outputs, the diagram below shows the speaker and headphone signal flow.

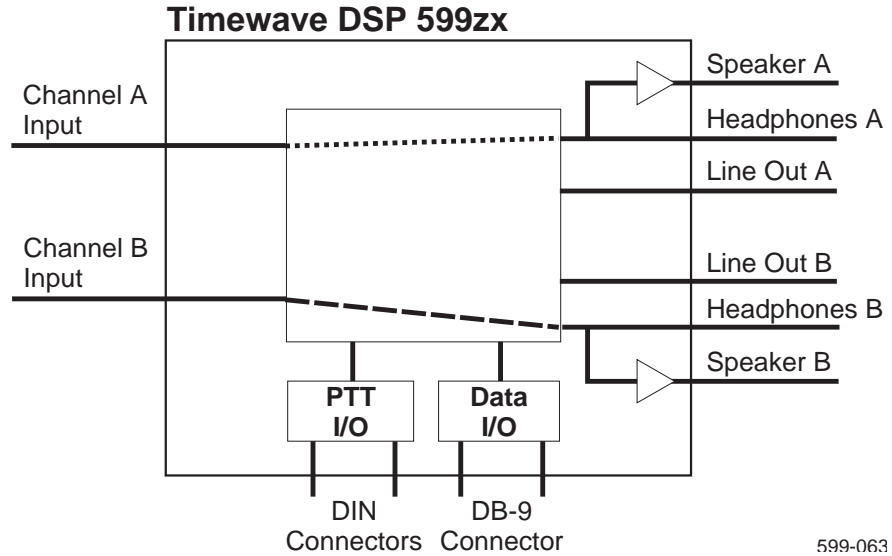

599-063

In this mode, you will hear the signal input on channel A on speaker/headphone A. Likewise, you hear the signal input on channel B on speaker/headphone B. When you are in this mode, you can hear both channels, but only the active channel is being processed by the DSP. The other is just being passed through. Selecting the active channel is accomplished by pressing **[Shift+Chan]** on the front panel. You can also set the audio level of the alternate channel with respect to the active channel within Setup - Install.

Line Output

You have the option to configure the line outputs differently from the speaker/headphone outputs. This is very convenient when using the internal modem or when using a multimode controller. You can have the speaker/headphone outputs configured dual and the line output configured mono. For example - this would direct the outputs from either selected input channel to the multimode controller. The factory default is mono as shown below.

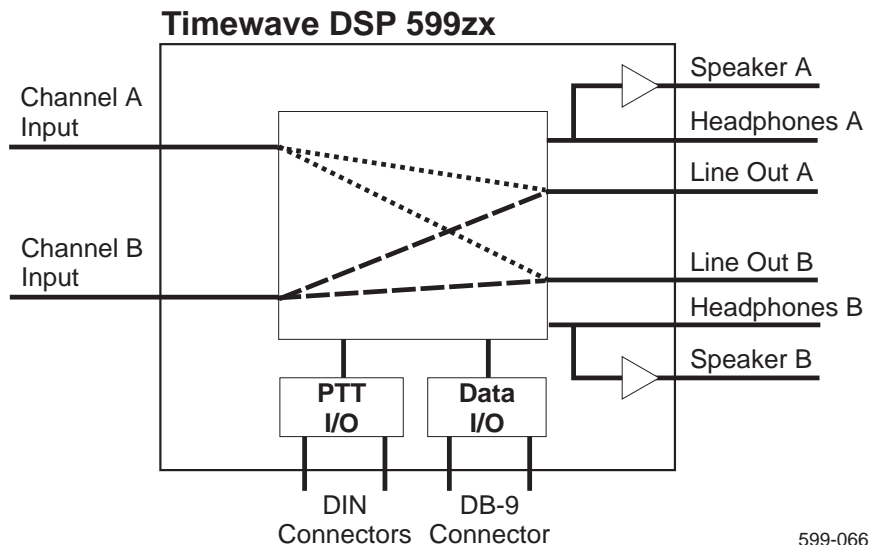

599-066

You also have the choice for line output to configure the outputs in dual mode as shown below.

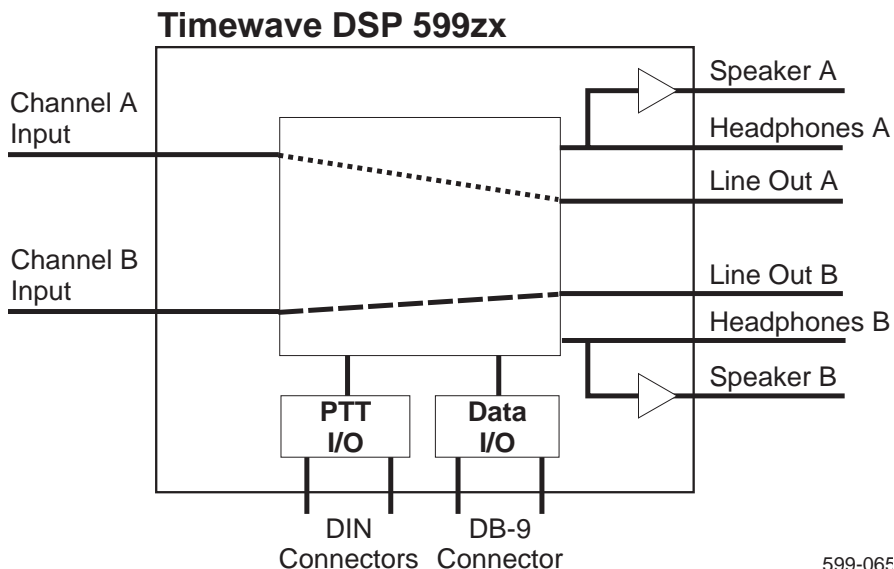

The options that you choose will depend on personal operating style, types of rigs connected, and favorite modes of operation. Feel free to experiment.

PTT Input

Proper connection of the DSP-599zx to the rig's Push to Talk circuit allows full function of the DSP-599zx. While in voice mode, the PTT circuit in the rig mutes the audio output of the DSP-599zx so audio feedback is not possible. Many rigs do not fully mute their audio while transmitting. When the DSP-599zx amplifies the partially muted audio the result can be audio feedback through the speaker.

When operating in CW mode, the PTT circuit does not mute the speaker output. This allows you to hear your internally generated sidetone from your radio. If you do not use PTT circuit, the narrow CW filter within the DSP-599zx may not allow you to hear your sidetone.

When operating in data mode you will also need the PTT output connected to your rig to allow the RTTY modem to trigger the transmit function on your rig. You can program the Push-To-Talk (PTT) Inputs to electronically bypass or mute the DSP-599zx in Data mode. Some operators like the output muted in data mode and some prefer to pass the output through. Within the data mode setup section of Setup the output is muted or not. Turn to page 6-56 for the Setup - Data procedure. Factory default setting is mute for data.

External contact closures operate the PTT Input circuits. No external power is required. Connect the return (shield) sides of the PTT Input jacks to the DSP-599zx circuit and chassis ground.

Many rigs have a separate jack on the back of the rig for PTT. On Kenwood rigs, the connection is made through pin 3 on the DIN jack. See your owners manual for complete connection information.

Some linear amplifiers have 115 volt supplies for their transmit-receive relays. **If a transceiver PTT line is used to drive both the DSP-599zx and a linear amplifier, an isolation relay and/or isolation diode may be required to prevent damage to the DSP-599zx (and any other solid state equipment connected to the PTT line).**

RTTY Modem Input/Output

To access the internal RTTY modem and all of its features you will need to configure an output port within setup. You will also need to use one of the two DIN connectors and the RS-232 port. The DIN connector has all the signals needed to connect to your transceiver. The RS-232 connector provides a serial connection to your computer.

DIN Jacks - Radio A and Radio B

The two 8 pin circular DIN connectors (labeled Radio A and Radio B) on the back panel of the DSP-599zx have redundant line outputs, audio inputs, and PTT inputs. They also have connections that are reserved for future options. These connectors provide an alternate single jack connection for each channel of the DSP-599zx to radio interface.

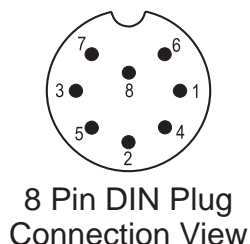

Pin	Signal
1	Line Out
2	Signal Ground
3	PTT Out
4	Key Out
5	FSK Out
6	DIN Audio In
7	PTT In
8	Reserved

599-021

When using the internal RTTY modem, you will need to use this connector. The plug is available from Radio Shack (Part #274-026) or other sources.

RS-232 Connector

The DB-9F connector provides a RS-232 compatible connection for the RTTY modem output to drive a computer. The output is demodulated FSK in the same code format (Baudot, ASCII, etc.) as the received signal. The DSP-599zx does not decode or change the signal in any way except for demodulation. The computer must have a software application loaded which can do the decoding and encoding.

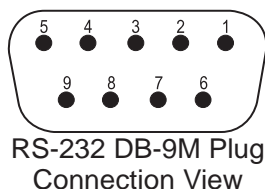

Pin	Signal
2	RD IN Mark/Space
3	TD OUT Mark/Space
5	Signal Ground
7	RTS rx/tx activation
8	CTS Reserved

599-020

Setup - Install

There are eight user adjustable variables within this mode of setup.

Even though these are called “Install” options, they are global options that you may change occasionally. We do not recommend changing any of these parameters until after you are thoroughly familiar with how the DSP-599zx works and that you really have to make the changes. Err on the side of caution when you make changes.

1. Press **[Shift+Mode]** twice to enter Setup mode.
2. Rotate **left knob** until **Install** appears on the bottom line of the display
3. Press the **left knob** to select.

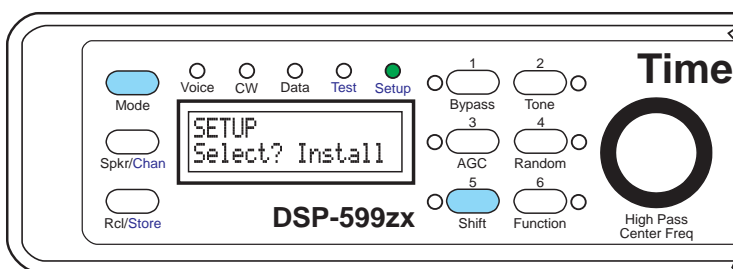

599-067

Audio Input Signal Level Setup

You can adjust the Input signal level. This should not be necessary if you are connected to the speaker output of your receiver. This might be necessary if you are connecting a high impedance device such as a tape recorder to the DSP-599zx. These usually do not have volume control. The range of adjustment is from +6.0 dBV to -16.5 dBV in 1.5 dBV steps. The factory default is -3 dBV.

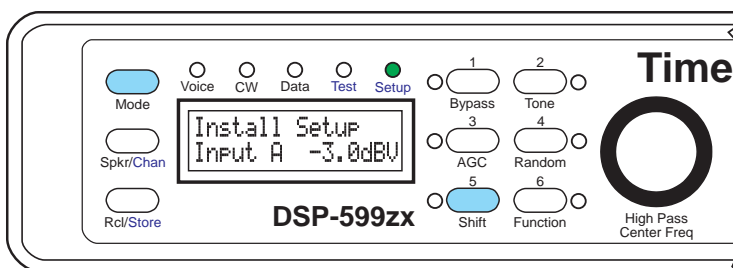

599-074

1. Press **[Shift+Mode]** twice to enter Setup mode.
2. Rotate **left knob** until **Install** appears on the bottom line of the display
3. Press the **left knob** to select.
4. Rotate **left knob** until **Input A** appears on the bottom left of the display

5. Press the **left knob** to select.
6. Rotate **left knob** until the chosen value appears on the bottom right of the display
7. Press the **left knob** to select.
8. Rotate **left knob** until **Install**  appears on the bottom left of the display
9. Press the **left knob** to select.
10. Rotate **left knob** until the chosen value appears on the bottom right of the display
11. Press the **left knob** to accept choice and save. Press **middle knob** to escape without saving changes.
12. Rotate **left knob** until your next function to change appears on the bottom line of the display or press the **middle knob** to return to main set-up menu.

Line Out Signal Level Setup

You should not need to change the factory default settings. If you need to change the settings for some reason, do so with some caution. The range of adjustment is -3.0 dBV to -24.0 dBV in 1.5 dBV steps. The factory default is -3.0 dBV.

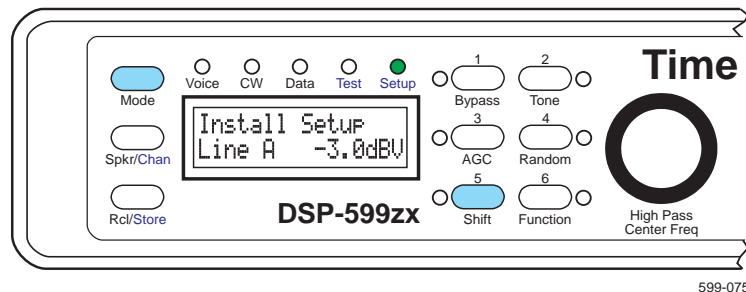

1. Press [**Shift+Mode**] twice to enter Setup mode.
2. Rotate **left knob** until **Install** appears on the bottom line of the display
3. Press the **left knob** to select.
4. Rotate **left knob** until **Line A**  appears on the bottom left of the display
5. Press the **left knob** to select.
6. Rotate **left knob** until the chosen value appears on the bottom right of the display
7. Press the **left knob** to select.

8. Rotate **left knob** until **Line E** appears on the bottom left of the display
9. Press the **left knob** to select.
10. Rotate **left knob** until the chosen value appears on the bottom right of the display
11. Press the **left knob** to accept choice and save. Press **middle knob** to escape without saving changes.
12. Rotate **left knob** until your next function to change appears on the bottom line of the display or press the **middle knob** to return to main set-up menu.

Speaker/Headphone Routing

See page 2-7 for a discussion on the choices. Your choices are mono and dual.

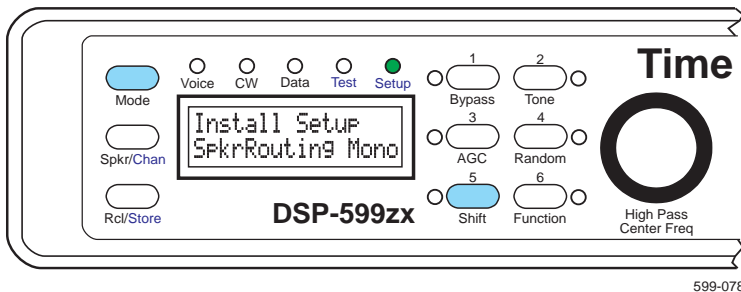

1. Press [**Shift+Mode**] twice to enter Setup mode.
2. Rotate **left knob** until **Install** appears on the bottom line of the display
3. Press the **left knob** to select.
4. Rotate **left knob** until **SpkrRouting** appears on the bottom left of the display
5. Press the **left knob** to select.
6. Rotate **left knob** until the chosen value appears on the bottom right of the display. Your choices are Mono or Dual.
7. Press the **left knob** to accept choice and save. Press **middle knob** to escape without saving changes.
8. Rotate **left knob** until your next function to change appears on the bottom line of the display or press the **middle knob** to return to main set-up menu.

Alternate Channel Gain

If you have selected dual mode for speaker/headphone, you can also set the audio level of the alternate channel with respect to the active channel. This allows the alternate channel to be heard at a lower volume than the active channel. The range is 0.0 dB to -18 dB in 3 dB steps. The factory default is 0 dB.

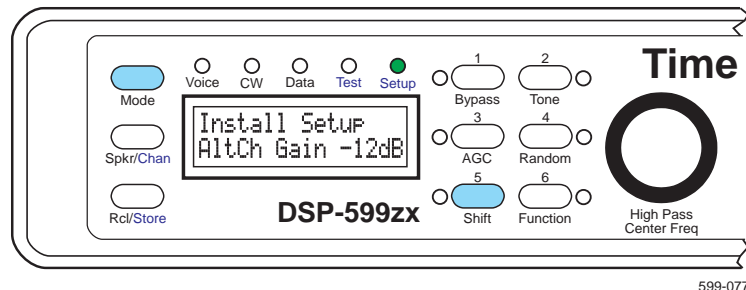

1. Press **[Shift+Mode]** twice to enter Setup mode.
2. Rotate **left knob** until **Install** appears on the bottom line of the display
3. Press the **left knob** to select.
4. Rotate **left knob** until **AltCh Gain** appears on the bottom left of the display
5. Press the **left knob** to select.
6. Rotate **left knob** until the chosen value appears on the bottom right of the display
7. Press the **left knob** to accept choice and save. Press **middle knob** to escape without saving changes.
8. Rotate **left knob** until your next function to change appears on the bottom line of the display or press the **middle knob** to return to main set-up menu.

Line Out Routing

See page 2-8 for a discussion on the choices. Your choices are mono and dual.

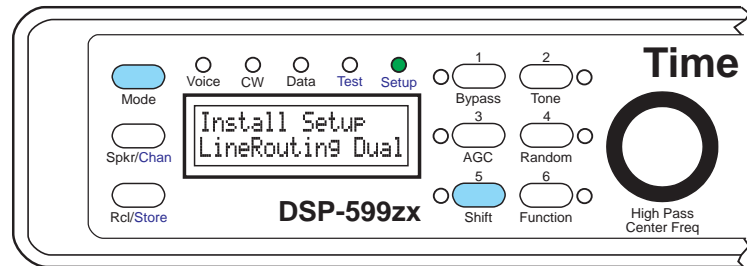

599-079

1. Press [**Shift+Mode**] twice to enter Setup mode.
2. Rotate **left knob** until **Install** appears on the bottom line of the display
3. Press the **left knob** to select.
4. Rotate **left knob** until **LineRouting** appears on the bottom left of the display
5. Press the **left knob** to select.
6. Rotate **left knob** until the chosen value appears on the bottom right of the display. Your choices are Mono or Dual.
7. Press the **left knob** to accept choice and save. Press **middle knob** to escape without saving changes.
8. Rotate **left knob** until your next function to change appears on the bottom line of the display or press the **middle knob** to return to main set-up menu.

Reset Memory

When you select reset memory, you get the choice of USA or European. Selecting USA sets AM Line Noise to 60 Hz. and sets RTTY frequency tones to 2210 Hz. Selecting European sets AM Line Noise to 50 Hz. and sets RTTY frequency tones to 1360 Hz. These also are all individually adjustable in other sections of setup.

The big thing that Reset Memory does is resets all operation based memories. Examples include all user memories, power up mode configuration, and all modifications to Data mode parameters.

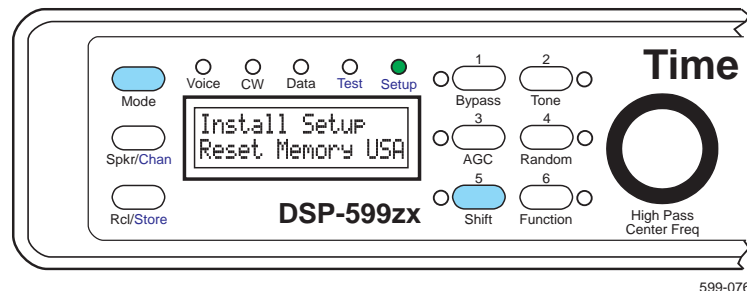

1. Press **[Shift+Mode]** twice to enter Setup mode.
2. Rotate **left knob** until **Install** appears on the bottom line of the display
3. Press the **left knob** to select.
4. Rotate **left knob** until **Reset Memory** appears on the bottom left of the display
5. Press the **left knob** to select.
6. Rotate **left knob** until the chosen value appears on the bottom right of the display. Your choices are USA or EUR.
7. Press the **left knob** to accept choice and save. Press **middle knob** to escape without saving changes.
8. Rotate **left knob** until your next function to change appears on the bottom line of the display or press the **middle knob** to return to main set-up menu.

Exit Setup

When you are through with Setup, press **[Mode]** to return to Voice mode.

3

General Operation

Introduction

The DSP-599zx provides you a well stocked tool box of powerful tools. Each tool is designed to do a specific job and do it well. You need to carefully select the correct tool to fix the problem. Like any other tool box, you should only use the tools you need.

Front Panel Operation

Three knobs, two with push buttons built in, and nine push-button keys on the front panel control the DSP-599zx. One knob controls power and sets the speaker and headphone output level of the DSP-599zx. The other two knobs, with their built-in push buttons, select the filter and test generator frequencies of the DSP-599zx.

The operator can also use the left knob to make a selection from a menu or change a variable. Rotate the left knob to view the selections and press the knob to select your choice.

In most situations, pressing the middle knob deactivates temporary settings. It is also used to escape from menus without making a selection. You can think of the pressing the button middle knob as pressing an Esc/Cancel button.

The push-buttons select the operating modes and features of the DSP-599zx. Either an indicator LED or information on the liquid crystal display indicates active modes. Note that pressing a push-button always selects the mode indicated below the push-button.

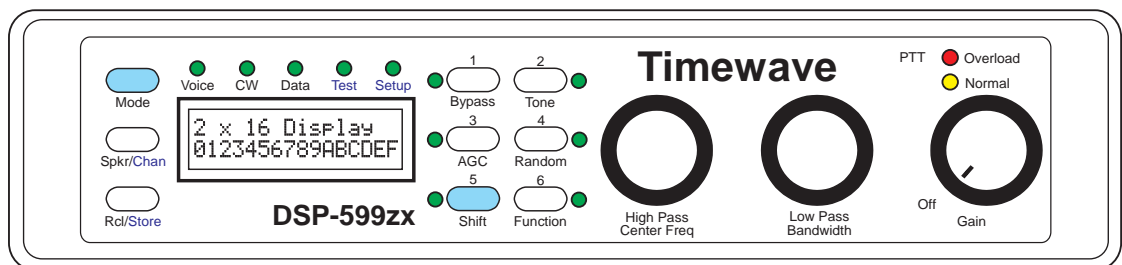

559-001

Controls Common to All Modes and Features

Primary Operating Modes [Mode]

Press the Mode key to switch between the main operating modes (Voice, CW, Data). Each time you press **[Mode]**, the operating mode changes to the next mode. The active mode is indicated by a LED and is displayed on the LCD as a two or three character name.

Secondary Operating Modes and Features [Shift]

The **[Shift]** key selects modes and operating features with light blue lettering by pressing and releasing **[Shift]** before pressing the mode or feature key. The shifted modes include Setup **[Shift+Mode]****[Shift+Mode]** and Test Instrument **[Shift+Mode]**. Shifted operating features include Input Channel **[Shift+Chan]**, memory store **[Shift+Store]**, and Speaker Mute **[Shift+ Spkr]**.

Many specialized mode dependent functions are controlled, for example, by pressing **[Shift+Tone]**, **[Shift+Random]**, or **[Shift+Function]**. The availability of any of these and response vary depending upon many factors including operating mode. See mode specific sections for information.

If you press the **[Shift]** key and decide not to complete the shift operation, pressing the **[Shift]** key a second time before pressing another key will cancel the shift operation. If a mode or operating feature does not require a shift, pressing **[Shift]** and that mode or operating feature key cancels the shift and does not execute the mode or operating feature. The shift operation will automatically cancel if you do not press a key within three seconds after pressing **[Shift]**.

Speaker Control [Spkr/Chan]

The **[Spkr]** key will mute both A and B speaker outputs. The  icon near the top middle of the display is visible when the speaker outputs are active. The speaker output setting does not affect the headphone outputs or the line outputs.

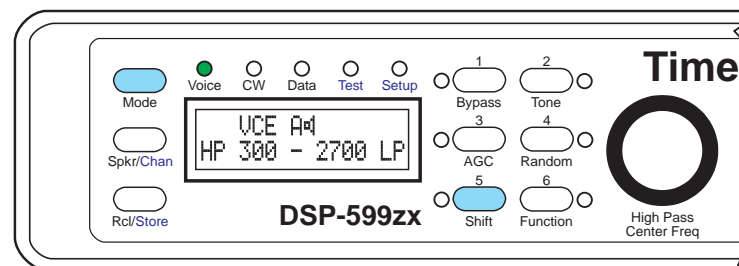

599-006

Channel Control [Spkr/Chan]

Press **[Shift+Chan]** to toggle between input channels A and B. The active channel is displayed immediately to the left of the speaker icon.

An example: Channel A is connected to your HF rig and set for CW mode with a narrow bandpass filter. Channel B is connected to a shortwave receiver and set for Voice mode with a wide bandwidth filter. When switching from channel A to B, all the settings change from CW mode with a narrow filter to Voice mode with a wide filter for AM. Switching back to channel A changes everything back to CW mode again.

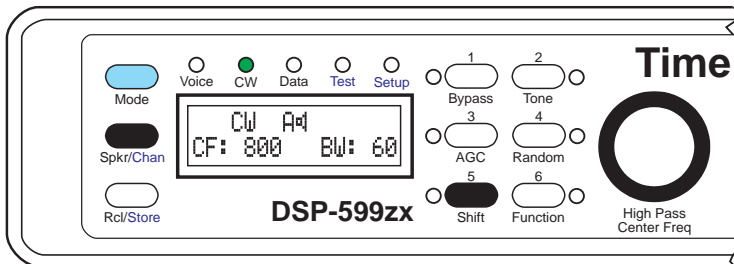

599-031

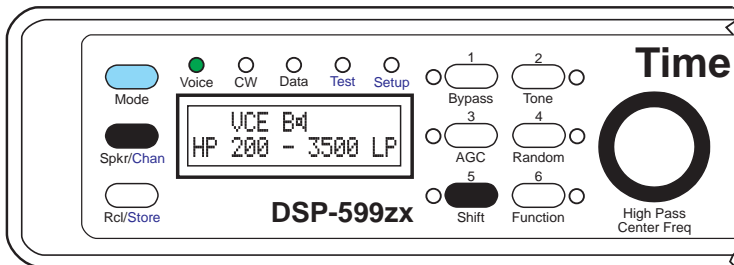

599-032

Memory Operation [Rcl/Store]

To store a setting in memory, press **[Shift+Store+#]**. (# = a digit in the range 1 to 6 printed in yellow letters above the corresponding key.)

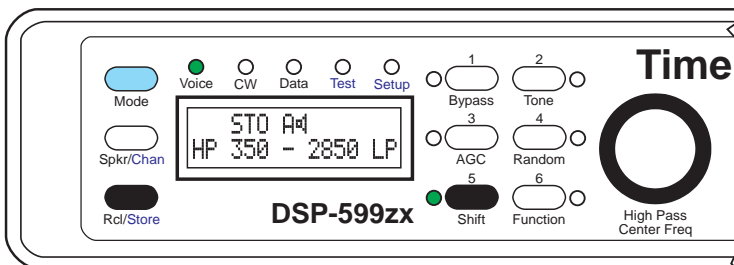

599-037

To recall a setting from memory, press **[Rcl+{#}]**. (# = a digit in the range 1 to 6 printed in yellow letters above the corresponding key.)

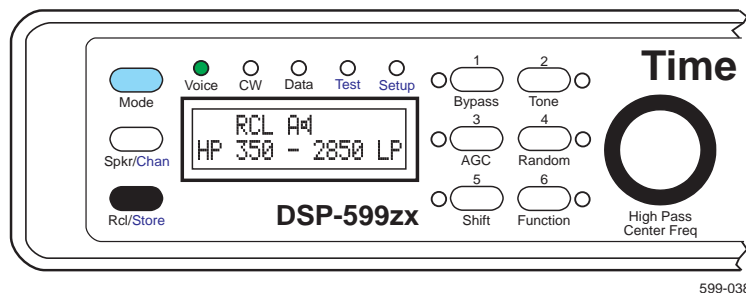

If you start to store or recall a setting from memory and decide not to complete the store or recall, pressing any other key (including **[Store]** or **[Rcl]**) before a number key is pressed cancels the Store or Recall operation. The Store or Recall operation will automatically cancel if you do not press a number key within five seconds after pressing the **[Rcl/Store]** key.

If you have recalled a setting from memory and want to restore the previous setting from before the memory recall, press **[Rcl+Rcl]**. The previous setting will replace the recalled setting. Pressing **[Rcl+Rcl]** again will bring back the recalled setting. For example, press **[Rcl+3]** to recall the memory 3 setting. Press **[Rcl+Rcl]** to restore the setting before memory 3 was recalled. Press **[Rcl+Rcl]** again to restore the memory 3 setting. Each time **[Rcl+Rcl]** is pressed the two settings will be swapped. This is a good way to compare two settings or switch quickly between two settings.

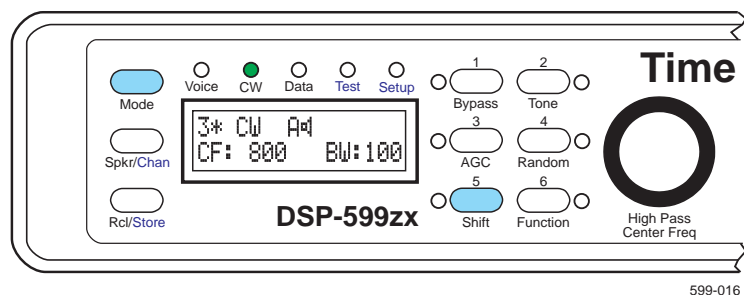

The memory number is displayed in the top left position on the display when you recall a configuration from memory. An asterisk is displayed next to the memory number if you make any changes to the configuration after recalling the configuration. The asterisk disappears if you store the new configuration or if you change operating modes.

It is good operating practice to reserve memory 1 as a scratch pad or temporary memory. Use memory 1 to store temporary configurations when you want to compare several configurations, or as a temporary location to store a new configuration to when you cannot decide which memory you want to use for a storage location.

User Selectable Power Up Mode

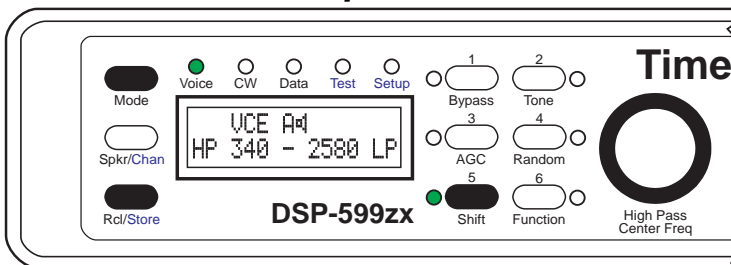

599-036

Select power up mode by pressing **[Shift+Store+Mode]**. This stores the operating mode and channel that you wish to start with when the DSP-599zx is powered up. You may easily change this selection at any time in the future by repeating the process.

Bypass [Bypass]

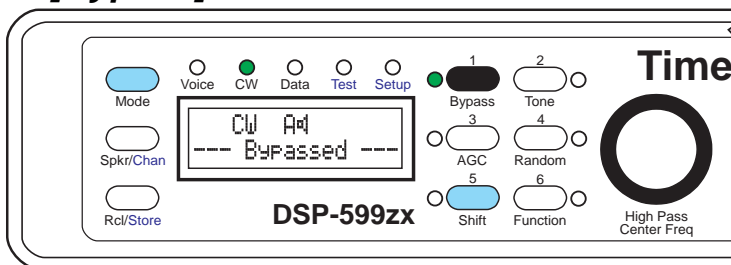

599-008

When you select **[Bypass]**, the other controls have no effect on the operation of the DSP-599zx. The LED next to the button and **Bypassed** displayed on the bottom line of the LCD indicates that bypass is active.

The bypass function completely bypasses the DSP electronics in Voice and CW modes but follows the speaker setting. If the speaker is set to off, the speaker will remain off while in bypass mode. The speaker will be on when DSP-599zx power is off.

The Data mode has a special electronic bypass mode for data link integrity described in the *Data Mode* section on page 6-3.

Automatic Gain Control [AGC]

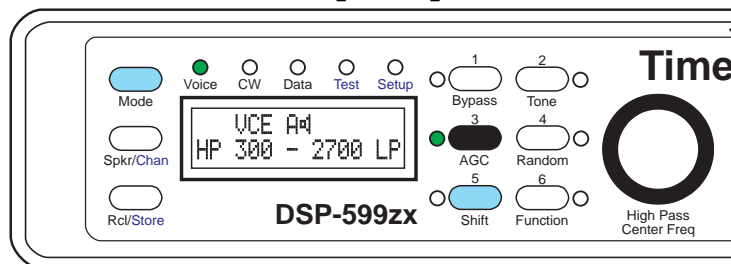

599-033

The AGC feature helps maintain a constant output level when the input level varies. The obvious use of the AGC feature is to keep the DSP-599zx output level when input signal levels vary rapidly as a result of operating conditions (for example, nets, contests, rapid fading). The AGC can also help alleviate

two other common receiver problems. The first is increase the level of weak signals when receive system gain is low. In the process of maintaining the constant level, the signal processor can add up to 36 dB of gain to the DSP-599zx signal path. In some situations, this increased gain will also noticeably increase the background noise level.

The second common problem is receiver desensing by the AGC action of strong signals in the passband of the receiver. The receiver selectivity may not be sufficient to separate a strong signal from a weak signal, but the DSP-599zx may easily separate the two signals. (This is a receiver problem because the weak signal couldn't be heard without the highly selective DSP filter.) Since the stronger signal controls the gain of the receiver via the AGC, the stronger signal effectively modulates the weaker signal.

Depending upon the relative AGC time constants of the DSP-599zx and the receiver, the DSP-599zx can help remove the AGC induced modulation. Experiment with changing the receiver AGC setting from Fast to Slow, Slow to Fast, or even turning off the receiver AGC. Try the same changes if "Pumping" of the signal levels occurs as a result of AGC interaction between the receiver AGC and the DSP-599zx AGC when listening to normal signals.

Leaving the AGC on all the time is not necessarily the best solution. You will find situations when you will have a better audio signal with AGC off.

Noise Reduction

Press **[Random]** to enable random noise reduction. The LED next to the key lights when the feature is on.

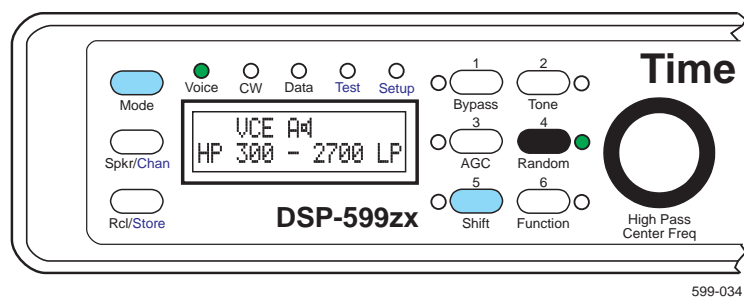

Power Switch/Gain Adjust Control

The gain knob on the front panel of the DSP-599zx is the power switch/gain adjust control. The gain control simultaneously controls both channels' volumes. Within Setup, you can adjust the relative volume of channel A with respect to channel B. This adjustment ranges from equal levels to the inactive channel off.

Turning off or removing power from the DSP-599zx automatically de-energizes a bypass relay and forces the DSP-599zx into the bypass mode.

4

Voice Mode

Operation

In Voice mode, the DSP-599zx conditions the audio response of the DSP-599zx using a combination of highpass filters and lowpass filters, adaptively reduces random noise, and adaptively eliminates multi-tone noise (heterodynes). These three functions can operate simultaneously or independently as outlined below.

High Pass/Low Pass Filters

SSB and AM voice signals often have a high signal-to-noise ratio but have interference from other signals that overlap the desired signal. The steep skirts of the highpass and lowpass filters allow elimination of the interference with minimal impact on the desired signal.

- Highpass filters tune from 100 to 1000 Hz.
- Lowpass filters tune from 1000 to 5000 Hz.

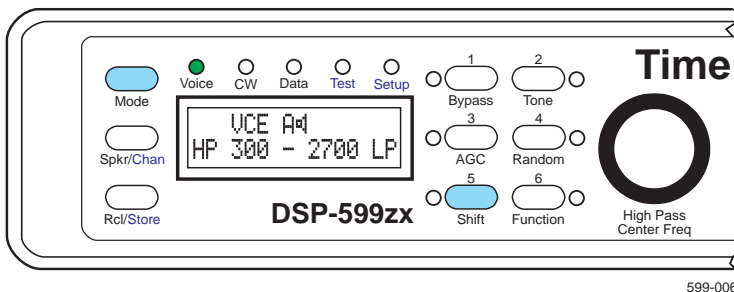

- Turn **[High Pass]** to the desired frequency indicated by the numbers in the lower left side of the display.
- Turn **[Low Pass]** to the desired frequency indicated by the numbers in the lower right side of the display.

These two settings customize the frequency response of the DSP-599zx.

High Pass/Low Pass Hint

Set the Highpass Filter to 300 Hz and the Lowpass filter to 2.7 kHz for normal sideband operation. Adjust the Highpass filter up to 400 Hz to eliminate heavy QRM, if necessary. Adjust the Lowpass filter as low as 1.6 kHz to eliminate heavy QRM. Of course you may set the filter frequencies anywhere you wish, but remember that extremely narrow bandwidths will affect intelligibility, so keep the bandwidths wide, if possible.

Noise Reduction

To activate random noise reduction, press **[Random]**. When the feature is active, the LED next to the key lights.

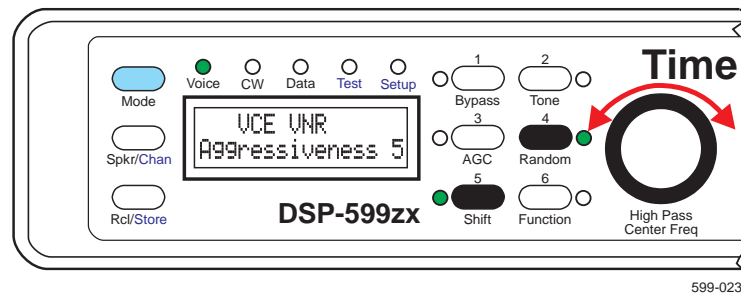

- Press **[Shift+Random]** to adjust the aggressiveness of Noise Reduction.
- Then turn the **left knob** to adjust the amount of random noise reduction.
- The top line of the liquid crystal display shows **VNR** and the bottom line displays the relative amount of noise reduction aggressiveness while the **VNR** function is active.
- The aggressiveness value can be adjusted from one to nine with a default value of five. The higher the aggressiveness value is set, the greater the noise reduction.
- Pressing the **left knob** or pressing **[Shift+Random]** again stores the new value and returns the DSP-599zx to its normal operating mode. The noise reduction aggressiveness will remain at its last setting until it is changed.

Noise Reduction Operating Hints

Power Line Noise

If your receiver has variable noise blanker controls, it is often possible to use the noise blanker and the DSP-599zx Random mode together. This can be a very effective noise reduction method for impulsive power line noise. Set the receiver noise blanker to remove the high amplitude noise spikes and the DSP-599zx to remove the remaining noise. An advantage of this combination is the ability to reduce the noise blanking settings of the receiver to minimize the blanking distortion caused by strong signals near the receive frequency.

Static Crashes

It is often possible to reduce atmospheric static crashes to a tolerable level using the DSP-599zx random noise reduction mode. It is important to try different AGC, input attenuator and RF gain settings on your receiver in addition to the DSP-599zx. Fast AGC with 10 - 20 dB of input signal attenuation usually helps prevent the receiver front end from overload and the AGC from desensing the receiver. Results vary with different receivers - don't be afraid to experiment. Don't try to operate if lightning is overhead! Disconnect your antenna and read this manual again.

AM Line Noise

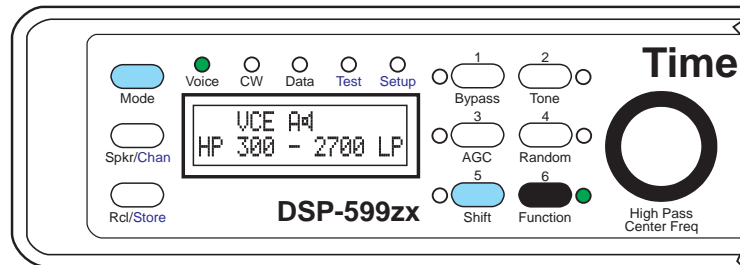

599-098

When working weak signals working in shortwave and AM voice modes, you might have line noise interference. Press **[Function]** to activate the AM Line Noise Filter. This filter does not work on SSB! The AM Line Noise Filter is active when the LED next to the **[Function]** key is on. The aggressiveness of the AM Line Noise Filter is adjustable.

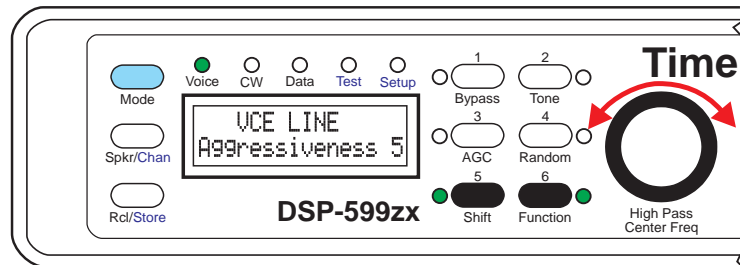

599-099

- Press **[Shift+Function]** to adjust the aggressiveness of the AM Line Noise Filter.
- Then turn the **left knob** to adjust the amount of noise reduction.
- The top line of the liquid crystal display shows **VCE LINE** and the bottom line displays the relative amount of noise reduction aggressiveness while the AM Line Noise Filter function is active.

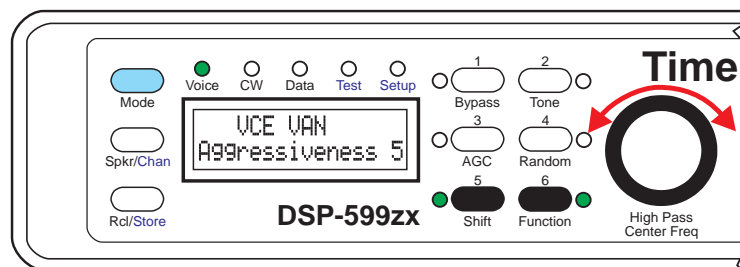

599-102

- The aggressiveness value can be adjusted from one to nine with a default value of five. The higher the aggressiveness value is set, the greater the noise reduction.
- Pressing the **left knob** or pressing **[Shift+Function]** again stores the new value and returns the DSP-599zx to its normal operating mode with the AM Line Noise Filter activated. The noise reduction aggressiveness will remain at its last setting until it is changed.

Heterodyne Elimination/Notch Filters

The DSP-599zx has both an automatic and a manual tone notch filter to help remove interfering heterodynes, CW, and data signals.

Automatic Notch Filter

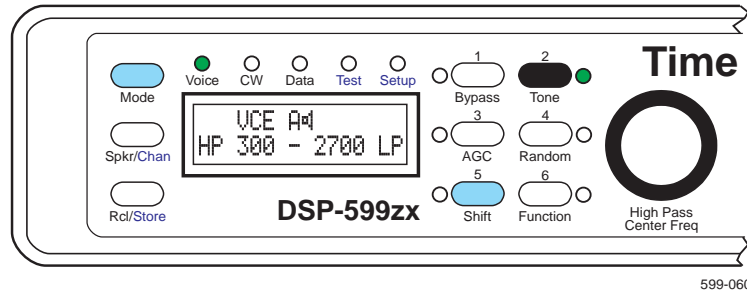

The automatic tone notch filter can reduce multiple heterodynes 40 to 50 dB, virtually eliminating the offending signals. The automatic tone notch filter substantially reduces CW and FSK data signals, depending upon the keying speed or baud rate. The automatic tone notch filter toggles on and off by pressing **[Tone]**. The LED next to the key will light when active. The aggressiveness of the automatic tone notch filter is adjustable.

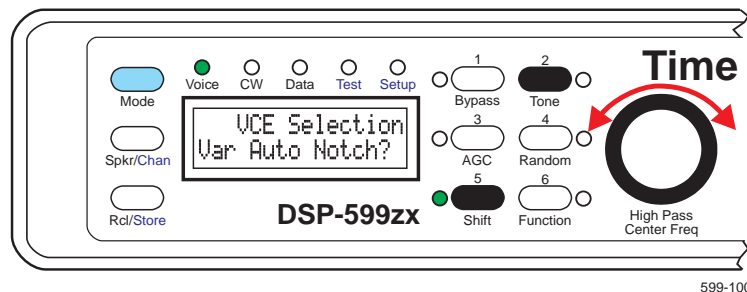

- Press **[Shift+Tone]**. Rotate left knob until `Var Auto Notch?` appears on the bottom line of the display.
- Press the **left knob** to select.
- The top line of the liquid crystal display shows `VCE VAR` and the bottom line displays the relative amount of noise reduction aggressiveness while the automatic tone notch filter function is active.
- Rotate the **left knob** to adjust the amount of noise reduction.
- The aggressiveness value can be adjusted from one to nine with a default value of five. The higher the aggressiveness value is set, the greater the noise reduction.
- Pressing the **left knob** or pressing **[Shift+Tone]** again stores the new value and returns the DSP-599zx to its normal operating mode with the automatic tone notch filter activated. The noise reduction aggressiveness will remain at its last setting until it is changed.

Manual Notch Filter

The manually tuned notch filter is equally effective in reducing the interfering signal levels, but may be used to eliminate a single heterodyne, CW or data signal.

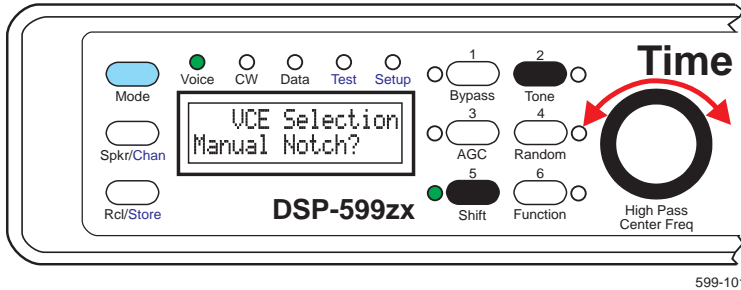

- Activate the manual notch function by pressing **[Shift+Tone]**. Rotate left knob until Manual Notch? appears on the bottom line of the display.
- Press the **left knob** to select.

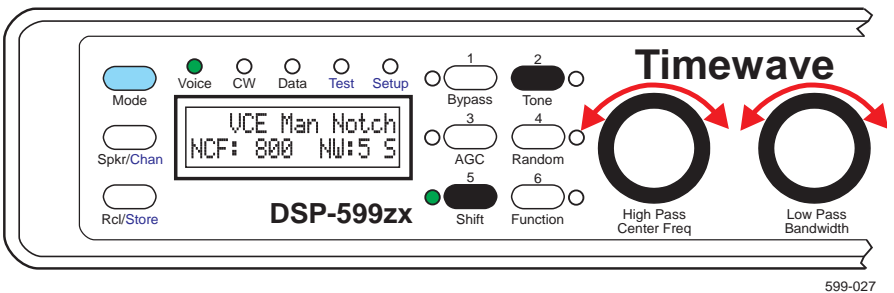

- Rotate the left knob **[Center Freq]** to change the notch center frequency (NCF) of the filter in 10 Hz steps.
- Rotate the middle knob **[Bandwidth]** to adjust the notch bandwidth (NW). The lower the value, the narrower the filter. Number one through five are single notch filters. Number six through nine are dual notch filters separated by 180 Hz for filtering out interfering data signals. As a reminder, a **S** or **D** will be displayed in the bottom right corner of the display to remind you if you have a single or dual notch filter.
- After tuning the filter to the desired center frequency and adjusting the bandwidth, push the momentary switch built into the **left knob**.

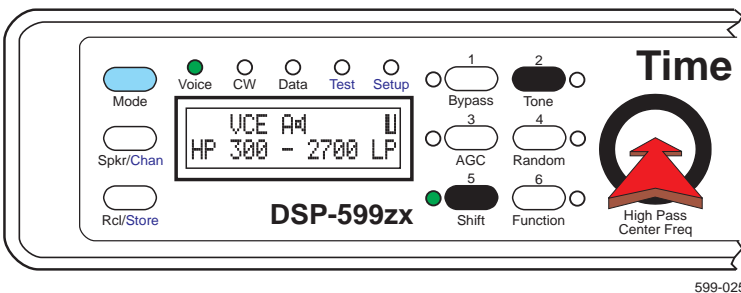

The display changes back to the original operating mode with a  icon in the upper right corner of the display indicating that the manually tuned notch filter is active. Turn off the manual notch filter mode by pressing the momentary switch built into the **middle knob**.

Voice Bypass

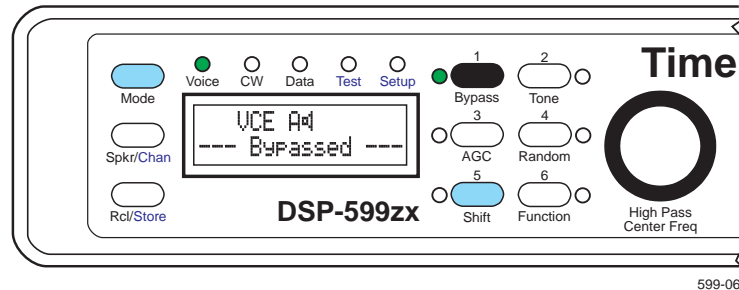

Depressing [**Bypass**] places the DSP-599zx into a bypass mode. In this mode, a relay connects the audio input jacks of the DSP-599zx directly to the speaker, line, and headphone output jacks. The **Bypass** mode has precedence over the voice mode. When the DSP-599zx is in bypass, the settings of the all other controls do not affect the signal.

Bypass respects the status of the speaker switch. If the speaker is turned off, bypass leaves it off. The speaker will always, however, come on when power is turned off on the DSP-599zx.

Setup - Voice

There is one user adjustable variable within this mode of setup.

1. Press [**Shift+Mode**] twice to enter Setup mode.
2. Rotate **left knob** until **Voice** appears on the bottom line of the display
3. Press the **left knob** to select.

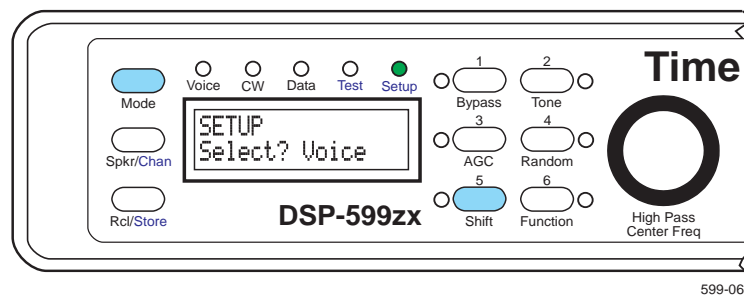

AM Line Noise

To make the AM Line Noise filter most effective, you need to set it to the local power frequency. The selections are 50 Hz and 60 Hz.

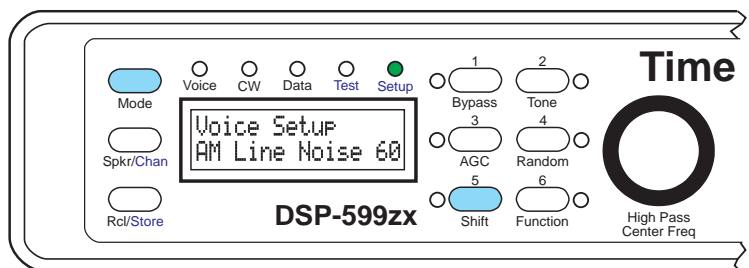

4. Rotate **left knob** until AM Line Noise appears on the bottom left of the display
5. Press the **left knob** to select.
6. Rotate **left knob** until the chosen value appears on the bottom right of the display
7. Press the **left knob** to accept choice and save. Press **middle knob** to escape without saving changes.
8. Rotate **left knob** until your next function to change appears on the bottom line of the display or press the **middle knob** to return to main set-up menu

Exit Setup

When you are through with Setup, press **[Mode]** to return to Voice mode.

5

CW Mode

Operation

The CW Mode digitally processes analog CW (Continuous Wave) signals for Morse code reception. Independently selectable processing techniques include noise reduction, tunable bandpass filtering and automatic gain control.

Bandpass Filters

A narrow band signal like CW and RTTY requires bandpass filters with steep skirts and linear phase response. Linear phase response maximizes the usable signaling rate for a given bandwidth and minimizes ringing often heard on other types of extremely sharp filters. The filter skirts on the CW filters are so steep that a signal literally falls off the edge of the passband as you tune through a CW signal.

- Bandwidths range from 10 Hz to 600 Hz.
- Center frequencies from 200 to 2100 Hz.

The narrow filters are useful for trying to dig out extremely weak signals from the noise and QRM. The wider filters allow easy tuning and listening to multiple CW signals simultaneously.

In the CW Bandpass mode, the DSP-599zx tailors the audio input using tunable bandpass filtering, adaptive random noise reduction, and manual notch filtering. These functions can operate simultaneously or independently. The DSP-599zx also provides a marker tone at the center frequency of the selected CW bandpass filter.

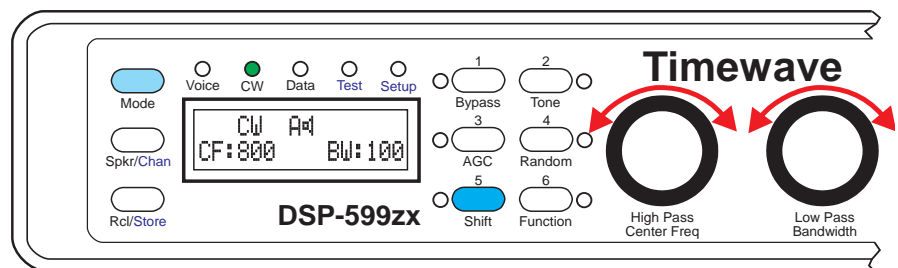

599-095

- Turn **[Center Freq]** to the desired bandpass center frequency indicated on the lower left side of the display.
- Turn **[Bandwidth]** to the desired bandwidth noting the bandwidth indicated displayed on the bottom right side of the display.

Noise Reduction

To activate random noise reduction, press **[Random]**. The LED next to the button lights when the feature is activated.

CW Operating Hint

The extremely narrow linear phase filters in the DSP-599zx will allow you to copy very weak and closely spaced CW signals. Use 10 to 100 Hz bandwidths, but tune very slowly. Since many radios are difficult to tune slowly, use the bandpass center frequency control to help pick out the weak and closely spaced signals. If you want to change your receive frequency, the RIT or Clarifier controls on some receivers allow very fine tuning. If you have little interest in working very weak signals, tune with the bandwidth set at 150 to 600 Hz and decrease the bandwidth further only if you need to eliminate QRM. Use the 10 to 25 Hz bandwidths if you are trying to copy a very slow CW signal (10 words per minute or less). EME (Moonbounce) is a typical application for the 10 to 25 Hz filters. Random noise reduction (Random) is especially helpful when listening to CW in the 400-600 Hz bandwidth.

Use the **[Random]** and **[AGC]** combination to boost the level of very weak CW signals when your receiver is at maximum gain. Some CW signals seem to magically pop out of the noise.

Manual Notch Filter

The manually tuned notch filter is equally effective in reducing the interfering signal levels, but may be used to eliminate a single heterodyne, CW or data signal in Voice and CW modes.

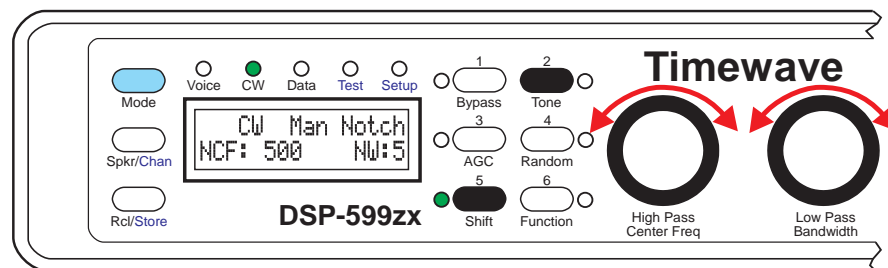

- Activate the manual notch function by pressing **[Shift+Tone]**.
- Rotate the left knob **[Center Freq]** to change the notch center frequency (NCF) of the filter in 10 Hz steps.
- Rotate the middle knob **[Bandwidth]** to adjust the notch bandwidth (NW). The lower the value, the narrower the filter.
- After tuning the filter to the desired center frequency and adjusting the bandwidth, push the momentary switch built into the left knob.

The display changes back to the original operating mode with a  icon in the upper right corner of the display indicating that the manually tuned notch filter is active.

- Turn off the manual notch filter mode by pressing **[Shift+Tone]** or pushing the momentary switch built into the middle knob.

CW Marker Tone

- To activate the marker tone for CW, press **[Tone]**.

The DSP-599zx generates an audio tone at the bandpass filter center frequency. Use the marker to center a wide bandpass filter (300 - 600 Hz) on a signal by matching the marker tone pitch to signal pitch by ear. The tone can be set to within 2.5 Hz of any frequency from 200 Hz to 2150 Hz. Then reduce the bandwidth of the bandpass filter as narrow as required. The desired signal will not be “lost” outside the passband of the filter.

CW Tone Pitch Shift

A feature unique to the DSP-599zx is the ability to easily shift the CW tone pitch to another frequency. This feature works well with receivers that have non-adjustable, relatively high pitch CW tone, since most hams prefer to listen to 400 - 600 Hz CW tones.

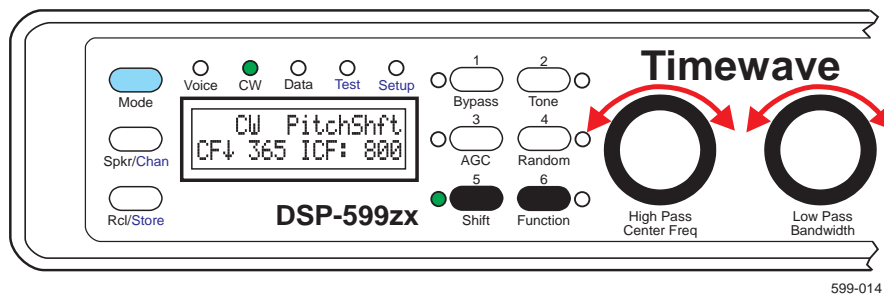

- Press **[Shift+Function]** to enable CW Pitch shift.
- Rotate the left knob **[Center Freq]** to shift the output CW pitch that you hear. As soon as you start turning the knob, you will notice that an up/down arrow will replace the colon following C:F.
- Rotate the middle knob **[Bandwidth]** to shift the input CW pitch from the radio.

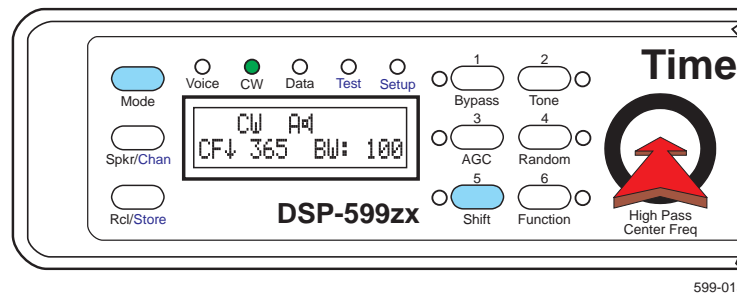

- Press **[Shift+Function]** or the **left knob** to switch back to standard operating mode.

The LCD will change to display the input center frequency (ICF) and the final center frequency (CF) that the user will hear.

Let's use for example a Kenwood transceiver with an 800 Hz CW pitch and we would like to change it to 365 Hz.

1. Press **[Shift+Function]**.
2. Rotate the middle knob **[Bandwidth]** to display ICF: 800 (the input CW pitch from the radio).
3. Rotate the left knob **[Center Frequency]** to display CF↓ 365 (the output CW pitch you want to hear).
4. Press **[Shift+Function]** or the left knob to switch back to standard operating mode.

The colon after CF has been replaced with a arrow indicating that you have programmed in a pitch shift and it is up or down. The CW pitch shift will remain the same until it is reprogrammed to a new frequency with the above procedure or deactivated.

- To remove the pitch shift, press **[Shift+Function]**. Then press middle knob to deactivate.

CW Bypass Mode

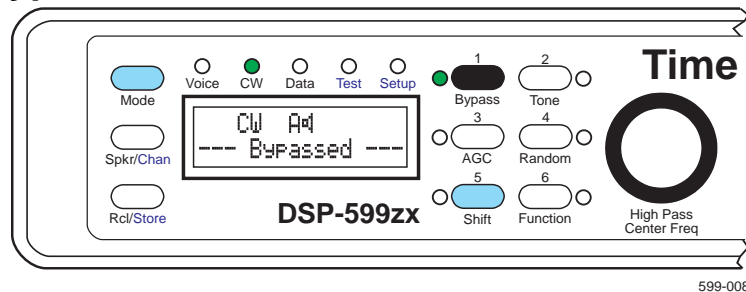

Press **[Bypass]** to place the DSP-599zx into a bypass mode. In this mode, a relay connects the audio input jacks of the DSP-599zx directly to the speaker, line, and headphone output jacks. The **Bypass** mode has precedence over the CW mode. When the DSP-599zx is in bypass, the settings of the all other controls do not affect the signal.

Bypass respects the status of the speaker switch. If the speaker is turned off, bypass leaves it off. The speaker will always, however, come on when power is turned off on the DSP-599zx. Turning off or removing power from the DSP-599zx automatically de-energizes the relay and forces the DSP-599zx into the bypass mode.

Setup - CW

There is one user adjustable variable within this mode of setup.

1. Press **[Shift+Mode]** twice to enter Setup mode.
2. Rotate **left knob** until **CW** appears on the bottom line of the display
3. Press the **left knob** to select.

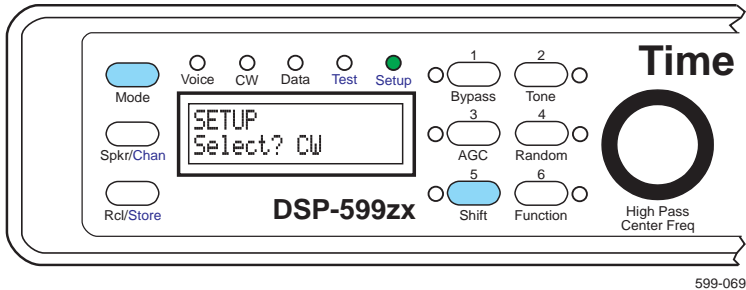

Marker Tone Level

You can adjust the volume of the CW Marker Tone. This allows you to set the tone level to approximately match the level of the incoming CW tones. The range is from 0 dB to -36 dB in 3 dB steps.

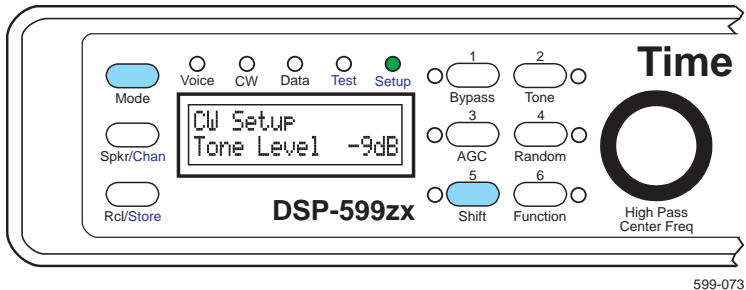

1. Rotate **left knob** until **Tone Level** appears on the bottom left of the display
2. Press the **left knob** to select.
3. Rotate **left knob** until the chosen value appears on the bottom right of the display
4. Press the **left knob** to accept choice and save.
5. Rotate **left knob** until your next function to change appears on the bottom line of the display or press the **middle knob** to return to main set-up menu.

Exit Setup

When you are through with Setup, press **[Mode]** to return to Voice mode.

6

Data Mode

Introduction

Data signals like CW and RTTY require bandpass filters with steep skirts and linear phase response. Linear phase response maximizes the usable signaling rate for a given bandwidth. The baud rate, center frequency and frequency shift of a data signal determine the bandwidth of filter for that data signal. In the Data Filter mode, the DSP-599zx has an array of band-pass filters optimized for the most common high frequency (1.8-30 MHz) data modes.

The DSP-599zx also has a built in RTTY modem. The RTTY modem demodulates received RTTY audio tones and generates audio frequency shift keyed signals.

A third option within Data mode is the RTTY remodulator mode. This is a special receiving mode that regenerates the data tones to send them to an external modem.

Configuration of the RTTY modem is done as part of Setup - Data. You can choose to have channel A line output function as a the RTTY modem output or have channel B function as the RTTY modem output.

The RTTY remodulator is selected by pressing the **[Function]** key.

Operations Common To All Data Types

Basic Data Mode Operation

- Pressing **[Mode]** to select the Data mode.
- Turn the **left knob** to select the appropriate data filters.
- Turn the **middle knob** slightly to vary the filter bandwidth to suit the band conditions.

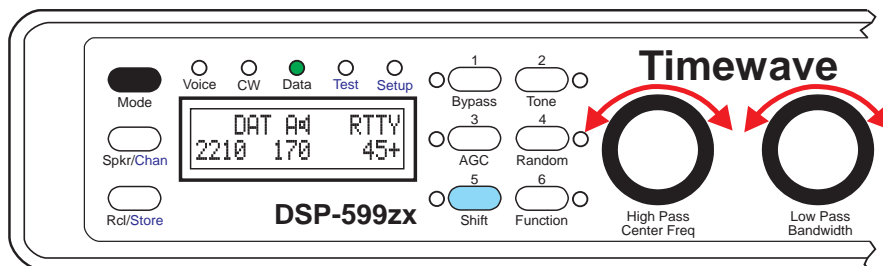

599-056

Data Settings Display

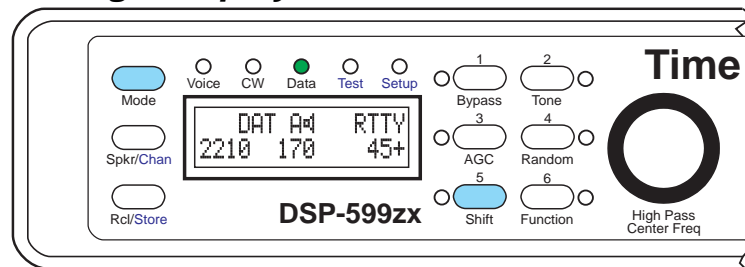

599-029

- DAT (Data filter) - Top left line
- Channel and speaker status - Top middle line
- Data signal type- right, top line
- Modulation center frequency - left, bottom line
- Total frequency shift, - center, bottom line
- Baud rate - right, bottom line.
- A + or - in the bottom right corner of the display indicates the new bandwidth is either greater than or less than the setup bandwidth.

Data Tuning Function

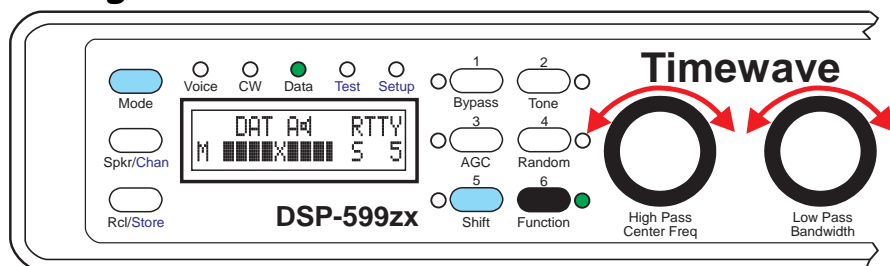

599-057

- Press **[Mode]** to select the Data mode.
- Turn the **left knob** to select appropriate data filter.
- Press **[Shift+Function]** to turn the FSK(AFSK) tuning display on.
- Tune in a FSK data signal on the receiver connected to the DSP-599zx.
- Adjust the receiver frequency so that the Mark and Space bars on the display are approximately equal length.
- Press **[Function]** to switch the middle knob from **[Bandwidth]** to **[DCD]** (Data Carrier Detect).
- Turn middle knob **[DCD]** for clean error-free copy on your terminal display.
- The DCD setting, with a range of 1 - 9, is displayed on the lower right corner of the display. When a data carrier is detected that exceeds the DCD setting, an asterisk (*) is displayed next to the DC setting.
- TX is displayed when the terminal program is switched to transmit.

Random Noise Reduction

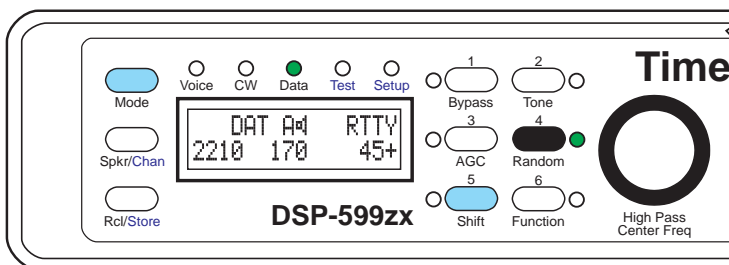

599-058

The random noise reduction mode was not designed for data signals, but Timewave DSP users have found it helpful under some conditions. Generally, do not use the **Random** mode for data. If noise conditions are severe, and you have tried other filter combinations, then try the **Random** mode. To activate random noise reduction, press **[Random]**.

Data Bypass Mode

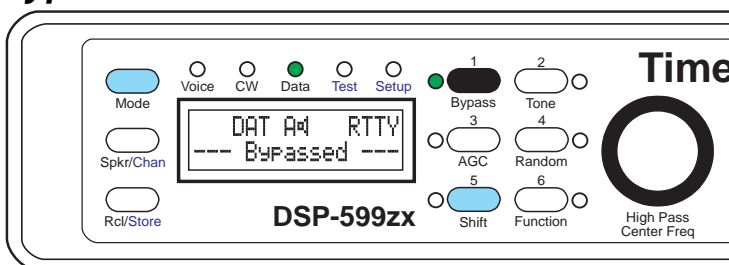

599-059

Pressing **[Bypass]** places the DSP-599zx into an electronic bypass mode. In the data mode, the bypass mode routes the signal through an allpass DSP filter which has precisely the same delay as the normal narrow band filter. When switching from data mode to bypass mode, this prevents a time discontinuity that can cause an AMTOR or PacTOR link to lose synchronization. The bypass mode has precedence over the Data mode. When the DSP-599zx is in bypass, the settings of the gain control and the parameter select push buttons do not affect the signal.

- Bypass respects the status of the speaker switch. If the speaker is turned off, bypass leaves it off. The speaker will always, however, come on when power is turned off on the DSP-599zx. Turning off or removing power from the DSP-599zx automatically de-energizes the bypass relay and forces the DSP-599zx into the relay bypass mode.

Data Filter Mode

The Data Filter mode choices appear sequentially on the display. The table below lists the filter choices. (Use Setup to limit the number of choices to those actually used - see Setup - Data.) The following table lists the factory default values for each filter mode. Most can be modified or disabled within data setup.

	Center Freq.	Freq. Shift	Baud Rate	Comments
RTTY	2210	170	45	•
RTTY 2	2210	200	45	•
AMTOR	2210	200	100	Same filters as SITOR
PacTOR	2210	200	200*	*100/200 - adaptive
G-TOR	2210	170	300*	*100/200/300 - adaptive
HF Packet	1700	200	300	PK-232 = 2210 Hz. CF
WeFAX	Fixed	Fixed	Fixed	HF only, filter only
SSTV	Fixed	Fixed	Fixed	Filter only
CLOVER	Fixed	Fixed	Fixed	Filter only
RTTY S	2210	170	75	Common shortwave RTTY parameters
RTTY 4	1275*	1700*	45	425 Hz shift. * = Mark/Space freq.
RTTY 8	1275*	2125*	45	850 Hz shift * = Mark/Space freq.
SITOR	2210	200	100	Same filters as AMTOR
USR 1	2210*	170*	45*	* = User Programmable
USR 2	2210*	170*	45*	* = User Programmable
USR 3	2210*	170*	45*	* = User Programmable

RTTY, AMTOR, SITOR, PacTOR, G-TOR

Normal operation for RTTY, AMTOR, SITOR, PacTOR and G-TOR uses a 2210 Hz center frequency filter in the USA. A 1360 Hz center frequency is common in Europe. The defaults used in your DSP-599zx can be chosen from within Setup - Install.

HF Packet

HF packet modems are usually centered at 1700 Hz or 2210 Hz, depending upon the modem manufacturer. Kantronics' Kam+ is factory set to 1700 Hz center frequency and 200 Hz frequency shift. AEA's PK-232 is factory set to 2210 Hz center frequency and 200 Hz frequency shift.

CLOVER

CLOVER is a DSP-based mode and theoretically should not benefit from additional filtering. However, Timewave DSP users report some benefit from using a 500 to 600 Hz bandwidth filter.

SSTV and WeFAX

These two modes use individual fixed bandpass filters specifically designed for the each mode. Pressing **[Tone]** has no effect on the SSTV and WeFAX filters.

RTTY FSK Test Signals

Press **[Tone]** while in a non burst Data mode at 75 baud or less activates a sync nul (diddle) test tone. The sync nul test tone may sound different than what you may be used to. It has been padded with extra stop bits to equalize the mark and space energies. It functions identical to what most consider "normal."

If the baud rate is 100 baud or higher, pressing **[Tone]** activates a space mark reference calibration tone that toggles at the specified baud rate. It is not a standard ASCII character.

Pressing **[Shift+Tone]** while in the **Data** RTTY mode at 75 baud or less inserts an "RYRY" audio FSK test signal into the receive channel. The "RYRY" test signal center frequency, frequency shift, and baud rate is determined by the RTTY parameter settings. The level of marker tone is adjustable relative to the processed receive signal. If the baud rate is 100 baud or higher, nothing happens when **[Shift+Tone]** is pressed.

Wideband Data Operating Hint

The DSP-599zx can simulate almost any filter necessary for wideband data signals. If you know the upper and lower audio frequency limits of the signal you are using, simply set the Highpass and Lowpass filters to pass those frequencies. The linear phase response and steep skirts of DSP-599zx will help reject QRM and improve S/N ratio. If you don't know the frequency limits, tune in a strong signal with the Highpass and Lowpass filters set to 300 Hz and 2.7 kHz. Then tighten up the filters until the copy from the signal begins to degrade. Then back off the filters until the copy is acceptable. Store these highpass and lowpass settings in a memory location or record them so that you can use them when you operate that mode again. You will have optimum QRM rejection and the best signal-to-noise ratio.

RTTY Modem Operation

The RTTY modem both demodulates received RTTY audio tones and generates AFSK and AFSK signals.

The modem is operational whenever you are in one of the RTTY modes. You need, however, to have a computer connected to the RS-232 port on the DSP-599zx and have appropriate software terminal program that can decode and encode Baudot and ASCII. Timewave does not provide the terminal program. You will also need to make appropriate cables to connect from the DIN connector to your transceiver. Consult your transceiver user manual for specific information.

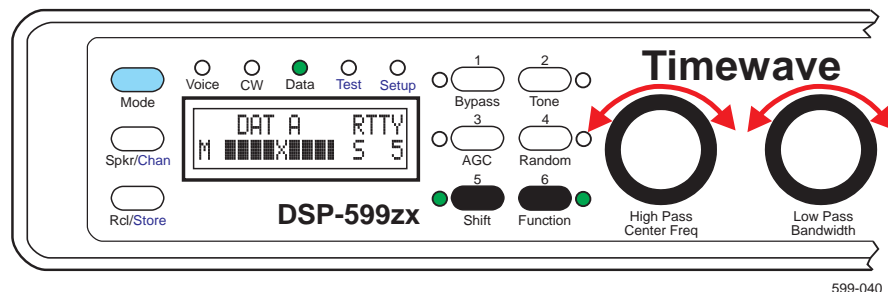

599-040

- Press **[Mode]** to select the Data mode.
- Turn the **left knob** to select one of the RTTY filters.
- Press **[Shift+Function]** to turn the tuning display on.
- Tune in a RTTY signal on the receiver connected to the DSP-599zx.
- Adjust the receiver frequency so that the Mark and Space bars on the display are approximately equal length.
- Press **[Function]** to switch the middle knob from **[Bandwidth]** to **[DCD]** (Data Carrier Detect).
- Turn middle knob **[DCD]** for clean error-free copy on your terminal display.
- The DCD setting, with a range of 1 - 9, is displayed on the lower right corner of the display. When a data carrier is detected that exceeds the DCD setting, an asterisk (*) is displayed next to the DC setting.
- TX is displayed when the terminal program is switched to transmit.



Power your computer on first.

When your have a computer connected to the DSP-599zx, take care to turn the power on for the computer first. Then turn on the DSP-599zx. Under some circumstances, the DSP-599zx will power up in transmit mode keying your transmitter if the computer power is turned on last.

The AFSK output signal from the line output jack and pin 1 of the DIN connector on the DSP-599zx can drive the microphone input or AFSK input on a transceiver. Do not over-drive your transceiver. It prevents you from mak-

ing clean contacts and generates QRM for everyone else. Carefully follow your transceiver or transmitter instructions for input drive level. See DSP-599zx *Installation - Line Output Signal Level Setup* (page 2-12) for instructions on setting DSP-599zx line output level.

The FSK output signal from pin 5 on the DIN connector on the DSP 599zx can directly drive a FSK input on a transceiver. See *Installation - RTTY Modem Input/Output* (page 2-10) for more information on connections.

The RTTY modem has signal decoding; it modulates and demodulates only! A computer with a terminal program is required to use the RTTY modem. Timewave does not supply the terminal program.

RTTY Remodulator Operation

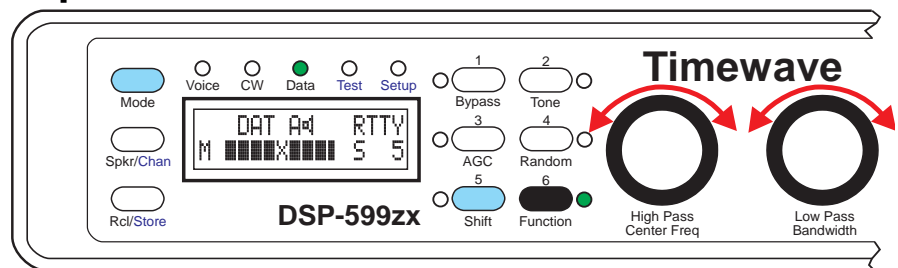

599-057

The RTTY remodulator is a special mode for receiving RTTY. Its function varies slightly depending upon if you are using the DSP-599zx internal RTTY modem or using an external multimode controller:

- Press **[Mode]** to select the Data mode.
- Turn the **left knob** to select the appropriate RTTY data filters.
- Press **[Function]** to select the remodulator.
- The **middle knob** now adjusts the DCD threshold.

The LED illuminated next to the **[Function]** button indicates the RTTY remodulator is selected. The DSP-599zx filters and demodulates the received RTTY signal. Then The DSP-599zx generates a new set of RTTY tones that are modulated by the output of the RTTY demodulator.

The incoming signal is sent to the speaker/headphone and the remodulated signal is sent through the line output. Only the pure audio RTTY tones are sent to your multimode controller. You still need to monitor the incoming signal for quality. You still need to be tuned in and may need to adjust bandwidth.

When using the RTTY modem the process is similar. Pressing **[Function]**, however only toggles the **middle knob** between **[Bandwidth]** and **[DCD]** threshold.

Data Operating Hints

Data Primer

RTTY, AMTOR, SITOR, PacTOR, G-TOR and HF Packet all use Frequency Shift Keying (FSK). FSK is also called AFSK Audio Frequency Shift Keying when frequency shifted audio tones are used to modulate a transmitter.

A FSK signal is produced when the frequency shift audio is generated by circuitry within the radio. AFSK signals are generated when the audio containing the shifting frequency comes from outside the radio. A common example of this is a TNC connected to a radio through the microphone input. Our RTTY modem supports both forms. See your transceiver owners manual for specific information.

There are three important parameters used to describe an FSK or AFSK signal -- the frequency shift, the center frequency, and the keying or baud rate. The combination of frequency shift and baud rate determine the spectrum of the FSK signal. The goal of a filter is to reject everything in the spectrum except the desired signal while minimizing the degradation of the desired signal.

Frequency shift

You may specify the frequency shift in one of two ways. The most common specification in amateur radio is total shift or the difference between the low (Mark) and high (Space) tones. In the technical literature, the shift from a center frequency is more commonly specified. For example, a 170 Hz shift RTTY signal is the same as a +/- 85 Hz shift. Note the frequency shift remains the same whether it is shifting an RF signal or an audio frequency signal. In amateur radio, there are only two common frequency shifts - 170 Hz and 200 Hz. Other radio services use 425 Hz and 850 Hz shifts. 170 Hz is the standard RTTY and G-TOR frequency shift, while 200 Hz is the standard for AMTOR, SITOR and PacTOR. Unfortunately, some data converters use 200 Hz shift for RTTY, which adds to the problem of properly filtering data signals.

Center Frequency

The center frequency of a FSK signal is independent of the frequency shift or the baud rate. In the audio spectrum, either before an AFSK signal modulates a RF signal or after the RF FSK signal is demodulated, there are several common center frequencies. In the North America, 2210 Hz is the standard center frequency for RTTY, PacTOR, AMTOR, SITOR, and G-TOR, while both 1700 Hz and 2210 Hz share the standard for HF packet. In Europe and some other parts of the world, lower center frequencies of 1300, 1360 and 1530 Hz are more common.

Baud Rate

Baud rates vary from 45.5 baud for RTTY to 300 baud for HF packet. G-TOR, PacTOR, and Clover have adaptive baud rates which change depending upon the quality of the channel.

For a more complete discussion of data modes, see the latest edition of the *ARRL Handbook*.

QRM Operating Hint

Choosing the correct bandwidth for the baud rate and shift of a data signal is critical to reject QRM while minimizing the bit error rate from noise. If there is no QRM, wide bandwidths may be acceptable on a strong signal, but could cause increased bit errors on a weak signal. The factory default settings are the generally the best trade-off between bit error rate and QRM rejection. If necessary, change them slightly under severe band conditions. For example, normally 250 Hz is the recommended bandwidth for RTTY; however, other bandwidths from 175 Hz to 350 Hz may improve copy under some band conditions.

Mark Space Frequencies

The mark-space frequencies of the modem, receiver and DSP-599zx must match. Default mark-space frequency shifts and center frequencies vary among modem and radio manufacturers, and in different parts of the world. Some modems have default HF Packet mark-space center frequencies different from their RTTY, AMTOR, and PacTOR mark-space center frequencies.

The DSP-599zx mark-space center frequency factory setting is 2210 Hz for RTTY, AMTOR, G-TOR and PacTOR data modes. The DSP-599zx HF Packet mark-space center frequency factory setting is 1700 Hz. The mark-space center frequencies of the modem, receiver and DSP-599zx must match. Some modems and radios have programmable mark-space frequencies. If your modem and radio default to different mark-space center frequencies, you must change the modem or radio mark-space center frequencies to match the DSP-599zx, or change the DSP-599zx mark-space center frequencies to match the modem and radio mark-space center frequencies. See your radio or modem instruction manual.

Note that some receivers do not have specific provisions to use their narrow (200 - 600 Hz wide) filters for data. Operate these radios in their SSB voice filter bandwidth. Other receivers may have fixed or variable mark-space frequencies - check your operating instructions carefully!

The Kantronics KAM+ usually has the HF Packet mark-space center frequency set to 1700 Hz (1600-1800 Hz mark-space frequencies). See the KAM+ manual for the procedure to change the KAM+ mark-space center frequency setting via software.

Setup - Data Mode

1. Press **[Shift+Mode]** twice to enter Setup mode.
2. Rotate **left knob** until **Data** appears on the bottom line of the display
3. Press the **left knob** to select.

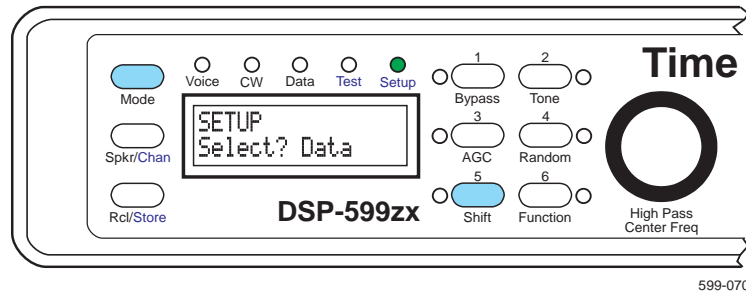

599-070

Speaker Mute/Bypass

You can adjust the transmit speaker volume of the data signal. This allows you to set the audio level of the transmitted signal from off the full volume when compared to incoming data signals. This is something of personal preference. The range is from 0 dB to -24 dB in 3 dB steps and off. The factory default value is off.

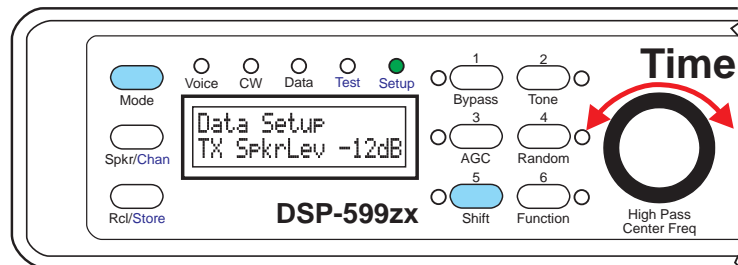

599-092

1. Press **[Shift+Mode]** twice to enter Setup mode.
2. Rotate **left knob** until **Data** appears on the bottom line of the display
3. Press the **left knob** to select.
4. Rotate **left knob** until **TX SpkrLev** appears on the bottom left of the display
5. Press the **left knob** to select.
6. Rotate **left knob** until the chosen value appears on the bottom right of the display
7. Press the **left knob** to accept choice and save. Press **middle knob** to escape without saving changes.
8. Rotate **left knob** until your next function to change appears on the bottom line of the display or press the **middle knob** to return to main set-up menu.

Modem Assignment

You can select which output channel will be used for the internal RTTY Modem. This does not affect any other operating mode. You can select to send RTTY Modem signals to A, B, or A&B. You may also select to turn it off. The factory default is A&B.

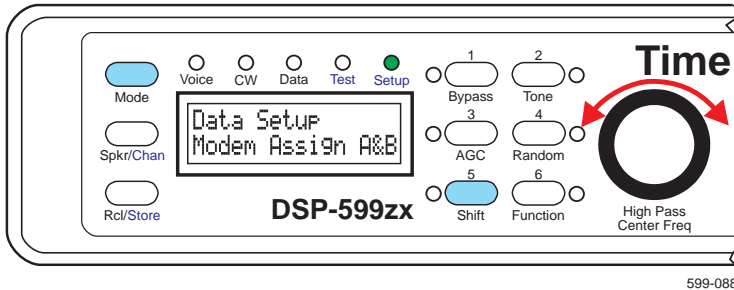

1. Press **[Shift+Mode]** twice to enter Setup mode.
2. Rotate **left knob** until **Data** appears on the bottom line of the display
3. Press the **left knob** to select.
4. Rotate **left knob** until **Modem Assign** appears on the bottom left of the display.
5. Press the **left knob** to select.
6. Rotate **left knob** until the chosen value appears on the bottom right of the display Your choices are **A**, **B**, or **A&B**.
7. Press the **left knob** to accept choice and save. Press **middle knob** to escape without saving changes.
8. Rotate **left knob** until your next function to change appears on the bottom line of the display or press the **middle knob** to return to main set-up menu.

FSK Mark Control

With some transceivers, the normal configuration for Mark within the FSK signal be reversed and not adjustable. Standard convention is for Mark to be at the lower frequency. Channel A and B are separately configurable. Your choices are Normal (**Nor**) or Reverse (**Rev**). The factory default is Normal.

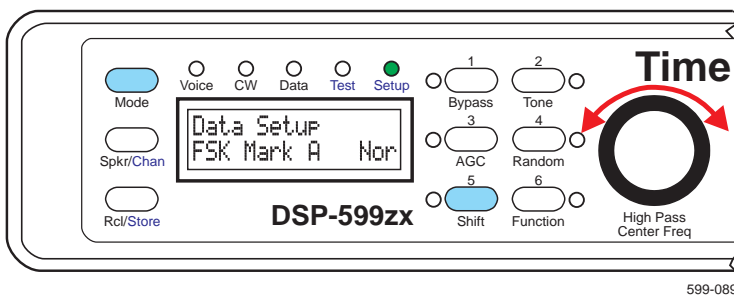

1. Press **[Shift+Mode]** twice to enter Setup mode.
2. Rotate **left knob** until **Data** appears on the bottom line of the display
3. Press the **left knob** to select.
4. Rotate **left knob** until **FSK Mark F** (or **E**) appears on the bottom left of the display
5. Press the **left knob** to select.
6. Rotate **left knob** until the chosen value appears on the bottom right of the display
7. Press the **left knob** to accept choice and save. Press **middle knob** to escape without saving changes.
8. Rotate **left knob** until your next function to change appears on the bottom line of the display or press the **middle knob** to return to main set-up menu.

Configuring Data Operating Modes

You can adjust the parameters for many of the data operating modes. For all data modes, you can turn access on or off. Selecting **On** will list the data operating mode as a choice while in Data Mode. The status is displayed in the upper right corner of the display. Selecting **Off** will remove the data operating mode from the menu while in data mode.

For the data operating modes that have user configurable information you can configure the following:

- Mark/Space Center Frequency
- Mark/Space Shift Frequency
- Baud Rate
- Bandwidth

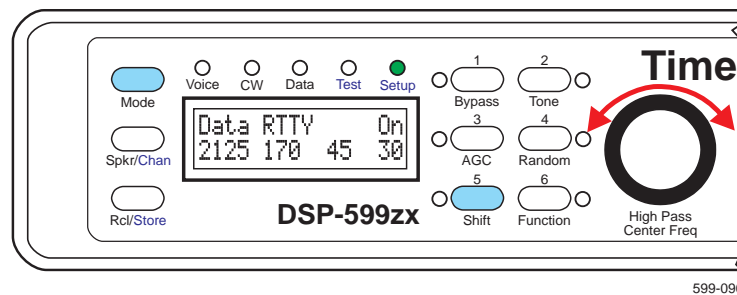

The four configurable values are displayed across the bottom of the display. From the left, the first number is the mark frequency. The second is the shift frequency. The third is the baud rate. The fourth is the bandwidth.

The **space frequency** is calculated by adding the mark frequency and the shift frequency. The range for the mark center frequency is 1200 - 2150 Hz in 5 Hz steps. The space center frequency can be no greater than 2350 Hz.

The choices for **frequency shift** are 170, 200, 425, and 850 Hz.

Baud rate choices are 45, 50, 57, 75, 100, 110, 150, 200, and 300 baud.

Bandwidth is adjustable in 5 Hz steps through a range from 20 - 600 Hz. Optimal bandwidth approximately equals the baud rate multiplied by 0.75. For example: If the baud rate is 100, the optional bandwidth would be 75 Hz. If the baud rate is 75 baud, the optional bandwidth would be 55 Hz.

1. Press **[Shift+Mode]** twice to enter Setup mode.
2. Rotate **left knob** until **Data** appears on the bottom line of the display
3. Press the **left knob** to select.
4. Rotate **left knob** until **Datamode?** appears on the bottom left of the display
5. Press the **left knob** to select.

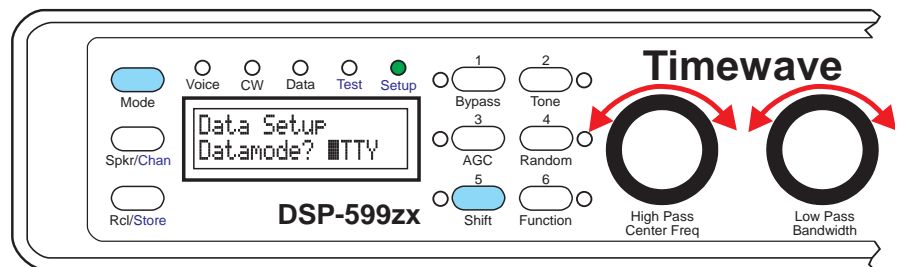

599-093

6. Rotate **left knob** until the desired data operating mode appears on the bottom right of the display
7. Press the **left knob** to select.

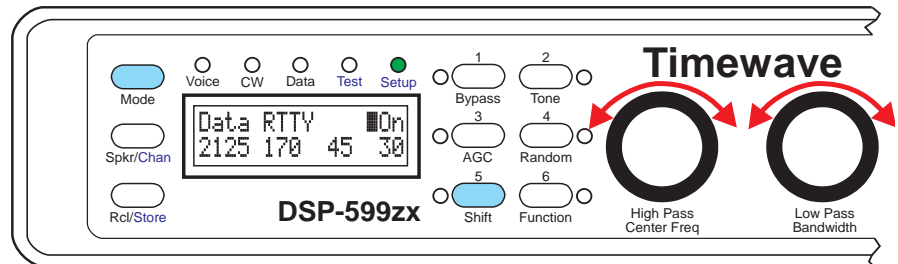

599-094

8. Rotate the **middle knob** until the flashing cursor appears on the first character of the parameter you would like to change. Rotate **left knob** until correct value appears.
9. Rotate the **middle knob** gain until the flashing cursor appears on the first character of the next parameter you would like to change. Rotate **left knob** until correct value appears.
10. When done, press the **left knob** to accept choice and save. Press **middle knob** to escape without saving changes.

11. Rotate **left knob** until your next function to change appears on the bottom line of the display or press the **middle knob** to return to main set-up menu.

Exit Setup

When you are through with Setup, press **[Mode]** to return to Voice mode.

7

Test Instrument Operation

The Test Instrument mode helps analyze signals and other equipment. It includes an audio millivoltmeter, an audio sine wave signal generator, a two-tone generator, and a CTCSS tone encoder/decoder. Test Instrument functions operate on either **A** or **B** channel. The speaker may be switched on or off without affecting the Test Instrument functions.

Exiting from Test Instrument functions can be accomplished two different ways.

- Pressing **[Mode]** completely exits you from Test Instrument mode and returns you to Voice mode.
- Pressing the **middle knob** escapes you back to the Test Instrument function menu. You can then choose a different test function. You can then select a new test function. Pressing the **middle knob** again will put you back into Voice mode.

Audio Millivoltmeter

This mode measures audio voltage levels from other equipment including microphones, TNCs, multimode controllers, and receivers. Measurements include both peak and true RMS millivolts. Frequency response ranges from 10 Hz to 10 kHz.

The audio millivoltmeter has many applications in installation, maintenance, and operation of radio and audio equipment. In EME work, the audio millivoltmeter is useful in antenna evaluation when comparing sun noise and cold sky noise. In VHF/UHF FM work, the audio millivoltmeter's peak reading capabilities allow relative measurement of peak frequency deviation of received voice, data and control signals. When used with the CTCSS function of the DSP-599zx, the audio millivoltmeter allows relative measurement of frequency deviation of CTCSS tones received UHF and VHF FM/PM signals.

The audio millivoltmeter displays the voltage of the audio input signal for the selected channel. Audio millivoltmeter functions include true RMS voltage and peak voltage. The millivoltmeter display is also active in the sine wave, and two-tone modes.

Operation

To use the AC millivoltmeter for general purposes, select sine wave or two tone mode and do not turn the tone on.

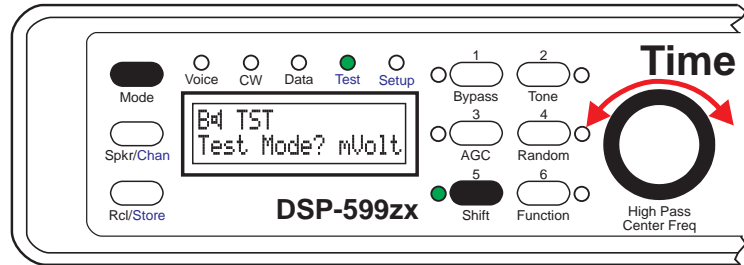

599-080

- Press **[Shift+Mode]** to enter the Test Instrument mode.
- Turn the **left knob** to **mVOLT**.
- Press the **left knob** to enter the chosen mode.

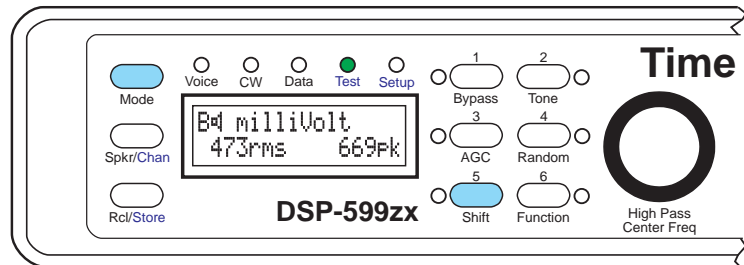

599-081

- The selected channel input voltage is displayed in the lower left of the display in mVrms and as mVpk in the lower right corner of the display. The DSP-599zx can measure and display up to 2000mV.
- Press **[Function]** to select input signal amplitude units - **mVrms** or **mVpk**.
- The channel **B** input impedance is factory-set to 20k ohms. Channel **A** is factory-set to 25 ohms. See page 2-4 for setup information changing input impedance.
- Press **[Spkr]** to turn the speaker on to listen to the input signal on the selected channel.
- Press **[Mode]** to exit Test Instrument mode. Press the **middle knob** to escape back to the test function menu.



Maximum input level is 2000 millivolts rms.

Do not attempt to measure any voltage above 2000 millivolts, especially 115 Vac or 220 Vac power line voltage! You will damage the DSP-599zx! All warranties will be void!

Sine Wave Generator

This mode produces a tunable low-distortion, precision frequency sine wave test signal from 20 Hz to 10 kHz in 20 Hz steps. Output signal voltage is adjustable from 5-50 mV in 1 mV steps and from 50-500 mV in 10 mV steps. The operator may use the precision test signal for calibration and/or trouble shooting of other equipment. The display shows the frequency and amplitude of the output signal from the line output.

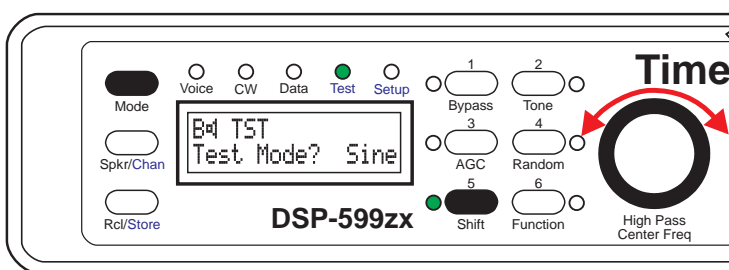

599-044

- Press **[Shift+Mode]** to enter the Test Instrument mode.
- Turn the **left knob** to **Sine**
- Press the **left knob** to select the sine wave generator

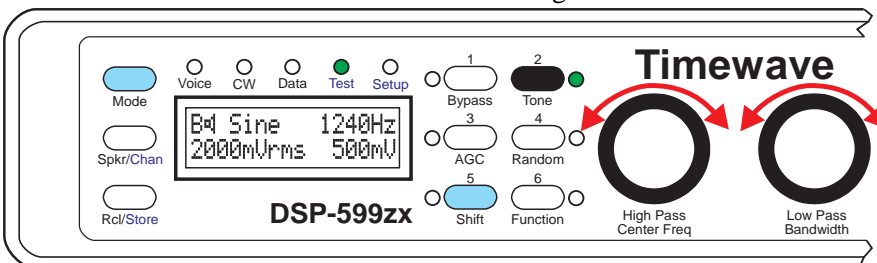

599-046

- Press **[Tone]** to start generator.
- Turn **left knob** to set frequency.
- Press **[Function]** to select input signal amplitude units - **mVrms** or **mVpk**.
- Turn **middle knob** to set output amplitude (shown on lower right of display).
- Press **[Tone]** again to turn off generator.

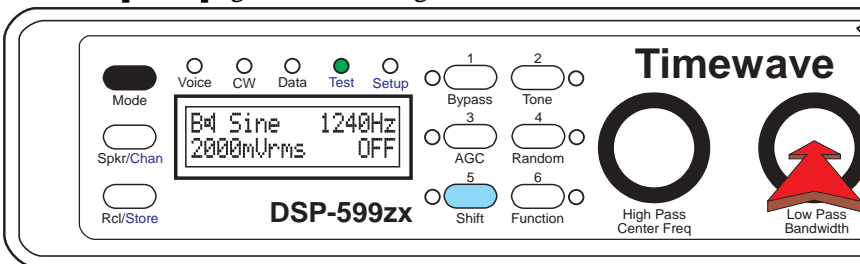

599-055

- Press **[Mode]** to exit Test Instrument mode. Press the **middle knob** to escape back to the test function menu.

Two-Tone Generator (Version 4.0 firmware only)

This mode produces two low-distortion, precision-frequency sine wave signals at 700 Hz and 1900 Hz. Output signal voltage is adjustable from 5-50 mV in 1 mV steps and from 50-250 mV in 10 mV steps. Two-tone signals are used for SSB transmitter linearity testing. Please read the latest edition of the *ARRL Handbook* for additional information on SSB two-tone testing. The display shows the frequencies of both tones and the amplitude of the two-tone output signal from the line output. The amplitudes of the two tones are identical and they track when adjusted.

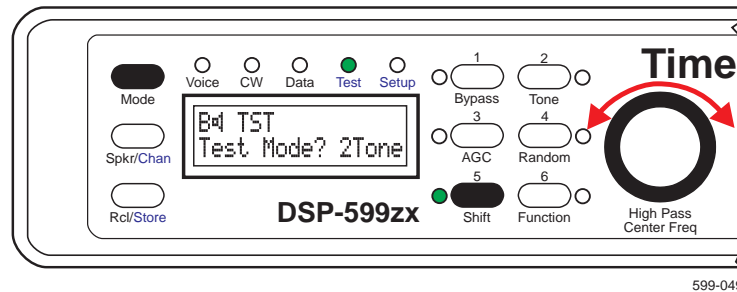

599-049

- Press **[Shift+Mode]** to enter the Test Instrument mode.
- Turn the **left knob** to **2Tone**.
- Press **left knob** to select the two-tone generator.

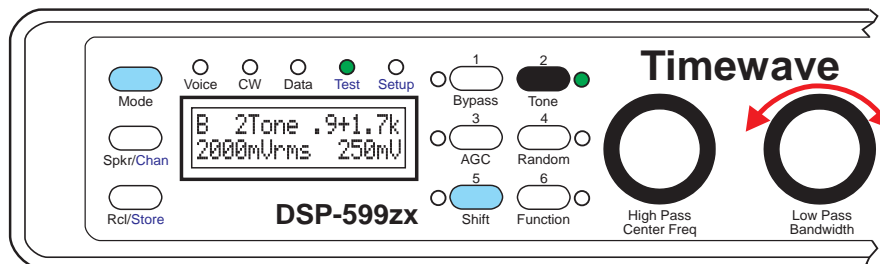

599-047

- Press **[Tone]** to Tone to turn on generator.
- Turn the **middle knob** to set amplitude (shown on lower right of display).
- Press **[Tone]** again to stop generator.
- Press **[Mode]** to exit Test Instrument mode. Press the **middle knob** to escape back to the test function menu.

CTCSS Decoder (Version 4 Firmware only)

The DSP-599zx has a CTCSS tone encoder and decoder built into the Test Instrument mode. The decoder can operate in an CTCSS autodetect mode or in a tone squelch mode. The autodetect mode automatically displays the frequency and amplitude of the incoming CTCSS tone. This allows relative measurement of peak deviation of CTCSS tones for UHF and VHF FM/PM transmitters. The tone squelch mode can detect a selected CTCSS tone and activate a switch output on DSP-599zx as well as generate a tone on the selected CTCSS frequency. Output signal voltage is adjustable from 5-50 mV in 1 mV steps and from 50-500 mV in 10 mV steps.

By design, some transceivers filter out low frequencies so that we normally do not hear them. The result is low speaker output of CTCSS tones that may not be detected reliably.

Autodetect

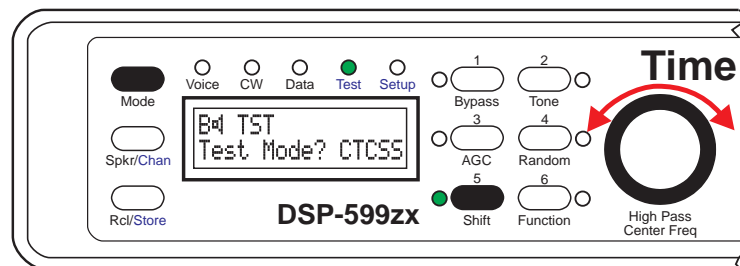

599-050

- Press [Shift+Mode] to enter the Test Instrument mode.
- Turn the **left knob** to CTCSS
- Press the **left knob** to enable the CTCSS Tone feature.

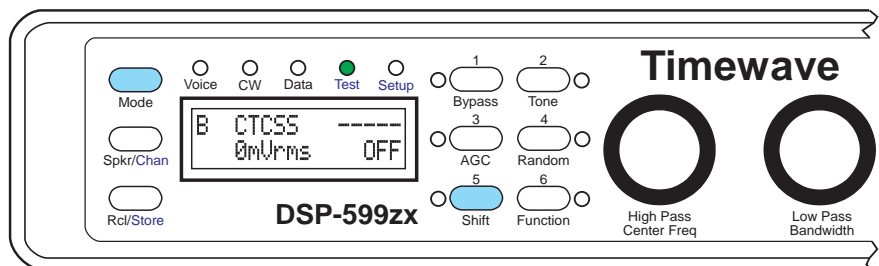

599-048

- The DSP-599zx is now in the **autodetect** mode

Autodetect Display with Input CTCSS Tone

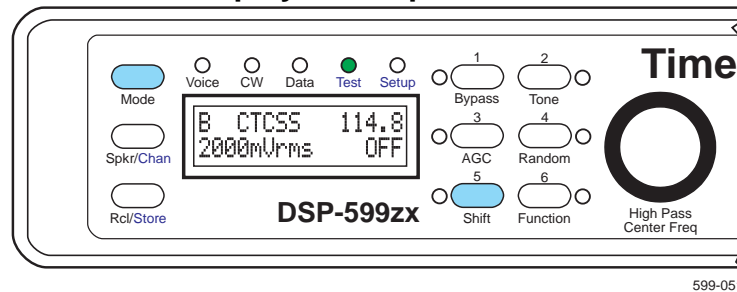

- Press **[Function]** to select input signal amplitude units - mV_{RMS} or μV_{PK} .
- If there is an incoming CTCSS tone, the display will show the frequency (upper right) and the amplitude (lower left).

Tone Squelch

CTCSS Tone Squelch Selection

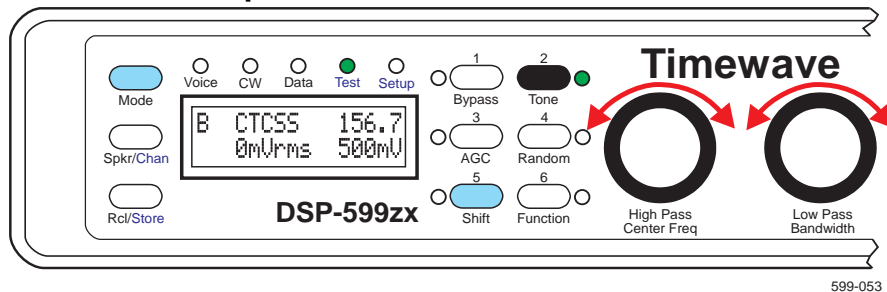

- Press **[Shift+Mode]** to enter the Test Instrument mode.
- Turn the **left knob** to CTCSS
- Press the **left knob** to enable CTCSS Tone feature.
- Press **[Tone]** to turn generator on.
- The DSP-599zx is now in the **tone squelch** mode.
- The **left knob** selects the output and input CTCSS tone center frequency.
- Turn the **middle knob** to set the output tone amplitude in volts RMS (shown on lower right of display).

CTCSS Tone Squelch Detection

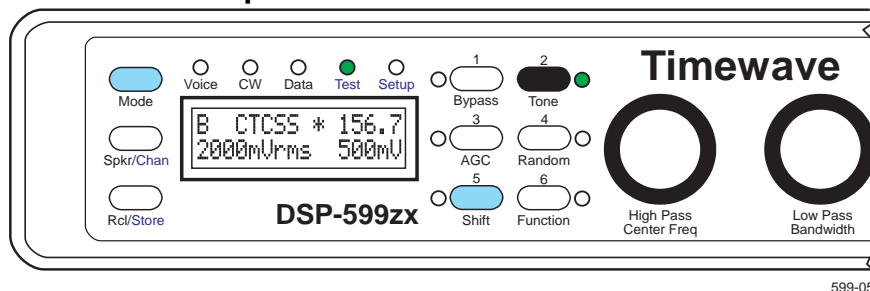

- The amplitude of the selected CTCSS input signal is shown on the lower left side of the display.

- An asterisk is displayed in the upper middle section of the display if the incoming CTCSS signal exceeds the tone squelch threshold level. The audio output is unmuted when the squelch is open.
- Press **[Tone]** again to stop generator and return to the autodetect mode
- Press **[Mode]** to exit Test Instrument mode. Press the **middle knob** to escape back to the test function menu.

	Frequency - Hz	Amplitude - Millivolts rms	Squelch Output
Decode Input	67.0 - 254.1 see Tone Freq. Table	5 - 2000	low = tone present
Encode Output	67.0 - 254.1 see Tone Freq. Table	5 - 500	NA

CTCSS Tone Squelch

The decoder has a detector that pulls a DSP-599zx output pin low when a signal exceeds the threshold. This output may be used to trigger a tape recorder or other monitoring device.

CTCSS Tone Squelch Switch Output Jack and Pin Numbers

Channel	DIN Jack on DSP-599zx	Output Pin No.	Ground Pin No.
A	“Radio A”	4	2
B	“Radio B”	4	2

What are CTCSS tones?

CTCSS tones are normally used in VHF/UHF systems to help reject annoying interfering signals on repeaters or to allow only desired signals to be heard on direct radio links. A selected CTCSS tone mixes with the transmit audio to modulate a transmitted signal. When a tone is present on a received signal, a CTCSS tone decoder output opens the receiver audio squelch, allowing the incoming signal to be heard. The tone frequencies are all below 255 Hz and are usually not audible on most VHF/UHF radios if the frequency deviation is set correctly. The tones usually sound like a “hum” if they can be heard.

CTCSS is an acronym for “Continuous Tone Coded Sub-audible Squelch.” 32 of the tone frequencies are TIA (formerly EIA) standards. Some companies have trademarked names for their CTCSS tone systems and have ex-

tended the frequency set to include more tones. Motorola calls their system "Private Line," which is commonly shortened to "PL." GE calls their system "Channel Guard."

Most new amateur VHF/UHF transceivers have built-in CTCSS encoders with optional CTCSS decoders. Older transceivers often have neither an encoder nor a decoder.

CTCSS Tone Frequencies - Hz

67.0	94.8	131.8	171.3	203.5
69.3	97.4	136.5	173.8	206.5
71.9	100.0	141.3	177.3	210.7
74.4	103.5	146.2	179.9	218.1
77.0	107.2	151.4	183.5	225.7
79.7	110.9	156.7	186.2	229.1
82.5	114.8	159.8	189.9	233.6
85.4	118.8	162.2	192.8	241.8
88.5	123.0	165.5	196.6	250.3
91.5	127.3	167.9	199.5	254.1

Checking CTCSS Tone Frequency and Deviation

The DSP-599zx can help identify the CTCSS tone frequency of the incoming signal and the CTCSS tone relative frequency deviation with respect to other signals heard on the same receiver. To identify and measure a CTCSS tone, use the CTCSS autodetect function to read the CTCSS frequency and amplitude on the LCD display. If the 599zx displays a much lower or higher CTCSS tone amplitude than a known good signal (or most other signals on the same frequency), the CTCSS tone deviation of the received signal is probably set incorrectly. Compare only CTCSS tones of the same frequency unless you know the audio output frequency response of your receiver is flat to less than 30 Hz into a 10K load impedance.

Setup - Test Instrument

There are eight user adjustable variables within this mode of setup.

1. Press **[Shift+Mode]** twice to enter Setup mode.
2. Rotate **left knob** until **Test** appears on the bottom line of the display
3. Press the **left knob** to select.

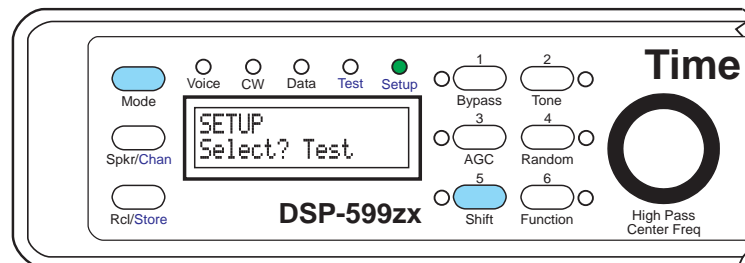

599-071

Default CTCSS Tone (Version 4 firmware only)

You can adjust the default CTCSS tone that will appear when you turn the CTCSS test function on.

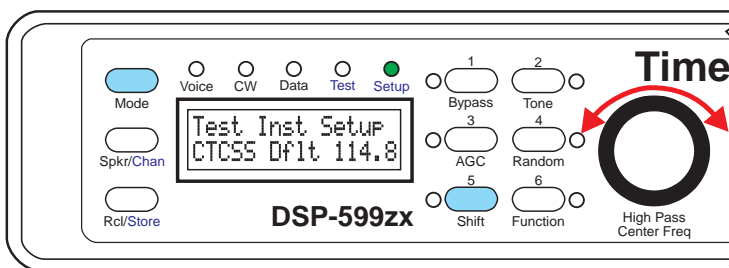

599-082

1. Press **[Shift+Mode]** twice to enter Setup mode.
2. Rotate **left knob** until **Test** appears on the bottom line of the display
3. Press the **left knob** to select.
4. Rotate **left knob** until **CTCSS Df1t** appears on the bottom left of the display
5. Press the **left knob** to select.
6. Rotate **left knob** until the chosen value appears on the bottom right of the display
7. Press the **left knob** to accept choice and save. Press **middle knob** to escape without saving changes.
8. Rotate **left knob** until your next function to change appears on the bottom line of the display or press the **middle knob** to return to main set-up menu.

CTCSS Trigger Threshold (Version 4 firmware only)

You can adjust the level that the CTCSS tone will trigger the squelch to open. The factory default is 20 mV.

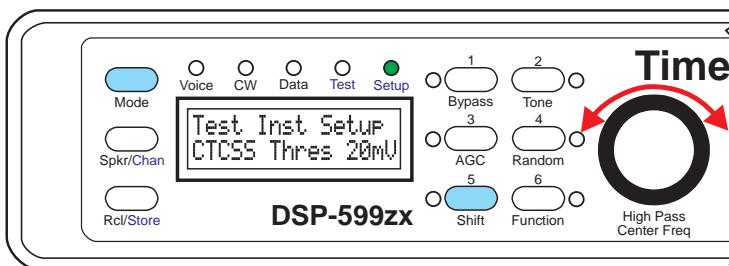

599-083

1. Press **[Shift+Mode]** twice to enter Setup mode.
2. Rotate **left knob** until **Test** appears on the bottom line of the display
3. Press the **left knob** to select.

4. Rotate **left knob** until **CTCSS Thres** appears on the bottom left of the display
5. Press the **left knob** to select.
6. Rotate **left knob** until the chosen value appears on the bottom right of the display
7. Press the **left knob** to accept choice and save. Press **middle knob** to escape without saving changes.
8. Rotate **left knob** until your next function to change appears on the bottom line of the display or press the **middle knob** to return to main set-up menu.

Signal Generator Calibration

This unit was delivered to you calibrated. If for some reason you decide that you need to re-calibrate the outputs and inputs on the DSP-599zx, do it with great care. Resetting the unit has no effect on these settings. Use a high quality digital multimode VOM meter, such as a Fluke 8060 or equivalent. It takes a unit of this caliber to be accurate at the 1 kHz calibration tone. Adjust meter to read AC voltage with a range of 0 - 2 volts.

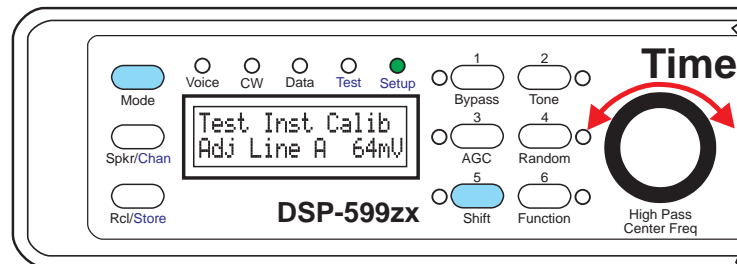

599-085

1. Connect a Fluke 8060 or equivalent to channel A line output. Set meter to AC volts, in the appropriate range to read the required voltage.
2. Press [**Shift+Mode**] twice to enter Setup mode.
3. Rotate **left knob** until **Test** appears on the bottom line of the display
4. Press the **left knob** to select.
5. Rotate **left knob** until **Adj Line A 64mV** appears on the bottom line of the display
6. Press the **left knob** to select.
7. Rotate **left knob** until the reading on the meter reads 64 millivolts.
8. Press the **left knob** to accept choice and save. Press **middle knob** to escape without saving changes.
9. Rotate **left knob** until **Adj Line A 512mV** appears on the bottom line of the display

10. Press the **left knob** to select.
11. Rotate **left knob** until the reading on the meter reads 512 millivolts.
12. Press the **left knob** to select. Press **middle knob** to escape without saving changes.
13. Reconnect the meter to channel **B** line out and repeat steps 2 - 9 except for channel **B**.
14. Rotate **left knob** until your next function to change appears on the bottom line of the display or press the **middle knob** to return to main setup menu.

Millivoltmeter Calibration

Again, like the previous calibration, it will usually not be required. If you do this procedure, proceed with caution. You will need to have the inputs set for high impedance. See page 2-4 for this procedure.

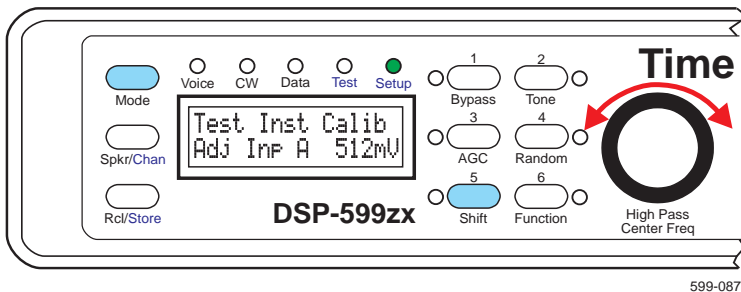

1. Connect jumper cable from Line Output on channel **A** to audio Input on channel **A**.
2. Press [**Shift+Mode**] twice to enter Setup mode.
3. Rotate **left knob** until **Test** appears on the bottom line of the display
4. Press the **left knob** to select.
5. Rotate **left knob** until **Adj Inp A** appears on the bottom line of the display
6. Press the **left knob** to select.
7. Rotate **left knob** until the **512mV** appears on the bottom right of the display
8. Press the **left knob** to accept choice and save. Press **middle knob** to escape without saving changes.
9. Reconnect the jumper cable from Line Output on channel **B** to audio Input on channel **B**.
10. Repeats sets 2 - 5 for channel **B**.
11. Rotate **left knob** until your next function to change appears on the bot-

tom line of the display or press the **middle knob** to return to main set-up menu.

Exit Setup

When you are through with Setup, press **[Mode]** to return to Voice mode.

8

Troubleshooting

Most of the functions of the DSP-599zx can be checked using the LCD display, the LEDs, the internal sine wave generator and audio millivoltmeter and your ears.

The most common problem with amateur radio equipment is defective or incorrectly connected cables. Check them carefully!

Check our World Wide Web site (<http://www.timewave.com>) for additional troubleshooting hints.

Common Problems and Solutions.

Nothing comes on when I turn on the power.

1. Check power connection to DSP-599zx.
2. Make sure your power supply is on.
3. Verify that you have 12-16 Vdc at the power connection with center pin positive.
4. Check the fuse for continuity. Loosen the two screws holding each of the bezels in place. Slide bezels off the unit.
5. Remove four screws holding the front panel in place. Carefully disconnect the two ribbon cables from the rear of the front panel.
6. Remove the four screws holding the rear panel in place.
7. Turn unit over and remove the two screws from the bottom of the case.
8. Observing static precautions carefully turn unit upright and slide circuit board assembly about two thirds of the way out of the case.
9. Visually check fuse in lower left corner. Check with meter if not sure. If you need to replace fuse replace with 1.6A 5 mm x 20 mm (Radio Shack Part #270-1051 or equiv.)
10. Reassemble reversing instructions above.
11. Reconnect only power cable and turn on. If lights stay on, power off and reconnect all other cables. Power back to test. If unit does not light up, call our technical support department.

"Normal" LED does not flash on audio peaks.

1. Check power connection to DSP-599zx.
2. Increase audio input level with receiver audio output level control until the "Normal" LED flashes.
3. Bypass the DSP-599zx by turning it off. Verify the audio level out of the radio by listening to the speaker. If nothing is heard, plug a set of **stereo** headphones into the rear panel headphone jack. If no audio is heard in the headphones or speaker, check audio input connections from the receiver's external speaker output to the DSP-599zx. Make sure the cable polarity is correct. See the audio input installation section.

"Overload" LED flashes constantly on audio peaks.

1. Check power connection to DSP-599zx.
2. Reduce audio input level with receiver's audio output volume control, audio levels into the DSP-599zx are very important for distortion-free reception. Occasional flashes of the overload LED are usually not a problem.

No audio output

1. Check power connection to DSP-599zx.
2. Increase audio input level with receiver audio output level control until the "**Normal**" LED flashes.
3. The speaker icon should be visible on the top line of the display. If it is not visible, press [**Spkr**] to unmute the speaker.
4. Verify that the radio is connected to the channel shown on the display.
5. Turn the DSP-599zx's front panel audio level control clockwise.
6. Bypass the DSP-599zx by turning it off. Verify the audio level out of the radio by listening to the speaker. If no audio is heard from the speaker, check the speaker connections with the DSP-599zx and the connections between the receiver and the DSP-599zx. If no audio is heard in the headphones or speaker, check audio input connections to the DSP-599zx from the receiver.
7. Check audio output device (speaker or headphones).

It still does not work!

If the DSP-599zx does not seem to work correctly after carefully following the installation, operation and troubleshooting instructions in this manual, call, write, E-mail or FAX the Timewave Customer Service Department for additional help.

Timewave Technology Inc.

501 W. Lawson Ave.

St. Paul, MN 55117

U.S.A.

Phone 651-489-5080

FAX 651-489-5066

E-mail sales@timewave.com

Web <http://www.timewave.com>

Appendix A

Specifications

AUDIO INPUT A & B

Impedance	20 K ohms or 25 ohms, jumper selectable
input signal range for full output	10 mV to 1.0 volt, front panel programmable

AUDIO OUTPUT A & B

Speaker output power	1.0 watts into 8 ohms at 13.8 VDC, both output channels A & B operating, 1.5 watts into 4 ohms at 13.8 VDC, both output channels A & B operating,
Line output	0 dB level referenced to input level . Not controlled by gain control
Headphone Jack	1/4" two-circuit jack, use stereo headphones to use all functions, mono headphones for most functions
Harmonic Distortion	less than 1% at rated output

NOISE REDUCTION FILTERS

	Frequency Range	Attenuation	Type	Delay
Random Noise Reduction	entire freq. range of selected filter	Up to 20 dB, varies with noise characteristics. Noise reduction aggressiveness front panel adjustable	Adaptive	5 msec max
Heterodyne Eliminator (multiple automatic notch)	entire freq. range of selected bandpass filter	Up to 50 dB, varies with noise characteristics	Adaptive	5 msec max
Heterodyne Eliminator (manual notch)	entire freq. range of selected bandpass filter	Up to 50 dB, varies with noise characteristics	manual	

Note: The random noise reduction and bandpass filters can operate simultaneously. The random noise reduction, tone notch and highpass/lowpass filters can operate simultaneously.

CW FILTERS

CW filters	Bandwidth = 5 Hz to 600 Hz, 10 Hz steps. Center freq. = 200 to 2150 Hz, 5 Hz steps,	55 dB at 60 Hz outside the passband	FIR Linear phase	BW less than 20 Hz= 64 msec max BW greater 20 Hz= 40 msec max
CW Marker Tone	Sine wave at center freq. of selected CW filter.			

DATA FILTERS

RTTY, AMTOR, PACTOR, G-TOR, HF Packet	Mark/Space bandwidth 60 Hz to 100 Hz, Center Freq.= 2210 Hz plus options of 1700, 1360, 1300, 1530 or 2125 Hz	40 dB at 60 Hz outside the passband	FIR Linear phase	38 msec max
Note:	RTTY and AMTOR filters have a notch at the center frequency .			
CLOVER	2000-2500 Hz	55 dB at 75 Hz outside the passband	FIR Linear phase	21 msec max
SSTV	1100-1300 Hz & 1500-2300 Hz	50 dB at 75 Hz outside the passband	Composite FIR Linear phase	21 msec max
WeFAX	1500-2300 Hz	55 dB at 75 Hz outside the passband	FIR Linear phase	21 msec max
FSK Marker Tones	1) RY string - Alternating sine waves at mark-space freq. of selected data filter (170 or 200 Hz shift). Baud rate matches selected RTTY data mode. 2) Sync-Nul Character (Diddle) - Baud rate matches selected data filter.			

RTTY MODEM

Shifts	170, 200, 425, 850 Hz
Data Rates	45, 50, 57, 75 Baud
Input	Audio from receiver.
Output	Open collector FSK and variable level AFSK
Transmit Data Polarity	Normal or Reverse
I/O	Receive data, Transmit data, PTT (RS-232 compatible)

VOICE FILTERS

	Frequency Range	Attenuation	Type	Delay
Highpass	Corner freq. = 100 to 1000 Hz, 10 Hz steps.	60 dB at 180 Hz outside the passband	FIR Linear phase	24 msec max for any combination of
Lowpass	Corner Freq. = 1000 to 5000 Hz, 10 Hz steps.	60 dB. at 180 Hz outside the passband	FIR Linear phase	highpass & lowpass

AGC

Voice mode	36 dB
CW and Data Modes	18 dB

SIGNAL PROCESSING

A-D/D-A Converter	16 bit linear, sigma-delta conversion, dual channel
Signal Processor	16 bit, 27ns Analog Devices ADSP-2181 with 80 KB of memory

TEST INSTRUMENT MODE

Audio Generator	Single. Two-tone (Version 4 firmware only). single Sine wave tunable from 20 Hz to 10 kHz. Two-tone fixed 700Hz and 1900Hz. (Version 4 firmware only) Sine wave distortion less than 1%.
Audio millivoltmeter	True RMS from 4mV to 2000 mV., 20Hz to 10 kHz
CTCSS encoder-decoder	Generates and decodes and displays CTCSS “PL” tones from 67.0 Hz to 254.1 Hz. (Version 4 firmware only)
CTCSS squelch	Open collector output pulls low when selected CTCSS tone is present. (connection on back panel DIN connector) (Version 4 firmware only)

MEMORY

Six Memories	All configuration setups can be stored and recalled (except volume control setting).
--------------	--

DISPLAY

2x16 alphanumeric characters, dot-matrix, yellow-green backlit LCD.

DIMENSIONS

Size	7.6 in. wide x 8.5 in. deep x 1.9 in. high (193 mm wide x 216 mm deep x 48 mm high)
Weight	2.53 lb. (1.15 Kg.)

POWER

Requirements	12-16 VDC @ 1A
Fuse	1.6A 5 mm x 20 mm

Note: RTTY, AMTOR, PacTOR, G-TOR and HF Packet data filter bandwidths are specified at -3 dB points to comply with traditional data filter specification methods. All other filter bandwidths are specified to comply with conventional DSP FIR filter parametric descriptions.

Appendix B

Glossary

AFSK (Audio Frequency Shift Keying)

A common RTTY mode most often used for VHF and UHF communications. The signal is generated by switching between two audio tones fed into the microphone input of a FM transmitter.

AMTOR

Amateur Teleprinting Over Radio is an error correcting digital mode. Data is sent in three character blocks then waits for a response of ACK or NAK to indicate successful or unsuccessful transmission.

Bandpass Filter

A filter that allows only a given range of frequencies to pass through. All frequencies outside the range are either eliminated or significantly reduced in volume.

Center Frequency

The nominal frequency at which the RTTY data signal is transmitted. The signal is actually a rapid switching between two frequencies (Mark and Space) centered on the nominal frequency. Nothing is actually transmitted on the center frequency. The normal range is 1200 to 2500 Hz. The North American standard is 2210 Hz.

CLOVER

A digital communications mode that utilizes a four-tone modulations system and digital signal processing to pass data on the HF bands. It has a relatively narrow signal bandwidth of 500 Hz. Because CLOVER stations share information concerning signal conditions and power output levels, it has the ability to automatically adjust power output to maintain stable communications. It is however, extremely sensitive to frequency shift. It cannot tolerate frequency drift of more than 15 Hz while linked.

DCD (Data Carrier Detect)

A “squelch” circuit for data. This is done by sampling data transmissions to verify that it is valid data in the mode selected. When found, the circuit opens the circuit to allow data to flow through.

FSK (Frequency Shift Keying)

A common RTTY mode most often used for HF communications. The signal is generated by switching a HF carrier between two separate frequencies.

G-TOR

A data mode that use several compression, checking or correction techniques besides automatic repeat requests. Faster than either AMTOR or PacTOR.

Heterodyne

The combining of two different frequencies to produce beats whose frequency is either the difference or the sum of the two frequencies.

Highpass Filter

A filter that permits frequencies above a certain cutoff frequency to pass and eliminates or significantly reduces signals below the filter frequency.

Lowpass Filter

A filter that permits frequencies below a certain cutoff frequency to pass and eliminates or significantly reduces signals above the filter frequency.

Mark-Space Frequency

The two frequencies at which RTTY data is actually sent. The common frequency shifts between Mark and Space are 170 Hz and 200 Hz.

PacTOR

A packet-like digital mode combining aspects of packet and AMTOR and also has AX.25 compatibility. Unlike standard packet radio, PacTOR does not allow frequency sharing. PacTOR is faster than AMTOR and uses the complete ASCII character set and can easily handle binary data transfers.

RTTY

The original data communications mode and is well suited for “roundtable” QSOs with several stations. It does not support frequency sharing or error correction. RTTY was originally designed for use with mechanical teleprinters, predating personal computers.

SSTV

Slow-Scan TV is a narrow bandwidth image mode popular on the HF bands that transmits pictures at 8, 16 or 32 seconds per frame.

WeFAX

Weather facsimile image format. There are two modes HF and satellite. The DSP-599zx currently supports only HF mode Detailed information on satellite mode can be found in *The Weather Satellite Handbook* published by the ARRL

Appendix C

Product Warranty

Timewave Technology Inc. products carry the following warranty:

Timewave hardware products are warranted against defects in materials and workmanship. If Timewave receives notice of such defects during the warranty period, Timewave shall, at its option, either repair or replace hardware products which prove to be defective.

Timewave software and firmware products which are designated by Timewave for use with a hardware product are warranted not to fail to execute their programming instructions due to defects in materials and workmanship. If Timewave receives notice of such defects during the warranty period, Timewave shall, at its option, either repair or replace software media or firmware which do not execute their programming instructions due to such defects. Timewave does not warrant that operation of the software, firmware, or hardware shall be uninterrupted or error free.

The warranty period for each product is one year from date of shipment.

Limitation of Warranty: The foregoing warranty shall not apply to defects resulting from:

1. Improper or inadequate maintenance by the Buyer;
2. Buyer-supplied software or interfacing;
3. Unauthorized modification or misuse;
4. Operation outside the environmental specifications of the product;
5. Improper site preparation and maintenance.

Exclusive Remedies:

The remedies provided herein are the Buyer's sole and exclusive remedies. In no event shall Timewave be liable for direct, indirect, special, incidental or consequential damages (including loss of profits) whether based on contract, tort, or any other legal theory.

Appendix D

Electromagnetic Interference

To maintain the integrity of the EMI prevention measures in this unit, it is important to replace all hardware if the unit is reassembled after opening the housing.

This unit has been tested to verify compliance with EMI requirements of FCC rules part 15. The following notice is required by the FCC.

NOTE:

This equipment has been tested and found to comply with the limits for a Class B digital device, pursuant to part 15 of the FCC rules. These limits are designed to provide reasonable protection against harmful interference in a residential installation. This equipment generates, uses and can radiate radio frequency energy and, if not installed and used in accordance with the instructions, may cause harmful interference to radio communications. However, there is no guarantee that interference will not occur in a particular installation. If this equipment does cause harmful interference to radio or television, which can be determined by turning the equipment off and on, the user is encouraged to try to correct the interference by one or more of the following measures:

- Reorient or relocate the receiving antenna.
- Increase the separation between the equipment and the receiver.
- Connect the equipment into an outlet on a circuit different from that which the receiver is connected.
- Consult the dealer or an experienced radio/TV technician.

Appendix E

Schematic Diagrams

The schematic diagrams in this manual may differ slightly from any particular DSP-599zx. Timewave reserves the right to make changes in the DSP-599zx at any time.

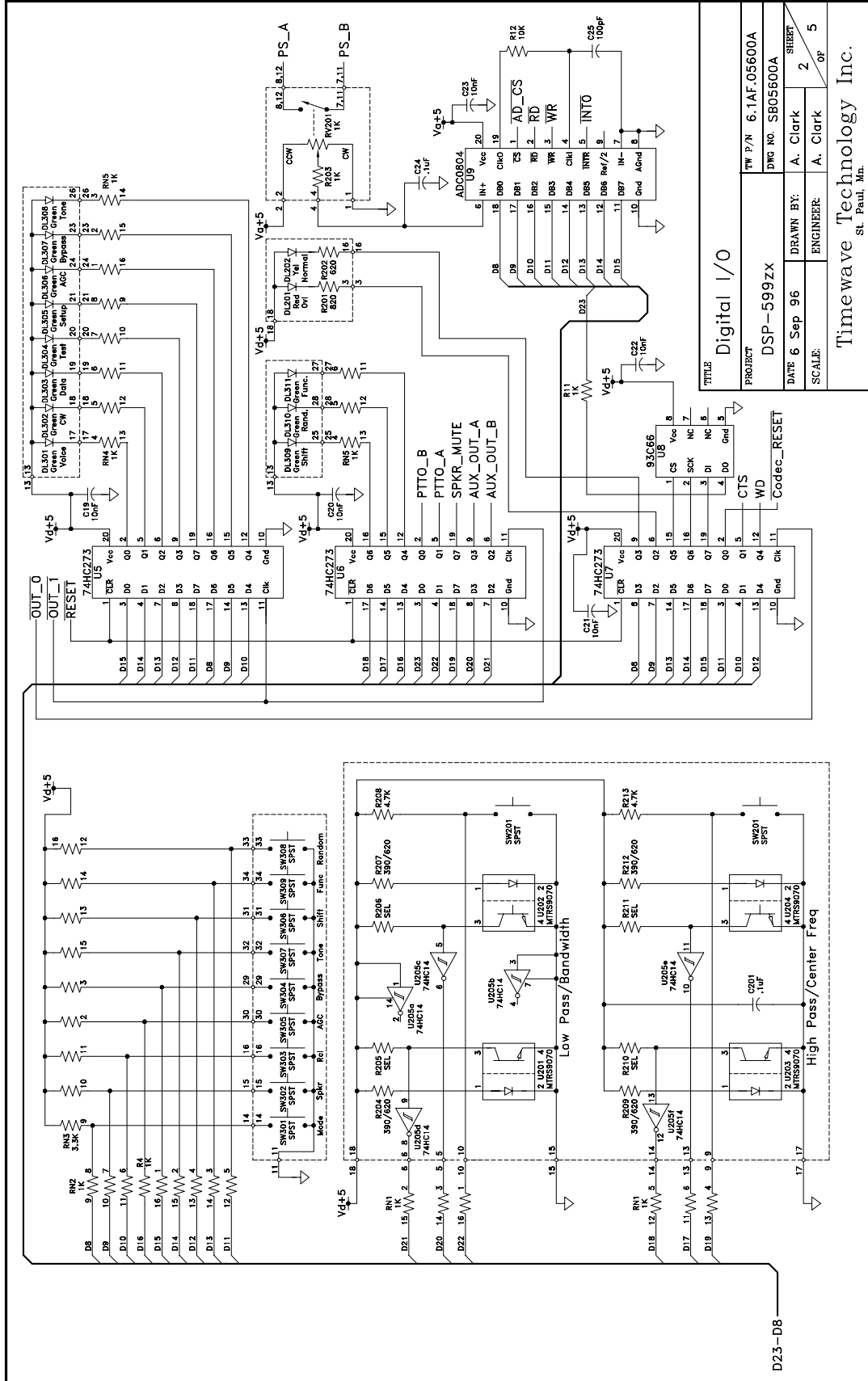

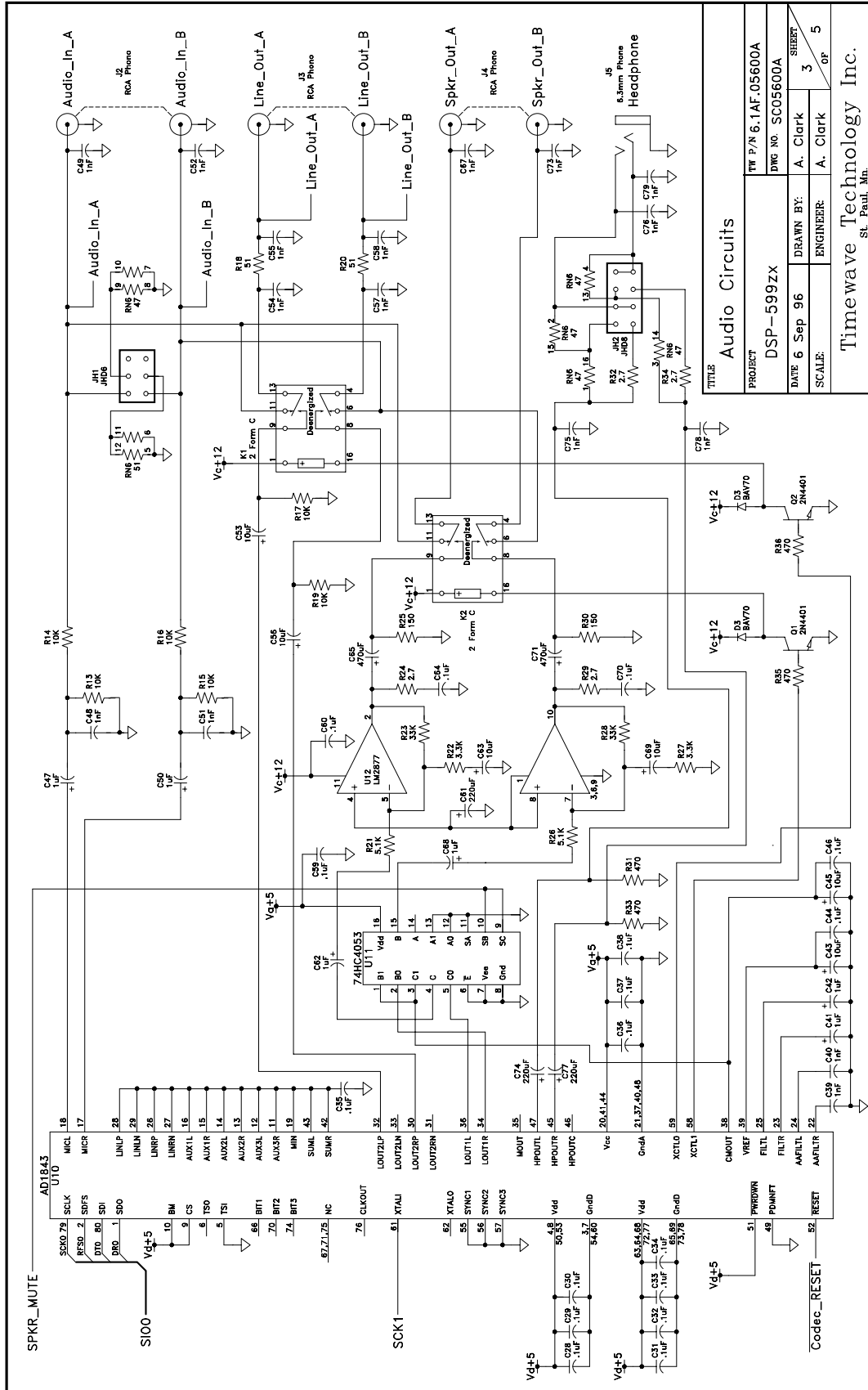

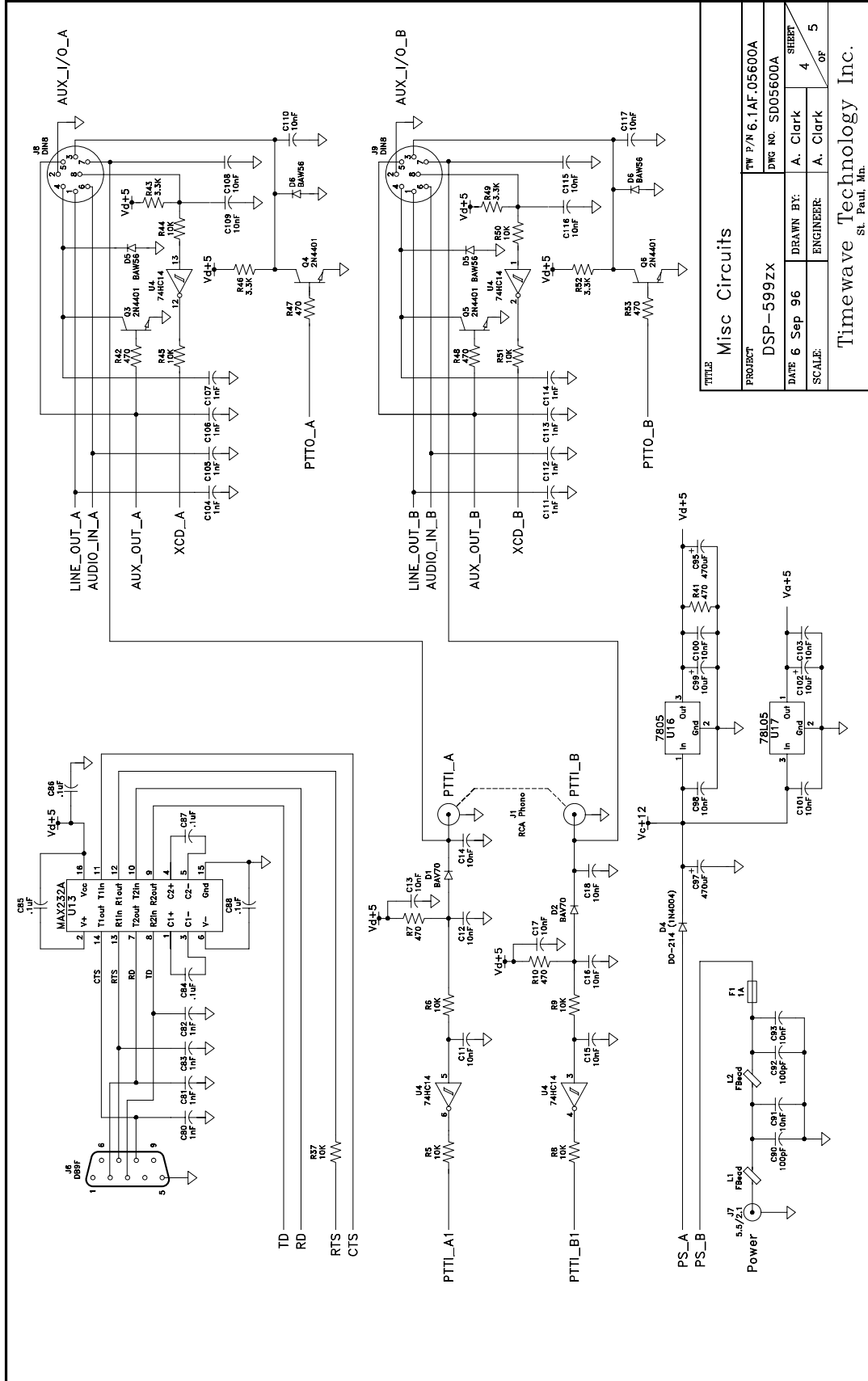

TITLE Misc Circuits			
PROJECT DSP-599zx		TW P/N 6.1AF.05600A	
DATE 6 Sep 96		DWG NO. SD05600A	
SCALE:		DRAWN BY: A. Clark	
		ENGINEER: A. Clark	
		SHEET 5	
		OF 5	
Timewave Technology Inc. St. Paul, Mn.			

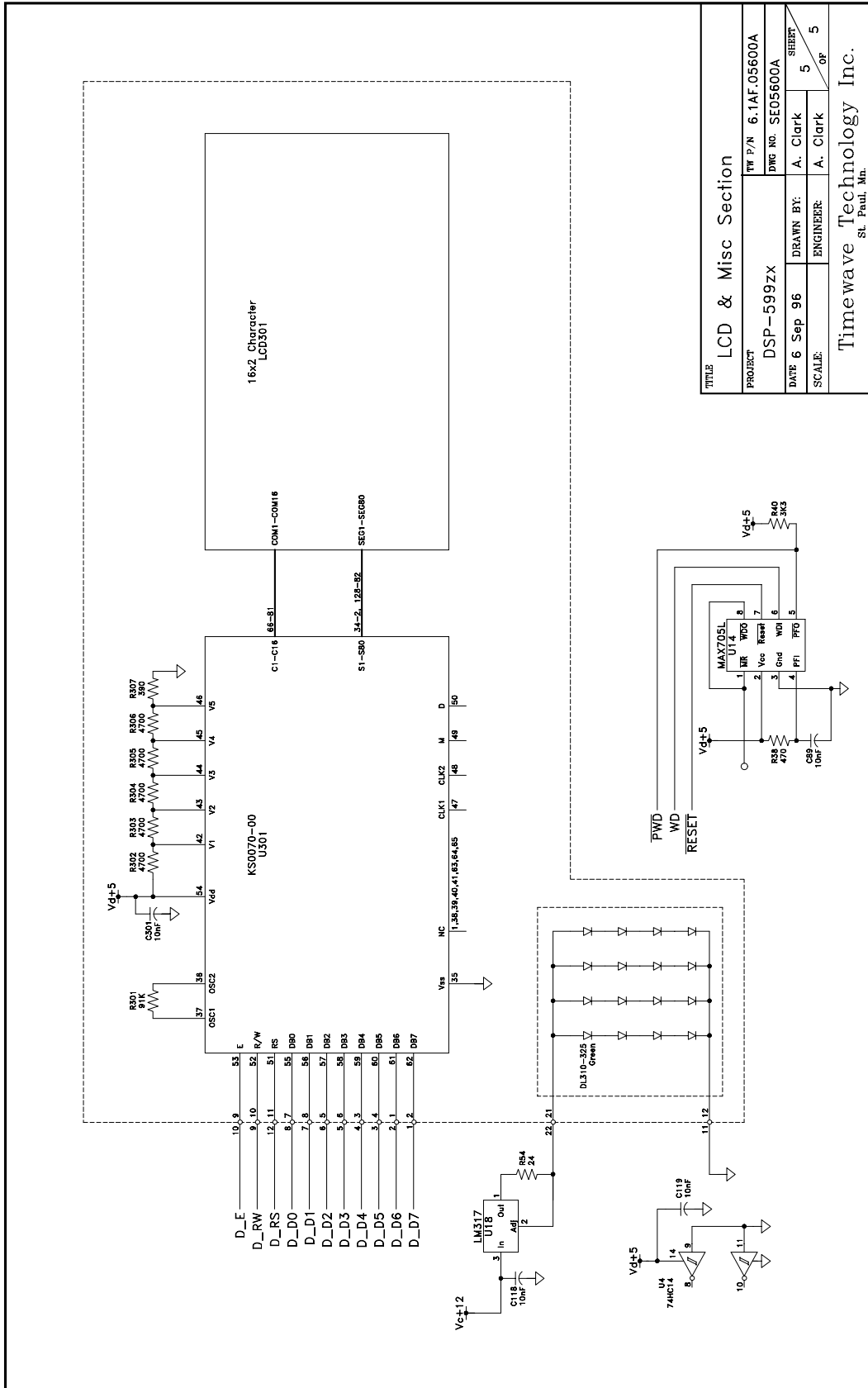

TITLE		LCD & Misc Section	
PROJECT	DSP-599ZX	TW P/N	6.1AF.05600A
DATE	6 Sep 96	DWG NO.	SE05600A
SCALE:		DRAWN BY:	A. Clark
		ENGINEER:	A. Clark
			SHEET 5 OF 5
Timewave Technology Inc. St. Paul, Mn.			