

Assembly Manual for the

UHF WATTMETER

K-6312

PLEASE READ DISCLAIMER CAREFULLY AS WE CAN ONLY GUARANTEE PARTS AND NOT THE LABOUR CONTENT YOU PROVIDE.

Reprinted in part by arrangement with Electronics Australia from their November, 1984 edition.

DICK SMITH
HIT



SWR -What it means in practice

When amateurs get together, and the talk turns to antennas, it is not long before the magic phrase, 'SWR', is heard. But just what is SWR and how important is it in practice?

It is an unfortunate fact that SWR, along with antenna and transmission line theory in general, is one of the most misunderstood subjects in the whole of amateur radio. It boasts as many myths and old wives tales as does pregnancy and childbirth, some of them perpetuated by supposedly reputable text books.

In trying to get a mental picture of what is, admittedly, an extremely complex subject it is often a help to start with a theoretically perfect situation, against which we can compare the usually imperfect practical situation.

THE ANTENNA

Let's start with the antenna. In any transmitter installation, this has to satisfy two basic requirements. One is to radiate the RF energy fed to it by the transmitter in the most efficient manner possible. The other is to present the transmitter with the correct load in order that the transmitter may deliver the level of RF power which the designer intended.

While both are important, the second requirement is, in many ways, the more important one. Suppose we have a typical commercial transmitter designed to deliver 10W into a 50Ω load. If we connect a pure (ie, non-reactive) 50Ω resistor directly across the antenna terminals or socket at the set, and energise the transmitter, it will deliver 10W to the resistor, which will appear as heat.

If we were to substitute some other value of resistor a number of things

could happen. The most likely one is that the transmitter would no longer deliver its 10W. By how much it would fall short would depend on the error in the load value and the design and tolerance of the particular transmitter output stage.

Another possibility, again depending on the output stage design, is that it would try to deliver more than its rated power, but run into overload in the process, and destroy itself and other sections as a result. Fortunately, most commercially designed transmitters are well protected in this regard, but there is no point in taking unnecessary risks.

But, this risk aside, we should make every endeavour to present the correct load to the transmitter simply to ensure that it delivers the maximum power for which it was designed. On the other hand, there is little to be gained by simply feeding this energy into a resistor; it will radiate very little of the RF energy and waste virtually all of it as heat.

So we replace the resistor with an antenna and, fairly obviously, this antenna should look (to the transmitter) like a 50Ω resistor if it is to deliver maximum power. Assuming the antenna is resonant at the transmitter frequency, and fed at the right point, it will look like a resistor. If it is not resonant it will exhibit either a capacitive or inductive component, according to which way it is off resonance.

Assuming that it is resonant, the next question concerns the value of resistance it presents to the transmitter. And this is where the going gets tough because, in other than a very few clearly defined cases, this is very largely an unknown or,

at best, "guesstimated" value.

We can, for example, nominate the resistance at the centre of a half wave dipole as being in the region of 72Ω, while a folded version of the half-wave dipole will have four times this impedance, or 288Ω (often mentally rounded off to 300Ω). A number of factors can cause minor variations to these values, such as the diameter of the elements, relative to their length, space between folded dipole elements, etc.

A more controversial value is that for the popular quarter-wave ground plane. For years it has been stated, in many popular amateur textbooks, that this is approximately half the value of the simple dipole, or 36Ω (in fact, various values have been quoted between 30 and 36Ω). This figure appears to have been based on a theoretically calculated value for a quarter-wave radiator working against an infinitely large, perfectly conducting ground plane.

Some of these text books even went so far as to describe matching devices ("Q" sections, etc) which would match this value to the popular 50Ω coax cable and transmitter load requirements. As anyone who has tried to make one of these matching systems work, or who has attempted to confirm this figure with an impedance bridge will testify, the real-life ground plane, using four quarter-wave radials, is a vastly different device.

Strangely enough, the true situation has been known for many years. At least as early as 1962, and possibly earlier, the R.S.G.B. Handbook (page 365) stated: "The radiation resistance of a ground quarter wave aerial is 35Ω, but that of a ground-plane is less than 20Ω." More recently other authorities have been emphasising this same point but, unfortunately, old ideas die hard, and the point needs to be emphasised a good deal more strongly if the error is to be corrected.

Text courtesy of Electronics Australia

One of the most recent articles on the subject, and one of the most detailed, is that by Guy Fletcher, VK2BBF, which appeared in the August 1984 issue of "Amateur Radio", the official journal of the Wireless Institute of Australia. This, and two articles which follow in subsequent issues, are recommended to anyone wishing to get a more detailed picture of the antenna scene generally.

But this is a separate argument. The point we set out to make is that, apart from these few simple designs, it is exceedingly difficult to nominate the feed point impedance of an antenna. We do know the general effect of many design factors; that, for example, the addition of director or reflector elements to a dipole will lower the impedance. But by how much is another matter.

So we are faced with the situation that the impedance of all but the simplest antenna systems is largely an unknown quantity. With experience we can make a rough estimation that it will be between this and that figure, or below some other figure, but beyond that we must resort to some form of measurement or "suck-it-and-see" approach.

SWR METERS

One such approach involves the use of a standing wave ratio meter, or SWR meter. But it would be premature to go into details at this stage. We need to talk about SWR in some detail first.

So far we have considered only those situations where a resistor or an antenna — which looked like the same resistor — was connected directly across the transmitter output terminals. Apart from a few special cases, feeding an antenna in this manner is not very practical. We need to locate the antenna as high as possible and clear of objects which might shield it, while we need to put the transmitter in a convenient indoor working location, some distance away.

And, to couple the two together, we need a special kind of cable; one that will convey the transmitter output to the antenna with minimum loss and which, in itself, will not radiate any significant amount of this energy into a shielded environment, where much of it would be wasted.

There are two types of cable commonly used by amateurs, the open wire line and the coaxial cable. The open wire line can be homemade, has very low losses, and can be made to have any impedance characteristic over a wide range. On the other hand it can be awkward to install and is much less popular than it once was.

Coaxial cable is a commercial product, with somewhat higher losses, and is commonly available in two popular impedance values: 50 and 72Ω. It is reasonably flexible and relatively easy to install. For most of our discussion we will assume the use of coaxial cable, although most of the points would be just as valid for open wire lines.

CHARACTERISTIC IMPEDANCE

Undoubtedly the most important single characteristic of a coaxial cable, for the beginner to understand, is its characteristic impedance, typically 50 or 72Ω, as already mentioned. This is not an easy concept to grasp and the beginner may have to content himself with accepting some basic statements at their face value, at least initially.

Coaxial cable consists of two conductors, one within the other, and insulated from each other. A common form uses solid or stranded wire as the central conductor, copper braid as the outer conductor, and a polythene insulating material between them.

The characteristic impedance is a factor of the inductance of the two conductors, relative to the capacitance between them, per unit length. These factors, in turn, are determined by the physical characteristics of the components; the inductance by the cross sectional area of the conductors, and the capacitance by their area relative to each other, the distance between them, and the dielectric constant of the insulating material. The length of the line is not a factor.

The effect of this inductance/capacitance relationship is to establish an equally firm relationship between the voltage and current of RF energy travelling up the line. This relationship is exactly the same as would

have occurred across and through a pure resistor having the same value (say 50Ω) as the characteristic impedance of the cable.

It may help to grasp this concept if one is to visualise a very short burst of RF energy transmitted up the line; so short that its trailing edge has left the transmitter long before its leading edge has reached the load at the far end. Thus, something in the manner of a fired projectile, or even a thrown tennis ball, it is in a kind of limbo; while influenced initially by the manner of its launch its subsequent movement is largely a factor of its environment. And it knows nothing about what lies in store for it at the end of its journey.

We can carry the analogy a little further. If the tennis ball ultimately hits a brick wall it will bounce off (or be reflected) simply because the brick wall represents a gross mismatch to the manner in which energy is stored in the moving ball. A softer object, such as a bale of hay, may well have absorbed all the energy with no bounce (or reflection).

The same applies to our burst of RF energy. When it reaches the end of the cable it will need to meet exactly the right load if all its energy is to be dissipated in that load. And it doesn't take much imagination to conclude that the load should look like (in this case) a 50Ω resistor.

If it encounters any other value then only part of the energy will be absorbed by the load, and the remainder will be reflected down the line in the direction of the transmitter. And this is what creates what are called "standing waves" on the transmission line.

STANDING WAVES

In greater detail, the standing waves are actually peaks of voltage between the conductors, or peaks of current through the conductors, which occur at regular intervals along the line. They occur at those points where (say) the voltage of the outgoing energy encounters voltage of reflected energy which is exactly in phase with it. Similarly for the current peaks.

The position of each peak is fixed and will always be one half wavelength away from its neighbour. Exactly between each peak, ie, one quarter wavelength away, will be a dip or voltage minimum, and it is the ratio between these two voltages which constitutes our "standing wave ratio" or SWR. (Note: wavelengths in coaxial cable will be physically shorter than in free space, according to the characteristics of the insulating material. A factor of 0.66 is typical, commonly referred to as the "velocity factor".)

In the theoretically perfect situation, where the cable is correctly terminated, all the energy is absorbed by the load, there will be no reflected wave, and the voltage and current values will remain essentially constant along the length of the line. Such a situation is said to

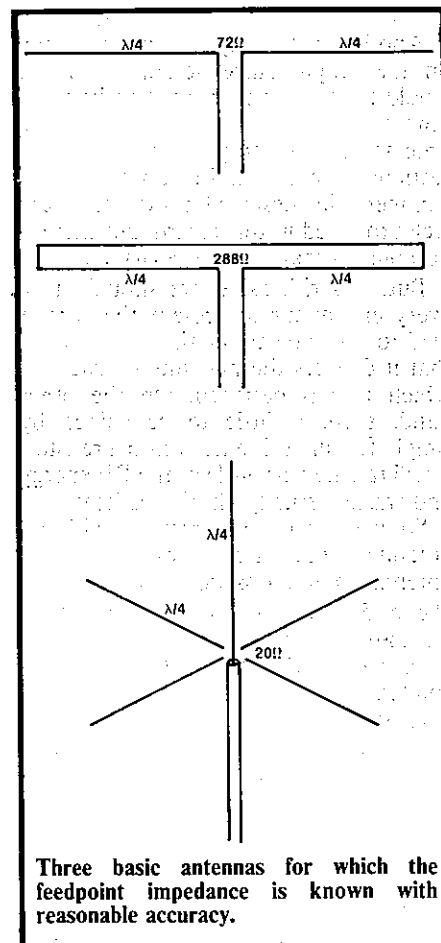

Three basic antennas for which the feedpoint impedance is known with reasonable accuracy.

constitute a "flat" line.

By now the reason for our interest in the SWR should be apparent. Because it occurs only if there is a mismatch, and its value is directly related to the degree of mismatch, its measurement provides a very useful "suck-it-and-see" approach to ensuring that the transmitter is presented with its correct load.

In greater detail, an SWR of (say) 2 to 1 will mean that the load is in error, relative to the cable impedance, by this ratio. But it cannot indicate in which direction the error lies. Assuming a 50Ω cable the 2 to 1 error could mean that the load is half (25Ω) or twice (100Ω) the correct value. Note, however, that this relationship is true only when the load is purely resistive.

Considering all the foregoing, and with the benefit of hindsight, one wonders whether the term "SWR", to some extent, might be misleading; and that some other term, like "mismatch ratio", might not have been a better choice.

But it is essential to keep one very important point in mind at this stage of the discussion. The existence of standing waves, in itself, is only a secondary problem. It is a useful measurement only because it tells us whether the transmitter is being correctly loaded or not and that our efforts should be directed to correcting this aspect of the problem. Whether we correct the SWR in the process may not even matter. Let us consider a practical example.

Suppose an SWR reading indicates quite clearly that there is a serious mismatch between antenna and cable. We have two options: either fit some kind of matching device between the antenna and the cable so that the antenna now looks like the correct value, or fit a matching device between the transmitter and the cable so that the transmitter sees a correct load.

In theory the first option is the preferred one, since we not only present the transmitter with its optimum load, but we eliminate the standing waves at the same time. In practice, however, the second option may well be very much more practical and convenient. It will have achieved the same primary objective of loading the transmitter correctly and in many cases the SWR can be ignored.

But what happens to the RF energy reflected by an antenna which does not match the cable? If it is sent back down the line, is it not wasted? No, it isn't. The practical situation is that the transmitter presents a gross mismatch to the line, and deliberately so. Its (source) impedance is kept as low as possible in order that as little as possible of the RF energy it generates is wasted as heat in the final stage.

So the reflected RF energy encounters this gross mismatch and is promptly reflected up the line again to the antenna, where the major proportion of it is radiated and a minor proportion

reflected. After a couple of such journeys virtually all of the energy will have been radiated. (In typical audio transmission systems the time delays involved are not important. In a TV transmission system they can be significant, and more careful design is necessary to avoid transmitting "ghosts".)

CABLE LOSSES

In fact, there is a flaw in that argument. We can only assume that no energy is wasted if we ignore the inherent losses in the cable. All cables have some losses, and these increase with frequency. For example, a popular foam filled coax, RG8U, has a loss of 0.9dB/30m at 30MHz which rises to 3.5dB/30m at 400MHz. The presence of such losses means that any signal which has to traverse the line more than once will suffer additional losses on each excursion.

So we have to concede that, in practice, standing waves do create some loss. But how much, and how important is it? If we assume a 3dB loss in a cable system which is correctly terminated, ie, no standing waves, then an SWR of 3 to 1 will add a further 1dB loss. The accompanying graph indicates the additional loss for a wide range of basic cable losses and SWR values.

At 450MHz, using RG8U cable, with a run approaching 30m, a loss of 3dB could be expected and, if it had to be tolerated, then anything which would minimise further losses would be worth considering. This is a case where, all else being equal, correction at the antenna might be preferable to that at the transmitter.

At lower frequencies losses become less important. At 150MHz, RG8U wastes only 2dB/30m (an additional 0.8dB for a 3:1 SWR), and at 30MHz 0.9dB (plus 0.48dB for 3:1 SWR).

So, hopefully, that should put the SWR problem into some kind of perspective. But there are other misconceptions which we might perhaps comment upon. One is that the reflected energy finds its way back into the final stage and overheats it. Wrong!

It is true that a transmitter working into a transmission line with a high SWR may show signs of distress. But the distress is not due to the SWR; rather it is due to the incorrect load at the antenna into which the transmitter is trying to work.

CABLE LENGTH?

Another popular furbphy claims that the length of the cable is critical; that it must be an exact multiple of a half wavelength long if the transmitter is to be properly loaded — and the standing waves eliminated — even when the antenna is presenting a proper load.

The truth is that, if the load is correct, then this value will be "seen" at the other end of the cable regardless of its length. If the load is incorrect, then this value will be seen at half wavelength intervals along the cable. But since it is wrong anyway there seems little point in trying to reproduce it.

In fact, in such circumstances, the length of the line can be critical for a quite different reason. Between the half wavelength points the cable will exhibit a range of impedances, one of which may match the transmitter. So, by adjusting its length the cable may be made to act as a matching transformer, and load the transmitter correctly.

But don't try to do it using the SWR meter because altering the line length will have no effect on the SWR. If this trick is to be employed other measurements must be used, such as that from a field strength meter at a fixed distance from the antenna.

Illustration courtesy of Electronics Australia

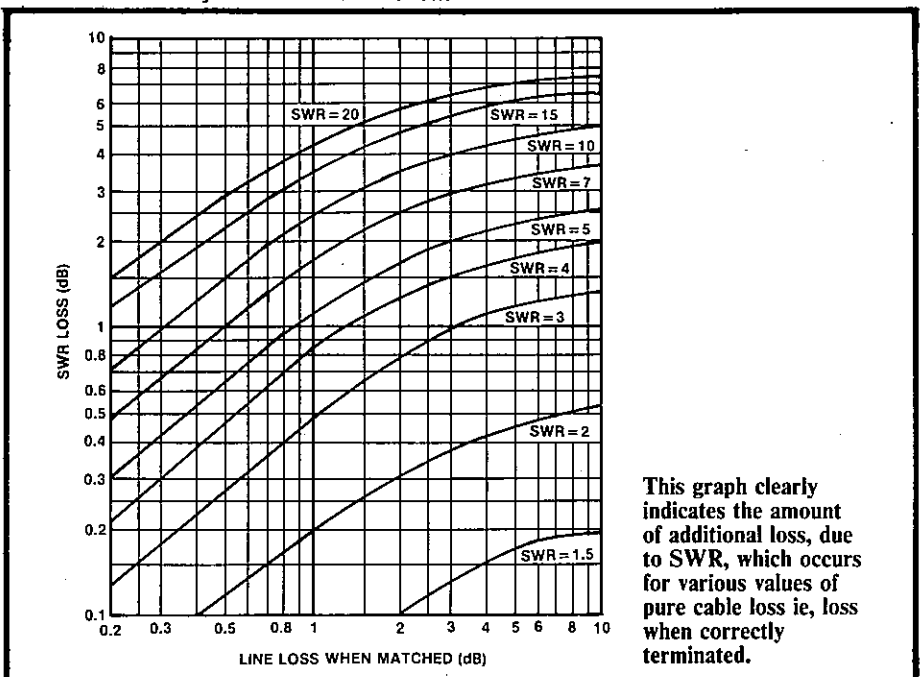

This graph clearly indicates the amount of additional loss, due to SWR, which occurs for various values of pure cable loss ie, loss when correctly terminated.

So, after all that, what is the role of the SWR meter? Well, it obviously isn't the universal answer to all antenna/transmission line problems. On the other hand, if it is the only instrument available it can be quite useful. An important point to realise is that, while it can indicate that there is something wrong with a particular set-up, it cannot indicate what is wrong.

Thus an antenna may present the wrong load for a number of reasons. It may not be resonant, the design may be wrong or may have been misinterpreted by the constructor, or the matching device, if one is used, may be incorrect. Alternatively, the cable impedance may be other than that claimed. (There is the story, well authenticated, about the Sydney disposals dealer who could supply either 50Ω or 75Ω cable at a very attractive price, both off the same reel!)

In other words, when the SWR meter indicates that there is something wrong, the important thing is to make a systematic approach to finding out what it is. For example, terminating the cable in a good dummy load having the same resistance will quickly indicate whether or not the cable is at fault. If it is not, the antenna is the next obvious suspect.

Exactly what needs to be done, or can be done, to change the antenna's impedance will, of course, depend on the particular type of antenna and what is physically convenient or practical. But, whatever the approach, the SWR meter can be used to monitor the effect of the changes or adjustments.

Finally, one more controversial point. Just where should the SWR meter be connected in the line: at the transmitter end or the antenna end? Some authorities are adamant that it should be at the antenna end, while others are equally emphatic that this precaution isn't necessary.

While, in theory, it can be shown that the antenna is the right place to make this measurement, the practical situation is that this is seldom a very convenient, or even feasible, arrangement. So, in practice, most people tend to make it at the transmitter end. (Where an antenna tuning unit, or other matching device is used at the transmitter, fitting the meter between the two is a perfectly legitimate way of determining when the tuning unit is presenting the correct load to the transmitter.)

The main objection to measurements made at the transmitter end is that the cable losses will mask the true ratio, the forward signal having been attenuated before it was reflected, and the reflected signal attenuated again on the way back. Depending on the severity of the losses, the user may obtain a reading below what he has set as an acceptable maximum when, in fact, the true value is appreciably higher.

Unfortunately, cable losses become worse as the frequency increases and, in the 420-450MHz (70cm) band this problem could be very real. So, be

prepared to work at the antenna unless the coax line can be kept short. In cases like this it is sometimes better to move the transmitter close to the antenna, and use a much shorter line.

And so to sum up: The most important characteristic of an antenna system is to present the transmitter with its optimum load. An SWR measurement can indicate whether this is happening and, if not, the degree of error. It is valuable primarily for this reason, the standing waves in themselves being relatively unimportant.

Text courtesy of Electronics Australia

THE PROJECT - as designed by Research and Development, Dick Smith Electronics

The development of this project was brought about by the lack of inexpensive, accurate equipment in the market place available to amateur and CB operators to enable the measurement of forward and reverse power and the mathematical calculation of SWR. The project was conceived in early 1984 by Gil McPherson and Garry Crapp and was prompted by many enquires from the constructors of the now successful 'Explorer' UHF Transceiver kit. It seems logical to present the project at this time as there are now over 500 'Explorers' operational in the field.

Basically the unit is an insertion type RF watt meter, capable of measuring RF power in either forward or reverse direction into a 50 ohm load. The unit relies primarily on its strip line technique layout for reproducible accuracy. The unit employs three circuit boards, (1) the

switching board which carries both the range switch and the forward - reverse power switch, (2) the strip line circuit board from which coupling currents are sampled and rectified to give a power reading and (3) a shield used to minimise extraneous capacitance and inductance and ensure constant impedance.

The only other components are a 0 to 100 micro amp meter movement, a calibrated forward and reverse power scale, two non-inductive 75 ohm resistors, two Hewlett Packard 2800 hot carrier diodes, two 1000pF feedthrough capacitors, one 1000pF ceramic capacitor, three preset range pots and two ferrite beads.

It can be seen from this small parts list that there is relatively nothing to go wrong with the meter once it has been constructed.

MEASUREMENT OF LOAD POWER

Power delivered to and dissipated in a load is given by the formula:

$$W_L = W_F - W_R$$

Where appreciable power is reflected, that is in the case of an antenna, it is necessary to subtract reflected power from the forward power to get the load power. This correction is negligible (less than 1%) if the load is such to have a SWR of 1.2 to 1 or less - good load resistors, that is non-inductive resistors, will thus show negligible or unreadable reflected power. It is thus quite simple using the chart provided with the kit to

The diagram below shows the circuit for the K-6312 SWR Power Meter.

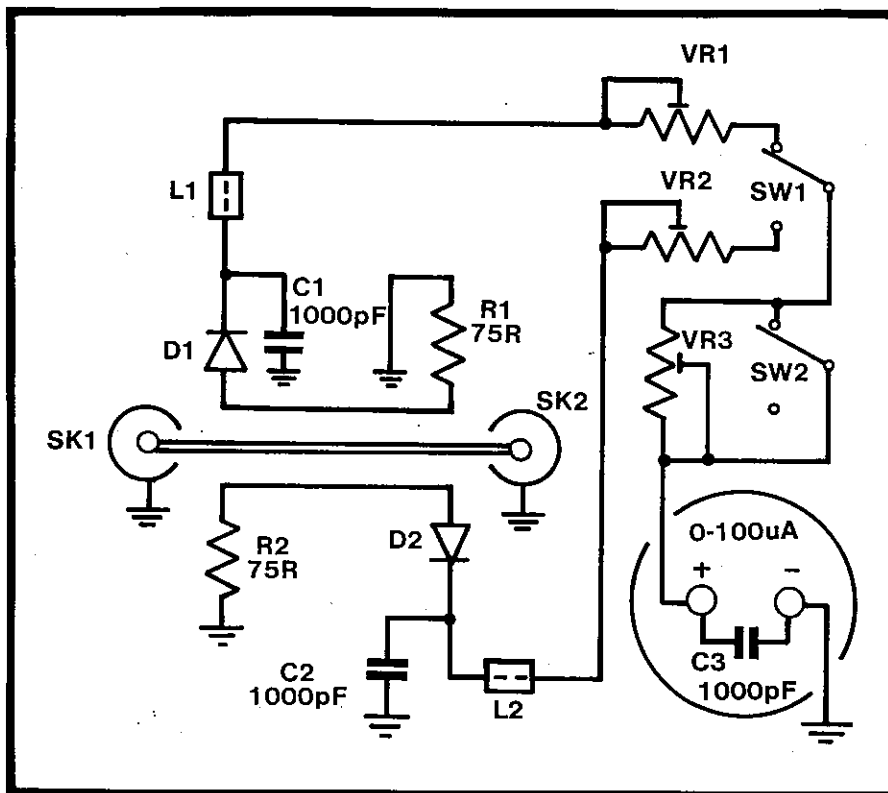

calculate VSWR knowing both forward and reflected power.

It is for this reason that SWR scales and their complicated setting controls have been deliberately omitted.

It is easy to check by simply switching between forward and reverse power to see whether an antenna is reflecting an appreciable amount of power. In an antenna matching situation, the main aim is usually to minimise reflected power and this can be done by monitoring power in the reverse position.

It can thus be seen that the K-6312 Wattmeter may be useful for continuous monitoring of reflected power. For instance in checking intermittent antenna faults.

It should be noted that throughout the communications industry the Bird Model 43 Throughline RF Directional Watt meter has become the international standard and it was with this product in mind that the K-6312 was developed.

CONSTRUCTION

Because the input and output connections are placed on the rear of the metal case in which the unit is built, the strip line circuit board must be assembled through the front of the case via the hole intended to mount the panel meter. As such the panel meter must be mounted last.

The following procedures should be used during the construction of the Wattmeter.

1. Secure the two BNC sockets and tin bracket to the rear of the case of the unit, using the nuts and washers provided with the BNC sockets.

2. Assemble the strip line printed circuit board i.e. solder the two resistors, two diodes, and two feed through capacitors and the 8 circuit board pins into the strip line circuit board. Feed through

capacitors have been used here because they have very short leads and thus very low lead inductance. The body of the feed through capacitor must be soldered to directly.

3. Using two nylon screws, secure the blank circuit board directly on top of the strip line circuit board, copper side facing outwards.

4. Position the strip line circuit board assembly into the tin bracket and solder the two centre pins of the BNC connector into position. Soldering will have to be done through the meter hole in the front panel of the case. After this solder the tin bracket to the ends of the strip line PCB.

5. Assemble the trimpots on the switching circuit boards. This means soldering into position the three trimpots and three printed circuit board pins.

6. Insert and secure the switches through the front of the case, that is so that the connections of the switch are outside the front panel of the case, then solder the circuit board to the switch terminals. This is to ensure that the correct switch spacing is obtained when mounting the switches and circuit boards from the inside of the case.

7. Remove the switch board assembly from the front of the case and mount it from the inner side of the case. Solder lengths of hookup wire from the trimpot circuit board to the feed through capacitors. Do not forget to thread this wire through the ferrite beads as per the diagram on page 6.

8. Preparing the meter:

a. Carefully fit the new meter scale calibrated in watts to the meter movement.

b. Solder the 1000pF capacitor across the rear of the meter. Move the solder lugs so that they face one another to allow the shortest possible leads on the 1000pF capacitors.

c. Solder a length of hookup wire about 8cm long to each meter terminal.

9. Secure the meter to the case using the four nuts and washers provided.

10. Solder the meter wires to the correct location on the circuit board as per the diagram on page 6.

CALIBRATION

Equipment required:

1x variable DC power supply (0 to 15 volts)

1x multimeter, preferably digital.

1x 100 ohm ½W resistor

1. Set the DC power supply to 5.0 volts output and monitor the output with the digital multimeter.

2. Connect a 100 ohm ½W series current limiting resistor in series with the positive lead from the power supply.

3. Connect the negative lead from the power supply to the chassis of the Wattmeter.

4. Connect the positive lead (through the 100 ohm series resistor) to the 'hot' end of the 75 ohm resistor in the strip line circuit board.

5. With the direction switch SW1 set in the forward position adjust the 25K trimpot VR1 for full scale on the 10 Watt range.

6. Remove the 5 volt DC lead and connect to the other 75 ohm resistor in the unit - operate the direction switch to the opposite direction and adjust VR2 (the other 25K trimpot) for full scale on the 10 Watt scale.

7. Disconnect the 5 volt test line after both these procedures are complete.

8. Switch the range switch to the 50 watt position and apply 12.2 volts (measured at the power supply) through a 100 ohm limiting resistor across either 75 ohm resistor. Should the meter not read, reverse the direction switch and adjust VR3, the 50K trimpot for 50 Watt full scale reading. This adjustment sets the 50 Watt range in both directions.

This completes the basic calibration. Further accuracy must be achieved by comparing the unit with a known standard, however the accuracy given as a result of this basic calibration procedure does allow relative measurements to be made. ●

PARTS LIST

COMPONENTS

2x	75R Cracked Carbon Resistor (R1, R2)	□
2x	1000pF Feed Through Capacitor (C1, C2)	□
1x	1000pF Ceramic Capacitor (C3)	□
2x	HP 2800 Diode (D1, D2)	□
2x	20K/25K Trimpot (VR1, VR2)	□
1x	47K/50K Trimpot (VR3)	□
2x	Ferrite Bead (L1, L2)	□
2x	BNC Socket SDR (SK1, SK2)	□
2x	SPDT Toggle Switch (SW1, SW2)	□

MISCELLANEOUS

Nylon nuts and bolts, solder, PCB pins, hookup wire, case, PCB (3), rear tin bracket, meter and meter panel, power chart card ... □

MOUNTING TIN BRACKET AND BNC SOCKETS TO BACK PANEL

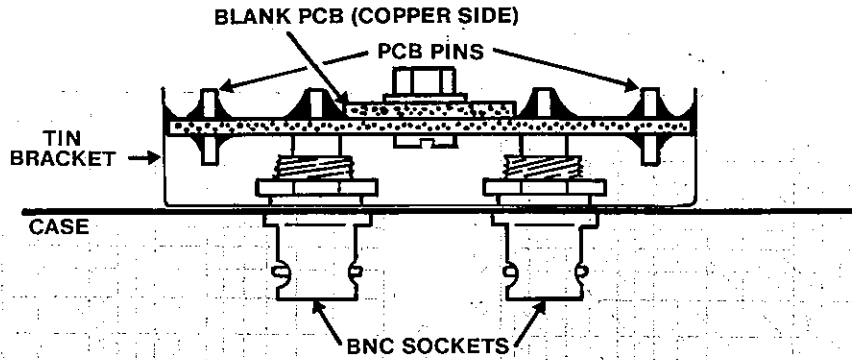

CHANGING METER PANEL

Unscrew the two phillips-head screws located at either side of the meter panel. Once these screws are removed the meter face will come off with just a little persuasion.

To remove the scale plate, another two small phillips-head screws will have to be removed. These are located either side of the moving coil. Once removed, slide the scale plate away from the meter needle. Care must be taken when changing the panels, as damage may be caused to the coil unless the panels are slid into position. Having attached the new meter face, installation is simply the opposite procedure to the above.

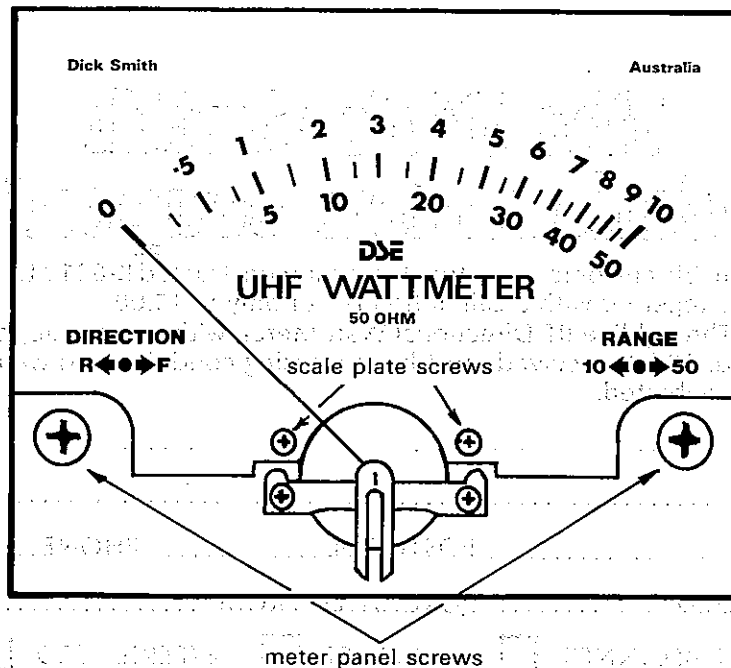

SPECIFICATIONS

DIRECTIVITY > 20dB
 INSERTION LOSS < 0.3dB
 FREQUENCY RESPONSE (NARROW BAND) USEABLE OVER
 FREQUENCY RANGE 400-520 MHz
 ACCURACY WITHIN 10%
 BEST ACCURACY WITHIN 30 MHz OF CALIBRATION
 FREQUENCY
 MAXIMUM POWER - 100 WATTS
 IMPEDANCE - 50 OHMS
 CONNECTORS - BNC TYPE

STANDING WAVE RATIO CHARTS

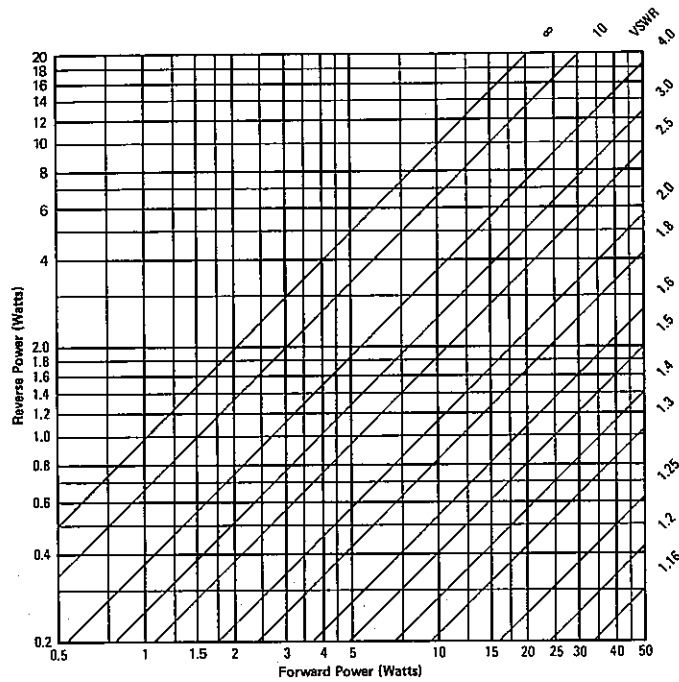
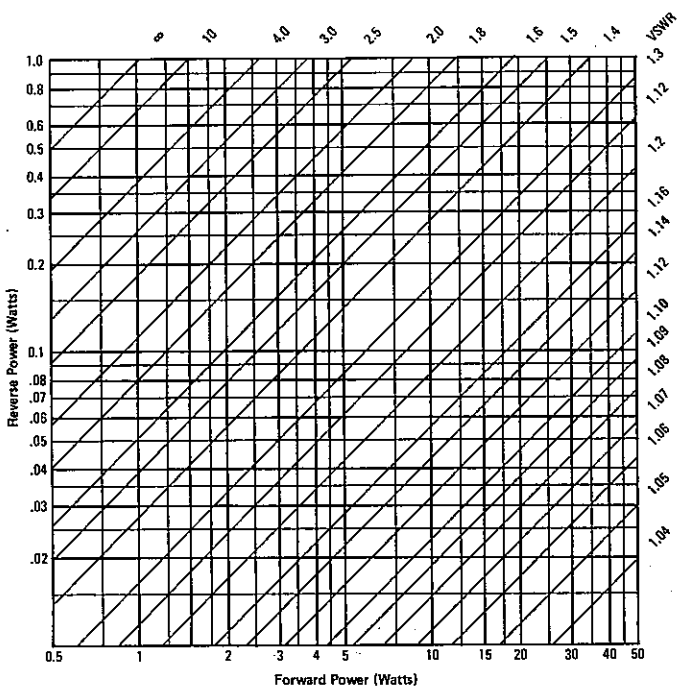

The Dick Smith 'Calibration coupon'

This coupon will enable customers to return their fully constructed K-6312 UHF Wattmeter to our Service Department, together with a calibration fee of only \$ 15.00

A Bird Model 43 Throughline RF Directional Watt Meter, with an accuracy of within 5% will be used as the standard. All kits received must be in working condition and we reserve the right to return faulty kits uncalibrated.

NAME

ADDRESS

POSTCODE PHONE

DATE KIT PURCHASED PURCHASED FROM

I AM A - COMPLETE BEGINNER HOBBYIST EXPERIENCED

I have included the \$ 15.00 calibration fee.

STORE LOCATIONS

Australia
 NSW
 Smith & Young Sts
 155 Terrace Level
 Shop 1, 65-75 Main St
 613 Princess Hwy
 Oxford & Adelaide Sts
 531 Pittwater Rd
 Campbelltown Mall Queen St
 Shop 235, Archer St Entrance
 147 Hume Hwy
 164 Pacific Hwy
 315 Mann St
 4 Florence St
 Elizabeth Dr & Bathurst St
 450 High St
 173 Mainland Rd, Tighes Hill
 Lane Cove & Waterloo Pkcs
 George & Smith Sts
 The Gateway High & Henry Sts
 818 George St
 123 York St
 Treloar's Bldg, Brisbane St
 263 Kerri St
 ACT
 96 Gladstone St

Victoria
 0800 21 8399
 023 707 4846
 023 871 7722
 023 548 7744
 023 987 1444
 023 83 0441
 0441 27 2199
 021 411 1955
 021 842 8922
 021 428 2311
 0431 22 0235
 021 477 8833
 023 826 8888
 0431 33 7886
 0448 81 1896
 021 84 3835
 021 888 2188
 0473 22 3400
 021 211 3777
 023 282 9111
 0467 64 1061
 0423 24 3800
 0423 80 4944

Queensland
 145 McCrae St
 Shop 40 Shop Hill Central Man St
 Hawthorn Rd & Nepean Hwy
 260 Sydney Rd
 1150 Mt Alexander Rd
 Nepean Hwy & Ross Smith Ave
 Shop 9 110, High St
 291-293 Elizabeth St
 Bridge Rd & The Boulevarde
 Springvale & Dandenong Pkcs
 QLD
 197-199 Elizabeth St
 166 Logan Rd
 Gympie & Hamilton Rds
 Queen Elizabeth Dr & Bernard St
 Gold Coast Hwy & Welch St
 Bowen & Fullerton Sts
 Ingham Rd & Cowley St West End
 Cnr Pacific Hwy & Kingston Rd
 SA
 Wright & Market Sts
 Main South & Flagstaff Rds
 Main North Rd & Gairdner St
 24 Park Terrace

Western Australia
 0833 31 5433
 0841 43 0388
 081 880 0889
 081 582 2386
 081 543 4455
 083 378 7444
 083 783 8144
 0853 43 8322
 083 87 8834
 081 428 1614
 081 547 8228
 081 229 8277
 081 381 8233
 081 358 8253
 0818 27 8644
 0818 32 8943
 0818 34 4200
 0818 27 5722
 081 241 8844

South Australia
 081 212 1942
 081 258 8777
 081 280 8068
 081 281 1593

Western Australia
 081 451 8888
 081 335 8733
 081 328 8844
 081 321 4357
 NT
 TAS
 28 Barrack St
 17 Stuart Hwy
New Zealand
 269 Mylvar Pass Rd
 1795 Great North Rd
 26 East Tamau Rd
 Fox & Commerce Sts
 450 Anglesea St
 154 Featherston St
 Victoria St & Bealey Ave
 Manse & Commerce Sts

Canberra 081 451 8888
Fremantle 081 335 8733
North Perth 081 328 8844
Perth City 081 321 4357
Hobart 0823 31 0600
Stuart Park 0889 81 1977
Auckland 071 39 8495
Avondale 091 89 8696
Papatoetoe 091 278 2335
Auckland 071 38 8774
Hamilton 071 38 4480
Wellington 041 73 8658
Christchurch 031 50 4425
Dunedin 0241 74 1996

USA
 390 Convention Way
Redwood City, CA 348 8444



Terms available to approved personal applicants through AGG